

TEST CLIPS & OSCILLOSCOPE PROBES

Emulation Technology test adapters and Oscilloscope probes are designed especially for testing dual-in-line IC packages on high-density PC boards . Many of the test clips and probes are specifically designed for ultra-dense packaged chips located adjacent to each other. As chip packages shrink the ability to test becomes increasingly challenging. Test clips and probes can readily assist the user looking for a cost-effective means of testing signals at the chip level.

FEATURES & BENEFITS

- Allow Access to Board-Mounted IC Signals
- Allow hands-free testing and debugging of ICs soldered onto PCBs
- Clips either piggy-back or clip onto IC packages. Many models also lock onto the device's body for a secure connection
- Test points provide quick connection of test cable assemblies, test probes, or wire wraps. Most models provide signal labeling
- Some designs allow a "known good" device to be soldered onto the Clip. Target system diagnostics may then be run while the board-mounted device is disabled
- Many designs may also be used as emulator adapters
- Several styles are available

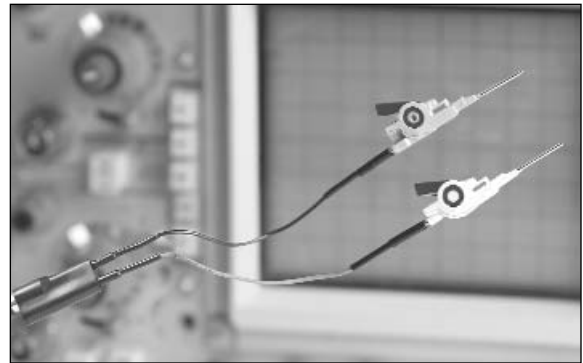
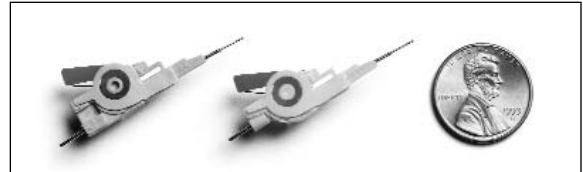
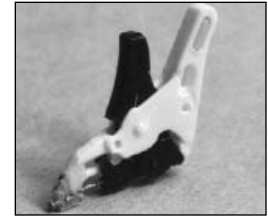
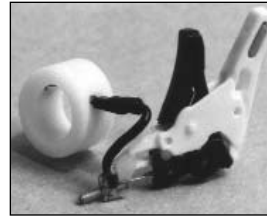

TEST CLIPS & OSCILLOSCOPES

	<u>Popular Test Clip Styles</u>
SSOP	Locking feature; Test Point spacing: .050" or .100".
TSOP	Elastomeric Connectors instead of pins; Low-profile; Connector styles: Male-to-Male, Flex, and Rigid.
SOIC/SOJ/QFP	EIAJ: Standard & Locking versions; JEDEC: Locking; Optional Flex or Rigid connector.
DIP	Standard & High-Density versions.
PLCC	Quad Clip: With optional Extender Cables; Low-Profile: With straight or 90° test leads.

Custom Solutions are available. Call us today.

<u>Test Clips & Oscilloscope Probes</u>	<u>Page</u>
Deluxe Probe Kits	175, 176
DIP Test Clips.....	167
Flying Test Leads	164
MicroGrippers High Speed to 5 GHz	172
MicroGrippers High Speed to 5—10 GHz	173
MicroGrippers, 1—100MHz.....	170, 171
PLCC Test Clip Cables	163
PLCC Test Clips.....	163
Probe Fixture, Adjustable	176
QFP Friction Lock Test Clips	162
PQFP/TQFP JEDEC Locking Test Clips	161
PQFP/TQFP Locking Test Clips	160
SMD Grabbers	168, 169
SMD Test Probes	174, 175
SMD Tweezer Clips	175
SOIC Test Clips	164
SSOP Test Clips	165



Information Required for Ordering:

- 1) IC Package information: Manufacturer, Part Number and package outline drawing
- 2) Clearance: Distance between IC & other components
- 3) Preferred features: Locking Clip, Test Lead or Connector style Test Lead Pitch, etc.

For a complete test clip listing, pricing and delivery information, please see:
Web Link: www.1800adapter.com/040

LOCKING TEST CLIPS - EIAJ

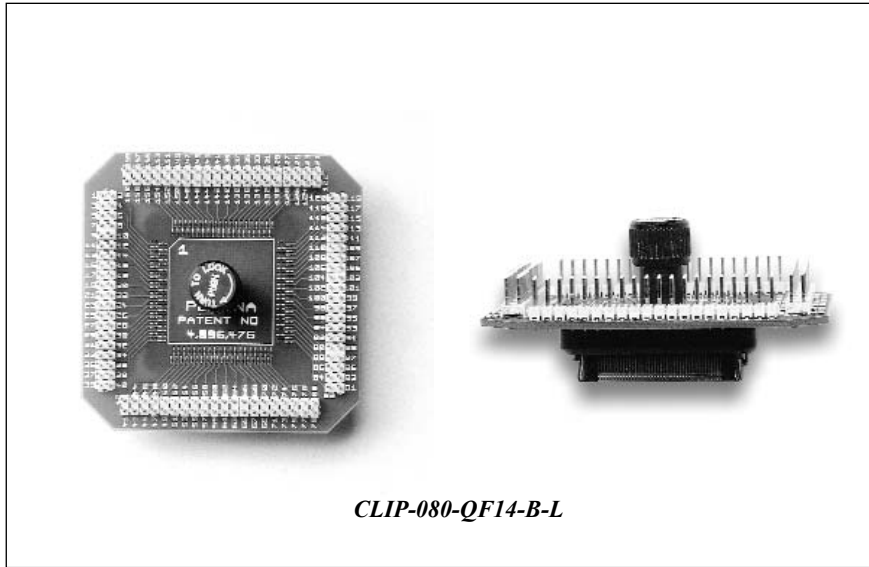

LOCKING TEST CLIPS EIAJ TYPE

This ET PQFP Clip[®] is specifically designed for testing EIAJ metric Plastic Quad Flatpack (PQFP) surface mounted ICs. It piggybacks onto a soldered-in PQFP, and converts the PQFP leads to standard .1" test points, for easy attachment of test instruments.

As an option, on most ET PQFP Test Clips you can solder a known "good" PQFP device to the top of the PQFP clip, disable the device at board level, and then run your target system diagnostics.

In addition, the PQFP clip can be used to convert a PQFP to any other IC package type for easy emulation.

Ordering Information Example

Pin Count _____ Clip Type _____
 Product Code _____ CLIP-160-QF07-A-L _____ Locking Test Clip
 _____ QFP Footprint
 (see Footprint Section)

METRIC PQFP/TQFP TEST CLIPS

Pin Count	Package Shape	Lead Pitch in./mm	Body Size (+/- .4mm)	Critical Dimensions (+/- .1mm)	Drawing#	Part Number
80	RECT.	.0315/.80	14X20	16.3X22.3	F4145	CLIP-080-QF08-A-L
80	RECT.	.0315/.80	14X20	15.6X21.6	F4146	CLIP-080-QF08-B-L
100	RECT.	.0256/.65	14X20	16.3X22.3	F5031	CLIP-100-QF06-A-L
100	RECT.	.0256/.65	14X20	15.6X21.6	F4149	CLIP-100-QF06-B-L
144	SQ.	.019/.50	20X20	21.4 SQ.	F4671	CLIP-144-QF63-D-L
160	SQ.	.0256/.65	28X28	30.3 SQ.	F4150	CLIP-160-QF07-A-L
160	SQ.	.0256/.65	28X28	29.6 SQ.	F4151	CLIP-160-QF07-B-L
176	SQ.	.0196/.50	24X24	25.0 SQ.	F4672	CLIP-176-QF67-D-L
208	SQ.	.0196/.50	28X28	29.6 SQ.	F4152	CLIP-208-QF21-C-L
240	SQ.	.0196/.50	32X32	33.6 SQ.	F4822	CLIP-240-QF62-C-L
304	SQ.	.0196/.50	40X40	41.6 SQ.	F5244	CLIP-304-QF61-C-L

HOW TO ORDER

Use the tables on these pages to select your test clip, based on the package drawing for your chip.

- 1) Select pin count.
- 2) Select lead pitch and body size.
- 3) Verify the footprint in the Footprint Section.

Try our SOIC Flying Test Leads. Female. Plugs onto .025" wire wrap post; maintains 1/10" spacing.
Web Link: www.1800adapter.com/089

For a complete test clip listing, pricing and delivery information, please see:
Web Link: www.1800adapter.com/040

LOCKING QFP TEST CLIPS JEDEC TYPE

Now you can test your PQFP devices—even while they're soldered to a PC board! The ET PQFP Clip[®] is specifically designed to allow testing of surface mounted JEDEC plastic or ceramic Quad Flat Packs. It piggybacks onto a soldered-in PQFP, and converts the PQFP leads to standard .1" test points, for easy attachment of test instruments.

The special "locking" feature ensures positive electrical interconnection while providing a solid mechanical connection in either the vertical or horizontal plane. The mechanism locks to the body of the IC, avoiding damage to the leads.

CONTACTS: Selectively gold plated Beryllium Copper.

INSULATION: Liquid crystal polymer and Nylon, black.

RATING: 250 VRMS Max., 1 Amp Max., +110° C (+230°F) Max.

HOW TO ORDER

Use the tables on these pages to select your test clip, based on the package drawing for your chip.

- 1) Select pin count.
- 2) Select lead pitch and body size.
- 3) Verify the footprint in the Footprint Section.

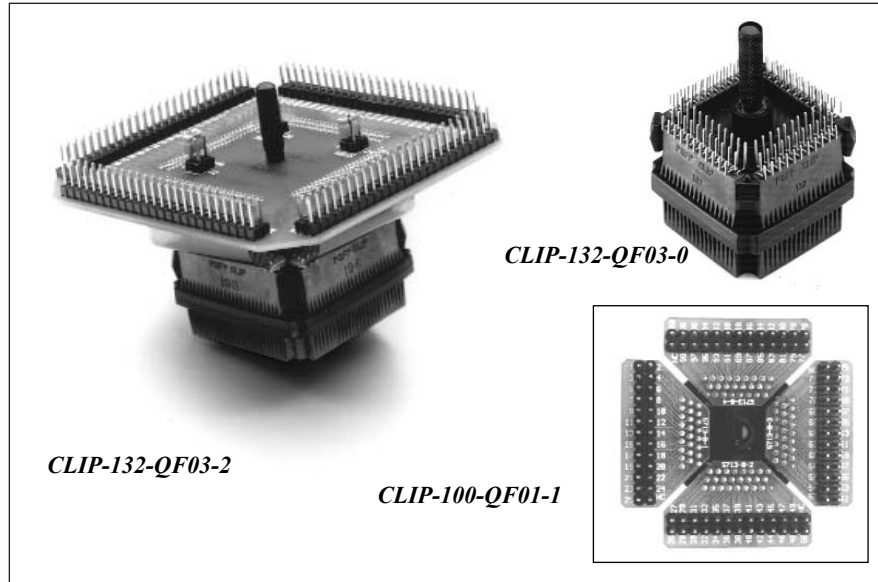

CLIP-132-QF03-2

CLIP-100-QF01-1

CLIP-132-QF03-0

Ordering Information Example

Pin Count _____
 Product Code _____ CLIP-132-QF03-1 _____
 JEDEC = Joint Electronic Device Engineering Council

Clip Type (see table, below)
 QFP Footprint (see Footprint Section)

JEDEC QFP TEST CLIPS

Pin Count	Lead Pitch in./mm	Body Size	Package/ Footprint Drawing #	Part Number	Drawing #
100	.025/.635	.750" SQ.	100-QF01	CLIP-100-QF01-0	F3718
100	.025/.635	.750" SQ.	100-QF01	CLIP-100-QF01-1	F2067
100	.025/.635	.750" SQ.	100-QF01	CLIP-100-QF01-2	F1447
132	.025/.635	.950" SQ.	132-QF03	CLIP-132-QF03-0	F3833
132	.025/.635	.950" SQ.	132-QF03	CLIP-132-QF03-1	F1795
132	.025/.635	.950" SQ.	132-QF03	CLIP-132-QF03-2	F1648

Note: (1) PQFP Only

Clip Type

Type	Top Circuit Board	Height	Test Points
-0	None	1.7" Typ.	.075" Stagger
-1	4-Piece Assembly	1.9" Typ.	.100" In-Line
-2	1-Piece with Flex Cable	1.9" Typ.	.100" In-Line

For a complete test clip listing, pricing and delivery information, please see
 Web Link: www.1800adapter.com/040

TEST CLIPS - EIAJ

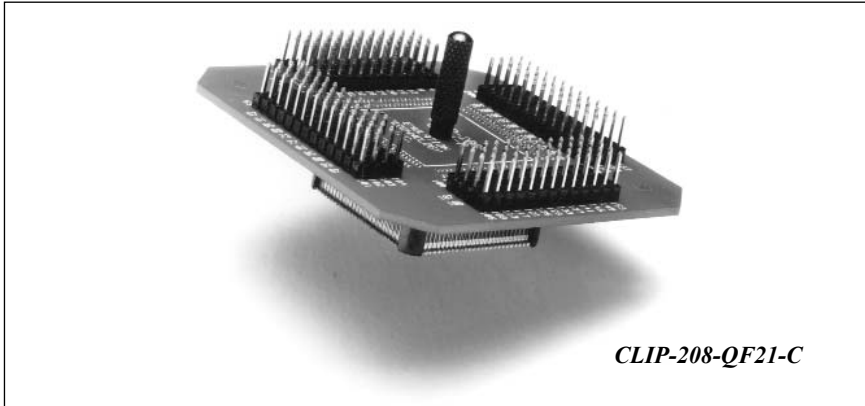

CLIP-208-QF21-C

Ordering Information Example

Pin Count _____
 Product Code _____ CLIP-080-QF08-B(C) _____
 EIAJ = Electronic Industry Association of Japan

Clip Version
 (see Table below, at right)
 Clip for Ceramic Package
 QFP Footprint
 (see Footprint Section)

METRIC QFP TEST CLIPS

Pin Count	Package Shape	Lead Pitch in./mm	Body Size (+/- .4mm)	Critical Dimensions (+/- .1mm)	Part Number	Drawing #
44	SQ.	0.80	10X10	12.3 SQ.	CLIP-044-QF16-A	F1446
44	SQ.	0.80	10X10	11.6 SQ.	CLIP-044-QF16-B	F1832
64	RECT.	1.00	14X20	16.6X22.3	CLIP-064-QF09-A	F1670
64	RECT.	1.00	14X20	15.6X21.6	CLIP-064-QF09-B	F1672
64	SQ.	0.80	14X14	16.3 SQ.	CLIP-064-QF29-A	F3712
64	SQ.	0.80	14X14	15.6 SQ.	CLIP-064-QF29-B	F3713
80	RECT.	0.80	14X20	16.3X22.3	CLIP-080-QF08-A	F1628
80	RECT.	0.80	14X20	15.6X21.6	CLIP-080-QF08-B	F1339
80	SQ.	0.65	14X14	16.3 SQ.	CLIP-080-QF14-A	F2175
80	SQ.	0.65	14X14	15.6 SQ.	CLIP-080-QF14-B	F2176
80	SQ.	0.50	12X12	N/A	CLIP-080-QF47-2	F6625
100	RECT.	0.65	14X20	16.3X22.3	CLIP-100-QF06-A	F1629
100	RECT.	0.65	14X20	15.6X21.6	CLIP-100-QF06-B	F1340
100	RECT.	0.65	14X20	14.8X20.8	CLIP-100-QF06-2	F5677
112	SQ.	0.65	20X20	22.3 SQ.	CLIP-112-QF36-B/C	F3721
120	SQ.	0.80	28X28	30.3 SQ.	CLIP-120-QF05-A	F1608
120	SQ.	0.80	28X28	29.6 SQ.	CLIP-120-QF05-B	F1609
128	SQ.	0.80	28X28	30.3 SQ.	CLIP-128-QF13-A	F1192
128	SQ.	0.80	28X28	29.6 SQ.	CLIP-128-QF13-B	F1342
144	SQ.	0.65	28X28	30.3 SQ.	CLIP-144-QF10-A	F1606
144	SQ.	0.65	28X28	29.6 SQ.	CLIP-144-QF10-B	F1607
144	SQ.	0.65	28X28	29.6 SQ.	CLIP-144-QF10-BC	F1807
160	SQ.	0.65	28X28	30.3 SQ.	CLIP-160-QF07-A	F5237
160	SQ.	0.65	28X28	29.6 SQ.	CLIP-160-QF07-B	F3722
168	SQ.	0.65	28X28	29.6 SQ.	CLIP-168-QF25-B	F1344
208	SQ.	0.50	28X28	30.3 SQ.	CLIP-208-QF21-2	F5875
208	SQ.	0.50	28X28	29.6 SQ.	CLIP-208-QF21-C	F1415
240	SQ.	0.50	32X32	33.6 SQ.	CLIP-240-QF62-C	F2164
240	SQ.	0.50	32X32	33.6 SQ.	CLIP-240-QF62-CM	F1297
240	SQ.	0.50	32X32	33.6 SQ.	CLIP-240-QF62-2	F1716
304	SQ.	0.50	40X40	41.6 SQ.	CLIP-304-QF61-C	F3729

For a complete SOIC Flying Test Leads listing, pricing and delivery information, please see:
Web Link: www.1800adapter.com/089

For a complete test clip listing, pricing and delivery information, please see:
Web Link: www.1800adapter.com/040

QFP TEST CLIPS

EIAJ TYPE

This ET PQFP Clip[®] is specifically designed for testing EIAJ or JEDEC metric Plastic Quad Flatpack (PQFP) surface mounted ICs. It piggybacks onto a soldered-in PQFP, and converts the PQFP leads to standard .1" test points, for easy attachment of test instruments.

As an option, on most ET PQFP Test Clips you can solder a known "good" PQFP device to the top of the PQFP clip, disable the device at board level, and then run your target system diagnostics.

In addition, the PQFP clip can be used to convert a PQFP to any other IC package type for easy emulation.

CONTACTS: 0.30mm (.010") Sq. pins, Beryllium Copper, gold plated.

INSULATION: Liquid crystal polymer. Vectra A-130, black.

RATING: 250 VRMS Max.,
 5 Amps, +110°C
 (+230°F) Max.

HOW TO ORDER

- 1) Select pin count.
- 2) Select lead pitch and body size.
 Tolerance on body size is +/- .4mm.
- 3) Calculate critical dimension.
Tolerance on Critical Dimension is +/- .1mm. See example below.

Clip Version

Type	Tip to Tip Dimension (T)
-A	Body size + 3.9mm
-B	Body size + 3.2mm
-C	Body size + 2.6mm
-D	Body size + 2.0mm

Calculating your Critical Dimension

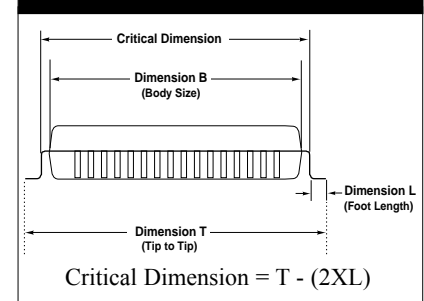

PLCC - TEST CLIPS

PLCC QUAD CLIP™

QUAD CLIP™ is designed for Plastic Leaded Chip Carriers (PLCC) with "J" leads. Latches on diagonal sides allow the adapter to be positively held in place providing hands free testing.

UPPER

CONTACTS: .635mm (.025") Sq. pins. Phosphor Bronze, gold plated.

INSULATION: Glass-filled nylon, gray.

CONTACT: Beryllium Copper, gold plated.

RATING: 500 VRMS; 1 Amp; +102°C (+216°F) Max.

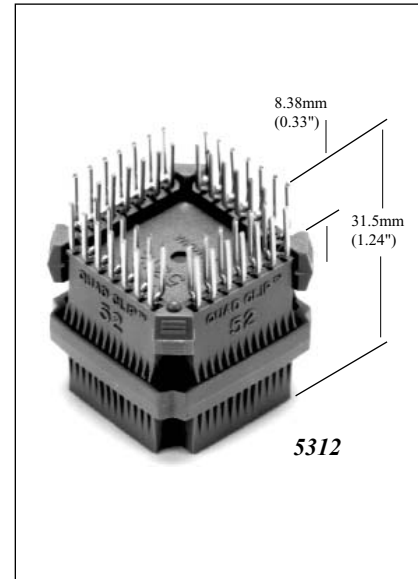
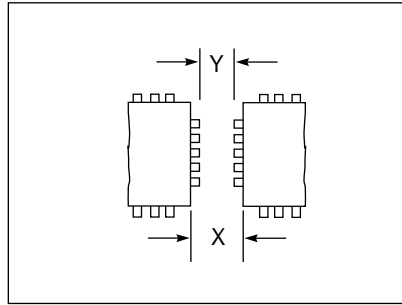

	X Min.	Y Min.
Single Chip Testing	3.05mm (.120")	2.79mm (.110")
Adjacent Testing	8.26mm (.325")	7.24mm (.285")

Pin Count	Pins per Side	Pitch	Part #
20	5X5	.050"	5279
28	7X7	.050"	5280
32	7X9	.050"	5733
44	11X11	.050"	5281
52	13X13	.050"	5312
68	17X17	.050"	5401
84	21X21	.050"	5402

PLCC TEST CLIP CABLE ATTACHMENTS

- Clip extenders work with the PLCC QUAD Clips above.

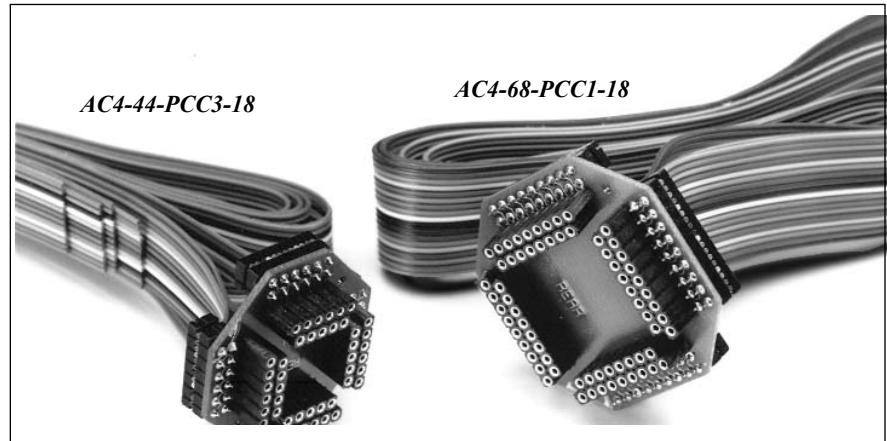

Pin Count	Dimensions	Part #	Drawing #
32	1.250X1.350	AC4-32-PCC7-18	F5378
44	1.45" SQ.	AC4-44-PCC3-18	F3703
52	1.55" SQ.	AC4-52-PCC4-18	F3704
68	1.75" SQ.	AC4-68-PCC1-18	F3705
84	1.95" SQ.	AC4-84-PCC5-18	F3706

For a complete test clip listing, pricing and delivery information, please see
Web Link: www.1800adapter.com/040

TEST CLIPS - SOIC / FLYING TEST LEADS

FEMALE TO FEMALE		
Part #	Length	Quantity
03-3103	76 mm (3.0")	10/pkg
03-3104	101.5 mm (4.0")	10/pkg
03-3106	152.4 mm (6.0")	10/pkg
03-3110	254 mm (10.0")	10/pkg
03-3112	305 mm (12.0")	10/pkg

FEMALE TO MALE		
Part #	Length	Quantity
04-3103	76 mm (3.0")	10/pkg
04-3104	101.5 mm (4.0")	10/pkg
04-3106	152.4 mm (6.0")	10/pkg
04-3110	254 mm (10.0")	10/pkg
04-3112	305 mm (12.0")	10/pkg
04-3136	915 mm (36.0")	10/pkg

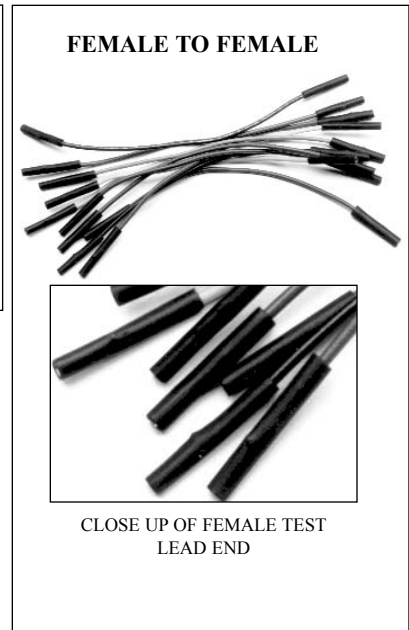

CLOSE UP OF FEMALE TEST LEAD END

FEMALE TO MALE NOT SHOWN.

FEMALE TO FEMALE

WIRE: 26 AWG, 19X38 t.c., polyvinyl insulation.
1ST END: Female. Plugs onto .025" wire wrap post; maintains 1/10" spacing.
2ND END: Female.
RATING: Operating Voltage: 500 VRMS Max.; +50⁰ (+122⁰F)

FEMALE TO MALE

WIRE: 26 AWG, 19X38 t.c., polyvinyl insulation.
1ST END: Female. Plugs onto .025" wire wrap post; maintains 1/10" spacing.
2ND END: Male.
RATING: Operating Voltage: 500 VRMS Max.; +50⁰ (+122⁰F)

*For a complete SOIC Flying Test Leads listing, pricing and delivery information, please see:
Web Link: www.1800adapter.com/089*

SOIC CLIP™

This test clip is designed specifically for testing Small Outline Integrated Circuits (SOIC). The SOIC Clip™ assures a positive connection and provides hands-free testing convenience.

- 0.64mm (.025") square access pins on upper end permits either individual pin testing or the use of 2.54mm (.100") spaced connectors. Lead pitch is .050".
- Molded barrier between each contact allows connections to be made on live boards without accidental shorting of adjacent contacts

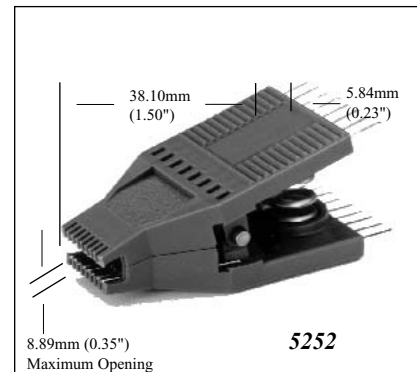
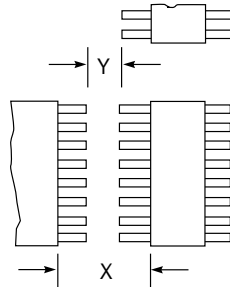

INSULATION: Glass-filled nylon, blue.

CONTACT: Beryllium Copper, gold plated.

RATING: 500 VRMS; 1 Amp; +102⁰C (+216⁰F) Max.

	X Min.	Y Min.
Single Chip Testing	4.06mm (.160")	1.52mm (.060")
Narrow Body (Adjacent)	15.24mm (.600")	12.70mm (.500")
Wide Body (Adjacent)	8.51mm (.335")	5.97mm (.235")

Pin Count	Part #
8	5250
14	5251
16	5252
20	5253
24	5254
28	5437
32	6107
40	6108
44	6109

*For a complete test clip listing, pricing and delivery information, please see
Web Link: www.1800adapter.com/040*

SSOP TEST CLIPS

These test clips provide you with an easy means to connect your instrument to the fine pitch plastic SSOP chip leads. SSOP test clips are perfect for emulation, field service testing, and failure analysis.

The locking mechanism holds the clip to the device by gripping the chip body at the ends of the package. Each contact is individually canted to assure positive contact, regardless of coplanarity. The top interface connects with high density IDC cable connectors.

MATERIAL:

Upper Contacts - .018 sq. pins, Phosphor Bronze, gold plated, 30 microinches Max

Lower Contacts - Beryllium Copper, gold plated. Handle, Aluminum alloy, black anodized

INSULATION: Body, Ultem and nylon.

CONDUCTOR: Beryllium Copper, gold plated. Insulation, Kapton

RATING: 250 VRMS; 1 Amp; +110°C (+230°F) Max.

FEATURES

- Interfaces with high density SSOP chip leads
- Locking feature insures positive retention on the chip in either vertical or horizontal position
- Label on top of clip provides a guide for pin numbering
- Gold plated contacts for the chip leads and the connector pins assure noise free connection

Note: Will not work on .110" or thicker IC

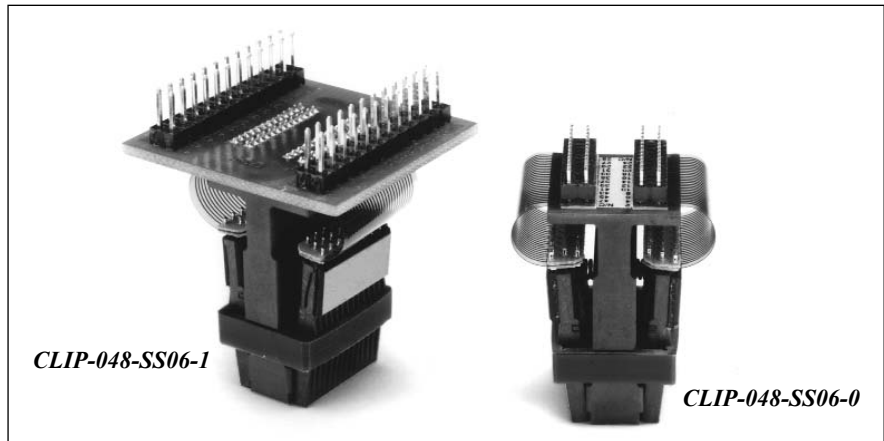

Ordering Information Example

Pin Count _____
 Product Code _____ CLIP-048-SS06-1 _____ Clip Version:
 SSOP Footprint (see Footprint Section) _____ -0 = .05" Test Point Spacing
 -1 = .1" Test Point Spacing

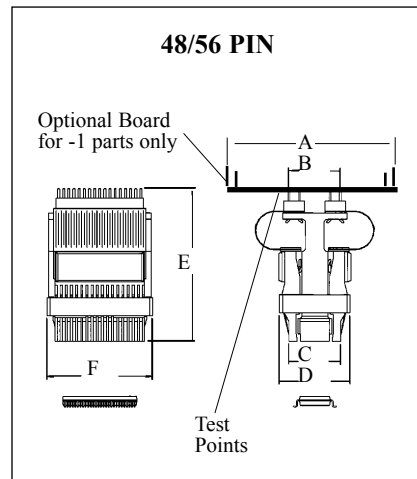
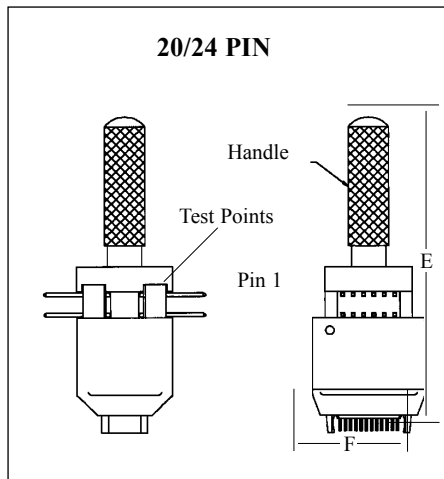

48/56 SSOP Test Clip Dimensions						
Part #	Document #	A	B	C	D	F
CLIP-048-SS06-0	F2013	1.15	.500	.506	.695	.835
CLIP-048-SS06-1	F2012	1.15	.500	.506	.695	.835
CLIP-048-SS15-2	Consult Drawing					
CLIP-056-SS06-0	F2011	1.15	.500	.506	.695	1.02
CLIP-056-SS06-1	F2008	1.15	.500	.506	.695	1.02

48/56 SSOP Dimensions/Required Board Space						
Package Type	G	H	I	J	X	Y
48-SS06	.625"	.420"	.025"	.300"	.720"	.570"
56-SS06	.725"	.420"	.025"	.300"	.870"	.570"

20/24 SSOP Test Clip Dimensions/Required Board Space								
Part #	Document #	Pin Ct	E	F	I	J	X	Y
CLIP-020/24-SS12-1	F3708	20/24	1.54"	.54"	.025"	.154"	.540"	.530"
CLIP-020-SS04-1	F3707	20	1.54"	.54"	.065"	.209"	.370"	.310"
CLIP-024-SS04-1	F3709	24	1.54"	.54"	.065"	.209"	.400"	.310"

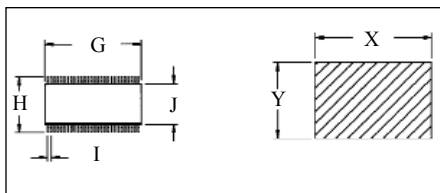

For a complete test clip listing, pricing and delivery information, please see
Web Link: www.1800adapter.com/040

TEST CLIPS - TSOP

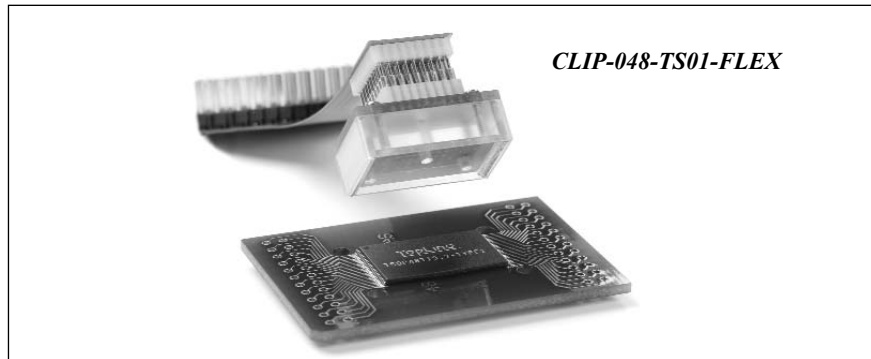

CLIP-048-TS01-FLEX

Ordering Information Example

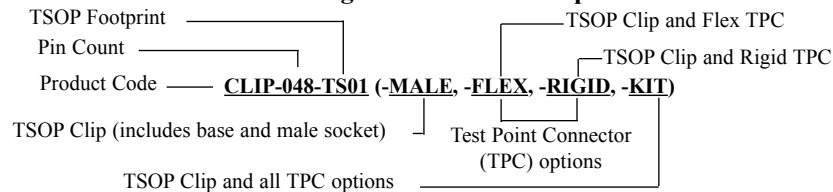

TSOP CLIP WITH MALE SOCKET

Part #	Document #	Lead Pitch	Body Size	Footprint Code
CLIP-028-TS05-MALE	F4235	.55mm	11.8mm	028-TS05
CLIP-032-TS01-MALE	F4234	.50mm	18.4mm	032-TS01
CLIP-032-TS04-MALE	F4234	.50mm	12.4mm	032-TS04
CLIP-040-TS01-MALE	F4233	.50mm	18.4mm	040-TS01
CLIP-048-TS01-MALE	F4232	.50mm	18.4mm	048-TS01
CLIP-048-TS02-MALE	F4236	.50mm	16.4mm	048-TS02
CLIP-056-TS01-MALE	F4231	.50mm	18.4mm	056-TS01

TSOP CLIP WITH FLEX TEST POINT CONNECTOR

Part #	Document #	Lead Pitch	Body Size	Footprint Code
CLIP-028-TS05-FLEX	F4243	.55mm	11.8mm	028-TS05
CLIP-032-TS01-FLEX	F4242	.50mm	18.4mm	032-TS01
CLIP-032-TS04-FLEX	F4242	.50mm	12.4mm	032-TS04
CLIP-040-TS01-FLEX	F4241	.50mm	18.4mm	040-TS01
CLIP-048-TS01-FLEX	F4240	.50mm	18.4mm	048-TS01
CLIP-048-TS02-FLEX	F4244	.50mm	16.4mm	048-TS02
CLIP-056-TS01-FLEX	F4239	.50mm	18.4mm	056-TS01

TSOP CLIP WITH RIGID TEST POINT CONNECTOR

Part #	Document #	Lead Pitch	Body Size	Footprint Code
CLIP-028-TS05-RIGID	F4251	.55mm	11.8mm	028-TS05
CLIP-032-TS01-RIGID	F4250	.50mm	18.4mm	032-TS01
CLIP-032-TS04-RIGID	F4254	.50mm	12.4mm	032-TS04
CLIP-040-TS01-RIGID	F4249	.50mm	18.4mm	040-TS01
CLIP-048-TS01-RIGID	F4248	.50mm	18.4mm	048-TS01
CLIP-048-TS02-RIGID	F4252	.50mm	16.4mm	048-TS02
CLIP-056-TS01-RIGID	F4247	.50mm	18.4mm	056-TS01

TSOP CLIP KIT (Includes all of the Above)

Part #	Document #	Lead Pitch	Body Size	Footprint Code
CLIP-028-TS05-KIT	N/A	.55mm	11.8mm	028-TS05
CLIP-032-TS01-KIT	N/A	.50mm	18.4mm	032-TS01
CLIP-032-TS04-KIT	N/A	.50mm	12.4mm	032-TS04
CLIP-040-TS01-KIT	N/A	.50mm	18.4mm	040-TS01
CLIP-048-TS01-KIT	N/A	.50mm	18.4mm	048-TS01
CLIP-048-TS02-KIT	N/A	.50mm	16.4mm	048-TS02
CLIP-056-TS01-KIT	N/A	.50mm	18.4mm	056-TS01

TSOP TEST CLIPS

This is the first clip-on solution specifically designed for testing Thin Small Outline Packages (TSOPs). Its low-profile design and use of directionally conductive elastomeric connectors make it ideal for probing units up to .030" apart and with a lead pitch of 0.50mm to 0.55mm.

MATERIAL:

Body: Vespel^{®E}
Pins: 10μ" Gold over 100μ" Nickel
Posts: 10μ" Gold over 50μ" Nickel

OPERATING CHARACTERISTICS:

Elastomer Base:
250 milliohms
Flex Test Point Connector:
150 milliohms
Rigid Test Point Connector:
350 milliohms

HOW TO ORDER

- 1) Select pin count.
- 2) Determine lead pitch and body size.
Tolerance on body size is +/- .4mm.
- 3) Verify the correct footprint (See footprint section in catalog).

For a complete test clip listing, pricing and delivery information, please see:

Web Link: www.1800adapter.com/040

DIP CLIP™

Emulation Technology test adapters are designed especially for testing dual-in-line IC packages on high-density PC boards. The DIP CLIP™ test adapter has many built-in features that assure a positive electrical connection while providing hands-free testing.

The high density DIP CLIP™ test adapters are used for ultra-dense packaged chips located adjacent to each other on 2.54mm (.100") spacing.

MATERIAL: Contact, tarnish resistant Nickel, Silver or Gold plated Beryllium Copper. Stainless steel hinge pin and spring.

INSULATION: Glass filled nylon, blue.

RATING: 500 VRMS; 1 Amp; +102°C (+126°F) Max.

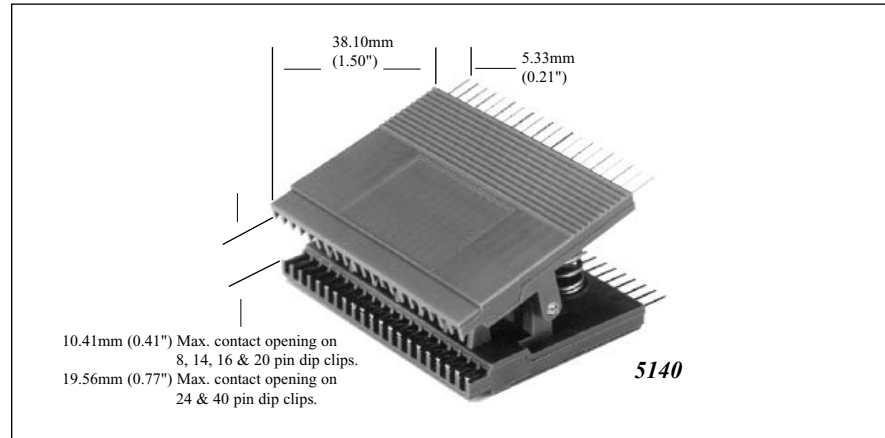

Part #	No. of Pins	Contact Material	Type
5108	8	Gold Plated Beryllium Copper	Standard
5208	8	Gold Plated Beryllium Copper	High Density
5014	14	Spring Tempered Nickel Silver	Standard
5114	14	Spring Tempered Nickel Silver	High Density
5214	14	Gold Plated Beryllium Copper	Standard
5314	14	Gold Plated Beryllium Copper	High Density
3916A	16	Spring Tempered Nickel Silver	Standard
4236A	16	Spring Tempered Nickel Silver	High Density
5116	16	Gold Plated Beryllium Copper	Standard
5216	16	Gold Plated Beryllium Copper	High Density
5120	20	Gold Plated Beryllium Copper	Standard
5220	20	Gold Plated Beryllium Copper	High Density
4124A	24	Spring Tempered Nickel Silver	Standard*
4324A	24	Spring Tempered Nickel Silver	High Density*
5124	24	Gold Plated Beryllium Copper	Standard*
5224	24	Gold Plated Beryllium Copper	High Density*
4140A	40	Spring Tempered Nickel Silver	Standard*
4340A	40	Spring Tempered Nickel Silver	High Density*
5140	40	Gold Plated Beryllium Copper	Standard*
5240	40	Gold Plated Beryllium Copper	High Density*

FEATURES

- Contacts 1.02 mm (.040") wide on lower end are serrated for good electrical connection
- 0.64mm (.025")X0.71mm (.028") square serrated test points on upper end will accept wire wraps or mini test clips
- Molded barrier between each contact allows connections to be made on live boards without accidental shorting of adjacent contacts

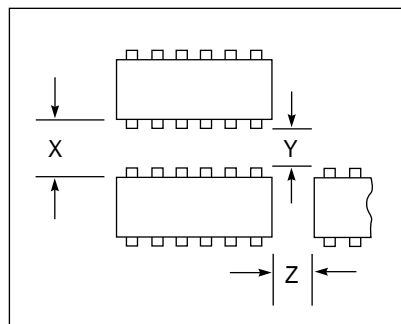

	X Min.	Y Min.	Z Min.
Single Chip Testing Standard	3.30mm (.130")	1.91mm (.075")	1.02mm (.040")
Single Chip Testing High Density	2.67mm (.105")	1.27mm (.050")	1.02mm (.040")
Adjacent	7.62mm (.300")	5.72mm (.225")	2.03mm (.080")

For a complete test clip listing, pricing and delivery information, please see
Web Link: www.1800adapter.com/040

SMD GRABBERS®

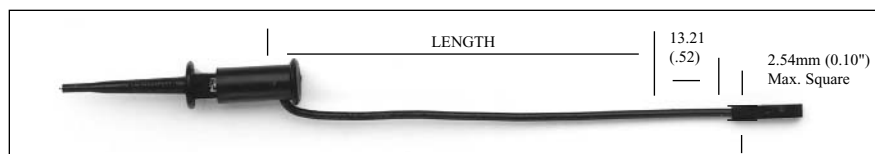

0.64mm (.025") Sq. Pin Receptacle End: Gold plated Phosphor Bronze. ABS insulation.

Part #	2nd End	Length
5302-12-*	Stacking Banana Plug	304.8mm (12.0")
5302-24-*	Stacking Banana Plug	609.6mm (24.0")
5302-36-*	Stacking Banana Plug	914.4mm (36.0")
5412-12-*	.064 mm Sq. Pin Receptacle	304.8mm (12.0")
5412-24-*	.064 mm Sq. Pin Receptacle	609.6mm (24.0")
5412-36-*	.064 mm Sq. Pin Receptacle	914.4mm (36.0")

***STD COLORS:** -0 Black, -2 Red.

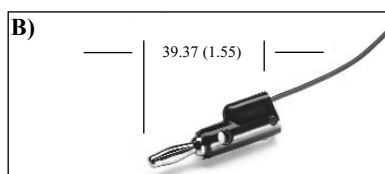
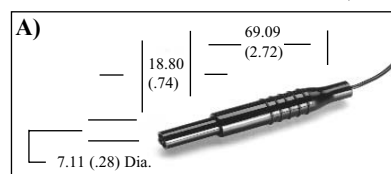

SMD GRABBER TEST CLIP TO VARIOUS ENDS

1ST END: SMD Grabber Test Clip. Contact, selectively gold plated stainless steel. Insulation; glass filled nylon.

WIRE: 22 AWG, 26x36 t.c., PVC insulated, 1.63mm (.064") O.D.

RATING: 1000 WVDC; 0.5 Amps; +50°C (+122°F) Max.

A) Sheathed Banana Plug End:

Brass body, Beryllium Copper spring, Nickel plated. Nylon insulation.

B) Stacking Banana Plug End:

Brass body, Beryllium Copper spring, Nickel plated. Polypropylene insulation.

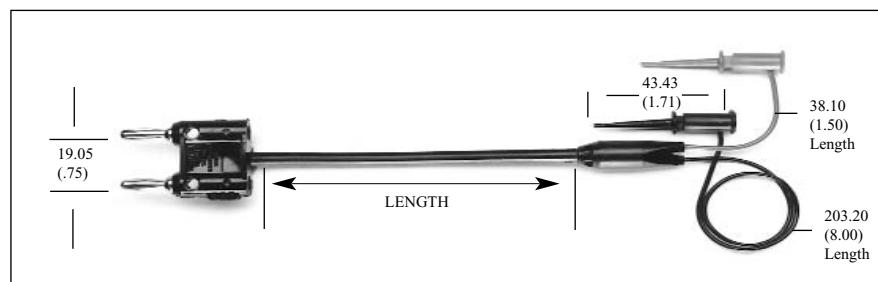

Double Banana Plug End: Nickel plated Brass body. Beryllium Copper spring. Black polyethylene insulation. Rating: 1000WVDC; 0.5 Amp; +55°C (+131°F) Max.



Part #	2nd End	Length
5304-K-24	BNC Male	609.6mm(24.0")
→ 5304-K-36	BNC Male	914.4mm(36.0")
5411-C-36	Dbl. Banana Plug	914.4mm(36.0")
5411-C-60	Dbl. Banana Plug	1524.0mm(60.0")

SMD GRABBER TEST CLIPS TO VARIOUS ENDS

1ST END: SMD Grabber Test Clips. Contact, selectively gold plated stainless steel. Insulation; glass filled nylon. One black, one red.

CABLE: Shielded coax., RG 174/U, 2.54mm (.100) and RG58C/U, 4.95mm (.195) O.D. Y-Mold insulation, PVC, black.

BNC Male End:

Brass body, tarnish resistant plated. Brass center contact, gold plated. Nominal impedance: 50 Ohms. Boot, PVC, black. Rating: 500 VRMS Max.; +50°C (+122°F) Max.

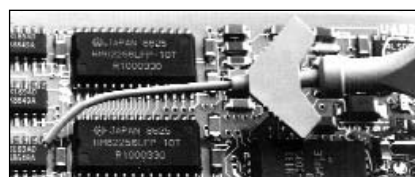

SMT GRABBER VALUE PACK

- Includes 20 SMT Grabber Clips.

Specifications: Grabbers
 Elect. Connector Point: 2 (0.025" connections)
 Resistance: 12-30 millions
 Dimensions: Shaft: 0.05" O.D.
 Length: 2.30"
 Weight: 1.0 grams
 Wire: .011".
 Leads: N/A

SMT GRABBER CLIPS WITH FLEXIBLE TIP

The flexible tip sleeve allows for bending up to a 35 degree angle to accommodate for hard-to-reach circuit locations.

Part #
SMG50

For a complete test clip listing, pricing and delivery information, please see
Web Link: www.1800adapter.com/040

TEST CLIPS - SMD GRABBER®

The SMD Grabber Test Clip is especially suited for testing surface mounted packages on centers as small as 0.76mm (.030"). Pincer-like contacts grasp individual legs of SMDs such as those in SOIC, SOJ, PLCC packages. Its circular design and small size have been developed for easy use and handling.

SMD GRABBER TEST CLIP, DO-IT-YOURSELF

Part #
5243-*

*STD COLORS: -0 Black, -1 Brown, -2 Red, -3 Orange, -4 Yellow, -5 Green, -6 Blue, -7 Violet, -8 Gray, -9 White.

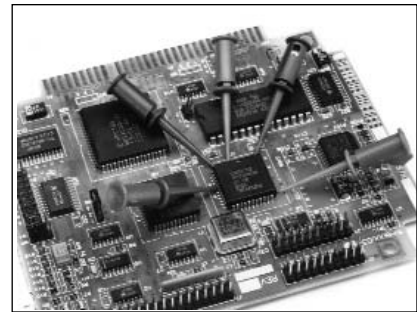
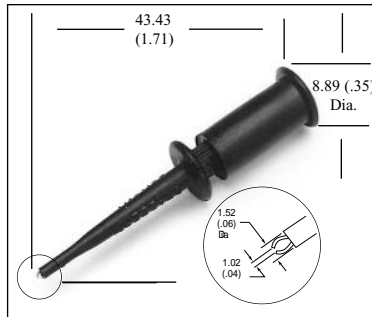

MATERIAL: Contact, stainless steel.
FINISH: Selectively gold plated on tip.
INSULATION: Glass filled nylon.
RATING: 1000 WVDC; 0.5 Amp; +102°C (+216°F) Max.

SMD GRABBER TEST CLIP, with 0.64mm (.025") SQ. PIN

Part #
5360-*

*STD COLORS: -0 Black, -1 Brown, -2 Red, -3 Orange, -4 Yellow, -5 Green, -6 Blue, -7 Violet, -8 Gray, -9 White.

1ST END: Contact, stainless steel, selectively gold plated.
INSULATION: Glass filled nylon.
2ND END: Square pin, phosphor bronze, gold plated.
RATING: 1000 WVDC; 0.5 Amps; +102°C (+216°F) Max.

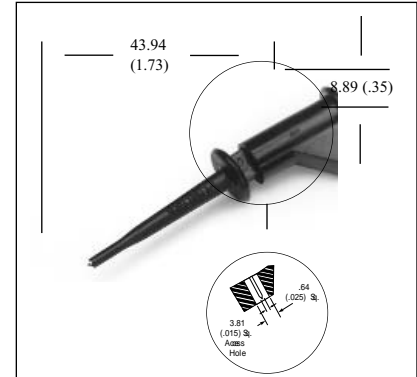

SMD GRABBER TEST CLIP, ONE and TWO ENDS

Part #	Length	Ends
5303-36-*	914.4mm (36.0")	1
5301-06-*	152.4mm (6.0")	2
5301-12-*	304.8mm (12.0")	2
5301-24-*	609.6mm (24.0")	2
5301-36-*	914.4mm (36.0")	2

*STD COLORS: -0 Black, -2 Red

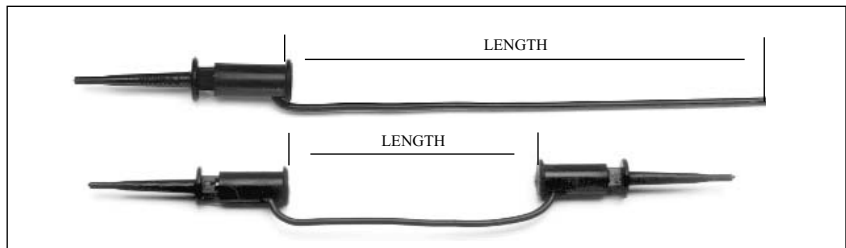

1ST END: SMD Grabber Test Clip. Contact, selectively gold plated stainless steel. Insulation; glass filled nylon.
WIRE: 22 AWG, 26x36 t.c., PVC insulated, 1.63mm (.064") O.D.
2ND END: One end only - none. Two ends - same as first end.
RATING: 1000 WVDC; 0.5 Amps; +102°C (+216°F) Max.

ULTRA-THIN GRABBER TEST CLIP, ONE and TWO ENDS

These test clips are especially designed for testing today's fine-pitched, surface mount devices. This ultra-thin body contour combined with a 1.2mm/0.5" shaft maximizes the users' ability to stack the clips tightly onto fine-pitched devices with up to 50 mils spacing. The shaft flexes (up to 36°) for easy access from different angles.

Part #
6090-40-0 (Black) One end only
6090-40-2 (Red) One end only
6091-30-0 One each end
6091-30-2 One each end

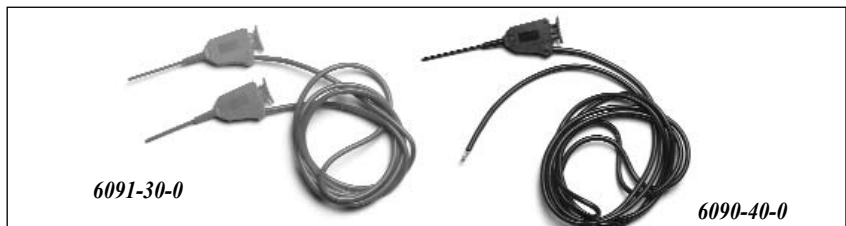

WIRE: Silicone insulated, 2mm (.08") O.D. Overall length of 54mm/2.13"
2ND END: One end only - none. Two ends - same as first end.
TEMP: -20° to 80° C.

For a complete test clip listing, pricing and delivery information, please see
Web Link: www.1800adapter.com/040

POFP MICROGRIPPERS™

MicroGripper 0.8mm to 0.5mm Lead Pitch (3 Side by Side - Maximum)

- Used to monitor signal on SMT packages up to 0.5mm lead pitch with a logic analyzer or oscilloscopes
- 3 adjacent SMT leads (max.) for testing
- Board under test must be inactive when connecting clips
- Maximum frequency is 100MHz
- Contact resistance is 10 Ω

PART NUMBERS: **FP-1B10**
FP-1B30
FOP-2, FOP-3, FOP-4

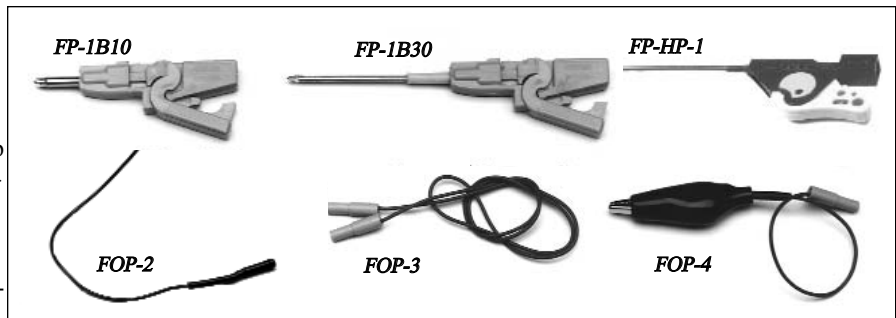

Part	Document	Description	Qty.
FP-1B10	F3855	Gripper, 10mm long tip	ea.
FP-1B30	F3855	Gripper, 30mm long tip	ea.
FOP-2*	F3855	Jumper lead, 200mm long, female to female	ea.
FOP-3*	F3855	Jumper lead, 300mm long, female to female	ea.
FOP-4*	F3855	Jumper lead, 100mm long, alligator clip at opposite end	ea.
FP-HP-1	F3855	Gripper, 2.54mm to 0.8mm, (See Below)	10/pkg.

* Necessary if using an oscilloscope.

MicroGripper 2.54mm to 0.8mm Lead Pitch

- Includes 10 multi-colored Grippers
- Barrel bends 30 degrees for hard to reach signal probing

PART NUMBER: **FP-HP-1**

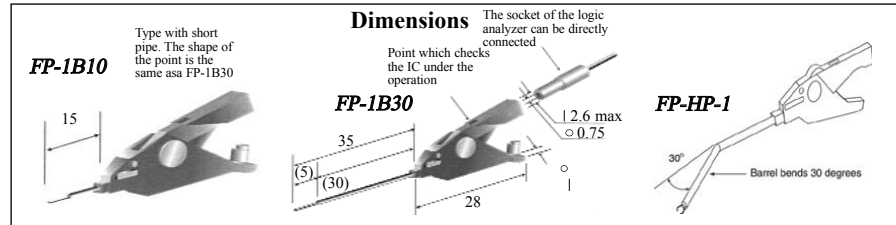

MicroGripper Oscilloscope Probe Adapter Kit 1.25mm to 0.2mm Lead Pitch

- Monitor signals of QFP and SOIC packages to 0.2mm lead pitch with standard oscilloscopes
- Plug your probe tip into dual-lead adapter, then connect Grippers to female test leads (see drawing below)
- Probe kits contain 4 MicroGrippers, 2 Scope Adapters

5.2mm Diam. Probe Adapter (Alone)
P/N: ETPF/064 Drawing#: F5720

7.2mm Diam. Probe Adapter (Alone)
P/N: FP-GR-P1 Drawing#: F6088

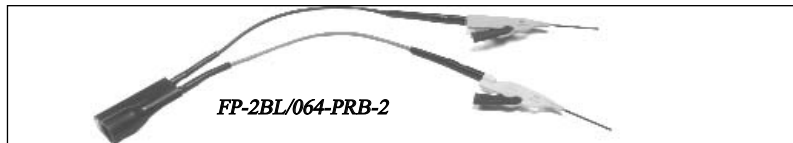

Probe Tip Diameter	Lead Pitch Range	ET Part #	Drawing #
5.2mm	1.25mm to 0.3mm SHORT VERSION	FP2B/064-PRB-2	F2317
5.2mm	1.25mm to 0.3mm LONG VERSION	FP2BL/064-PRB-2	F2317
5.2mm	0.5mm to 0.2mm	FP2S/064-PRB-2	F5732
7.2mm	1.25mm to 0.3mm SHORT VERSION	FP2B/GRP1-PRB-2	F2317
7.2mm	1.25mm to 0.3mm LONG VERSION	FP2BL/GRP1-PRB-2	F2317
7.2mm	0.5mm to 0.2mm	FP2S/GRP1-PRB-2	F5732

For complete specifications including a manufacturer cross reference, please visit our Web site.

High Temperature MicroGripper 1.25mm to 0.3mm Lead Pitch

- New temperature rated MicroGrippers
- Test from -55 $^{\circ}$ C to +250 $^{\circ}$ C
- Two temperature Range options available
- Contact Resistance 10m Ω

P/N: **FP-HR-1**: -55 $^{\circ}$ C to +250 $^{\circ}$ C MicroGripper

P/N: **FP-HRG-1** ; -20 $^{\circ}$ C to +150 $^{\circ}$ C MicroGripper

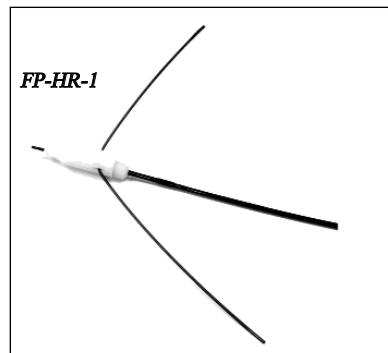

For a complete test clip listing, pricing and delivery information, please see
Web Link: www.1800adapter.com/040

POFP MICROGRIPPERS™

MicroGripper™

**1.25mm to 0.2mm Lead Pitch
(Unlimited - Side by Side)**

- Used with SMT packages down to 0.3mm lead pitch
- Thin clip body width allows many lead grippers to be mounted side by side for simultaneous testing
- Bandwidth (3dB> 100MHz)
- Packaged 10 per box

MATERIAL: Steel wire or stainless steel,
Nickel plated
FINISH: Plastic: ABS
RATING: 500 WVDC

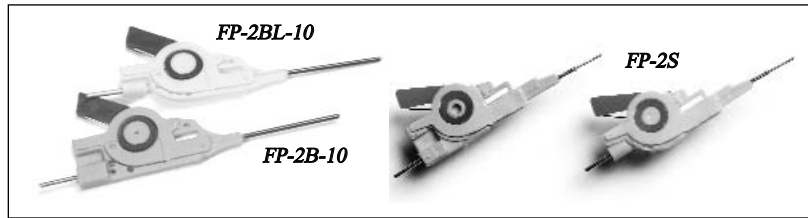

Part	Description	Qty	Document
FP-2BL-10	Gripper, short/no cords, 1.25 to 0.3mm	10/pkg.	F3217
FP-2B-10	Gripper, 0.8mm	10/pkg.	N/A
FP-2CL-10*	Gripper, long w/cords, 1.25 to 0.3mm*	10/pkg.	N/A
FP-2C-10*	Gripper, short w/cords, 1.25 to 0.3mm*	10/pkg.	N/A
FP-2S-10:	Gripper, long w/cords, 0.5 to 0.2mm	10/pkg.	N/A
FOP-1:	Jumpers/Male to Female, 0.5 to 0.2mm	10/pkg.	N/A

* With colored jumpers

Improved version has a Teflon™ coated tip and 40% more distance when spring is extended.

Micro Gripper™

**1.25mm to 0.3mm Lead Pitch
(Unlimited - Side by Side)**

- New low profile MicroGrippers
- Conductor resistance for ET P/N: FP-7CL=2mΩ max
- Conductor resistance for ET P/N: FP-LA1=40mΩ max
- Flexible stand wires included with each package of 10

FP-7C-10: Gripper short /10 per package with cord
FP-7CL-10: Gripper long/10 per package with cord
FP-LA1C-10: Gripper long/10 per package with cord

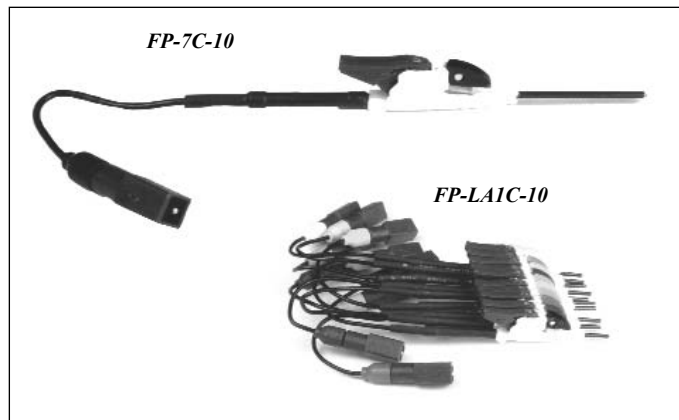

MicroGripper™ Kelvin True Measure

1.25mm to 0.3mm Lead Pitch

- Used with SMT packages down to 0.3mm lead pitch
- Thin clip body width allows many lead grippers to be mounted side by side for simultaneous testing
- Maximum frequency is 100MHz

FEATURES & BENEFITS

- Four wire measurement using the Kelvin probe reduces the voltage drop in test leads that cause measurement inaccuracies
- Excellent for resistance measurement below 2W
- Double probe tines are ideal for testing surface mount and small leaded components
- Probe tips and spade lugs are gold plated Beryllium Copper for low contact resistance
- Compatible with Agilent, Keithley, Tektronix and most 4 wire test instruments with screw connections for binding posts
- Extremely small 7mm body height for tight testing areas
- Flexible stand wires included with each package



FP-KELVIN-2: Gripper short 2 per package with cord

For a complete test clip listing, pricing and delivery information, please see
Web Link: www.1800adapter.com/040



MICROGRIPPERS™ - HIGH SPEED 1 TO 5 GHz

TEST CLIPS & OSCILLOSCOPES

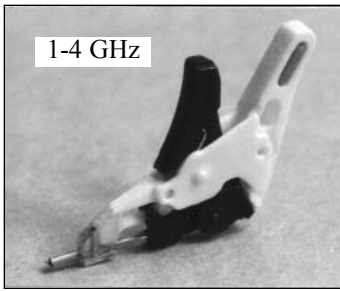

1-4 GHz

P/N: FPN-SM-105F-1

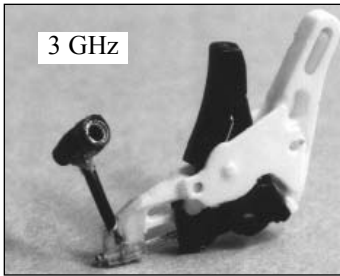

3 GHz

P/N: FPN-M-10

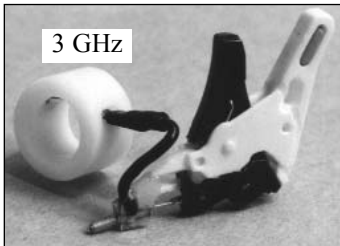

3 GHz

P/N: FPN-M-30

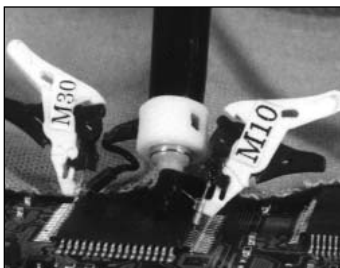

P/Ns FPN-M10 & FPN-M-30 in use.

Now you can accomplish high frequency signal measurement in the GHz band using an oscilloscope.

Test accessories with long conductors used together with circuits that output high-speed signals can degrade the signal fidelity and add noise. This is why we created the ideal microgripper for high-speed signal measurement.

FEATURES & BENEFITS

- The Noise Free Micro Gripper attaches directly to the socket tip of the differential probe
- You can connect in parallel by 0.2mm pitch between center of QFP and center of IC terminal
- Available for 1 GHz, 3 GHz, 5 GHz & 10 GHz
- Available in 2.54mm to 0.2mm lead pitches

YOU MUST USE TWEEZERS WHEN YOU USE THIS CLIP

Lead Pitch Range (mm)	Lever Color	Barrel Length (mm)	Cord Length (mm)	Cord Diameter (mm)	Conductor Resistance (Milliohm)	Capacitance (pF)	Male Pin Diam (mm)	Female Skt Diam (mm)	Drawing Number	ET Part #
1 GHz										
0.2 to 0.5	Red	3.00	5.00	0.75	0.5	0.5		0.65-0.80	F7061	FPN-S-15
0.2 to 0.5	Red	3.00	10.00	0.75	0.8	1.0		4.80	F7061	FPN-S-25
0.5 to 1.0	Blue	3.00	5.00	0.75	0.5	0.5		0.65-0.80	F7061	FPN-M-15
0.5 to 1.0	Blue	3.00	10.00	0.75	1.5	2.0		4.80	F7061	FPN-M-20
0.5 to 1.0	Blue	3.00	10.00	0.75	0.8	1.0		4.80	F7061	FPN-M-25
0.8 to 2.54	Green	3.00	5.00	0.75	0.5	0.5		0.65-0.80	F7061	FPN-L-15
0.8 to 2.54	Green	3.00	10.00	0.75	0.8	1.0		4.80	F7061	FPN-L-25
3 GHz										
0.2 to 0.5	Red	1.50	3.00	0.75	0.3	0.3		0.65-0.80	F7062	FPN-S-10
0.2 to 0.5	Red	3.00	10.00	4.80	0.8	1.0		4.80	F7062	FPN-S-30
0.5 to 1.0	Blue	1.50	3.00	0.75	0.3	0.3		0.65-0.80	F7062	FPN-M-10
0.5 to 1.0	Blue	3.00	10.00	4.80	0.8	1.0		4.80	F7062	FPN-M-30
0.8 to 2.54	Green	1.50	3.00	0.75	0.3	0.3		0.65-0.80	F7062	FPN-L-10
0.8 to 2.54	Green	3.00	10.00	4.80	0.8	1.0		4.80	F7062	FPN-L-30

All high speed Microgrippers are sold in pairs. Minimum order is 2 units. The 1—4 GHz Microgrippers come with accessories kit (FPN-T-55, shown below).

HIGH SPEED MICROGRIPPER ACCESSORIES KIT

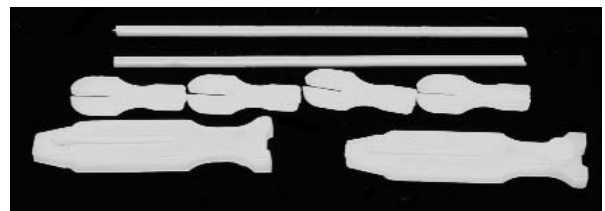

P/N: FPN-T-55

Try our SolderQuik™ BGA Preform

Allows for easy and inexpensive testing of new BGA package designs. Use it for testing, rework and prototyping BGA packages.

Web Link: www.1800adapter.com/043

For a complete list of high-speed microgripper specifications, pricing and delivery information, see:

Web Link: www.1800adapter.com/105



Now you can accomplish high frequency signal measurement in the GHz band using an oscilloscope.

Test accessories with long conductors used together with circuits that output high-speed signals can degrade the signal fidelity and add noise. This is why we created the ideal microgripper for high-speed signal measurement.

FEATURES & BENEFITS

- The Noise Free Microgripper attaches directly to the socket tip of the differential probe
- You can connect in parallel by 0.2mm pitch between center of QFP and center of IC terminal
- Available for 1 GHz, 3 GHz, 5 GHz & 10 GHz
- Available in 2.54mm to 0.2mm lead pitches.

YOU MUST USE TWEEZERS WHEN YOU USE THIS CLIP

Lead Pitch Range (mm)	Lever Color	Barrel Length (mm)	Cord Length (mm)	Cord Diameter (mm)	Conductor Resistance (Milliohm)	Capacitance (pF)	Male Pin Diam. (mm)	Female Skt Diam. (mm)	Drawing Number	ET Part #
5 GHz										
0.2 to 0.5	Red	1.50	3.00	0.75	0.3	0.3	0.68		F7063	FPN-S-1
0.2 to 0.5	Red	3.00	5.00	0.75	0.5	0.5	0.68		F7063	FPN-S-2
0.5 to 1.0	Blue	1.50	3.00	0.75	0.3	0.3	0.68		F7063	FPN-M-1
0.5 to 1.0	Blue	3.00	5.00	0.75	0.5	0.5	0.68		F7063	FPN-M-2
0.8 to 2.54	Green	1.50	3.00	0.75	0.3	0.3	0.68		F7063	FPN-L-1
0.8 to 2.54	Green	3.00	5.00	0.75	0.5	0.5	0.68		F7063	FPN-L-2
10 GHz										
0.2 to 0.5	Red	0.50	2.00	0.75	0.2	0.2	0.68		F7064	FPN-SS-1
0.5 to 1.0	Blue	0.50	2.00	0.75	0.2	0.2	0.68		F7064	FPN-SM-1
0.8 to 2.54	Green	0.50	2.00	0.75	0.2	0.2	0.68		F7064	FPN-SL-1

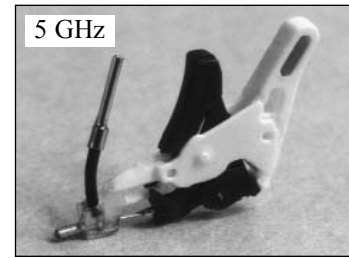

P/N FPN-M-2



P/N: FPN-M-10

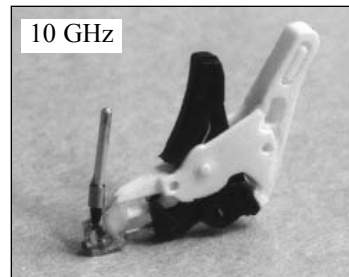

P/N: FPN-M-10

All high speed Microgrippers are sold in pairs. Minimum order is 2 units. The 5—10 GHz Microgrippers come with accessories kit, Part number FPN-T-55 (Pictured on page 172.)

HIGH SPEED MICROGRIPPER TWEEZERS



P/N: FPN-T-55



P/N: FPN-T-56

Try our **SolderQuik™ BGA Preform**
 Allows for easy and inexpensive testing of new BGA package designs. Use it for testing, rework and prototyping BGA packages.
Web Link: www.1800adapter.com/043

For a complete list of high-speed microgripper specifications, pricing and delivery information, see:
Web Link: www.1800adapter.com/105

SMD TEST PROBES

EXTENDABLE TIP PROBE TO VARIOUS ENDS

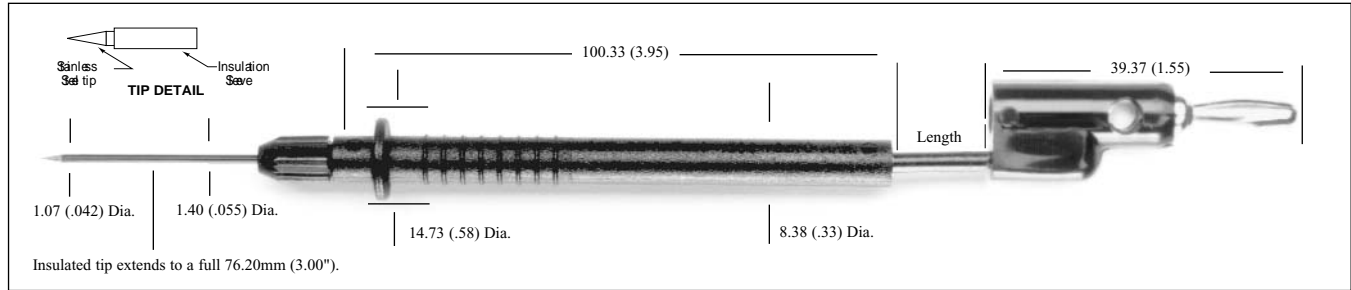

Stacking Banana Plug End: Brass body, Beryllium Copper spring, Nickel plated. Insulation; polypropylene. Two pieces: Black and Red.

1ST END: Extendable Probe. Collet, brass. Insulation; nylon. Tip; stainless steel. Insulation; Kynar. Chuck nut, nylon.

WIRE: 18 AWG, 65X36 t.c., PVC insulated, 3.66mm (.144") O.D.

RATING: 1500 V AC/DC; 3 Amps; +55°C (+131°F) Max.

Part #	2nd End	Length
5952	Stacking Banana Plug	1219.2mm (48.0")

SMD MICROTIP™ TEST PROBE

SMD MICROTIP™

The Microtip is specially designed to probe SMD contacts. It features a stainless steel needle point tip that is flexible to help prevent damage to the SMD lands. The microtip is curved to aid probing of hard to reach areas.

Part #	Length
5144-48-*	1219.2mm (48.0")

*STD COLORS: -0 Black, -2 Red.

1ST END: SMD Microtips Test Probe. Chuck, brass, Nickel plated. Replaceable microtip, stainless steel. Insulation; nylon.

WIRE: 20 AWG, 41X36 t.c., PVC insulated, 2.21mm (.087") O.D.

RATING: 1200 V AC/DC; 5 Amps; +55°C (+131°F) Max.

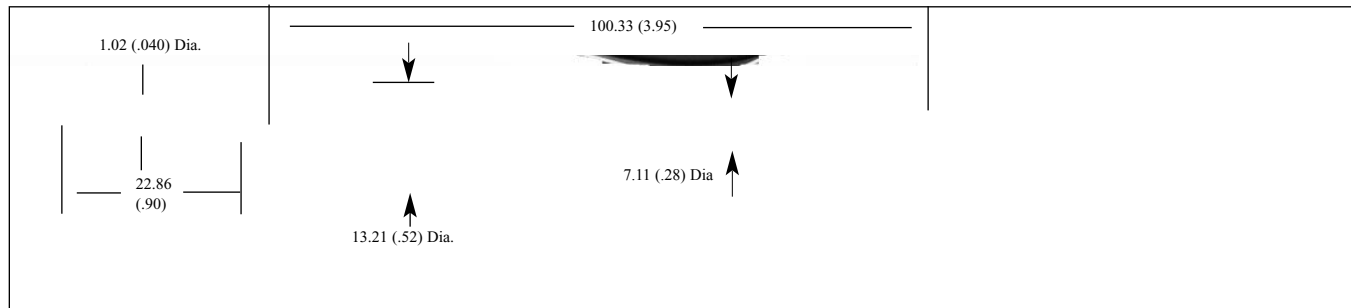

Stacking Banana Plug End: Brass body, Beryllium Copper spring, Nickel plated. Insulation; polypropylene.

QUICK PROBE TEST FIXTURE

This probe is designed to provide quick and easy SMD probing. Its simple design quickly connects a test instrument, such as an oscilloscope, to a variety of SMDs including PLCC, SOIC, QFP, and VIAS or test point holes.

Part #	Document #
QP-2000	F1011

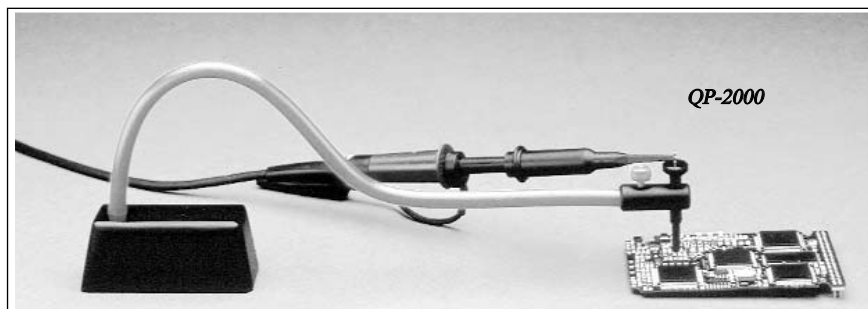

- Heavy base and flexible shaft make positioning to a test point a simple process.
- Adjustment features enable precise positioning to adjacent test points, even on very fine pitches.

For a complete test clip listing, pricing and delivery information, please see:
Web Link: www.1800adapter.com/040

SMD TEST PROBES & TWEEZERS

PROBE SET AND REPLACEMENT TIPS

The precise probe set is ideal for making measurements not easily accessible. The right-angle sheathed banana plug provides easy connection to hand-held digital instruments. The plugs fit most Fluke, Tektronix, Hewlett-Packard and Wavetek meters.



Right-Angle Banana Plug End: Brass body, Beryllium Copper spring, Nickel plated. Insulation; polypropylene, one black and one red.

INSULATION: Nylon 6 fire retardant, UL94 VO, or fire retardant polypropylene.
WIRE: 24 AWG, stranding 45X 40 tinned copper, silicon rubber .089 (2,26 mm) O.D.

Part #	Description
6341	Probe set with 5 sets of replacement tips
6354	5 replacement tips

SMD TWEEZER CLIPS

The tweezer clip is specifically designed for testing Surface Mounted Devices (SMD). The durable tips assure a positive electrical connection. The tweezer gives rapid and convenient testing.

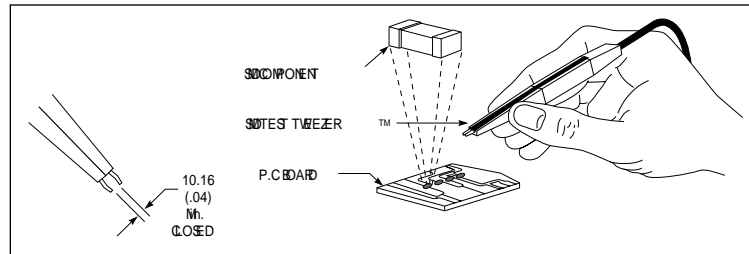
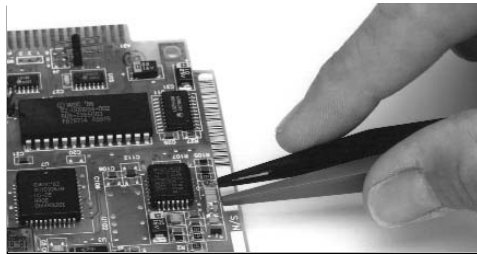

SMD TEST TWEEZER™ TO VARIOUS ENDS

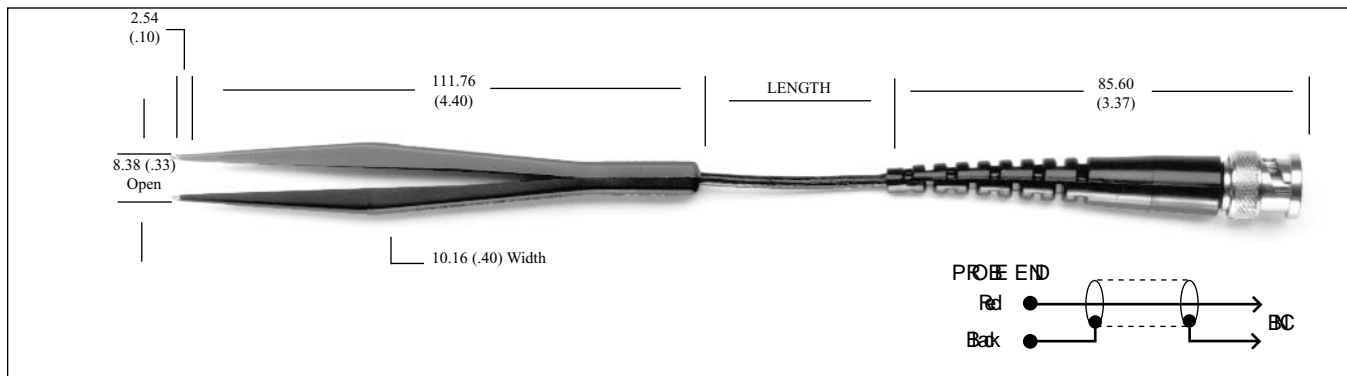

BNC Male End: Brass body, tarnish resistant plated. Center contact, brass gold plated. Boot; PVC, black.

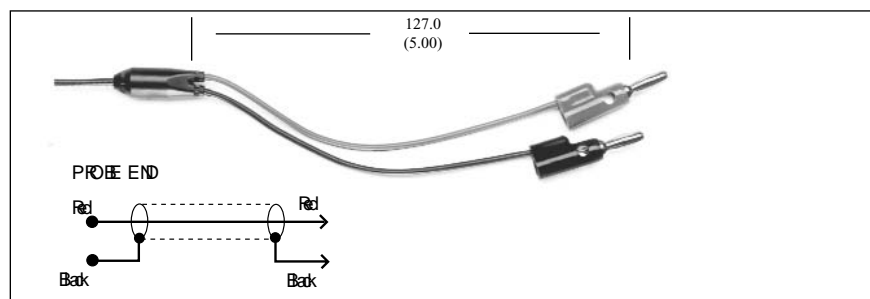

Single Stacking Banana Plug End: Brass body, Beryllium Copper spring, Nickel plated. Insulation; polypropylene, one black and one red.

1ST END: SMD Test Tweezer. Tips, Beryllium Copper, gold plated. Insulation; glass filled nylon, black and red.

CABLE: Shielded coaxial, RG174/U, 2.54mm (.100") O.D.

RATING: 400 WRMS; 3 Amps; +50°C (+122°F) Max.

Part #	Length
5142-K-48	1219.2mm (48.0")
5143-K-48	1219.2mm (48.0")

For a complete test clip listing, pricing and delivery information, please see
Web Link: www.1800adapter.com/040

PROBE TEST FIXTURE/PROBE KITS

DELUXE PROBE KIT

This ET9104R Probe Kit is a modular package that includes two leads, two probes, 2 sprung hook probes, 2 alligator clips, two spade lugs, and a pouch.

FEATURES

- Silicone leads
- Burn resistant
- Goldleaf contacts
- 18 gauge (440 strands)

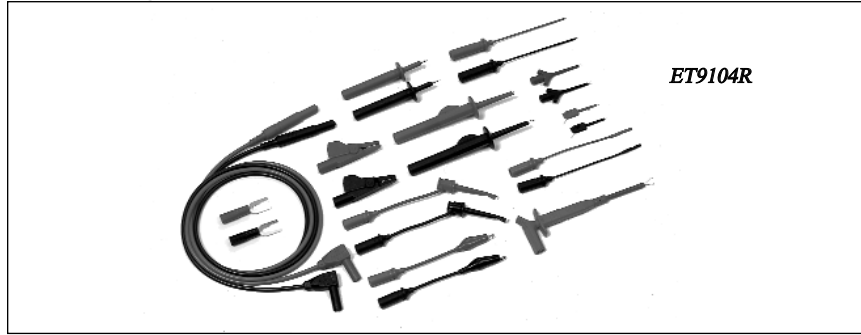

Part #
ET9104-R

DELUXE PROBE KIT

This DELUXE Probe Kit includes the probe, a storage pouch and 17 accessories, plus a set of snap-on channel identification markers (various colors). You can master the most difficult servicing or design problems by simply connecting the correct accessories to the probe.

FEATURES

- 18-piece kit
- Low resistance gold contacts
- Switchable readout actuator option

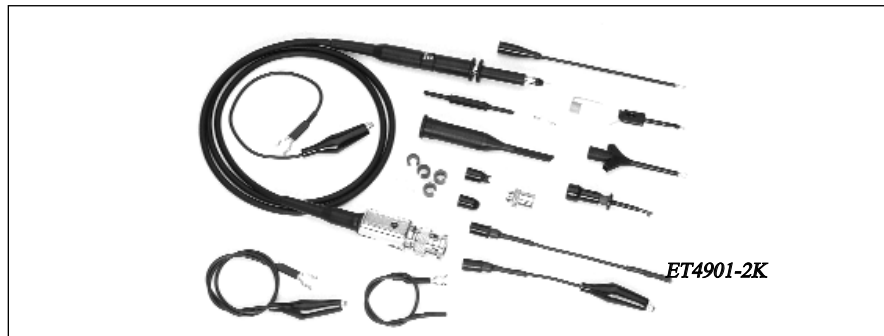

PART #	ATTEN.	LENGTH		BW-MHz AT-3DB	RISE TIME ns	LOADING	
		FT.	M.			pF	Ω
ET4901-2K	SWITCHED 1X/R/10X	5.0	1.5	10/150	35/2.40	57/115	1/10
ET4903-2K	FIXED 1X	5.0	1.5	30	11.6	40	1
ET4904-2K	FIXED 10X	5.0	1.5	150	2.4	15	10
ET4905-2K	FIXED 10X	5.0	1.5	250	1.4	12	10
ET4910-2K	FIXED 100X	5.0	1.5	200	1.7	3.5	10
ET4906-2K	FIXED 10X	5.0	1.5	300	1.16	11	10

SMD TEST PROBES

Designed to provide high performance, reliable SMD testing.

Each of the test probes features a sharp, spring-loaded tip to assist users needing to test within an SMD environment where space is limited and the test points are difficult to reach.



- Spring contact minimizes pressure on DUT and prevents slippage on the board surface
- Laser trimmed hybrid circuitry improves accuracy and reliability
- Reed relay switch with a shielded X10 position prevents accidental operation
- Fast rise times
- True frequency response

ET Part #	Application	Characteristics	Drawing #
ET-PMV511	Timing & voltage high impedance measurements	10 Mohms, 15 pF bandwidths to 500 MHz	F6779
ET-PMM501	Low mass, general purpose, high impedance measurements	10 Mohms, 10 pF	F6780
ET-PMMZ511	Low-mass, low impedance measurements	450 to 950 ohms, 1.5 pF	F6781
ET-PHV641-L	Probing high power discrete components	66 Mohms, 3pF 100:1 for measurements to 2 kV	F6782
ET-PHV4002-3	Switching power supply, power transmission	1000:1 divider for measurements to 30 kV	F6783
ET-PMT G321	General purpose for work bench or field service	10 Mohms, 15 pF or 1 Mohm, 50 pF	F6784

For a complete test clip listing, pricing and delivery information, please see: **Web Link: www.1800adapter.com/040**