



**R**esearch  
& **E**ngineering

OCTOBER 1957

The Magazine of

# **DATA***mation*

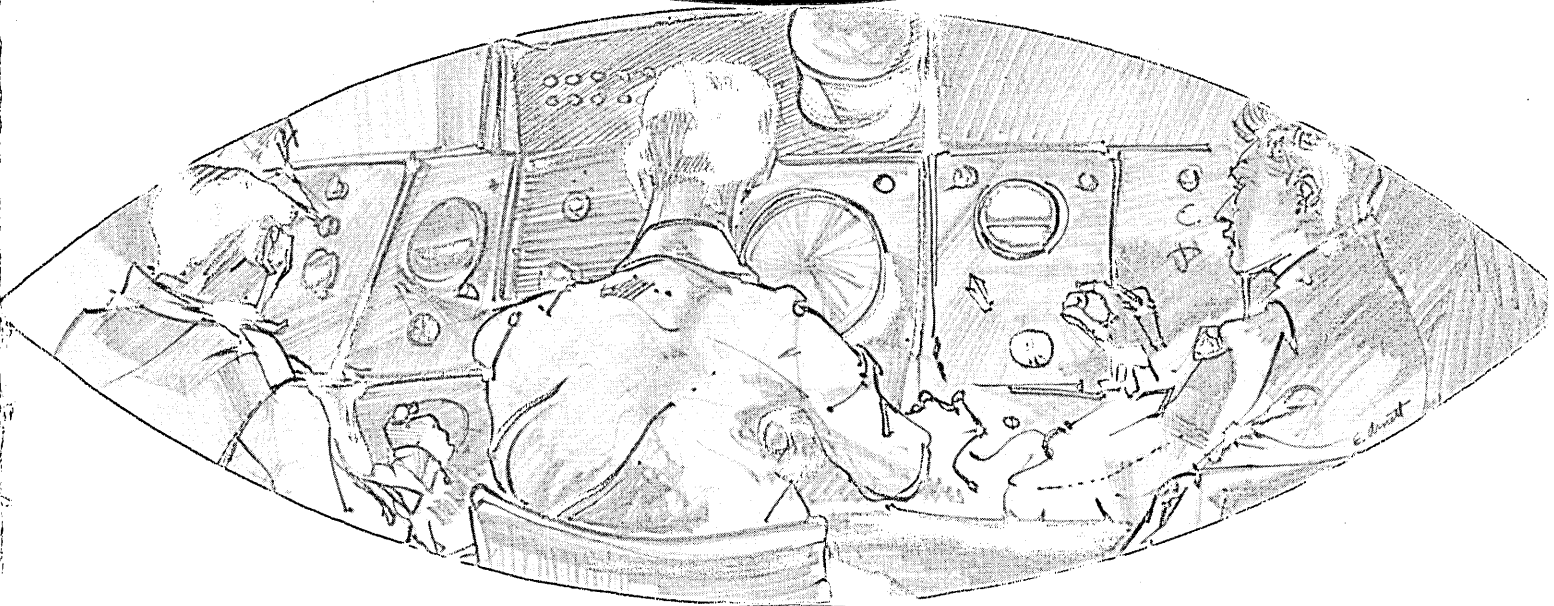

The automatic handling of information

from **AMPHENOL**  
Research and  
Development

★  
Two years in design and testing, AMPHENOL's proven Poke-Home contacts are ready! Six major new connector lines (in standard, rack & panel and miniature types) incorporating Poke-Home contacts are now being tooled. Watch for further announcements!

## POKE-HOME CONTACTS

- ★ Wired outside the connector — "poked home" for assembly
- ★ Increased reliability
- ★ Individual wire maintenance
- ★ Ease of inspection
- ★ Adaptable to automation
- ★ Substantial reduction in wiring costs

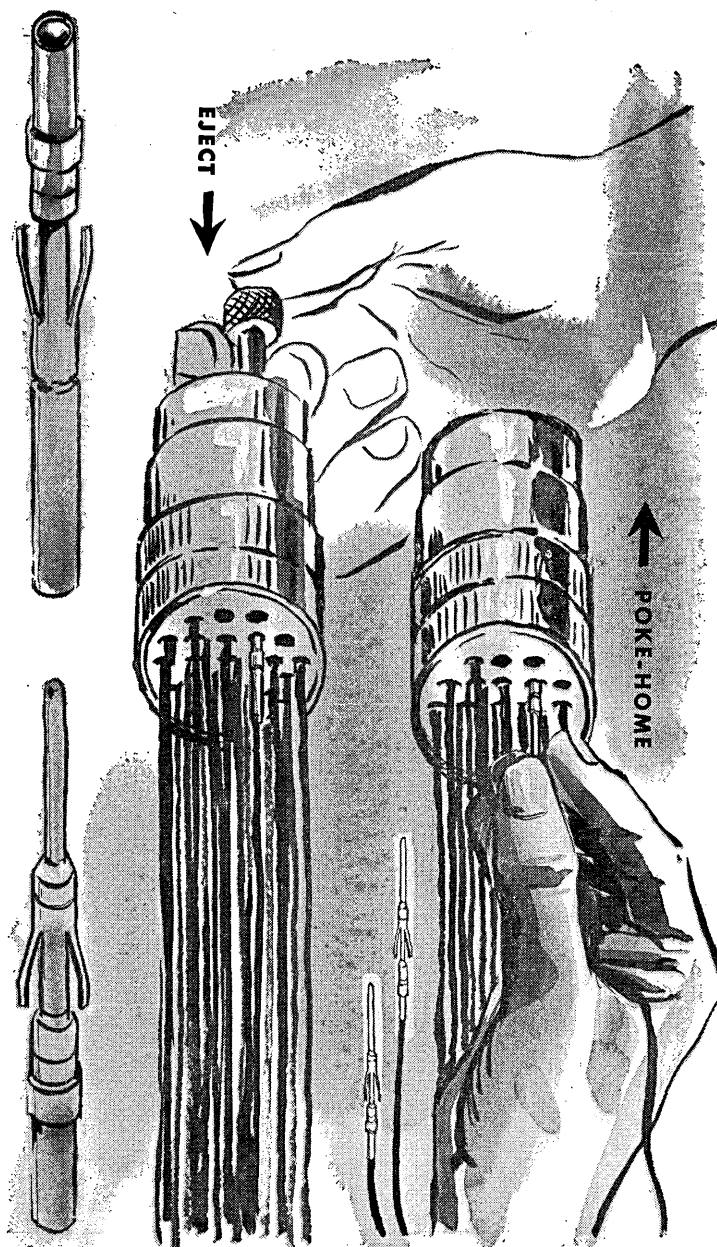

AMPHENOL ELECTRONICS CORPORATION  
*chicago 50, illinois*

Circle 1 on Reader Service Card

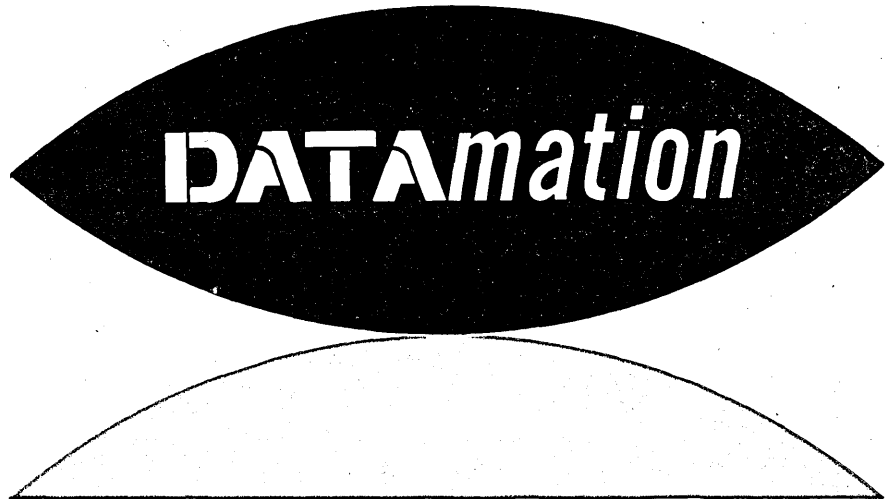
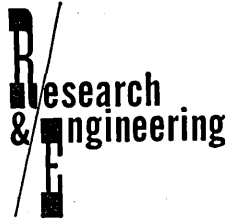

Publisher & President  
Frank D. Thompson

Vice-President  
Gardner F. Landon

Editor  
Charles R. Kluge

Production Manager  
Martha Knowles

Sales Manager  
Earl W. Wilken  
103 Park Ave.  
New York 17, N. Y.  
LExington 2-0541

Representatives

*Eastern*  
Paul S. & Donald C. Weil  
39-01 Main St.  
Flushing 54, N. Y.  
INdependence 3-9098

*Midwest*  
Stuart J. Osten  
333 N. Michigan Ave.  
Chicago 1, Ill.  
DEarborn 2-3507

*Western*  
Earl W. Wilken  
10373 W. Pico Blvd.  
Los Angeles 64, Calif.  
BRadshaw 2-5954

Cover Design  
Burton Browne Advtg.  
Chicago, Ill.

Engravings  
Reliance Reproduction Co.  
New York, N. Y.

Printer  
The Wilson H. Lee Co.  
Orange, Conn.

Over 28,000 Circulation

Vol. 3, No. 7

October 1957

Table of Contents

4th Computer Applications Symposium (Program Hi-Lights) . . . . . 11
Microlock: A Tracking Receiver for Satellite Communications (Cover Story) . . . . . 13
by Dr. Henry L. Richter, Jr.
What is an Analog Computer? . . . . . 17
The Ryan/Navy Automatic Global Navigator . . . . . 18
by Owen S. Olds
Sarnoff Foresees Voice-Controlled Systems . . . . . 23
Electronic Linguist "Speaks" Both A&D Terms . . . . . 24
The Use of Choppers in DC Amplification . . . . . 26
by P. T. McCauley
Eastern Joint Computer Conference (Program Hi-Lights) . . . . . 31
Send Real Voices on Imaginary Journey . . . . . 32
Simulate Air Traffic Flow on Digital Computer . . . . . 33
New Tools Reduce Paperwork . . . . . 34
Complex Instruments Gather Hard-to-Get Data . . . . . 36
New Computer Center Aids Research . . . . . 37
Automatic Control for Industrial Process Plants . . . . . 39

Departments

Book Service . . . . . 38
Current Literature . . . . . 7
Dates to Remember . . . . . 11
Index of Advertisers . . . . . 48
New Products . . . . . 41
News of the Industry . . . . . 3
Progress & Promotion . . . . . 21

RESEARCH & ENGINEERING IS CIRCULATED TO THE MANUFACTURERS AND USERS OF AUTOMATIC INFORMATION-HANDLING EQUIPMENT IN ALL BRANCHES OF BUSINESS, INDUSTRY, GOVERNMENT AND MILITARY INSTALLATIONS. SUBSCRIPTION, U.S.A. & CANADA, \$10.00 ANNUALLY; OTHER COUNTRIES, \$20.00 ANNUALLY; SINGLE ISSUE, \$1.00 WHEN AVAILABLE. PUBLISHED MONTHLY BY THE RELYEA PUBLISHING CORP., FRANK D. THOMPSON, PRESIDENT. EXECUTIVE, EDITORIAL, ADVERTISING, AND CIRCULATION OFFICE: 103 PARK AVE., NEW YORK 17, N.Y., LEXINGTON 2-0541. UNSOLICITED MANUSCRIPTS MUST BE ACCOMPANIED BY RETURN POSTAGE; ALTHOUGH ALL REASONABLE CARE WILL BE TAKEN, THE EDITOR ASSUMES NO RESPONSIBILITY FOR THEIR SAFETY OR RETURN. PUBLISHED AND ACCEPTED AS CONTROLLED CIRCULATION PUBLICATION AT ORANGE, CONN. COPYRIGHT 1957, THE RELYEA PUBLISHING CORP. THE TRADEMARKS R/E AND RESEARCH & ENGINEERING ARE THE PROPERTY OF THE RELYEA PUBLISHING CORP., REGISTERED WITH THE U.S. PATENT OFFICE.

# MODULIZED SERVO SYSTEMS

**QUICKLY INTERCHANGEABLE... EASILY SERVICED**

- Miniaturized
- Lightweight
- Simple, fast installation
- Meets MIL-E-5272
- Can be hermetically sealed with dimensional changes

OSTER TYPE	SB-9805-01	SB-9805-02	SB-9805-03	SB-9805-11
<b>Motor</b>				
Fixed Phase Voltage	26v	115v	115v	26v
Control Phase Voltage	26v	115v	115v	26v
Frequency	400	400	400	400
Max. Power @ Stall	6	5	5	6
No Load Speed	10,500	10,000	10,000	10,500
<b>Generator</b>				
Excitation Voltage Phase 1	26v			26v
Output Phase 2	0.3v/1000 RPM 100,000 ohm load			0.3v/1000 RPM 100,000 ohm load
Null	.012v			.012v
Wobble Voltage	.007v			.007v
(Power Excitation)	3.5 watts Max.			3.5 watts Max.
Linearity	0.5% to 4000 RPM			0.5% to 4000 RPM
<b>Potentiometer</b>				
Mechanical Rotation	360°	360°	360°	360°
Resistance	1000 ohms	50,000 ohms	50,000 ohms	1000 ohms
Accuracy of Total Resistance	±5%	±5%	±5%	±5%
Electrical Angle	350°	350°	350°	350°
<b>Servo Block Unit</b>				
Ambient Temperature	-55°C to 72°C	-55°C to 72°C	-55°C to 72°C	-55°C to 72°C
Altitude	-1000 feet to 55,000 feet	-1000 feet to 55,000 feet	-1000 feet to 55,000 feet	-1000 feet to 55,000 feet
Life	3000 hours excluding pot.	3000 hours excluding pot.	3000 hours excluding pot.	3000 hours excluding pot.
<b>Gear Train</b>				
Ratio	1000 : 1	336 : 1	167 : 1	10,000 : 1
Dust Enclosed per	Section 4.11 MIL-E-5272A	Section 4.11 MIL-E-5272A	Section 4.11 MIL-E-5272A	Section 4.11 MIL-E-5272A
Backlash	Anti-Backlash gear on pot.	1°	1°	Anti-Backlash gear on pot.
<b>Synchro</b>				
Input Voltage—Stator	11.8v			
Output Voltage—Rotor	10.6v			
<b>Clutch Brake</b>				
Input Voltage		100v dc	100v dc	
Input Power		2.0 watts Max.	2.0 watts Max.	
Operate Time—Energize		5 milliseconds	5 milliseconds	
Operate Time—De-energize		20 milliseconds	20 milliseconds	

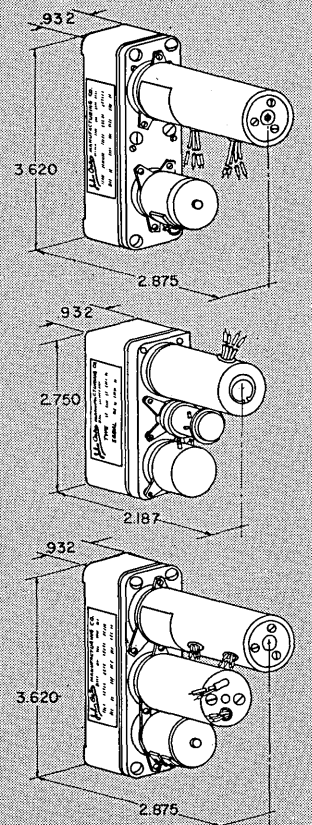

Offered as illustrated with identical or different combinations of:

gear ratios	servo
clutch	synchro
brake	motor-tach
clutch-brake	potentiometer

Write for further information TODAY, enclosing details of your requirement.

Other products include motor-gear-trains, synchros, AC drive motors, DC motors, servo mechanism assemblies, motor tachs, servo torque units, reference and tachometer generators, actuators, motor driven blower and fan assemblies and fast response resolvers.

**MANUFACTURING COMPANY**  
Your Rotating Equipment Specialist  
**Avionic Division**  
Racine, Wisconsin

Engineers For Advanced Projects:

Interesting, varied work on designing transistor circuits and servo mechanisms. Contact Mr. Zelazo, Director of Research, in confidence.

Circle 2 on Reader Service Card

BURTON BROWNE ADVERTISING

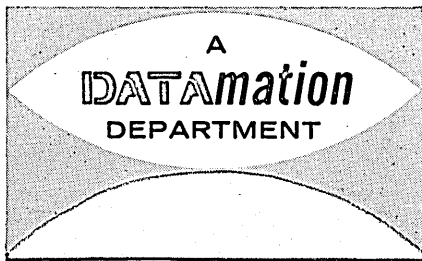

## NEWS OF THE INDUSTRY

### RCA & IBM Sign License Agreement

John L. Burns, President of Radio Corp. of America, and Thomas J. Watson, Jr., President of International Business Machines Corp., have announced that RCA and IBM have signed a non-exclusive agreement exchanging licenses under their respective patents for electronic computers and other data processing machines. Under a non-exclusive agreement, each party retains freedom to license applicants under its own patents.

Under the license arrangement, RCA acquires the right to use IBM patents in its electronic computers and other data processing machines. IBM, in turn, acquires the right to use RCA patents in its computers and electronic data processing machines, thus providing both companies freedom of action in this fast-moving field.

In a joint statement, Burns and Watson said, "As a consequence of this agreement, both RCA and IBM expect to make further progress in the rapidly expanding art of electronic data processing. Business machines, computers, and electronic data processing will in the future broaden industrial and commercial horizons. This arrangement enables the widest possible competition between our companies without the risks of infringing each other's patents."

### Daystrom Forms Avionics Group

Daystrom, Inc. has announced a major reorganization of certain subsidiaries into an Avionics Group for development and manufacture of complete electronic systems for the guidance and control of missiles and aircraft.

Involved in the move are Daystrom Pacific Corp. (Santa Monica, Calif.), which manufactures gyroscopes, potentiometers, and other miniature electronic equipment; Daystrom Transicoil Corp. (Worcester, Pa.), which produces servo-mechanisms; Daystrom Instrument Div. (Archbald, Pa.), which manufactures electronic computer equipment and precision sub-assemblies; the Aircraft Instruments Div. of Weston Electrical Instrument Corp. (Newark, N. J.), which will supply specialized equipment to the new group; and special research and development facilities at Poughkeepsie, N. Y.

President Thomas R. Jones pointed out that this marks "the first step in the integration of operating units which have been acquired or formed by Daystrom, Inc. since 1944. Up to the present, each unit has operated individually, producing equipment and assemblies for avionics and other uses. Through consolidation we will be in a position to coordinate engineering, research and development, and production facilities into a single unit available for the development of complete systems. The units involved in the new group offer all the facili-

ties and experience required for the development and manufacture of entire guidance and control systems."

### Marquardt Installs Special DP Equipment

Extremely high temperatures plague not only the plane designer, but the engine designers as well. Ramjet engines particularly have heat problems, even during their testing.

At the Marquardt Jet Laboratory in Van Nuys, Calif., for example, testing is done at conditions approximating actual flight. To simulate the ram air pressure and ram temperature, it is necessary to add heat to the air. For a typical test in the middle Mach-number range, this might be around 500° F. Marquardt uses two J-33 turbojet engines to power a fire-tube-type heat exchanger which can produce 100-million BTU per hour.

To process the data from the many test instruments, Marquardt has installed special MilliSADIC data processing equipment designed and built by Consolidated Electroynamics of Pasadena, Calif.

### Beckman Sponsors 2nd Computer Course

Los Angeles Computation Center of Beckman Instruments, Inc., is completing the second of a series of free courses on the theory and operation of analog computers.

According to George A. Bekey, manager of the facility operated by the Beckman Berkeley division, representatives of 12 major firms and governmental departments are engaged in learning the techniques of using the computers to solve a large variety of scientific and engineering problems.

Participants are registered from AiResearch Manufacturing Co., American Machine & Foundry, Atomics International, Bendix Aviation, Douglas Aircraft Co., Inc., the Guided Missile Div. of Firestone Tire & Rubber Co., Hughes Aircraft Co., Northrop Aircraft, Inc., North American Aviation, Inc., Rand Corp., Rheem Manufacturing Co., and U.S. Naval Ordnance.

### Study Wind Tunnel Drives with Computer

An analog computer played a role in study of the electric drive and controls of a transonic wind tunnel, two General Electric Co. engineers stated at the Fall General Meeting of the American Institute of Electrical Engineers.

K. G. Black and R. J. Noorda, both of Schnectady, N.Y., told a symposium on computing devices and rotating machinery that the computer was utilized before the electric drive and controls were installed on a large wind tunnel.

"Two factors made it desirable to examine the

**IMPROVED**

# HIGH-PERFORMANCE OSCILLOSCOPE

DC-to-15 MC Vertical Response  
0.05 v/cm Vertical-Deflection Factor  
0.04  $\mu$ sec/cm Calibrated Sweep

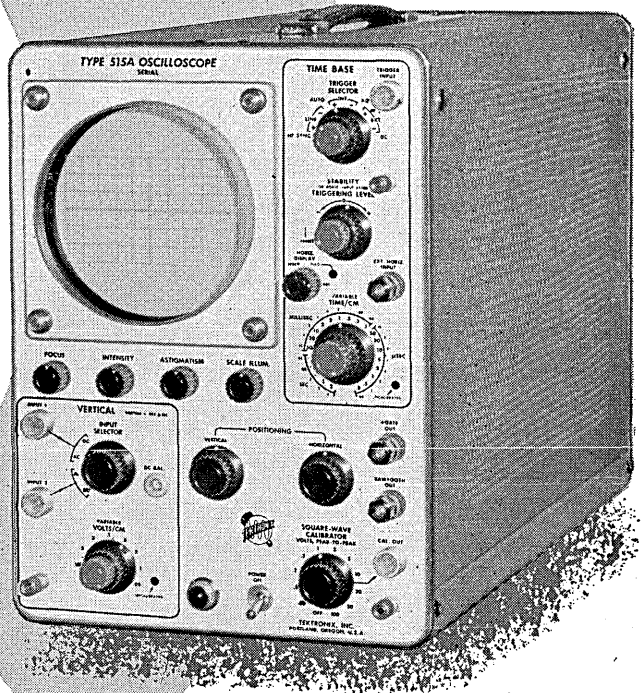
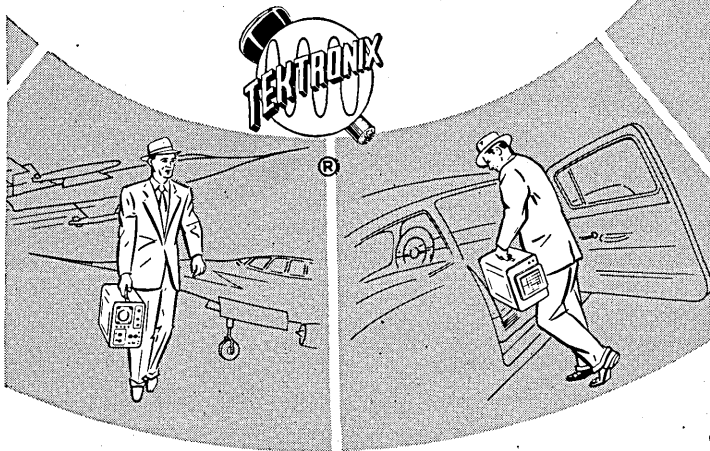

## TYPE 515A SPECIFICATIONS

### VERTICAL RESPONSE

Passband—dc to 15 mc.  
Risettime—0.023  $\mu$ sec.  
Signal Delay—0.25  $\mu$ sec.

### VERTICAL SENSITIVITY

0.05 v/cm to 50 v/cm, continuously variable.  
9 calibrated steps from 0.05 v/cm to 20 v/cm.

### SWEEP RANGE

0.04  $\mu$ sec/cm to 6 sec/cm, continuously variable.  
Single control selects any of 22 calibrated steps from  
0.2  $\mu$ sec/cm to 2 sec/cm.  
5 x magnifier, accurate on all ranges.

### FOUR-WAY TRIGGERING

- 1. Amplitude-Level Selection**—adjustable amplitude-level and stability controls for triggering at a selected level on either the positive or negative slope of external, internal, and line signals, ac or dc-coupled.
- 2. Preset Stability**—same as above, except stability control is preset at the optimum triggering point and requires no readjustment.
- 3. Automatic Triggering**—automatic level-seeking trigger circuit provides dependable triggering for most applications. One simple setting assures positive sweep-triggering by signals of widely differing amplitudes, shapes, and repetition rates. No trigger controls need be touched until a different type of operation is desired. Provides a reference trace on the screen when no trigger signal is present.
- 4. High-Frequency Sync**—assures a steady display of sine-wave signals up to approximately 20 mc.

### OTHER FEATURES

4-KV Accelerating Potential  
DC-Coupled Unblanking  
Square-Wave Amplitude Calibrator  
Electronically-Regulated Power Supplies  
Dimensions—9 $\frac{3}{4}$ " wide, 13 $\frac{1}{2}$ " high, 21 $\frac{1}{2}$ " deep.  
Weight—40 pounds.

TYPE 515A.....\$750

Prices f.o.b. Portland, Oregon

The Tektronix Type 515A is high in performance, quality and value. It offers two important improvements over its very popular predecessor, the Type 515 . . . doubled sensitivity, and preset stability control. Yet it costs no more.

Although a higher-performance instrument, the Type 515A is smaller and weighs less than many other five-inch laboratory oscilloscopes. Therefore it is more easily moved from place to place in the laboratory, and to remote locations for applications requiring precise measurements. Take a look at the specifications and see if you don't think the Type 515A has interesting possibilities in your work.

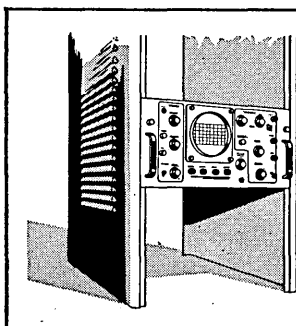

**TYPE RM15**  
Same instrument electrically as the Type 515A, but in rack-mounting form. Dimensions—8 $\frac{3}{4}$ " high, 19" wide, 23" rack depth.

**TYPE RM15**  
\$825

# Tektronix, Inc.

P. O. Box 831 • Portland 7, Oregon  
Phone CYpress 2-2611 • TWX-PD 311 • Cable: TEKTRONIX

Circle 3 on Reader Service Card

**ENGINEERS**—interested in furthering the advancement of the oscilloscope? We have openings for men with creative design ability. Please write Richard Ropiequet, Vice President, Engineering.

The Magazine of DATAmation

system on the computer," they said in a paper entitled *Analog Computer Study of Wind Tunnel Drives*. "One factor is the large power usage of the drive and the length of time involved in acceleration and deceleration at a rate acceptable to the electric utility. These considerations prohibited excessive tune-up adjustments and testing. The other factor is the transient current in the d.c. machine during switching. It was necessary to determine that this current would not exceed breaker settings."

The drive examined by the computer was rated at 110,000 horsepower continuously and 132,000 horsepower for one hour. The drive was powered by three 14 pole wound rotor induction machines coupled in tandem on a single shaft, with two motors rated at 41,500 hp, and one at 27,000 hp, plus the d.c. controls. They said that the drive and controls were installed and operated as indicated by the computer study.

### "Computers as Controllers"

Opening the third session of the recent ISA Instrument-Automation Conference, IBM's Dr. Cuthbert C. Hurd, Director of Automation Research, stated that computers can, in principle, be used to control automatic factories. Describing automatic control already achieved in aircraft and in tracking of earth satellites, Dr. Hurd indicated that the same scientific methods can be applied in the steel industry, petroleum industry, and utilities industry.

Two of the research methods for establishing these descriptions are known as "simulation" and "perturbation." Simulation methods have already been used by IBM research scientists to demonstrate the feasibility of controlling 1,000 aircraft en route between airports with safe operation achieved under computer-issued instructions. Perturbation methods are to be employed in the forthcoming Satellite program, Vanguard. In Project Vanguard, a part of the International Geophysical Year, orbit calculations will be refined and made more precise as experience sent from the satellite is used.

Dr. Hurd went on to point out that it is already evident that computers can, in a sense, be taught to learn, as illustrated by accomplishment in the field of checkers.

### RCA Develops Improved Ferrite Core

An improved low-drive ferrite core for use as an information-storing device in electronic digital computers has been announced by L. J. Battaglia, Manager, Marketing Dept., RCA Components Div. "The new low-drive ferrite core represents a considerable engineering improvement because it is comparable to the high-drive core in ability to withstand large disturbing current impulses without reversing its flux state."

The RCA 222M2 has faster turnover time, higher output signal, and a driving current in the 300-500 milliamperage range. A minute ring-shaped device processed by ceramic techniques, the core possesses magnetic properties. Directed current will cause the core to change its positive or negative state, thus either storing or releasing coded information within millionths of a second.

For example, operating in a coincident-current type matrix, the 222M2 receiving a full driving current of 400 milliamperes will produce an undisturbed "One" output signal of 72 millivolts peak, and a 2.4 micro-seconds turnover time.

In addition to exacting mechanical and electrical core production tolerances, RCA Components Division's customer core orders are tested by the recently-announced Automatic Ferrite Memory Core Tester.

### Reliability Record Made by Bendix G-15

Late in August 1955, the second Bendix G-15 computer off the assembly line was installed in a major oil refinery in Texas. In June 1957, its meter passed the 10,000th hour. By September 1st, the number 11,728 had turned up. This represents almost six man-years of work in two years—the average human puts in 2,000 hours per year.

The oil company takes care of its own machine. Up-time figures throughout this period have been maintained above 95%. Scheduling is on a 24-hour per day basis with unattended operation at night and over week ends. Use of the Bendix MTA-2 magnetic tape unit has been developed to permit this procedure. Several hundred consecutive hours of error-free operation are not uncommon.

Individual problems at this installation frequently take over 100 hours, and may run from 5 to 700 hours. As an example, the program for the integration of partial differential equations is based on 50 points, with 100 or more calculations per point per time step, integrating time and space. Each time step runs approximately 15 minutes, and there are 1,000 time steps per case. The numerical solution of differential equations is used in the study of pressure buildups and reservoir flow.

In establishing overnight operation, a control device was added to turn the computer off permanently if there is power failure, for example, during electrical storms. In addition, a pin-feeder has been added to the typewriter to ensure that the typewriter paper stays in alignment during the long unattended periods.

### 2nd Major Plant Expansion for Audio Devices

Audio Devices, Inc. of New York has leased an additional factory building which will raise its operating space for the manufacture of magnetic tape to a total of 60,000 square feet. The new space addition, the second major plant expansion in a three-month period, was required to allow an immediate increase in production to meet demands for the company's magnetic tape products.

The new building is adjacent to the company's existing plant in Glenbrook, Conn. Installation of production machinery is already under way. The additional capacity will be applied to a cross-section of the company's products, including the new low print-through Master Audiotape for sound recording, magnetic tape for electronic computers, and magnetic film for the motion picture industry.

Looking for dependable  
ultrasonic  
equipment?

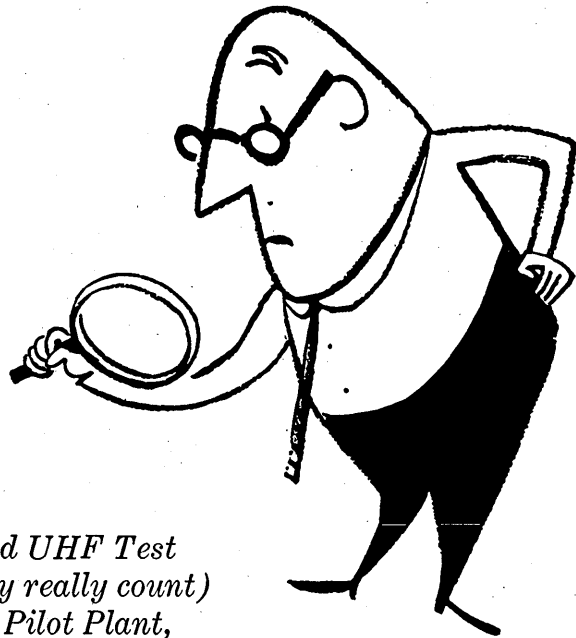

## NARDA'S NOTED FOR IT!

*NARDA, the finest name in Microwave and UHF Test Equipment (where precision and reliability really count) now offers the highest quality Laboratory, Pilot Plant, and Full-Scale Production Equipment for:*

**CLEANING AND DEGREASING  
MACHINING HARD BRITTLE MATERIALS  
FLUXLESS SOLDERING, POTS AND IRONS  
BRAZING AND WELDING  
ELECTROPLATING, GALVANIZING  
ELECTROPOLISHING  
DEBURRING  
QUENCHING  
DEGASSING MOLTEN METALS  
PICKLING AND DESCALING  
IMPROVEMENT OF PRESS OPERATIONS  
CHEMICAL MILLING  
ETCHING  
SMOKE AND FUME PRECIPITATION**

**BOILER FEEDWATER DEGASSING  
BOILER DESCALING  
RADIOACTIVE DECONTAMINATION  
ACCELERATING CHEMICAL REACTIONS  
BEER FOAMING  
IMPREGNATION  
MIXING, EMULSIFYING, HOMOGENIZATION  
TEXTILE WET FINISHING  
POLYMERIZATION  
IMPROVING HEAT TRANSFER  
HULL BARNACLE INHIBITION  
FERMENTATION  
STERILIZATION  
DEGASSING OF FOODS, CHEMICALS**

Cost Saving Ultrasonic Applications for American Industry; — Metal Working, Die-Casting, Foundry, Plating, Metal Treating, Metal Finishing, Optical, Glass, Electrical, Electronic, Nuclear Energy, Automotive, Aircraft, Horological, Jewelry, Medical, Marine, Mining, Utilities, Power Plants, Instrumentation, Automation, Brewing, Bottling, Food, Confectionary, Dairy, Cosmetic, Pharmaceutical, Paper, Chemical, Petroleum, Paint, Plastic and Textile

### NARDA — Complete 4-Point Industrial Service

- Catalog and Off-The-Shelf Equipment • Private Label Manufacture
- Components for OEM Accounts • Research and Development Contract Services



*A Subsidiary of The NARDA Microwave Corporation*

**160 HERRICKS ROAD, MINEOLA, L. I., N. Y., PIONEER 6-4650**

Inquiries invited from Distributors, Manufacturer's Representatives, and Original Equipment Manufacturers interested in acquiring lines of the finest, most attractively priced ultrasonic equipment available in the United States or Abroad. Several Choice territories are open.

Circle 4 on Reader Service Card



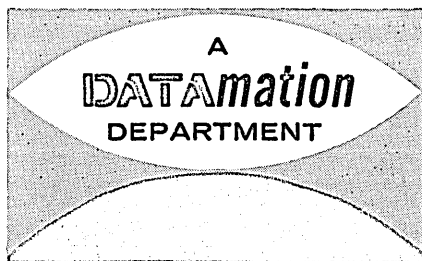

## CURRENT LITERATURE

**Transistorized Modules for Digital Systems** (20 pp.), Catalogue No. M-1, lists and fully describes Computer Control Company's new Series M 3C-PAC transistorized asynchronous digital plug-in printed circuit packages, together with price list. (Computer Control Co., Inc., 92 Broad St., Wellesley 57, Mass.)

*Circle 101 on Reader Service Card*

**Traverse Closure** (8 pp.), Brochure No. 5-04-130, outlines computer solution to problems in civil and architectural engineering in relation to right-of-way acquisition, sub-divisions, and similar land survey jobs. (ElectroData, 460 Sierra Madre Villa, Pasadena, Calif.)

*Circle 102 on Reader Service Card*

**The Beckman/112** (8 pp.) Brochure No. 3010, describes the Beckman/Model 112 data processing system, "a practical data system for the process industry." Detail is given in the brochure outlining the economics of automatic data processing in the present-day well-instrumented plant. The applications of systems of unquestioned reliability to present-day process plant control and provision for future expansion is described. (Beckman Instruments, Inc., Systems Div., 325 Muller Ave., Anaheim, Calif.)

*Circle 103 on Reader Service Card*

**Coleman Powered Comparator** (4 pp.) Technical Bulletin No. CR 191, describes Coleman's powered comparator—a high precision, electro-mechanical data reduction machine that measures and records the distance between points (and also the angular position of images) on photographic film or glass

plate. 16mm, 35mm, 70mm, and 5½" film or plates may be accommodated. Data is automatically recorded in digital form on any one of many types of available automatic readout equipment. (Coleman Engineering Co., Inc., 6040 W. Jefferson Blvd., Los Angeles 16, Calif.)

*Circle 104 on Reader Service Card*

**Teledata Tape Transmitter-Receiver** (10 pp.), Form No. 1539R, describes Friden's Teledata tape transmitter-receiver for use at the ends of a communication channel to transmit coded information contained in punched tape to a receiving location where it is repunched into an identical tape. The bits involved in each code in the tape are transmitted sequentially over a single circuit or channel in the same general manner as coded messages are transmitted by commercial teletypewriting systems. (Friden Calculating Machine Co., Inc., San Leandro, Calif.)

*Circle 105 on Reader Service Card*

Features of the new **Univac II Data Automation System** are described fully in a 79-page manual (No. U-23) published recently by Remington Rand Univac, 315 Fourth Ave., New York City 10.

Designed for the needs of both the computer specialist and the layman, the manual contains five sections: (1) description and illustration of all available equipments and their function, (2) a non-technical guide to the binary number system and the 7-place code of the Univac II system, (3) a technical description of how the Central Computer is organized functionally, (4) an explanation of the system's entire repertoire of in-

structions, and (5) illustrations of how the computer responds to special conditions.

*Circle 106 on Reader Service Card*

**New Tailored Pulses**, a 2-page bulletin on IDL high-speed rotary switches for telemetering, programming, sampling, and scanning, illustrates typical contact arrangement and typical circuit applications. (Instrument Development Laboratories, Inc., 67 Mechanic St., Attleboro, Mass.)

*Circle 107 on Reader Service Card*

**Punched-Card Reader** (6 pp.), Bulletin No. CR-7, describes a new line of static punched-card readers developed for use with industrial processing and control systems. Bulletin describes operating characteristics, connecting components, and top and bottom plate configurations available. Schematic diagrams explain the card reader's operation. Dimensions and prices are included. (Peerless Electric Co., Electronics Div., 1401 W. Market St., Warren, Ohio)

*Circle 108 on Reader Service Card*

**Remote Data Readout Counters**, a 6-page brochure, contains illustrations and descriptions of company's recently-announced series of remote data readout counters, together with price list. (Veeder Root, Inc., Hartford 2, Conn.)

*Circle 109 on Reader Service Card*

**Pipeline Design** (8 pp.), Brochure No. 5-03-110, considers the optimum design of a natural gas pipeline as an example of a Datatron computational process, and describes how the computer completes, in 1.4 seconds, the calculations involving one pipe

segment or compressor station design. (ElectroData, 460 Sierra Madre Villa, Pasadena, Calif.)

Circle 110 on Reader Service Card

**Delay Generator**, a 4-page brochure, illustrates and describes the operation of a new precision delay generator, the Type 6010, designed as a piece of laboratory-type test equipment for applications which require accurate, variable, time interval pulses. In this brochure, the precision delay is divided into its three operating units: the trigger generator, the delay generator, and the regulated power supply; operation of each unit is described. (Burroughs Corp., Electronic Instrument Div., 1209 Vine St., Philadelphia 7, Pa.)

Circle 111 on Reader Service Card

**Multidata Cameras**, a 4-page brochure, describes Model IV-c and Model III Multidata cameras—all-purpose instruments that have made important contributions in the research, design, and

production of weapon systems. They are being used in such diversified applications as airborne systems analysis, missile tracking, radar evaluation, stereoscopic recording, fire control analysis, and automatic systems evaluation. (Flight Research, Inc., P. O. Box, 1-F, Richmond 1, Va.)

Circle 112 on Reader Service Card

**Magnetic Tape for Instrumentation**, an 8-page brochure, covers six types of "Scotch" brand instrumentation tapes for use in telemetering and airborne recording, machine tool control systems, computers, geophysical recording, and other instrumentation applications. Included are charts listing physical and magnetic properties of each of the precision tapes and a comparison chart summary of major factors in selecting a tape for a particular application. (Minnesota Mining & Mfg. Co., 900 Bush St., St. Paul 6, Minn.)

Circle 113 on Reader Service Card

**Cut & Fill** (12 pp.), Brochure No. 5-04-110, details the computing of volumes of a proposed roadbed and explains how data from a field office is fed the computer, arithmetic and logic operations are performed, and final design computations printed for the engineer in only minutes. (ElectroData, 460 Sierra Madre Villa, Pasadena, Calif.)

Circle 114 on Reader Service Card

**099 DataReducer**, a 26-page brochure, describes Telecomputings' Type 099 DataReducer—a general purpose reader that handles almost any type of record: film or paper, opaque or transparent, sprocketed or unsprocketed, continuous or framed, with orthogonal, curvilinear, or polar coordinates. It produces punched cards, paper tape, printed lists, and/or graphic plots (either points or continuous traces). (Telecomputing Data Reduction Systems, 12838 Saticoy St., N. Hollywood, Calif.)

Circle 115 on Reader Service Card

**Automatic Wave Analyzers** (4 pp.), Bulletin 9001, describes Davies' automatic wave analyzers that provide an ideal method for directly reducing analog data. By recording the data on magnetic tape, and running the tape through an analyzer, a complete Fourier series can be automatically plotted and printed in permanent record form. At no point need data be converted from analog to digital expressions or manually faired, measured, or sampled in any way. (Davies Laboratories Div., Minneapolis - Honeywell Regulator Co., 10721 Hanna St., Beltsville, Md.)

Circle 116 on Reader Service Card

**Bridge Design** (8 pp.), Brochure No. 5-04-120, describes the structural design, stress, and dimensional calculations and analyses. As a problem, the brochure considers the analyzing of a determinate bridge truss supported at two points and containing one diagonal in each panel. Assumed vertical loads

# YOKE

SPECIALISTS

**COMPLETE LINE for every Military and Special purpose.**

- Yokes for 7/8", 1-1/8", 1-1/2", 2-1/8" neck diameter CR tubes.
- Rotating and fixed coil designs.
- Core material to suit your requirements.

Special test instruments can establish your yoke deflection parameters to an accuracy of  $\pm 0.1\%$ .

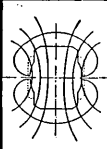

Series aiding field and parallel (bucking) field designs.

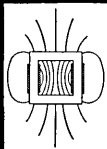



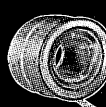

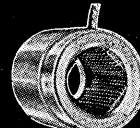

**Consult Dr. Henry Marcy on your new applications today.**

*syntronic*  
**INSTRUMENTS, INC.**

170 Industrial Road • Addison, Ill. • Phone: Terrace 4-6103

Circle 5 on Reader Service Card

are applied at the panel points, and primary stress in each truss member is computed. (Electro-Data, 460 Sierra Madre Villa, Pasadena, Calif.)

*Circle 117 on Reader Service Card*

1957 Interim Catalog (28 pp.), No. 357, describes Non-Linear Systems' digital voltmeters, digital ohmmeters, and AC-DC converters. (Non-Linear Systems, Inc., Del Mar Airport, Del Mar, Calif.)

*Circle 118 on Reader Service Card*

Bendix G-15 (6 pp.), Bulletin No. AB116, describes the G-15 general purpose digital computer and the DA-1 digital differential analyzer accessory. With the addition of a DA-1, the G-15 assumes a dual role: it combines the wide applicability of the general purpose computer with the simple programming for the solution of linear and nonlinear differential equations which is characteristic of the digital differential analyzer. (Bendix Computer Div. of Bendix Aviation Corp., 5630 Arbor Vitae St., Los Angeles 45, Calif.)

*Circle 119 on Reader Service Card*

About Binary Coleman Digitizers (4 pp.), Technical Bulletin No. CR 185, describes Coleman's binary digitizers that translate shaft position into contact settings which represent discrete, unambiguous, binary digits in straight parallel or binary-coded decimal form. Voltage for each bit is either on (1) or off (0). No translation is required. (Coleman Engineering Co., Inc., 6040 W. Jefferson Blvd., Los Angeles 16, Calif.)

*Circle 120 on Reader Service Card*

Detailed Specifications of the GEDA A14 covers the newest member of Goodyear Aircraft's noted line of GEDA precision computing equipment—the A14. In addition to being adaptable for installations ranging from the small to the very large, the A14 basic elements are so designed that special-purpose computers easily can be "tailor

made" for specialized applications. Such installations have been produced for nuclear research, automatic control of electric power generation, etc. (Goodyear Aircraft Corp., Dept. 913, Akron 15, Ohio)

*Circle 121 on Reader Service Card*

LGP-30 — The Royal Precision Electronic Computer, a 12-page brochure, describes the LGP-30—a serial, single address, fixed point, binary, stored program digital computer that fulfills the need for a small-sized, reliable, and low-priced scientific computing device. The LGP-30 has an integrated logical design that utilizes each component for many operations. (Royal McBee Corp., Westchester Ave., Port Chester, N. Y.)

*Circle 122 on Reader Service Card*

An Introduction to Systron Corp. Systems Engineering, a 4-page brochure, describes the company's systems engineering service, facilities, and such standard

building blocks as the Systron digit-set universal counter (Model 1040), digital recorder (Model 1400), megacycle universal counter (Model 1031), and digital preset controllers (Models 1080 & 1081). (Systron Corp., 2055 Concord Blvd., Concord Calif.)

*Circle 123 on Reader Service Card*

Mass Spectrometer Data Reduction (8 pp.), Brochure No. 5-03-120, details the use of Data-tron in rapidly reducing to usable form the great quantities of raw data obtained from mass spectrometer analyses. The inversion of a matrix of coefficients and the computation of a mixture's percent composition are documented. (ElectroData, 460 Sierra Madre Villa, Pasadena, Calif.)

*Circle 124 on Reader Service Card*

The RECOMP II (4 pp.), Publication No. 508-T, describes Autonetics' portable general purpose, all transistor, digital

## PHOTOMULTIPLIER TUBE SHIELDS of FERNETIC CO-NETIC

Non-Retentive, Non-Shock Sensitive,  
Attenuate High & Low Intensity Fields

Will not become magnetized. Permanently nonretentive (negligible residual magnetism). Last indefinitely

Magnetic shielding permanently unaffected by shock or vibration from usage, transporting, drilling, bending or possible cutting modifications. No periodic annealing required.

Double layer (1 Fernetic, 1 Co-Netic) attenuates 300 gauss down to approx. .01 gauss. Triple layer (2 Fernetic, 1 Co-Netic) attenuates 1200 gauss down to approx. .01 gauss. Fields of higher magnitude can be attenuated by additional layers.

A wide variety of standard designs available. Also special designs to your exact requirement to shield photomultiplier tubes . . . or for any other magnetic shielding purpose. Other standard and special size magnetic shields available for many applications. Unfabricated sheets of Netic and Fernetic alloys available in 30" x 120" or smaller sizes. .004" Thin flexible Netic and Co-Netic foil for shielding low level fields also available in many widths and in continuous lengths. Hand forms easily.

Do a better job by using the only permanently effective magnetic shielding—Fernetic and Co-Netic. Extreme flexibility also reduces cost and time of experimental work. Send full details on your shielding problems today.

MAGNETIC SHIELD DIVISION PERFECTION MICA CO.  
1322 No. Elston Avenue, Chicago 22, Illinois

Originators of Permanently Effective Fernetic Co-Netic, Magnetic Shielding  
*Circle 6 on Reader Service Card*

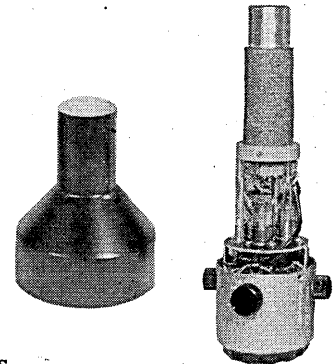

computer that can automatically perform very long sequences of computation, making decisions and referring to memory as it works. It can process and act on a continuous flow of information from its input/out facilities. Complete operational flexibility is provided through built-in, fully automatic, floating decimal point arithmetic. (Autonetics, Div of North American Aviation, Inc., 9150 E. Imperial Hwy., Downey, Calif.)

*Circle 125 on Reader Service Card*

**IRC Catalog Data Bulletin** (4 pp.), Bulletin No. S-2, lists comprehensive data on functions, applications, principal equipment uses, characteristics, specifications, nomenclature, time delay, bandwidth and rise time of IRC's distributed-constant delay lines. (International Resistance Co., 401 N. Broad St., Phila. 8, Pa.)

*Circle 126 on Reader Service Card*

**Friden IDP Products in Action**, a 24-page booklet, is filled with integrated data processing applications involving not only the Friden Flexo-writer automatic writing machine, but many other tape-operated machines. Such functions as order invoice writing, purchase order writing, and accounts payable are all illustrated with easy-to-read, full-page flow charts, and concise descriptions. (Friden Calculating Machine Co., Inc., 1 Leighton Ave., Rochester 2, N. Y.)

*Circle 127 on Reader Service Card*

The function and application of the **Remington Rand Univac Scientific Computer Model 1103A** is described in a new brochure written specifically for the busy executive. The brochure describes the computer in nontechnical terms and cites examples of uses to which this large-scale equipment is being applied. Included in the presentation are the steps taken in converting a problem to mathematical terms and then to a program for solution by the computer. (Remington Rand Div. of Sperry Rand Corp., 315 4th Ave., N.Y.C. 10)

*Circle 128 on Reader Service Card*

## Event Recorder for On-Off Information

**A**n Event Recorder, which instantly and simultaneously records up to 100 channels of on-off information in permanent chart record form, has been announced by Brush Instruments, div. of Clevite Corp., Cleveland, Ohio.

The new instrument will prove particularly valuable in the checking of electrical and electronic sequences in missile and aircraft control systems, range timing readouts (time coding), in the evaluation of telephonic communications systems, in relay "chatter," contact-bounce, close-time, and many other applications where on-off test data is required.

This instrument indicates the events, the duration of events, and their correlation with other events as a function of time. On-off signals as short as one-thousandth of a second can be recorded.

The moving chart is governed by an electrically-controlled transmission, giving the chart 16 fixed speeds in a chart speed range from approximately 10" per second to 10" per day. Speeds are presented in millimeters per second or centimeters per hour. This transport mechanism has an accuracy of  $\frac{1}{4}$  of 1% of line frequency.

Electrical control of the chart motor transmission enables the operator to select chart speeds at the actual test site or by remote control. To obtain best trace resolution, a flick of a switch will automatically give desired chart speed. It is possible for the transmission to switch automatically to the best chart speed for optimum trace resolution.

Brush method of electric writing has a response time of less than 100 micro-seconds to a change in signal.

New Event Recorder holds a 500-foot roll of chart paper, and has an internal take-up mechanism. At slowest possible chart speed, the 500-foot roll represents almost a two-year supply of paper.

The Event Recorder holds a 500-foot roll of chart paper and has an internal take-up mechanism. The moving chart can also be passed out the front of the instrument.

At the slowest possible chart speed, the 500-foot roll represents almost a two-year supply of paper. While the instrument has been designed primarily as an event recorder, related analog data can be recorded simultaneously on the same time axis with the use of Brush magnetic pen-motors with the same high degree of accuracy reached by other Brush recording systems.

For example, as many as four channels of analog information can be recorded by the new Event Recorder, along with 50 channels of event data. Users will be able to alter the ratio of event to analog recording channels to suit their own specific applications.

*Circle 129 on Reader Service Card*

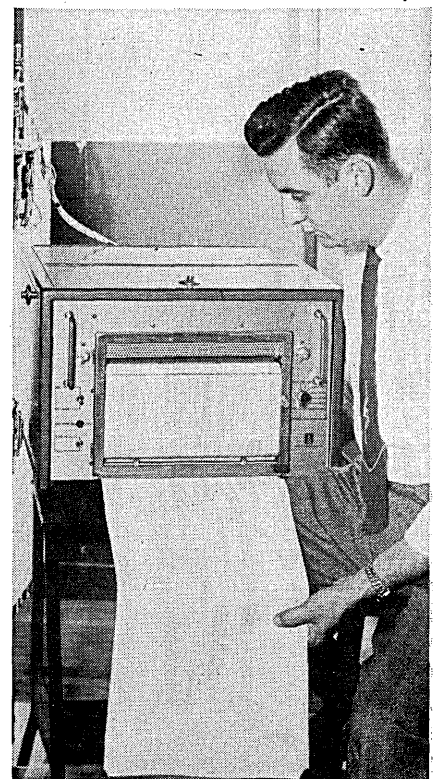

**Program Hi-Lights  
of Armour Research Foundation's...**

# 4th Computer Applications Symposium

Users of digital computers are continually expanding the frontier of applications into new and complex areas of calculation and data processing. The program of the 4th Computer Applications Symposium (sponsored by the Armour Research Foundation of Illinois Institute of Technology) to be held October 24 & 25 at the Morrison Hotel, Chicago, Ill., constitutes a cross section of newer applications and techniques.

Sessions will stress new applications, use of new computers and accessories, and developments in automatic programming. Round table discussions will follow each day's presentations, emphasizing solutions to planning and operating problems common to the organizations represented.

#### Papers to be presented October 24:

*An Extensive Hospital & Surgical Insurance Record-Keeping System* (Datamatic 1000), by R. J. Koch, Michigan Hospital Service,

*A Central Computer Installation as a Part of an Air Line Reservation System* (Univac File-Computer), by R. A. McAvoy, Eastern Air Lines,

*Fitting a Computer to an Inventory Control Problem* (IBM 705), by O. A. Kral, Minnesota Mining & Manufacturing Co.,

*The Problems of Planning New Metropolitan Transportation Facilities & Some Computer Applications*, by J. D. Carroll, Jr., Chicago Area Transportation Study,

*Data Processing Tasks for the 1960 Census* (Univac Scientific), by D. H. Heiser, Bureau of the Census, Dept. of Commerce,

*The Handling of Retail Store Requisitions from a General Warehouse* (Datatron), by M. J. Stoughton, Sears, Roebuck & Co.,

*Automatic Programming for Business Applications*, by G. M. Hopper, Remington Rand Univac Div., Sperry Rand Corp.

#### Papers to be presented October 25:

*Digital Simulation of Active Air Defense Systems* (Univac Scientific), by R. P. Rich, Johns Hopkins University,

*Statistical Calculations in Product Development Research* (LGP-30), by E. B. Gasser, The Toni Co.,

*Progress in Computer Applications to Electrical Machine & System Design* (IBM 704 & 709), by E. L. Harder, Westinghouse Electric Corp.,

*How Lazy Can You Get?* by A. L. Samuel, International Business Machines Corp.,

*The Solution of Certain Problems Occurring in the Study of Fluid Flow* (IBM 650), by L. U. Albers, Lewis Flight Propulsion Laboratory, National Advisory Committee for Aeronautics,

*A Dual Use Digital Computer (General Purpose or DDA) for Dynamic System Analysis* (G-15D), by E. H. Clamons & R. D. Adams, General Mills, Inc.,

*The Status of Automatic Programming for Scientific Problems*, by R. W. Bemer, International Business Machines Corp.

## DATES to remember

### OCTOBER

16-18, **Conference on Feedback Control**, theme: "Computers in Control," sponsored by AIEE, IRE & ASME, Chalfont-Haddon Hall, Atlantic City, N. J.

24 & 25, **Computer Applications Symposium**, sponsored by Armour Research Foundation of Illinois Institute of Technology, Morrison Hotel, Chicago, Ill. (For further information, write ARF, 10 W. 35th St., Chicago 16.)

28 thru Nov. 1, **Course: "Installing an Electronic Data Processing System,"** sponsored by Canning, Sisson & Associates, Barbizon-Plaza Hotel, New York City. (For further information, write CS&A, 1140 S. Robertson Blvd., Los Angeles, Calif.)

### NOVEMBER

4-8, **Institute on Electronics in Management**, theme: "Current Developments in Automatic Data Processing Systems," The American University, 1901 F St., N.W., Washington 6, D.C.

5-7, **Military-Industry Guided Missile Reliability Symposium**, Naval Air Missile Test Center, Pt. Mgu, Calif.

19 & 20, **Symposium on Analog & Digital Computation & Systems Dynamics**, Wright Air Development Center, Wright-Patterson Air Force Base, Ohio.

### DECEMBER

9-13, **Eastern Joint Computer Conference & Exhibit**, theme: "Computers with Deadlines to Meet," sponsored by IRE, ACM & AIEE, Sheraton Park Hotel, Washington, D.C. (For further information, write R. T. Burroughs, IBM Corp., 1220 Nineteenth St., N. W., Washington, D.C.)

Are You in Step with Progress?

# GET YOUR PROFIT WHERE THE MONEY IS

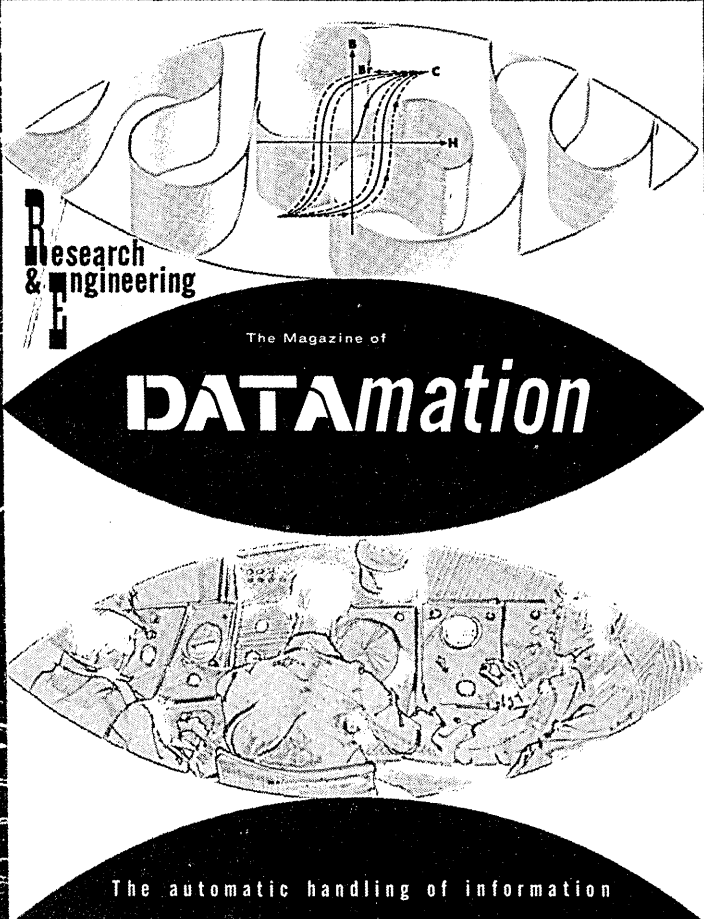

The specific market involved in the automatic handling of information—“Datamation” provides the greatest profit potential to manufacturers of

- / Digital Computers
- / Transistors
- / Analogue Computers
- / Printers
- / Data Processing Systems
- / Tubes
- / Relays
- / Magnetic Tape Units
- / Information Scanning Machines
- / Telemetering Devices
- / Converters Analogue Digital
- / Input-Output Systems
- / Photographic Equipment
- / X-Y Recorders
- / Cores
- / Magnetic Drum Units
- / Plotters
- / Diodes
- / Ferrites
- / New Materials
- / Positioning Mechanisms
- / & OTHER COMPUTER COMPONENTS AND SUB-ASSEMBLIES

## HOW MUCH is “Datamation” ?

\$4,250,000,000.00 of this country's gross electronic expenditure will be spent on equipment for the automatic handling of information. This is “Datamation”.

And Research and Engineering — the Magazine of Datamation is the one publication designed and edited for and circulated to the specific group of engineers and scientists that create, develop and use equipment for the automatic handling of information — military or industrial.

Be the first!

Research and Engineering personnel are anticipating this first sound technical approach to this field.

Make sure your advertising message will be in the history making initial issues with this brand new approach created by

FRANK THOMPSON, Publisher

Wire or Phone Today for Reservations and all details, rates, breakdown of 28,000 circulation guarantee etc. (October, 1957 first “Datamation” issue.)

Research & Engineering  
The magazine of

# DATAmation

103 Park Avenue, N. Y. 17, N. Y. • Lexington 2-0541

the automatic handling of information

Cover Picture: Dr. H. L. Richter, Jr. (right) of Caltech's Jet Propulsion Laboratory shows Dr. W. H. Pickering, Director of Caltech JPL, the latest data collected from pass made by Russian Sputnik.

# MICROLOCK:

## a tracking receiver for satellite communications

by Dr. Henry L. Richter, Jr., W6VZA  
California Institute of Technology, JPL

Due to the widespread interest in amateur radio participation in the IGY and the possibility of amateur satellite tracking, a receiver has been developed by the San Gabriel Valley Radio Club which will be useful for both tracking the satellite (as it passes through the antenna pattern) and for recovering information which may be placed on the carrier of the satellite transmitter. Figure 1 is a block diagram of the system, and the various components in this figure will be described.

As has been described before,<sup>1</sup> the satellite transmitter

<sup>1</sup>Easton, R., "Radio Tracking of the Earth Satellite," *QST*, July 1956, p. 38.

will operate on 108 mc. Several satellite experiments and payloads are contemplated involving different types of scientific measurements. Some of these experiments will place continuously telemetered information on the carrier, some will place information on the carrier only when interrogated by an official Minitrack ground station, the others will have continuous transmission of information, plus transmission of data stored during the previous orbit upon interrogation.

The receiver as designed is capable of tracking the satellite with an accuracy of two or three milliradians of arc. It will also detect either FM or AM modulation of the carrier frequency and, hence, will be useful for recording information telemetered from the satellite, a simple

## San Gabriel Valley, Calif., Radio Club

### *1st amateur radio club to record data from Russian satellite . . .*

As Dr. Henry L. Richter, Jr. of The Caltech Jet Propulsion Laboratory started for home on Friday, October 4th, one of his associates calmly informed him that Russia had successfully launched an earth satellite. As a member of the San Gabriel Valley Radio Club, Dr. Richter alerted other members of W6QFK. At six o'clock, Robert Legg met Dr. Richter at the Los Angeles County Sheriff's Office at Temple City.

Within a half hour, Bob Legg was at home starting to change the equipment from 108 megacycles to 20.005 and 40.002 megacycles. This know-how had been made available by individuals from Caltech. Within a few minutes, another member of the club, Keith Bradshaw, joined Legg and both worked frantically to get the equipment ready to record the first pass.

Since they had no feed-in antenna at Legg's home, the next best thing was done. A wire was connected to the window screen and the two were ready to record at 7:16 Friday evening. The next morning, the equipment was taken to Temple City location and used in conjunction with recording equipment from the JP Lab.

A Sanborn #150 four-channel pen recorder and an Ampex console, Model 307-2, dual channel recorder were tied into the tracking device. Raw data was recorded on Sanborn Recording Permapaper and Minnesota Mining & Mfg. magnetic tape. About 50,000 feet of tape was used from Friday evening to Sunday morning, and recordings made on approximately 1/2 mile of paper.

The chart on the cover shows the 20.005 AGC recording and the 40.002 AGC along with the tone pattern. The signal pulse was 3/10th of a second on, and 3/10th of a second off. Pulses did have a pattern slope. However, no significance could be attached to the signal. Tracking equipment could receive with accuracy a signal under 1/10th of a microvolt.

The story on this amateur club tracking receiver is printed on the following pages. This story, however, is on their Microlock equipment which was set up to receive the previously agreed upon signals from the 108 megacycles plan in conjunction with the IGY program. Other data established was the mean altitude of 605 kilometers with a 6° shift per day of the satellite. Time for complete circle was established at 96.5 minutes, speed of 18,000 miles per hour.

Of great significance is the contribution made by several companies and organizations: Hoffman Television Inc., Caltech Jet Propulsion Lab., U.S. Naval Ordnance Test Station Annex, Consolidated Electrodynamics Corp., Hoffman Laboratories Inc., The Fluor Corp., The Birtcher Corp., and Specific Products, Inc.

The equipment and money donated by the above companies, and the energy and time given by the many club members made possible the mountain of data now available to the IGY. The unexpected launching by Russia of this satellite could have been even more of an accomplishment if we had not been able to collect data.

two dipoles or a helical antenna at each location. Three antennas serve as an interferometer system to get either east-west or north-south position data.

A fourth antenna is used as a reference antenna and could be used for communication purposes. The pattern of the antenna system is broad and the satellite can be tracked from horizon to horizon. The satellite would, hence, be "visible" for some ten minutes on a pass that went directly overhead.

The receiving equipment described in this article is a simplified version of the Microlock satellite tracking and communications system developed and used for instrumentation by the Jet Propulsion Laboratory of the California Institute of Technology, Pasadena, Calif., under contract with the U.S. Army Ordnance Corps.<sup>2</sup> The original receiver has a sensitivity of  $-150$  dbm; this corresponds to a sensitivity of  $.007$  microvolts into  $50$  ohms. This high sensitivity is achieved by use of a narrow bandwidth receiver system tracking the carrier frequency in phase.

The receiver described has a radio frequency tracking bandwidth of  $10$  cycles. A phase-locked system is used so that the  $10$ -cycle bandwidth always includes the carrier frequency. The receiver is able to shift this  $10$ -cycle band automatically to follow such changes in carrier frequency as would be expected from the satellite Doppler shift or the transmitter frequency drift. The tracking rate of the narrow bandwidth of the receiver is limited by the received power.

Under conditions of threshold input signal ( $-150$  dbm), the maximum allowable tracking rate is something on the order of  $25$  cycles per second squared. At higher input signal levels, the tracking rate can be quite rapid. The communications system was intended for use in tracking minimum power transmitters at the extreme range line-of-sight distances attained by modern missiles.

Another measure of the sensitivity is the following: Assuming isotropic (unity gain) antennas, the receiver has a capability of tracking a device radiating  $1$  milliwatt of power at  $108$  megacycles to a line-of-sight distance of over  $3,000$  miles. With typical modulation indices, the corresponding information (or message-sending) bandwidth for the threshold signal is one bit (or cycle) per second.

Figure 1. Block diagram of Microlock system.

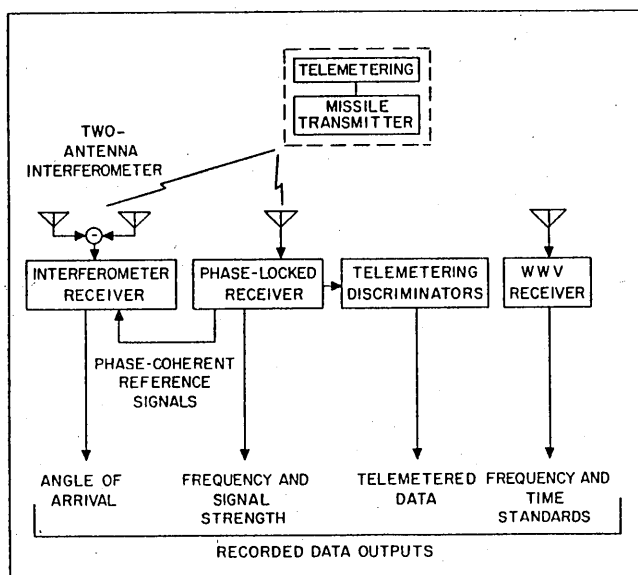

<sup>2</sup>Richter, H. L., Sampson, W. S., Stevens, R., "Microlock: A Minimum Weight Instrumentation System for a Satellite," External Publication 376, Jet Propulsion Lab., California Institute of Technology, Pasadena, Calif., April 16, 1957.

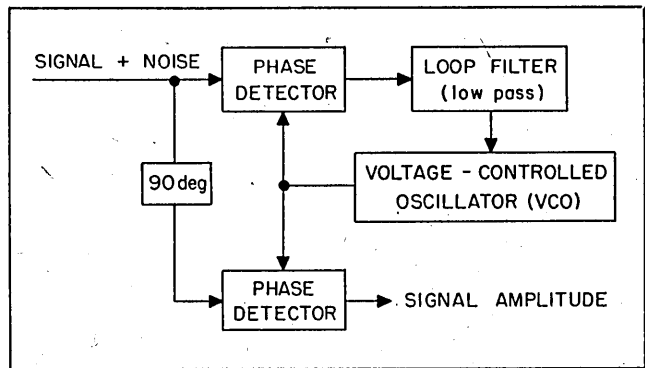

Figure 2. Basic phase-locked loop.

Such a system would be useful for slow CW, but is hardly applicable for phone use.

One way of looking at the one cycle per second information bandwidth is to specify that information may be sent on events occurring no faster than one per second. The actual modulation frequency range is a function of the receiving system itself. Several bandwidths will be mentioned in connection with the receiving system used and the reasons for each explained.

The main part of the receiving system shown in Figure 1 is the phase-locked receiver which will demodulate the information on the carrier as well as supply phase coherent signals to an interferometer receiver. A system of frequency and time standards has been worked out to measure both the carrier frequency of the satellite transmitter and to provide reference timing for the various recorded data. In order to discuss the phase-locked receiver, it is first necessary to introduce the reader to correlation detection, and then the full receiving system will be described.

The basic phase-locked loop is shown in Figure 2. A detailed explanation is contained in the appendix at the end of this article. The operation of this device is similar to that encountered in horizontal oscillators used in television receivers, which "lock on to" and reproduce a frequency indicated by a sync pulse.

### The Microlock Receiver

(1) *Reference Channel:* The full block diagram for the receiver developed by the San Gabriel Valley Radio Club is shown in Figure 3. The phase-locked servo system is composed of blocks 2 through 6. Block 1 is a wideband preamplifier located at the antenna to aid the signal in overcoming cable losses. Block 2 is a mixer stage which is used to heterodyne either the  $108$  mc signal or a  $146$  mc signal to  $19$  mc using the  $127$  mc voltage controlled oscillator (block 6).

A stable communication receiver (block 3) is used as an IF strip. The local oscillator of this receiver must be stable; more will be said about this later. Block 4 is a phase detector similar to that used in Figure 2 which compares the output of the receiver ( $455$  kc) with a  $455$  kc signal generated by a reference crystal controlled oscillator (block 7).

In the same manner as described in the appendix, if the  $455$  kc output from the receiver does not agree exactly in frequency in phase with the reference oscillator, an output is produced by the phase detector proportional to the sine of the phase difference between the two signals. This output is filtered (block 5) and applied to the voltage controlled oscillator (block 6). The filtered phase detector output will then control the  $127$  megacycle local oscillator in such a manner that the doubly-converted input signal is precisely at  $455$  kc.



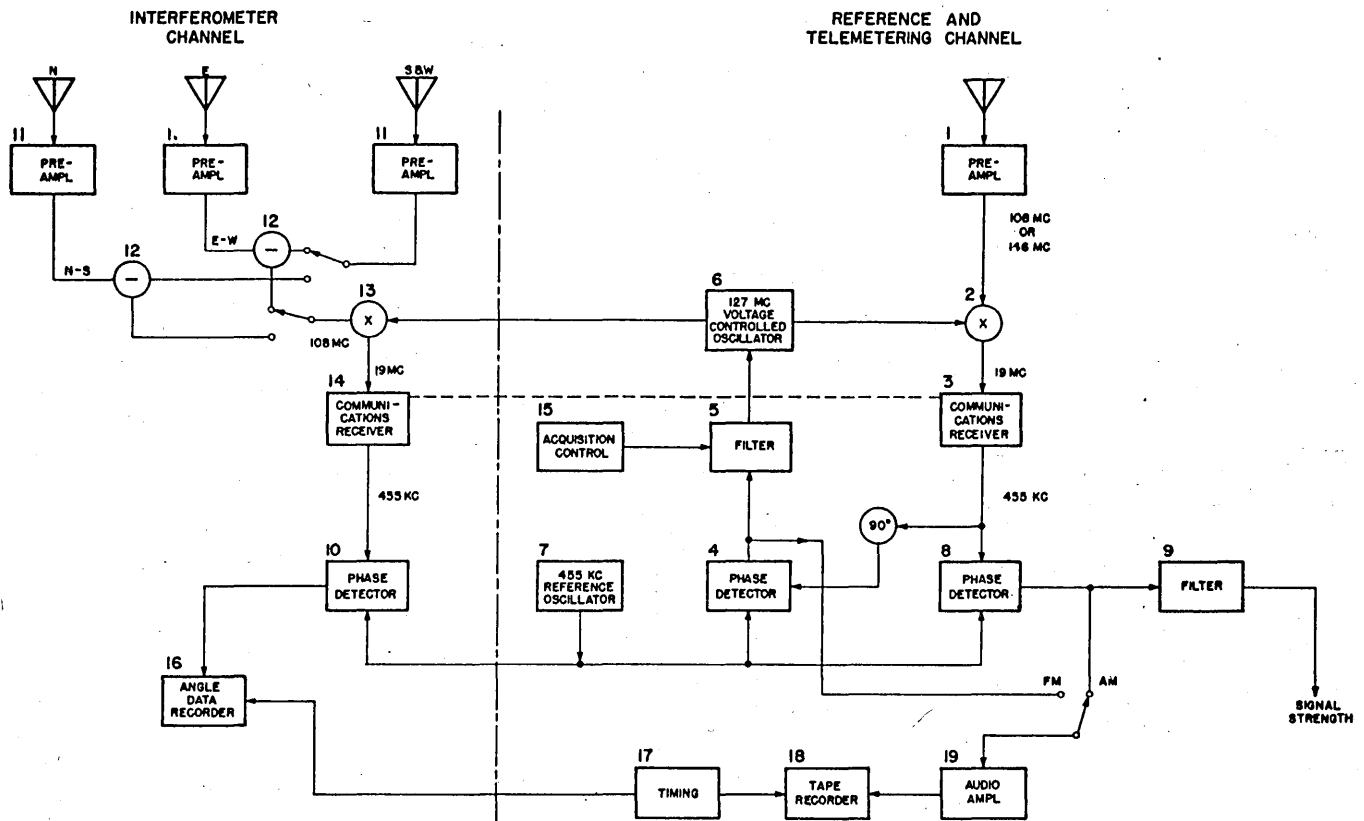

Figure 3. San Gabriel Valley Amateur Radio Microlock Station.

The loop filter (block 5) is in the circuit so that the voltage-controlled oscillator (VCO, block 6) will not follow rapid frequency or phase fluctuations of the signal. In this manner, the voltage-controlled oscillator output is a true replica of the input signal (however, removed 19 mc in frequency). The phase-locked servo system has a tracking bandwidth of 10 cycles. This implies that changes in the carrier frequency which occur more rapidly than 10 cycles per second are not tracked.

Any frequency or phase modulation of the input signal occurring at a rate faster than 10 cycles per second shows up as an error signal from phase detector 4. Since the error is not cancelled by frequency or phase shift of the VCO, it contains the phase or frequency modulation of the signal. This output can then be amplified and placed on a tape recorder for the purpose of recording frequency or phase modulation of the incoming carrier.

Phase detector 8 is included as a detector of signal strength or amplitude modulation. A  $90^\circ$  phase relationship exists between the inputs to phase detector 4 and phase detector 8. This is for the purpose of changing phase detector 8 from sine function to a cosine function (which is not affected by changes in angle near zero degrees). The output of phase detector 8 is, therefore, not sensitive to small differences in phase between the reference oscillator and the converted incoming signal but, instead, is proportional to the amplitude of the weaker of the two.

The output of phase detector 8, thus, contains amplitude modulation information; this output is filtered (block 9) for the purpose of obtaining signal strength information. A system is arranged so that the audio amplifier can select outputs from either the FM or AM channels for the tape recorder.

When the converted incoming signal is not far in fre-

quency from the reference oscillator, the voltage-controlled oscillator, depending on the signal strength, will move in such a manner as to acquire phase lock with the signal. However, if the signal is too far away for this to be accomplished, some other means of "acquiring" the signal is required.

Here, the technique is to use an acquisition control circuit which slowly sweeps the frequency of the VCO by introducing a small current into the capacitor in the loop filter (block 5). The frequency of the VCO is slowly swept through its range until the signal has been acquired. At this time, the phase detector output takes over and controls the VCO.

(2) *Interferometer Section:* The section of the receiver to the left of the dotted line in Figure 3 is the interferometer channel used for making measurements of the angle-of-arrival of the radio waves from the satellite. The principles governing the use of interferometer antennas have been well described previously.<sup>1,3</sup> Several alternates are possible. . .

Three antennas are involved for this channel, two of which are used at any one time. The antennas are arranged in the form of a right triangle so that one antenna serves as a common point and an east-west or north-south base line can be used depending on which of the other two antennas is selected (Figure 4). This is indicated in

Figure 4. Interferometer signal during satellite transit.

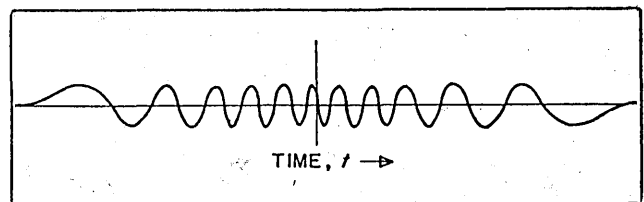

<sup>3</sup>Easton, R., "Mark II Minitrack, Base-Line Components," *QST*, September 1957, p. 37.

Figure 3 with the switch in the east-west direction.

As the satellite passes through the antenna pattern (a 200-ft. base line gives 40 nulls in the antenna pattern), a varying signal is produced which is a combination of the satellite motions over the field of view, and the antenna pattern. As the satellite passes into an antenna null, the signal strength becomes very low. In a manner similar to that just described for the measurement of signal strength of the incoming signal (phase detector 8), another receiver channel and phase detector (blocks 10, 12, 13, and 14) is used to measure the signal strength of the signal from the combined interferometer antenna system.

The pattern produced by the satellite passing through the antenna pattern is somewhat different from that described in Reference 1, in that phase coherence is retained and the pattern produced by a satellite transit through the antenna field is shown by Figure 4. Since phase coherence is retained (hence, polarity of the angle-of-arrival data exists), only 20 ambiguous antenna nulls are obtained.

The output of phase detector 10 is recorded on a pen recording device for the purpose of rapid reduction of angle data. The timing channel is also put on the angle data recorder for the purpose of determining precise meridian plane crossing time.

The interferometer channel of the receiver works similarly to that described for the reference channel. A pre-amplifier (block 11) is included in each antenna location. The antenna cabling system is arranged so that the output can be taken from either of two hybrid networks (block 12). This channel is designed for 108 mc only. The 108 mc signal is introduced into a mixer stage (block 13) which is also fed from the 127 mc VCO (block 6).

The output of this mixer will again be at 19 mc and is sent through a communication receiver (block 14) in the same manner as before (block 3). The signal is taken from the communication receiver at 455 kc and introduced into a phase detector (block 10) which is also referenced by the 455 kc reference oscillator (block 7). Signal strength is detected as described above.

Since each of the communication receivers has a local oscillator, and since phase coherence must be retained between the two channels the local oscillators of the two receivers must be locked together (dotted line between 3 and 14). Any drifts in the local oscillator in communication receiver 3 will be compensated since the servo loop is closed around this receiver. However, the other receiver

Part of the tracking equipment used to record data from Russian satellite.

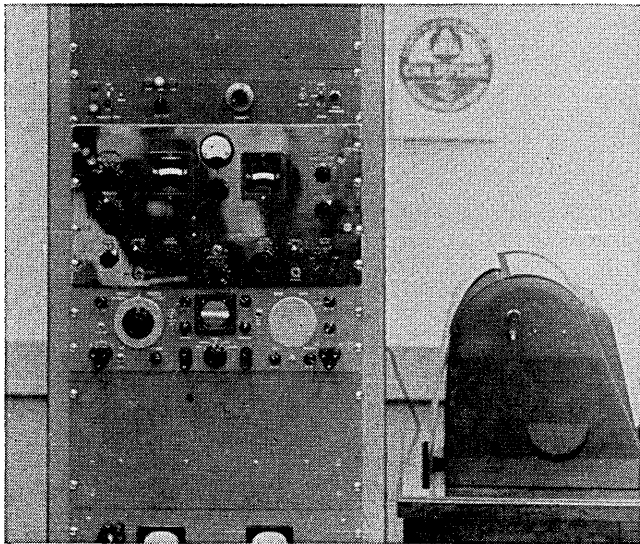

(block 14) cannot introduce any phase or frequency deviations to the incoming signal, or the 455 kc output will not be in phase synchronism with the reference oscillator.

It will be noticed that a 90° phase shift is introduced in the signal input lead to phase detector 4. Phase detectors 8 and 10 operate on the same phase in that they are signal strength indicators, and the quadrature relationship is necessary only as far as the relative phase of the signals entering phase detector 4 and phase detectors 8 and 10.

Not shown is the timing mechanism (this will be described later) and details of the antenna system. Small antennas at the locations of the main antennas are provided to supply signals that are equal in phase and amplitude for the purpose of adjusting the hybrid junctions. The relative phasing of any two antennas of a given interferometer is accomplished by varying cable lengths. The antenna systems are balanced in amplitude by varying the gain of preamplifiers (block 8).

This system is not as applicable to radio star calibration as the Mark II Minitrack system described previously,<sup>1</sup> since the antenna system here is such that it sees from horizon to horizon. Several radio stars are usually simultaneously present in the sky, and discrimination cannot be made between them unless the antenna pattern is considerably narrowed.

It should be emphasized that although the interferometer antenna system mentioned here has a base line of 200 ft. and an accuracy of 2 milliradians of arc, that a much more precise system could be used.<sup>3</sup> The 200-ft. system was used because of available space and because radio astronomers report random shifts of about 1 milliradian in the arrival direction of the signals from radio stars (which was used as a criterion of meaningful accuracy here).

*Summary.* The receiver just described, uses two highly-stable communication receivers complemented by several auxiliary circuits. A system using only one receiver will provide an indication that the satellite is present in the sky, and will receive telemetering using a single antenna of low gain. However, the receiver as described provides both a telemetering receiver and an interferometer receiver for angle-of-arrival measurements of the satellite signal.

A simple antenna system is used with the receiver for the purpose of angle tracking. However, a more precise antenna system could be used for the interferometer channel: an antenna system such as that described in Reference 3 would be suitable if a very wide beam antenna were used as the reference antenna.

Auxiliary equipment is needed which has not been discussed in this article, namely a precision timing source and a calibration oscillator. Details of these pieces of equipment can be obtained directly by writing to the author, although details of some of the circuits will be presented in the next part of this article. It is requested that any amateur radio groups that are interested in building satellite tracking stations of this variety communicate with the author to assure that they be kept up-to-date with the latest circuits and plans.

The sensitivity of the Microlock receiver is greater than that required to detect an 80 milliwatt satellite transmitter 300 miles overhead. However, the sensitivity will be required to track a satellite if either (1) the satellite transmitted power is decreased (as it may be for later satellite experiments to increase operating lifetime), or (2) it is desired to track the satellite in an orbit that is much further than 300 miles from the earth or which does not pass much above the radio horizon.

Experiments are being started to explore the use of this receiver for amateur communications at 146 mc. A system is presently being devised to permit the use of the two sections of the receiver to independently listen on the

Russian satellite frequencies of 20 and 40 mc. Since it has been indicated that the Russian satellites will use a one-watt transmitter, a receiver of high sensitivity will not be required.

**ACKNOWLEDGMENTS.** The valuable assistance of Robert Legg (W6QYY), H. R. Mecke (W6ZGC), and Keith Bradshaw (W6DAO of the San Gabriel Valley Radio Club, Inc.) is gratefully acknowledged. The author would also like to acknowledge the assistance of several co-sponsors which have provided valuable aid to the San Gabriel Valley Radio Club in support of their tracking station: The Birtcher Corp., Caltech Jet Propulsion Lab., Consolidated Electrodynamics Corp., The Fluor Corp., Hoffman Laboratories, Inc., Hoffman Television, Inc., Specific Products, Inc., and the U.S. Naval Ordnance Test Station Annex. The author would also like to thank Roger Easton of the Naval Research Laboratory for his comments and suggestions.

## APPENDIX

**Basic Lock-Loop Circuit.** The basic phase lock-loop circuit is illustrated in Figure 2. There are a number of ways of explaining the operation of this circuit, and there are a number of names applied to it, such as synchronous detector, linear detector, phase locked-loop, tracking filter, and others. The operation of this device makes use of previously-known information about the input signal.

For example, it is known that the signal from the satellite transmitter will be a coherent sine wave. The sideband power will be reasonably low. The rates at which the carrier frequency will shift are known and the approximate frequency of the carrier is known. The phase sensitive detector in Figure 2 is a device for comparing two signals.

The output of the phase sensitive detector is proportional to the sine of the phase difference between the two signals applied. In this case the two signals are, first, the input consisting of signal plus noise and, second, a local estimate of

the signal generated by a stable sine wave oscillator. The output of the phase sensitive detector is filtered, and the loop closed to the local oscillator (which, in this case, is a voltage-controlled device).

If the two input signals are approximately (but not exactly) equal in phase, an output will be produced from the phase sensitive detector which will correct the local oscillator frequency and phase. By means of the closed servo loop just described, a tracking device is produced whereby the local oscillator is made to follow the applied signal not only in frequency but also closely in phase.

The closed servo loop is a null-seeking system which operates in such a manner that the sine wave produced by the VCO is 90° removed from the input signal. This results in the phase detector output being proportional to the sine of the phase difference between the input signal and the VCO.

The output of the phase sensitive detector contains the product of the input and the locally-generated sine wave, and can be represented  $(S + N) S^* = SS^* + S^*N$  (where  $S^*$  is the locally-generated signal,  $S$  the input signal, and  $N$  the input noise). The output from a conventional square law or product detector (which multiplies the signal by itself using a non-linear device), is mathematically  $(S + N)^2 = S^2 + 2SN + N^2$ .

The advantage of the linear detector can now be seen when these two equations are compared. If  $S$  and  $S^*$  are much larger than  $N$ , the two equations reduce to  $S^2$ . However, when  $N$  becomes comparable with or greater than  $S$ , then the advantage of the linear detector becomes clear (the  $N^2$  term in the latter equation becomes predominant).

The lower phase detector in Figure 2 has an input signal shift of 90° from that entering the top phase detector. As was just mentioned, the upper phase detector is in quadrature (90° removed) from the voltage-controlled oscillator. The 90° phase shift introduced in the signal going to the lower phased detector is in such a direction as to bring the incoming signal into a zero phase relationship with the VCO. The output of the phase detector, being proportional to the cosine of the phase difference between the two applied signals, now becomes proportional to the amplitude of the weaker signal.

# What is an analog computer?

The analog computer functions as a model of a system under design . . . an electronic model which can be modified or subjected to varying operating conditions with the turn of a dial.

Aircraft design is a major field of application for the instrument. Here, the analog computer becomes a model of a proposed aircraft which can be put through a variety of aerodynamic paces before plans ever leave the drawing board.

Electronic flight testing is accomplished in the engineering laboratory by technical test pilots whose controls are knobs, dials, and patchboards of complex wiring. Flight conditions can be changed or aircraft design altered at will.

A recent application points up the vital role of the analog computer in aviation today. Several models of a military aircraft had crashed on take-off. The cause was unknown. The Air Force grounded the plane until the trouble was determined and corrected.

The problem was taken to the analog computer. The instrument was transformed into a model of the aircraft and put through a variety of take-off exercises. Through electronic trial and error, the aerodynamic flaw was discovered and the computer then was employed to work out the design changes necessary to prevent future accidents.

The analog computer has been used to design virtually every airplane automatic pilot system since World War II. Converting the instrument into a model auto pilot, designers introduce a variety of in-flight problems. As a result, modern auto pilots now are proved in flight tests before they ever take control of an aircraft.

In operation, the analog computer employs electrical voltages to represent the mathematical equations which describe the features or characteristics of an aircraft. Other voltages represent equations which describe speed, altitude, force and other flight conditions. Voltage variations are made by turning a dial or changing the arrangement of plug-in wires. Hence, the design of an aircraft, or the conditions under which it is operating, can be changed by adjusting the proper dials and wires.

The versatile analog computer is widely used in the design of modern aircraft, but its application is not limited to that field. The instrument also is applied to the development of rockets, guided missiles, submarines, jet engines, and atomic reactors. In industry, the analog computer aids in the design of more efficient production plants and processes. With advance in automation, the analog computer will play an increasingly important role in precise automatic control. *Donner Scientific Co., Concord, Calif.*

It's light, accurate, complete  
fast, simple, compact...

# the ryan/navy Automatic Global Navigator

by Owen S. Olds, Chief Electronics Engineer  
Ryan Aeronautical Co.

First details of a system of "electronics intelligence" which fully meets the navigational requirements of high-speed, jet-powered flight have been released by the U. S. Navy and the Ryan Aeronautical Co. of San Diego, Calif.

Designated AN/APN-67, the system consists of a radar system and a computation system. The "front end" of the equipment is a continuous wave (C-W) radar set which transmits only two narrow beams of microwave energy to the ground and receives back-scattered microwave echoes. The radar system employs a low-powered transmitter, combined with zero-beat superheterodyne detection techniques.

Since, instantaneously, an aircraft has a component of velocity along the line-of-sight from the receiver-transmitter to the ground, the frequency of the echo energy is shifted from that of the transmitter by the Doppler frequency. Because the Ryan APN-67 employs continuous wave techniques, the transmitted energy is concentrated at a single frequency, rather than being spread over a broad spectrum of frequencies, such as results from pulsed transmission. Also, the serious "altitude hole" problems encountered in pulse-Doppler radar do not affect a C-W system.

Continuous wave techniques,

Lt. Comdr. Edward Doolin (USN) adjusts panel of Ryan AN/APN-67 automatic navigator in Navy's twin-jet A3D Douglas Skywarrior assigned to Project AROWA.

combined with narrow beam widths, result in a single, extremely-narrow echo spectrum from each beam, displaced from the transmitted frequency by the Doppler shift. The Doppler signals are determined directly by a zero-beat superheterodyne detection system.

The detected Doppler shifts are

measured and used in a data stabilizing computer, together with information normally available within the aircraft, to provide precise measurements of aircraft ground speed components. These components are then integrated by a navigational computer to provide present position and other outputs of the system. Special



features of the APN-67 computer are automatic corrections for both compass deviations and magnetic variation.

The receiver-transmitter (R-T) includes in a single integral package the system's only microwave generator, waveguide, a reflector, a radome, and the two microwave crystal detectors. The microwave generator is a special Varián klystron which provides frequency stability and ruggedness in a compact envelope incorporating an integral cooling jacket.

Its output is divided between two antenna feeds within the R-T, and a small portion is fed to the two crystal detectors. The reflector forms the two radiation beams and receives the echoes returned from the earth. The two signals which lie in the audio range have finite band widths because the incidence angles are not the same for all parts of the antenna main lobes. The major function of the dual-channel Signal Data Converter is to measure the center frequency of each Doppler spectrum corresponding to the center of each antenna beam, and to provide outputs suitable for the analog computation system.

Each signal data converter is effectively an amplifier plus a very narrow-band filter and an analog output device. This filter searches the band for possible signals, then tunes to the tracks the power-center frequency of the received Doppler spectrum. Although equating power-center to beam-center frequencies involves certain small errors which depend upon the antenna beam

Signal Data Converter of the Ryan AN/APN-67 Automatic Navigator.

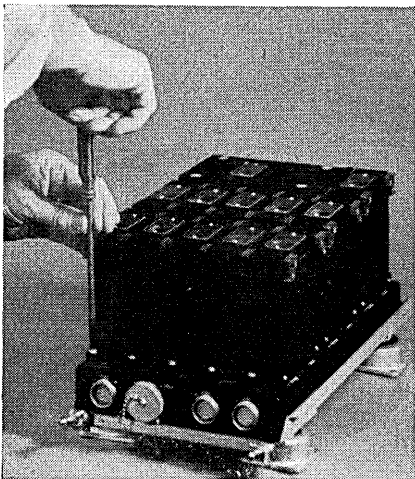

Carl H. Gottwald (left), Ass't Chief of Electronic Projects at Ryan, and compact Receiver-Transmitter for the Ryan AN/APN-67 Automatic Navigator.

width and the type of terrain below the aircraft, the computation system provides compensation for these effects. The system is calibrated for over-land operation, and a manually-operated switch changes calibration for over-sea operation.

The signal data converter incorporates circuitry which automatically transfers the computation system to memory operation in the absence of sufficient echo signal strength. The output of the radar system consists of synchro signals, corresponding to the port and starboard Doppler frequencies.

Contrary to common belief, it is not necessary to use two separate antennas to discriminate received energy from transmitted energy. One of the unique design features of the Ryan APN-67 is its ability to transmit and receive two continuous wave radar beams using only a single receiver-transmitter. Another design feature is that the receiver-transmitter is a *sealed* black box, with *no* moving parts and *no* adjustments. Also, unlike other systems, the radome is furnished as an integral part of the Ryan equipment.

The computation system removes from the Doppler signals those components not produced by aircraft horizontal ground velocity, computes the navigational parameters and presents them in either visual or elec-

trical form, or both. It discriminates the signal elements produced by irrelevant aircraft motion, such as pitch, roll, climb, and descent, and determines ground speed, ground miles, and drift angle directly. With the addition of heading data, the system goes on to compute the earth referenced parameters (latitude, longitude, ground track, course deviation, true heading, North-South and East-West miles).

For versatility, the system has been designed as a few basic units plus a number of accessory components which may be added in varying combinations to meet the exact requirements of specific applications.

Amplifiers, gear trains, differentials, function cams, multipliers, transmitters, and motors typical of electromechanical analog computers comprise the building blocks of the computation system. The electrical outputs are synchro shaft positions which are proportional to either changes in, or the absolute value of, the various navigational parameters. The visual outputs are displayed by pointers or counters, whichever is appropriate.

The principal functional units

of the Ryan APN-67 automatic navigator are: receiver-transmitter (R-T), signal data converter (SDC), ground miles and drift angle computer (GMDA), and navigational computer. A power supply, cooler, amplifiers, junction box, and remote indicators are also included.

The complete system is operated by controls on the Control Indicator panel. The "Power Off" switch turns the system on; position fixes and desired track are set in by means of the selector and slew control. The indicators are activated or stopped during a fix set-in by means of the "Ind-Reset" switch. The "Land-Sea" switch alters the system calibration to compensate for the difference in back-scattering between land and average sea.

For the human navigator, continuous information on the aircraft's position, in longitude and latitude, desired and actual ground track, ground miles traveled, drift angle, ground speed and course error are displayed on dials and counters. For the pilot, a single course error indicator is the only instrument he needs to take him to any destination in the world. By keeping the needle of this instrument at "zero," he flies his desired ground track without regard for wind or drift.

The Ryan APN-67 and related equipment has far-reaching importance for both military and commercial aircraft of all types. It is now being used in aerial magnetic survey work, with the Navy's "Project Magnet," to more accurately determine the intensity and direction of the earth's magnetic field. And, a special version of the equipment is being used with helicopters in ASW work as the means for providing all weather capability to these rotary-winged aircraft.

A commercial version of the Ryan automatic navigator has been conceived especially to meet airline needs. It provides an accurate solution to the long-range navigational problem in a lightweight, compact package. It provides basic outputs of ground speed and drift angle for use in a navigational computer and in one or more ground speed and drift angle indicators.

Knowledge of present position, whether in latitude or longitude, grid miles or range and bearing coordinates, is a basic requirement of all missions. One obvious military ben-

efit is the ability to report accurately the location of a contact in the patrol ASW and AEW missions. This permits the weapon delivery-type aircraft or ships to accurately locate the contact site without the need for detecting aircraft to remain in the area. The ability of minelayers, bombers, and fighter-bombers to precisely locate a target is greatly enhanced, as is the value of reconnaissance and magnetic survey information, when it can be pin-pointed in terms of latitude and longitude.

Knowledge of ground speed and drift angle also permits advantage to be taken of prevailing winds, resulting in increased speed and range. To the military, this means increased mission capabilities. To the airlines, it means greater economies based on savings in fuel and time enroute, more accurate ETA's, and reduced stack time at airports. In addition, continuous, accurate knowledge of position and track can mean the difference between a routine flight and a disaster.

Airlines, preparing to install jetliners in their systems, are keenly

*Circle 130 on Reader Service Card*

interested in the commercial versions of the Ryan automatic navigator because of their need for a fast, automatic, light-weight system to guide their flights over long distances. Jet flight requires a navigational system, which will unerringly maintain a fast-flying plane "on course" all the way to its destination, because of the greater speeds and higher fuel consumptions involved.

Another welcome benefit, which the Ryan navigator system brings to pilots and navigators, is freedom from continuous computations. With all computing automatically performed, the pilot and navigator are relieved of this time-consuming and diverting occupation just when they need the freedom most—while flying a higher-speed aircraft which permits less time for complex deductions.

The Ryan APN-67 automatic navigator is the result of a team effort involving the Navy's Bureau of Aeronautics, the Ryan Aeronautical Co., and several subcontractors—principally Varian Associates, and the Kollsman Instrument Corp.

## new data transmission system

In a paper presented at the recent '57 Fall General Meeting of the American Institute of Electrical Engineers, R. R. Mosier and R. G. Clabaugh (Collins Radio Corp., Burbank, Calif.) described a new system for the transmission of computer information—"a significant advancement in the communications art."

The system, called Kineplex, according to the authors, because it employs kinematic filters in its detection process and is most frequently employed in multiplex configurations, transmits computer information by wire or radio. "Efficient band-width utilization and reliability," said Mosier and Clabaugh, "have been major design objectives of the high-capacity Kineplex system."

They described the system as a high-capacity phase-shift data transmission system which will operate in a single telephone voice band of

standard quality or equivalent. The system will accept at its input, with suitable conversion, binary data from any source.

Specifically, the system is designed to accept either 40 channels of 60, 75, or 100-word-per-minute asynchronous telegraph data or, with accessory converting equipment, standard business machine cards at a rate of 200 cards-per-minute, or binary data from high-speed magnetic tapes not to exceed 3000 bits-per-second depending on application.

The system has been designed with the technical limitations of the wire and radio media expressly paramount. Radio-frequency multipath effects, unequal delays across the passbands of channelizing filters, noisy telephone or radio circuits, and bandwidth limitations are factors around which the system was designed.

## PROGRESS & PROMOTION

**James G. Miles**, who has held executive sales and engineering positions with Twin City computer manufacturers, has joined the staff of **Control Data Corp.** He will be director of engineering services for the new Minneapolis data processing firm.

In his new position, Miles will be responsible for research and development contracts with the U.S. Government and its prime contractors. Control Data expects to obtain contracts in the field of electronic data processing and military systems including guided missile control, air traffic control, and air defense.

He will also have responsibility for consulting services the company will offer including problem analysis and programming of business applications and scientific data processing.

—p&p—

An **RCA** business office for Bizmac electronic data processing systems and equipment has been established in Washington, D.C., to serve District of Columbia and field offices of Government agencies.

**Robert Bruce**, widely known in Government circles as a spe-

cialist in electronic data handling systems, has been appointed Manager, Bizmac Washington District, with headquarters at 1625 K Street.

The appointment of **William B. Rodenhi** to the staff of the RCA Bizmac office in Washington has also been announced. A systems analyst specialist, Rodenhi will provide the technical assistance to Government and military agencies on planned applications of electronic data processing equipment.

—p&p—

Members of the Instrument Society of America, meeting for the recent ISA Instrument Conference & Exhibit, elected **Robert J. Jeffries (Daystrom, Inc.)** as President of the Society for 1957-58.

Well known author, educator, and innovator in the field of instrumentation and automatic control, Jeffries has been a guiding figure in the founding and growth of ISA and has served on many committees on both national and local levels.

Jeffries is Assistant to the President of Daystrom, Inc., Murray Hill, N.J. and founder and director of Educational &

Technical Consultants, Inc. He is, in addition, an active member of AIEE, ASME, and IRE.

—p&p—

Purchase of a 13½ acre site fronting on Galindo Street, and plans for late spring construction of a new plant to house **Systron Corp.** (Concord, Calif.), an electronics firm, have been announced by **George H. Bruns, Jr.**, president.

Heading the organization with Bruns will be **Norman Perlmutter**, vice-president and chief engineer; **James R. Cunningham**, marketing manager; and **Mel Torpacka**, production and plant manager.

The electronics firm concentrates its efforts in two main areas: design and manufacture of automatic control systems and data processing systems for industrial applications, and manufacture of electronic instruments for aircraft and industrial firms.

—p&p—

The appointment of **Roe Nardone** as a Director of the company and the Director of En-



**Robert J. Jeffries**  
 Daystrom, Inc.



**Roe Nardone**  
 Haydu Electronics Products, Inc.

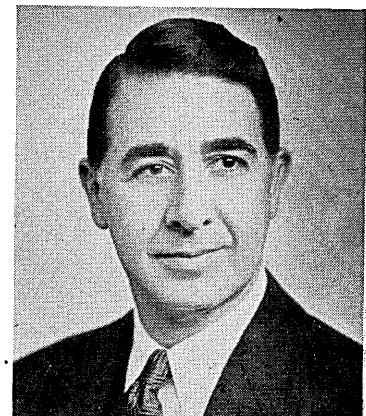

**Richard A. Wilson**  
 Daystrom, Inc.

gineering has been announced by George K. Haydu, president, **Haydu Electronic Products, Inc.**, Plainfield, N.J.

Nardone is widely recognized in the industry as a leading designer of electro-mechanical actuators, landing gears, etc., for aircraft. Having more than 120 patents to his credit, he also co-authored "Kent's Manual"—a basic engineering reference found in most engineering departments across the country.

Haydu Electronic Products is divided into three divisions: the Precision Products & Aircraft Accessories div. (engaged in precision manufacturing of intricate machine components for computers, guided missiles, rockets as well as actuators, electronic tubes, and electro-mechanical assemblies and systems), the Industrial Gas Burner div., and the Instrument Div.

—p&p—

**Daystrom, Inc.** has announced that **Richard A. Wilson**, one of the radio and electronic industry's leading executives, is joining the parent organization as a vice-president.

Wilson is known throughout the Armed Services for his work on military contracts and the building of a successful sales, engineering, and manufacturing team for precision, complicated electronic systems.

In addition to his corporate responsibilities as vice-president, Wilson will head up the newly formed Avionics Group and will also be responsible for Daystrom's activities in weapons systems, underwater equipment, and certain other military and industrial work of the company's operating units.

—p&p—

**Consolidated Electrodynamics Corp.**, Pasadena, Calif., has received a \$400,000 order from **Interstate Electronics Corp.**, Anaheim, for electronic instrumentation. The equipment will become part of a comprehensive test-range instrumentation system which Interstate will fur-

nish for an important Navy missile program.

Magnetic-tape recorder/reproducers and recording oscillographs supplied by Consolidated will record environmental measurements associated with missile launchings and telemetered data from missiles in flight for play-back and evaluation by test engineers.

—p&p—

**John C. McGregor**, president of **The Narda Microwave Corp.**, Mineola, L.I., N.Y., has announced the company's entry into the new, fast-growing ultrasonics industry. A subsidiary, **The Narda Ultrasonics Corp.**, has been formed as a separate operating group to provide attractively-priced ultrasonic cleaning machines and metalworking equipment.

Associated with Narda Microwave in this venture is **Paul Martin Platzman** (formerly a director and vice-president of **Acoustica Associates, Inc.**) who will function as vice-president and sales manager of the subsidiary. A member of ultrasonic specialists prominent in generator and transducer design and ultrasonics application have also been engaged by the company for key management and engineering positions.

—p&p—

Appointment of **George A. Baird** to the new post of associate director of engineering, responsible for engineering coordination of all commercial products manufactured by **Burroughs Corp.**, has been announced by **T. M. Butler**, director of engineering.

An engineering graduate of Villanova University with a master's degree in electrical engineering from the University of Pennsylvania, Baird joined Burroughs in 1949 at its Paoli, Pa., Research Center as a research associate. He became a project engineer in 1952, and was appointed manager of the Center's electromechanisms department in 1955, the post he held prior to his latest appointment.

A specialist in analysis instrumentation and computers has been named assistant research director at the **Institute of Gas Technology of Illinois Institute of Technology**, Chicago. The promotion of **Duane V. Kniebes** from head of the analytical division to assistant research director was announced by **Dr. Martin A. Elliott**, IGT director.

Kniebes will be responsible for research activities in the Institute's analytical division and the computer laboratory. The Institute of Gas Technology is the gas industry's educational and research facility.

Kniebes joined IGT in 1949 as an assistant chemist, and was promoted to head of the analytical division in 1954. A 1948 graduate of Michigan State University, he received his B.S. degree in chemistry. In 1954, he was awarded an M.S. degree in physics from IIT.

—p&p—

Realignment of sales activities to keep pace with expansion of its Systems Engineering group, has been announced by the **Industrial Div. of Minneapolis-Honeywell Regulator Co.** Two new sales divisions, eastern and western, have been set up, with **J. T. Teed** in charge of the former in Philadelphia, and **T. W. Tracy** heading up the latter in Los Angeles.

The move was dictated, **J. A. Robinson**, field sales manager, said, by the increasing growth of systems engineering in the fields of nuclear energy, electric power, and data handling.

Teed joined Honeywell as an industrial salesman in Tulsa in 1951 following graduation from Texas A. & M. He had been manager of the Tulsa branch office since 1954.

Tracy, a graduate of California Institute of Technology, was a west coast member of Honeywell's rocket and missile team prior to his present assignment. He joined Honeywell in 1949 as an industrial salesman in San Francisco, and later was area supervisor for the Transistor Div. in Los Angeles.



the basic reason for its development, is to simulate missile system flight characteristics. "One missile saved by a computer's detection of a hidden source of trouble would more than pay for the facilities and might shorten noticeably the total development time of the missile system." Schwidetzky explained.

Many characteristics of missile flight are inherently analog. Such variables as rotation, velocity, weight, and inertia are analog quantities. The high degree of accuracy essential in computation of these variables can be achieved only through the use of digital equipment. Thus a combination of the two techniques is desirable. The Addaverter makes this possible by converting or translating the analog quantities to digital terms.

Although the computer-converter will be used in the study of ICBM performance, a clear example of how it works can be found in the launching of an anti-aircraft missile. An anti aircraft missile must be guided with extreme accuracy in order to intercept the target plane at the proper instant. To accomplish this,

two tracking radars on the ground send data on the position of the missiles and the target to a ground-based digital computer. The computer samples the data at regular intervals and calculates the proper trajectory for interception. This trajectory is compared with the actual missile course and corrective signals are radioed to an autopilot in the missile. The autopilot transfers the correction to the missile's control surfaces.

Simulation of this action only on an analog computer does not produce sufficient accuracy. Yet analog simulation has a distinct advantage in that actual missile system components, such as the autopilot, can be used in the simulation. This allows a detailed study of the operating characteristics of these components.

A combined analog-digital computation of the missile flight would be simulated as follows: Missile action is calculated continually on the analog computer until interception. Periodically (several times a second) the Addaverter samples missile directional information and con-

verts it to digital form. After each conversion, which takes about 100 microseconds, the information is transferred to the digital computer which calculates the proper trajectory. The corrective data is then returned in digital form to the computer-converter where, in approximately 30 microseconds, it is reconverted into analog voltage and passed on to the autopilot simulation.

Since the autopilot is represented in analog form, the actual autopilot equipment could be used in the simulation. This, however, requires that the simulation be run at the same rate as the device being simulated, which accounts for the speed requirements of the digital computer and converting system.

While no strictly commercial applications of the computer-converter are foreseen at present, Convair-Astronautics scientists have worked out a variety of useful combinations for analog, digital, and Addaverter equipment. Wide use of Addaverter techniques is predicted for scientific laboratories and industrial firms interested in system engineering and automation.

Circle 131 on Reader Service Card.



## SPECTROPHOTOMETER PMQ II

MADE IN WEST GERMANY

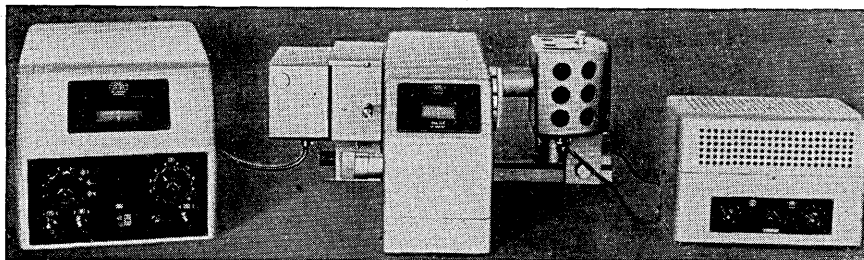

This instrument offers universal applications for rapid, reliable, and accurate photometric measurements of liquids, gases, and solids at the highest resolving power of the spectrum.

The spectral region ranges from near-infrared (1,000  $m\mu$ ) to far-ultraviolet (200  $m\mu$ ). The instrument operates on 110-volt A.C. The transmission and extinction is directly and easily read off on the scale of the indicator.

The adjustment of the width of the slit and that of the wave-length is guaranteed to be free of lost motion. This is accomplished by incorporating in the monochromator a mechanism automatically coupling the wave-length indicator to the wave-length emanating from the exit slit. This new device assures highest accuracy of measurement which will not be affected by wear and tear.

*Write for Literature*

**CARL ZEISS, INC.,**

485 Fifth Avenue, New York 17, N.Y.

*Guaranteed Uninterrupted Repair Service*

Circle 7 on Reader Service Card

# The Use of Choppers in DC Amplification

by P. T. McCauley, Director of Engineering, James Vibrapowr Co., Chicago

In many instrumentation applications, it is advantageous to use DC-operated strain gauges to avoid errors caused by stray capacitance or similar random reactive effects. Transducers of the thermocouple type act as DC generators. In other types of transducers, the useful information output either contains a DC component, or is of such low-frequency AC that for most purposes it must be treated as DC. General purpose analog computers make wide use of DC for computation. These fields, and a myriad of other applications of DC instrumentation, computation, and control have brought about wide use of high-gain, highly-stable DC amplifiers.

Prior to World War II, such amplifiers were not practical for general use. The introduction of the mechanical DC modulator, or chopper, into the field of DC amplification has overcome the considerable disadvantages of complexity, questionable long-term stability, and amplification accuracy inherent in the earlier design.

In essence, a chopper is nothing more than an electrically-driven, high-speed switch. It may be used to interrupt a DC signal, causing it to appear to the input of an amplifier as an AC signal having a peak voltage equal to that of the applied DC. This makes it possible for the DC amplifier to be AC coupled, and to make use of the straightforward techniques normally found in high-gain, high-stable AC amplifiers.

At the output of the amplifier, rectification and filtering may be employed to restore the signal to DC having a high order of freedom from drift and error. Or the signal may be used as AC having a specific and accurate relationship to the input DC. This general type of DC amplifier is usually referred to as a "straight chopper amplifier" (Figure 1). Its high-frequency re-

sponse is generally limited to about one-tenth the switching frequency of the chopper.

There is a second general type of chopper amplifier known as a "chopper stabilized amplifier" (Figure 2). It is a combination of a straight chopper amplifier with a conventional DC amplifier so that the high order of stability of the straight chopper amplifier is combined with the high-frequency response of the conventional DC amplifier. This is accomplished by feeding the input signal directly into a DC amplifier, and through a low-pass filter into a straight chopper amplifier having a rectified and filtered output. This output is then introduced into the input of the DC amplifier.

The chopper amplifier in this arrangement precedes the DC amplifier for DC and very-low-frequency AC signals. Since the chopper amplifier is not affected by power supply voltage changes and similar causes of instability, it acts as an input stage having high gain and very low drift. The use of this type of chopper stabilization reduces the effect of drift in the DC amplifier by a factor equal to the gain of the chopper amplifier.

In a straight chopper amplifier, high-frequency response is sacrificed in the interest of maximum stability and sensitivity, and practically all of the error appearing is chopper-generated. In a chopper stabilized DC amplifier with much better high-frequency response, chopper-generated error appears in the same magnitude as in a straight chopper amplifier; but there is, in addition, the drift of the main DC amplifier reduced by the factor of the gain of the side chopper amplifier. In this case, maximum stability is sacrificed in the interest of improved high-frequency response.

Compared to a conventional DC amplifier, both of these types show a vast improvement in usable gain and long-term stability. The principal cause of drift,

Figure 1. Straight chopper amplifier.

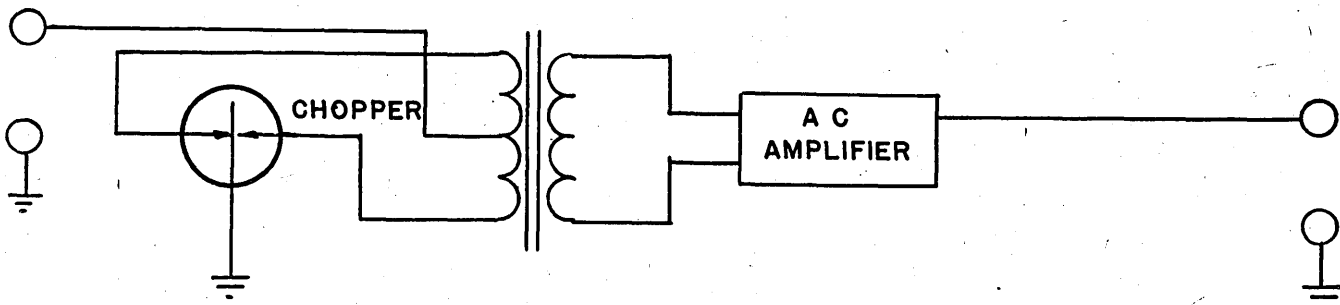

sees automation as vital asset  
for free world . . .

## Sarnoff foresees Voice-Controlled Systems

Automation, with its vast promise of higher productivity, can become a "vital asset" to our national economy and to the security of the Free World in the Cold War against Communism, Brig. General David Sarnoff, Chairman of the Board of Radio Corp. of America, declared recently.

Addressing the 34th annual conference of the Life Office Management Association, General Sarnoff said that far from being a threat to the American economy, automation can "contribute immeasurably to the prosperity we seek for ourselves and for all mankind."

"Automation—a concept born of the latest phase of electronic development—has become critically important to us and to our allies. It offers the stimulating prospect of greater security, wider industrialization, a higher standard of living, and a better and happier life. If we have the wisdom and the will to face up to our opportunities, electronics can broaden our horizons beyond all expectation."

To the American economy, automation holds out the promise of being a boon rather than a bane, Sarnoff said. In answer to the "calamity criers" who picture it as a threat of dire trouble, he cited past revolutionary developments of the machine age and pointed out they actually created more jobs than they eliminated.

"We have the word of our most eminent economists that the major problem in the years ahead will not be unemployment, but how to stretch the labor force to keep pace with our growing population and our rising standard of living. . . . The answer to increased productivity will be found through automation.

"As our national economy adjusts to this new force, there will inevitably be problems—the kinds of problems that have always accompanied technological change," he said. "But one of America's greatest sources of strength has been its ability to accommodate, and even to encourage, technological change without changing its own basic emphasis on individual freedom and human dignity."

After noting some of the tremendous accomplishments already scored by electronics in business and industry, General Sarnoff mentioned three fields in which he expects dramatic developments in the future:

(1) *Medical diagnosis*: Electronic computers ultimately will aid the doctor in examinations and diagnosis by storing in their "memory" not only the best medical knowledge of the day—the symptoms, for example, of the various diseases—but also the previous medical record of the patient involved, such as cardiogram, blood pressure, temperature, and blood count. By scanning this information, fed to it on tape, this

"diagnostic robot" can give the doctor an instantaneous picture of any important changes in the patient, Sarnoff said.

(2) *Personal Radio Communication*: "With a tiny gadget about the size of a pack of cigarettes, you will be able to carry on a conversation with friends or business associates wherever you happen to be—on the golf course, on a fishing trip, or even on a trans-Atlantic flight. Your receiver will have a decoding unit that will respond to only one of a million or more possible arrangements of pulses sent out from a transmitter. In this way, you will be assured of complete privacy in your conversation, even though you will be on the largest party line in the world."

(3) *Voice-Controlled Electronic Systems*: "Basic studies already have led to the development of a rudimentary phonetic typewriter that can type a few simple words and phrases spoken into a microphone. Through experiments with this system and further development of the novel principles employed in it, we can expect to achieve new and versatile systems capable of 'understanding' and carrying out verbal orders.

"The business man of the future may well dictate his inter-office memos and personal letters directly to an electronic typewriter that will produce them phonetically in response to his voice.

"We may also look forward to the day when spoken instructions will be used to control the programming and operation of computers in business. To be really fanciful, we might picture the householder of the future talking into a little pocket transmitter to issue such instructions as 'dishwasher on,' 'thermostat 72 degrees,' and so on—activating controls which cause each of these things to happen instantly."

In the business field, General Sarnoff said, it is not unreasonable to envisage the day when all branch offices will be linked with the home office through communications systems integrated into the computer systems to perform accounting and other operations.

"Insurance policy records, which now occupy five or ten floors of a skyscraper office building, will ultimately be condensed on a few hundred reels of magnetic tape and stored in a single room," Sarnoff continued. "An employee who wants some specific information on your policy or mine will simply press a button or dial a code number. The electronic memory will be searched at lightning speed, and the desired information will appear instantly on a television-like screen on the employee's desk.

"Great as the accomplishments of industrial and commercial electronics have been so far, we are still in the pioneering stage."

# Electronic Linguist

## "speaks" both A&D terms

A sort of electronic linguistic genius—a machine that “speaks” in both analog and digital terms—is making possible faster, more flexible, and more accurate scientific calculations at Convair Div. of General Dynamics Corp.

Originated by Convair-Astronautics (the Convair operating division at San Diego, Calif., responsible for development and pilot production of the Atlas Intercontinental Ballistic Missile), the \$200,000 “computer-converter” was named the Addaverter. It will be used to help simulate and evaluate flight performance of the ICBM.

To bridge the analog and digital computing equipment with the computer-converter requires 7,700 pounds of electronic materials housed in eight-foot-high cabinets 15 feet long and two feet deep. The unit contains 2,000 vacuum tubes and about 4,500 germanium diodes. Its display panel contains nearly 600 flashing lights. It uses 15,000 watts of power.

Until recently analog and digital computing systems could be combined only in a limited way due, in part, to the fundamental differences in analog and digital systems’ methods of solving complicated problems. Analog systems, for example, express quantity by measurable physical characteristics, such as voltage, rotation, and resistance. Digital systems express quantity in exact numbers or digits. In essence, an analog system measures; a digital system counts.

Convair-Astronautics and Epsco, Inc., of Boston, Mass., developer of

Electronics engineers for Convair Div. of General Dynamics Corp. use an oscilloscope to check circuits in electronic device that accurately converts computer data into either analog or digital terms.

the Addaverter, have succeeded in mating the two computing systems on a large scale. The Addaverter, by converting problem data from analog to digital and digital to analog, unites the best features and decreases the disadvantages of each system. The unit is capable of great accuracy without the usual deterioration at low signal levels.

Specifications for the computer-converter were developed under the direction of W. H. Schwidetsky,

chief of computers and simulation for Convair-Astronautics. The main problem was to meet exacting performance requirements of a high-speed converting device without sacrificing flexibility. Specifications had to take into account the varied features of analog and digital computers, as well as present and future features of missile systems and the state of converter technology.

The principal use of the Addaverter at Convair-Astronautics, and

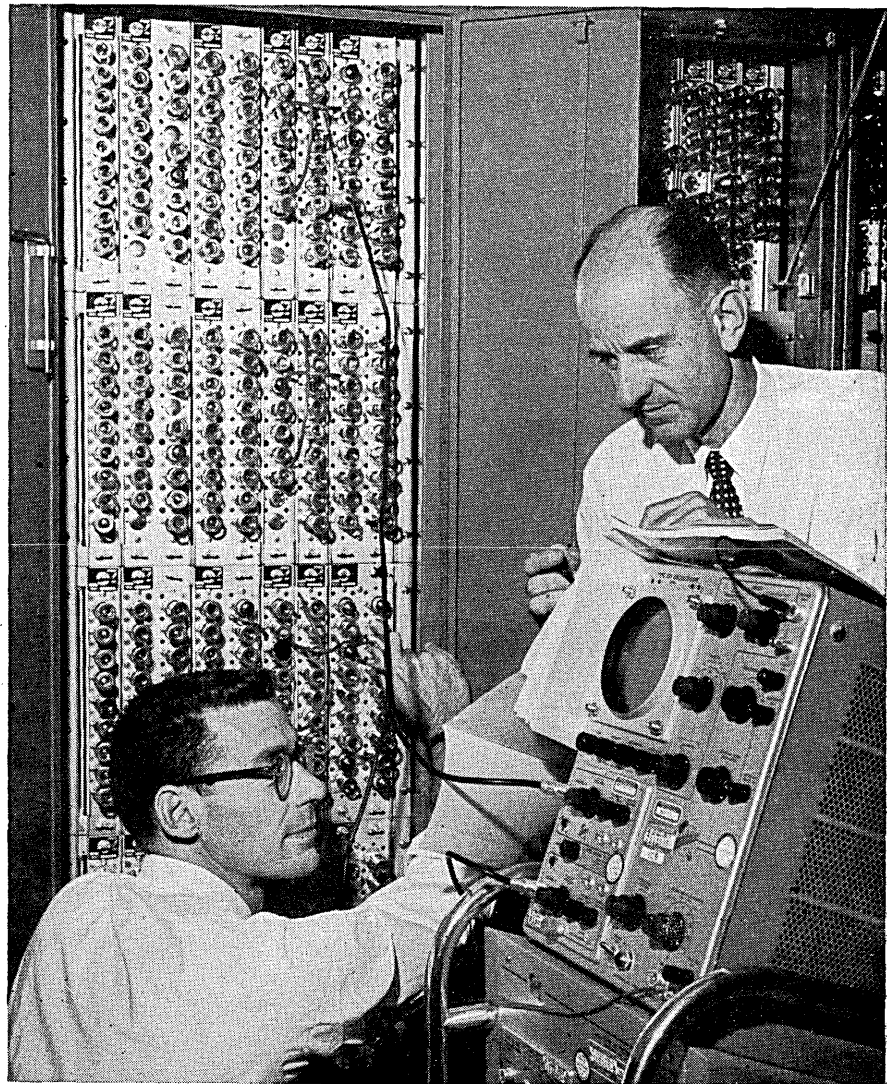

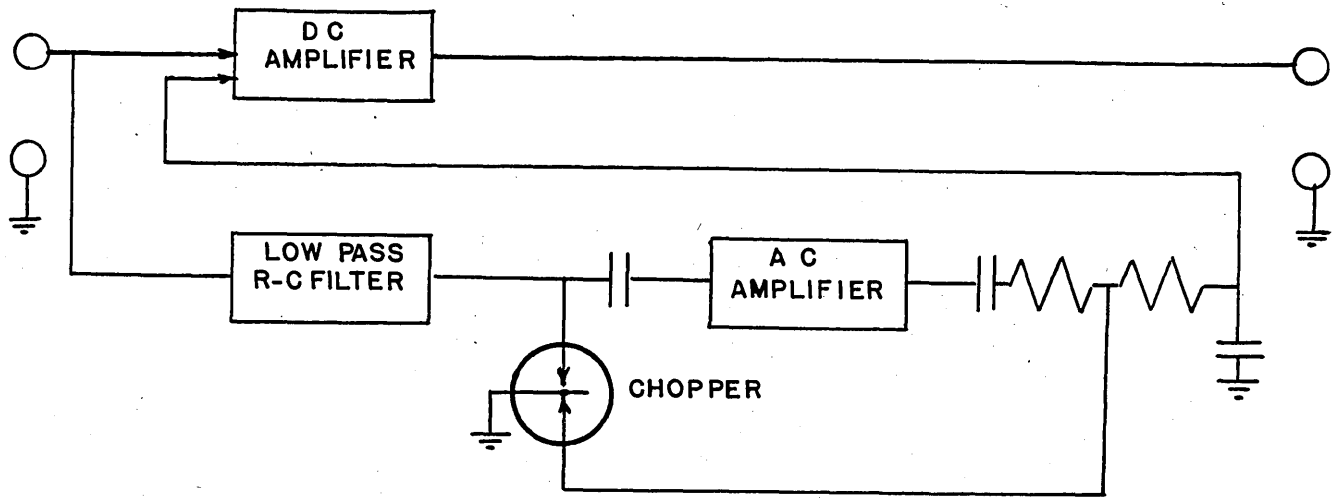

Figure 2. Chopper stabilized amplifier.

offset, or residual noise is transferred from the electronic circuitry of the amplifier to the chopper itself. For this reason, the characteristics of chopper-generated noise become an important consideration in the design of various types of chopper amplifiers and in their application.

**Chopper noise defined**

Chopper noise may be defined as any extraneous electrical signal generated by the chopper. It is desirable that it be many times smaller than the level of the desired signal, and that it be constant in nature and level. This noise comes from several different sources, and is usually identified by its origin. Noise may be categorized as dielectric, magnetic, thermal, electrochemical, and electrostatic. In a working amplifier, all types are usually present to some degree, and their identification may present formidable problems in measurement technique.

Dielectric noise is generated by the motion of a

conductor in the vicinity of a dielectric. Consider the fundamental relationship,  $Q = CE$ . At any given instant, the switching circuits of the chopper will have some small voltage with respect to ground due to various combinations of the other sources of voltage generation. Therefore, there will be energy stored in the dielectric material adjacent to these switching members. As they move closer to or further away from the dielectric material, their capacitance to ground will change. With  $Q$  held constant,  $E$  must vary in inverse proportion to the variation in  $C$ . Thus, an alternating voltage proportional to the amplitude and frequency of motion of the switching members is generated.

Since the actual capacity and, hence, the amount of energy stored is very small, it has a very high impedance. That is to say, the internal generator imped-

Figure 3. Chopper noise measuring equipment; (above) 60 cps measurements, (below) 400 cps measurements.

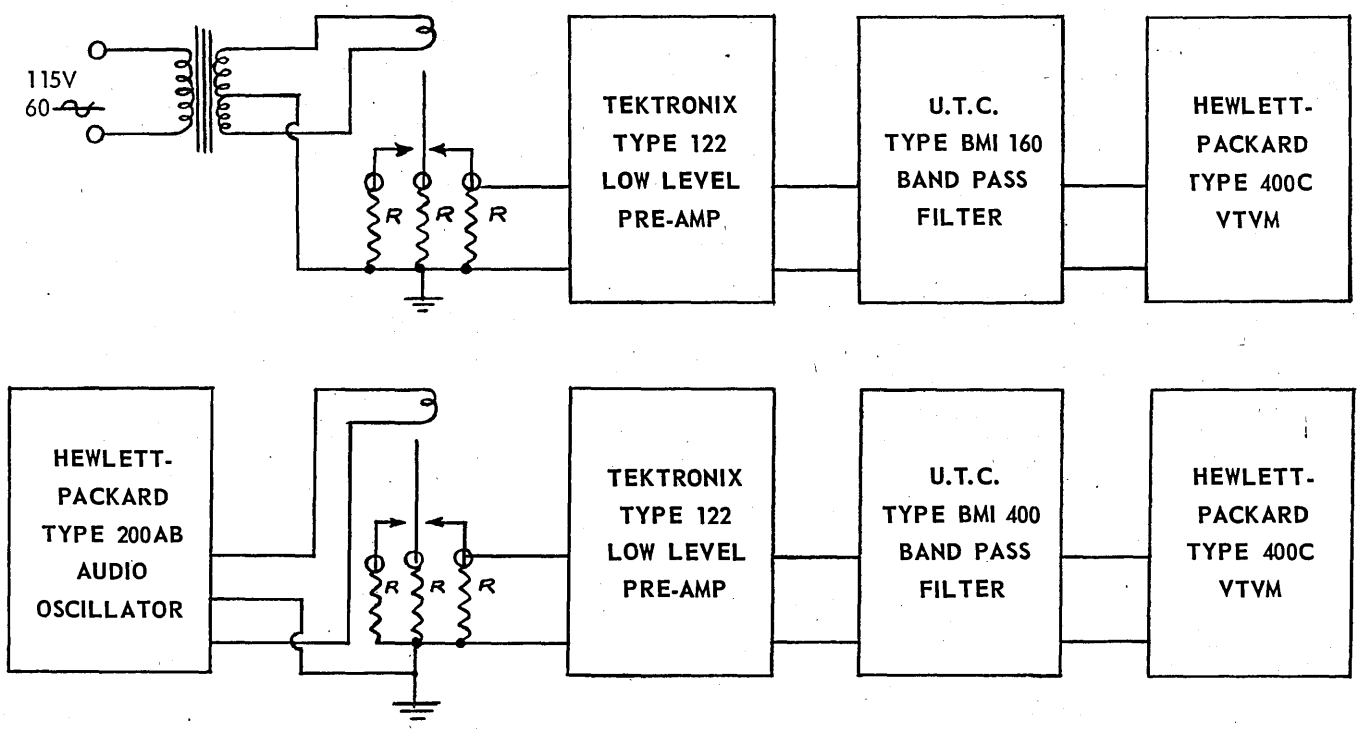

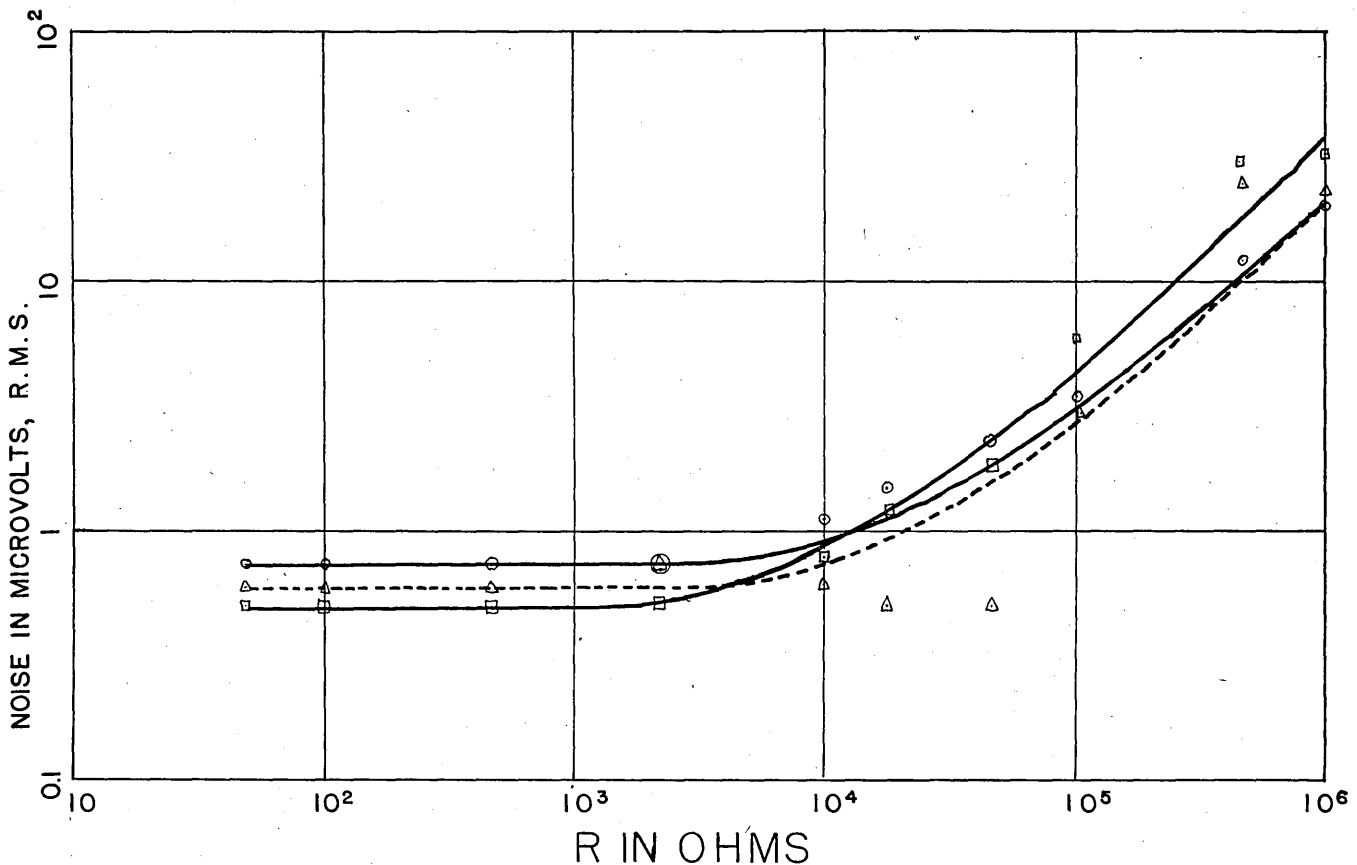

Noise versus Circuit Resistance, James Type C-1275, 6.3 v, 400 cps.

ance of electrostatic noise is very high. For example, in a *James 1200 series* 400-cycle chopper, dielectric noise is on the order of five microvolts when the contact in question is terminated in one megohm, and drops below one microvolt at 100,000 ohms. As a result of the high source impedance, dielectric noise appears to be directly proportional to load impedance and may be expressed in volts per ohm of load impedance.

### Magnetic noise

Magnetic noise originates in the switching circuits of the chopper by stray magnetic flux linkages through the closed loops of the contact circuits and the terminating load impedance. As contrasted to dielectric noise, magnetic noise has a very low source impedance—less than one ohm. This occurs because the circuit is, in effect, a transformer having a one-turn secondary consisting of the contact bearing members of the chopper. The chopper drive coil acts as the primary. Since the turns ratio is of the order of 2400, and the DC resistance of the chopper drive coil is about 300 ohms, the reflected impedance would be on the order of  $0.18 \times 10^{-6}$  ohms if this were the limiting factor. Actually, the closed circuit contact resistance is on the order of a few-hundredths of an ohm, and this governs.

Since this value is generally very much lower than the circuit load impedance, magnetic noise is practically constant, regardless of external load impedance. It is, therefore, usually expressed as an absolute level of noise. In terms of induced noise level in the *1200 series* chop-

pers, the contact circuits are well shielded from stray flux linkages so that the magnetic noise level is far below that which would be anticipated from transformer theory.

### Thermal noise

Thermal noise is produced by a temperature gradient across a bi-metallic junction in exactly the same fashion as a thermocouple. In a *1200 series* chopper, the number of these junctions has been kept at minimum, and they are so arranged as to generate cancelling voltages. The points at which thermal noise can be generated are at the junctions between the steel spring arms and the gold contacts, between the steel spring arms and the copper lead wires, and between the copper lead wires and the ferrous alloy base pins. However, these circuits are symmetrical mirror images of one another and are connected in series when the contacts are closed, such that the polarity of voltage generated by one set of contact circuits is opposite to that of the other.

Thus the voltages buck out one another if the temperature gradients across the various junctions are the same. Since all of the parts concerned with generation of this type of noise are in close proximity, the differences in temperature gradients are generally very small and the resulting noise is negligible. Because of the virtual impossibility of maintaining controllable temperature gradients across the various junctions under repeatable test conditions, choppers are not generally rated for level of thermal noise.

Electro-chemical noise is produced by galvanic action between dissimilar metals separated by an insulating barrier in the presence of moisture. In essence, two dis-

similar metals separated by an insulator will generate a voltage if there is an electrolyte present. Atmospheric humidity is sufficient to dissolve minute traces of impurities in and around the insulator, which provide the necessary ions to make an electrolyte. The result is a small battery whose output voltage is dependent upon the amount and nature of the electrolyte, and upon the difference between the metals in the electromotive series. Its prevention lies in scrupulous cleanliness, and proper material selection. In the case of sealed choppers, it may be further inhibited by thoroughly drying out the chopper prior to sealing, and including only dry air or a dry inert gas in the can.

The required cleanliness and dryness can best be achieved in an air-conditioned, humidity-controlled room having an adequately-filtered air supply. For the 1200 series choppers, conditions of manufacture are such as to assure maximum cleanliness and dryness. In addition, the problem has been attacked at its source. At every point where an electro-chemical voltage can be developed which will appear in the contact circuits, the metal surfaces on either side of the insulator are gold plated. Thus, gold-plated frames, gold-plated spacers, gold-plated spring actuators, and the like are used. Gold is a relatively inert metal, and is not subject to oxidation or tarnish to nearly the same degree as silver. By eliminating dissimilar metal surfaces, the problem of electro-chemical voltage generation is reduced to inconsequential proportions. As in the case of thermal noise, it is not practical to specify a level for electro-chemical noise owing to the extreme difficulty of establishing a standard condition for measurement.

Electrostatic noise originates in the signal or switching circuits of the chopper by capacitive coupling between the chopper drive voltage and the signal circuits and their associated wiring, including base pins on the header. Since the actual capacity of this stray coupling is very small, it behaves just as does dielectric noise.

Noise versus Circuit Resistance, James Type C-1204, 6.3 v, 60 cps.

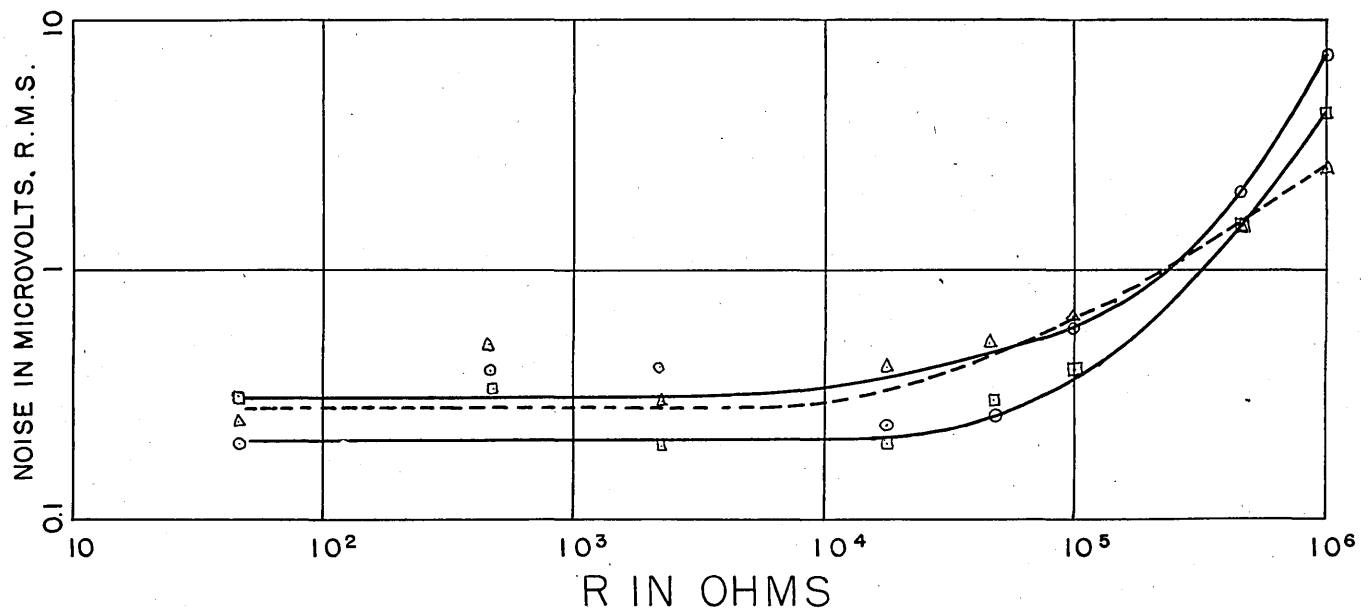

There are two other aspects of noise not directly associated with the internal operation of a chopper. The first of these is external dielectric noise caused by the vibration of the chopper. In some cases, this vibration can be transmitted to insulated lead wires in high impedance circuits. When an insulated wire (particularly one of the newer thermoplastic types) is vibrated relative to another conductor, such as a metal chassis, an alternating voltage can be developed in exactly the same fashion as occurs within the chopper. The second source of external noise is the mechanical excitation of microphonic low level tubes.

Measurement of the various forms of chopper noise presents certain problems. In almost all cases, the noise in question is below thirty or forty microvolts, and the majority of the measurements must be made at levels below one microvolt. Particularly in the case of 60-cycle choppers, stray fields of power line frequency present a great obstacle.

Wide band noise measurements using an accurate peak-to-peak voltage detector certainly are the most informative types of data. However, thermal noise in the input circuits of such amplifiers limits their usable sensitivity for quantitative measurements to about 50 microvolts (amplifier noise being 10% of signal level).

In the 1200 series choppers, the noise output lies substantially at the exciting frequency. That is, noise passed through an amplifier having a flat frequency response from 0.2 cps to 40 kc produces the same reading on an RMS vacuum tube voltmeter as noise passed through an amplifier having a flat frequency response from 8 cps to 250 cps in the case of the 60-cycle choppers. However, even with such substantial bandwidth reduction, amplifier noise still limits accurate quantitative measurements to about 20 microvolts.

As a result it was determined to make noise measurements using a very narrow band pass filter, having its pass band center at the exciting frequency of the chopper. Using this technique, it is possible to obtain a measuring system having an equivalent noise input of about 0.1 microvolt. This allows a reasonable degree of accuracy of measurement down to 1.0 microvolt and an

indication of even lower noise. However, the insertion of such a filter into the system allows passage of only the sinusoidal component of the noise at the fundamental frequency of the signal input. Peak-to-peak measurements therefore lose their meaning. Even though the elimination of higher harmonics reduces the RMS noise reading by some small amount, this appears to be the only practical means of making readily reproducible noise measurements of a chopper whose residual noise is only 8 microvolts at most at a circuit impedance of one megohm. The noise versus circuit resistance curves given here were plotted from data taken using this method.

The equipment used in the measurements consisted of a shielded chopper jig made by JAMES, a Tektronix Type 122 Low-Level Preamplifier, a UTC type BMI-60, or BMI-400 interstage bandpass filter, a Hewlett Packard type 400C vacuum tube voltmeter, a Tektronix type 531 oscilloscope, and a Hewlett Packard type 200AB audio oscillator. Figure 3 is a block diagram of this equipment arrangement.

The noise curves are not rationalized but, rather, are actual best fit curves of the data as taken. As a result, points appear which lie well removed from the curves. In general, these may be attributed to abrupt increases in the ambient noise level caused by the operation of spot welders in the vicinity, and similar high level magnetic transients. In some cases, one contact shows consistently lower noise level than the other. This can be attributed to a steady level stray field external to the chopper and out of phase with the particular contact.

As has been discussed earlier, dielectric noise appears when the circuit impedance is high, and magnetic noise when the circuit impedance is low. An examination of the curves will show a fair range at the lower load resistance where noise is practically constant. This is the magnetic noise. As circuit resistance increases, the noise line slants upward, with noise doubling with each doubling of circuit resistance. This is primarily dielectric noise.

Thermal noise and electro-chemical noise do not appear on these curves, as such. They represent some very small portion of the noise identified as magnetic and dielectric, respectively. Thermal noise can best be measured by determining the noise level at a low impedance, with all members of the unit at an even temperature. Then, if a temperature gradient be induced across one of the bi-metallic junctions, the increase in noise level may be attributed to the thermal emf generated by the temperature gradient.

Electro-chemical noise is of high source impedance. It can best be measured by baking a chopper at 85°C in a vacuum for a period of several hours, and then measuring the noise level across a high impedance. Then, if the chopper is subjected to high humidity for a period of several hours, any increase in noise at the same impedance can be attributed to electro-chemical action. A word of caution in this connection is in order. It is possible that minute quantities of free water may collect on insulator spacers and seriously lower the chopper insulation resistance, if condensation has occurred during the course of exposure to high humidity. In this case, depending on the nature of the measuring equipment, the effect may be completely misleading.

The distinction between electrostatic noise and dielectric noise presents a problem in measurement of such proportions that it was resolved only by construction of a series of experimental choppers without dielectric material in the vicinity of the moving system. While the resultant choppers were not practically usable, they were adequate for determination of electrostatic noise level. In general, however, it is safe to assume that noise is principally electrostatic in nature when the measured noise level across a high impedance changes when one side or the other of the driving coil is grounded, or when noise level appears to be proportional to input voltage.

The data given in the curves will give the design engineer a basis for selection of components and circuit parameters consistent with the input signal level necessary to his particular application. It should be further considered that the contact closures of the 1200 series chopper are displaced about 20° lagging with respect to the driving voltage, and about 10° lagging with respect to the driving current in the case of the 60 cycle chopper, and about 65° lagging with respect to the driving voltage and 10° lagging with respect to the driving current in the case of the 400-cycle chopper. In some cases, these phase relationships may be used to differentiate between signal and noise where it is necessary to operate with signal levels of the same order of the magnitude as the residual noise. Whether the closure displacement with respect to voltage, or current, is of primary importance under these circumstances depends on the nature of the noise and the circuit impedance.

Circle 132 on Reader Service Card

## U. of C. to Build New Computer

The University of Chicago has announced it will build a high-speed digital computer of advanced design for scientific research. The computer will be designed by Nicholas C. Metropolis, the physicist who directed the development and construction of Maniac I and Maniac II at the Los Alamos, N. M., Scientific Laboratories.

Metropolis has assumed a joint appointment as director of the University's new Computer Laboratory and professor in both the department of physics and the Enrico Fermi Institute for Nuclear Studies; Chancellor Lawrence A. Kimpton has announced.

The new computer will be an advanced Maniac (Mathematical analyzer, numerical integrator, and computer) design, and will require two years to build.

Maniac I is a high-speed digital computer completed in 1952, which made the complicated calculations involved in the development of the first thermonuclear device. The computer was constructed under Metropolis' direction by members of the Los Alamos lab of the Atomic Energy Commission, operated by the University of California.

Also coming to the University from Los Alamos is Walter Orvedahl, who will serve as chief engineer for the new Computing Lab.



**Program Hi-Lights  
of AIEE, IRE, and ACM's . . .**

# Eastern Joint Computer Conference

The latest advances in the use of electronic "brains" for defense, industry, aircraft, earth satellites, automobile control, communications industry, and business will be aired at the Eastern Joint Computer Conference at the Shoreham and Sheraton Park Hotels, Washington, D. C., December 9-13.

Forty-seven papers will be presented during nine sessions. The Conference is sponsored by the American Institute of Electrical Engineers, the Institute of Radio Engineers, and the Association for Computing Machinery.

Speaker at the Conference banquet Wednesday evening, December 11, will be E. R. Quesada, special assistant to the President for airways modernization. The luncheon speaker on Thursday, December 12, will be Max Woodbury, New York University. His topic will be "The Voters Won't Wait!"

Scheduled sessions and their chairmen are: "Industrial Control Computers & Instrumentation" (two sessions), E. C. Johnson (Bendix Aviation Corp.) and J. F. Reintjes (Massachusetts Institute of Technology); "Traffic Control, Navigation and Surveillance" (two sessions), Morris Rubinoff (University of Pennsylvania) and Arnold A. Cohen (Remington Rand UNIVAC); "Simulation in Real Time," R. M. Howe, University of Michigan; "Synthesis of Real-Time System," John W. Carr, University of Michigan; "On-Line Business Systems," R. E. Sprague, Teleregister Corp.; "Digital Communications Technique," I. L. Auerbach, Auerbach Electronic Corp.; and "Document Reading, Pattern Recognition & Character Synthesis," Howard Engstrom, National Security Agency.

**Papers to be presented include . . .**

*A Coordinated Data Processing System & Analog Computer to Determine Refinery Process Operating Guides*, by C. H. Taylor, Fisher & Porter Co.,

*Mechanization of Letter Mail Sorting*, by I. Rotkin, National Bureau of Standards,

*Logic Functions & Their Application to Steel Mill Control*, by W. M. Brittain, Westinghouse Electric Corp.,

*Preparations for Tracing an Artificial Earth Satellite at the Vanguard Computer Center*, by D. A. Quarles, Jr., International Business Machines Corp.,

*Use of a Digital Computer for Airborne Guidance & Navigation*, by S. Zadoff & J. Rattner, Sperry Gyroscope Co.,

*Experimentation on the Human Operator Tie-In to an Airborne Navigation Computer Control System*, by C. A. Bennett, International Business Machines Corp.,

*Multi-Weapon Automatic Target & Battery Evaluator*, by A. E. Miller, Burroughs Corp.,

*Control of Automobile Traffic as a Problem in Real-Time Computation*, by D. L. Gerlough, University of California,

*Applications of Computers to Automobile Stability & Control Problems*, by R. H. Kohr, General Motors Corp.,

*A Transistor Circuit Chassis for High Reliability in Missile Guidance Systems*, by G. A. Raymond, Remington Rand UNIVAC,

*A Real-Time Control System for Air Defense*, by R. R. Everett, H. D. Bennington & C. A. Zraket, MIT Lincoln Laboratory,

*The Sage Duplex Computers*, by C. E. Diss (International Business Machines Corp.), P. R. Vance (MIT Lincoln Laboratory) L. G. Dooley (Rand Corp.),

*The Application of Electronic Computers to Air Traffic Control*, by W. H. Thomas, International Business Machines Corp.,

*On-Line Data Processing for CAA Air Traffic Control Operations*, by G. E. Fenimore, CAA Technical Development Evaluation Center,

*The Use of an IBM 704 in the Simulation of Speech Recognition Systems*, by G. L. Schultz, International Business Machines Corp.,

*Devices for Reading Handwritten Characters*, by T. L. Dimond, Bell Telephone Laboratories.

## New IBM System

Data Processing Div. of IBM has announced the 705-III, one of the most powerful electronic systems on the market for the processing of business data. It is the latest addition to the IBM 700-series of large-scale electronic data processing systems now at work in scores of business, scientific, and government installations.

One of the features of the new system is a completely-transistorized magnetic tape unit with an input-output rate fast enough to read or write the equivalent of a full-length novel once every 15 seconds. This ultra-high speed tape unit, the IBM 729 Model 3, can read or write business information at the rate of 60,000 characters per second, automatically checking the information for validity and readability at the same time.

The system also utilizes the new 767 Data Synchronizer which controls magnetic tape input and output so that the 705-III can read problem data, compute, and write answers simultaneously.

Circle 133 on Reader Service Card

# Send Real Voices On Imaginary Journey

New equipment designed at Bell Telephone Laboratories and developed by the Modac Div. of Airborne Instruments Laboratory, Inc. now permits Bell researchers to prove complex theories of speech transmission without building expensive test models.

The transmission of speech over wires is one of the most challenging problems in the field of engineering. The sound coming out of a telephone receiver should be a facsimile of the sound that goes into the transmitter. But telephones may be separated by thousands of miles, and the speech that enters the telephone at one end may have to pass through a number of circuits and many types of terminal and repeater equipment before it emerges from the receiver at the other end.

What happens, then, when an engineer comes up with a new theory for improving the voice quality or the efficiency of a telephone line? If, for instance, he wants to introduce but one new element into the relay system that will permit more messages to be sent over that same line, how can he be sure that the overall system will work according to his theory? How can he test all of the variables of distance, time, and performance characteristics of present-known equipment, and anticipate their effect on his proposed changes?

The obvious method—modifying the scores of relay stations according to the new theory and conducting actual tests on an existing full-length telephone line, would not only be fantastically expensive but might even disturb telephone service

over parallel lines. An alternative method—constructing a laboratory test model that would duplicate conditions on the cross-country line, is scarcely less expensive, especially in the light of modifications that might be necessary to convert it for use in future tests.

Bell Laboratories researchers developed a theory they considered might eliminate the setting up of these costly and time-consuming masses of experimental equipment. If they could get a piece of equipment that could convert their theories into computer information, a great saving of time and money could be effected in testing these theories.

Dr. Henry MacDonald and Dr. Max V. Mathews of Bell Labs brought their problem and the suggested solution to Thornwood, N. Y., where the Modac Div. of Airborne Instruments Laboratory is located. As a result, the Record and Playback Unit was conceived and is being manufactured by Modac. This equipment reduces experimental theories on speech and speech systems to a magnetic tape, and evaluates them by actually examining electrically the synthesized output of the IBM computer, as different variables and engineering concepts are introduced.

Joseph D. Mountain, Director of Modac, in explaining the equip-

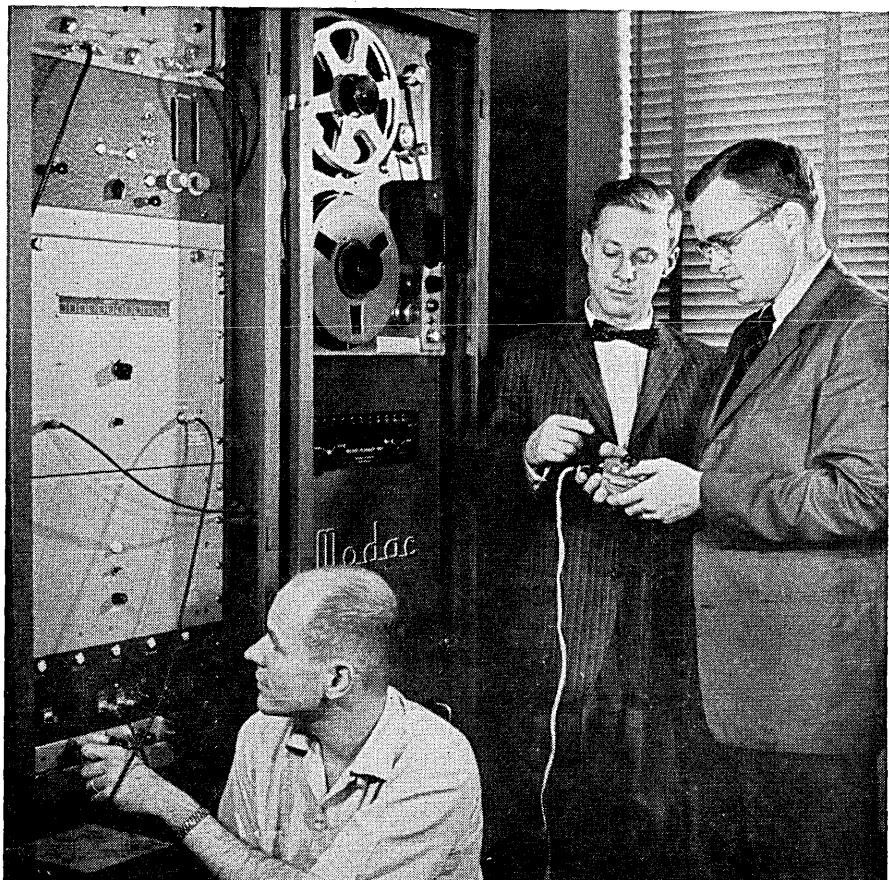

Modac equipment at Bell Telephone Laboratories. Left to right: M. V. Mathews, E. E. David, Jr., and H. S. MacDonald.

ment, stated, "The theory testing system couples Modac's magnetic tape record and playback unit with a high-speed electronic computer. In sound research, exact conditions of the proposed telephone circuit—the functions of the existing equipment, plus the individual function of the equipment to be introduced—are fed onto magnetic tapes that record all of the functions as electronic impulses. The Modac equipment, together with a converter, combines the impulses into digits which it feeds to the computer.

"In the computer, the digits are run through a myriad of equations simulating the circuit, and a final answer—in numerical form—is pro-

duced. This answer is then fed back into Modac equipment where it is converted into electronic impulses which exactly duplicate those of the proposed new circuitry. The machine then reproduces the voice through a speaker exactly as it would sound if the voice had traveled any proposed distance."

To illustrate this laboratory short-cut, Axel Jensen, Director of Visual & Acoustics Research of Bell Labs, speaking before the NARTB Engineering Conference in Chicago on coding and decoding speech messages, gave an interesting demonstration. He let his listeners hear simple sentences which had been recorded by the Modac machine onto magnetic

tape. These sentences were then coded onto IBM digital tape and transformed, by an IBM 650, into punched cards. These cards, in turn, were fed to an IBM 704; onto tape; into a translator; and finally, they were put on magnetic tape which, when played, could be compared with the original speech.

Summing up the demonstration, Jensen said, "Consider this amazing string of conversions—starting with ordinary speech, changing it into an 18-inch-high stack of punched cards, then reconstructing it to get reproduced speech of good quality! It's an important step ahead that will open new avenues to electronic researchers!"

## simulate air traffic flow on digital computer

**T**raffic jams in the sky are more than just a possibility—they are an actuality. But electronic computers may provide a solution to the problem. Scientists at Armour Research Foundation of Illinois Institute of Technology are simulating the flow of air traffic on an electronic digital computer.

They are investigating air traffic control systems for use by commercial, private, and military operators in the common system of the continental United States, according to Virgil H. Disney, manager of the ARF electrical engineering research department. Purpose of the investigation is to determine the effect of changes in the route structure and rules of the control system on air traffic capacity.

Sponsored by the U.S. Army Signal Engineering Laboratories (Ft. Monmouth, N. J.) and the Air Navigation Development Board (Washington, D. C.), the research study is being conducted in the Foundation's computer center in Chicago and its Southwestern Labs in Tucson.

It is now widely recognized that an improved systems approach to air

traffic problems is necessary, it was pointed out by project leader Gayle W. Bond of the ARF staff at Tucson. "During the past decade, volume of air traffic has increased very rapidly and flight characteristics of aircraft have changed almost radically."

"The maximum handling capacity is being reached," he added, "and new techniques for air traffic control are needed to handle more aircraft in the same amount of space with an adequate margin of safety."

A number of research and development projects aimed at improving the common system of air traffic and navigation in the United States are being sponsored by the Air Navigation Development Board, composed of the Department of Defense, Commerce, and the Military Departments.

For purposes of the Foundation's investigation, the area surrounding New York, Washington, and in between has been selected. "The initial portion of the program has been concerned with stipulated improvements in the present air traffic control system which can be made with presently available means," explained Bond.

He cited such improvements as alteration of airway structure, rearrangement of navigation and communication facilities, revised procedure, and additional personnel.

The later portion of the program is concerned with system improvements resulting from the assumed use of facilities which normally might be expected or could be made available in 1965, such as a complete radar network in the United States and improved communications.

Currently, two simulation methods are being investigated—one using paper and pencil methods and the other using electronic digital computers. The program is unique, according to Bond, in that methods of using an electronic digital computer for the systems analysis work are being developed and employed.

The complex procedure of air traffic control can be simulated in model form on the computer and accelerated to accumulate data more rapidly for analysis. In addition to handling more and larger samples, the computer enables the scientists to analyze the systems more completely and objectively.

Circle 134 on Reader Service Card

for engineers, scientists,  
and office personnel . . .

# New Tools Reduce Paperwork

**T**wo new machines that will greatly reduce paperwork drudgery for everybody from clerk to engineer have been announced by International Business Machines Corp., New York City.

They are the *IBM 610 Auto-Point Computer*—a desk-side electronic computer about the size of a spinet piano, which can handle problems ranging from insurance premium computation to jet aircraft design, and the *IBM 8200 Time Punch*—which punches employee payroll and job cost data on IBM cards at the source of these operations, thereby permitting automatic accounting.

"These machines," says Herbert R. Keith, general manager of IBM's Time Equipment Div. where the 610 and 820 were developed, "represent another big step toward freeing engineers, scientists, and office personnel from monotonous and routine paperwork—giving them more time for more interesting and creative work." Keith also feels that the 610, which further fills out the company's electronic computer line, will find its most widespread use in engineering laboratories.

At a recent IBM press interview, the new computer tackled computations involved in the trial design of a power transformer. Previously, an engineer working

with a desk calculator required six hours to solve the problem. The 610 had the answer in less than twenty minutes. The computer is capable of 214 additions or subtractions, and 52 divisions or multiplications a minute.

A high-speed, general purpose machine embodying many features—including a magnetic drum "memory" normally found only in giant electronic data processing systems, the 610 is completely self-contained: from initial programming to final output on punched tape or an IBM high-speed electric typewriter. The computer requires no air-conditioning.

Other features of the new computer are ease of programming and a flexibility which makes it applicable in a wide range of problem areas. Some of the jobs the 610 can handle are: bridge and highway design; stress, flutter, and vibration analyses encountered in jet aircraft design; sales forecasting, matrix arithmetic involved in communications circuit design problems, actuarial computations, reduction of test data for guided missile performance studies, cam design and performance analysis for industrial equipment manufacturers, and heat transfer calculations for the petro-chemical industry.

Of particular significance to the operator is the computer's ability to accept sentence-type instructions composed of any number of individual commands, causing the machine to execute entire functional operations

Operator checks arithmetic unit of new 610 Auto-Point Computer which features automatic positioning of the decimal point and simplicity of operation.



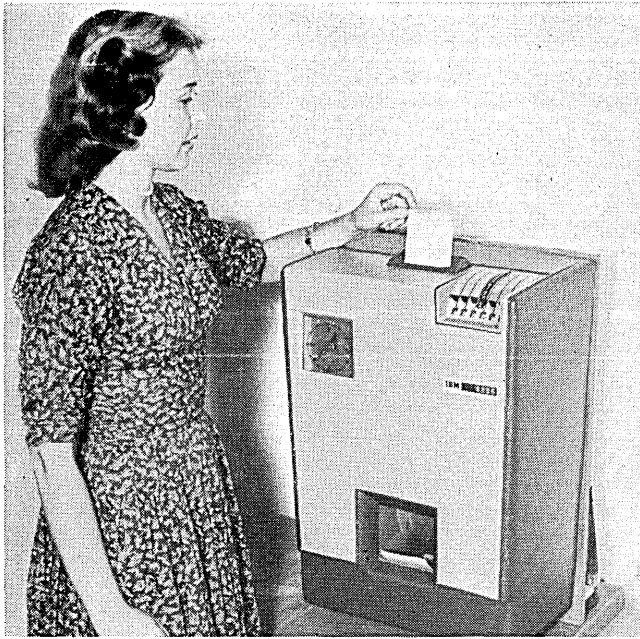

Here Ursula Wall inserts time card in new 8200 Time Punch. After card is punched by the machine to indicate employee attendance, it is feed directly to IBM electronic accounting machine for automatic preparation of payroll reports.

such as the computation of the square root of a sum, and the printing and punching of the answer.

Once the computer has been given a program for the solution of a certain type of problem, the program may be used over and over again. All the operator has to do is insert data into the machine, which will process it automatically.

The Auto-Point Computer takes its name from its ability to provide automatic decimal point control. To do this, the operator has only to throw a toggle switch to assure that the decimal point is positioned correctly throughout all computations and in final results.

An exclusive feature of the 610 enables the operator to intervene manually on the IBM electric typewriter keyboard as results are printed out. In this way, he can type in headings and other identifying data so that a complete, intelligible document is produced.

Another feature of the new computer is a visual display unit (similar to a miniature TV screen) which shows the operator any number stored in the machine. The 610 also employs special electronic circuitry to check itself against operating errors.

The newly-announced IBM 8200 Time Punch is reported to save a time clerk an estimated ten hours a week or more processing the attendance cards for 1,200 employees. With conventional equipment, the clerk must total up each employee's weekly attendance record and turn the data over to a key punch operator for recording on IBM punched cards.

The punched cards are then verified and run through electric accounting machines to add up payroll and other employee data. With the 8200 Time Punch, the work of the time clerk and key punch operator is done automatically, freeing them for other tasks.

The 8200 will be available in two basic types. The Time Punch, as used in attendance time applications, will produce IBM punched card records of IN and OUT

registrations of employees, identifying the day of the week, hour, and hundredths of hours in addition to an "on-time" designation.

Another model, Time-Data Punch, for job cost applications, will punch START and STOP times and, in addition, variable data such as employee serial number, job number, etc. The variable data is determined by manually-set levers. After a card is punched, an interlocking device prevents further card insertion until at least one lever is reset. A Time-Data Punch may be used for both attendance and job cost applications, where plant layout permits. The interlock may be made inoperative for an attendance application.

Operation of the 8200 is simple and fast. As each card is inserted into the card receiver, it is moved automatically to the punching location, punched, and delivered ready for data processing to the card stacker at the base of the recorder. The stacker has a capacity of 250 cards.

A key-operated time suppression device is an optional feature of the 8200. This device makes it possible to punch certain positions in the card while suppressing the punching of time. A timekeeper or supervisor would use this device to adjust a time card to a proper punching field as in the case of an employee who has not registered IN or OUT—a "no punch" condition. When a Time-Data Punch is equipped with the time suppression device, it is possible to insert variable data in cards without punching time. The 8200 will operate as an individual AC "plug-in" unit or as part of an existing IBM time system.

Circle 135 on Reader Service Card







Series 2000  
Snap-Action  
10 Amperes



Series 4000  
Silent Action  
1/2 Ampere



Series 23  
Silent  
Miniature  
1/4 Ampere



Series 30  
Silent Sub-  
Miniature  
.10 Ampere

- All for 115 V. AC operation
- Current carried commensurate with size

Write for Bulletin M-200



Telephone Fleetwood 4-1040

PUSH  
B  
U  
T  
T  
O  
N  
S  
W  
I  
T  
C  
H  
E  
S

567 Hillgrove Avenue, La Grange, Illinois

Circle 8 on Reader Service Card

# Complex Instruments Gather Hard-to-Get Data

**P**erkin-Elmer Corp. (Norwalk, Conn.), a leading manufacturer of scientific and optical instruments, has developed three precision optical devices of special importance to International Geophysical Year activities. These are: (1) optical systems for satellite tracking cameras, (2) auroral patrol spectrographs, and (3) tiny meteorological "weather eyes."

## Satellite tracking camera

The satellite tracking camera, featuring an optical system built by Perkin-Elmer, will be used to photograph the earth satellite as it moves in its orbit. Twelve of these special cameras, situated at strategic points on the earth, will make precise determinations of the satellite's orbit as it streaks through space (some 300 miles away from the earth's surface) at a speed of 18,000 miles per hour. With its high light-gathering power and unusually large 30° field of view, the tracking camera will detect the minute object in flight, making it possible to determine its orbit precisely.

Dr. James G. Baker, President of Spica, Inc. and one of the nation's foremost optical designers, designed the optical system for the satellite tracking cameras. The cameras themselves are being made under the auspices of the Smithsonian Astrophysical Observatory, which has the responsibility for the satellite optical tracking systems.

## Auroral patrol spectrograph

The auroral patrol spectrograph is an optical electronic instrument

This device, called an auroral patrol spectrograph, photographically records the spectra of auroras and air-glow.

which is expected to aid scientists in their attempt to solve an age-old mystery—the aurora borealis and aurora australis (more commonly called the Northern Lights and Southern Lights). Some 23 of these devices will be placed from the North to the South Pole in order to obtain a horizon-to-horizon photographic record of the spectra of auroras occurring along the meridional line

and, also, to photograph spectra of the "air-glow," a less known but equally baffling phenomenon.

A spectrum might be likened to fingerprints in that it is as characteristic of a material as fingerprints are of a man. Simply defined, it is an arrangement by wave-lengths of light or other radiant energy emitted by material. Thus, it can be seen that examination of the spectra of



matter in the atmosphere during an aurora is a positive means of identifying the aurora's composition.

The auroral patrol spectrograph is a highly complex and precise instrument. It consists of an upright steel box (about 4½' x 1' x 1¼'), a dome, and a small box extending from the top. An "all-sky" lens, which produces the image of a complete hemisphere on a flat plane, is housed in the dome.

The small box is a photometer, featuring a light-gathering system that "takes a picture" when the film in the instrument has been exposed to a certain quantity of light, or conversely, closes the shutter over the sky lens if the sky is too bright for the aurora or airglow to be photographed.

Inside the main box of the instrument is an extremely fast (F/0.625) Schmidt camera—four times faster than what amateur astronomers consider ultra fast. The spectrograph has been designed to function in all extremes of weather, from -40°F. at the poles, to 125° F. at the equator.

### Weather eye

The weather eye, only slightly larger than a pack of cigarettes and weighing less than four ounces, will measure the radiation emitted from the earth's cloud layer as the satellite spins in its orbit. Two of these devices are to be mounted in the satellite and will peer at the cloud layers through tiny windows in the satellite shell. Mirrors, only three inches in diameter by 3/16th of an inch thick, are designed to measure infrared radiation from the clouds, which will be focused on a tiny detector unit 1/25th of an inch long by 1/25th of an inch wide. The information collected will then be telemetered back to earth.

A silicon solar battery system to differentiate between day and night will disconnect the device when the satellite is on the dark side of the earth. The tiny "weather eyes" will help meteorologists gather information which is expected to prove helpful in long-range weather forecasting. At present, long-range forecasts are based on information covering only about 5% of the earth's surface. The type, patterns moisture content, and thickness of clouds are key clues to forthcoming weather.

Circle 136 on Reader Service Card

# New Computer Center Aids Research

**B**ecause of increasing demands on the joint Stanford University-SRI Computation Center, a second jointly-operated computer center, with an ElectroData Corp. 205 electronic digital computer, has been established at the Institute to complement the IBM 650 computer at Stanford University.

The new computer, located at the Institute's Menlo Park laboratories, has a 4,080-word memory, each word consisting, in computer terminology, of 10 decimal digits and a sign. It also includes a unit which provides automatic floating point arithmetic, i.e., automatic adjustment of the decimal scale of the computed data.

An IBM punched card system is used with the EDC 205 computer. The computation program information is punched on the cards which

are then fed into an input-output unit. This unit automatically reads the card information and transmits it to the computer.

It also receives output data from the computer and automatically punches this information on cards. An "on-line" printer provides printing of the computation for ready reference while the computer is carrying out the mathematical program.

All Institute research divisions employ computer techniques extensively. During the past year, computers have been utilized for almost 200 projects relating to air pollution studies, antenna design, civil defense surveys, computer design, detonation effects, distribution studies, economic planning, engine design, fuel consumption, fragmentation studies, market analysis, operations research, stress studies, weapons systems analysis, and many other research areas.

Although operated, maintained, and used by the Institute Mathematics Group as an Institute-wide service, the computer is available for direct use by other groups.

Below: C. L. Perry (standing), head, Mathematics Group, discusses a circuitry change with Arthur N. Briner, ElectroData resident engineer.

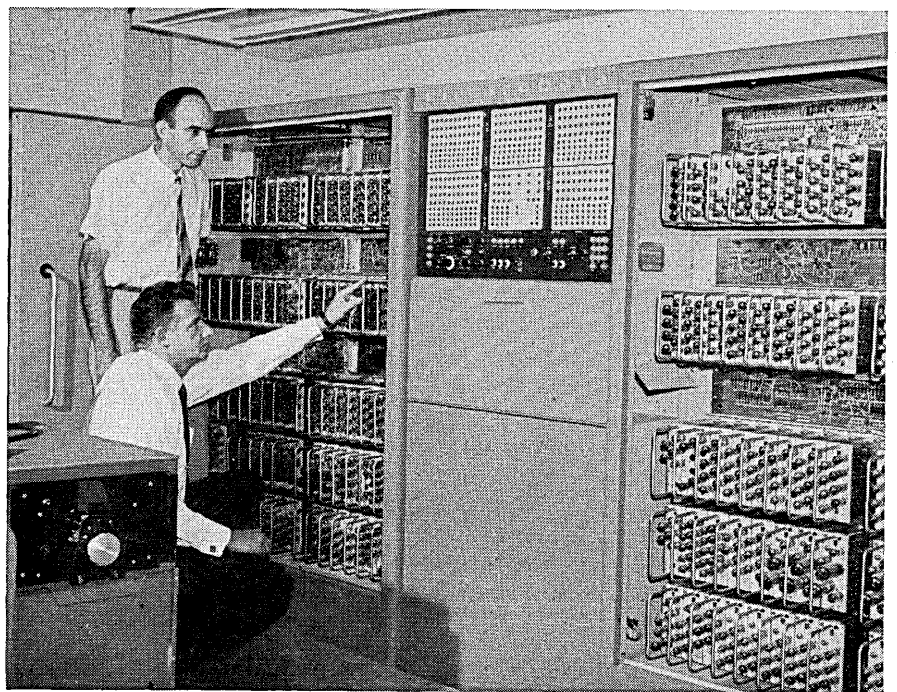

Circle 137 on Reader Service Card

## BOOK SERVICE

**Digital Computer Programming**, by D. D. McCracken (General Electric Co.), John Wiley & Sons, Inc., 440 Fourth Ave., New York City 16, 253 pp., illus., \$7.75.

This volume treats the down-to-earth details involved in actually working with digital computers. In clear and logical terms, it discusses many of the points that are especially troublesome to beginners, and builds a sound understanding of programming by means of a lucid presentation of its basic fundamentals. Its coverage is far more comprehensive than that provided by instruction manuals for specific computers, yet is on a more practical level than the broad surveys written primarily for non-users of computers.

To implement his approach, the author has devised a mythical computer combining elements from a number of different models currently on the market. Accordingly, the book is eminently suitable for use when there is no computer available for practice and demonstration.

**Automation in Business & Industry**, edited by Eugene M. Grabbe (The Ramo-Wooldridge Corp.), with 21 contributors, John Wiley & Sons, Inc., 440 Fourth Ave., N.Y.C. 16, 611 pp., illus., \$10.00.

Experts directly concerned with the subject show how feedback, control theory, instrumentation, analogue and digital computation, and data processing are becoming integrated as automation is applied on a broad scale to control systems. Emphasis is placed on new developments and applications.

**Office Work & Automation**, by Howard S. Levin (Consultant, Ebasco Services, Inc.), John Wiley & Sons, Inc., 440 Fourth Ave., New York City 16, 203 pp., illus., \$4.50.

Describes how recent developments in automation are bringing about a challenging reappraisal of the business office. The volume discusses integrated data processing electronic computers, and operations research. It explains basic concepts and provides a stimulating view of potentialities in this area.

**Introduction to Operations Research**, by C. West Churchman, Russell L. Ackoff & E. Leonard Aronoff (Case Institute of Technology), in collaboration with 11 other experts, John Wiley & Sons, Inc., 440 Fourth Ave., New York City 16, 645 pp., illus., \$12.00.

In a simple, straightforward manner this book (1) gives prospective consumers of O.R. a

sound basis for evaluating the field, and (2) provides future practitioners with a survey and a foundation upon which to plan future training. Cogent discussions are given of inventory, linear programming, waiting line, replacement, competitive, and other mathematical models useful in O.R.

**Electronic Data Processing for Business & Industry**, by Richard G. Canning (Canning, Sisson & Associates), John Wiley & Sons, Inc., 440 Fourth Ave., New York City 16, 322 pp., illus., \$7.00.

"It was by far the best, most experienced and most honest book on planning for electronics that I have come across. It's in layman's language. It can be the bible for your business electronics on a step-by-step basis. And speaking as a veteran of 30 major electronic and punch-card programs, I can say from personal experience: It works."—Wm. B. Worthington, National Director, Systems & Procedures Association.

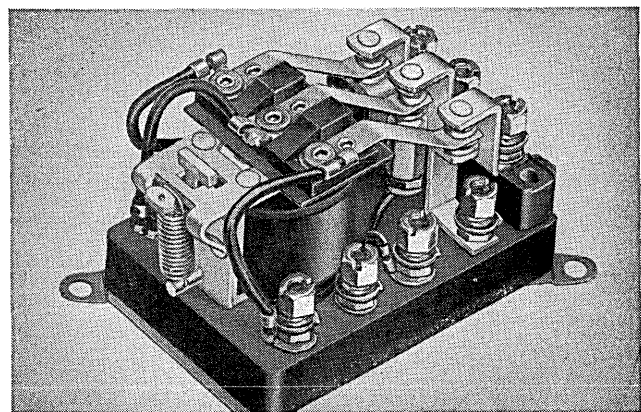

### Need a relay for AUTOMATION controls?

Whether it's for automation, traffic, elevator or instrument control, Ward Leonard's Bulletin 110 relays provide the millions of trouble-free operations required.

Our mechanical design, quality-controlled manufacturing methods and materials, and ample safety factors (both electrical and mechanical) insure this exceptionally long life.

Write today for Relay Bulletin 110. Ward Leonard Electric Co., 12 South St., Mount Vernon, N.Y.

4.11

**WARD LEONARD ELECTRIC CO.**

*Results-Engineered Controls Since 1892*

RHEOSTATS • RESISTORS • MOTOR CONTROLS • CHROMASTER



Circle 9 on Reader Service Card



New computer provides . . .

# Automatic Control for Industrial Process Plants

**D**evelopment of a new, advanced digital control computer which will provide fully automatic control for industrial process plants has been announced by The Ramo-Wooldridge Corp. of Los Angeles, Calif. Known as the *RW-300*, the new computer has been specifically designed to automatically control a variety of manufacturing processes, including chemical manufacturing, oil refining,

metals processing, and paper manufacturing.

Officials of the company's Computer Systems Division say that as a central unit of a process control system, the new computer can automatically read process instruments, perform the necessary computations to relate these readings to process objectives, determine the control actions that will result in optimum

plant operation, and activate process mechanisms or adjust set points on supervised control loops.

The new computer incorporates integral input-output buffering, selection, and analog-digital conversion equipment, allowing it to be connected directly to process instruments and control devices. It can accept inputs from practically any kind of process instrument. Input-output capacity can be adjusted to the requirements or processes of any degree of complexity.

One type of process control problem to which the new computer system is applicable is the control of the amounts of each of six different materials to be mixed together to form the input material to a chemical processing unit. Each of the six materials is a mixture made up of varying proportions of six compounds. Using the equations governing the chemical reactions, it is possible to write a set of six simultaneous equations with amounts of each of six materials as unknowns.

Because of the time variant nature of the composition of these materials, it is necessary to have frequent calculations of proper flow rates to obtain product uniformity. This can be done by solving the six simultaneous equations of the *RW-300* system, either utilizing automatic analyzing equipment or supplying the information from more conventional equipment.

The computations necessary in process control are only part of the problem if the system is to be automated sufficiently to minimize the possible human errors. Full use of



New digital control computer measures 55" in length, is 29" wide and 36" high, and weighs approximately 400 pounds.



Built on a modular basis, computer has active circuits mounted on inserts which are, in turn, attached to modules.

the new computer system would involve monitoring storage tank levels, feed temperatures, tank pressures, flow rates, valve positions, alarm conditions, and other items peculiar to the process to be controlled.

The program to solve six simultaneous equations, perform monitoring, and determine the necessary valve and tank input settings, requires about 3000 words of storage or less than half the memory space in the new computer system. Execution of this program takes about one and a half minutes. Thus, if the analyzing equipment could provide input data rapidly enough, it would be possible to correct flow rates of each raw material every minute and a half.

A highly flexible unit, the RW-300 is a stored program digital computer. By changes only in its instruction program and its external connections, its functions can be altered to (1) modify and improve its control actions as indicated by operating experience or as more input instruments become available; (2) change the control action from one process to another; (3) change from data logging to fully automatic on-line control; (4) change between control operation data logging, and scientific and engineering computations.

Small in size, the new computer is fully transistorized, and measures only 55" in overall length, by 29"

in width, and is 36" high. The control console is 29" high, or about standard desk height. The computer weighs approximately 400 pounds.

Ramo-Woodbridge scientists and engineers have carried out studies of the application of digital control systems to actual manufacturing processes of several companies. Economic analyses of the operation of specific control systems using the new computer have shown that their application to existing plants can produce tangible benefits that will return the investment in the control system within one to three years.

"In addition," Ramo-Woodbridge officials point out, "the improved control and automatic operation made possible by the RW-300 result in intangible benefits such as reduction in human errors and in plant upsets."

The new computer carries out a number of functions in automatic on-line process control. In input data interpretation, it does scaling, linearizing, and compensation for interferences. In computing, it can do maximizing, minimizing, averaging, correlating, smoothing, equation solving, interpolation, extrapolation, integration. In logical operations, it can start up and shut down process units, make comparison with standard conditions, and select material

flow paths. In checking and alarm operations, it makes instrument checks, process stability checks, and computer self checks. Data recording functions include process operation instructions and data logging.

When used as a data logger, the new computer converts the measurements of process instruments into digital numbers which are printed out to provide permanent records of process variables. The RW-300 provides the computational capability, flexibility, precision, and speed of a general purpose digital computer which can not only record data but also interpret and manipulate it.

The new computer may also be used as a tool by research laboratories in the process industries to explore the application of this new technology to new processes. At research centers, it can be shared among such duties as process design calculations, mass spectrometer and infrared analysis interpretations, data logging and interpretation for test equipment and pilot plants, and pilot plant control.

Because the RW-300 has been designed specifically for application to the process control industry, it will make available to this application the flexible, sophisticated computational and control ability necessary to implement integrated control systems.

*Circle 138 on Reader Service Card*

Computer is engineered for compactness. Modules are plugged into the sub-frame and subframes interconnected with cables. Magnet "memory" drum provides large storage capacity (about 800 words) and allows several programs to be stored.

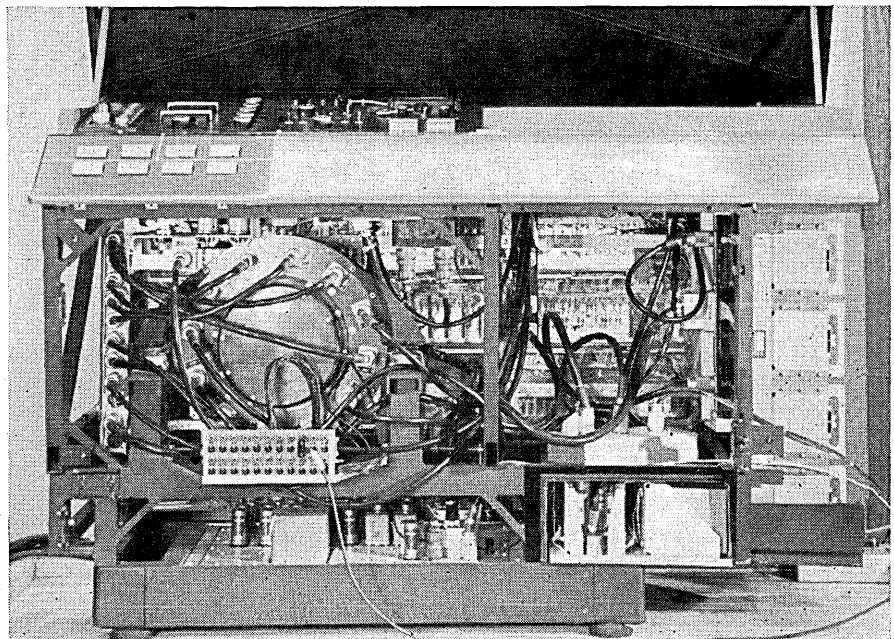

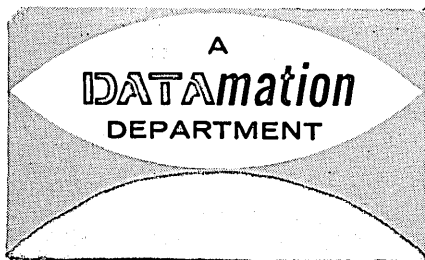

## NEW PRODUCTS

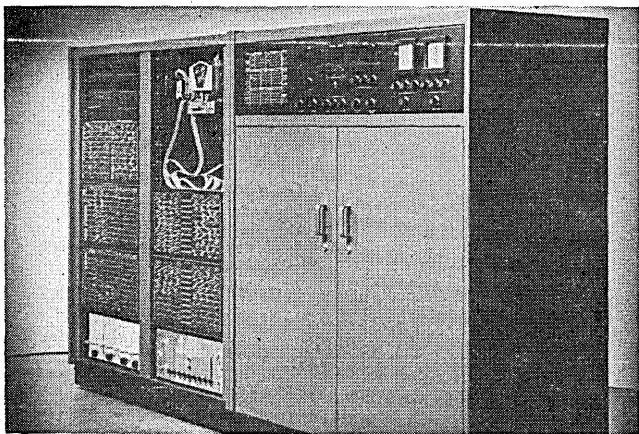

### 100-channel data processing system

Beckman Instruments, Inc., Systems Div., 325 N. Muller Ave., Anaheim, Calif., has announced a new, 100-channel Model 112 Data Processing System designed for continuous round-the-clock monitoring and control of a petroleum refinery re-former unit. Achieving maximum operating reliability through the use of all-transistor circuitry and magnetic amplifiers grouped in standard modules, the system will monitor inputs from thermocouples, pressure transducers, and flow meters.

Built-in computer mechanisms compensate flows for pressure, and a digital totalizer provides hourly and daily totals of material inputs. Designed for rapid scanning, computation, and identification of off-normal process variables, the system will make possible optimum plant control and provide precise operating data for accounting purposes.

*Circle 139 on Reader Service Card*

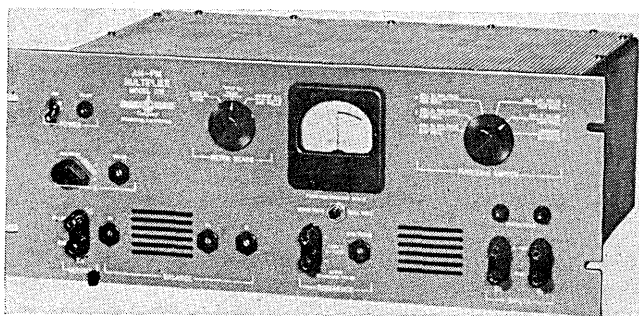

### Analog computer multiplier

Chadwick-Helmuth Co., 472 E. Duarte Rd., Monrovia, Calif., has announced a wide band, all-electronic analog computer multiplier designed for high accuracy and speed. The unit generates a voltage proportional to the

instantaneous product of two arbitrary input voltages from D.C. to 5 KC, with less than 5  $\mu$ sec delay. Accuracy is  $\pm 0.1\%$  of full scale over most of the band. After a short warmup, no adjustments are required for at least eight hours if accuracies of  $\pm 0.25\%$  are adequate.

Built-in metering system facilitates calibration and performance testing while unit is in use. Multiplication is accurate and dependable over long periods of time, since every active element is within a linear feed-back loop, and operation does not depend upon the non-linear characteristics of vacuum tubes or diodes. With no moving parts in the small and moderately-priced unit, multiplication is accomplished at high speeds and with precision.

The instrument operates with a 450KC carrier, which is phase-modulated and amplitude modulated by the two inputs to produce an output proportional to the product of these two modulating voltages. Modulation and demodulation is performed in diode-ring balanced modulators of special design to yield the required linearity, stability, and trouble-free operation.

*Circle 140 on Reader Service Card*

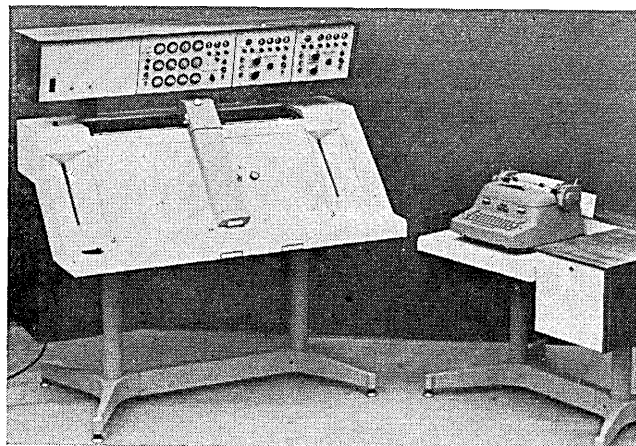

### Oscillogram reading device

Telecomputing Corp., 16217 Lindberg St., Van Nuys, Calif., has developed a new oscillogram reading device (the 099 DataReducer) which presents a new concept in data reduction. This new concept is essentially accomplished by a combination of operations and applications. Either linear or non-linear calibration is possible without overlays.

Curves may be quickly and accurately traced. Editing, notating, and reading are all possible over the entire area of the exposed record. X and Y motions are separately inhibitable. Opaque and translucent oscillograms can be read in a point-to-point operation. Data is pre-

pared for either plotting, typing, tape perforating, or card punching.

This equipment is incorporated into a desk-type console 54" wide and 59" high and constructed of walnut and formica panels on a metal frame. The 12" x 24" exposed reading area accommodates records 13" wide and a roll diameter of 6". Other technical specifications include a 40-400 count per inch resolution, total travel  $\pm 9999$  counts, and accurately calibrated to  $\pm 0.010$ ".

Circle 141 on Reader Service Card



### Electronic punched-tape typewriter

Remington Rand, Div. of Sperry Rand Corp., 315 Fourth Ave., New York City 10, has introduced a new electronic punched-tape typewriter that automatically creates and reads the paper tape that activates other equipment and wire communications systems. When used as an ordinary electric typewriter in preparing source documents, it automatically translates everything or selected data the typist writes into a punched tape for subsequent automatic processing; when fed the punched tape prepared by it or other machines, it automatically reads and types out the information at the rate of 120 words a minute.

The new machine can be adapted to various data processing programs with building-block flexibility, for it has been made available in three basic models: a tape punching unit, a tape reading unit, and a unit that does both, thus making it possible to arrange the equipment to the specific needs of each location in the overall data processing scheme. The new typewriter unifies remote work stations, speeds input and output to and from a centralized processing system, and brings true automation down to the level of basic source paperwork.

The new punched-tape typewriter is particularly significant where the smaller office is concerned, for it makes possible at minimum expense the big move to paperwork automation. A single typewriter, with punch and read units, might carry the full load of common language data processing in the small office. In the medium-size firm, a number of units may be used to handle the higher volume. Tapes punched automatically can be converted to punched cards for automatic tabulation of records, reports, and statistics, either on the premises or at a service bureau.

Large firms can establish continuous interoffice automation from the initial entry to tabulating or electronic data processing machines by means of punched-card or magnetic tape converters. At any stage of the

procedures, data can be automatically wire-transmitted to provide interoffice operational or data processing communication.

Circle 142 on Reader Service Card

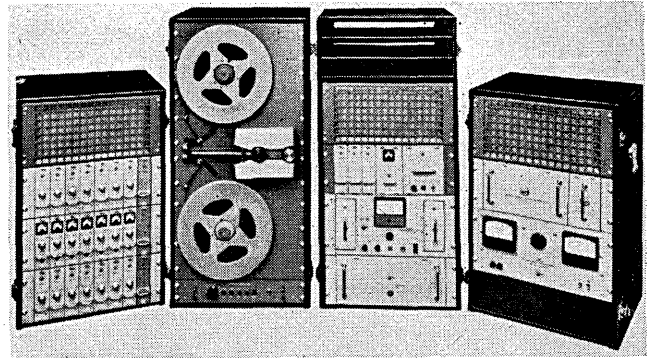

### Magnetic tape recording system

American Electronics, Inc., Recordata Div., 655 W. Washington Blvd., Los Angeles 15, Calif., has announced a new, portable 300 KC Bandwidth Recordata System. An exclusive feature of this multi-channel magnetic tape recording system is the selection, either remotely or from the front panel, of six speeds with appropriate equalization built-in to automatically compensate for each speed.

Proper speed and equalization from  $1\frac{7}{8}$  to 60" per second are obtained simply by turning the speed selector. The portable Series 3000 system accommodates reel sizes up to 14" as standard equipment, and may be ordered to utilize 19" reels. Continuous loop versions are also available. Tape tension is held constant within plus or minus  $\frac{1}{4}$  ounce from beginning to end of reel by a servo-system.

Packaged in four units, this system can be transported for field use. It is compatible with existing systems yet provides performance previously not considered possible.

Circle 143 on Reader Service Card

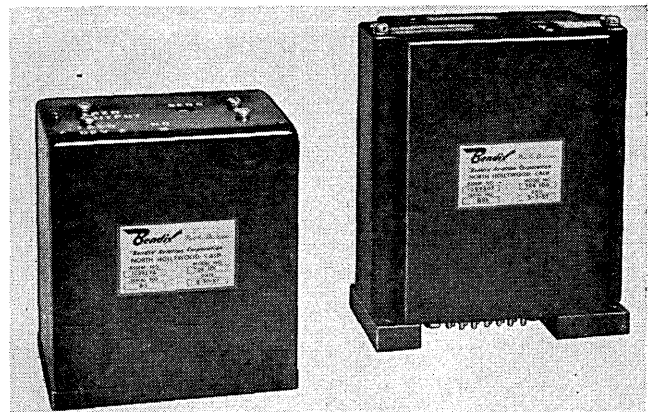

### Transistorized sub-carrier oscillators

Bendix Aviation Corp., Pacific Div., 11600 Sherman Way, N. Hollywood, Calif., is now offering a new line of transistorized sub-carrier oscillators for application in FM/FM telemetering systems. Two of the oscillator types (Models TOE-100 & TOE-101) are voltage controlled,

with the Model TOE-100 employing silicon transistors for high-temperature ranges, and Model TOE-101 utilizing germanium transistors for very-low-temperature applications.

Both are available for operation at any of the standard sub-carrier frequencies, and in a choice of input ranges. Proven advantages are vastly-improved stability, linearity, and resistance to severe environmental conditions.

The third type, Model TOR-100, is a silicon transistor resistance bridge sub-carrier oscillator with a configuration identical to that of the silicon transistor voltage controlled unit (Model TOE-101). It is used for the measurement of stresses where strain gage bridges are employed. TOR-100 is also used with strain gage transducers and for temperature measurements with resistant bridges as the temperature-sensing device.

Bridge excitation is supplied by the sub-carrier oscillator. The silicon oscillator units provide performance within specifications at temperatures to 85° C., while the germanium units operate over the range of -40° to +60° C. All units will withstand 25g vibration to 2,000 cycles per second. Total power requirements for any of the three basic types is less than 0.35 watt.

*Circle 144 on Reader Service Card*

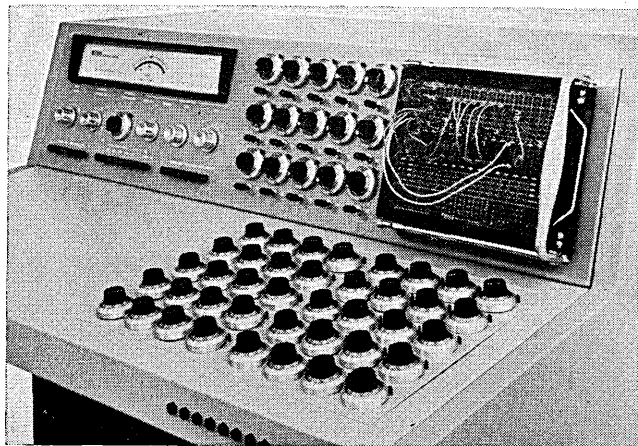

### Versatile analog computer

Donner Scientific Co., 888 Galindo St., Concord, Calif., has introduced a versatile, medium-sized computer in which 30 stabilized amplifiers, 40 coefficient potentiometers, a stable reference supply, and all associated circuitry are housed within a single, desk-type computing console. In addition, this linear computer has provisions for terminating a large variety of nonlinear and readout equipment.

Flexibility has also been designed into the modular cabinetry of the computing console. Plug-in, dual stabilized amplifiers and plug-in modules of coefficient potentiometers allow a tailored, modest initial investment to be readily expanded at some later date. The Donner Model 3100 can be obtained with 10 stabilized amplifiers and 20 coefficient potentiometers initially, and expanded to 30 stabilized amplifiers and 40 coefficient potentiometers.

The operational amplifiers have a DC gain in excess of 30 million. When connected as a unity inverter (1

megohm resistors), the maximum offset is less than 200 microvolts. When operated as a unity integrator (1 megohm and 1 microfarad), the maximum drift is less than 100 millivolts in 15 minutes. These features insure high accuracy over protracted computing intervals. In addition, accurate computation in **fast, repetitive operation** is obtainable due to the low value of amplifier phase shift at high frequency: as a unity inverter, the amplifier has less than 0.2 degrees of phase shift at 1,000 cps.

A generous amplifier output capability ( $\pm 100$  volts @  $\pm 10$  ma) provides large versatility in driving servo equipment or low-impedance recorders, and an enlarged linear output range at less than maximum load ( $\pm 140$  volts @ 5 ma) provides more freedom in problem scaling. To further insure exactness in problem solution, the reference power supply—which provides  $\pm 100$  volts for initial conditions, insertion of problem constants, and precise voltage measurement with the null voltmeter—is chopper stabilized and highly regulated.

*Circle 145 on Reader Service Card*

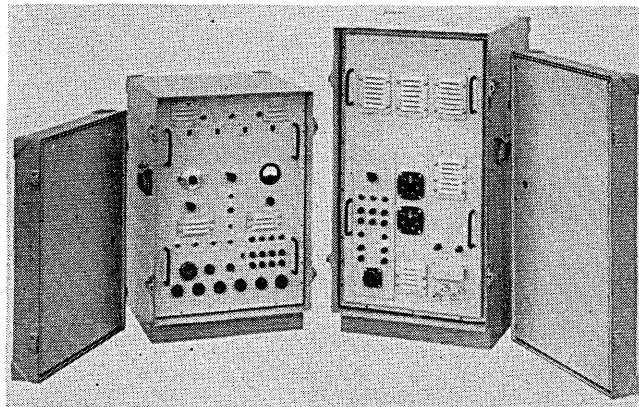

### Integrated air computer test set

Alto Scientific Co., 855 Commercial St., Palo Alto, Calif., has developed a new integrated air computer test set designed for either squadron or depot level use. The new test set includes a ratiometer simulator and pressure generator designed to establish an automatically-programmed sequence of inputs to the computer, and to compare the corresponding computer outputs to standard values on a go-no-go basis.

The program automatically stops when out-of-tolerance output is found. Panel indication of faulty outputs is given. The computer inputs established are 5 voltages within  $\pm 0.1\%$  and 8 air pressures (corresponding to pitot total and static) within approximately  $\pm 0.1$  mm Hg. The automatic program checks 10 points on the flight envelope. Altogether 214 computer output voltages are checked. The entire set is designed to meet MIL-E-5400 and MIL-T-945A.

Other important features of the set include: the servo-driven air system which allows pressures of high accuracy to be generated within less than 60 seconds regardless of ambient conditions, and versatile circuitry including plug-in precision voltage dividers which allow great flexibility in establishing test points. Both the number and position of test points can be varied to suit different aircraft computers.

*Circle 146 on Reader Service Card*



## Miniature computer

Codetyper Laboratories, 1027 Casa Vista Dr., Pomona, Calif., has announced a new, low-cost Model EBC3 Codetyper that will automatically key a radio transmitter as any of the keys on the typewriter-like keyboard are touched. No trained operator is needed in an emergency.

Speed is continually adjustable from 10 to 75 wpm. Containing only 12 miniature tubes, the unit is smaller and lighter than a portable typewriter. The output is simply clipped across the normally-used transmitting key making for convenient, quick hookup.

Keying relay and power supply are self-contained and allow operation on AC or DC. The complete circuit is printed including the keyboard switches. Built-in Monitor allows audible signals to be heard as the instrument is operated. The Codetyper makes machine-perfect code and is also useful in teaching code reading.

Circle 147 on Reader Service Card



## Unity ratiometer

Servonics, Inc., Alexandria, Va., announces the addition of a new product, the Unity Ratiometer, especially designed for ease of operation and simplicity of readout. This simple, high-speed readout is enhanced by

the automatic polarity indicator which gives an average of  $1\frac{1}{2}$  seconds per reading, with high accuracy.

The output shaft extension in this device has many uses, including the mounting of shaft encoders, output potentiometers, and other rotary transmitting devices. It is scaled 10 revolutions full scale with an output torque of 5 oz.-in.

There are two models of this ratiometer, the UV-100 and the RV-1. The UV-100 has an accuracy of .05% full scale with an input resistance of 10 meg-ohms. The unit is chopper stabilized. The power requirements for this model are 115 volts  $\pm 10\%$  60 cps at 40 watts, with a reference voltage of  $\pm 100$  volts at 2 mils. This model is adjustable to function with reference as low as  $\pm 1$  volt.

The RV-1, with an accuracy of 0.1%, has a self-contained reference of 0.01 V (10 milli-volt) full scale. This model has an input resistance of 2 meg-ohms, which is infinite at null. Its power requirements are 115 volts  $\pm 10\%$  60 cps at 45 watts.

Circle 148 on Reader Service Card

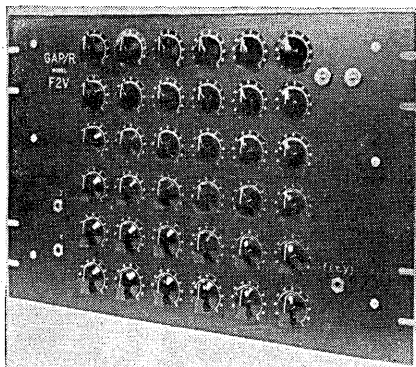

## Analog computing component

George A. Philbrick Researches, Inc., 230 Congress St., Boston 10, Mass., has announced the latest addition to their expanding line of non-linear computing components: the Function of Two Variables, Model F2V, that provides an output voltage which is an arbitrary function of two independent varying input voltages.

A family of curves is produced with smooth interpolation in both directions. This surface may be visualized as a tent with 36 poles where the height of each pole is individually adjustable between  $\pm 50$  volts. This new computing component fills a long felt need for an instrument

capable of providing instantaneous solutions for problems in data reduction and computing involving functions of two variables.

Extensions of the principles invoked make possible functions of 3 or more variables. Specifications include: Input Range:  $x = 0$  to  $+ 50$  volts,  $y = 0$  to  $+ 50$  volts; Output Range:  $- 50$  to  $+ 50$  volts, Impedance: less than one ohm, Allowable Load Impedance: 30K minimum; Power Requirements: 300 vdc at 150 ma, 115 vac 50-60 cps or 150 watts; Mounting Standard—rack mounted; Dimensions: 19" lg x  $8\frac{1}{8}$ " h x 16" deep.

Circle 149 on Reader Service Card

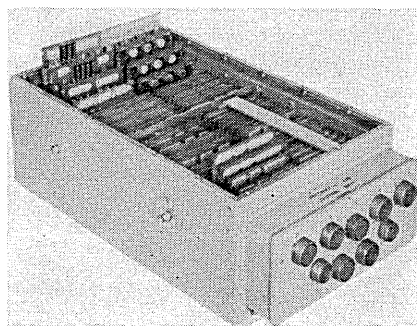

## Airborne computer

Philco Corp., 4700 Wissahickon Ave., Philadelphia 44, Pa., has announced delivery of its first high-speed Transistor Automatic Computer (known as the TRANSAC C-1100) to the U. S. Navy. The Navy is now in the process of installing the unit in one of its jet fighters. The computer is designed to handle all computational problems encountered in the control of military aircraft while in flight.

The advent of Philco's surface barrier transistors (SBT) proved to be the first significant step forward in the production of transportable high-speed data processing systems. This high-speed, high-frequency transistor is particularly adapted to switching circuits.

Miniature printed circuit cards, with their tiny transistors, are the heart of the airborne computer. The cards contain all of the elements for arithmetic and control functions, and require less power than a 25-watt light bulb. The unit also has a transistor-driver core memory for fast access as well as a drum memory for long-term storage.

Circle 150 on Reader Service Card

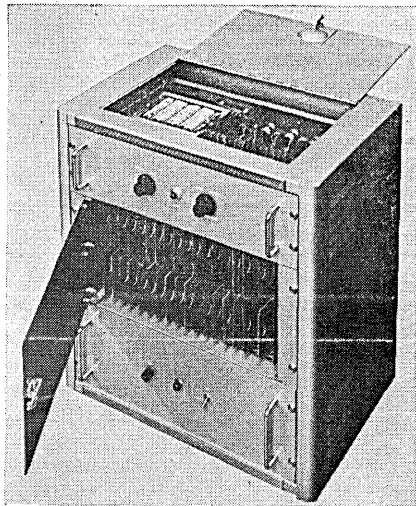

### Buffer storage unit

Telemeter Magnetics, Inc., 2245 Pontius Ave., Los Angeles 64, Calif., has announced a new coincident-current magnetic core storage unit that can be used as a temporary store, buffer, or delay time unit in data processing, computing, and automation systems.

Known as the Type 1092-BQ-S Buffer Storage Unit, each of the 1,092 characters has a capacity of eight binary digits in length. The storage unit is completely transistorized.

Circle 151 on Reader Service Card

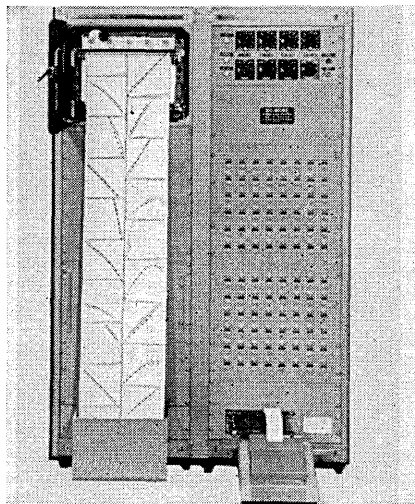

### Autographic plotter

Gilmore Industries, Inc., 5713 Euclid Ave., Cleveland 3, Ohio, has announced an autographic plotter, Model 114, for digital readout operating simultaneously with graphic plotting. A digital converter can be driven in tandem with the graphic plotter to operate a tape punch, card

punch, electric typewriter, or printer.

Model 114 is a multi-channel recording and plotting instrument for use with strain gage, thermocouple, or millivolt inputs. It automatically receives and plots each channel on an individual graph so that test personnel can quickly evaluate results "on-the-spot" while the test is actually in progress.

The autographic plotter is available in 24, 48, or 96 channel models.

Circle 152 on Reader Service Card

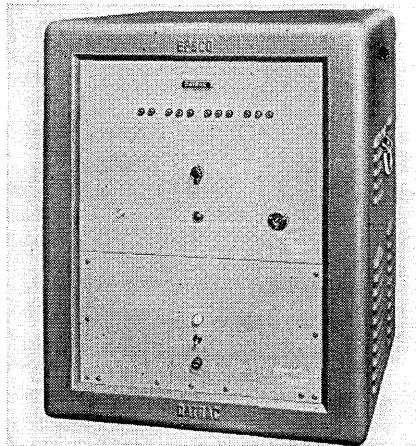

### Voltage-to-digital converter

Epsco, Inc., 588 Commonwealth Ave., Boston 15, Mass., has announced a high-speed, high-accuracy, voltage-to-digital converter (known as the Dattrac) that is designed for use in telemetering, data processing, instrumentation, and automatic control facilities.

In addition to the capability of converting unknown input voltages to digital codes at high speed and at precisely known times, the Dattrac can be operated as a digital-to-voltage converter—digital codes are applied as inputs and proportional voltages obtained as outputs.

There are two basic Dattrac models—the B-611 and the B-613. The former is designed for an 11-bit straight binary code; the latter for 13-bit binary-coded decimal notation, either 8-4-2-1 or 4-2-2-1. The times required for complete voltage-to-digital conversions are 22 and 26 microseconds in the B-611 and B-613 respectively.

These speeds make possible approximately 44,000 and 37,000 independent voltage-to-digital conversions per second. The same repetition rates are achievable when operating

in the digital-to-voltage direction.

The voltage-to-digital conversion accuracy of both models is better than  $\pm 0.05\% \pm \frac{1}{2}$  the least significant binary digit; the digital-to-voltage conversion accuracy of both is within  $\pm 0.05\%$ .

Circle 153 on Reader Service Card



### Wideband DC amplifier

KinTel Div. of Cohu Electronics, Inc., 5725 Kearny Villa Rd., San Diego 12, Calif., announces Model 111BF wideband DC amplifiers that utilize KinTel's chopper circuit to provide extremely stable and accurate amplification of microvolt-level signals from strain gages, thermocouples, and other types of transducers used to measure dynamic physical phenomena.

The amplifiers can be used to drive strip recorders, wideband oscilloscopes, voltage-controlled oscillators, recording galvanometers, tape recorders, chemical or industrial process control elements, computers, and many other types of indicating and recording instruments.

Features include: less than 2 microvolts drift; less than 5 microvolts noise  $\pm 35$  V,  $\pm 40$  ma output; DC to 40 kc bandwidth; 10,000 ohm input impedance; low output impedance; integral power supply; 10, accurate gain settings from zero to 1,000 with continuous variation between ranges by means of a potentiometer; and 1.0 microfarad maximum output cable capacity to permit driving long output cables.

The Model 111BF amplifiers may be obtained in a 6-amplifier module which fits standard 19" racks, or in a single-amplifier cabinet. KinTel can supply packaged "plug-in" DC instrumentation systems utilizing these amplifiers.

Circle 154 on Reader Service Card

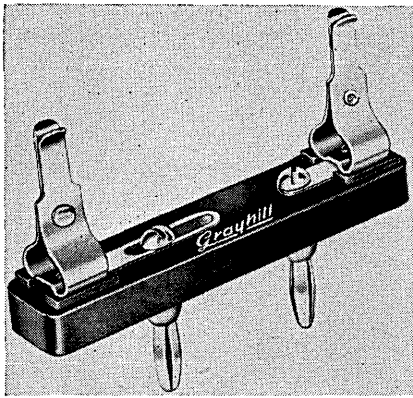

### Adjustable test clip adapter

Grayhill, Inc., 561 Hillgrove Ave., LaGrange, Ill., has placed on the market a universal test clip adapter to fit all banana-type jacks. Known as the Grayhill 2-7 test clip adapter, it features spring-tension test clips on top for simplified testing of resistors, capacitors, germanium diodes, and similar lead wire type components.

Adjustable banana jacks underneath may be adjusted to satisfy any banana plug spacing from standard  $\frac{3}{4}$ " centers to  $1\frac{1}{4}$ " centers. Nickel plated spring clips insure positive contact every time. The base is of electrical grade molded phenolic.

Circle 155 on Reader Service Card

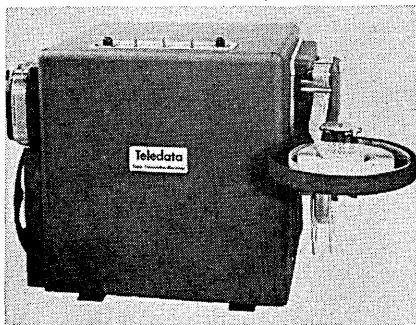

### Data transmitter-receiver

Friden Calculating Machine Co., San Leandro, Calif., has announced a new, long-range data transmitter-receiver for communicating data encoded in punched paper tape over existing wire services.

Designated the Friden Teledata, the new machine is capable of transmitting and receiving 5-, 6-, 7-, and 8-channel tape. Two or more units are stationed at different locations providing a means for immediate communications.

Teledata machines have a tape

reader and a punch. The reader, located at the right of the unit, is in operation when sending or transmitting information. The punch, on the left, is in operation when receiving information.

As data in punched tape is transmitted through the reader of the machine, it is simultaneously reperfected and checked on the punch of the Teledata placed at a distant location. The tapes are then used to actuate other equipment to produce automatically such documents as sales orders, invoices, and production orders, or tabulating cards for statistical reports.

Two of the most common types of connections between Teledata stations are the full-duplex connection and the half-duplex connection. The full-duplex arrangement allows each Teledata to transmit information at the same time. In half-duplex operation, data may be transmitted in either direction but in only one direction at a time.

Circle 156 on Reader Service Card

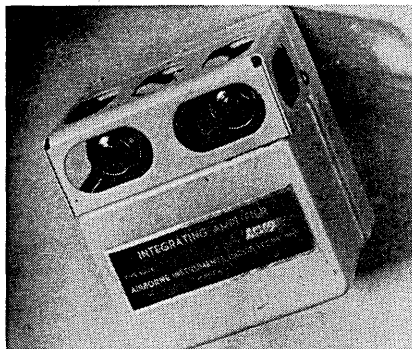

### Integrating amplifier

Airborne Instruments Laboratory, Inc., 160 Old Country Rd., Mineola, N. Y., has announced a new, 4-tube electronic integrator (known as the AIL Type 40) that can be used in computers and other electronic devices to integrate video, narrow pulses or intermittently sampled data, and to provide long-term memory of integrated input information.

Numerous circuit points of the amplifier are available at the terminals, increasing the versatility of the unit. Critical circuits are hermetically sealed, and all components are selected for accuracy and long life.

Input to the storage capacitors (0.01, 0.04 or 0.05  $\mu$ f) can be made directly through a 1750-megohm resistor, disconnecting diodes, or a

built-in relay, or indirectly by using the internal 5.1-megohm resistor and one or more external summing resistors in conjunction with the relay.

Output current is 1 ma maximum at any output voltage from -100 to +100 volts, 5 ma maximum from -50 to +50 volts.

Circle 157 on Reader Service Card

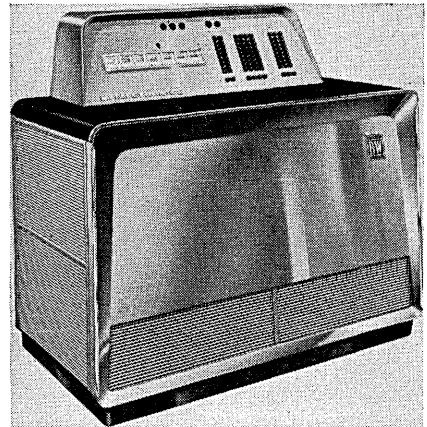

### Digital data system

BJ Electronics, Borg-Warner Corp., 3300 Newport Blvd., Santa Ana, Calif., has introduced a new digital data processing and recording system, known as the S-100, that is capable of sampling inputs from one to 100 vibroton digital transducers at rates of up to 100 per second. Measurement input is delivered as directly-digital information, either sequentially or upon demand.

Etched circuitry is employed throughout the component groups with plug-in type fabrication used to facilitate system maintenance with minimum operating interruptions. Pressure variations are measured by vibroton pressure transducers. Temperature data and inputs from other measurement instrumentation are also accepted by the system.

Measurement data received are transferred to the storage register until demanded by a data recording system. Information from the buffer storage register may be programmed by the system operator and routed to the appropriate output equipment.

System outputs include visual readout, tabulations, punched cards, tape, and other output media. Output provisions for process monitoring and control may also be incorporated. Power requirements: 115v, 60 cycle.

Circle 158 on Reader Service Card



## Indicator lamps

Circon Component Corp., Santa Barbara Airport, Goleta, Calif., has announced production availability of the Litestrip, a new idea in indicator lamp assemblies.

Essentially a preassembled and pre-tested strip of 10 indicator lamps bearing numerals from zero to nine, the unit thus forms a complete decade ready for assembly into computers, annunciators, matrix and read-out applications at a cost of less than that of installing individual lamps.

A standard decade Litestrip is only  $\frac{1}{2}$ " x 1" x 6". Special variations of numbers, lens colors, direction of read-out and dimensions are available. The units are available with incandescent lamps for operation on voltages of 1.3 to 28, and with the new NE2C subminiature neon lamp for operation on higher voltages.

Integral series resistors are available in each lamp if desired. When used with the NE2C subminiature neon lamp, Litestrip consumption is infinitesimal in normal use at only 0.04 watts. Current drawn is extremely low at 0.0003 amperes. All lamps are replaceable.

Circle 159 on Reader Service Card

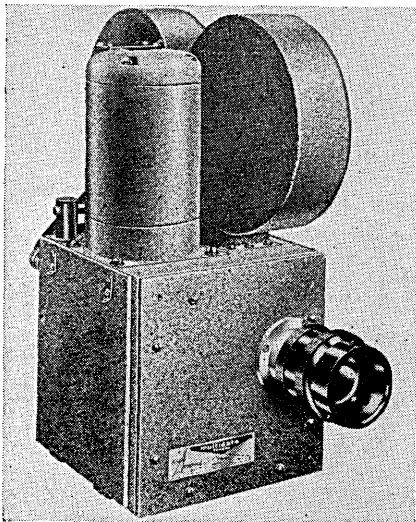

## Missile-tracking camera

Flight Research, Inc., P. O. Box 1-F, Richmond 1, Va., has announced a new 70mm camera specifically designed for missile tracking. Known as the Multidata MOD V, the 70mm camera provides a photographic record of missile flight with greater de-

tail than possible with smaller film size cameras.

The large frame of 70mm film— $2\frac{1}{4}$ " square—minimizes tracking error and helps keep high-speed, elusive missiles in sight. Another advantage of 70mm is greater magnification enabling more detailed study of fin flutter, attitude, exhaust nozzle characteristics and exhaust patterns, and other component features.

Two neon lights provide visible coding on both edges of the film for time base correlation. Four lighted fiducial markers indicate the aperture centerlines to within 0.001". The shutter is adjustable from 0° to 120°.

MOD V specifications include an automatic output pulse at the center of exposure at any shutter opening, and a removable front plate for changing lenses.

Circle 160 on Reader Service Card

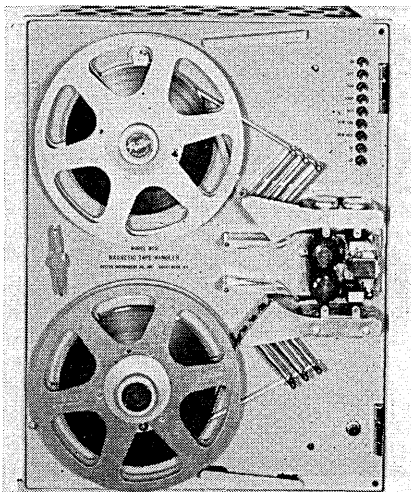

## Magnetic tape handler

Potter Instrument Co., Sunnyside Blvd., Plainview, N. Y., has announced a new series of digital magnetic tape handlers. Features of the Model 905 series include tape speeds up to 75" per second with 3 millisecond starts and stops. Any tape width up to  $1\frac{1}{4}$ " may be used.

Other new features include fast rewind in both forward and reverse directions, dual speeds in the ratio of four-to-one with high speeds up to 75" per second, transparent dust cover, quick threading, and rack mounting.

The transport mechanism is mounted on a hinged panel which provides immediate access to all mechanical parts and tubes. A hinged

rear door provides access to all wiring connections and the remote control terminal strip.

The Model 905 is automatically stopped when the end of a reel of tape approaches, when line voltage fails or drops below a prescribed minimum, or in the event of a tape failure. All machine functions, including on, off, forward, stop, reverse, forward rewind, reverse rewind, high speed and low speed may be controlled by conveniently grouped front-panel pushbuttons or by remote contact closures or pulses.

Multiple-channel record-playback heads and amplifiers for recording and playing back from 2 to 14 channels of information are available as optional equipment.

Circle 161 on Reader Service Card

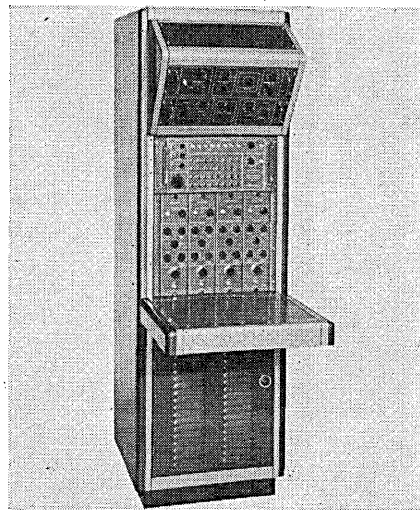

## Pulse generator

American Electronic Laboratories, Inc., 121 N. 7th St., Philadelphia, Pa., has announced the "138" pulse generator which produces pulses over the range of one microsecond to one second—singly, recurrently, single pairs, recurrent pairs, single trains, and recurrent trains.

The output is reversible and supplies 35 volts into 50 ohms. It is believed the instrument will be useful to those engaged in the fields of sonar, digital computers, acoustics, countermeasures, geophysics, analog computers, and radar.

Repetition frequencies from less than one cps to 250 kc/s are available internally. The instrument will follow external sync anywhere in this range aperiodically or periodically.

Circle 162 on Reader Service Card

## Magnetic tape handling unit

Remington Rand Div. of Sperry Rand Corp., 315 Fourth Ave., New York City 10, has announced a new type of magnetic tape handling unit—the Automatic Tape Unit—with built-in controls. Designed especially for the Univac File-Computer System, the new unit can make its own comparisons and its own logical decisions because of its self-controlling features.

Once given the proper instruction, the unit searches a tape, automatically, to find data that the computer needs, while the computer goes about other jobs. Each unit is equipped with its own independent core memory, comparison register, and program plugboard. Up to ten of these units can be operated simultaneously, each programmed for its own individual role in the data processing flow.

To search the tape, all the central computer does is tell the Automatic Tape Unit what facts it wants by giving it an "identifier" for the part, employee, shop schedule, or other information desired. Then the computer goes about other work while the unit searches the tape, backwards or forwards.

While the computer is busy on unrelated work, the new unit can sort tape data in any desired alphanumeric sequence, either ascending

or descending. Unique with the Tape Unit is its ability to take advantage of "ordered strings"—groups of items already in order—to substantially cut sorting time.

Circle 163 on Reader Service Card

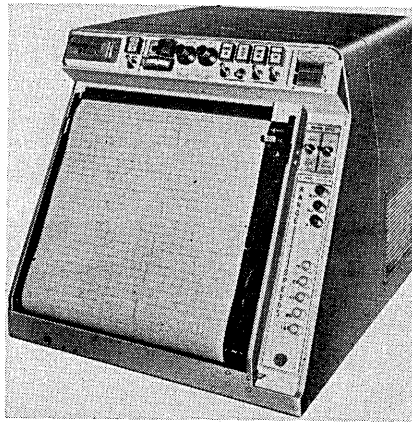

## Visicorder oscillograph

Heiland Div., Minneapolis-Honeywell, 5200 E. Evans Ave., Denver 22, Colo., has announced a new direct-recorder, known as the Model 1012 Visicorder, specifically designed to take advantage of the proven superiorities of the new visicorder principle.

The 1012 fits the most demanding applications where up to 36 channels of high sensitivity, high-frequency information are needed, and is also valuable where variables need to

be monitored at the instant they are being recorded.

The 1012 records directly on paper which requires no powder, magazine, liquids, vapors, or other processing. It records immediately visible and usable. Recording is accomplished in full view of the operator.

Circle 164 on Reader Service Card

## Pushbutton switch

Grayhill, Inc., 561 Hillgrove Ave., LaGrange, Ill., has designed and developed a new pushbutton switch for use on the Remington Rand Univac file computer. Known as the 34 Series, the switch is used with a matching indicating light to test conditions in the computer.

All logic "flip flop" circuits are monitored by the technical operator to check the operation of each printed circuit card. This non-snap, normally open, momentary contact switch is designed for taper pin solderless wiring.

Three female receptacles, provided with a built-in short between two points, accommodate in and out wiring with A-MP No. 53 taper pins. The 34 Series is currently available with red or black buttons; however, other colors are available on special order.

Circle 165 on Reader Service Card

# Index of Advertisers

Amphenol Electronics Corp. -----	Cover II	R/E, The Magazine of DATAtion -----	12
<i>Agency: Burton Browne Advtg.</i>			
Anaconda Wire & Cable Co. -----	Cover IV	Syntronic Instruments, Inc. -----	8
<i>Agency: Kenyon &amp; Eckhardt, Inc.</i>		<i>Agency: Burton Browne Advtg.</i>	
Grayhill, Inc. -----	35	Tektronix, Inc. -----	4
<i>Agency: Merchandising Advertisers, Inc.</i>		<i>Agency: Hugh Dwight Advtg.</i>	
Narda Ultrasonics Corp. -----	6	Triplett Electrical Instrument Co. -----	Cover III
		<i>Agency: Burton Browne Advtg.</i>	
John Oster Mfg. Co., Avionic Div. -----	2	Ward Leonard Electric Co. -----	38
<i>Agency: Burton Browne Advtg.</i>		<i>Agency: James Thomas Chirurg Co.</i>	
Perfection Mica Co. -----	9	Carl Zeiss, Inc. -----	25
<i>Agency: Burton Browne Advtg.</i>			

# TRIPLETT

## Reliability... through 15,631 accepted types

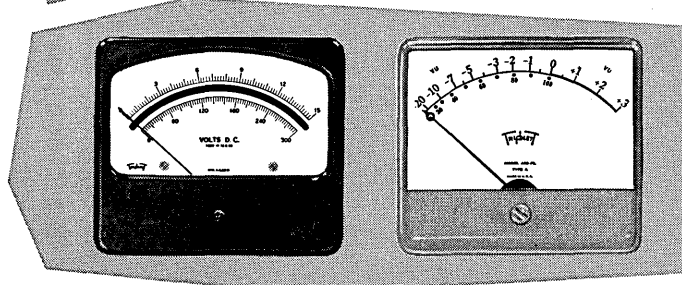
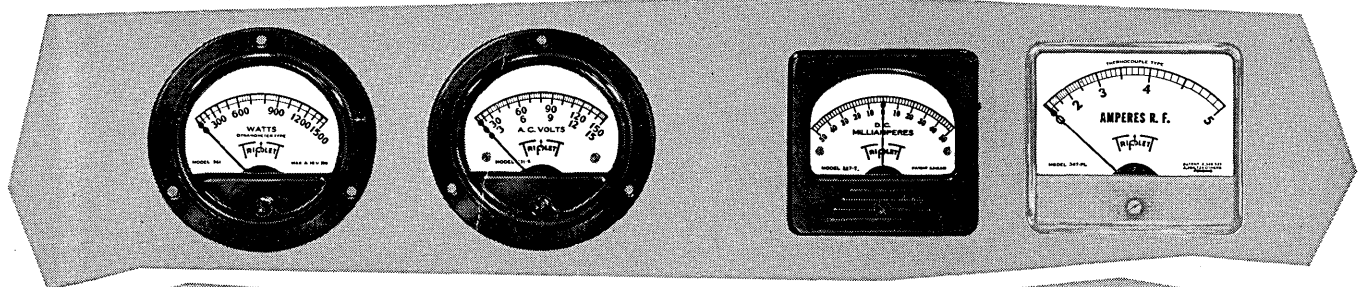
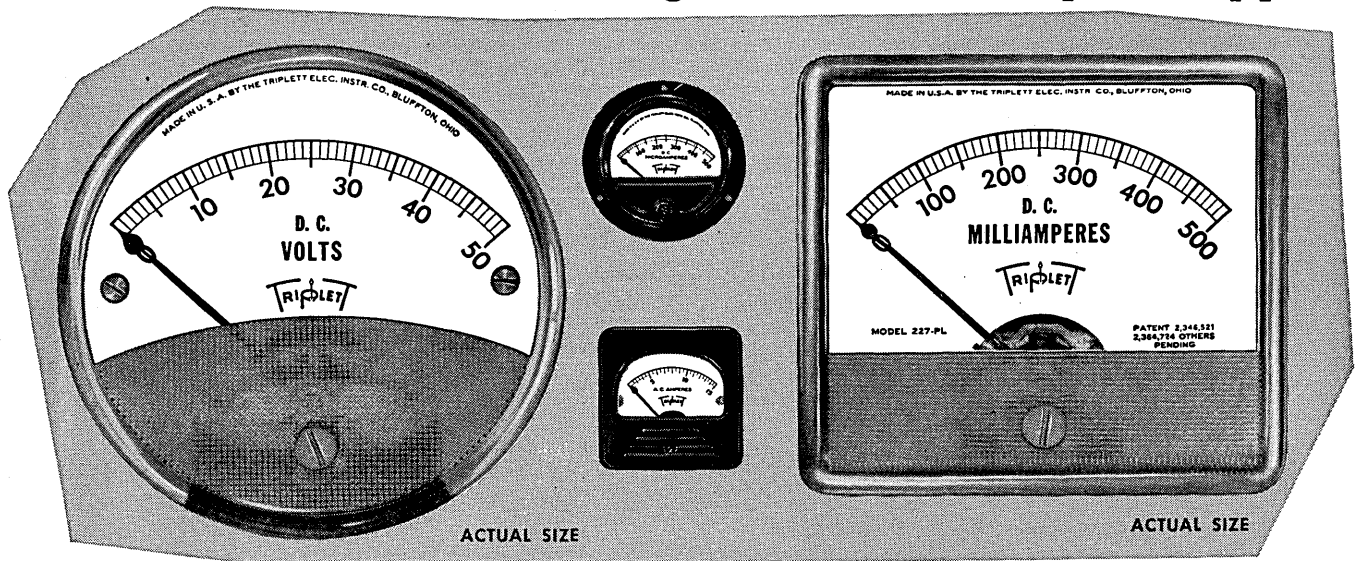

Clear plastic (PL) meters feature;

- Longer scale length
- Visibility unlimited
- Light unobstructed—no shadows
- Interchangeability—universal
- Appearance revolutionized

## UNIQUE FEATURES AND CHARACTERISTICS

These guarantee superior quality in *all* TRIPLETT meters:

- High torque to weight ratio for extra rugged movement. Specially developed bearings withstand severe vibration and reduce friction to a minimum.
- Bearings are microscopically graded not only for depth and radius, but also for *polish*. Only best quality jewels are used.
- Unique hardening method assures uniformly hard pivots.
- High flux scientifically aged alnico magnets for greatest permeability. Micrometrically balanced all metal frame construction protects bearings against vibration from any direction.
- Simplicity of frame construction assures easy, accurate alignment in servicing.
- Dials are all metal—no paper dials are ever used—will not become abrasive, warp, crack or discolor under normal conditions. (Printing presses in Triplet's own plant allow fast, inexpensive service on special dial requirements.)
- Extra strong ribbed pointers precisely balanced with triple "slide and lock" adjusting weights.
- Insulations provide extra allowance for breakdown voltages.
- All metal parts processed, all molded parts pre-cured to eliminate distortions from stresses and strains.

BURTON BROWNE ADVERTISING

**TRIPLETT ELECTRICAL INSTRUMENT COMPANY • 52 years of experience • BLUFFTON, OHIO**

*Triplet design and development facilities are available for your special requirements for meters and test equipment.*

Circle 10 on Reader Service Card



# ANATHERM

**Now—the first 155°C (Class F) polyester film-coated magnet wire designed to meet new AIEE requirements**

*Another Anaconda first!* Anatherm—a new polyester film-coated magnet wire—fully tested for use at “hottest-spot” temperatures up to 155°C. With this new higher level of thermal stability, Anaconda Anatherm is the first film-coated wire to meet the newly adopted AIEE 155°C (Class F) rating!

Greater thermal stability—plus excellent abrasion-resistance characteristics, chemical stability and dielectric strength—makes Anatherm ideally suited for manufacturers seeking maximum performance and reliability from smaller and smaller equipment operating at higher and higher temperatures.

As a polyester magnet wire, Anatherm can be used equally successfully at any hottest-spot temperature over the range of 105°C to 155°C.

Available in single and heavy film thickness in AWG sizes from 15 through 25.

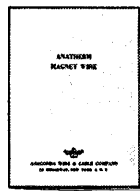

FREE TECHNICAL BULLETIN on Anatherm Magnet Wire is available. Simply write: Anaconda Wire & Cable Company, 25 Broadway, New York 4, New York. 57374



ASK THE MAN FROM **ANA CONDA**<sup>®</sup>  
**ABOUT ANATHERM MAGNET WIRE**

Circle 11 on Reader Service Card