

# DATA MATRITION

59

September / October

Edmund F Klein, Proj Engr  
Natl Cash Reg  
Electronics Div  
1401 E El Segundo  
Southorne, Calif

AN F. D. THOMPSON PUBLICATION

page 8 THIN MAGNETIC FILMS  
FOR COMPUTER APPLICATIONS

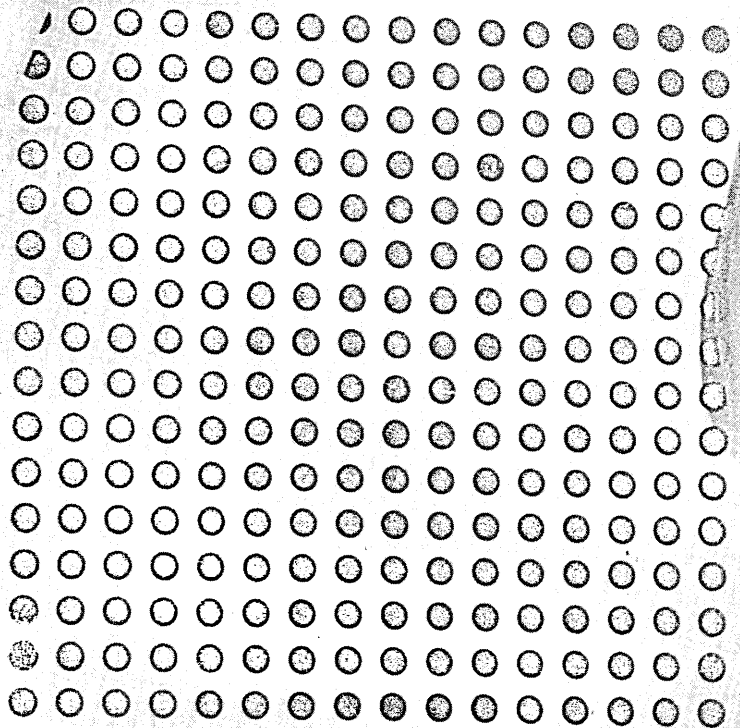

PHYS

TELEMETRY MAGNETICS  
SERIES 1000 #  
STATISTICS 10000

TELEMETRY MAGNETICS

MEMORY CORE

WAS THROWN

FROM THE TOP OF THE

LEANING TOWER OF PISA

INTO

A CATCHER'S MOUTH

*with almost*

STATISTICS 10000

*with one*

*range of capacities from 128 to 1024 words of from 4 to 24 bits per word. Larger storage capacities available by combining units. Solid state active elements are utilized throughout. TYPE RB operate reliably over a wide temperature range and are unaffected by humidity. In addition, the TYPE RB units cost less and do more!*

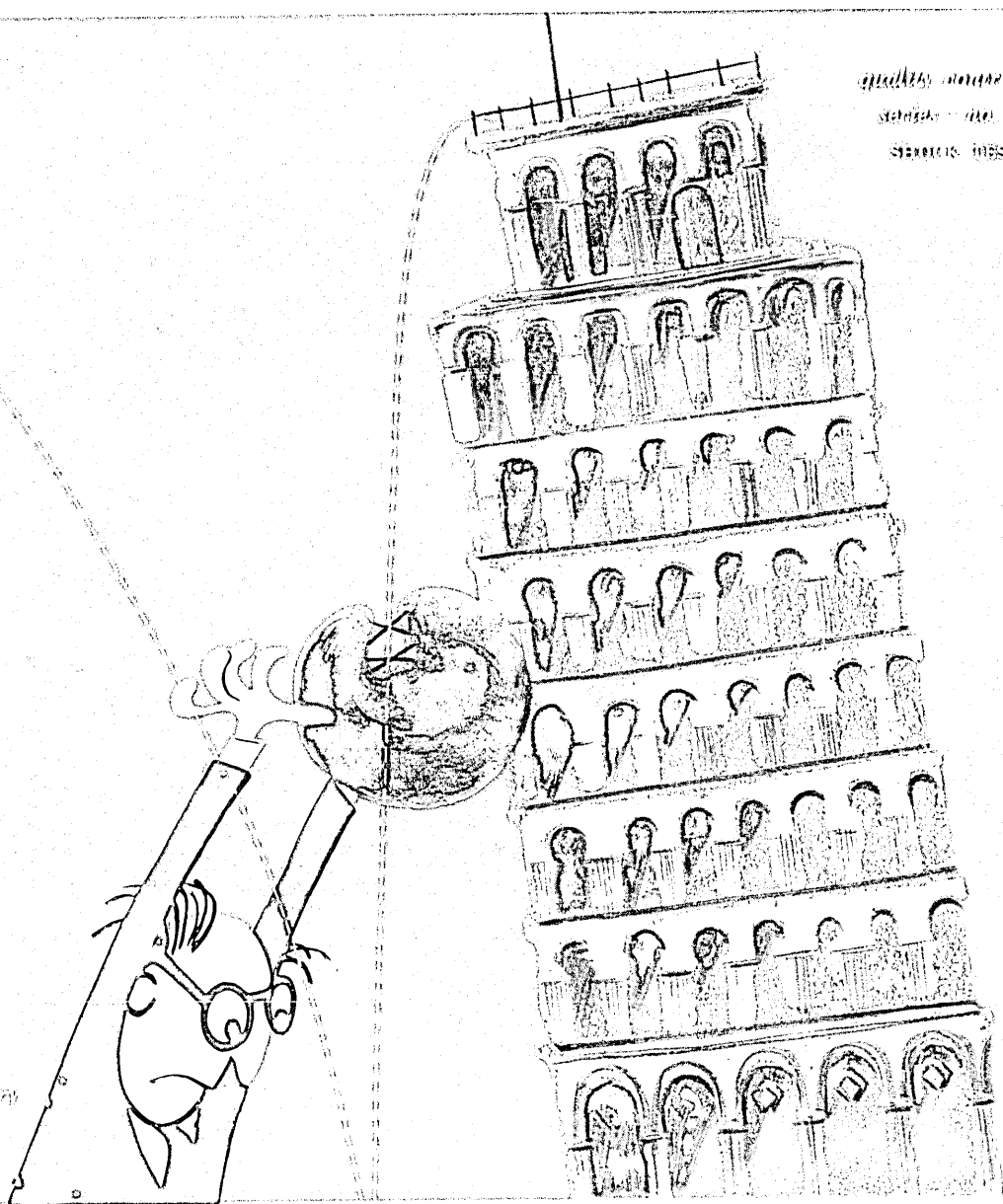

## NEW – versatile TYPE RB random access core memory features an unlimited application range!

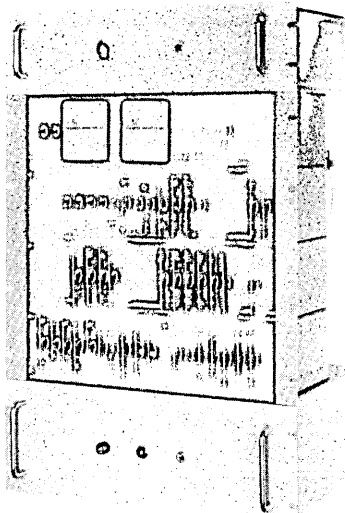

Type RB  
memory

TMI presents a new memory unit for any application requiring intermediate high speed storage and flexible input/output capabilities...TYPE RB memories feature addressable random access, sequential load and unload, or a combination of both as desired. Important new characteristics include 10 microsecond cycle time for complete read/write operation — 5 microsecond load and 5 microsecond unload when used as sequential buffer — information input and output may be either pulses or levels. These flexible units may be applied as random access memories or sequential load and unload buffers for —

- Data editing and format revision...
- Multiplexing of data from several sources...
- Random access storage with scanned sequential output...
- Sequential load with random output selection...

The versatile TYPE RB memories are designed and engineered for speed and reliability with a wide range of capacities from 128 to 1024 words of from 4 to 24 bits per word. Larger storage capacities available by combining units. Solid state active elements are utilized throughout. TYPE RB operate reliably over a wide temperature range and are unaffected by humidity. In addition, the TYPE RB units cost less and do more!

For more information, write today. One of our engineers will be glad to discuss your application.

Circle 1 on Reader Service Card.

### IMPORTANT JOB OPPORTUNITIES

Expansion to handle our increasing business activity plus research and development in new areas have created openings for qualified computer engineers. Investigate the wonderful opportunities offered by TMI in Southern California

TELEMETRY MAGNETICS Inc.  
245 North Main, Los Angeles, California • 316 48th St., New Washington, D.C.  
PIONEERS IN DEVELOPMENT AND MANUFACTURE OF ELECTRONIC DATA PRODUCTS

# DATA MATION 59

THIS ISSUE—26,900 COPIES

*the automatic handling of  
information*

volume 5, number

# 5

**FRANK D. THOMPSON** *Publisher*

**GARDNER F. LONDON** *Vice President*

**SANTO A. LANZAROTTA** *Editor*

**ETIENNE J. GUERIN** *European Editor*

**BETTE L. HOWE** *Production Manager*

**MARTHA KNOWLES** *Circulation Mgr.*

**DANIEL D. McCracken**  
**C. L. WANLASS**  
**HERBERT R. J. GROSCH**  
*Editorial Advisers*

**RICHARD W. NIELSON** *Sales Mgr.*

**WARREN A. TIBBETTS**  
*New England District Manager*  
434 Webster St., Manchester 4, N. H.  
NArtional 5-9498

**RICHARD W. NIELSON**  
*Eastern District Manager*  
141 E. 44th St., New York 17, N. Y.  
MUrray Hill 7-5180

**ALBERT PUDVAN**  
*Cleveland District Manager*  
3537 Lee Road, Shaker Heights 20, Ohio  
WAshington 1-9370

**GILBERT THAYER**  
*Midwest District Manager*  
201 N. Wells St., Chicago 6, Ill.  
FIancial 6-1026

**HAMILTON S. STYRON**  
*Western District Manager*  
10373 W. Pico Blvd., Los Angeles 64, Cal.  
BRadshaw 2-2643

**E. J. GUERIN**  
*European Manager*  
Box 824  
Stockholm 1, Sweden

Circulation audited by  
Business Publications Audit



## ARTICLES

8 *Thin Magnetic Films for Computer Applications*

11 *Magnetic Film Memory in Operation at Lincoln Laboratory*

15 *All About Paper Tape; A Postscript*

17 *Is It Overhaul or Trade-in Time?*

32 *International Conference on Information Processing*

32 *AUTOMATH '59, Its Exhibits and Exhibitors*

33 *Japan Comes to the Party*

34 *Special ICIP Technical Report*

46 *The Biax Magnetic Element*

## DEPARTMENTS

2 *to the editor . . .*

28 *People Moving Up in Datamation*

31 *Datamation in Business and Science*

37 *New Products in Datamation*

45 *Datamation News Briefs*

52 *New Datamation Literature*

56 *Advertisers' Index*



*A third editorial adviser has been added to the DATAMATION staff. HERBERT R. J. GROSCH, now a private consultant, is a well-known figure in the industry. He is active in many scientific and engineering societies and has presented numerous papers on the organization and operation of large computing facilities. Grosch has been manager of Space Programs (advanced programming) for IBM; manager (applications) of the GE Computer Dept.; and organized the Washington Technical Computing Bureau for IBM in 1951. He was the first employee of and directed computing for Watson Scientific Computing Laboratory from 1945-50. Tentative plans call for Grosch to contribute a regular column to DATAMATION.*

*ON OUR COVER—Experimental magnetic film memory array of the type installed in the TX-2 computer at M.I.T. Lincoln Laboratory. Memory elements are circular spots of Permalloy film (82 percent nickel, 18 percent iron) 750 Angstroms thick, evaporated on a thin glass substrate. Each element is 1.6 millimeters in diameter; center-to-center spacing is 2.5 millimeters. (See page 11.)*

EDITORIAL OFFICES — 10373 W. PICO BLVD., LOS ANGELES 64, CALIF.

## OVER 22,000 CIRCULATION

DATAMATION is circulated without charge by name and title to the manufacturers and users of automatic, information-handling equipment in all branches of business, industry, government and military installations. Qualified individuals in the United States and Canada are invited to request this publication on their company letter-head, stating position and firm's business. Available to others by subscription at the rate of \$5.00 annually; single issue, \$1.00 when available. No subscription agency is authorized by us to solicit or take orders for subscriptions

in the United States, Canada or overseas. DATAMATION will accept and consider articles dealing with small, medium and large electronic data processing systems; articles covering development and application of components, subsystems and systems; and other general articles of interest to those in the data processing industry. Material submitted should be accompanied by pictures and illustrations when possible. Unsolicited manuscripts to be returned to writer should include return postage but editor assumes no responsibility for their safety or return (although all reasonable care will be taken).



# DIGITAL COMPUTER MODULES



## THE PROBLEM

Rapid, reliable implementation of a special purpose digital system.

## OPTIMUM SOLUTION

3C-PACs, Series M or T, by Computer Control.

Both series of digital logical building blocks are guaranteed to meet your exacting requirements for reliability, compatibility, quality engineering and workmanship.

## FEATURES

- Complete intercircuit compatibility. No external-to-the-package coupling circuits required.
- Solid-state components.
- Compact etched circuit boards with color-coded handles.
- Connector supplied with each 3C-PAC. Guaranteed to have proper dimensional tolerances to eliminate connector headaches.
- All 3C-PACs are guaranteed for one full year.

Write for complete descriptive literature

**COMPUTER CONTROL Co., Inc.**

983 CONCORD STREET • FRAMINGHAM • MASSACHUSETTS

WESTERN DIVISION

2251 BARRY AVENUE • LOS ANGELES 64 • CALIFORNIA

Circle 2 on Reader Service Card

## to the editor...

Sir:

We never thought of DATAMATION as a humor magazine, but after reading the transcript of the panel discussion on the perennial professional society question ("It Overhaul or Trade-in Time?" July/August 1959 issue), we are beginning to wonder. We haven't laughed so hard in a decade. Are these guys kidding? Their search for ways in which members of the profession can gain acceptance is the same stumbling block over which countless other organizations have tripped, the N.M.A.A. among them. You won't solve this problem by self-interested conversation about it, nor is it solved by founding another organization.

We can hardly wait for completion of the article in the next issue, though hardly for reasons that the panel would appreciate.

Hilariously yours,  
Wolf J. Flywheel  
Camden, N.J.

*(Pardon us for entering the fray, Mr. Flywheel, but we are forced to point out that yours seems to be a somewhat negative approach to what you admit is a problem. If interested groups, however unofficial, do not discuss these things, how will action of any kind be generated?—Ed.)*

Sir:

You are to be commended on the complete coverage and fine treatment given by Mr. Etienne J. Guerin on the International Conference on Information Processing held in Paris, France, from June 15-20, 1959. Thank you also for the splendid coverage of the new International Federation of Information Processing Societies.

Very truly yours,  
Isaac L. Auerbach  
Past General Chairman  
U.S. Committee for the ICIP  
Narberth, Pa.

DATAMATION is published bi-monthly on or about the first day of every even-numbered month by F. D. Thompson Publications, Inc., Frank D. Thompson, president. Executive, Circulation and Advertising offices, 141 East 44th St., New York 17, N. Y. (Murray Hill 7-5180). Editorial offices, 10373 West Pico Blvd., Los Angeles 64, Calif. (BRadshaw 2-0817). Published at Chicago, Illinois, application as controlled circulation publication pending at Waseca, Minnesota. Copyright 1959, F. D. Thompson Publications, Inc.

DATAMATION



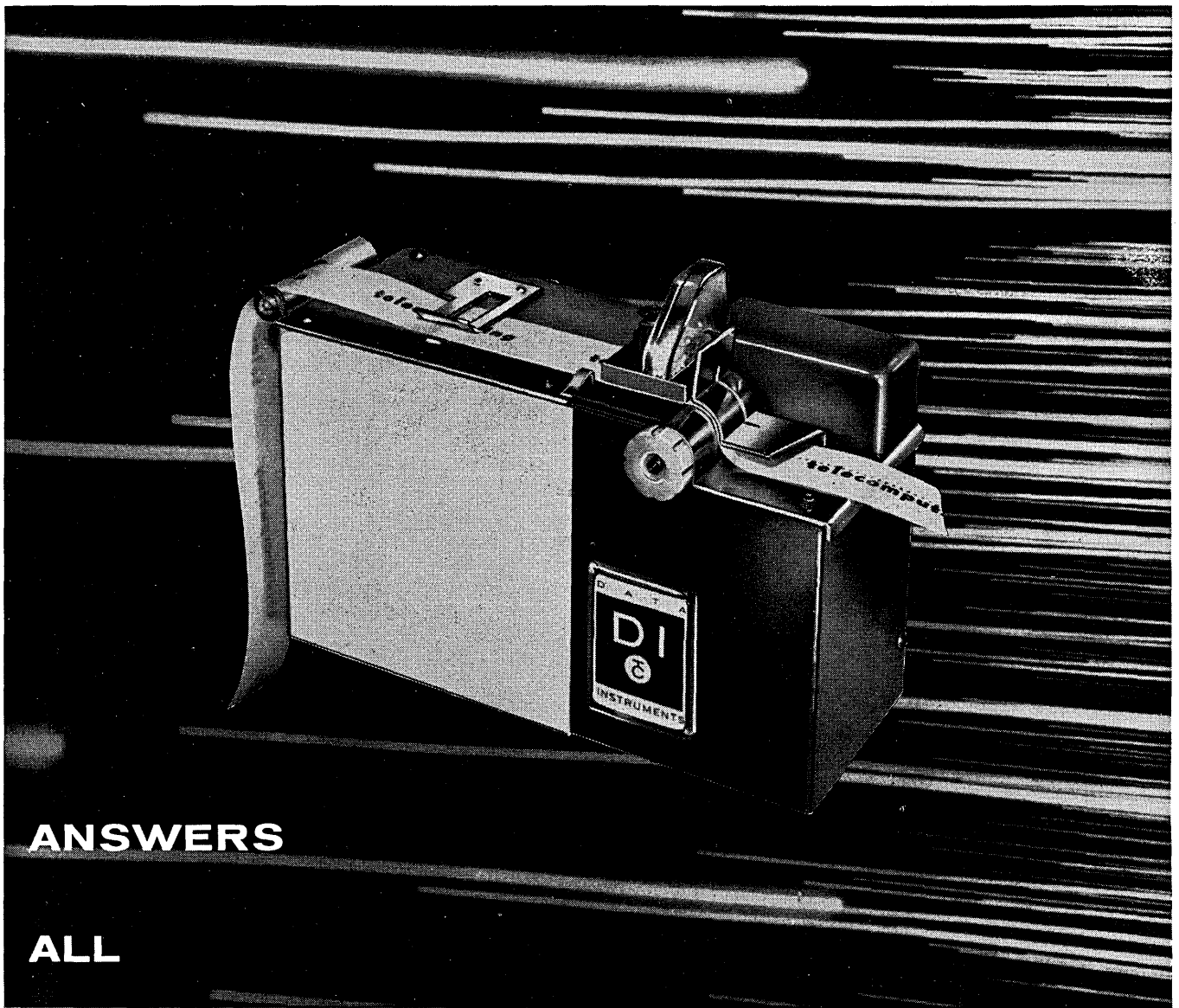

**ANSWERS**

**ALL**

**PAPER-**

**TAPE**

**PUNCHING**

**REQUIREMENTS**

**THE NEW DATA INSTRUMENTS HIGH-SPEED TAPE PERFORATOR**

Here is the one that outperforms them all! This new, high-speed, moderate cost Tape Perforator accepts any tape width or code level up to 1 inch 8 channels—even up to 30 channels on request...with a punching speed of 40 columns per second! Incorporates a simplified drive mechanism with minimum mechanical motions for high-speed operation, long life. These and many other unique design features of the Data Instruments Tape Perforator make it the ideal choice of *all* paper-tape punching in the fields of data handling, data reduction, data processing, and business systems. Write, wire, or phone for complete information.

*Pioneers In Instrumentation For Data Analysis*



**DATA INSTRUMENTS  
DIVISION OF TELECOMPUTING  
CORPORATION**

12838 SATICOY ST., NORTH HOLLYWOOD, CALIFORNIA, PHONE: TRIANGLE 7-8181

Circle 3 on Reader Service Card.

“We demanded the flexible computer that is expandable and easy to use... the Bendix G-15”

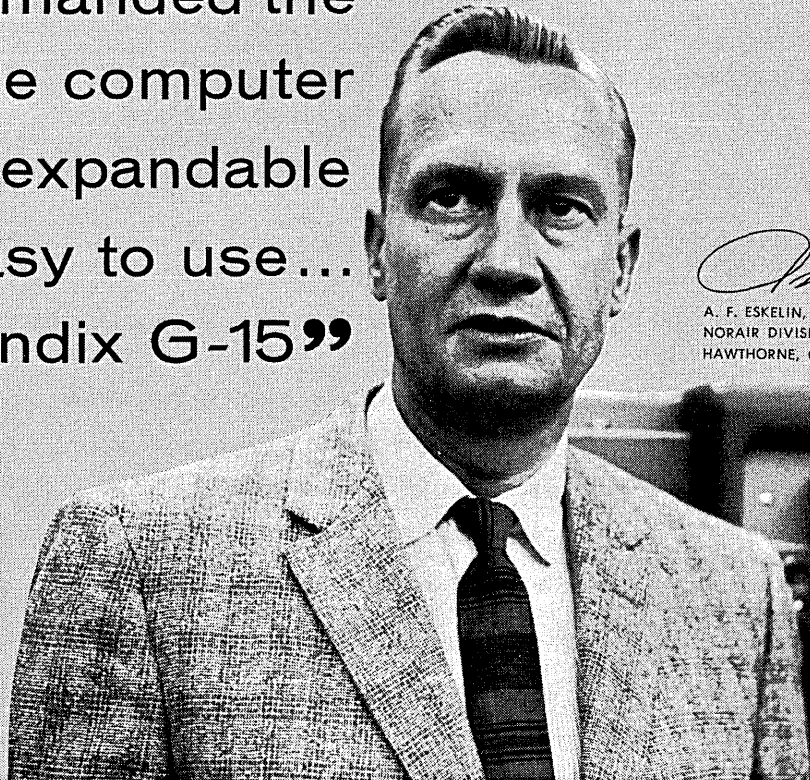

A. F. ESKELIN, MFG. RESEARCH ENGINEER,  
NORAIR DIVISION OF NORTHROP CORPORATION,  
HAWTHORNE, CALIFORNIA

In the production of Norair's sleek new supersonic N-156 jet fighter, a low-cost computer was required. It had to provide extreme accuracy and reliability, yet be easy for engineers to program. And it would have to accept magnetic tape and punched paper tape.

*“Only the Bendix G-15 digital computer could meet these requirements,”* said Mr. Eskelin.

Hundreds of other users, with applications ranging from payroll accounting to the design of nuclear power plants, happily second Norair's choice.

Why so many pleased users? One reason is price. The G-15 is a medium-scale computer, yet costs no more than small-scale machines. Another reason is versatility. The G-15 will handle complex computing jobs in every type of business or industry.

You can start with the basic G-15, a complete operating computer in itself, with a unique photo-electric paper tape reader-punch and electric typewriter.

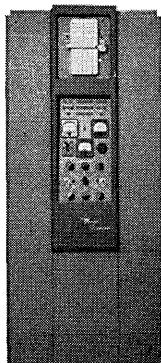

Then, add magnetic tape units, punched card equipment, multi-code paper tape readers, and other accessories as your work load expands and changes.

Simplified programming systems make the G-15 usable by your present staff, and hundreds of programs are available at no cost. Naturally, fast nation-wide service is available.

Complete details will be sent upon request. Mention specific problems where the G-15 may be helpful, and we will be pleased to advise you. Write to:

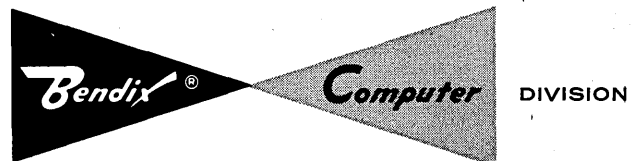

DEPT. E-15  
LOS ANGELES 45, CALIFORNIA

Circle 4 on Reader Service Card.

Backed by more than

# 10,000,000 LIFE TEST HOURS

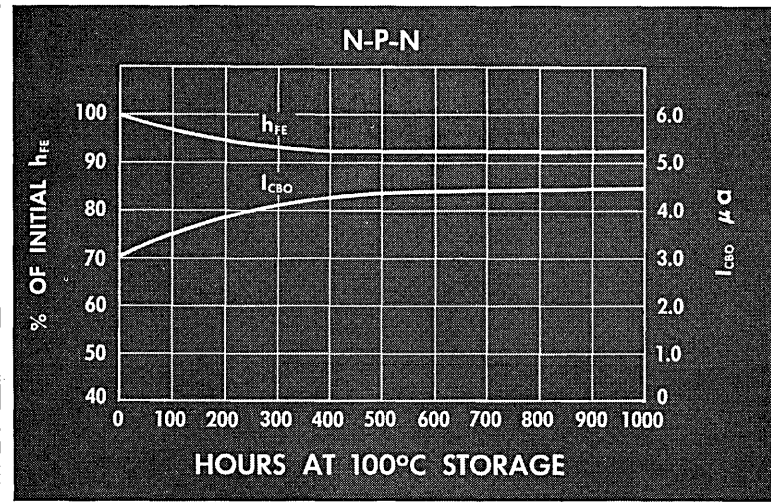
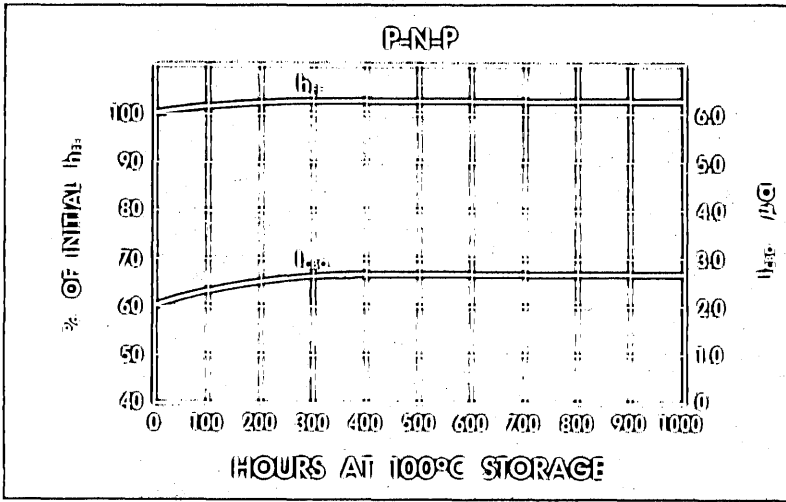

## TI COMPLEMENTARY COMPUTER TRANSISTORS!

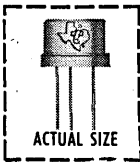

Now commercially available... and backed by more than 10,000,000 hours of recorded life test reliability data... eight types of performance-proved P-N-P and N-P-N alloy-junction germanium computer transistors! Take advantage of the high-reliability/low-cost benefits made possible by manufacturing economies already realized in 1½ years of high-volume production to the stringent

requirements of International Business Machines Corporation. Mechanized production equipment *has been built*... quality assurance controls and techniques *have been perfected*... and are in full use *now*, making these high-volume/high-reliability/low-cost units a reality *today*. Check the detailed specifications below and call your TI distributor or sales engineer for the low prices of these new computer transistors.

COMPLEMENTARY TI COMPUTER TRANSISTORS	MAXIMUM RATINGS AT 25°C							ELECTRICAL CHARACTERISTICS AT 25°C							
	Emitter-Base Voltage	Collector-Base Voltage	Collector-Emitter Voltage	I <sub>C</sub> Collector Current	I <sub>E</sub> Emitter Current	T <sub>STG</sub> Storage Temperature	P <sub>O</sub> Total Device Dissipation*	I <sub>EB0</sub> † Emitter Reverse Current	I <sub>CB0</sub> † Collector Reverse Current	h <sub>FE</sub> † Current Transfer Ratio	h <sub>FE</sub> † Current Transfer Ratio	f <sub>αCO</sub> † Alpha Cutoff Frequency	C <sub>OB</sub> † Output Capacitance		
								V <sub>E</sub> = 25v, I <sub>C</sub> = 0	V <sub>C</sub> = 25v, I <sub>E</sub> = 0	I <sub>C</sub> = 10ma, V <sub>CE</sub> = 1v	I <sub>C</sub> = 200ma, V <sub>CE</sub> = 0.35v	V <sub>CB</sub> = 5v, I <sub>E</sub> = -1ma	V <sub>CB</sub> = 5v, f = 1mc		
	Min	Max	Min	Max	Min	Max	Min	Max	Min	Max	Min	Max	Min	Max	
2N1302	N-P-N	25	25	25	300	-300		6	6	20	10	3	20		
2N1303	P-N-P	-25	-30	-25	-300	300		-6	-6	20	10	3	20		
2N1304	N-P-N	25	25	20	300	-300		6	6	40	200	15	20		
2N1305	P-N-P	-25	-30	-20	-300	300	-65 to 100	150	-6	-6	40	200	15	20	
2N1306	N-P-N	25	25	15	300	-300		6	6	60	300	20	20		
2N1307	P-N-P	-25	-30	-15	-300	300		-6	-6	60	300	20	20		
2N1308	N-P-N	25	25	15	300	-300		6	6	80	20	15	20		
2N1309	P-N-P	-25	-30	-15	-300	300		-6	-6	80	20	15	20		
Units		v	v	v	ma	ma	°C	mw	μa	μa		mc	μμf		

\* Derate at 2.5 mw/°C increase in ambient temperature over 25°C.

† Conditions listed apply to N-P-N. Negative values used for P-N-P.

germanium and silicon transistors  
silicon diodes and rectifiers  
tan-TI-cap solid tantalum capacitors  
precision carbon film resistors  
sensistor silicon resistors

TEXAS



INSTRUMENTS

INCORPORATED  
SEMICONDUCTOR-COMPONENTS DIVISION  
13500 N. CENTRAL EXPRESSWAY  
POST OFFICE BOX 312 · DALLAS, TEXAS

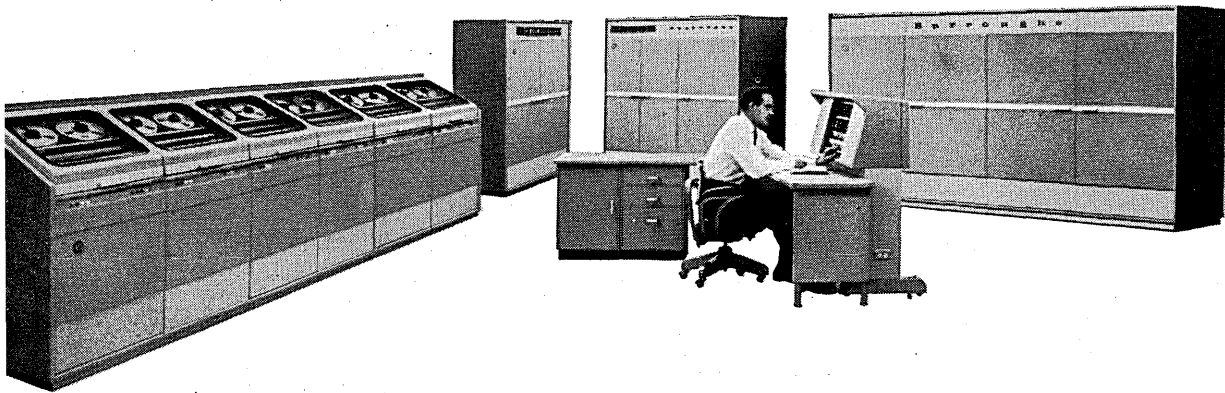
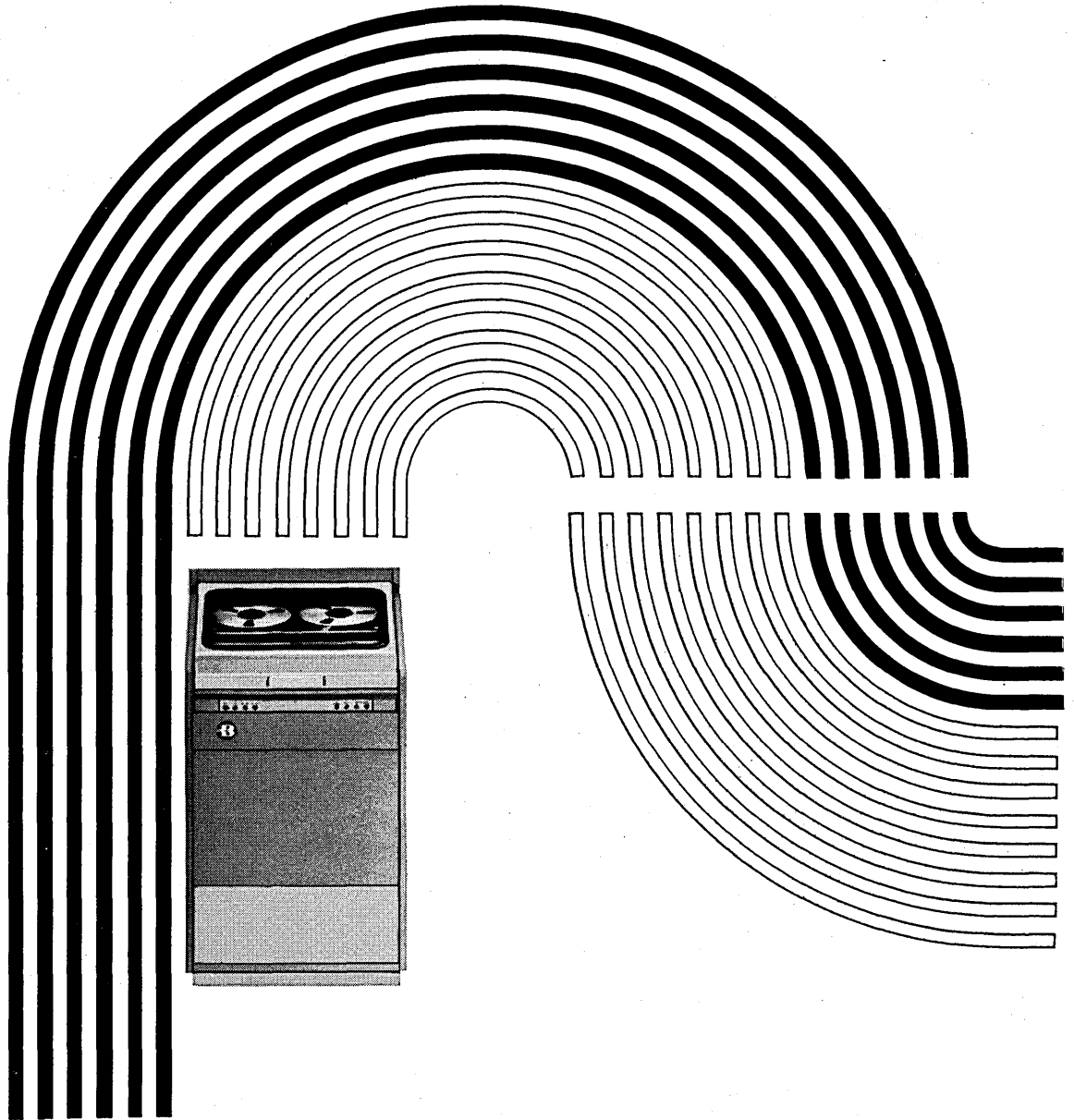

*the new  
Burroughs 220  
high speed  
printer system  
prints as fast  
as it thinks  
and can select  
what it says*

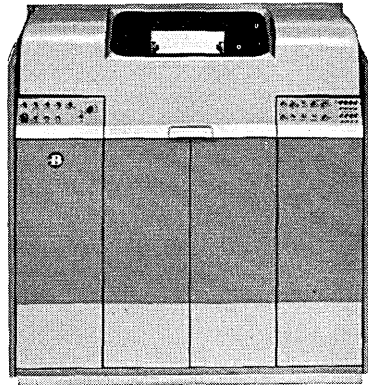
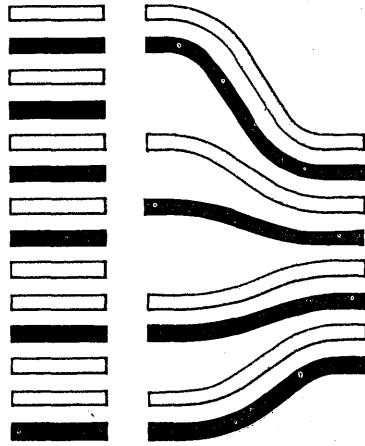
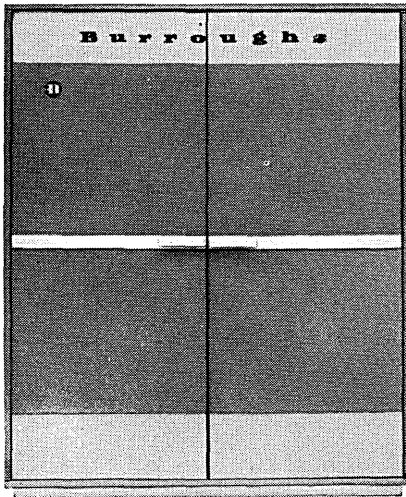

Cut your volume printing jobs down to size with the new Burroughs 220 High Speed Printer System. Printing up to 1500 lines per minute, this transistorized system operates on-line directly from the 220 Computer, or can be fed off-line from one or two 220 magnetic tape files, freeing the computer for other tasks. Built-in magnetic core memory automatically stores, edits and prints out data in whatever format you need. It selects, deletes or merges information to produce neat, legible documents . . . *reports, insurance premium notices, data reduction tabulations, utility bills, labels, bank statements*, or whatever you require. All computer editing steps are eliminated, saving you valuable computer hours in obtaining printed information. This new printer system makes the Burroughs 220, already the most advanced computer in the medium price class, an even faster, more versatile data processing system for business and scientific applications. It is only a part of Burroughs' complete line of advanced data processing systems...all in production...now at work in hundreds of installations...and supported by a nationwide team of computer specialists. Write for Bulletin No. 5221, ElectroData Division, Pasadena, California.

**Burroughs Corporation**

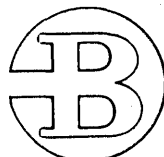

*"NEW DIMENSIONS/in electronics and data processing systems"*

Circle 6 on Reader Service Card.



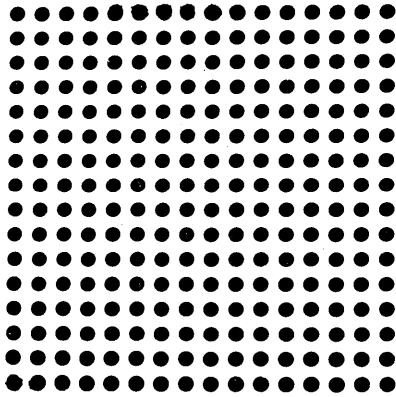

# thin magnetic films for computer applications

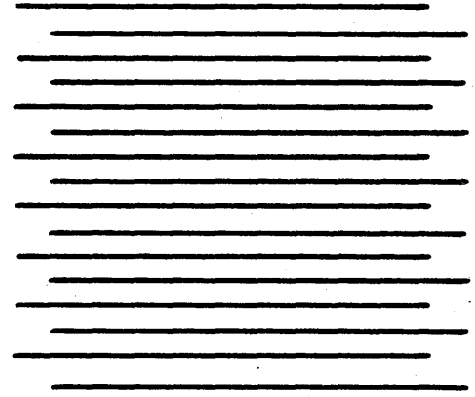

by **A. J. KOLK**, *Project Engineer*  
and **JOHN T. DOHERTY**, *Research Specialist*  
**THE NATIONAL CASH REGISTER COMPANY**,  
*Electronics Division (Solid State)*

Throughout the information processing industry, the possibility of using thin magnetic films as elements for storing binary information in digital computers has resulted in a considerable research effort. Extensive development of fabrication techniques for both electrodeposited and evaporated films has produced films in which high speed switching capabilities have been adequately demonstrated. Evolving from this work are devices such as the rod, the twistor and the bit wire which utilize electrodeposited films, and flat thin film memory arrays, as well as magnetic and Curie-point writing, using evaporated films. Further development of such devices will undoubtedly follow current research in these fields.

Thin films of magnetic material show special properties which make them particularly suited for computer applications. These films may be prepared by vacuum evaporation or by electrodeposition.

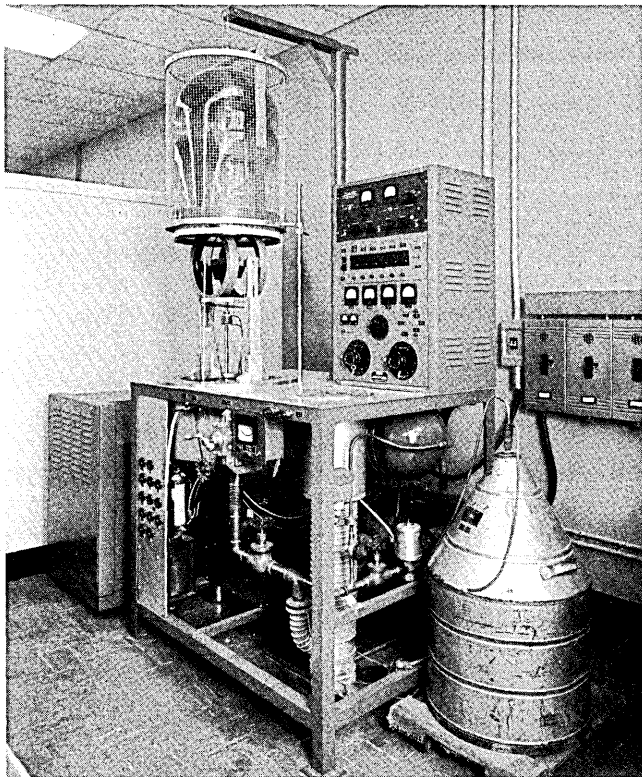

Figure 1—High vacuum equipment

More important applications of thin films to computer technology are described below. The thin film approach promises high speed in some configurations and lower cost and high density in others.

Optical detection of the magnetic state of the thin films show promise for application in high-density magnetic storage devices.

### evaporated films

The evaporation process permits fabrication of extremely thin films having electrical characteristics considerably different from bulk properties. This section contains a description of some of the properties and applications of thin evaporated magnetic films.

Figure 1 shows the general arrangement of vacuum equipment used for evaporating magnetic films. In this picture the source is heated by induction heating. However, resistance heating can also be used. The vacuum is ordinarily maintained at  $2$  to  $3 \times 10^{-5}$  mm Hg during evaporation, and the substrates (usually glass microscope slides) are mounted on the underside of a heater in the upper part of the chamber. Desired film patterns are provided by masking over the substrates. Film thicknesses may be monitored by resistance measurements or, in special cases, by optical means. A pair of Helmholtz coils, which are used to produce a DC magnetic field, may also be seen in Figure 1. Following the method outlined by Blois<sup>[1]</sup> in which it was shown that evaporation in a magnetic field produced films having directional properties, much work has been done on films of approximately 82% nickel and 18% iron.

### thin film memory

Magnetic properties of the thin films may be evaluated by measuring a hysteresis loop according to the method outlined by Crittenden<sup>[2]</sup>. Anisotropy is apparent when hysteresis loop measurements are made on the permalloy film. Figure 2 shows typical loops measured on the same film. The parallel loop was measured in the direction perpendicular to the applied field.

Table I shows some switching characteristics of thin flat films. The switching characteristics of these films may be controlled by application of a transverse field. This permits the switching fields and the switching speeds to be controlled. Figure 3 shows the relationship between transverse and switching field, a relationship which has been experimentally verified<sup>[3]</sup>. The coordinates are normalized to the anisotropy field,  $H_K$ . It may be noted that the type of switching, i.e., either domain rotation or wall motion, can be controlled by application of a transverse field. Figure 4 compares switching speeds of films with curves for ferrite cores and permalloy tape. When transverse fields



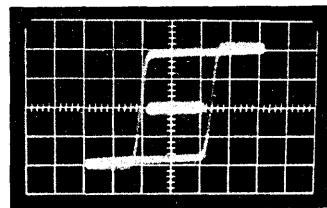

parallel

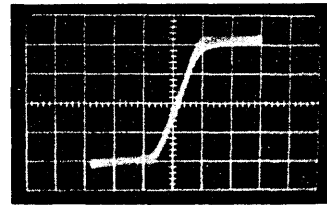

transverse

Film 11-19  
 $H_c = 2.3$  oersted

Figure 2—Hysteresis loops of evaporated (80 Ni 20 Fe) films

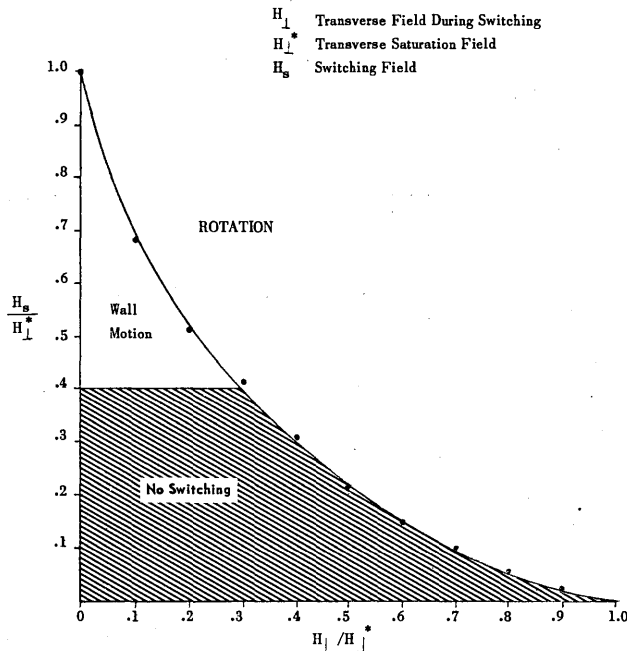

Figure 3—Switching field vs transverse field

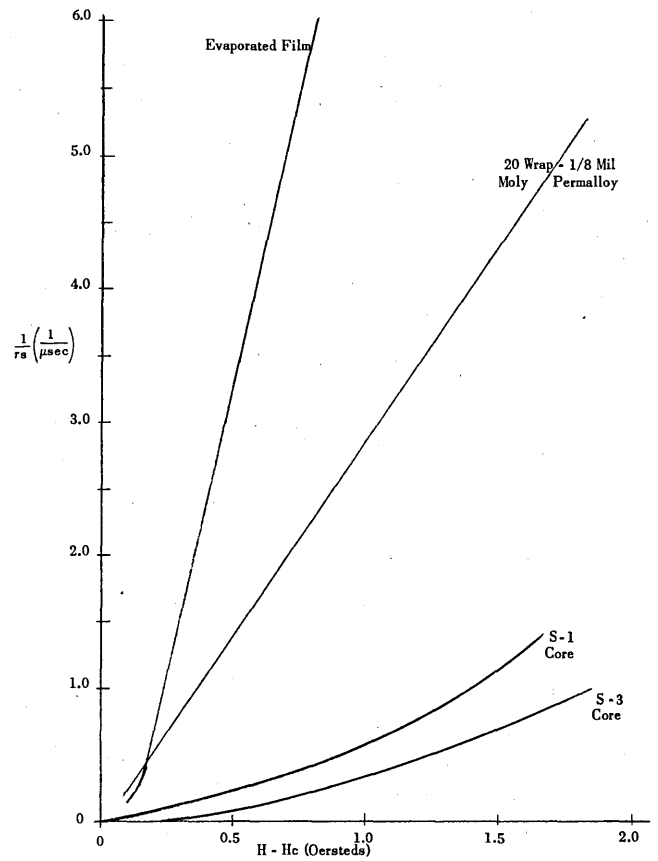

Figure 4—Switching curves

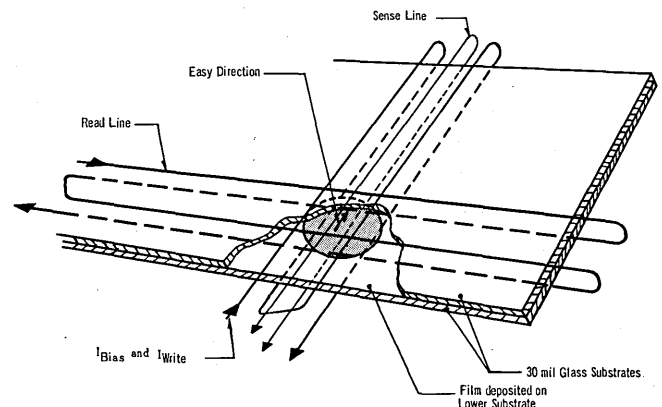

Figure 5—Thin film memory element

TABLE I

Element	Present Operating Speed in Memory Cycle	Potential Operating Speed in Memory Cycle	Present Switching Speed	Attainable Switching Speed	Drive Currents (present)
Planar Matrix	0.5 usec <sup>(6)</sup>	0.25 usec <sup>(25)</sup>	0.1 usec	0.01 usec	400 ma into <sup>(25)</sup> 5 ohms
Rod	0.5 usec <sup>(26)</sup>	0.25 usec	0.05 usec	0.025 usec	250 ma into 40 ohms
Twistor	2.0 usec	1.0 usec	0.6 usec <sup>(23)</sup>	?	<100 ma <sup>(23)</sup>
Bit Wire	2.0 usec	1.0 usec	0.1 usec <sup>(24)</sup>	?	*

\*400 ma into 5 ohms plus 70 ma into a solenoid drive<sup>(24)</sup>

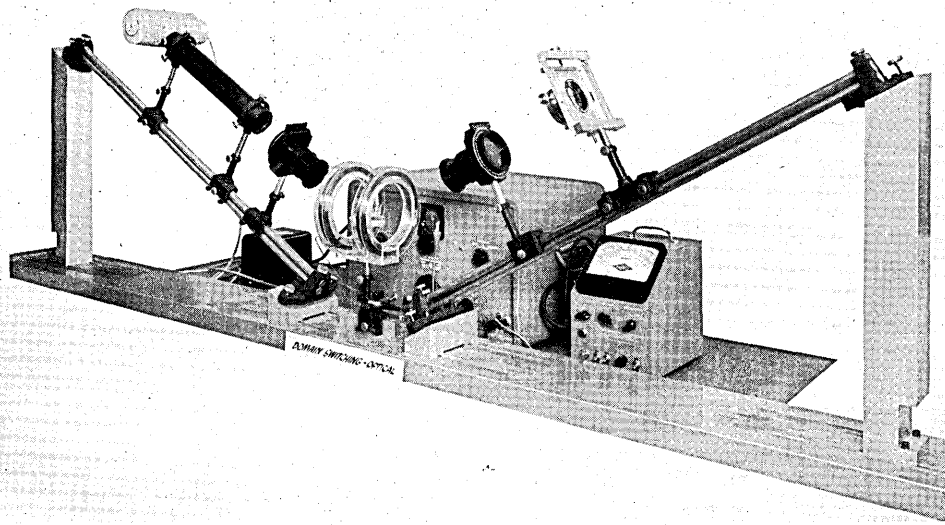

Figure 6—Kerr magneto optic apparatus

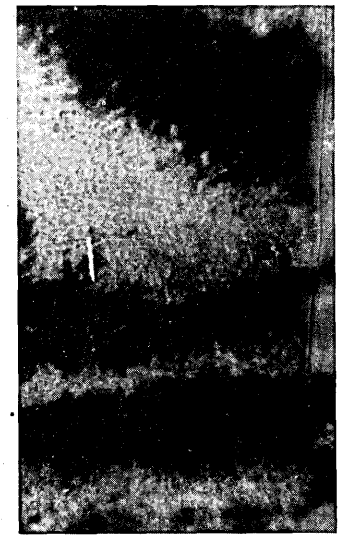

Figure 7—Magnetic domains in thin films

are applied, the switching curves for films are displaced to the left<sup>[1]</sup> indicating higher speed for a given drive.

These directional properties and transverse field effects have caused workers<sup>[5,6]</sup> to suggest that films may be used as memory elements for digital computers. Figure 5 shows how films may be used in a memory array.

By utilizing the Kerr magneto-optic effect, optical readouts may also be obtained from thin films. Figure 6 is an illustration of an optical bench.

When plane polarized light is reflected from a magnetic film, the plane of polarization is rotated either clockwise or counter clockwise depending upon the state of magnetization of the film.

By properly adjusting the analyzer in the reflected beam, anti-parallel domains are observed. Figure 7 shows magnetic domains in an evaporated permalloy film. For thin films, transmitted (Faraday effect) instead of reflected light may be used<sup>[7]</sup>. Figure 7 is a photograph of magnetic domains which were observed using reflected light. Application of magneto-optic effects include magnetic and Curie-point writing.

#### magnetic and curie-point writing

Magnetic writing is a method which has been proposed for high density storage. In this method either the Kerr or the Faraday effect is used to read out information. Input is accomplished by remagnetizing selected areas of the film by means of a magnetic probe. Williams<sup>[8]</sup> has suggested that  $10^6$  bits/cm<sup>2</sup> can be attained by this technique.

Another technique utilizing the Faraday effect is Curie-point writing<sup>[9]</sup>. Evaporated manganese-bismuth films having a magnetization vector normal to the plane of the film are used. When a film is uniformly magnetized normal to the surface, and a portion of the film is raised above the Curie temperature, this portion will upon cooling have its magnetization vector anti-parallel to the surrounding film. The Kerr magneto-optic effect may then be used to detect this reverse domain. Thus, an electron beam may be used to put information into the system with an optical readout. Information may be erased by providing a DC field strong enough to return the film to the original state of magnetization.

Practical applications of evaporated films require that the films be as uniform as possible. Several factors may

contribute to non-uniformity of evaporated films. Behrmdt and Maddocks<sup>[10]</sup> have demonstrated that substrate preparation affects film uniformity, and suggest that proper cleaning including an ammonium biffuoride etch be employed. The coercive force is also dependent upon film thickness. This has been established by Reimer<sup>[11]</sup> for nickel films and by Tiller and Clark<sup>[12]</sup> for permalloy films. Surface roughness may be demonstrated either by interferometer measurements or electron micrographs. Chemical composition may also vary within a single film. Chu and Wolfe<sup>[13]</sup> have reported that 3-4 percent variation in nickel content may be obtained for permalloy films. Inasmuch as angle of incidence of vapor on the substrate and rate of evaporation<sup>[14, 15, 16, 17]</sup> influence film structure, particularly in thin films, these factors also influence film uniformity.

Much of the current research effort on films is directly related to problems concerning film uniformity. Details vary in accordance with materials being used and the specific application.

#### electrodeposited thin magnetic films electrodeposited permalloy films

The difficulties inherent in the vacuum deposition of uniform permalloy films for use in computer memories have led to the consideration of other methods of making thin permalloy films. One obvious alternative method is electrodeposition. There are several reports<sup>[18, 19, 20]</sup> of the successful deposition of magnetically oriented films. These films show magnetic properties similar to vacuum deposited films of the same composition.

A recent paper by Wolf, Katz and Brain<sup>[18]</sup> reports the magnetic characteristics of electrodeposited films containing 80% to 87½% nickel, the remainder being iron. The thickness of the films showing best characteristics ranged from 530 Å to 600 Å; thicker films were reported to be less square.

The electroplating bath was stated to be composed of the sulfates of nickel and iron with some sodium chloride and boric acid added. Sodium lauryl sulfate was used as a surface active agent and saccharin was employed to reduce grain size and stress.

By controlling composition and the plating conditions, the anisotropy field was varied independently of the coer-

cive force in the easy direction. Hysteresis loops were presented to show the various ratios of the anisotropy field ( $H_k$ ) to the coercive force in the easy direction ( $H_c$ ). The unusual result was obtained that  $H_c/H_k$  could be made greater than unity. Reference to Figure 3 shows that this is not in accord with the simple rotational model for oriented thin magnetic films.

The films were deposited on a conducting layer of gold which was sputtered onto the surface of a microscope slide. The sputtered gold was chosen from a number of conducting substrates because, after plating, it yielded the best magnetic properties. The important factors in choosing a conducting layer were surface smoothness and the absence of an appreciable surface oxide.

Other work on electrodeposited permalloy has been carried out on the surface of metallized Mylar<sup>[21]</sup>. The surface of the Mylar was metallized with chromium-copper laid down by vacuum deposition. The chromium and copper were laid down in two layers; the first layer was chromium about 2700 Å in thickness, and the second layer consisted of about 1000 Å of copper. Over the copper, nickel-iron alloys were deposited both with and without an applied magnetic field. It was found that a field of 70 to 100 oersteds applied during plating improved the magnetic properties.

In addition to the flat sheets of Mylar some other forms were tried. Toroids of 1.3 cm outside diameter were reported to have been made by electroplating.

While the process of electroplating offers another route to the preparation of thin permalloy films, there are also difficulties inherent in this technique for the preparation of planar matrices for computer applications. In the first place, the film must be deposited on a conductive substrate, which implies that eddy current damping is present. If the conductive substrate is made very thin in order to minimize eddy current damping, then the resistance of the substrate causes a problem in the production of uniform coatings. The rate of electrochemical reaction is dependent on the voltage, and quite small variations in the voltage may considerably alter the plating current. Thus, in order to deposit uniform layers, the voltage should be the same throughout the surface of the substrate. However, ingenuity in anode construction or cell construction will sometimes permit uniform layers to be deposited onto relatively low conductivity substrates.

In the area of oriented electroplated magnetic films there is also a report by some Russian workers<sup>[20]</sup> that a uniaxial anisotropy has been produced in an electroplate of pure iron by the application of a magnetic field during the plating process.

#### the "rod"

Another application of electrodeposited thin magnetic coatings consists of a thin cylindrical configuration termed the "Rod"<sup>[21]</sup>. The magnetic element called the Rod can be formed by laying down a conductive substrate on a thin piece of glass cane (preferably 15 mils or less), and then electroplating a magnetic coating over the metallized glass. A typical configuration is shown in Figure 8.

In the case of 98% Fe, 2% Ni alloy electroplate, an element possessing good squareness and a coercive force of approximately 14 oersteds is obtained. The switching characteristics of the 98 Fe-2 Ni alloy are fast enough so that one-half-microsecond cycle times have been demon-

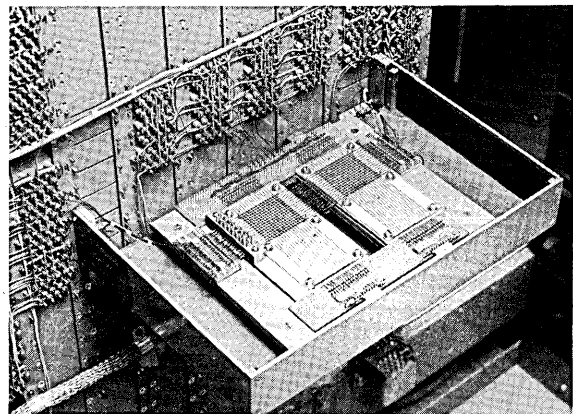

*First known operating magnetic-film computer memory is pictured at MIT Lincoln Laboratory in Lexington, Massachusetts. With a capacity of 32 ten-bit words and a read-and-write cycle time of 0.8 microseconds, this memory has been in satisfactory routine operation in Lincoln's TX-2 computer since it was first installed in July 1959.*

## MAGNETIC FILM MEMORY IN OPERATION AT LINCOLN

A high-speed magnetic film memory is now in operation as a part of the TX-2 digital computer at the M.I.T. Lincoln Laboratory. Its performance has been entirely satisfactory since its installation in July 1959. It has a capacity of 32 ten-bit words, suitable for evaluation testing, and serves as an experimental prototype for larger units. This new memory, and the TX-2 computer of which it is a part, were developed by Lincoln Laboratory under Air Force contract, with the joint support of the Army, Navy, and Air Force.

The read-and-write cycle time of 0.8 microseconds is consistent with the speed of the computer itself, although bench tests demonstrated successful operation at a cycle time as short as 0.4 microseconds. Net driving current for writing is 150 milliamperes, and one-millivolt output signals are obtained from individual memory elements.

Each memory element is a circular spot of Permalloy film (82 percent nickel, 18 percent iron) 750 Angstroms thick, 1.6 millimeters in diameter, centered 2.5 millimeters apart. The spots are deposited by evaporation on a flat glass substrate, 0.1 millimeter thick, in 16 x 16 unit arrays. The complete memory unit as installed in TX-2 and one of the experimental arrays are shown in the enclosed photographs. The transistor drive and sense circuits can be seen surrounding the memory.

A thin film memory has several potential advantages over the familiar ferrite toroidal core memory: faster cycle time, lower power dissipation, greater compactness, and simpler fabrication. The unit now in operation confirms these expectations, although none of these factors has been fully exploited in this first developmental model.

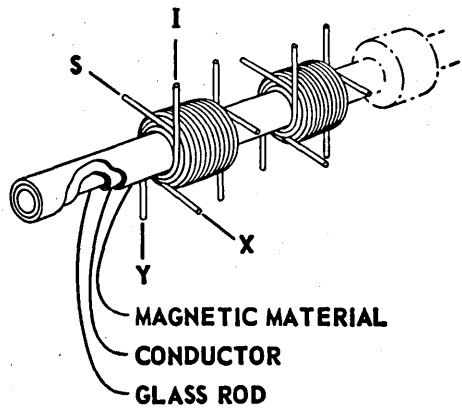

- I - INHIBIT (FIRST WINDING)**  
**S - SENSE (SECOND WINDING)**  
**Y - Y DRIVE (THIRD WINDING)**  
**X - X DRIVE (FOURTH WINDING)**

Figure 8—Magnetic rod with solenoid bundles wound in coincident-current memory mode

strated in a computer memory employing the Rod.

While the Rod appears somewhat slower than flat film matrices (10 vs 25 millimicrosecond) in switching speed, the difficulties in obtaining uniform evaporated or electro-deposited flat films, together with the low signal output, at present limits large scale applications of the flat film. To date, the fastest evaporated flat-film memory reported is intended to operate at a cycle time of 0.5 microseconds, the same as the cycle time already obtained with the Rod.

#### the twistor and bit wire

The element called the "Twistor" utilizes a preferred helical direction of magnetization produced by a torsional stress around the axis of a wire. The Twistor concept has been used in homogeneous magnetic wires and in wires of nonmagnetic conductor wrapped or coated with a thin layer of magnetic material<sup>[23, 23]</sup>.

The method of preparing the Twistor which has been reported to give the most reproducibility consists of wrapping a permalloy strip measuring 0.25 mil by 2 mils around a 3-mil-diameter insulated copper wire.

A material which operates similarly to the Twistor but is formed by a direct electroplating procedure without externally creating a strain is called the "Bit Wire"<sup>[24]</sup>. To make this element, a 0.2 mil-layer of a 78 Ni-22 Fe alloy is plated onto the surface of 3-mil beryllium-copper spring wire. Under certain plating conditions a helical easy axis is found to exist in the plated coating.

Although the magnetic "wrapping" or coatings of the Twistor and the Bit Wire are above the thickness region which is usually considered to be thin magnetic films, the elements are described in this review for comparison purposes. (The thickness region generally considered to be a "thin" film is under 10000 A.) A comparison of the Twistor, Bit Wire, the flat film matrix, and the Rod is shown in Table I. Although the strained types are somewhat slower in operating speed than the Rod or flat film, for certain applications where high speed is not a major consideration the Bit Wire or Twistor may offer economic advantages.

#### LIST OF REFERENCES

1. Blois, M. S., "Preparation of Thin Magnetic Films and Their Properties," J. Applied Physics, 26, p 975 (1955)

2. Crittenden, E. C., Hudimac, A. A. and Strough, R. I., "Magnetization Hysteresis Loop Tracer for Long Specimens of Extremely Small Cross Section," Review of Scientific Institute, 22, p 872 (1951)

3. Smith, D. O., "Static and Dynamic Behavior of Permalloy Films," J. Applied Physics, 29, No. 3, p 264 (1958)

4. Olson, C. D. and Pohm, A. V., "Flux Reversal in Thin Films of 82 percent Ni, 18 percent Fe," J. Applied Physics, 29, No. 3, p 274 (1958)

5. Pohm, A. V. and Rubens, S. M., "A Compact Coincident-Current Memory," Proceedings Eastern Joint Computer Conference, New York, p 120 (1956)

6. Raffel, J. I., "Operating Characteristics of a Thin Film Memory," Magnetism and Magnetic Materials Conference, Philadelphia, Pa. (1958)

7. Fowler, C. A., Fryer, E. M., "Magnetic Domains in Thin Films by Faraday Effect," Phys. Rev., Vol. 104, No. 2, Oct. 1956, p 552

8. Williams, H. J., Sherwood, F. G., Foster, F. G., and Kelley, E. M., "Magnetic Writing on Thin Films of MnBi," J. Applied Physics, Vol. 28, No. 10, Oct. 1957, p 1181

9. Mayer, L., "Curie-Point Writing on Magnetic Films," J. Applied Physics, Vol. 29, No. 6, June 1958, p 1003

10. Behrnt, K. H., and Maddocks, F. S., "The Influences of Substrate Processing on the Magnetic Properties and Reproducibility of Evaporated Nickel-Iron Films," Conference on Magnetism and Magnetic Materials, Nov. 1958

11. Reimer, L., "Magnetic Properties of Electrohytically Deposited and Evaporated Thin Films of Nickel," Z. Naturforschung, p 550 (1957)

12. Tiller, C. O. and Clark, G. W., "Coercive Force vs. Thickness for Thin Films of Nickel-Iron," Phys. Rev., Vol. 110, No. 2, (1958).

13. Chu, W. W. L., and Wolfe, J. E., Wagner, B. C., "Some Observations on Evaporated Permalloy Films," Conference on Magnetism and Magnetic Materials, Nov. 1958.

14. Smith, D. O., "Anisotropy in Permalloy Films," Magnetism and Magnetic Materials Conference, Philadelphia, Pa., (1958)

15. Knorr, T. G., and Hoffman, R. W., "Geometric Dependence of Magnetic Anisotropy in Thin Iron Films," AEC Tech. Rep., No. 3, Contract AT (ii-1), Sept. 1958

16. Sennett, R. E., G. D., "The Structure of Evaporated Metal Films and Their Optical Properties," J. Opt. Soc. Amer., 40, No. 4, p. 203 (1950)

17. Aziz, R. A., Scott, G. D., "Effect of Incident Atomic Velocity on Structure of Evaporated Silver Films," Can. J. Phys., 34, No. 8, p 731 (1956)

18. Wolf, I. W., Katz, H. W. and Brain, A. E., "The Fabrication and Properties of Memory Elements Using Electrodeposited Thin Magnetic Films of 82-18 Nickel Iron," Proceedings 1959 Electronic Components Conference, pp 15-20

19. Edelman, F. H., et al., "The Preparation and Characteristics of Thin Ferromagnetic Films," Final Engineering Report, Contract AF 19(604)-2659, ASTIA Doc. AD 160845

20. Kotel'mikov, N. V., "The Creation of a Magnetic Texture in Thin Iron Electrodeposits by the Application of a Magnetic Field," (In Russian) Fiz. metalov i metallovedenie, Vol VI, No. 2, pp 222-228 (1958)

21. Meier, D. A., "Millimicrosecond Magnetic Switching and Storage Element," J. App. Phys., 30, No. 4, pp 45S-46S (1959)

22. Bobeck, A. H., "A New Storage Element Suitable for Large-Sized Memory Array—The Twistor," The Bell System Technical Journal, 36, 1319-40, (1957)

23. Bobeck, A. H. and Title, R. S., "The Twistor—Its Use in a Memory Array," Nonlinear Magnetics and Magnetic Amplifiers Proceedings, Special Conference, 1958, pp 234-242

24. Schwartz, S. J., and Sallo, J. S., "Electrodeposited Twistor and Bit Wire Components," Presented at 1959 Solid State Circuits Conference, Feb. 12-13, 1959, Philadelphia, Pa.

25. Smith, D. O., "Thin Magnetic Films for Digital Computer Memories," Electronics, June 26, 1959, pp 44-45

26. Meier, D. A., (paper to be published)

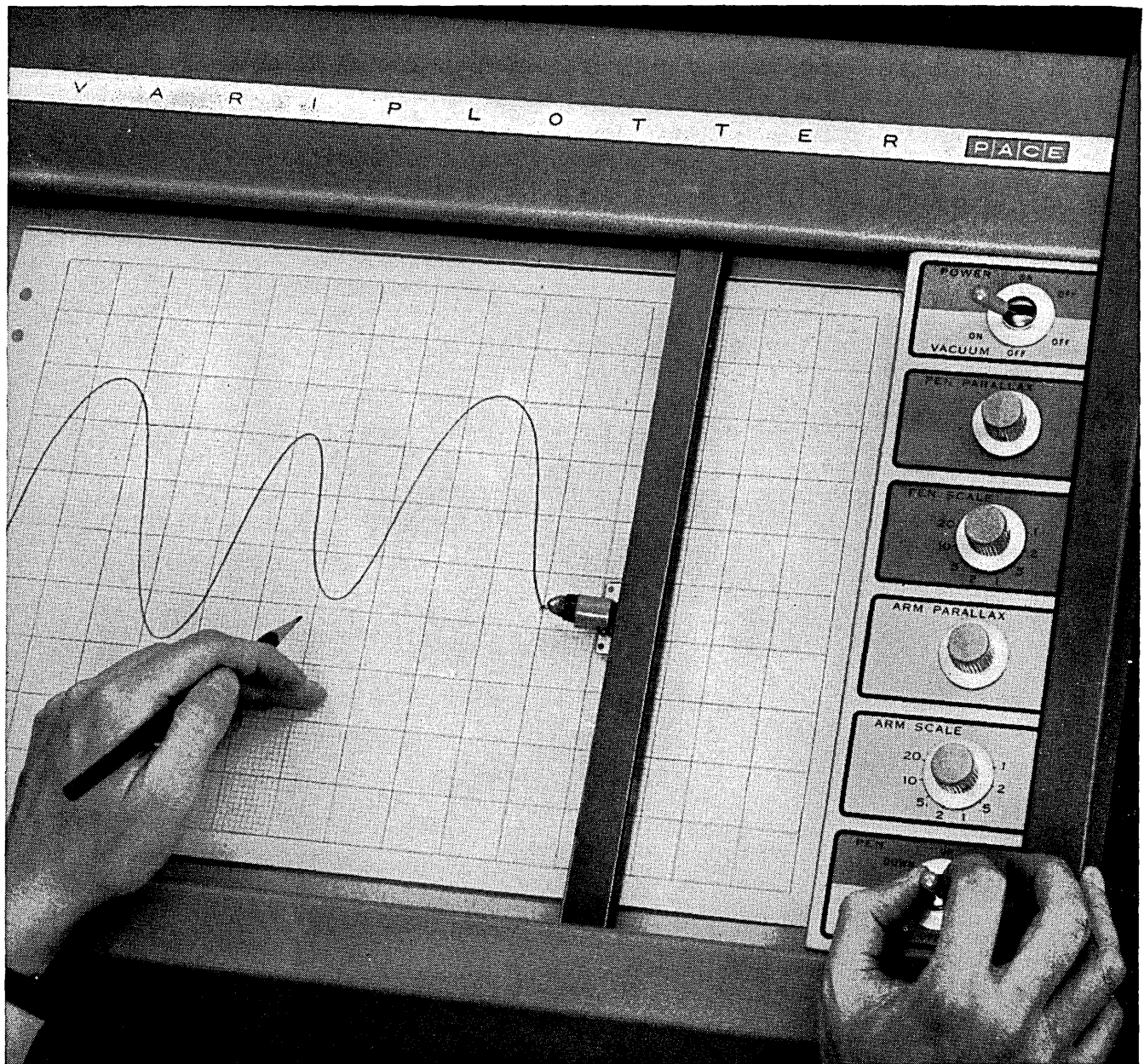

with **EAI** portable X-Y plotter—

**you can convert data to graphic form  
quickly...accurately...reliably**

With Electronic Associates' new Variplotter Model 1100E, data can be converted immediately to graphic form for quick, easy interpretation and understanding. Graphic display adds life to performance data—makes X and Y relationships instantly, unmistakably clear . . . provides permanent picture-like records of performance.

With the addition of accessories, versatile Variplotter will operate as a function generator, or will plot digital information from a keyboard. Its small size (23" L by 17½" W by 9½" H) and light weight (43 lbs.) make it a convenient laboratory tool.

The Variplotter combines high dynamic and static accuracy with a wide range of input sensitivities. Its

rugged construction assures dependable, low-maintenance performance.

For name of our nearest representative write Dept. D.

**VARIPLOTTER MODEL 1100E FEATURES:**

- Portable table top size
- Vacuum hold down
- Wide range of input sensitivities
- High dynamic and static accuracy
- Rugged construction
- Ease of maintenance
- Differential inputs

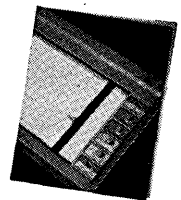

For complete specifications write for Booklet AP-810D

**EAI**

ELECTRONIC ASSOCIATES, INC. Long Branch, New Jersey

Circle 7 on Reader Service Card.



Join the leader of the new generation of computers!

# METHODS ANALYSTS FOR HONEYWELL 800

**Make your big move now.** All-transistorized Honeywell 800 is rapidly winning customers coast to coast. Make a name for yourself now, working with this most advanced data processing system in the medium to large-scale field.

**Enjoy management's full support.** Honeywell is dedicated to continuing progress in computer design and service. All data processing efforts are solidly supported right down the line.

**Advance in your own field.** Honeywell offers you a chance for high advancement in your chosen field. No need to transfer to another department to get ahead.

## Can you qualify?



- ★ *BS or MS in any science, math, statistics, accounting or business*
- ★ *3 to 5 years computer and applications experience*
- ★ *Willingness to relocate, if necessary*

Complete training on Honeywell 800 in Boston precedes assignment to locations in New York, Boston, Washington, Chicago, Detroit, Los Angeles and other major cities.

Write in confidence and send resume to:

John A. Koenig  
Professional Employment Supervisor  
Minneapolis-Honeywell, Datamatic Div.  
Newton Highlands 61, Mass.

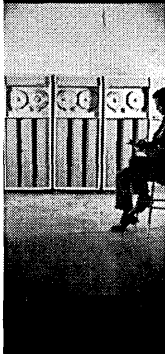
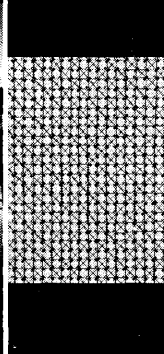
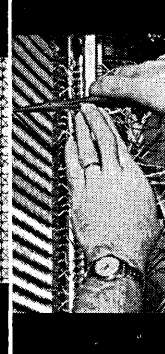
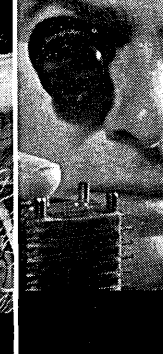
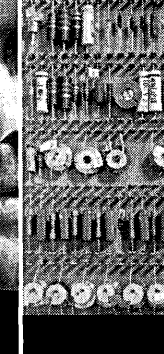
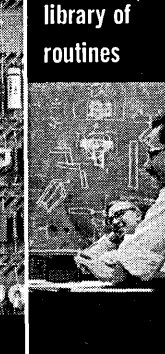
## 8 ways to identify the leader of the new generation of computers

1	2	3	4	5	6	7	8
<b>EFFICIENCY</b>	<b>ECONOMY</b>	<b>EXPANDABILITY</b>	<b>RELIABILITY</b>	<b>VERSATILITY</b>	<b>ADAPTABILITY</b>	<b>SERVICE</b>	<b>BACKING</b>
You can do up to 8 different, independently programmed jobs — simultaneously	You can process more data per dollar in a working day, on small volume applications or large	You can increase Honeywell 800 capacity indefinitely in small, economical stages	You can cut costs of maintaining accuracy with a new kind of automatic error correction	You can do both business data processing and scientific computation — simultaneously	You can simplify problem preparation with Honeywell's automatic programming aids and library of routines	You can expect complete training, programming assistance, maintenance and applications know-how from Honeywell's data processing specialists	You can count on the continuing support of a company dedicated to the advance of transistorized data processing
							

Circle 70 on Reader Service Card.



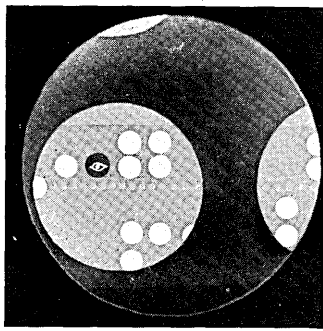

# ALL ABOUT PAPER TAPE

*a postscript*

To accommodate late entries, *DATAMATION* presents this final installment of a survey article covering paper tape equipment.

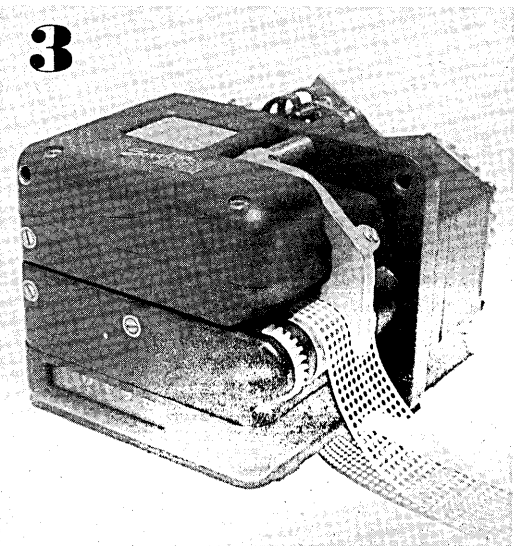
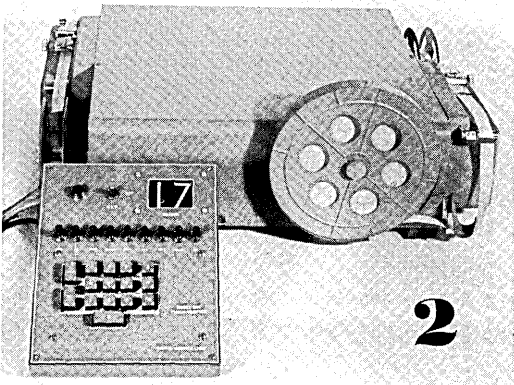
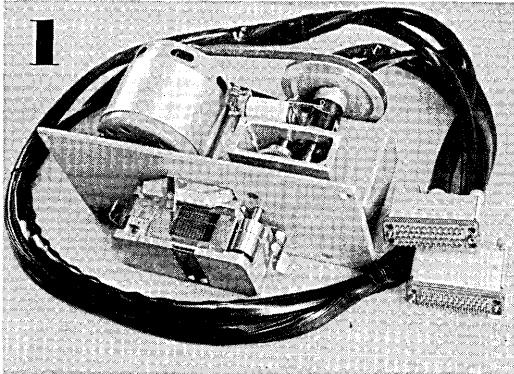

## WANG LABS

**1** Series TR Punched Tape Block Reader is an input device designed especially for digital control, programming and other similar applications. It is made for paper, paper-Mylar, Mylar or other insulating tapes from 0.687 to 1.000 inch wide with standard hole-spacing and hole-diameter. One of the chief advantages of this reader is that it can read from 6 to 24 lines of codes along the feed direction of the tape in addition to the regular 5 to 8 level transverse code holes of the tape. Consequently, up to a total of 192 bits of code information can be read off simultaneously from the tape and is available as contact closures for control or programming use.

Circle 100 on Reader Service Card.

## DIGITAL SERVICE LABS

**2** Model 244 punch-verifier features 10-key decimal keyboard mounted in separate console for ease of operation and convenience of operator. It has four verification checks: keyboard locks if key depressed and tape in verifier do not agree; key remains depressed as indication of error; if keyboard is correct — override switch permits punching of digit; if incorrect — reset button permits operator to try again. Other features of the 244 — automatic leader between blocks, least significant zeroes may be automatically punched, complete reproducing facilities, and all codes are compatible with Bendix G-15 code.

Circle 101 on Reader Service Card.

## SOROBAN ENGINEERING

**3** FR-2 tape reader is designed for operation under military environmental conditions. These conditions include operation at  $-65^{\circ}\text{F.}$ , with shock and vibration forces up to 20 G's. The reader is capable of passing a 50 hour salt spray test. It is explosion proof. The reader is capable of operation at rates up to 60 codes per second. Drive is through a Gilmer timing belt. Reverse reading can be achieved by reversing the drive shaft rotation. The reader's cam drive system and tape transport linkages are immersed in a splash oil bath. The design uses a latch-interlocked cam system for read and feed, thus reliable long life is accommodated whether character-by-character or continuous reading is employed.

Circle 102 on Reader Service Card.

Soroban's GP-2 tape perforator, which is about the same size and weight of a standard press camera, can punch up to 300 coded characters per second in standard communication paper or Mylar tape. This speed is at least five times faster than is provided by other commercially available tape perforators, according to the manufacturer. All internal parts of the punch are lubricated by a splash oil bath system. Manual lubrication intervals are in the order of several months. The basic recording cycle allots one-third of a cycle to tape transport and two-thirds to punch pin penetration of the tape.

Circle 103 on Reader Service Card.

## AIRBORNE RADAR...

The APS-67 Airborne Radar . . . designed and developed by *The Magnavox Company* in conjunction with the Navy Department, gives eyes that see by both day and night to the Crusader.

The APS-67 delivers the utmost in performance and reliability for this Navy Fighter . . . clearly demonstrating *The Magnavox Company's* ability to produce and work as prime contractor on a complex electronics project.

*MAGNAVOX capabilities are in The Fields Of Airborne Radar, ASW, Communications, Navigation Equipments, Fusing and Data Handling . . . your inquiries are invited.*

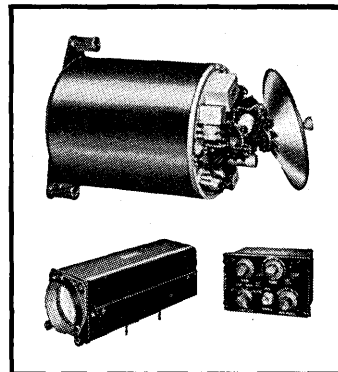

PRODUCTS  
THAT SEE BY  
THEMSELVES

# Magnavox

GIVES THE CRUSADER EYES!

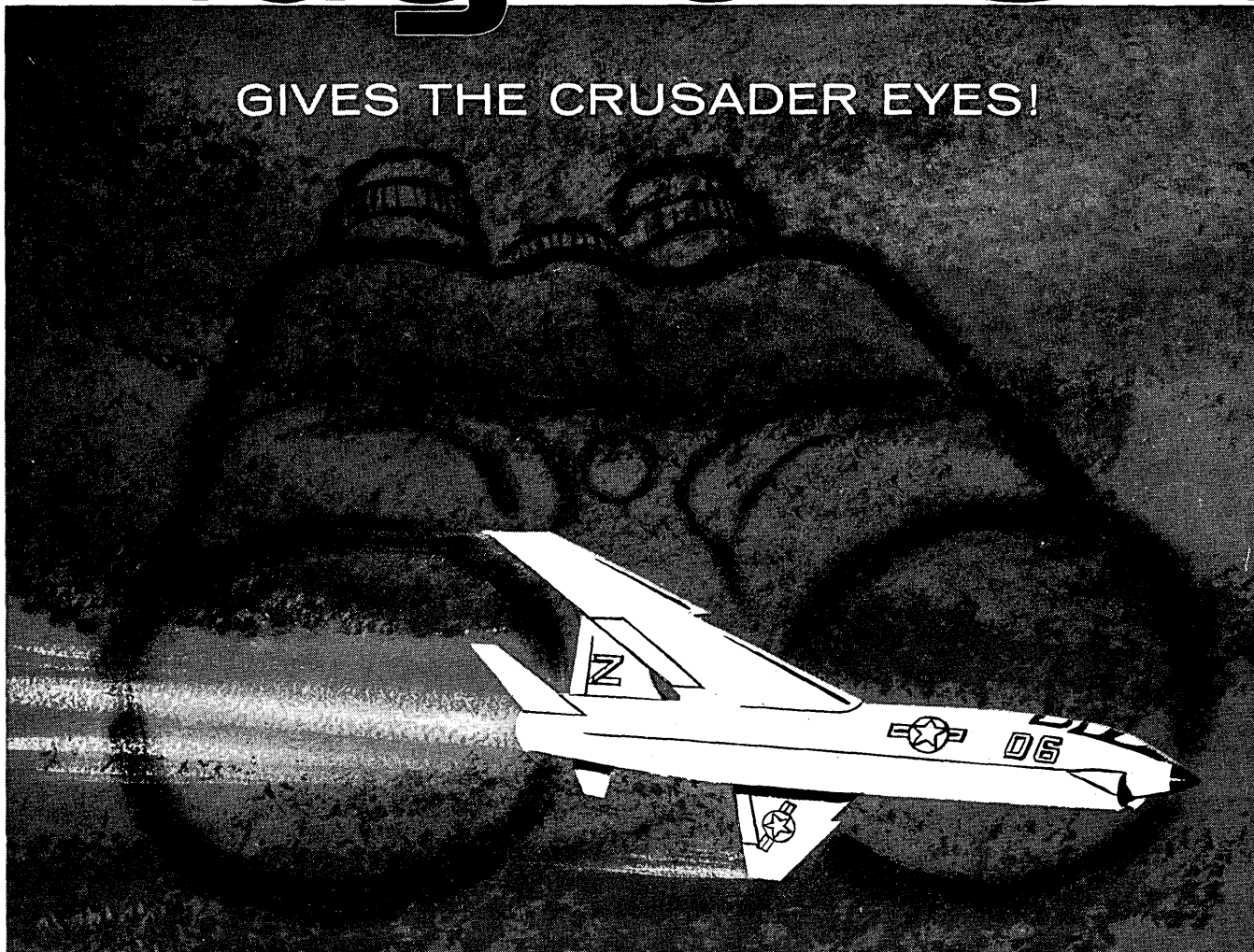

THE MAGNAVOX CO. • DEPT. 100 • *Government and Industrial Division* • FORT WAYNE, IND.

Circle 8 on Reader Service Card.

# IS IT OVERHAUL OR TRADE-IN TIME?

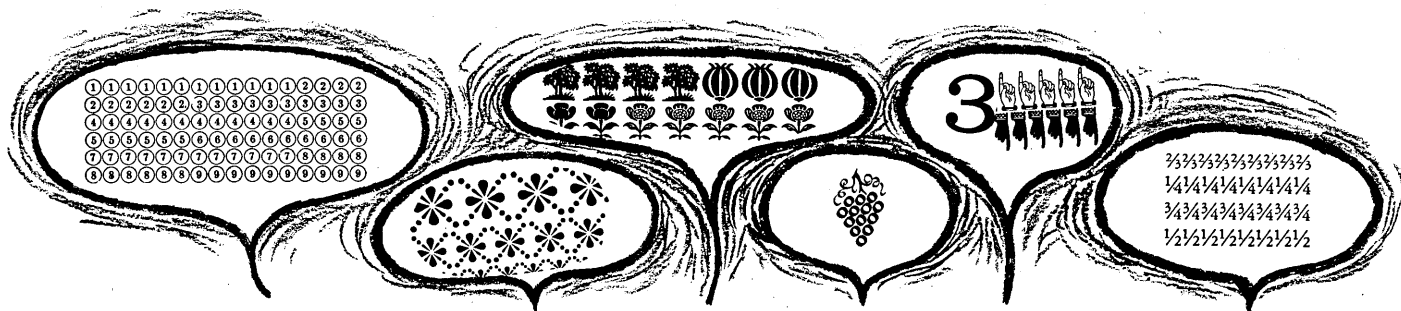

## *computer specialists conclude discussion of perennial professional society question*

On March 2, a day prior to the 1959 WJCC, a group active in computing met at the RAND Corporation to discuss some of the problems plaguing the industry. The discussion was recorded and printed copies were prepared and submitted to each individual for editing of his own remarks.

Among the topics covered was one dealing with what many of those attending felt was a lack of a unifying organization in the information processing industry.

DATAMATION agreed that publication of remarks covering this subject might benefit the industry. In our last issue, we presented approximately half of this section. The remaining half is presented here.

Those attending the 1959 session were Herb Grosch, IBM; Morris Rubinoff, Philco; C. B. Tompkins, UCLA; Charlie Phillips, Dept. of Defense; Herb Bright, Westinghouse; Saul Gorn, Moore School; Al Zipf, Bank of America; E. E. Minett, Remington Rand; Don Madden, System Development Corp.; Ed Cannon, Bureau of Standards; Bill Gunning, Epsco-West; Fred Way III, Case Institute; Walt Bauer, Space Technology Labs.; Oliver Selfridge, Lincoln Laboratories; Jackson Granholm, COMPUTING NEWS; Paul Armer, Fred Gruenberger, and Willis Ware, RAND.

Again we remind our readers that the opinions expressed here are those of the individuals concerned and do not necessarily reflect the views of DATAMATION or any of the organizations and companies mentioned.

Mr. Tompkins has the floor . . .

Tompkins: We have a group here which has some sort of cohesion; it has some sort of opinion which undoubtedly could be sharpened with some thought on the subject, and it has a gallant secretarial staff. If the members of the group have any good ideas, plus any forceful remarks that may have slipped into this record, these could probably be put together and addressed in the form of a letter to a small number of organizations that we've been discussing. The group could say to each of these organizations that it feels that there is a considerable need for expanded activity (joint activities of the type that the JCC was first put together to do) and point out that one needs a little bit more authority to do this and so forth and so forth.

Gorn: Tommy, what is this group's official name?

Tompkins: This is an informal group meeting at RAND and that's all.

Rubinoff: But, that's the point, we came here agreeing to have an informal discussion. Nevertheless, I don't think you

have to worry because we have in this room a key man from all four organizations, one from NJCC, one from ACM, one from IRE, and one from AIEE. There is no fear that the spirit of this discussion will not get back to those four organizations. Formally, I don't think we should go on record with anything.

Grosch: I would suggest that the reluctance of this group to take any action be memorialized in a name: Maximum Utilization of Logical Equipment, or Mule for short.

Gorn: Would the host be interested in taking any action on behalf of the group?

Gruenberger: It seems to me the best action we can take is to publish the expurgated transcript.

Grosch: What we need are ideas. There is no lack of action if you have objectives. We could always send Paul out with this banner flying if we only know what the banner should say. He's already told us what the incumbents are planning to do, and it sounds awful.

Gorn: Paul is scarred from several previous excursions.

Grosch: I know, I know!

Gorn: Morris and I and a few others have been making noises within various organizations for some time.

Gorn: One thing that RAND could do immediately is submit an expurgated version of the transcript of this meeting for publication.

Gruenberger: If we wanted to submit a letter it would take us at least until 8 o'clock tonight just to compose the first paragraph.

Grosch: If we really had something that we all wanted to push, any one of us could write an umpteen-page letter which could be published in any number of places. The point is, we don't know what to put in the letter.

Gorn: I think if we gathered together for the specific purpose of making such plans, that we could.

Grosch: I wish we would then.

Tompkins: I don't think we have to get together to do it.

Zipf: You gentlemen drew an analogy between the association you're talking about and the American Medical Association. It seems to me there's a basic difference. The AMA has a common customer, if you please, since everyone gets sick at some stage in the game. Maybe, collectively we are sick. One thing that has impressed me about all these societies is that none of them has attempted to cultivate representation from users. If this is their intent, then that's fine. But it seems to me that many of the problems we have talked about today are simpler than that (we started out by spending a great deal of time trying to design a more sophisticated computer system this morning) . . . I think we have to start by getting more people to be able to use what we have in order to expand the plan; and get the money from the "money places" to make it interesting to improve upon what we have.

Grosch: Al, I would like to comment on one thing you mentioned—the users not being in the Medical Association.

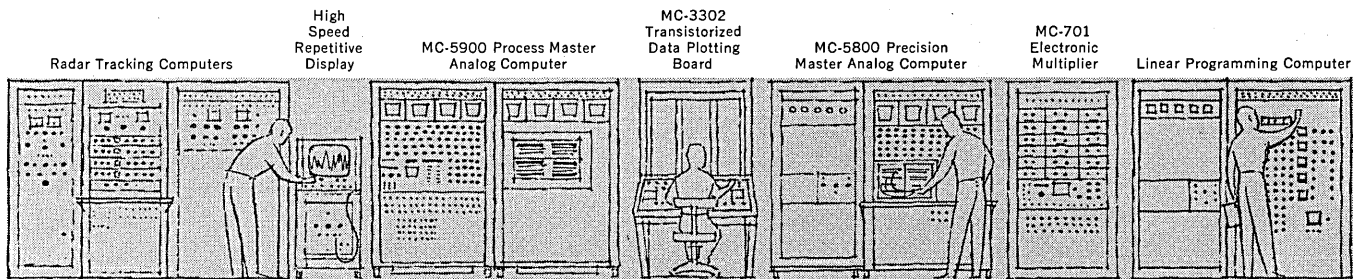

**Some people can prove man and mouse are identical**

It's all according to the points of similarity you choose. Differences are what really *prove* the superiority of man over mouse. Computers have differences, too. In fact, it's in these differences that the CSI-designed MC-5800 obsoletes every other Analog Computer. The best proof lies in

cold  
hard  
Specifications

- Exclusive dynamic memory makes automatic iterative solution of statistical or optimization problems a reality.
- Stable amplifier operation over the entire feed-back range from zero to infinity.
- Lowest amplifier grid-current <math>10^{-9}</math> ampere.
- Amplifiers provide lowest noise level output—less than one millivolt at unity gain.
- Amplifier frequency response—flat to 10,000 cps and only 3 db down at 28 kc.
- Real-time precision @ speeds to 60 solutions/sec.
- Exclusive electronic generators of the function of two-or-more variables may be programmed at patch-board in same time required for setup of single-variable generators.
- Will program 134 amplifiers, 30 electronic multipliers, 18 diode function generators, 2 time-delay generators, 8 relay amplifiers, and 6 servos from one 2128-hole patchboard.
- Highest performance electronic multiplier—flat to 10,000 cps and only 3 db down at 20 kc.
- Dynamic memory + high-speed quick-reset rep-op provide practical approach to solution of simultaneous partial differential equations.
- Dynamic memory with time-base accuracy of  $\pm 10 \mu\text{sec}$  provides automatic parameter searching by iteration—an exclusive capability.
- Solution of problems with up to 15 amplifiers in closed loops.
- Plug-in dynamic components ease maintenance.
- Lowest computer cross-talk—rejection greater than 2,000 to 1.
- Selection of real-time, expanded-time or high-speed compressed-time without reprogramming.
- Passive networks stabilized at  $< 1^\circ\text{C}$  above room ambient—no oven required.
- EVERY SPECIFICATION IS GUARANTEED TO BE TRUE PERFORMANCE STANDARD—IN SUSTAINED OPERATION.
- Only diode function generators utilizing resistors, potentiometers, and diodes of equal quality to those in computing networks.
- Only diode function generators with individual hi-lo gain positions for *each* segment.
- Lowest function generator drift  $< 5 \text{ mv}/8 \text{ hrs}$ .
- Lowest servo step-function overshoot—less than 1%.
- DC tachometer feedback on all servos.
- Complete control of all amplifiers, multipliers, dividers, and non-linear equipment at patchboard.
- Exclusive equipment-door packaging for free access and quick maintenance *without* shutdown.
- Insulated patchboard prevents costly shorting accidents.
- Power supplies eliminated from console—lowest, most stable operating temperatures—rise  $< 3^\circ\text{C}$ .
- Field expandable without mechanical rework or rewiring.

There are many more differences (over a hundred, in fact). Before you buy or lease your next analog computer, compare them all... and we think you'll agree with us when we say: The MC-5800 obsoletes every other analog computer made.

Computer Systems, Inc.—designers and manufacturers of the *highest* precision analog computers and computer accessories.

# MAN IS A MOUSE



**COMPUTER SYSTEMS, INC.**, 611 BROADWAY, NEW YORK 12, N. Y. • SP 7-4016  
A Schlumberger Subsidiary • formerly Mid-Century Instrumatic Corp.

Circle 9 on Reader Service Card.

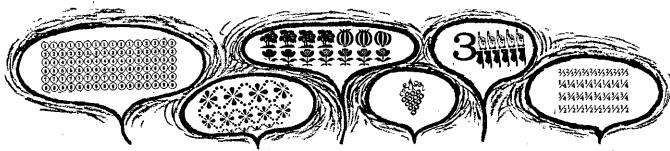

You don't give enemas with a stethoscope—the tools of medicine are specialized. But our tool is capable of doing nearly anything, at least in the low energy realm.

Gorn: Except give an enema!

Grosch: Instead of customer, I would like to use the term *applier* of this equipment. (To be sure, this *applier* frequently pays rent to a manufacturer.) To make a computing system work, you have to have some hardware. But, after you have the hardware, you have to adapt it to the problem. And, the people who do that adapting are as valid to our organization as the hardware boys.

Gorn: That's why I think such a society should have an advertising function and a training function, and that's why I thought it should be connected with the universities.

Grosch: As long as your joint operation, whether the JCC or a successor to it, derives its power from other organizations, it's going to be mighty hard to provide such functions as having a front man, pushing for education, and the like. Those things are functions of the member societies too.

Ware: Herb, it's even worse than that because the authority would derive from only a part of the member organizations.

Rubinoff: That's part of Herb's complaint. The ACM is the only organization that can say that that is its only endeavor.

Grosch: Now, ACM would naturally be a member of this new organization. I think NMAA should be, but I doubt if they would.

Gorn: I think you're selling ACM rather short here; I think they could pick up the ball.

Tompkins: I don't think they should.

Rubinoff: (a) they should have; (b) they could have; and (c) they didn't.

Tompkins: There is a local need in the ACM area for a good organization. Whether ACM is a good organization or not is another question. But, if there is to be an overall unifying organization, then I still think it should be an organization of organizations. I don't think it should be a membership organization. If ACM decided to take over this job, then they would have to sub-contract what they regard as their original function.

Gorn: Then, which one of these sub-organizations would have the advertising and training function we were talking about before?

Tompkins: Each of them has these functions to a certain extent in its own field now; to the extent that advertising and training cut across the domains of two or more of the fields, it should be done by the super organization. After all, that was the idea of the super organization.

Gorn: Now you're beginning to write parts of the constitution as well as the preamble.

Tompkins: I think maybe we have to write parts of the constitution.

Minett: If you had this super organization as we've been calling it, composed of member organizations, what would happen if ACM suddenly came alive?

Gorn: All we'd have then is that ACM would be taking a larger part in the activity than we might have expected.

Tompkins: ACM, in this society, should probably have the same role as that of the American Physical Society in the Institute of Physics. It should most likely be the most important single member of the society.

Minett: I wonder though, if this should occur—that you have ACM acting as a member society in a super society—and if ACM's full commitment would be to the super society, whereas the commitment of almost all other member societies would only be partial, then the other societies would readily perceive it. I think the other societies might then be very reluctant to be represented.

Rubinoff: I don't think so. Assuming that the super society is a society of societies, then those who are interested only in the computing aspect of the business as such would

join ACM. Those who were interested in hardware would go into AIEE or IRE, which should be merged in any case. If they were interested in business problems and the way computers affect business problems they might join NMAA.

Minett: I'm not the least bit concerned about individual members. As Herb pointed out, an individual can have many interests and many loyalties and doesn't get into conflict with himself because he has joined many organizations. The problem here lies wholly with the entrenched leadership. Also, the inflexibility of the constitutions of the member organizations would cause a lot of trouble here.

Gorn: The problem now is not the complete inflexibility of the ACM constitution, but its complete amorphousness.

Minett: I'd like to make a suggestion about the ACM. If there is any merit to a sort of a bicameral operation, (individual membership and other society participation), perhaps then the present ACM members should be looked on as the nucleus of the individual membership in this new operation.

Bright: Should user's groups get involved in such an operation?

Gorn: You have to be just as sure that there isn't pressure on the part of particular users as you are that there isn't pressure on the part of manufacturers.

Rubinoff: There should be one group that represents all users groups in this national body.

Minett: I should think that each individual user's group would have just as legitimate a claim to representation as AMA, NMAA, SIAM and all the others.

Rubinoff: The undertone of what Paul said was that NJCC is in existence and has a vast vested interest. They have a prior claim. Therefore they will be the representative. If other organizations want to come in as second class citizens and affiliate, they can. I personally object to that.

Armer: That's how ACM got into NJCC, isn't it?

Rubinoff: Oh, no.

Armer: Well, I wasn't around to observe it personally, but ACM was essentially a second class citizen for a period of time.

Grosch: It certainly didn't put any money into the early JCC.

That's a pretty good measure of importance.

Rubinoff: Are you implying then that all affiliates after a year or two will be given the privilege of becoming first class members?

Armer: It would be expected that things would go this way, yes. Some may decide to withdraw altogether.

Gorn: It seems like we've been answering question number 4: What Can be Done to Increase the Effectiveness of Our Professional Organizations? and the answer is, "create a new one."

Grosch: Not exactly. I figure if we had this society of societies the JCC would disappear, so essentially we haven't added anything. If we really added a brand new society, it is highly likely that ACM would disappear—at least, I hope it would.

Gorn: But, ACM is in the throes of trying to find out the extent of its own amorphousness and decide what its justification is. Don't we want to try to work within ACM for a while and see what happens?

Armer: I could make the same speech and substitute NJCC for ACM.

Minett: What we're doing here today is in many ways what we should be doing within the framework of ACM.

Gorn: Why do you feel, Paul, that nothing is happening?

Armer: Well, for one thing, there are too many people who are happy with the status quo; they resist all change.

Grosch: How many supposedly warm bodies have a vote in the ACM on a matter as important as this?

Armer: Roughly 20.

Gorn: When I first raised the question in the ACM of a new preamble, apart from a new constitution, with the current president, Hamming, his reaction was to whistle. It was thought that there are all sorts of problems involved, but there are a number of people on the council who are now pushing the idea. Members of the editorial board are going to be pushing a corresponding idea for reasons I indicated

# IBM<sup>®</sup> APPLIED SCIENCE...

*a professional career*

*that didn't exist ten years ago offers*

## *BROAD NEW OPPORTUNITIES*

Ten years ago, the Applied Science Representative was almost unheard of. Today, at IBM, he has a "frontier" career with all the associated challenges, excitement, and opportunities to make rapid progress based on personal capabilities.

The IBM Applied Science Representative is a professional consultant to the top echelons of business, industry, and government management. He deals with the mathematical formulation of scientific and management problems and proves the feasibility of solutions with electronic data processing systems.

Successful men and women candidates will be given comprehensive training to equip them to direct their education and talents toward a successful career in Applied Science.

*You can become an IBM Applied Scientist, if:*

- you have an M.S. or Ph.D. in engineering, mathematics, or one of the physical sciences . . . or a B.S. in engineering, mathematics, or one of the physical sciences and a Master's degree in business administration.
- you have a B.S. in mathematics or one of the physical sciences, plus experience in computer programming.
- you are interested in exercising a free hand in assignments requiring fresh thinking and new, creative approaches.
- you are able to communicate ideas to technical and nontechnical people.
- you are interested in joining the leader in the fast-expanding electronic-systems field.

*For further information, contact your nearest IBM branch office, or:*

#### IN THE EAST

Mr. W. F. McClelland  
Manager of Applied Science  
IBM Corporation  
Eastern Region  
425 Park Avenue  
New York 22, New York

#### IN THE MIDWEST

Mr. R. W. De Sio  
Manager of Applied Science  
IBM Corporation  
Midwestern Region  
618 South Michigan Avenue  
Chicago 5, Illinois

#### IN THE WEST

Mr. L. C. Hubbard  
Manager of Applied Science  
IBM Corporation  
Western Region  
3424 Wilshire Boulevard  
Los Angeles 5, California

*Applied Science Representatives are located in over 100 IBM branch offices throughout the country.*

**DATA PROCESSING DIVISION**



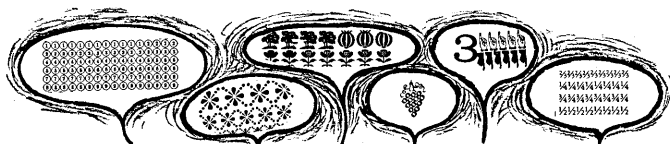
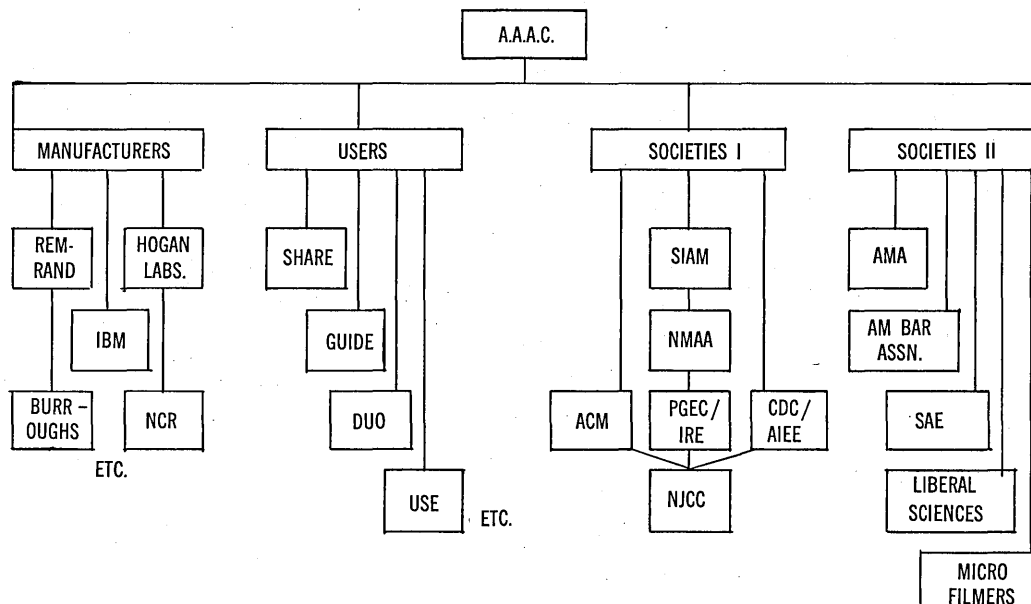

before and they are going to be represented on the council, so the question must come to a head in the council.

Grosch: I'm thinking that for a really radical action you might have to get something like two thirds of 20 people to agree to do something.

Gorn: If it involves any change in the constitution, then it will have to go to the whole membership.

[During the preceding fifteen minutes of discussion, Herb Bright was putting on the blackboard a diagram which eventually looked as illustrated above.]

Rubinoff: What Herb Bright has been putting on the blackboard looks very interesting.

Grosch: Yes, on the right we have one of those citrus trees that grows limes, lemons, and oranges all at once. In the middle we seem to have watermelons and cantaloupes, and on the left we have walnuts!

Gorn: From what we were saying before, almost all scientific societies would have to come into that chart at some time or other.

Grosch: I've never seen them joined together like that before, although it is a challenging possibility. You have, on the left, what used to be called RETMA and in the middle you have the suckers. On the right you have what amounts to the JCC. Boy, what a gaggle that's going to be! You can always take names and draw boxes around them and call it an organization chart. But I don't think it will work that way.

Bright: I'm not advocating it, Herb, I'm just trying to picture what we've been talking about.

Gorn: Let's take one example from that chart. The SHARE organization, in its own peculiar way, has that kind of structure; there's one section in SHARE that's worried about research and things like UNCOL...

Grosch: Saul, I'm glad you brought that up. I'd love to find a way to separate these conflicting operations in SHARE. The cooperative programming venture is one thing, pressure on the manufacturer is another, and things like research into UNCOL are again different.

Gorn: That's just about what I was going to say about this structure here. It would have the same problems that SHARE has.

Grosch: There is a certain log-rolling aspect to everything it does. No member ever says no to anything, and SHARE just inflates and inflates and inflates. This must not be for the organization we're discussing here. After all, we're com-

plaining about unsound organizations. We don't want to create another one.

(The group deviated from the subject briefly to discuss how and when the entire transcript, or parts thereof, would or would not be published.)

Cannon: I've had no experience in the formation of societies or councils but I think the more difficult course is the desirable one to pursue. I think the more difficult course is that of trying to form a society of societies, but I think there is a real advantage in forcing the IRE, for example, to realize that they have an interest here. To be sure, the society as a whole has other interests, but a large segment of the membership has an interest in information processing and that interest is likely to grow.

Minett: NJCC was chartered by these three organizations and it has a rather narrow charter from our point of view. It can't be changed by NJCC trying to change it; the organizations that chartered NJCC have got to do it. That means going to three organizations, or at least two out of the three, and asking, "Are you willing to recharter it?" At the same time you have to allow room for other people to get in and allow their agendas to change.

Grosch: If you would let interested parties (and I'm speaking now of individuals rather than organizations) read the unexpurgated version of this transcript, I think two out of the three organizations would immediately vote no. I think the IRE might say yes, but ACM and AIEE would certainly say no.

Rubinoff: I think you're guessing wrong.

Ware: It takes three out of three.

Grosch: Our legal advisor here says it takes three out of three and I know that ACM would vote against it.

Rubinoff: NJCC is a structure which is definitely very difficult to manipulate. For one thing, it takes a long time to do anything and for another it requires unanimous agreement among the three groups. It's like the CIO was when it started off; it's just a committee. It's quite different from what we're talking about now; that is, an organization to represent societies.

Minett: What you want is a majority rule operation.

Rubinoff: But you want to give this organization some authority so that it can take action in a reasonable amount of time, not in a year or so. The NJCC has very little power to do the kind of things that Herb was talking about, like disseminating literature and to make known to people what is going on in the computing world. Its major activity is the running of the Eastern and Western Joint Computer Conferences.

Ware: The details of which it hasn't done too much about.

Rubinoff: That's right. All it really does is elect a local chairman and let him worry about the conference.



*electra/JET courtesy of Western Airlines*

Another Consolidated Systems achievement. Today, a national effort is being made to collect flight load data in military and commercial aircraft. The goal is statistical prediction of structural failure and engine malfunction—Air Safety. By editing large amounts of analog data at high rates of speed and conditioning it for entry into a digital computer, Consolidated converts the measurement of physical quantities to significant figures...bridging the gap between raw data and air safety. For full information write for Bulletin CEC 3021-X2.

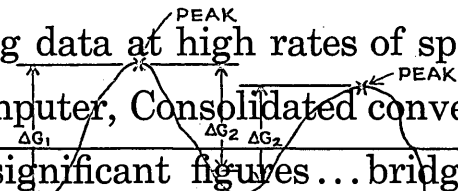

**CONSOLIDATED SYSTEMS CORPORATION**

1500 S. Shamrock, Monrovia, Calif.



A SUBSIDIARY OF CONSOLIDATED ELECTRODYNAMICS

GL1

High-speed Translator and Editor System converts analog records to digital form 100 times faster than original recording speed, condensing 50 hours of recording into 30 minutes. Editor digitizes only specified peaks, thereby reducing data by 80 to 90%. These values are recorded for entry into an IBM 705 or Burroughs computer.

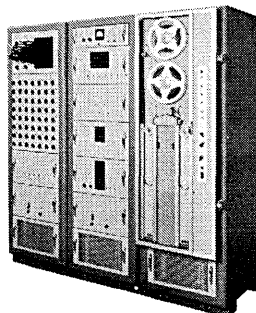

Circle 10 on Reader Service Card.

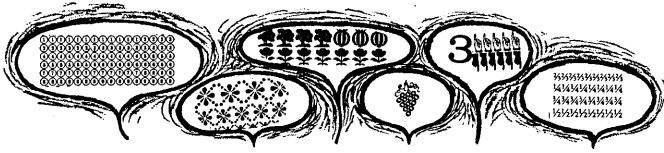

Bright: And it could continue under this new arrangement as a working committee.

Grosch: There are three alternatives we have discussed. One alternative is for the JCC to change its structure. We seem to think that this won't work because even if the JCC had the willingness to do it they don't have the power. A second alternative is to reformulate the objectives of the ACM and its council. We ruled this one out on the grounds that the ACM has the power to do it but not the willingness. And the third alternative is to form a brand new society that would presumably have the power and the willingness but doesn't even exist. So it looks like we can't move.

Bright: How about a show of hands, right now, for those who would honestly favor something like an Institute of Societies?

Gorn: I don't vote either way, because I want to think about it. My tendency is to try to reformulate the ACM.

\* I see nine hands.

\* There are three who want to reformulate the ACM.

Grosch: And, I'd like to start something new; that makes one.

Bright: It wouldn't hurt to improve any organization that is a member of such a council. If any of them have rats in the basement it would be well to set a few traps.

Grosch: I can't see the ACM setting any traps.

\* Why do you say that the ACM has rats in its basement?

Grosch: The rulers of the ACM have made it what it is today, so you can hardly expect them to change. The ACM Council could sit down and rebuild itself if it wanted to, and do everything we've talked about. But I remember year after year the excitement about whether the ACM should accept advertising so we could get money and do bigger and better things, and the answer was always, "who needs money?" And it was true: for what they wanted they didn't need money, and they didn't need advertising. And now they want to raise money for of all things, a Review Journal!

Gorn: When they asked me to start the committee rolling to start the Communications, they told me that the society could afford it. And, a year later, they said, "this is losing money; we've got to do something about it." Actually, they were not projecting the increasing income from advertising.

Grosch: When I was president of the American Rocket Society in 1951, we were trying to get off the dime. It was perfectly clear to the board of directors that first you got a good technical journal and with that, you would draw membership. Then with a substantial circulation you could solicit advertising, which would raise money. You could then afford to have a good executive secretary, who could do some decent planning. After that, you start a news journal running, and then build working technical groups and student chapters. I got the technical journal going in 1951, and in 1958 they had a budget ten times the one I had in 1951.

\* How big is it?

Grosch: When I was president, the ARS had about 1500 members. Now it has 20,000. I'm not talking about the money that went directly to the publications; I'm talking about the working budget for salaries, office expenses and the like. The whole thing went just like clockwork. And they haven't had the growth that we have. You think of Sputnik as starting a boom, but actually there was a lot of dough being spent in rockets and missiles in 1951.

Madden: I don't really believe that we're so far from accomplishing this. I ask you to look at the last election. The margin was pretty small. Paul, here, might have been president of this organization. If he were, he'd be pushing pretty hard, and this kind of enthusiasm gets you support. If that had come about we'd be a long step toward going where we'd like to go. All except for this small margin.

Bright: Let me make one observation about the ACM

Council. It seems to me that as long as I can remember there has been one guiding philosophy; namely, that they hate the name of this society.

Grosch: How do the engineers here feel about the ACM expanding to become a great new society? I'm surprised we haven't heard from them.

Rubinoff: Whom, here, are you calling engineers?

Gunning: Well, I'm one, and I can't see that it would make much difference. It's going to be such a big and general thing anyway.

Grosch: I would think the engineers would say, "We're not going to have any votes, with all these gosh-durned programmers around the place."

Rubinoff: That one I'll subscribe to.

Minett: Since 1948 I've disliked the name of this thing. It seems to me it's too hardware-minded.

Gorn: Remember two years ago it was mighty hard to get programming information into the journal. And that has changed.

Grosch: The name sounds like hardware, and the membership interest seems to be mainly applications.

Rubinoff: And scientific applications, at that.

Ware: There seems to be a gentlemen's agreement between the ACM and the PGEC to keep the division that way.

Bright: Maybe if we changed the name from the Association for to the Association against Computing Machinery, it would wash better.

Grosch: I think all you would have to do is add one word and make it the Association for Computing Machinery Users. That was what we (the 30 or 40 guys who originally met at Columbia) originally intended.

Rubinoff: But, the session at Aberdeen had designers and hardware implications in it.

Tompkins: There wasn't really that. I was there too. You have to remember that there weren't any machines at that time. There were three or four little ones and a lot of punched-card machines and that's about all.

Grosch: We solved partial differential equations on 601's, which was a pretty good trick.

Tompkins: I know, but that's all we had and the users were clamoring for some machines that they could use. The potential users at that time were trying to get their finger in the design of the forthcoming machines.

Gorn: I think we agreed this morning that we did not want to separate the designers from the programmers.

Grosch: I don't want to separate them. I was describing a name change to describe the present society more accurately. It's much healthier to have them working together. But I want them in a position where they can function effectively. I don't think they do right now; at most they clash, and usually they don't interact at all.

[The discussion went off at this point to the question of working hours for programmers (pregnant or otherwise).]

Bright: Do you people really want to let this question of a super society just fade away?

Rubinoff: It won't fade away, Herb, don't worry. There are a number of people here who will carry the ball to several organizations.

Armer: I'd like to hear more discussion about it. In particular, a few people said that they were going to object to my committee's report and Ruby said he was going to vote against it. But, in all this discussion, I didn't hear of another single proposal that anyone was willing to argue for. Why do you object?

Gorn: Too little, too late.

Armer: Too late, we can't do anything about. But, maybe we can do more. What would you like us to do?

Grosch: We have existing forces in the field that will not retire. This includes not only human beings but organizations made up of human beings. I think there's a need for us to do something different, but maybe it isn't possible.

Gorn: It seems to me that some of those forces you're talking about recognize that they should have done something earlier, and are now retiring.

Grosch: There is no question that, on an absolute scale, things are getting better all the time. Paul's position, his committee, the interest that senior people are taking in these problems, all these things are good. I'm just afraid



Royal Precision

# LGP-30

## Large-scale electronic computation at desk-side

Operating from any convenient wall outlet, the powerful, low-cost LGP-30 gives you the full flexibility of stored-program operation with an unusually large memory of 4096 words—*2000 more than the next computer in its class!*

Because the LGP-30 command structure and controls have been remarkably simplified, you require only minimum experience. You get complete format control...alpha-numeric input-output via keyboard or punched paper tape. No additional equipment is required for operation although, if desired, a high-speed photoelectric reader—with or without mechanical punch—is available.

The greatest computer value in the market, the LGP-30 requires no expensive installation or air-conditioning. It may be either purchased or leased. Customer training is free. An extensive library of programs and sub-routines is available—as well as membership in an active users organization.



## Royal Precision Corporation

Royal Precision is jointly owned by the Royal McBee and General Precision Equipment Corporations. LGP-30 sales and service are available coast-to-coast, in Canada and abroad through Royal McBee Data Processing offices. For complete information and specifications, write **ROYAL MCBEE CORPORATION**, data processing division, Port Chester, New York

Circle 11 on Reader Service Card.

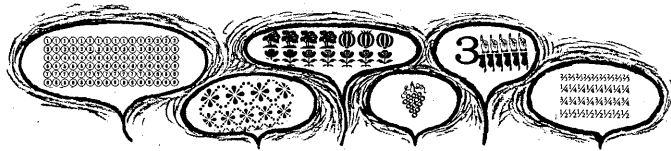

that the absolute improvement is less than the growing need and hence our relative position is getting worse. The opportunity to do good is so much greater than it used to be, and this makes the situation worse when we only do a little. I realize that this is just a polemic, and it's rather vague.

Gorn: Actually, the main objection within ACM to such an idea is that it might alienate the rank and file who are not interested in such academic questions.

Grosch: We don't know what the gross population of our field really thinks about this. There is no single organization of all those listed on the board, that speaks for all of these people, or even asks good questions.

Let me give you a case in point. I get three national rosters that come around. I get one from the Institute of Physics; one from some mathematics outfit; one from an engineering group.

None of these three does anything like justice to the computer business. The mathematics one is getting there, but it has nowhere near the detailed breakdown of skills and abilities that we should have. One of those rosters ought to come out of this outfit.

Gorn: And, what about the people who design the national roster of scientific personnel? They have to be made aware of the skills in computing.

Grosch: Much information is available to us if we would go out and collect it. We could talk to the directors of institutes, professional societies, government agencies, people who run these rosters, the National Academy of Sciences...

Now there's another problem. Since we are not a united discipline it is extremely difficult to get our members into one of the fancy groups. How would we get a computer man into the National Academy of Science, for example? In the Academy there will be an outstanding physicist, an outstanding psychologist, and so on. But a man wouldn't have a chance just because he's a hot shot in the computer racket. So we don't get proper representation.

Gorn: We can still use the method of getting him in under one of those other disciplines.

Grosch: Well, of course. And this has been a problem with all new disciplines. On the other hand, we're going up awfully fast.

Selfridge: With the improvement in status going up so fast, you must be happy with the first derivative, and not with the absolute position. How is the increase in recognition going? Is this really unsatisfactory?

Grosch: I think it is.

Way: I think part of the problem is that we don't have a catch-all title for people in this kind of work.

Gruenberger: So, we need a name.

Armer: Herb, I'd be interested in knowing how you reached your figure of 50,000 people in this field.

Grosch: It was largely intuitive. A considerable portion of the people who are interested attend the major conventions. If you add up the attendance at our major conventions, some 20 thousand different people attend who represent some 50,000 people who are interested but can't come that year. Remember, I'm including information theory people, the business guys, the component men and so on.

Phillips: How many people are there on your joint mailing list these days?

Ware: About 22,000.

Phillips: The bureau of the budget made a survey recently of the Government people in this field (figuring that the Department of Defense had about 80% of the computers) and they came up with a figure of between 5,000 and 10,000. This includes both scientific and business type operations, and both operating and managerial people, with a primary computer occupation specialty.

Grosch: Well, IBM alone has close to 10,000 interested in this racket, including professional and quasi-professional people.

Rubinoff: It would seem clear that if you take in such fields as automatic control using computers, rocket guidance,

\* You can get the 50,000 real easy.

Grosch: And, if we wanted to get real wild, we could put in all the librarians, all the microfilm operators...

Armer: The first derivative out in this area is tremendous!

Rubinoff: It seems to me that when we were discussing this before lunch, we were looking at it through very narrow eyes. The influence of data processing on our society is very large and going off in all directions. Consider for example the people in psychology, linguistics, economics, and even medicine, who are now beginning to think of the impact of data processing on their fields. It is for this reason that now is the time to act before we have fifteen new splinter groups.

Rubinoff: We don't want to have many organizations. And if we do have many such, we want to have one organization to provide unifying professional status to them. If we don't do it now, then ten years from now we will regret it.

Bright: Morris, are you thinking about separating the sheep from the goats, in this institute?

Rubinoff: First tell me whether I'm a sheep or a goat.

Bright: I think we have to remember that there are two kinds of societies here, as regards loyalties. One is the kind whose primary interest is in machines as such; parts of IRE and certainly all of ACM, SIAM, and NMAA are in this category. Then there are others, of which I think SAE is a prime example, who have a sort of secondary interest but would want a voice, perhaps not the same kind of voice, maybe a different color voice.

Armer: I agree with this dichotomy. The primary group consists of those who are interested in information processing for the sake of information processing.

Grosch: There were five hundred civil engineers who came to a meeting in Kansas City because of their interest in bridge calculations, cut-and-fill calculations, and so forth. I was never more surprised in my life. There was a whole hotel full of them. I thought there'd be about eight guys and one Bendix salesman.

Bright: There could be a place for such people in an umbrella-type organization, with perhaps a newsletter devoted to just their interests. We might even get to the point where the organization could afford a 407 to check program decks before they go out, which I understand IBM can't in New York.

Grosch: Our machines are in such demand that it's getting very difficult to afford one for our own use.

Bright: This wasn't the story I heard.

Grosch: Let's not look on the black side of things!

Armer: They could afford it, they were just too cheap.

Gorn: Well, Herb, what do you think we ought to do?

Grosch: I'm beginning to think maybe I ought to take back the remarks I made about the chart that Herb is putting on the blackboard. Maybe he has created a new kind of organization by simply tying together these widely disparate groups. Just think what an empire he is creating for someone.

Bright: You'll notice that although we have some sort of name for the organization at the top [pointing to the initials AAAC (representing American Association for the Advancement of Computation)] we've left out the important point; namely, to whom this organization reports.

[At this point Bright lettered on the blackboard at the top, the initials HRJG.]

Grosch: Seriously, it seems to me that the flow of information, the flow of authority and the flow of money on that chart, are all mixed up. Generally, an important thing about an organizational chart is to have all the things that flow, flow in the same direction.

Rubinoff: You mentioned a problem before; namely, that not everyone has the same amount of interest in the computer field. Normally, I think in terms of things like automatic control and their use of computers, but we have in this room a man from the Bank of America. You could hardly say that the Bank of America's primary interest is in computers. On the other hand, this is getting to be a very important aspect of their work. Similarly, it is important in a lot of other fields, from missile guidance, to automatic con-



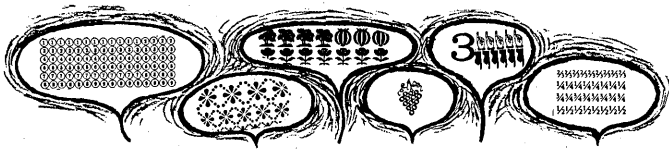

trol, to accounting, to industrial process control. All such people should have a representation, somehow. In this sense, it's different from automobiles.

Grosch: There are two kinds of representation. One way is to have a committee or an elected representative of something like the American Banking Association participating in a society of societies. The other way is to make known to those individuals in the Bank of America, say, that there is a home for them up yonder at 10 dollars a head. Which route do we want to follow? The problem of getting worthwhile action from as disparate groups as we have on the blackboard would make it impossible for someone to go down and testify when ERMA blows up and the entire economy of the state of California grinds to a halt.

Tompkins: Of course, they said the same thing about the United States of America when the proposal was first made to weld together disparate groups like the New England states and the central states.

Gorn: Herb's objection is quite valid. On the one hand you have those who are interested in communicating controls and on the other hand those who are interested in controlling communications. These are very different people.

Way: How do you tell when a professional is a professional, Herb—when he kicks in the ten bucks?

Grosch: Roughly speaking, yes. There has to be some feedback in the loop; especially in the early days, he has to have some say in what the organization gives him for his 10 dollars. The trouble here is that the interest of any one of those constituent outfits is so different from the interest of every one of the others. In that situation, how could they ever get any action?

Way: I'm tempted to go with you on individual membership, for just that reason. But, are you going to get enough people?

Grosch: I think that many outfits would wind up by sending observers, so to speak, and that isn't out of the question at all. The Standards Association has worked that way for a long time. Don't get me wrong; I'm not implying that this will become a Standards group.

Suppose someone in the American Bar Association develops a deep interest in information retrieval as related to legal procedures. I'm sure he would try to form a committee for that purpose, and either have the committee send a representative, or have the members themselves join.

Someone could knock on the door and say, "Gee, there should be a committee to look into the problems of the legal profession in relation to information retrieval." Then any lawyers within our own ranks would be an obvious nucleus of such a committee. If there weren't enough, then the outsider would have to say, "Look, I'll provide some lawyers and you provide information retrievers, and they can work together."

You notice that this list of interested groups can get longer and longer. We're going to eventually interact with nearly every professional society in the world.

Tompkins: But, they should no more be members here than they should be members of the statistical society.

Grosch: When you get right down to it, the key trouble is that we have two warring hardware groups and one poor moribund user's group, all trying to work together in this JCC farce. And what we have to do is sweep it all aside: we just have to start over!

Rubinoff: Let's look at the other suggestion that was made earlier. The ACM should have some new blood injected intravenously; the IRE and the AIEE should recognize that they are primarily electrical engineers with a side interest in computers as such, just as the American Banking Association has a side interest in computers as such. The ABA should participate in the construction of instruction catalogs just like the designers have to participate in the design of the hardware to implement those instruction catalogs. This all means that there should be ACM in the top box and all

computer activities should filter through the ACM. All other groups should then affiliate with the ACM. A lot of people are going to feel that they have had the rug pulled out from under them. But it is a solution. Historically, I agree with Herb. The ACM didn't even pick up the ball, much less have the chance to drop it.

Bright: You keep saying that this is virtually impossible, but yet I think this is just what has been done in the AAAS with most of the societies concerned. There are even some non-scientific organizations in it.

Gorn: If that is the case, then what you're saying is that the AAAS is that organization.

Bright: Not really; there could, though, be some staff connection.

Grosch: It should be pointed out that for years after its formation the AAAS never took a stand on anything. All it did was hold an annual meeting and publish a very innocuous journal. When they needed a Voice of Science to appear in Washington, it would be almost anybody except the permanent secretary of the AAAS. They are changing now, but only after the formation of the Federation of American Scientists and outfits like that.

This, of course, was a shameful gap. If there was any association of scientists that should have been able to step up and say, "This is wrong," to McCarthyism, it should have been the AAAS.

Bright: Then, you're saying that they're beginning to be the sort of organization that we're talking about here. They now say things in print, signed by an officer of the organization, and thus take an editorial stand.

Grosch: There are absolute gains in the ACM every year, but I think the urgency is growing faster; the relative situation is deteriorating.

Bright: A lot of the people here have some sort of executive connection with various of the societies that we have maligned. Suppose that we were to agree on some sort of joint pronouncement. How would it be if such individuals here were to take it back to the SHARE executive board and other noxious bodies and try to peddle it? Assuming that we could come to a meeting of the minds, perhaps the proper place to peddle it would be in the steering committees of the various organizations that would be affected.

Grosch: Would the RAND Corporation furnish the services of Paul Armer for a year, having him sever all other connections during that time? I'd sure like to see someone have a try at really planning this thing out.

Armer: Leaving personalities out of your last comment, you have an important point there, Herb. To do the job right would take a lot of planning and a lot of hard work. It could not be done by a committee which meets only periodically. A working group which holed up in some isolated spot for several weeks might get the job done, but a committee, in the usual sense, would never get any place.

Grosch: One way to float this new society, assuming that it's a society of individuals would be to launch it with a manifesto signed by the outstanding names of all the people who are interested in this. That means someone would have to go out and find out who the outstanding names are in the NMAA, for instance. I doubt if any of us know the leading lights in the NMAA or the Automatic Control group or many of the others. And you'd have to convince them, too, because they'd be signing this thing.

Rubinoff: The trouble with the Automatic Control people is that they would want us to sign their manifesto first.

Way: As far as forming a society of members is concerned, my experience in Cleveland indicates that I could go out and sell the idea to individuals in large numbers, but I'd have trouble in selling it to the local ACM chapters and it would be completely impossible to sell it to the AIEE.

Rubinoff: That's not true.

Way: In Cleveland it is. We happen to have the largest discussion group in town now, as a matter of fact.

Gorn: Look at the beginning of the Information and Control Magazine. This is a magazine that seems to be interested in the area as a whole. We should consider how they got started. They did not think in terms of starting a new so-

(Continued on page 44)



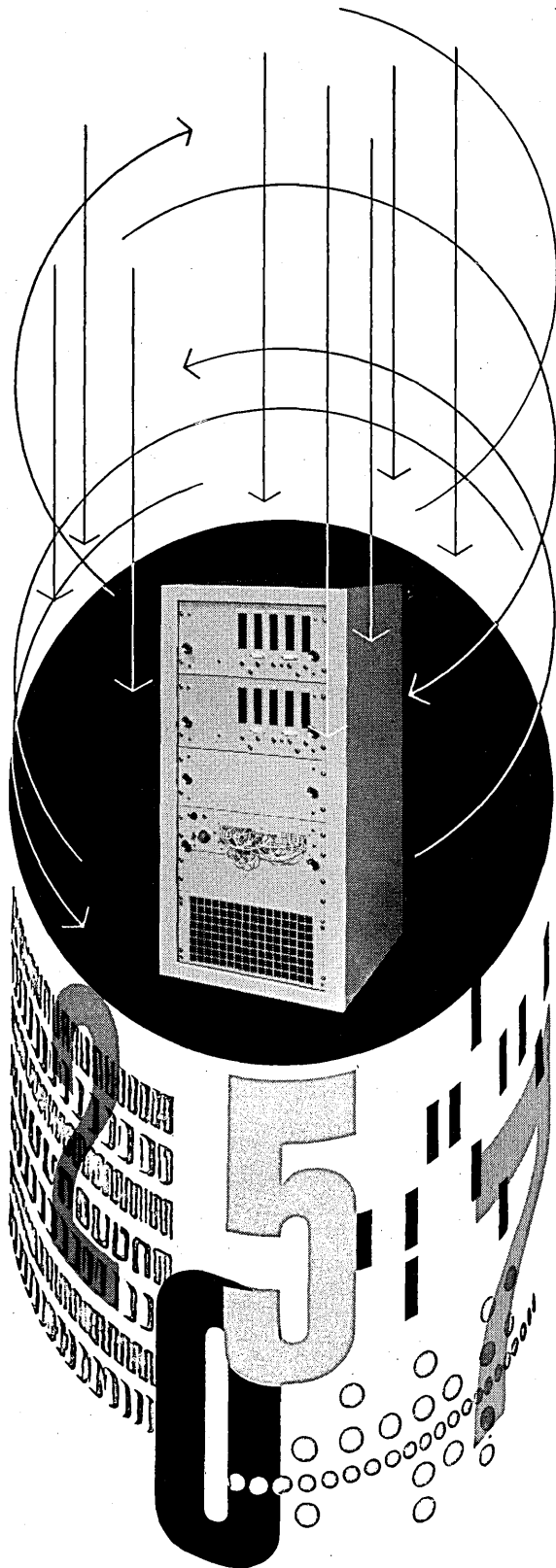

*new! from benson-lehner...  
the PIGMI automatically converts  
angular or linear position  
to recorded digital data!*

The new Benson-Lehner PIGMI (Position Indicating General Measuring Instrument) automatically records in digital form the angular or linear position of measuring instruments such as comparators, measuring microscopes, coordinatographs, etc. Digital output may be had in the form of punched cards, punched tape, magnetic tape or tabular lists. Operating at a counting speed up to 35,000 counts per second with a measuring range of  $\pm 99999$ ., the compact PIGMI is the fastest, most accurate device of its kind.

*For details, write:*

 **benson-lehner** Corporation

1860 Franklin Street • Santa Monica, California  
OFFICES: LOS ANGELES; WASHINGTON, D.C.; DAYTON, OHIO  
Service Center in 28 cities throughout the world.

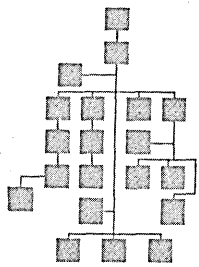

## people moving up in **DATAMATION**

Mrs. **Ida Rhodes**, Applied Mathematics Div., National Bureau of Standards, has been awarded the U.S. Dept. of Commerce Gold Medal for Exceptional Service. The citation — "significant pioneering leadership and outstanding contribution to the scientific programs of the Nation in the functional design and application of electronic digital computing equipment." Mrs. Rhodes was a featured speaker at the recent ICIP in Paris . . . Burroughs Electro-Data Div., named **Walter B. Claus** staff assist. to the director of manufacturing. **Brad McKenzie** is appointed manager of the dp center . . . Newly formed Computer Sciences Corp., has engaged **Dr. Charles Swift** (ex Con-vaire) as a computer consultant . . . IBM Vanguard Computing Center has named **Dr. James H. Turnock, Jr.**, project manager for Project Mercury. Other IBM appointments: **Kenneth N. Davis, Jr.**, controller; **George F. Kennard**, manager of r and e dept; and **Thomas R. Horton** manager of the systems analysis dept. — all at Federal Systems Div., N.Y.

**Dr. Finn J. Larsen** was appointed to the newly-created post of vp in charge of research for Minneapolis-Honeywell. Larsen, who joined M-H in 1948, continues to direct activities of the central research labs in Minneapolis. **Thomas H. Armstrong** has been named vp in charge of

marketing for M-H's Datamatic div. Armstrong's edp background spans 20 years . . . Aeronutronic's Computer Operations has promoted **Joseph K. Slap** to manager of product planning; **George D. Talbot**, to the dp staff; **Daniel F. Morrill** to the auxiliary equipment dept. Three key marketing appointments are: **Dr. S. Dean Wanlass**, marketing manager; **Steig Gavelin**, western representative; **Robert G. Evans**, special representative.

Epsco has engaged **Roy H. Callahan**, Rear Admiral, U.S. Naval Reserve, Retired, as director of operations. He will be directly responsible to the president for operation of company engineering, production activities. **Eugene S. Goebel**, former vp for market relations of Motorola, joined Epsco as vp in charge of marketing. Other appointments: **Bruce K. Smith**, asst. to the president, advanced product technology; **Elton Sherman**, manager; **Philip Hood**, production manager; and **Jack Haughey**, asst. manager of the newly-formed standard systems dept. **Howard Carter** joined Epsco-West as project manager . . . Tally register named **Frank C. Partin** sales manager — formerly asst. chief engineer. . . . Telex, Inc., systems & special products div., engaged **A. Jallen**, specialist in transistor circuitry design.

Promotion of **Norman O. Bender, Jr.**, to newly created position of operations manager for Transac computers, was announced by Philco's government & industrial div. **Robert E. Steele**, is named manager of product planning; **Robert A. Cohen** appointed to new position of manager-customer information services . . . Bendix Computer Div., named **Ronald Compton** senior engineer for computer design; **Stetson Avery** was made manager of the new district office in Detroit; **Herbert H. Jones** is now programming instructor . . . RCA's edp div., elected **John E. Johnson** vp and marketing manager. Johnson was marketing vp of M-H Datamatic Div., before joining RCA last year.

**James D. Bowles** heads Ampex Corp's newly formed Computer Products Organization (providing specialized engineering and marketing services) . . . **Robert D. Schmidt** is now sales manager for TMI's data equipment div. . . . General Petroleum Corp., moved **Arch B. Johnston** to the Socony Mobil Oil Co., methods research dept., in N.Y. Johnston is supervisor of data processing operations and research . . . **Colonel John C. Pitchford**, USA, retired, joined Benson-Lehner Corp., as project manager to study future developments of company's product line.

Appointment of **I. S. Lerner** as applied research director was announced by Royal McBee Corp. He directed business machines research at the instrument development labs. for past three years . . . Universal Oil Products Co., appointed **Dr. L. G. Massey** head of the computer dept. . . . **Harold Weiss**, now manager of applications engineering at GE's computer dept., will organize and staff an applications-engineering group.

IS. IDA RHODES  
National  
Bureau of  
Standards



F. J. LARSEN  
VP of Research,  
Minneapolis-  
Honeywell



R. H. CALLAHAN  
Director of  
Operations,  
Epsco



N. O. BENDER, JR.  
Operations  
Manager,  
Transac



J. D. BOWLES  
Ampex  
Computer  
Organization



I. S. LERNER  
Applied  
Research,  
Royal McBee

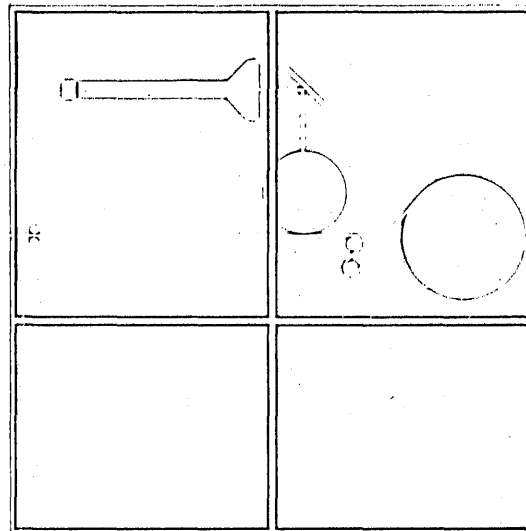
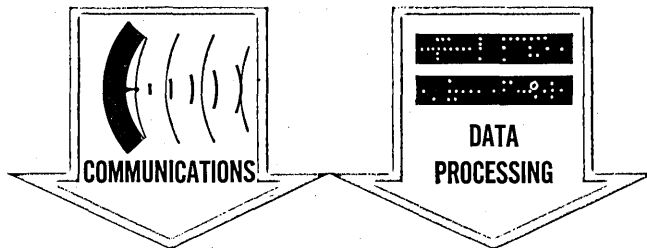

S-C 3000

# MOST VERSATILE OF MEDIUM-SPEED ELECTRONIC PRINTERS

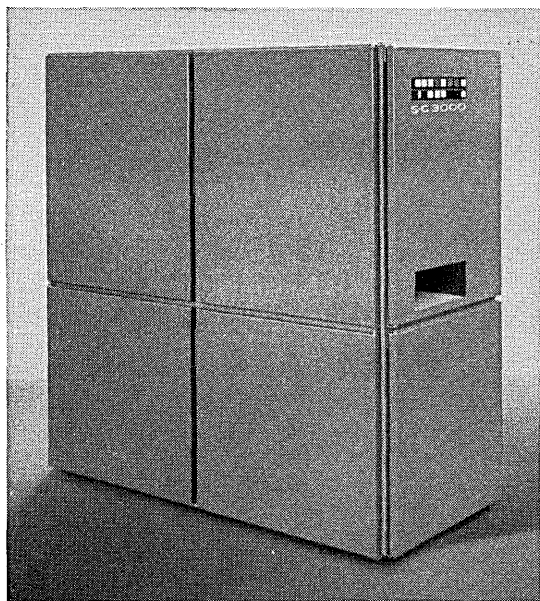

Printing ten to 10,000 words (500 lines) per minute, the S-C 3000 Medium-Speed Electronic Printer meets the demanding requirements of high-speed communications networks and data processing systems for reliable, economical printout equipment. The versatile S-C 3000 is compatible with most computers now in use and with such binary data links as telephone, telegraph and microwave. In addition to dry printing alphanumeric and symbolic data, the S-C 3000 is capable of facsimile reproduction. By combining the CHARACTRON® Shaped Beam Tube and the xerographic printing process, the S-C 3000 prints electronically on inexpensive, untreated paper — *without impact, without troublesome, high-speed moving parts, without use of liquid developer* — surpassing “high-speed” electromechanical printers in reliability, economy and simplicity of operation, yet printing at comparable speeds.

Send for complete information concerning S-C 3000 Medium-Speed Electronic Printers. Ask for Bulletin 9-C. Write today: Stromberg-Carlson - San Diego, 1895 Hancock Street, San Diego 12, California.

**STROMBERG-CARLSON**  
A DIVISION OF **GENERAL DYNAMICS**

Circle 13 on Reader Service Card.



*Invites*

## COMPUTER PROGRAMMERS

*To Join Its Expanding  
Scientific Community*

MITRE is a non-profit organization formed under the sponsorship of the Massachusetts Institute of Technology. Its nucleus is a Technical Staff of scientists and engineers with established reputations in the design and development of computer-based systems.

The organization's task is to provide the technical solutions to problems in the design, development and integration of large-scale, real-time control air defense systems. Ranging in scope from the practical problems of improving present systems through the design of future systems, MITRE assignments provide a unique multi-discipline environment in which significant contributions can be made.

System-oriented programmers with experience on large-scale computers will find opportunities to define problems and formulate solutions in:

- REAL TIME SIMULATION
- SYSTEM PROGRAMMING
- MATHEMATICAL MODEL MANIPULATION
- COMPUTER APPLICATIONS
- MACHINE DESIGN
- INFORMATION STORAGE and RETRIEVAL
- CODING TECHNIQUES
- SUBSYSTEM SIMULATION
- AUTOMATIC PROGRAMMING RESEARCH

These positions are available at MITRE's modern facilities in suburban Boston, Massachusetts, Fort Walton Beach, Florida, and Montgomery, Alabama.

To arrange an immediate confidential interview,  
please direct your inquiry to:

Dana N. Burdette, Personnel Director

**THE MITRE CORPORATION**

244 WOOD STREET — LEXINGTON 73, MASSACHUSETTS

*A brochure more fully describing MITRE and its activities is available on request.*

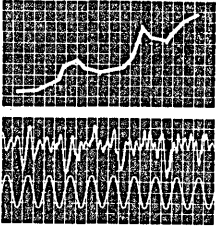

## DATAMATION *in business and science*

### RCA ON MOVE; ANNOUNCES 502, 503, 504

RCA, formerly a somewhat silent member of the Solid State Computer Manufacturers Association, began stirring around early this summer by announcing a series of 501 computer service centers (first now operating in Camden, a second to open on Wall St. early next year) and then really joined the publicity party by unveiling, the day after Labor Day, three solid state machines in the 501 series. Some specs for the 502, 503 and 504 were released in newspaper ads and we add these comments . . . The 502 is a stripped down system designed for firms with about 5000 points of EAM equipment. The 503 is the medium size model. Two 501 production systems (503 configuration) are now operating and a reliable source states that three a month will be coming off the line during the last quarter. This same source claims that 36 firm orders for the 503 have been received. The 504 will be in production in approximately 18 months. It is the largest of the series. While RCA was announcing little in the way of new information (modular design has always been a strong 501 selling point) they have definitely started an aggressive marketing campaign.

### IBM PLANNING MACHINE ANNOUNCEMENTS

Meanwhile, back at IBM, the world's largest computer manufacturer is not resting on its record. Word has it that due to necessary final product testing, the September traditional announcement of new machines has been delayed until early October. What will be featured? Probably a solid state machine called the 1401 (said to be somewhere in the spectrum of the 7070 class) and a desk size job called "Cadet." "Space" is the tag on a small business data processor which may be announced. Neither of these names is definite and in fact, according to IBM form, neither is likely to appear on the final equipment. In terms of size and price, "Cadet" is said to be somewhere in the range between the G-15 and Recomp II. There is at least a possibility that IBM might announce a solid state 705 (the 7050?). RCA seems to have caught IBM with its guard down by announcing the Wall St. computer service center (see above). About a month after RCA's move, IBM disclosed plans for setting up 25 to 30 datacenters in major cities. They will be stocked with 7070's. An IBM Wall St. center will be opened in March, 1960. And to put things back in perspective, a 705 III was moved into Bache and Co. in August. This was the first big machine on the Big Street.

### REMRAND RUMORS CONCERN NEWER UNIVAC

RemRand men are talking quietly about some new machines of their own. Current rumors concern a solid state Univac III (to be announced in 1960) and the fact that Larc will soon be commercially available (at half the cost but half as fast as Stretch). Due to mistaken information received by DATAMATION, three index registers for the SS-80 were listed in a July/August article as standard equipment. This is not correct. The register package leases for \$150 a month.





Exhibited at AUTO MATH 59 were three Ampex tape units—the FR 300, FR 400 and FR 200A. Also on display were read-heads, amplifiers and other components.

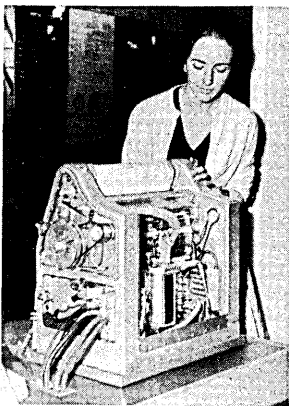

Creed's Model 1000 printer, billed as one of the world's fastest, is presently in prototype form. It can be used for direct online computer output or as an offline printer controlled by paper or magnetic tape. Provision has been made for automatic tabulation and form feeding at speeds up to 200 character spaces and 20 line spaces per second respectively.

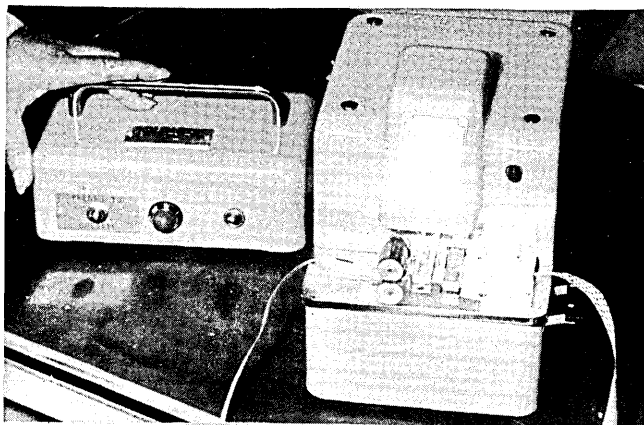

Shown at the NCR booth was this new British-made Elliot high speed tape reader which is designed to read standard 5, 6, 7, and 8 hole punched paper tape at any speed up to 1,000 characters per second. It can stop within a character. The characters are sensed by OCP71 phototransistors illuminated by perspex light guides.

Firms from all over the world displayed information processing units at AUTO MATH 59, the equipment exhibit for the International Conference on Information Processing held in Paris in June. DATAMATION presents briefs of some of these companies and their equipment.

Standard Elektrik Lorenz of Stuttgart, Germany, displayed their ER 56 transistorized computer.

Circle 104 on Reader Service Card.

Zuse Co., Bad Hersfeld, Germany, showed their range of computers: Model Z-11, program-controlled relay computer - binary, with 27 binary digits word length; Model Z-22 program-controlled binary - 38 binary digits, using a drum storage of 8,192 words rotating at 6,000 rpm.

Circle 105 on Reader Service Card.

Standard Telephones & Cables Ltd., Newport, England, presented the StanTec Zebra computer: serial, binary, 33 digits including 1 sign digit model; 8,192 words magnetic drum storage. Rotates at 6,000 rpm with average access time of 5 ms. A 5-channel photoelectric tape reader, max. 200 char/sec, can be used as input.

Circle 106 on Reader Service Card.

Creed & Co., Ltd., Croydon, England, exhibited an output tape punch and output printer. Model 3000 punch records computer output data in 5/8 track tape at 300 char/sec., with capacity of 120,000 char/reel. Model 1000 (experimental) serial printer operates from a 5 or 6 wire parallel input at 100 char/sec.

Circle 107 on Reader Service Card.

Bell Telephone Manufacturing Co., Antwerpen, Belgium, presented an Endless Loop Magnetic Tape Storage developed exclusively in Belgium, which can be exported to the U.S. but must not be manufactured here. Unit has capacity for 5 containers, 10-million character memory.

Circle 108 on Reader Service Card.

Facit Electronics, Sweden, displayed an ECM-64 Carousel memory; the Facit ETR 500 transistorized electronic tape reader; and the new ETP 150 high-speed tape punch with punching speed of 150 lines/sec., on 5 to 8-channel tape with 10 lines per inch. Feed and punching mechanisms are electromagnetico-mechanical.

Circle 109 on Reader Service Card.

Olivetti of Italy showed the Audit type accounting machine and typewriter, with numerical and/or alphanumeric perforator, a tape to card converter, a paper tape to magnetic tape converter.

Circle 110 on Reader Service Card.

Bull Machines Co., of France, displayed various logical elements, and a Gamma 60.

Circle 111 on Reader Service Card.

Societe Nouvelle d'Electronique, Paris, France, showed the KL 901 universal computer (arithmetic, parallel): word length is 30 binary digits, floating point, microprogramming by magnetic cores. Input is by paper tape reader operating at 1,000 char/sec., output on tape punch.

Circle 112 on Reader Service Card.

SEA (Societe d'Electronique et d'Automatisme), France, displayed their SEA 1080 high-speed punched tape photoelectric reader; CAB 500 universal binary computer, with word length of 32 binary digits plus sign. Memory storage consists of magnetic drum with 16,384 locations for 30 binary figures (8,192 immediately available).

Circle 113 on Reader Service Card

Benson-France, affiliate of Benson-Lehner, exhibited electroplotters, oscillograph trace readers, decimal con-

(Continued on page 34)

# ICIP

Delegates attending the International Conference on Information Processing were not surprised that the Japanese were present. The delegates were mildly surprised that Japan's computer manufacturers and users were in Paris in force and they were quite surprised at the fine quality and assortment of equipment made in Japan. "Very representative" and "clever" were the words heard most often to describe this equipment. DATAMATION presents some samples of machinery manufactured by three of Japan's largest computer firms.

## NIPPON ELECTRIC

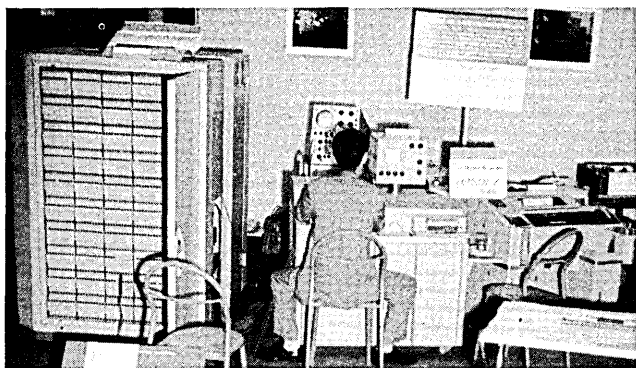

An operator sits at the control console of the NEAC2201 computer. The mainframe is pictured on the left and the input/output unit is on the right. The machine uses a 200 kc clock pulse and features internal programming. Operation code is  $1\frac{1}{2}$  address system and there are two index registers. Paper tape reader operates at 200 characters per second and the tape punch at 8 characters per second. There is no magnetic tape or external memory.

## OKI ELECTRIC

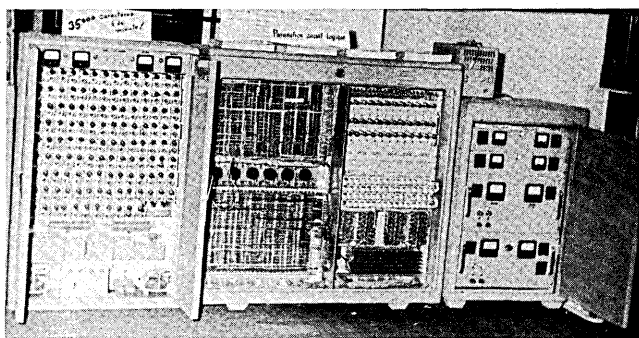

Left is the OKI model 58 photo tape reader which operates at speeds of 12,000 or 24,000 characters per minute. It reads photoelectrically 5 to 8 track punched paper tape. The printing unit (center) uses an endless motion steel belt mechanism which provides printing rates of 300 lpm. This can be increased to 600 lpm by using a special type driving belt which allows double line printing. There are 120 or 180 characters per line spaced at 10 characters per inch.

# JAPAN

comes to the party

## HITACHI

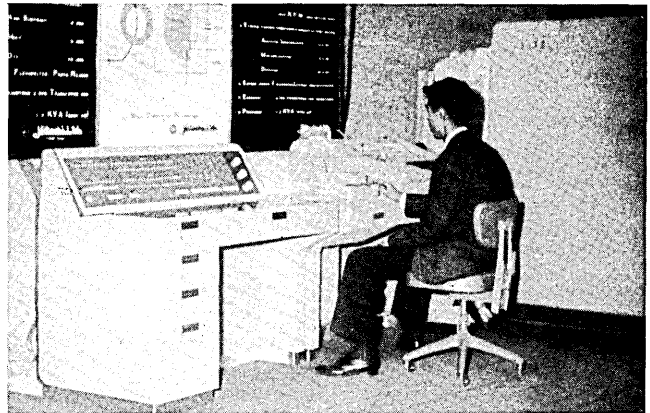

HIPAC 101 (Hitachi Parametron Automatic Computer) is a scientific machine made by Hitachi Ltd., of Tokyo. It is a medium-size, stored program computer using approximately 4500 parametrons, highly stable logical elements. To supplement the low clock frequency of the parametron, a parallel mode of operation is used providing comparatively high speed operation. Since two cycle counters (which modify addresses and count the number of repeat operations) are used, calculations can be carried out with few program steps. The 101 features decimal to binary conversion and is a fixed point machine. Punched tape is used for input and the machine contains both a phototape reader and a teleprinter-type tape reader but input can be accomplished through a special control code. Word length is varied—long words are 39 bits and sign and short words are 19 bits and sign. There are 44 types of instructions. Drum revolution is 9000 rpm and storage is 1,024 long words. The machine contains 500 junction transistors, 300 germanium diodes and 50 vacuum tubes.

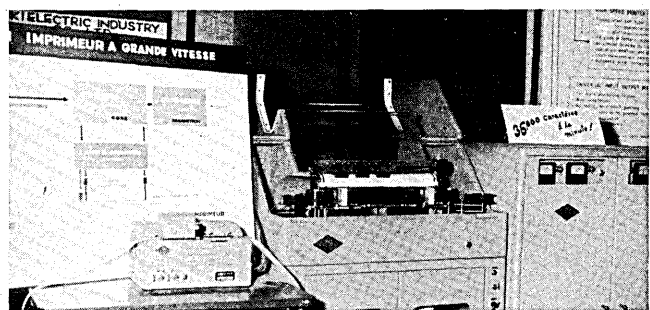

Opened panels of the OKI high-speed printer units show the driver unit containing as many drivers as there are type hammers (with power transistors and vacuum tubes) used as electronic circuit elements; and the memory control unit using as circuit elements parametrons and dual frequency memory cores.

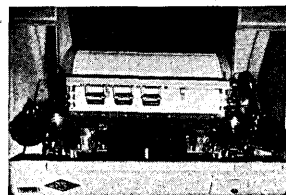

Close-up of the printer mechanism shows the endless motion steel belt mechanism and memory control circuits.



## special icip technical report

**ERRATA**—Page eight, July/August issue, covered the formation of the International Federation of Information Processing Societies (IFIPS). Please note that the vice chairman from the USSR is Anatole A. Dorodnicyn—not Mr. Bazilievsky. Correct address of coordinating chairman, Isaac L. Auerbach, is Auerbach Electronics Corp., 109 N. Essex Ave., Narbeth, Pa.—not Philadelphia.

by **ETIENNE J. GUERIN**

### TREATMENT OF PARTIAL DIFFERENTIAL EQUATIONS IN THE U.S.S.R.

In the paper "The Use of High-Speed Digital Computers for the Solution of Partial Differential Equations," presented at ICIP by Mr. A. A. Dorodnicyn, Chief of the Computing Center of the Academy of Sciences of the USSR, the author commented that in the solution of hyperbolic systems of partial differential equations two methods were successfully used — the method of characteristics and the method of finite differences. In the latter case special attention must be paid to the stability of calculations. For the elliptical, parabolical and mixed systems as the experience showed, the methods of reducing from partial differential equations to systems of ordinary differential equations (method of straight-lines, method of integral relations) are very convenient because they do not require too large computer memories.

Interviewed in Paris, Mr. Dorodnicyn supplied from memory a list of Russian bibliography (not listed on his paper) on the treatment of partial differential equations which DATAMATION presents here both transliterated from the Cyrillic alphabet and translated, with guiding notes for researchers.

(1) — G. V. Marchuk.

Chislennye metody rascheta atomikh reaktorov. Book, 1958 (Note: State publishing organization unknown, but suggest contact Mezhrunarodnaja Kniga, Moscow G-200)

*(Continued from page 32)*

verters, semi-automatic digital machines designed for reading and analyzing film-type records, etc.

Circle 114 on Reader Service Card.

**Bendix Aviation Corp.**, displayed their G-15 general purpose digital computer.

Circle 115 on Reader Service Card.

**National Cash Register**, showed: Model 304, 490 and 480 printing units; the Post Tronic document sorter and the National-Elliott 405 tape punch.

Circle 116 on Reader Service Card.

**Thompson-Ramo-Wooldridge**, through their affiliate **Inter-technique**, showed the RW-300 industrial computer.

Circle 117 on Reader Service Card.

**IBM** through **IBM France**, had a cryogenics stand. The display included an IBM 9202 paper tape to card converter; IBM 9900 Special Index analyzer; and an IBM 9310 Universal card scanner.

Circle 118 on Reader Service Card.

**Royal McBee Corp.**, exhibited the LCP-30 computer.

Circle 119 on Reader Service Card.

**Friden**, had a wide display including the Model C Computer, Friden Punch, the Flexwriter Programmatic.

Circle 120 on Reader Service Card.

**Ampex**, displayed tape transports and tape units.

Circle 121 on Reader Service Card.

**Minnesota Mining & Manufacturing Co.**, exhibited general purpose and special tapes.

Circle 122 on Reader Service Card.

**Burroughs**, showed the Datafile 560, the Model 440 perforated tape photoelectric reader, Model 544 tape transport, and the E101 computer.

Circle 123 on Reader Service Card.

Numerical method for the computation of atomic reactors.

(2) — S. K. Godunov.

Raznostnyi metod chislennogo rascheta razryvkh reschenni uravenenii gidrodinamiki.

Matematicheskii Sbornik Bo. 3, 1959 —

Difference method of numerical calculation of discontinuous solutions of hydrodynamical equations.

Mathematics Articles, No. 3, 1959 (Note: This is a magazine).

(3) — P. I. Chuskin.

Obtekanie ellipsoidov i ellipsoidov dozvukovym potokom gaza.

Prikladnaia matematika i mekhanika, 1957.

The subsonic flow about ellipses and ellipsoids. Applied Mathematics and Mechanics, 1957.

(Note: This is a monthly magazine and issue apparently is unknown.)

(4) — O. M. Belotserkovskii.

Obtekanie tel sverkhzvukovym potokom s otoshedshei udarnoi voldnoi.

Prikladnaia matematika i mekhanika, 1958.

Supersonic flow about bodies with detached shock waves.

Applied Mathematics and Mechanics, 1958. (As the month is not specified, it should be remembered that AMM is a monthly).

For this subject, see also the works of Belotserkovskii, Chushkin, Katskova, Shmyglevskii in the magazine Vychislitel'naia Matematika (Computing Mathematics) Nos. 2 and 3.

(5) — The series of papers of

A. N. Tikhonov and A. A. Samarskii in Doklady Akademii Nauk SSSR (Reports of the Academy of Sciences of the USSR) for 1957, 1958. (Note: Doklady AN SSSR is a monthly).

### METHODS OF SPEEDING UP THE OPERATION OF DIGITAL COMPUTERS

"Methods of Speeding-Up the Operation of Digital Computers" was a paper presented at the ICIP by I. Y. Akushsky, L. B. Emelianov-Yaroslavsky, E. A. Klyamko, V. S. Linsky and G. D. Monakhov of the Institute of Scientific Research of Electronic Mathematical Machines in Moscow. As an aid to researchers, DATAMATION supplies the following information with reference to the bibliography referenced under No. 2 of that paper, reading:

(3) — G. D. Monakhov and E. I. Klyamko.

Method of speeding binary division in digital computers.

Priborostroenie No. 2, 1957.

PRIBOROSTROENIE, which means "instrument making," is a monthly magazine published since 1956 and it is the organ of Min. mashinostroeniia i priborostroeniia SSSR (Ministry of Mechanical Engineering and Instrument Making of the USSR).

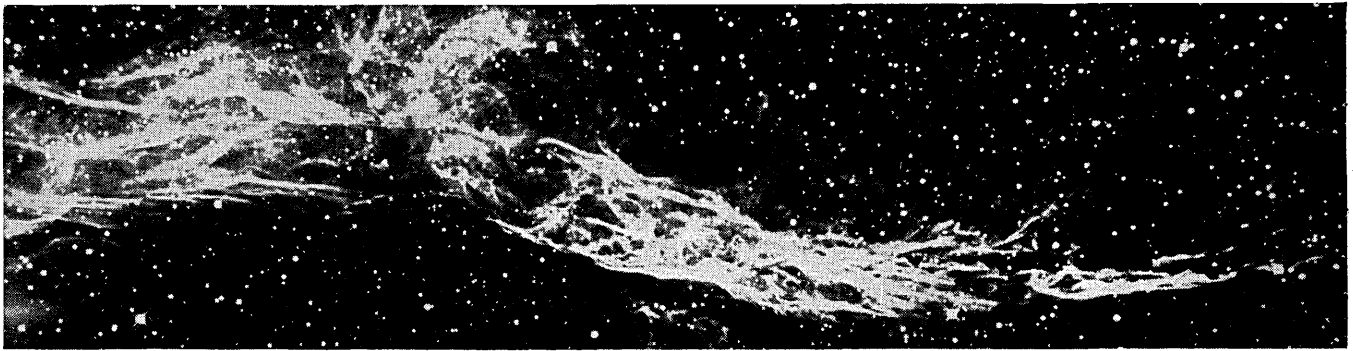

*Space Technology Laboratories' new corporate symbol represents a bright history in a stimulating age. \* STL has provided the over-all systems engineering and technical direction for the Air Force Ballistic Missile Program since it was assigned the highest national priority in 1954. Five years of accelerated effort produced epic advances in science and technology, and propelled the art of missilery through three distinct generations of progress. STL contributed technical leadership to the science/government/industry team which has built this solid, expandable foundation for future advances in space, and is daily adding new strength to our national security. \* In addition to its major management functions, STL also conducts advanced space probe experiments for the Air Force at the direction of such agencies as NASA and ARPA. \* To those scientists and engineers with capabilities in propulsion, electronics, thermodynamics, aerodynamics, structures, astrophysics, computer technology, and other related fields and disciplines, STL now offers unique professional opportunities. Inquiries regarding staff positions at STL are invited.*



a new symbol  
for a new era of  
technology

Space Technology Laboratories, Inc. P. O. BOX 95004, LOS ANGELES 45, CALIFORNIA

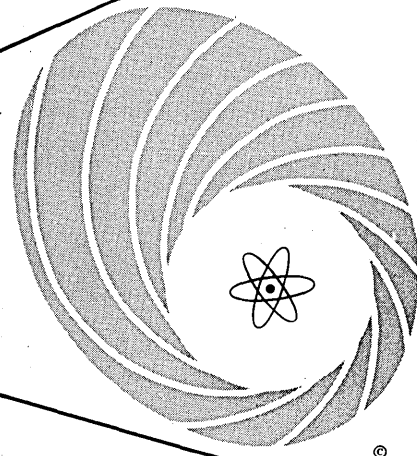

# **NEW PERSPECTIVES IN SPACE TECHNOLOGY**

**at RCA's new Astro-Electronic Products Division, Princeton, N. J.**

Continued research and investigation into new areas of electronics and space technology has opened up a number of challenging opportunities for creative scientists and engineers at this rapidly growing division of RCA.

#### **ADVANCED PROJECTS SYSTEMS ENGINEERS**

Must be able to make significant contributions to feasibility and preliminary design studies of satellite systems, lunar exploration and development and planetary exploration.

Assignments will cover all aspects of space vehicles, including sensors, communications, guidance, stabilization, power supplies, environmental control and data processing.

#### **DESIGN ENGINEERS**

Electrical engineers competent to design and integrate complex electronic and electro-mechanical equipment into final forms for satellite systems. Emphasis is on extremely high reliability and long life under stringent environmental conditions.

#### **COMMUNICATIONS ENGINEERS**

Must have several years development experience in one of the following:

VHF, UHF and SHF transmitters and receivers or antenna systems. Communication systems design including equipment, modulation methods and multiplexing systems.

#### **CIRCUIT DESIGNERS**

Experienced in the design of transistorized circuitry for audio, video, RF and control applications preferred.

#### **DIGITAL SYSTEMS AND DATA HANDLING**

Research and Development Engineers for: Advanced Digital Computer System Design • Digital System Logical Design • Digital System Design and Research • Digital Data Handling Systems Design

Operations Research Analysts with strong backgrounds in physical problems such as mechanics and orbital calculations.

Senior Systems Analysts experienced in the design of large systems integrating the capabilities of data processing equipment with those of human beings. Data processing specialists in mechanical translation, automata and machine learning.

For a personal interview, communicate with Mr. D. D. Brodhead.  
Call Collect Hightstown 8-0424 or send resume to Dept. PE-161



**RADIO CORPORATION OF AMERICA**

*Astro-Electronic Products Division, Princeton, N. J.*



Circle 72 on Reader Service Card.



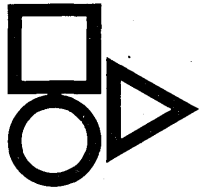

## new products in **DATAMATION**

### npn transistors

Seven new NPN transistors permit practical complementary circuitry up to 100 mc and feature low collector capacitance. Their applications include low-level, high speed computers. The new family includes the 2N1199, which is intended for high-speed, high temperature saturated switching circuits at frequencies up to 5 mc and feature a typical  $f_T$  of 125 mc. Types 2N1267, 2N1268 and 2N1269 represent beta ranges of 6-18, 11-36 and 28-90, respectively, intended for 4.3 mc amplifier applications, and feature typical power gain of 25 db at 4.3 mc. The 2N1270, 2N1271 and 2N1272 transistors for 12.5 mc amplifier applications have the same three specific beta ranges. Twenty db minimum power gain is specified at 12.5 mc. For information

write PHILCO CORP., Lansdale Tube Company Div., Philadelphia, Pa., or use reader service card.  
Circle 200 on Reader Service Card.

### readout photocells

Designed specifically for computer and data processing equipment where rapid detection of light passing

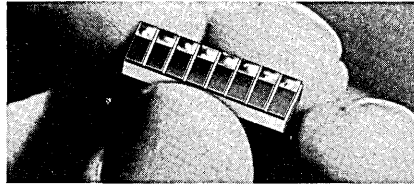

through punched cards or tape is required, these silicon photovoltaic readout matrices feature extremely fast response time in the order of 10 microseconds. The self-generating devices convert light energy directly in-

to electricity, with no need for external power supplies. Each matrix is made up of a multiple array of individually segmented silicon cells. Light energy striking a particular segment will cause power to flow from that segment only. For information write INTERNATIONAL RECTIFIER CORP., 1521 E. Grand Ave., El Segundo, Calif., or use reader card.

Circle 201 on Reader Service Card.

### computer tape

A new magnetic tape, C-1, specially designed for computer use, makes use of the exclusive Ferrosheen process to provide the lowest coefficient of friction of any magnetic tape, according to the manufacturer. Tests show a wearing quality for C-1 ten times greater than any tape of comparable magnetic properties, the manufacturer

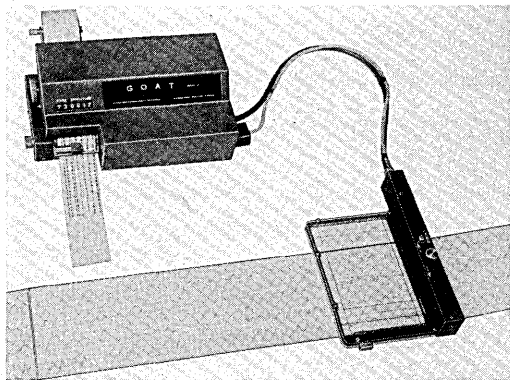
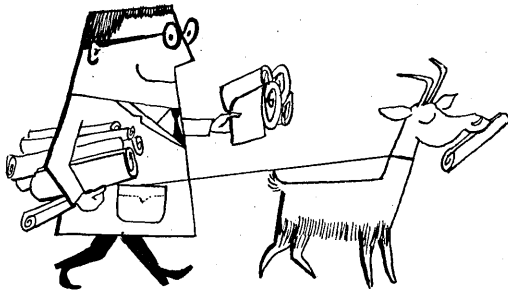

GOAT consists of a desk unit containing a printing counter and the necessary servos, and a reading head which incorporates a variable scale in the X direction for dividing timing lines.

Suffering from highly indigestible data?

Feed It To A

# GOAT

Gerber Oscillogram Amplitude Tabulator

The GOAT, newest Gerber instrument, has been an instant success.

It reads amplitudes conventionally or peak-to-peak, linearized and corrected for scale factors. PRINTS both corrected amplitude and time reference in tabular form.

Zero location instantly reset to any reference line. Resolution—.001 inch or .1 mm.

OPTIONAL: Pre-setable time-index counter. Plus-minus printout. Attachment to derive equations from curves.

This remarkable data reduction system, including printer, only \$995.

### Other GERBER Instruments for Data Reduction—

A complete line from simple instruments to complete, automatic systems. Contact GSI concerning your specialized data reduction requirements.

Free literature available. Write or phone.



**GERBER SCIENTIFIC INSTRUMENT COMPANY**  
89 SPRUCE STREET • HARTFORD, CONNECTICUT • JA 8-2124

Circle 14 on Reader Service Card.

# DISCOVER the DI/AN DIFFERENCE

... in  
shift-register modules,  
for example:



Our "Thimbles" are tiny, rugged, encapsulated packages, containing a complete, reliable, magnetic-core-transistor shift-register circuit. Widest operating

margins of any shift-register technique! Build complete Thimble registers (or buy them from us) at lower cost per bit than with any other module.

Compatible accessory circuit modules available from stock!

Write for Catalog D-591.

... not just a "core in a package", but a complete working circuit... you furnish only the signals!

... not a "power-hound": requires much less driving power, and no standby power.



## ALSO PRODUCES:

BUFFER STORAGEES  
RANDOM-ACCESS CORE MEMORIES  
MAGNETIC-LOGIC MODULES  
DIGITAL/ANALOG SYSTEMS

... ALL WITH THE  
DI/AN DIFFERENCE

DI/AN CONTROLS, INC.  
Magnetic Digital-Analog Systems and Components  
40 Leon Street  
Boston 15, Mass.  
TWX Roxbury, Mass 1057  
HIGHLANDS 5-5640

Circle 15 on Reader Service Card.

## NEW PRODUCTS

states. Supplied on an all-magnesium reel, this tape comes in two thicknesses of Mylar backing. A 1.0-mil backing provides lengths of 3600 feet. As such, the tape is identified as C-1. Shorter lengths are available as C-2 with 1.5-mil backing. For information write AMPEX MAGNETIC TAPE, 934 Charter St., Redwood City, Calif. Circle 202 on Reader Service Card.

## memory stack

A new miniaturized memory stack for coincident current systems, whose physical volume is 1/50th of the con-

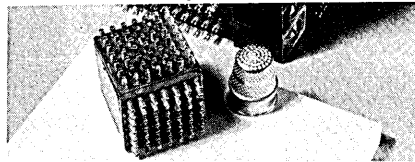

ventional stack, has been developed. The manufacturer's design and assembly techniques make possible the wiring of ferrite memory cores at a density rate of about 3.5 million per cubic foot and have produced prototype stacks consisting of 2,048 cores in a unit measuring 1 x 1.4 x 1.4 inches. This compares with a conventional stack measuring 3½ x 3½ x 4 inches. In each case the device consists of eight 16 x 16 arrays. Production models will be available in September. For information write GENERAL CERAMICS CORP., Applied Logics Div., Keasbey, N. J., or use card. Circle 203 on Reader Service Card.

## monitor

A monitor for verifying wire transmitted numerical data has as its basic component a solenoid-operated add-

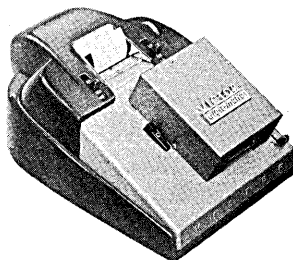

ing machine. This Data Transmission Control System is cable-connected at the transmitting and receiving points where they automatically accumulate figures and print batch totals. These totals are compared at the receiving point (or central processing center) to verify the accuracy of the trans-

# DISCOVER the DI/AN DIFFERENCE

... in magnetic logic  
modules, for example:



Our compact "Interlocks" and their microscopic counterparts, our "Logic-squares," perform any logical function:

AND, OR, AND NOT (INHIBIT), COMPLEMENT, BINARY COUNT, BRANCH, EXCLUSIVE OR, TRANSFER, DRIVE, STORE ... with only one logic element!

With greater reliability and at much lower cost than any other technique now available.

Unique magnetic-core-transistor circuitry operates with full margins to 100KC.

Write for Catalog D593

... not sensitive to normal power supply variations or extremes of ambient temperature.

... no diodes, transistors, or external circuitry required. You furnish only the signals.

WONDERFUL SHORT CUT TO MAGNETIC LOGIC TECHNIQUES! Write for the free DI/AN "Applications Handbook #H-359," 16 page profusely illustrated, packed with information!



## ALSO PRODUCES:

BUFFER STORAGEES  
RANDOM ACCESS CORE MEMORIES  
CORE TRANSISTOR SHIFT REGISTERS  
DIGITAL/ANALOG SYSTEMS

... ALL WITH THE  
DI/AN DIFFERENCE

DI/AN CONTROLS, INC.  
Magnetic Digital-Analog Systems and Components  
40 Leon Street  
Boston 15, Mass.  
TWX Roxbury, Mass. 1057  
HIGHLANDS 5-5640

Circle 16 on Reader Service Card.

mitted data. For information write VICTOR ADDING MACHINE CO., 3900 N. Rockwell St., Chicago 18, Ill. Circle 204 on Reader Service Card.

#### npn-pnp transistors

A series of complementary NPN-PNP transistors, in the diamond package, eliminate input and output transform-

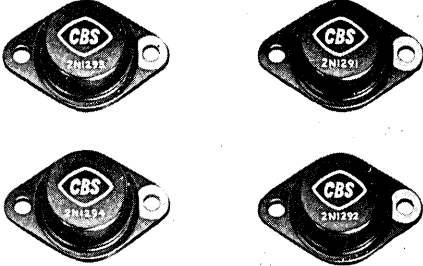

ers in push-pull circuits to save money and space while at the same time providing improved frequency response, according to the manufacturer. Negative feedback can be more easily applied using them. All types in the line have a maximum collector current of three amps, a minimum large-signal current gain of 30 (for a collector current of 0.5 amp), and a maximum thermal resistance of 3° C/W. For information write CBS ELECTRONICS, 100 Endicott St., Danvers, Mass.

Circle 205 on Reader Service Card.

#### transistors

Two new Mesa transistors (RCA-2N1300 and 2N1301) for high-speed switching in computers offer several technical features. The new units have high-speed switching in saturation-type circuits, maximum power dissipation of 150 milliwatts at 25° C, minimum collector-to-base breakdown voltage of -13 volts, typical gain-bandwidth product (figure of merit): 40 Mc for 2N1300 and 60 Mc for 2N1301, and hermetically sealed in a JEDEC TO-5 case. For information write RADIO CORPORATION OF AMERICA, 30 Rockefeller Plaza, New York 20, N.Y., or use card.

Circle 206 on Reader Service Card.

#### character generator

A new method of generating alpha numeric characters for electronic display purposes has been developed. This new generator can be used for continuous display of tabular information and/or insertion of written data into pictorial-type displays by means of time-sharing techniques.

**digital** offers all the advantages of the

# BUILDING BLOCK CONCEPT

- Full selection of transistorized logic packages
- Complete freedom and flexibility of application
- Time-saving ease of assembly and reassembly
- Speeds up to 5 megacycles per second
- Economy in slow-speed applications

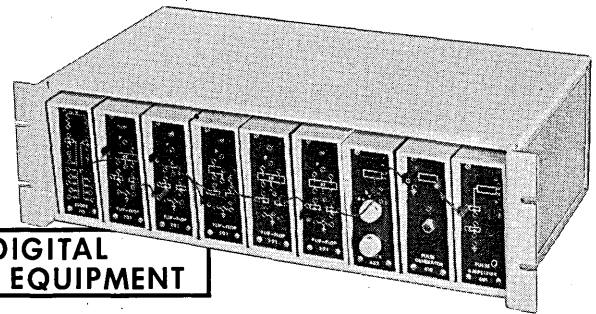

**DIGITAL TEST EQUIPMENT**

Packaged in convenient building block form, DEC Test Equipment units can be assembled quickly and easily by means of banana-jack patch cord interconnections to form custom digital test instruments such as signal generators, counters, pattern generators, etc.

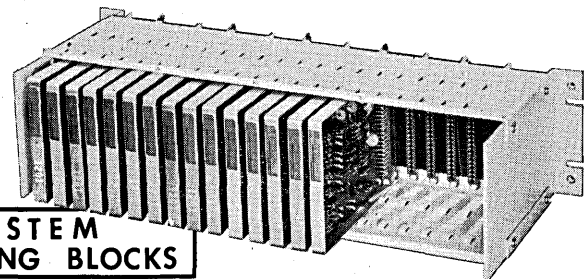

**SYSTEM BUILDING BLOCKS**

Featuring saturated circuits with wide operating margins, DEC System plug-in units provide the designer complete flexibility in formulating the logic for permanent or semi-permanent digital systems.

Write or call for complete technical information.

**digital** | **EQUIPMENT CORPORATION**  
 MAYNARD, MASSACHUSETTS  
 TWINOAKS 7-8822 • TWX 818

WEST COAST FIELD OFFICE • 690 NORTH SEPULVEDA BOULEVARD • EL SEGUNDO, CALIFORNIA • EASTGATE 2-5707

Circle 17 on Reader Service Card.

# RARE OPPORTUNITIES IN DIGITAL DATA PROCESSING

## SECTION MANAGER AND SENIOR ENGINEERING POSITIONS

Our Digital Computer Group has recently been elevated to a new departmental status — in recognition of the *increasingly vital* role digital computers will play in our present and future systems.

General-purpose, real time digital computers with solid-state circuitry will be used in most instances. Departmental assignments will be concerned primarily with system, logical and circuit design, as well as mathematical analysis and programming. Mechanical design and packaging are to be done by other departments.

These openings are truly exceptional — because they represent your chance to move into a key position in a departmental and divisional (Electronics Division) “ground floor” growth situation. Your remuneration and responsibility can grow rapidly with the department.

You may be particularly interested to know that regardless of a group's size, whether you supervise none or many, your compensation will be based on responsibility — whether purely technical or supervisory. Additional benefits such as paid vacations, tuition assistance, free hospitalization, surgical and life insurance, etc., are equal or superior to those offered elsewhere. The Corporation also provides a unique lake resort for summer and winter recreational activities. Last but hardly least among these advantages is the fact that there are *no state income or sales taxes* for you to pay.

A short distance from New York, the facilities are surrounded by dozens of attractive residential communities, fine schools and a superb complex of superhighways linking you to lake, seashore or mountain vacation resorts.

You may be in for a powerful career boost by investigating these openings for seasoned engineers or other qualified personnel. Positions of major responsibility, including Section Managers in systems, logic and circuit design, are available.

**Many positions are available for engineers with other types of electronics experience. You are invited to send a resume, outlining your qualifications, to:**

**Mr. T. W. Cozine, Mgr., Executive & Technical Placement,  
Curtiss-Wright Corporation, Dept. ED-11, Wood-Ridge, N.J.**

ALL REPLIES CONFIDENTIAL

# CURTISS-WRIGHT

CORPORATION • WOOD-RIDGE, N. J.

Circle 73 on Reader Service Card.

## NEW PRODUCTS

Electronic character generation can be used in a wide variety of situations, such as high-speed computer readout functions. This new centrally located on-command system produces characters from a minimum amount of equipment. For information write PHILCO CORP., Government and Industrial Div., 4700 Wissahickon Ave., Philadelphia 44, Penna.

Circle 207 on Reader Service Card.

### detector capsule

Type EA7 photo-voltaic detection device is designed for use in applications where higher light sensitivity and small

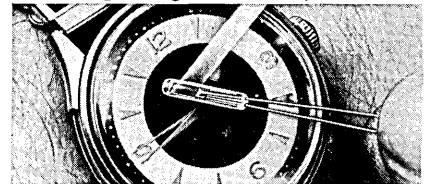

size are of prime importance. Primary application of the new device will be in computers as a punched card or tape readout. The unit will generate a minimum of 300 microamperes into a 1,000 ohm load at an illumination level of 1,250 foot-candles of tungsten light at 2,800 degrees K, color temperature. The detector cell has a response time of about 20 microseconds, the exact speed depending on the load impedance. For information write HOFFMAN ELECTRONICS CORP., Semiconductor Div., 930 Pitner Ave., Evanston, Illinois, or use reader card.

Circle 208 on Reader Service Card.

### computer typewriter

A fully alphanumeric typewriter is now available with the G-15 digital computer. Data entering and leaving



the computer via the typewriter can now be identified with alphabetic information and a variety of special symbols. Headings for columnar type-out, as well as complete format control, can be programmed. All information is typed into the computer in

the normal typing manner. Upper and lower case letters, numbers and special symbols are entered and typed out directly, without the necessity for manual encoding of alphabetic data, conversion subroutines or programmed carriage shifts. For information write BENDIX COMPUTER DIVISION, 5630 Arbor Vitae St., Los Angeles 45, Calif., or use reader service card.

Circle 209 on Reader Service Card.

#### dp system

Model 821-N is designed to sample analogue voltage information, digitize, and print seven channels. Simple

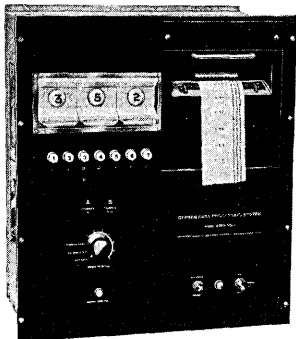

modifications permit any number of channels to be handled. The analogue to digital conversion is fully electronic. Sampling, digital conversion, and printing occur at the rate of three channels per second. Visual output is by means of Nixie lamp banks indicating the value of the analogue voltages corrected by the proper scale factors. In addition to the visual output, printed paper tape is produced for permanently recording the data. For information write THE GERBER SCIENTIFIC INSTRUMENT CO., 89 Spruce St., Hartford, Connecticut.

Circle 210 on Reader Service Card.

#### digital data link

Designed for the transmission of digital data over standard communication channels at rates up to 33,000 bits per second, the DA-100 Digital Data Link is an integrated transmit-receive unit, capable of sending or receiving over 20,000 pages of printed matter in one eight-hour shift. The output magnetic tape is usable directly in computer format for the entry and solution of problems or may be printed out in report form for local distribution. Coupled with present or contemplated computers and associated peripheral equipment—management reports, sales reports, billing, shipping and receiving reports, together with scientific

# JOIN THE RCA BREAKTHROUGH IN ELECTRONIC DATA PROCESSING

RCA . . . world leader in electronics . . . is currently expanding its electronic data processing operations as a result of one of the most significant breakthroughs in modern electronics—the all-transistor RCA 501 system. Already the RCA 501 is being talked about as the world's most efficient electronic data processing system; its sales curve is slanting sharply upwards.

If you have experience in EDP sales or technical services, and are ready to step up to more challenging and rewarding assignments, investigate today the many new career openings at RCA. Current positions, dealing with medium and large-scale systems, include the following:

**EDP SALES REPRESENTATIVE**—background should include a thorough systems knowledge and at least one year of field experience with either government or commercial clients.

**EDP PROGRAMMERS AND METHODS ANALYSTS**—local openings for qualified men to work closely with both customer and sales personnel in the development of specific applications, related procedures, and programs.

*For a strictly confidential interview with RCA management, please send a detailed résumé of your background and personal qualifications to:*

Mr. E. C. Baggett  
Professional & Administrative Employment  
RCA, Dept. E-61  
Bldg. 10-1  
Camden 2, N. J.



**RADIO CORPORATION of AMERICA**

ELECTRONIC DATA PROCESSING DIVISION

Circle 74 on Reader Service Card.



This is the New

# TALLY



## Bi-directional Paper Tape Reader

***It reads paper tape rapidly and economically***

Tally Series 424 Paper Tape Readers furnish a new low cost approach to rapid search and accurate punched paper tape reading. Self contained, this unique bi-directional asynchronous reader is available in both rack and console styles.

***It features...***

A reading rate of 60 characters per second in either direction— instantaneously reversible. Triggered tape feed readout. Full accountability with form C switch providing positive hole/space identification. Reads 5, 6, 7, or 8 channels without modification. Low cost, only \$595 for console unit. Can be slaved to any other 60 character device.

***It's ready for delivery now***

For full technical information including a 6 page folder and the name of your nearest Tally engineering representative, please write department 8010.

# TALLY

REGISTER CORPORATION  
5300 14th Avenue N.W., Seattle 7, Wash.

Circle 18 on Reader Service Card.

## NEW PRODUCTS

computations can be made immediately available at branch or field offices. For information write EPSCO, INC., 275 Massachusetts Ave., Cambridge, Mass., or use reader card.

Circle 211 on Reader Service Card.

### paper tape unit

A "piggy back" paper tape unit which allows the E101 to accept data and instructions from either one of two readers is available. Coupled with the standard Model A531 input unit, it provides the programmer with completely automatic control of two separate tapes. Control of the new unit — officially titled the Duplex Tape Input Unit — is provided by the E101 pin-board programming unit. For information write BURROUGHS CORP., ElectroData Div., 460 Sierra Madre Villa, Pasadena, Calif., or use card.

Circle 212 on Reader Service Card.

### current drivers

Two new current drivers designed to provide a source of current pulses for testing computer components requiring significant drive currents. The Negative Current Driver Model 50 and Positive Current Driver Model 60 can be used independently or they can be used in conjunction to provide both polarities of pulses. Width and pattern of current pulses is determined by external logic carried out with DEC Digital Test Equipment or equivalent circuits. For information write DIGITAL EQUIPMENT CORP., Maynard, Mass., or use card.



Circle 213 on Reader Service Card.

### tape splicer

This tape splicer measures, cuts, and seals nylon-coded glass fibre tape in endless loops within precise length tolerances of plus or minus one thousandth of an inch. This unit can cut at the exact spot on the tape, seal the ends in precise lateral alignment, produce minimum ridge at the splice and meet rigid length tolerances. For information write PRESTOSEAL

## WACO Raised Floors Perform Perfectly For All Computers

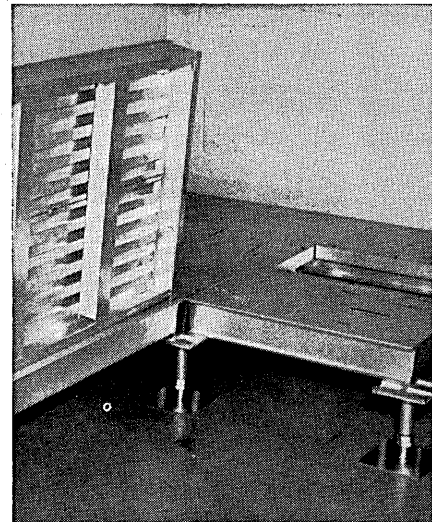

**Exclusive new design reinforced panels eliminate stringers, permit total access!**

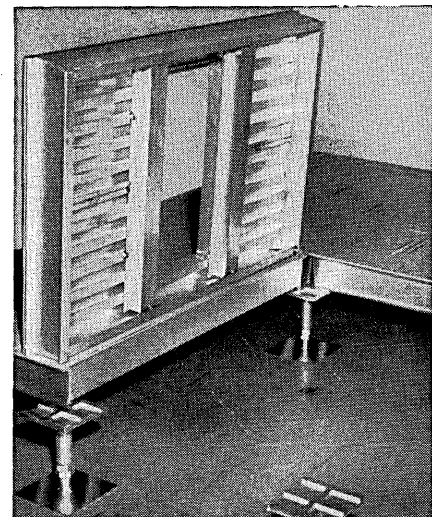

WACO "Series 300" raised floors feature reinforced, aluminum panels with stringer-free installation to permit total access to sub-floor; allow cut-outs anywhere on the panel, even after installation, while retaining maximum strength, minimum deflection. Adjustable pedestals assure perfectly level floor for all computer installation.

WRITE FOR FREE CATALOG  
**WASHINGTON ALUMINUM CO.**  
Dept. 379 • Baltimore 29, Md.

Circle 19 on Reader Service Card.

MANUFACTURING CORP., Long Island City, N.Y., or use reader card.  
 Circle 214 on Reader Service Card.

**alpha numeric readout**

An in-line, in-plane alpha numeric display unit using only one input per character has been developed. In



Model SGS-401, no external segment switching devices are required. Featuring the Selective Group Switching principle, the standard model displays 26 letters and 10 digits. Other combinations or additional characters, including standard or special symbols are available at slight extra cost. For information write I.D.E.A., INC., 7900 Pendleton Pike, Indianapolis 26, Indiana, or use reader service card.  
 Circle 215 on Reader Service Card.

**silicon junction diode**

A miniature, silicon junction computer diode features exceptionally fast re-

covery time. When switched from the forward bias with 10 milliamps current flowing to reverse bias of -5 volts, the MA-4223 complete recovery time is four millimicroseconds maximum. Essential electrical data is: forward current (steady-state DC), 50 mAdc; peak surge current (1 sec), 100 mAdc; reverse voltage (steady-state DC), 30 Vdc; power dissipation, 100 mW. For information write MICRO-WAVE ASSOCIATES, South Avenue, Burlington, Mass., or use reader card.  
 Circle 216 on Reader Service Card.

**tape input to plotters**

A new converter, which makes possible the direct use of digital magnetic tape as input to automatic graph plotters and similar voltage devices, eliminates the necessity for transferring data from magnetic tape to punched cards, and more than doubles plotting speeds even for existing plotters, according to the manufacturer. The unit has solid state switching circuitry and can be adapted to magnetic tape from any digital computer. Selection of data by patchboard makes special programming unnecessary. For information write BENSON-LEHNER

CORP., 11930 W. Olympic Blvd., Los Angeles 64, Calif., or use reader card.  
 Circle 217 on Reader Service Card.

**indicator lamp**

Newly designed microminiature incandescent indicator lamp which operates directly from the output of a

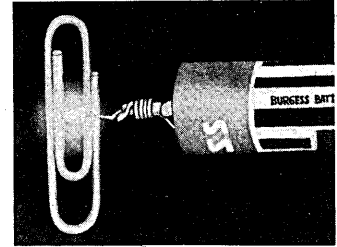

transistor without amplification is now in production. The lamp operates at less than 1.5 volts and draws less than 50 milliamperes, according to the manufacturer. It is tailored for transistor circuits; housed in a vial one hundred and ten thousandths of an inch long and fifty thousandths of an inch in diameter with two platinum leads extending from one end. For information write MINITRON COMPONENTS CORP., 67 Illinois Ave., Paterson, N.J., or use reader card.  
 Circle 218 on Reader Service Card.



THE  
 FASTEST  
 GROWING  
 COMPUTER-  
 ORIENTED  
 RESEARCH  
 FIRM  
 IN THE  
 NATION

**VARIETY...GROWTH**

C-E-I-R offers challenging opportunities for programmers, analysts and applied mathematicians in novel applications of the latest computing and data-processing equipment. Advanced research projects of far-reaching significance for Government, Business and Industry encourage creativity, initiative and professional achievement.

**COMPUTER PROGRAMMERS**

IBM 704, 709 and 7090 programmers at C-E-I-R are currently engaged in many exciting new fields that will soon be the talk of the industry. Staff openings at all levels of experience in both our New York office and Washington Computing Center, to handle such varied assignments as . . .

- Business Strategy Games
- Interplanetary Trajectories
- Stock Market Predictions
- Air Traffic Analysis
- Information Retrieval
- Oil Refinery Simulation
- Military Intelligence
- Language Translation
- Bank Automation
- Weapons System Simulation
- Election Forecasting
- Linear Programming

Fringe benefits include advanced study program, three weeks' vacation, attractive profit sharing and retirement plans. For variety . . . advancement . . . growth . . . send your resume now to:

**C-E-I-R INC.** 1200 Jefferson Davis Highway  
 ARLINGTON 2, VIRGINIA

Circle 75 on Reader Service Card.

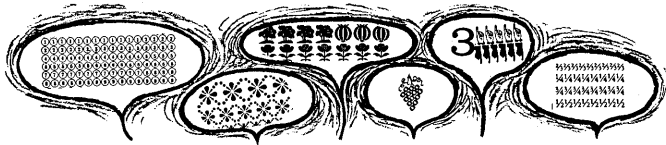

(Continued from page 26)

ciety. They simply went out and started a new magazine.

Selfridge: They probably did think in terms of a new society, but felt that they didn't have time for it. But there is a new institute now at MIT in communications sciences, for which his magazine is one of its voices.

Gorn: Maybe what we seek already exists, gentlemen: an Institute for Communication Sciences.

Grosch: I think I'd prefer the word information, rather than Communication. Communication implies transmission; information includes standing still and still processing. I don't think of a library as a communication device, for instance, except in a very broad sense, and yet I think of it as part of an information system.

\* Then how about the Institute for Information Systems as a title?

Rubinoff: No, it's already been pointed out that information processing is the phrase coming into acceptance.

Selfridge: Yes, that's the name of the new division at the Lincoln Labs.

Gorn: What's the name of the new group at Princeton?

\* FOCUS.

Gorn: It looks as if universities or offshoots thereof are beginning to start institutes.

Grosch: Saul, I don't want to get back to the earlier topic, universities themselves, but it seems to me that it isn't university faculties which are starting these institutes, but rather business groups who are servicing industry and the government. We've been using the word university around here in the old-fashioned sense of a group of scholars who are interested in teaching and research. What you're talking

about is just another corporation without incorporation, set up to spend defense funds.

Gorn: If you want to have a professional society, and you want it to grow, I don't see how you can do it without having the universities involved.

Rubinoff: Well, the university people are members of these societies.

Grosch: Let me cite the case of the Institute for Aeronautical Sciences. There are many wonderful universities and many of them have fine aeronautical sciences departments, but the IAS is not primarily university oriented. It has a lot of university members but the universities do not guide the IAS by a long shot.

Gorn: I wasn't thinking of its guiding but as a source of the expanding professional membership.

Grosch: But even so, would you find that all the IAS members have come from aeronautical sciences departments in the universities? The organization has grown so that a large share of their membership today consists of mechanical engineers and others.

The point is that if the IAS can be a real strong organization, the computer world can be too, and not be any more university oriented than they are. Note also that the IAS is not just an offshoot of the Aircraft Industries Association.

Armer: But, it's the presidents of some of these companies that are still behind that organization. We still have that problem.

Grosch: I have the impression, Paul, that they have left it relatively pure. They're willing to support it financially, without trying to steer it.

I think that the manufacturers in our industry would give financial support to our new society without trying to dominate it.

Rubinoff: Let's face it, the manufacturers are providing the financial help right now. They send their people to the meetings, provide secretarial help, take care of all the arrangements and generally pay all the hidden costs.

Armer: They hide them, that's the thing. What we need is

## MATHEMATICIAN

with graduate study and computer (650) experience for opportunity position. Applicants must possess ability to utilize literature on numerical methods in the computer solution of engineering problems.

Matrix algebra, linear differential equations, and statistical analysis involved.

### Chrysler Corporation

Engineering Division  
P. O. Box 1118  
Detroit 31, Michigan

Circle 76 on Reader Service Card.

## COMPUTER ENGINEERS

Engineers at the Masters and Ph.D. level with three to five years experience in advanced digital computer systems, digital techniques or control systems design are required to fill vacancies in the Automated Data Systems Development Department.

The work will consist of system studies and advanced apparatus systems development for the automated acquisition, transmission, storage, processing and display of variables data generated in the development, design and production of atomic ordnance. The systems and applications being relatively new in concept offer unlimited horizons for highly creative and imaginative individuals.

Sandia Corporation, located in Albuquerque, N.M., is engaged in research and development of nuclear weapons and other projects for the AEC. Albuquerque is a modern city of about 225,000; has an excellent climate and many cultural and recreational attractions. Winters are mild, summer nights are cool, and there's plenty of year-around sunshine.

Sandia's liberal employee benefits include generous vacations, retirement and insurance plans, and a graduate education assistance program. Paid relocation allowance. Send resume to Staff Employment Section 521.



Circle 77 on Reader Service Card.

a paid professional staff out in the open for which you need cash from these companies.

Grosch: A decent budget for the professional staff of the American Association for the Advancement of Computing would be a couple hundred thousand bucks a year. Now that's a lot of money, but take a look at the American Rocket Society. They have a whole hive of fairly expert people. They have full time editors, and I don't mean professional rocket people who sit around and review articles; and these are editors who actually write with pencils in their grubby little fists. They have an executive director, they have a secretary type, they have all sorts of little girls in mail rooms and people running madly around; they even have public relations men. And all this is coming off the top.

Gorn: With the number of members that we've been talking about and support from the manufacturers, this amount of money wouldn't be too much.

Grosch: Right. I'm sure the budget for the IAS is much greater. But my point is that the Rocket Society did this in six years.

Bright: I took this matter of corporate contributions up one time with our legal department when I wanted to find out the company's policy in case SHARE became an organization of corporate memberships. He told me then that there is ample precedent within our company for furnishing financial aid to professional groups, both as donations and for corporate memberships.

Our costs for participation in SHARE alone (and remember that SHARE is not even a formally organized professional society) have run to thousands of dollars per year, considering personnel participation, expenses to attend the meetings and the like.

I would imagine that SDC has set some kind of world's record along these lines and I don't imagine it is because SDC figures that these men just need a vacation from their desks. It seems to be clear that corporations must get solid value from the professional societies and are willing to put up costs for value.

Grosch: They want to do it carefully so that it doesn't appear as some sort of bribe or controlling interest. It's quite obvious that there is considerable support in the form of advertising, corporate memberships and lots of individual memberships. They're quite willing to do it if they see some evidence of a return on their money.

[It being nearly five o'clock, chairman Ware declared the meeting officially adjourned.]

## DATAMATION NEWS BRIEFS

✓ Plans to construct a transistor plant at Lewiston, Me., for the manufacture of transistors, diodes and rectifiers for computers, radars and missiles, etc., has been announced by Raytheon. **Circle 126 on Reader Service Card.**

✓ FAST, short for FIELDATA Applications, Systems and Techniques, is a new user group activated in April. Members use MOBIDIC (Sylvania) BASICPAC and COM-PAC (Philco) and IMPAC (IBM). Third FAST meeting is scheduled for Nov. 3, 4, 5 at Fort Monmouth, N.J.

✓ Halex, Inc., of El Segundo, Calif., is specializing in the process of depositing thin films of conductive, semi-conductive and resistive substances to form electronic circuits. Halex engineers utilize high vacuum techniques (see page 8). **Circle 127 on Reader Service Card.**

✓ A patent covering two new approaches to character recognition problems has been issued by the U.S. Patent Office. Patent No. 2,897,481 was issued to David H. Shepard of Farrington Mfg. Co., Needham Heights, Mass., who is assigned to Intelligent Machines Research Corp., Alexandria, Va. **Circle 128 on Reader Service Card.**

✓ May 3, 4 and 5 are the dates for the 1960 Western Joint Computer Conference — to be held in San Francisco next year. For information contact WJCC, Box 214, Station A, Palo Alto, California.

## NETIC CO-NETIC

# T A P E D A T A P R E S E R V E R S

### Keep Data Clear, Distinct, Without Distortion

Permanently maintain original fidelity of recorded data on automation programming tapes, telemetering, broadcast, video and hi-fi tapes by diverting all damaging magnetic fields. Magnetic shielding qualities not affected if sturdy Netic Co-Netic containers are dropped or vibrated. Containers do not retain residual magnetism nor require periodic annealing.



Successfully provide simultaneous high and low intensity shielding plus high and low frequency shielding from all damaging extraneous fields produced by generators, power supplies, transformers, magnetic tables on surface grinders, magnetic chucks, de-gaussers, soldering irons, motors, power lines, welding machines, solenoids, etc. around factories, laboratories, military installations, and radio and TV stations. Available in many convenient round or rectangular shapes. Write for sizes and prices today.

**MAGNETIC SHIELD DIVISION PERFECTION MICA CO.**

1322 No. Elston Avenue • Chicago 22, Illinois

Circle 20 on Reader Service Card.

## Computational Research

### A position of responsibility and growth to be filled

Position entails future expansion of present digital computer facilities in fields of research and, secondarily, as a service department (with necessary assistance) in a large research organization. Opportunity for person selected to supervise entire operation and to develop research fields of his own interest as long as they are compatible with long-range planning of organization. Involves working closely with both technical and nontechnical personnel.

Work areas include research in fields of numerical analysis, mathematical research, and engineering problems.

You should have an advanced degree in mathematics and/or electrical engineering. Must have at least 4 years' experience supervising, operating and utilizing a fairly large-scale digital computer facility.

Battelle, 100% devoted to research, provides a good working climate; the city is cultured and metropolitan; known for good living. An extra-generous benefits program assures your future. Write for details to L. H. Hill,

## BATTELLE MEMORIAL INSTITUTE

505 King Avenue, Columbus 1, Ohio

Circle 78 on Reader Service Card.

# THE BIAX MAGNETIC ELEMENT

*new aeronutronic development features ferrite bar*

by **EDWARD O. BOUTWELL** and **RALPH B. CONN**  
*Aeronutronic, Division of Ford Motor Company*

BIAX, a small (50 x 50 x 80 mils) magnetic device which has been devised for digital applications, has been announced by Aeronutronic, a Ford Motor Company division. The basic element, shown in Figure 1, is a short ferrite bar which contains two orthogonal holes. Binary information may be stored magnetically in the material which surrounds one of the two 20 mil square holes. This stored information may be read-out at some later time by establishing a magnetic flux around the second hole. The resultant interaction of the two magnetic fields generates an output pulse on the storage-axis sense winding. This interrogation or read-out operation, may be performed in either a destructive or non-destructive manner. These two modes are used in the logic and memory applications respectively.

A more complete description of the principles which are involved in the BIAX concept has been presented elsewhere.<sup>1</sup> It is important to this discussion, however, to note that both the operating speed and the power requirements of all magnetic computer elements is directly related to the size of the basic device. The extremely small size of the BIAX element thus permits high-speed minimal power applications. Furthermore, simplified fabrication techniques permit it to compete favorably on a cost basis with other memory and logic elements.

## logic element

In its logic role the BIAX magnetic element of Figure 1 is operated in a destructive mode. It accepts up to 15

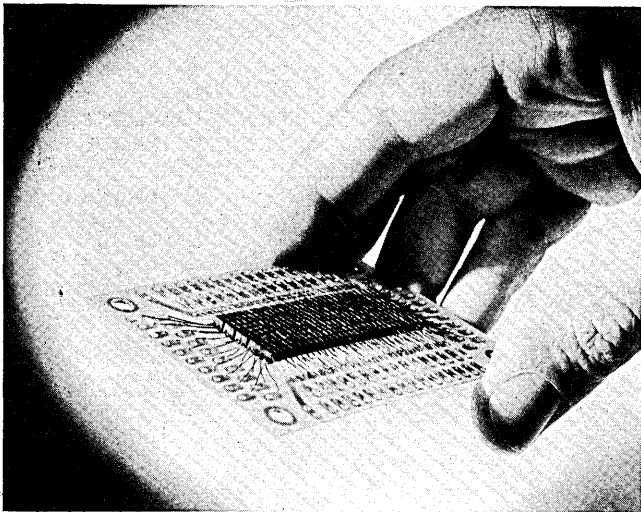

*A TYPICAL BIAX ARRAY for an electronic digital computer memory unit, this printed circuit card contains more than 300 BIAX elements. Multiples of such printed circuit cards, containing BIAX, are mounted adjacent to one another in a computer to provide large memory capability. BIAX is a development of Aeronutronic, a Division of Ford Motor Company, Newport Beach, California.*

windings, each representing a logic variable. Several such "product-gates" may be summed, as in Figure 2, by passing the sense winding through each required gate. The familiar and-or proposition which results is a basic building block of computer logic.

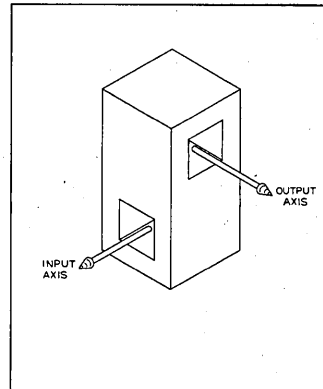

BASIC BIAX ELEMENT  
FIGURE 1

Before assessing the advantages of the BIAX logic element, it will be helpful to review the relationships which exist between logic element capabilities and desirable computer characteristics. That is, what logic element properties are important in the mechanization of high performance computers? In general, the factors of speed, reliability, size and power are of paramount consideration. Speed of operation

refers not only to the repetition rate of the logic cycle, but also implies the ability to do as much logical work as possible during each cycle. Reliability must be interpreted as the reliability of both the basic elements and any connections which are required to mate the element with the system. Certainly the size of the logic element must be small so that a computer of reasonable complexity may be contained in an ever decreasing volume. Finally, the power required to operate a logic element must be maintained at a low level. This requirement for minimum power consumption is related to the problems of power generation and removal of dissipated power. In this last respect, it is desirable for the logic elements to possess such environmental characteristics that they are relatively insensitive to heat that is generated within the system.

Present logic usage of the BIAX element is in the range of one to two million decision cycles per second. The BIAX logic principle, however, has been demonstrated at higher frequencies. Synchronous operation can thus be effected in a frequency range which was previously dominated by expensive semiconductor methods. In addition to its favorable frequency characteristics, the BIAX element has been found to be useful in advanced logic techniques which permit the accomplishment of four-level logic (and-or-and-or) at each clock period.

The high reliability of BIAX mechanized logic results in part from the fact that the logic elements themselves are passive devices. This should be contrasted with transistors whose active element characteristics may deteriorate with age. Furthermore, semiconductors are subject to damage by transients of both an electrical and environmental nature. The absence of thousands of connections

<sup>1</sup>Wanlass, C. D. & S. D., "BIAX High Speed Magnetic Computer Element," WESCON Convention Record, 1959.



in BIAx mechanized logic also contributes materially to its reliability. In a BIAx logic system, connections are required only at the input and output terminals of the system flip-flops. By way of comparison, two or more connections are required for each element in a system of semiconductor logic.

The size advantage of the BIAx element has already been emphasized. The magnetic element size-power relationship, which was discussed above, is responsible for the minimum power requirement of BIAx logic when compared with other magnetic element mechanizations.

### use in memory arrays

Important characteristics of computer memories are their physical size, storage capacity, access time, access mode (random or sequential) and the nature of their readout. A memory made of BIAx elements offers desirable features in all these areas.

A complete BIAx memory system of 21,500 bits with full read and write capabilities can be packaged in 0.8 cubic feet for airborne applications. This memory would have parallel non-destructive readout at a 2 Mcps rate, and operate in the random access mode. In addition to this mode of memory operation which permits reading and writing under program control, there are two other types of memory operation possible with BIAx elements.

The first type is a memory that has one BIAx element per memory bit and can be altered under operator control, but not under program control. This type of memory is particularly useful during the system development phase of a control computer application. It cannot be altered inadvertently by program malfunction, but can be changed easily as the system design evolves.

The second memory type is one that is well suited to permanent storage, allowing anything from a subroutine to a complete control system program to be stored. This is made possible by using the position of a wire to indicate the value of a particular bit in a word. Thus, if there are twenty bits in a computer word, twenty wires will be used to represent these bits. The wires will be threaded through or around the memory BIAx element depending upon whether in the word in question this bit is a one or a zero. In principle only one element per stored word is needed, but the necessary engineering compromises dictate the use of one per seven bits. Figure 3 shows how a simple memory of this type would be constructed.

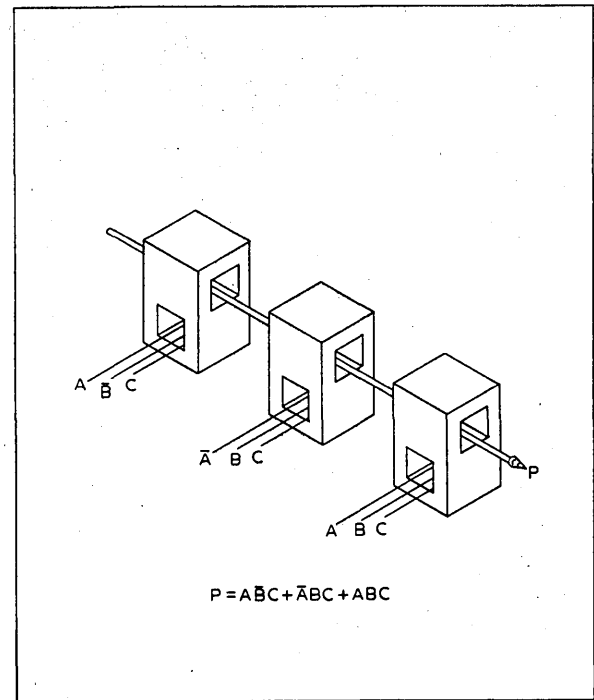

BIAx AND-OR LOGIC  
FIGURE 2

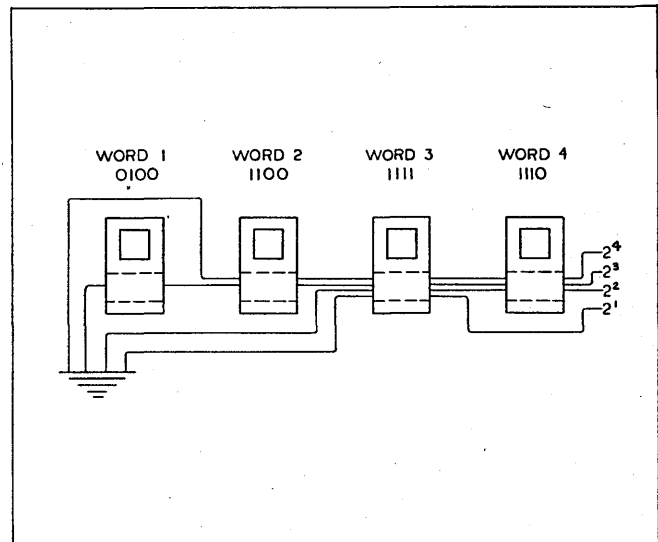

BIAx PERMANENTLY WIRED STORAGE  
FIGURE 3

*RALPH B. CONN is a senior staff member in Aeronutronic's Computer operation. He is project engineer on a military control computer. He was previously employed by the Ramo-Wooldridge Corporation and before that, the California Institute of Technology Jet Propulsion Laboratory. His work at both these organizations was concerned with the design and development of control system computers. He joined Aeronutronic in March, 1959.*

*EDWARD O. BOUTWELL, JR. has been at Aeronutronic since July, 1958. He is a staff member in the Digital Computer Engineering Laboratory and is currently engaged in the system and logical design of high speed computers. He was formerly employed by the National Cash Register Electronic Division where he contributed to the logical design of data processing systems.*

### applications

The features mentioned above make the BIAx magnetic element particularly adapted for use in computers in certain areas. The first of these is the field of high-speed information retrieval. When it is necessary to interrogate a large file, using an involved interrogation plan, it is mandatory that each interrogation be performed as fast as possible. The high speed of BIAx logic and memory makes it possible to actually process file information as it is read from the primary file. In addition to raising the file processing speed, this approach allows the file access control to be simplified.

Another application for BIAx elements is the field of airborne digital control computers. Present day machines

*Expanding the Frontiers  
of Space Technology in*

## COMPUTER OPERATIONS

■ Lockheed Missiles and Space Division's computer center is one of the largest and most modern in the world. It is concerned with formula and data applications in more than 40 areas of science and technology.

Equipment includes two Univac 1103AF digital computers with twenty magnetic-tape units, card-to-tape and tape-to-card converters, and two high-speed magnetic tape printers; two IBM 709 digital computers with two data synchronizers, twenty-four magnetic-tape units, CRT display and recorder units, card-to-tape and tape-to-card converters, two high speed and one low speed printers; four Lockheed magnetic-tape plotters, Model 1100 variplotter; three 100-amplifier, three 60-amplifier, and two 20-amplifier analog computers; twelve 11" x 17" X-Y plotters; double-arm 30" x 30" X-Y plotter; and 114 channels of time-history recorders.

The center serves both government and industry in the solution of complex mathematical problems. Digital computer programs have been used in such work as: strategy and logistics; stress and flutter analysis; static, wind-tunnel and flight testing; missile performance; aerodynamics; trajectory computations; financial forecasting; personnel assignments; cost accounting; control-systems analysis; and various problems involving numerical integration, simulation, curve fitting and numerical approximations. Work with analog computers includes the solution of problems in flight control stability; structural analysis; dynamic analysis; and simulation.

### ENGINEERS and SCIENTISTS

Lockheed's programs reach far into the future and deal with unknown and stimulating environments. If you are experienced in one of the above areas, or in related work, we invite you to share in the progress of a company that has an outstanding record of achievement and make an important individual contribution to your nation's efforts in the race for space. Write: Research and Development Staff, Dept. J-46, 962 W. El Camino Real, Sunnyvale, California. U.S. citizenship required.

## **Lockheed** MISSILES AND SPACE DIVISION

*Systems Manager for Navy POLARIS FBM,  
DISCOVERER, SENTRY and MIDAS;  
Army KINGFISHER, Air Force Q-5 and X-7*

SUNNYVALE, PALO ALTO, VAN NUYS, SANTA CRUZ,  
SANTA MARIA, CALIFORNIA • CAPE CANAVERAL, FLORIDA  
ALAMOGORDO, NEW MEXICO • HAWAII

## THE BIAX MAGNETIC ELEMENT

are not fast enough to handle all necessary computations aboard combat aircraft. Using BIAX memory and BIAX logic it will be possible to achieve a multiply time as short as 5 usec. and correspondingly short times for other operations. Thus, one BIAX computer could handle data processing, navigation, weapon delivery and cruise control.

Another approach to the airborne control problem is that used for space vehicles. Here the computations are not as numerous nor the speed requirements as great. However, reliability is of the utmost importance. A computer design using BIAX logic and storage will result in a machine with substantially fewer semiconductors, but still maintaining the necessary computation speed. Thus, with fewer semiconductors, the reliability is increased.

The last field of application follows naturally. This is the field of industrial control. Here, as in the space vehicle situation, reliability is of paramount importance and the speed requirements are not too great. Thus, it will be possible to build industrial control computers that operate at speeds faster than those of present day machines and yet have significantly fewer semiconductors. This will be a big step toward the 24-hour per day, seven day per week operation demanded by industry. ●

## HEAVY DUTY ELEVATED FLOORING

### THE "ONLY" FLOOR



The photos show a small portion of the computing facilities at CEIR, Inc. in Arlington, Virginia. This facility is the largest commercial computing center in the United States.

### The "Only" Floor for

Computer rooms—electronic laboratories—business machines areas—temporary and permanent staging and special instrumentation platforms.

### To Accommodate

Intercabling, air conditioning, duct work and all other utilities.

### The "Only" Floor is

A prefabricated raised floor assembly. Custom designed using the highest quality honeycomb sandwich construction to satisfy the demands of architects, engineers and scientists, by presenting an attractive, durable, strong, fire resistant and accessible panel floor.

## HMP

Write for descriptive literature.  
HARFORD METAL PRODUCTS, INC.  
Aberdeen, Maryland

**How to make  
your move  
without  
making a  
move...**



• Tired? We've made it easy for you. Western Union, open-handed and large-hearted as ever was, has agreed to bring us your message at *no cost to you*. All you do is hand Western Union the blank below (tear out the whole page, if you feel strong enough) with check marks in the right places. We do the rest.

For example, we'll send you information about the broadly varied opportunities at *tech/ops*, and an illustrated brochure about this medium-sized and growing research and development firm with the usual benefits and an *unusual* profit-sharing plan. But do it today.

<table border="1" style="width: 100%; border-collapse: collapse;"> <tr> <th colspan="2" style="text-align: center;">DOMESTIC SERVICE</th> </tr> <tr> <td colspan="2" style="font-size: small;">Check the class of service desired; otherwise this message will be sent as a fast telegram</td> </tr> <tr> <td style="text-align: center;">TELEGRAM</td> <td style="text-align: center;">\$</td> </tr> <tr> <td style="text-align: center;">DAY LETTER</td> <td style="text-align: center;">S</td> </tr> <tr> <td style="text-align: center;">NIGHT LETTER</td> <td style="text-align: center;">E</td> </tr> </table>	DOMESTIC SERVICE		Check the class of service desired; otherwise this message will be sent as a fast telegram		TELEGRAM	\$	DAY LETTER	S	NIGHT LETTER	E	<h1 style="margin: 0;">WESTERN UNION</h1> <h2 style="margin: 0;">TELEGRAM</h2> <p style="font-size: x-small;">1206 (4-55) W. P. MARSHALL, PRESIDENT</p>	<table border="1" style="width: 100%; border-collapse: collapse;"> <tr> <th colspan="2" style="text-align: center;">INTERNATIONAL SERVICE</th> </tr> <tr> <td colspan="2" style="font-size: small;">Check the class of service desired; otherwise the message will be sent at the full rate</td> </tr> <tr> <td style="text-align: center;">FULL RATE</td> <td style="text-align: center;">\$</td> </tr> <tr> <td style="text-align: center;">LETTER TELEGRAM</td> <td style="text-align: center;">S</td> </tr> <tr> <td style="text-align: center;">SHORE-SHIP</td> <td style="text-align: center;">E</td> </tr> </table>	INTERNATIONAL SERVICE		Check the class of service desired; otherwise the message will be sent at the full rate		FULL RATE	\$	LETTER TELEGRAM	S	SHORE-SHIP	E
DOMESTIC SERVICE																						
Check the class of service desired; otherwise this message will be sent as a fast telegram																						
TELEGRAM	\$																					
DAY LETTER	S																					
NIGHT LETTER	E																					
INTERNATIONAL SERVICE																						
Check the class of service desired; otherwise the message will be sent at the full rate																						
FULL RATE	\$																					
LETTER TELEGRAM	S																					
SHORE-SHIP	E																					
NO. WDS.-CL. OF SVC.	PD. OR COLL.	CASH NO.	CHARGE TO THE ACCOUNT OF	TIME FILED																		

Send the following message, subject to the terms on back hereof, which are hereby agreed to

**I am now a**

<input checked="" type="checkbox"/> senior mathematician with a Ph.D. in mathematics or physics and experience with digital computers and modern programming techniques <b>1</b> <input type="checkbox"/> analysis division director with a Ph.D. and eight years of experience since my B.S. or B.A. degree <b>2</b> <input type="checkbox"/> senior OR analyst with a graduate degree in mathematics or the physical sciences and experience in OR and/or systems analysis <b>3</b>	<input type="checkbox"/> associate OR analyst with a graduate degree in mathematics or the physical sciences <b>4</b> <input type="checkbox"/> research aide <b>5</b> I am interested in hearing more about positions available at <u>tech/ops</u> .
---	--

NAME \_\_\_\_\_

ADDRESS \_\_\_\_\_ TELEPHONE \_\_\_\_\_

Mr. Kingsley S. Andersson  
**Technical Operations, Incorporated**  
 Washington Research Office  
 3520 PROSPECT STREET, N. W. • WASHINGTON, D. C.

Circle 80 on Reader Service Card.

**"THE PROGRAMMING FIELD** is on the verge of tremendous changes. If we consider the developments in programming techniques and computer hardware that are currently in progress, these alone are enough to make one pause. Added to this are the new uses to which digital computers are being put, such as in management and process control systems. These new uses have created classes of problems for which we do not even have an adequate language to formulate the problems.

"We at SDC are aware of these imminent changes and are preparing for them by extensive activity in pure and applied research in computer programming. Realizing that a large computer based system consists of many integrated components, we are also undertaking interdisciplinary research among such diverse fields as computer programming, electrical engineering, psychology, and operations research.

"If you are a senior member of the programming profession and would like to participate in advanced research projects, you are invited to contact Mr. William Keefer at System Development Corporation, 2478 Colorado Ave., Santa Monica, Calif."



Robert Bosak, Head of the Data Processing Research Staff

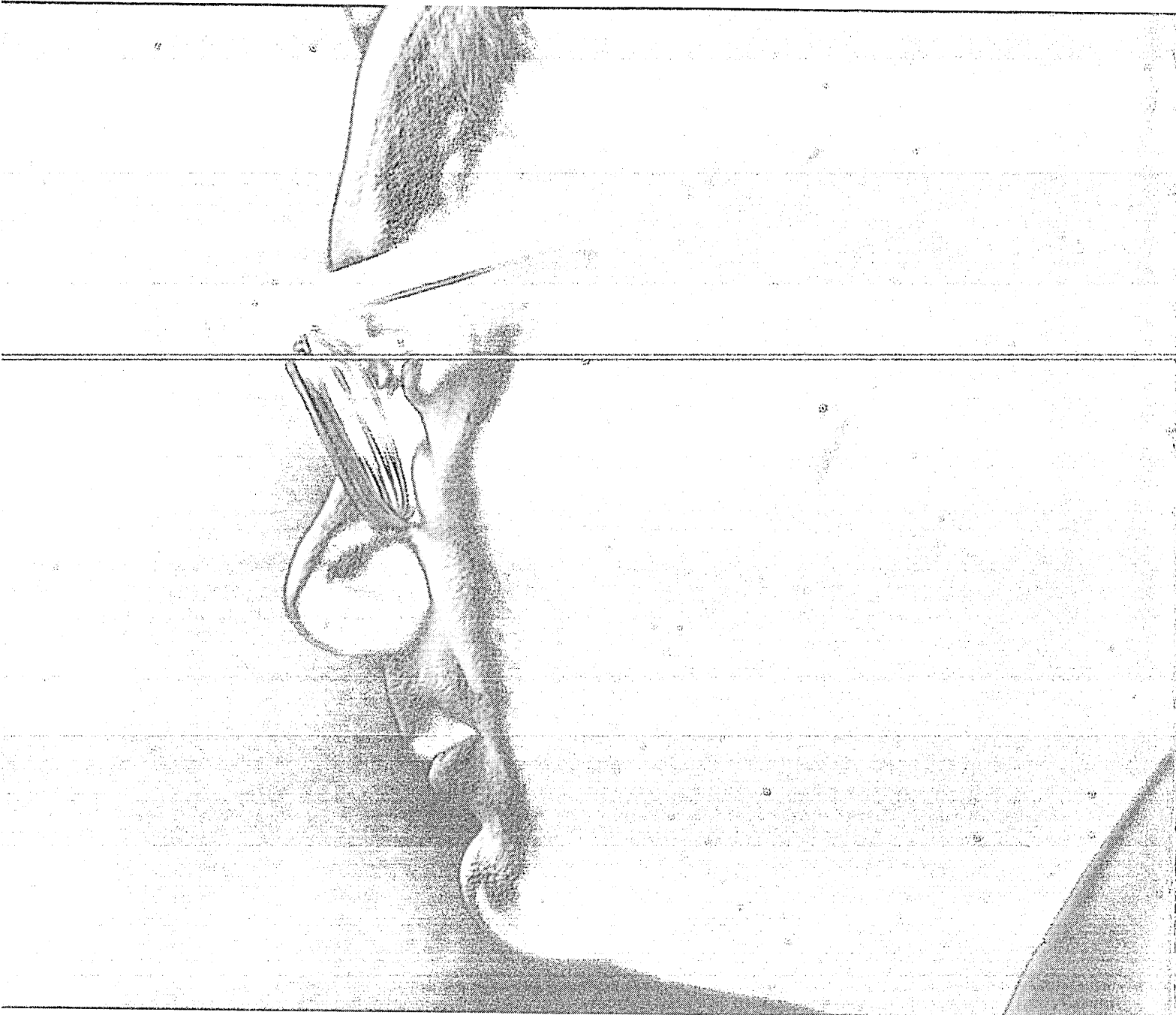

Robert Bosak, Head of the Data Processing Research Staff



## SYSTEM DEVELOPMENT CORPORATION

Circle 81 on Reader Service Card.

SANTA MONICA, CALIFORNIA · LODI, NEW JERSEY

# JB

# TRANSISTORFORMERS

The Ultimate in Subminiature  
Transistor Transformers

**JB TRANSISTORFORMERS** are specified by leading manufacturers of computers, missiles, transistor radios, F-M trceivers, telephone message recorders, miniature electronic airborne equipment and hearing aids. Used with transistor circuits, **JB TRANSISTORFORMERS** will reduce the size of your product, match outputs at all points in your circuit and improve your frequency response.

The "JB" Transistorformer series listed below is designed to meet MIL-T-27A, Grade 2, Class R specifications. All units are impregnated and encapsulated with epoxy resin.

### All types available for immediate delivery!

PART NO.	APPLICATION	TURNS RATIO PRI. TO SEC.	IMPEDANCE (OHMS)		D.C. RESISTANCE (OHMS)	
			PRI.	SEC.	PRI.	SEC.
JB1	INTERSTAGE	4.47:1	20,000	1,000	1,700	275
JB2	INTERSTAGE	5.01:1	20,000	800	1,600	170
JB3	INTERSTAGE	2.56:1	10,000 CT	1,500 CT	1,150	110
JB4	OUTPUT	2.83:1	500	50	115	12
JB5	OUTPUT	2.82:1	400	50	70	10
JB6	INPUT	14.1:1	200,000	1,000	6,500	245
JB7	OUTPUT	4.00:1	1,000	50	240	16
JB8	INPUT	14.0:1	200,000 CT	1,000 CT	6,500	245
JB9	OUTPUT	1.54:1	1,500 CT	600	210	120
JB10	REACTOR		3 HYS. @ 2ma		1,100	
JB11	REACTOR		1 HY. @ 2ma		200	
JB12	REACTOR		6 HYS. @ 2ma		2,600	
JB13	OUTPUT	13.5:1	600	3.2	90	0.8
JB14	OUTPUT	18.0:1	1,200	3.2	190	0.8
JB15	OUTPUT	53.2:1	10,000	3.2	1,500	0.8
JB16	DRIVER	4.44:1	10,000 CT	500 CT	1,160	45
JB17	DRIVER	3.03:1	10,000	1,200 CT	1,160	100
JB18	DRIVER	2.22:1	10,000	2,000 CT	1,380	170
JB19	OUTPUT	1.23:1	900 CT	600	105	110
JB20	OUTPUT	1:1.10	500 CT	600	60	105
JB21	OUTPUT	1:1.42	300 CT	600	40	110
JB22	OUTPUT	3.30:1	150 CT	12	25	3
JB23	OUTPUT	4.85:1	300 CT	12	40	2
JB24	OUTPUT	6.98:1	600 CT	12	85	2
JB25	OUTPUT	8.14:1	800 CT	12	100	2
JB26	OUTPUT	9.07:1	1,000 CT	12	150	2
JB27	OUTPUT	10.0:1	1,500 CT	12	230	2
JB28	OUTPUT	25.0:1	7,500 CT	12	750	2
JB29	INTERSTAGE	5.00:1	20,000 CT	800 CT	1,500	160
JB30	REACTOR		12 HYS. @ Oma		2,000	
JB31	REACTOR		20 HYS. @ Oma		2,800	
JB32	INTERSTAGE	1:3.00	10,000	90,000	980	5,600

Windings of above units are from wire size 34 A.W.G. to 52 A.W.G.—wound on nylon bobbins and using nickel alloy laminations. Leads are #26 A.W.G. solid tinned copper wire 2" long.

**WHEN ORDERING**, specify style desired by suffixing -A or -X to part number. (i.e. JB1-A, JB32-X, etc.)

**STYLE A**  
(Core and Coil only)

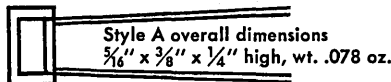

**STYLE X**  
(Black Phenolic Case)

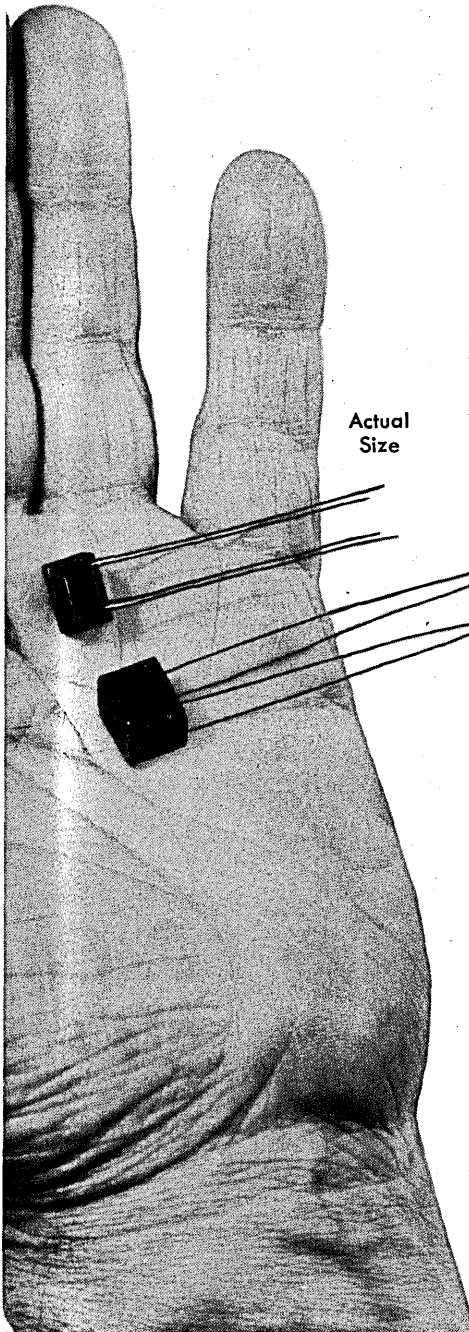
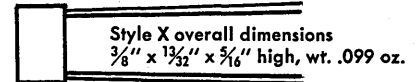

# JB

## ELECTRONIC TRANSFORMERS, INC.

2310 WEST ARMITAGE AVENUE

CHICAGO 47, ILLINOIS

ARmitage 6-0444

*A Gen. Blackledge Enterprise*



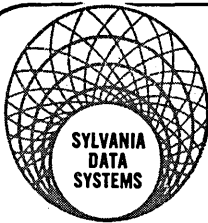

LAST OF A SERIES

# Data Systems and Techniques to Expand Man's Scientific Knowledge

...THE CONTINUING OBJECTIVE OF IMAGINATIVE MINDS  
AT SYLVANIA'S DATA SYSTEMS OPERATIONS

Data processing, frequently regarded as a recent development, is as old as mankind. When we witness a person counting on his fingers, we are watching the world's oldest — and simplest — digital computer in operation. With man's constant search for faster, more efficient ways of processing and reducing data came the development of devices such as the abacus, straightedge-and-compass, slide rule, astrolabe, nomogram, planimeter and integrator. Each of these inventions brought measurable advances in engineering and the physical sciences.

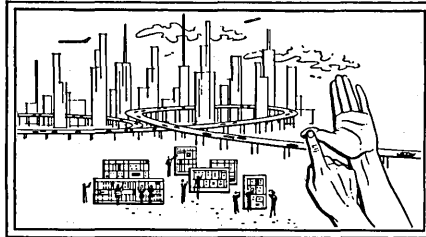

Today, the world has entered the scientific age in which the bold dreams of yesterday are becoming realities. At Sylvania's Data Systems Operations far-ranging programs in data systems are directed toward expanding man's scientific knowledge and developing new technologies. Typical of these projects are MOBIDIC, the first mobile, transistorized, large-scale computer and the data processing phase of BMEWS, the USAF's Ballistic Missile Early Warning System.

■ **MECHANICAL ENGINEER** Senior positions in product engineering & design of data processing systems. Areas: (1) packaging design of digital & analog circuits with emphasis on modularity & standardization; (2) structural design of cabinets, racks, chassis & other modular packaging; (3) environmental control, testing & analysis; (4) design of operator's consoles & displays; (5) design of electronic test equipment; (6) systems integration.

■ **SENIOR SYSTEMS ENGINEERS** To work on digital data systems. Past experience (5-10 years) as Systems Designers or Project Leaders. Also openings for JR. SYSTEMS ENGINEERS with 1-5 years experience.

■ **SENIOR ENGINEER** BS/EE; at least 2 years recent experience in transistor circuit design; 5 years total experience in diversified circuit work, particularly digital computer circuits. Design & supervise development of transistor circuits to operate over wide temperature range. Select & specify components, packaging layout & interconnecting cables for pulse & switching circuits, high gain linear amplifiers & selection matrices.

Please send resume to J. B. Dewing  
Data Systems Operations / SYLVANIA ELECTRONIC SYSTEMS

A Division of

**SYLVANIA**

Subsidiary of  
GENERAL TELEPHONE & ELECTRONICS



189 B Street — Needham 94, Massachusetts

Circle 82 on Reader Service Card.

## NEW LITERATURE

**TRANSISTOR RELIABILITY:** A twenty-page booklet contains reprints of the series of articles "How To Design for Transistor Reliability" by J. B. Hangstefer and L. H. Dixon, Jr. Diagrams and tables are included. For copy write SOLID STATE PRODUCTS, INC., 1 Pingree St., Salem, Mass., or use reader service card.  
Circle 260 on Reader Service Card.

**TAPE EDITING:** Model 150 tape preparation and editing console is described, with specifications, illustrations and diagrams in a six-page leaflet No. TRC-M1501. The unit features tape to tape duplication or verification at sixty characters per second, allows correction to be made without splicing or over-punching. For copy write TALLY REGISTER CORP., 5300 14th Ave., N.W., Seattle 7, Washington, or use reader card.  
Circle 261 on Reader Service Card.

**DISK MEMORY:** Specifications and description of new magnetic disk memory are contained in a four-page leaflet 515-K. Type 55000-304 has storage capacity of 4096 words; type 55050-304 — 4160 words. Price list is included. For copy write AUTONETICS INDUSTRIAL PRODUCTS, a Div. of North American Aviation, Inc., 3548 Wilshire Blvd., Los Angeles 5, Calif., or use reader service card.  
Circle 262 on Reader Service Card.

**X-Y PLOTTER:** Model 210 X-Y plotter, with multiple symbol printing head and removable modular control section for added versatility, is described and illustrated with specifications in a four-page leaflet. For copy write LIBRASCOPE, INC., 808 Western Ave., Glendale, Calif., or use card.  
Circle 263 on Reader Service Card.

**AUTOMATIC TEST SYSTEM:** A new 24-page booklet, No. 307, is available on SCATE, a pre-programmed automatic test system using only solid-state devices in computer circuit modules assembled in a mobile console. SCATE can evaluate all signifi-



cant parameters of the system under test and can reduce the time required for checking out complex electronic systems to minutes, claims the manufacturer. For copy write STROMBERG-CARLSON, 1400 North Goodman St., Rochester 3, N.Y., or use card.

Circle 264 on Reader Service Card.

**TAPE PERFORATOR:** This manufacturer's high speed tape perforator, with an operating speed of up to 40 columns per second, is detailed and illustrated in a six-page folder. For copy write DATA INSTRUMENTS, Div. of Telecomputing Corp., 12838 Saticoy St., North Hollywood, Calif.

Circle 265 on Reader Service Card.

**CARD SYSTEMS:** Three units of the Keysort card grooving equipment are illustrated and operating features and specifications listed in sheet No. S-540R59. Keysort marginally-notched card systems are used for inventory control, order and sales analysis and other data processing requirements. For copy write ROYAL McBEE CORP., Data Processing Div., Port Chester, N.Y., or use reader card.

Circle 266 on Reader Service Card.

**FREQUENCY CONVERTER:** Four-page bulletin No. 2024 describes a broad range frequency converter for 15 to 40,000 cps inputs. Applications include recorders, computers, digital indicators, and millimeters. For copy write COX INSTRUMENTS DIVISION, George L. Nankervis Co., 15300 Fullerton, Detroit 27, Mich.

Circle 267 on Reader Service Card.

**WELDED ASSEMBLIES:** Six-page illustrated brochure describes this company's welded assembly technique for high density packaging of electronic components—particularly adaptable to installations in data processing equipment, computers, and airborne electronic systems. For copy write Mr. Wesley J. Davis, Dept. 2528, Industrial Tube Division, RAYTHEON COMPANY, 55 Chapel St., Newton 58, Mass., or use reader service card.

Circle 268 on Reader Service Card.

**SPEED CHANGERS:** Bulletin No. 96 describes this company's new Series 2 miniature adjustable ratio speed changers, for use in analyzers business machines, chart drives, computers and

scanning mechanisms. For copy write METRON INSTRUMENT CO., 432 Lincoln St., Denver 3, Colorado.

Circle 269 on Reader Service Card.

**PROGRAMMING TECHNIQUE:** A seven-page bulletin describes the routine called "RECIPE" (Recomp Computer Interpretive Program Expediter), a new computing technique for use with the Recomp II. For copy write AUTONETICS, A Div. of North American Aviation, Inc., 9150 E. Imperial Highway, Downey, California.

Circle 270 on Reader Service Card.

**MAGNETIC CLUTCH:** The C-18 Magnetic Clutch for applications in the field of computers is described with specifications and average characteristics in a data sheet. For copy write GUIDANCE CONTROLS CORP., 110 Duffy Ave., Hicksville, L.I., N.Y.

Circle 271 on Reader Service Card.

**ANALOG COMPUTER:** A four-page illustrated leaflet is available outlining this manufacturer's Model 200 analog computer. One of the features includes digital coefficient entry per-

## MATHEMATICIAN

(Numerical Analyst)

Applied mathematician required to analyze engineering and scientific problems and program their solution for a large electronic computer. Must have honour degree in mathematics. Preference for one years post-graduate work in applied mathematics.

Applying giving full details of qualifications, experience and salary expected to:

Box 308

141 E. 44th St.

New York 17, N.Y.

Circle 83 on Reader Service Card.

## elevated aluminum flooring

### ELAFLOR\*

RECOMMENDED  
FOR COMPUTER  
ROOMS,  
BUSINESS  
MACHINE AREAS

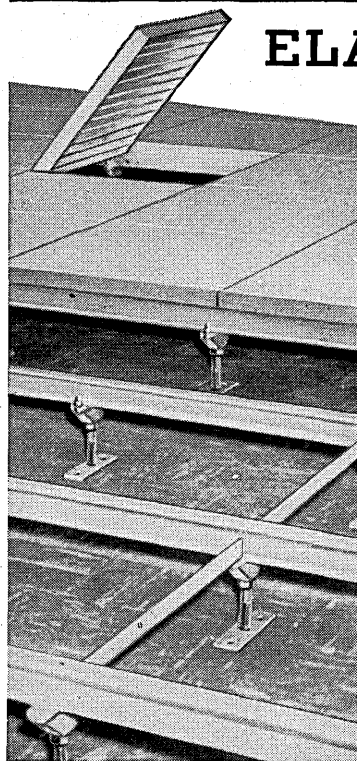

Provides a strong, elevated, fire resistant floor with free access to cables, air conditioning ducts, air and vacuum lines, telephone lines, etc. Elaflor ... designed for computer rooms ... business machine areas, etc. gives you these advantages plus the durability of extruded aluminum and the beauty of the floor covering of your choice.

Write for free Elaflor literature and installation examples

\*Pat. App. For



### LISKEY ALUMINUM, INC.

Friendship International Airport, Box 506 Glen Burnie 4, Md.

Circle 23 on Reader Service Card.

# MILMAN

## DIGITAL AND MESSAGE READOUTS

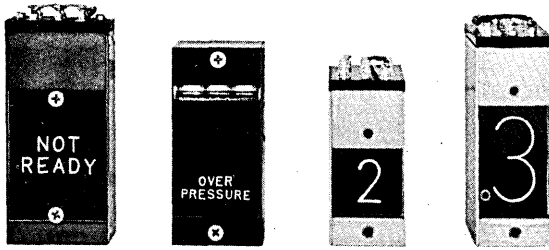

### APPLICATIONS

PROCESS CONTROL, PRODUCTION TEST EQUIPMENT, AUTOMATIC SYSTEMS, CONDITION INDICATORS.

DIGITAL COMPUTERS, DISPLAY OF ANY NUMERICAL QUANTITY (TIME, TEMPERATURE, PRESSURE, COUNT, INTERVAL, SPEED, COORDINATES, ETC.).

For further information and prices contact:

**MILMAN ENGINEERING CO.**

1831 Pontius Avenue  
Los Angeles 25, California  
GRanite 3-0616

● Lighted and color coded messages eliminate errors due to misreading of information.

● Superpositioning of one message ahead of the other in the units reduces the panel area required to display information.

● Modular construction allows side by side mounting for in-line presentation of digital or message information.

● Simple panel cutouts and mounting dimensions featured.

● For operation on 6, 12 or 28 volts AC or DC with low current drain.

Circle 24 on Reader Service Card.

mitting high speed setting of four place numerical values. For copy write COLORADO RESEARCH CORP., Broomfield, Heights, Colo.

Circle 272 on Reader Service Card.

**SYMBOLIC LOGIC:** A 32-page manual entitled, "Symbolic Logic, Boolean Algebra and the Design of Digital Systems," has been compiled by the technical staff of Computer Control Co. It is a comprehensive effort toward the understanding of the fundamental principles of symbolic logic and the application of these principles to the design of digital systems. For copy write COMPUTER CONTROL CO., INC., 983 Concord St., Framingham, Mass., or use reader card.

Circle 273 on Reader Service Card.

**TRANSISTOR PLUG-INS:** Detailed physical and electrical specifications of DYKOR transistorized plug-in units for digital systems are described and illustrated in six pages of catalog PI-79. A five-page addenda includes an assortment of novel circuits for application in digital systems from a simple data converter to a complex computer. For copy write DYKOR COMPONENTS DIVISION, Digi-tronics Corp., Albertson, L.I., N.Y.

Circle 274 on Reader Service Card.

**EDUCATIONAL COMPUTER:** Fourteen-page catalog S1 describes SPEC (stored program educational computer) general-purpose digital computer and digital differential analyzer plus logical design implementer. SPEC is designed for educational usage, serious computation, experimentation and demonstration of modern construction and hardware techniques. For copy write COMPUTER CONTROL CO., INC., 2251 Barry Ave., Los Angeles 64, California.

Circle 275 on Reader Service Card.

**POWER SUPPLIES:** The Magitran line of solid state regulated power supplies are described in a new four-page catalog No. 114A, with graphs, specifications and physical data. For copy write ELECTRONIC RESEARCH ASSOCIATES, INC., 67 Factory Place, Cedar Grove, N.J.

Circle 276 on Reader Service Card.

**CORE STORAGE BUFFER:** Data sheet, AD-14, "Increasing Computer

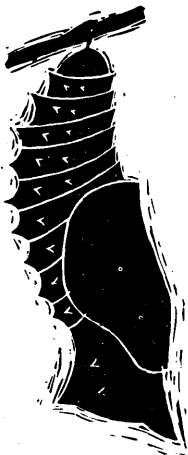

## METAMORPHOSIS

See your R&D metamorphose into usable hardware. Our Inertial Guidance System contracts require that we add to our staff. If you have 3 to 5 years of experience, you probably qualify for a position of responsibility. Inquire today of Mr. C. T. Petrie, Manager, Research & Engineering Staff.



LITTON INDUSTRIES Electronic Equipments Division  
Beverly Hills, California

Capacity and Flexibility by Magnetic Core Buffering" outlines this manufacturer's application of its buffers in the UNIVAC 1105. For copy write **TELEMETER MAGNETICS, INC.**, 2245 Pontius Ave., Los Angeles 64, Calif., or use reader service card.

Circle 277 on Reader Service Card.

**RECORDER/REPRODUCER:** A twelve-page illustrated booklet describes the FR-600 transistorized analog magnetic tape recorder/reproducer in twin-rack cabinet. Tape may be fed to visual display devices or converted for analysis by computers, plotters or calculators. Specifications are included. For copy write **AMPEX CORP.**, 934 Charter St., Redwood City, Calif., or use reader card.

Circle 278 on Reader Service Card.

**TAPE TRANSPORTS:** A 12-page brochure entitled, "Transistorized Tape Transports and Accessories" specifies manufacturer's complete line of digital magnetic and perforated tape handlers and record/playback heads and amplifiers. For copy write **POTTER INSTRUMENT CO.**, Sunnyside Blvd., Plainview, L.I., N.Y.

Circle 279 on Reader Service Card.

**DATA STORAGE:** An eight-page brochure outlines this company's combined capabilities of video and parallel digital magnetic tape recording in one data storage system, for the industrial and military markets. Illustrations and typical specifications are included. For copy write **LOCKHEED AIRCRAFT CORP.**, Market Administration Dept., Burbank, Calif.

Circle 280 on Reader Service Card.

**HYBRID SYSTEMS:** A twelve-page brochure illustrates and describes the capabilities and facilities of this company who specialize in hybrid systems and produce the Light Foot Quantizer, the DIGICORDER, etc. For copy write **COMPUTER EQUIPMENT CORP.**, 1931 Pontius Ave., Los Angeles 25, Calif., or use card.

Circle 281 on Reader Service Card.

**PNPN TRIGISTOR:** A two-page technical data sheet describes the Silicon Trigistor, a new circuit equivalent component with characteristics which approximate the circuit function of a flip-flop. For copy write **SOLID STATE PRODUCTS, INC.**, 1 Pingree St., Salem, Mass., or use reader card.

Circle 282 on Reader Service Card.

**Responsible Assignments  
Stimulating Association for  
PHYSICISTS, MATHEMATICIANS,  
and ELECTRONICS ENGINEERS**

From a small test center where the first atomic bomb was exploded in 1945 to today's modern extensive missile testing facility—that's the Air Force Missile Development Center at Holloman, the site of Telecomputing Services, Inc.

We work with high-speed digital computers and other data reduction equipment to reduce, analyze, and evaluate data gathered from various instrumentation systems located on the White Sands Missile Range; and prepare reports for the government and contractors.

Our continuing growth is creating new positions for qualified engineers . . . a growth accelerated by recognition of individual achievement . . . a growth YOU can share.

If you are a physicist, mathematician, or electronics engineer we invite you to investigate the opportunities as a Data Processing Specialist in this expanding field of missiles, satellites, and space travel.

*In addition to our pleasant, modern facility and professional working atmosphere, other benefits include: Attractive Salaries, Area Bonus, Relocation Pay, Profit Sharing, Group Insurance, Educational Reimbursement.*

For Application and Further Information, write:  
Director of Technical Personnel

**TELECOMPUTING SERVICES, INC.**  
SUBSIDIARY OF  
**TELECOMPUTING CORPORATION**  
BOX 447-C, HOLLOMAN AIR FORCE BASE, NEW MEXICO

Circle 84 on Reader Service Card.

## ENGINEERS RESEARCH OPPORTUNITIES

Aeronutronic, a new division of Ford Motor Company, has immediate need for computer engineers to staff its new \$22 million Research Center in Newport Beach, Southern California. Here, you have all the advantages of a stimulating environment, working with advanced equipment, located where you can enjoy California living at its finest.

Look into these ground floor opportunities in research and development work that is challenging and exceptionally rewarding to qualified men.

### Positions now open:

- Systems Engineer
- Magnetic Memory Engineers
- Communications Engineers
- Digital Computer Programmers
- Transistorized Circuit Engineers
- Logical Designers
- Circuit Engineers
- Mechanical Engineers
- Optical Engineers

Qualified applicants are invited to send resumes or inquiries to Mr. R. E. Durant, Aeronutronic, Box NH-486, Newport Beach, California.

### Computer Operations

## AERONUTRONIC

a Division of  
**Ford Motor Company**  
Newport Beach  
Santa Ana • Maywood  
California

Circle 85 on Reader Service Card.

ELECTRONICS: Over, on and under...

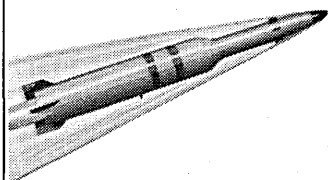

## DIGITAL COMPUTER ENGINEERS

**NOW IS THE TIME TO MOVE UP FAST WITH AUTONETICS**

Here's your opportunity to join the team that developed the nation's first transistorized portable digital computer with "Big Computer" capabilities.

Autonetics now offers you advanced opportunities in the design, research, development, test and checkout, manufacture, and field service of digital computers. Apply your experience to:

- Inertial Guidance Systems
- Flight Control Systems
- Automatic Checkout Centrals
- Armament Control Systems

BSEE or better is preferred, along with several years experience in either systems or components associated with digital computers in circuits, memories, input-output equipment, logic design, analysis, or programing.

Send your resume to:  
 Mr. B. D. Benning,  
 Manager, Employment Services  
 Dept. F-102  
 9150 East Imperial Highway  
 Downey, California

**Autonetics**   
 A Division of North American Aviation, Inc.

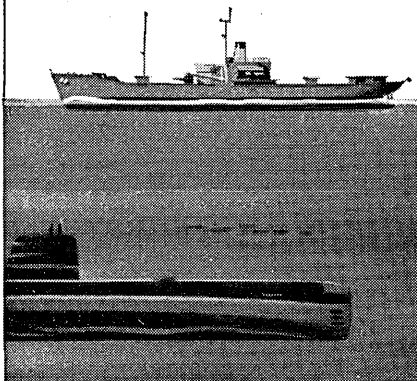

## ADVERTISERS' INDEX

Aeronutronic .....	55
Armour Research Foundation .....	56
Autonetics Division, North American Aviation, Inc. ....	56
Battelle Memorial Institute .....	45
Bendix Computer Div. ....	4
Benson-Lehner Corp. ....	27
C-E-I-R, Inc. ....	43
Chrysler Corp. ....	44
Computer Control Co., Inc. ....	2
Computer Systems, Inc. ....	18
Consolidated Systems Corp. ....	22
Curtiss-Wright Corp. ....	40
DATAmatic Division, Minneapolis-Honeywell .....	14
Di/An Controls, Inc. ....	38
Digital Equipment Corp. ....	39
ElectroData Division, Burroughs Corp. ....	6, 7
Electronic Associates, Inc. ....	13
Epsco, Inc. ....	Cover 4
Gerber Scientific Instrument Co. ...	37
Harford Metal Products, Inc. ....	48
International Business Machines Corp. ....	20
International Electric Corp. ...	Cover 3
JB Electronic Transformers, Inc. ...	51
Liskey Aluminum, Inc. ....	53
Litton Industries .....	54
Lockheed Missiles & Space Div. ...	48
Magnavox Co. ....	16
Milman Engineering Co. ....	54
The Mitre Corp. ....	30
Perfection Mica .....	45
Radio Corporation of America Astro-Electronic Products Div. ...	36
Radio Corporation of America Electronic Data Processing Div. ...	41
Royal McBee Corp. ....	24
Sandia Corp. ....	44
Space Technology Laboratories, Inc. ...	35
Stromberg-Carlson Div., General Dynamics .....	29
Sylvania Electronic Systems .....	52
System Development Corp. ....	50
Tally Register Corp. ....	42
Technical Operations, Inc. ....	49
Telecomputing Corp. ....	3
Telecomputing Services, Inc. ....	55
Telemeter Magnetics, Inc. ....	Cover 2
Texas Instruments, Inc. ....	5
Washington Aluminum Co. ....	42

## OPERATIONS RESEARCH MATHEMATICAL PROGRAMMING COMPUTER APPLICATIONS STATISTICS

Challenging assignments are available for Operations Analysts, Mathematicians, and Statisticians in an expanding research group engaged in applied and basic investigations for industry and government. Creative and versatile individuals will find the professional atmosphere stimulating and rewarding. A UNIVAC 1105 Computer facility is available as a research tool for all staff members.

Applicants should preferably have an advanced degree and be experienced in one or more of the following:

- Probabilistic Modeling
- Information System Studies
- Analytical Studies
- Game and Queueing Theory
- Network Optimization Studies
- Theory of Computing Algorithms
- Linear and Non-linear Programming
- Learning Theory

Armour Research Foundation is in a metropolitan area offering outstanding cultural and educational advantages. Excellent salaries are offered to suit your individual experience and educational background. Benefits include insurance and retirement programs, an extremely liberal vacation program, and tuition-free advanced studies. Generous relocation and interview allowances are provided. For further information write to:

Allen J. Paneral

**ARMOUR RESEARCH FOUNDATION**  
*of Illinois Institute of Technology*

10 West 35th Street  
 Chicago 16, Illinois  
 Circle 86 on Reader Service Card.



## WITH ONLY MINUTES TO ACT

If America should be attacked . . . from bases around the world Strategic Air Command bombers, tankers and surface-to-surface missiles will rise to action. Minutes only will be available.

To integrate and control this assault requires accessibility and handling of a staggering volume of data. In the missile era, present methods of gathering and processing data will be inadequate. SAC is automating the system.

As systems manager, International Electric Corporation is developing and will turn over to SAC a world-wide electronic

combat control system, an integrated complex of electronic subsystems. The system, employing digital techniques and equipment, will transmit, process and display information on a global basis . . . with only seconds involved.

Engineers whose interests lie in systems engineering, data processing and communications will find in this long-term project exceptional opportunity to exercise creative competence and individual initiative. For details of engineering assignments write B. J. Crawford, Director of Technical Staffing.

## INTERNATIONAL ELECTRIC CORPORATION

*An Associate of International Telephone and Telegraph Corporation*  
Route 17 & Garden State Parkway, Paramus, New Jersey



# YOUR digital data input

Computer-format **tape output**

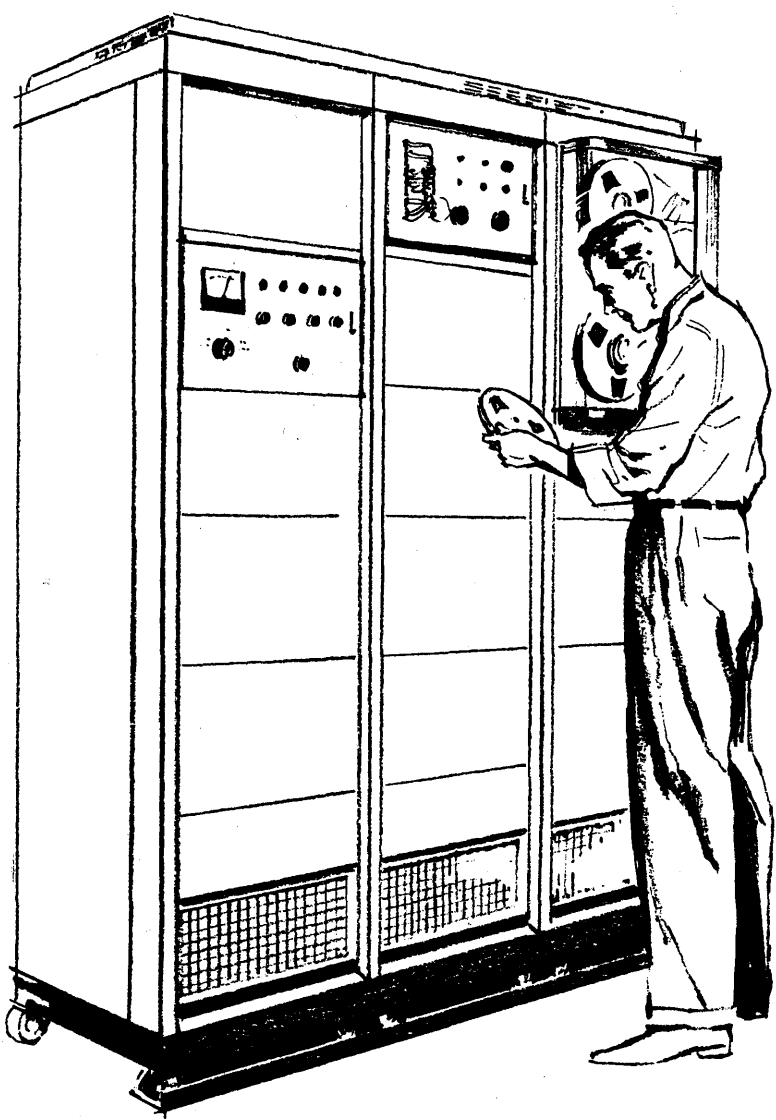

### The Epsco Model S-2000

Digital Recorder accepts your digital data in parallel form, either synchronous or asynchronous rates, and prepares magnetic tape in a format suitable for direct entry into your computer.

As a standard production unit, the Model S-2000 Digital Recorder incorporates design features that insure compatibility with a broad range of data processing requirements. Automatic processing of digital data into computer format permits you to increase the usefulness of your computer facility and to reduce significantly the time and cost of data preparation.

For complete technical information write: Systems Division, Epsco, Inc., 275 Mass. Ave., Cambridge, Mass.

*Assembly-line techniques are effecting substantial time and cost savings in the production of Epsco Digital Recorders.*

**Epsco**   
 First in data control

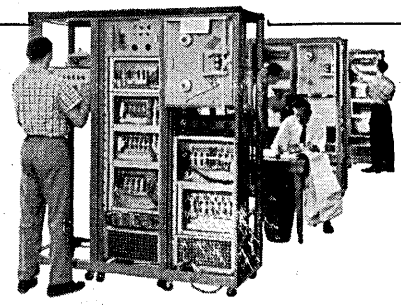

Circle 25 on Reader Service Card.