

# electronics®

## CHEMICAL

### LASER

Pyrotechnic pumping  
cuts size and weight

(photo below)

## HALL DEVICES:

### NEW CIRCUITS

Three useful  
modulation schemes

## BEACON RECEIVER

### FOR LIGHT PLANES

Solid-state design  
includes agc



ALSO IN THIS ISSUE:

**ELECTRONICS IN ISRAEL**



LEWIS H. YOUNG, Editor  
Dial Direct: (971-2645)  
Area Code 212

JANUARY 17, 1964

J. M. CARROLL, Managing Editor (2293)

SENIOR EDITORS  
Samuel Weber (2371)  
George W. Sideris (3444)

SENIOR ASSOCIATE EDITORS  
Michael F. Wolff (2600)  
John F. Mason (2666)

ASSOCIATE EDITORS  
Michael F. Tomaino (2071)  
William P. O'Brien (2297)  
George J. Flynn (2188)  
George V. Novotny (3151)  
Leon H. Dulberger (3446)  
Alexander A. McKenzie (2685)

ASSISTANT EDITORS  
Stephen B. Gray (2245)  
Barry A. Briskman (2306)  
Dan Smith (2467)  
Joel A. Strasser (2127)  
Vincent S. Acunto (2592)  
C. R. Whetstone (3495)  
Eric Valentine (2710)  
Louis S. Gomolak (2472)  
G. G. Tirellis (2187)

REGIONAL EDITORS  
Harold C. Hood,  
1125 W. 6th St., Los Angeles 90017, Calif.  
(213-482-5450)  
Laurence D. Shergalis,  
John Hancock Bldg., 255 California St.,  
San Francisco 94111, Calif. (415-362-4600)  
Thomas Maguire  
McGraw-Hill Bldg., 607 Boylston St.,  
Boston 02116, Mass. (617-262-1160)  
Cletus M. Wiley,  
Blair Bldg., 645 N. Michigan Ave.,  
Chicago 60611, Ill. (312-664-5800)

ART DIRECTOR  
Howard R. Berry (2430)

ASSISTANT ART DIRECTOR  
John C. Wright, Jr. (3430)

EDITORIAL ASSISTANTS  
Lorraine Rossi, Virginia T. Bastian,  
Lynn Emery, Ann Mella, Lorraine Werner,  
Alice M. Moyer, Sharon Parks,  
Claire Benell, Kay Fontana,  
Sandra A. Le Mond, Mary Jo Jadin

FOREIGN NEWS BUREAU  
DIRECTOR, John Wilhelm, (2532);  
Lawrence Mihlon (2997), Alyne Elias  
(2998)  
LONDON—John Shinn, Derek Barlow,  
Nicholas Landon, 34 Dover St., London  
W.1, England  
BONN—Richard Mikton,  
Silke McQueen, Mittelstrasse 39, Bad  
Godesberg, Germany  
BRUSSELS—Arthur Erikson, 27 Rue Ducarler,  
Brussels, Belgium  
PARIS—Robert Farrell, 17 Ave. Matignon,  
3rd Fl., Paris 8, France  
MILAN—Bruce Bendow, Via Manzoni  
No. 12, Milan, Italy  
MEXICO CITY—Wesley Perry, Jr.,  
Lafragua 4-314, Mexico 1 D.F. Mexico  
RIO DE JANEIRO—Leslie Warren, Rua  
Mexico 3-S/1507 1509, Rio de Janeiro,  
Brazil  
MOSCOW—Donald Winston,  
Kutuzovsky Prospekt 19, Apt. 28-29,  
Moscow, USSR  
TOKYO—Richard Halloran, Charles Cohen,  
John Yamaguchi, Toranomom Sangyo  
Bldg., 1 Kotohiracho Shiba, Minato-Ku,  
Tokyo, Japan

CIRCULATION MANAGER  
Hugh J. Quinn (2310)

C. C. RANDOLPH, Publisher (2016)

# electronics

A MCGRAW-HILL PUBLICATION 75 CENTS

**CHEMICALLY-PUMPED** laser light has been produced at North American Aviation by exploding a small capsule filled with pyrotechnic powder; laser output was in the 5,000 to 9,000-angstrom band. A 40-pound chemical laser could produce output equivalent to that of a 1,000-lb conventional laser. *Present research concentrates on learning to trigger lasers without damaging them by shock waves. See p 48 COVER*

**U.S.-USSR SPACE TESTS.** Next week's scheduled launch of the Echo II passive communications satellite will set the stage for American-Russian cooperation in space experiments. *British facilities will relay our signals to the Russians* 10

**SCR'S PULSE RADAR.** Semiconductor-magnetic circuits generate fast, high-power pulses. Uses in radar, sonar and lasers are being explored. *Pulse is built up in capacitors, so low-voltage unregulated supply may be used* 14

**ELECTRONICS IN ISRAEL.** A first-hand portrait of a nation at the threshold of developing its own diversified electronics industry. Its assets include a large number of competent scientists, engineers and technicians, excellent test apparatus and a heritage of high interest in research and development. *Products will encompass computers, instruments and equipment for the armed services.* By W. W. MacDonald, Consultant 23

**NEW USES FOR HALL DEVICES.** These Hall-effect modulators consist of a rectangular indium arsenide element cemented to a ferrite disk. Three applications are modulating a 1-Mc carrier with a 400-cps tone, producing bursts of audio-frequency signals and generating bursts in which the prf is higher than the audio frequency. *The last circuit can detect low-frequency magnetic fields.* By A. R. Hilbinger, Aircraft Armaments, Inc. 30

**MARKER-BEACON RECEIVER.** Designed for use on light aircraft, this receiver uses silicon planar diffused transistors and is compact in its layout. Design features include crystal-controlled local oscillator, narrow-band r-f filter to reject tv channel 5 and mismatched transistors to eliminate neutralization problems. *Variable emitter feedback provides agc without unwanted changes in input and output impedances.* By J. G. Robertson, Univ. of Washington 33

Contents continued

Published weekly, with Electronics Buyers' Guide as part of the subscription, by McGraw-Hill, Inc. Founder: James H. McGraw (1860-1948).

**SUBSCRIPTIONS:** Available only by paid subscription. Publisher reserves the right to refuse non-qualified subscriptions. Subscriptions to Electronics solicited only from those actively engaged in the field of the publication. Position and company connection must be indicated on subscription orders forwarded to address shown below. Subscription rates for individuals in the field of the publication: U. S. and possessions and Canada \$6 one year, \$9 two years, \$12 three years (single copies 75¢). All other countries \$20 one year (single copies \$1.50).

**EXECUTIVE, EDITORIAL, CIRCULATION and ADVERTISING OFFICES:** McGraw-Hill Building, 330 West 42nd Street, New York, N. Y., 10036. Telephone Area Code 212. 971-3333. Teletype TWX N. Y. 212-640-4646. Cable McGrawhill, N. Y. Printed in Albany, N. Y. Second class postage paid at Albany, N. Y. Title reg. ® in U. S. Patent Office. Copyright © 1964 by McGraw-Hill, Inc. All Rights Reserved. The contents of this publication may not be reproduced either in whole or in part without consent of copyright owner.

**OFFICERS OF MCGRAW-HILL PUBLICATIONS:** Shelton Fisher, President; Vice Presidents: Joseph H. Allen, Operations; John R. Callahan, Editorial; Ervin E. DeGraff, Circulation; Donald C. McGraw, Jr., Advertising Sales; Angelo R. Venezian, Marketing.

**CORPORATION OFFICERS:** Donald C. McGraw, President; L. Keith Goodrich, Hugh J. Kelly, Harry L. Waddell, Executive Vice Presidents; John J. Cooke, Vice President and Secretary; John L. McGraw, Treasurer.

**UNCONDITIONAL GUARANTEE:** The publisher, upon written request, agrees to refund the part of the subscription price applying to the remaining unfilled portion of the subscription if service is unsatisfactory.

**SUBSCRIBERS:** Please address all correspondence regarding subscriptions, change of address notices, and subscription orders to Fulfillment Manager, Electronics, P. O. Box 430 Hightstown, N. J., 08520. Change of address notices should be sent promptly; provide old as well as new address; include zip code or postal zone number if any. If possible, attach address label from recent issue. Please allow one month for change of address to become effective.

**POSTMASTER:** Please send Form 3579 to Fulfillment Manager, Electronics, P. O. Box 430, Hightstown, N. J., 08520.

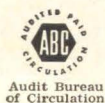

Audit Bureau of Circulation



Associated Business Publications

Contents continued

**REFERENCE SHEET: TEMPERATURE RISE IN WAVEGUIDE.** Power lost due to attenuation generates heat in rigid waveguide structures. *This graph plots average power in watts against temperature rise above ambient for various waveguide sizes and materials.* By T. J. Vaughan, Antenna System, Inc. 36

**RELIABILITY OUTLOOK.** Military plans to use quantitative criteria in reliability specs, is also figuring out cost criteria. *More importance is being given reliability in consumer products, as management warms up to reliability concepts* 39

**ARPAT'S NEW RADAR.** Pencil-beam, 10-Mw-peak radar is ready to start gathering missile reentry data for terminal defense studies. *It may be used for countermeasures experiments, too* 44

**BRITISH POLARIS.** England selects the company to manage navigation systems for its four Polaris submarines. *Subcontractors are to be chosen from British and American firms* 45

DEPARTMENTS

**Crosstalk.** Industry Must Help Itself 5

**Comment.** Standards. Air Surveillance 6

**Electronics Newsletter** 17

**Meetings Ahead.** Precision Electromagnetic Measurements Conference 18

**Washington This Week.** New Procurement Rules to Define Adequate Price Competition 20

**Research and Development.** New Laser Chemically Pumped 48

**Components and Materials.** Standards Proposed for Microcircuit Flatpacks 52

**Production Techniques.** Welder Bonds Smaller Leads 56

**New Products.** System Increases Digital Rate 60

**Literature of the Week** 65

**People and Plants.** IBM Promotes Two Executives 66

**Index to Advertisers** 70

**Now from Sprague!**

# SEPT<sup>®</sup>

## SILICON PLANAR EPITAXIAL TRANSISTORS 2N2217 thru 2N2222

TO-5 (P <sub>D</sub> =.8W) TO-18 (P <sub>D</sub> =.5W)	2N2217 2N2220	2N2218 2N2221	2N2219 2N2222
BV <sub>CBO</sub>	60 V (min.)	60 V (min.)	60 V (min.)
I <sub>CBO</sub> @ 50V	10nA(max.)	10nA(max.)	10nA(max.)
h <sub>FE</sub> @ I <sub>C</sub> =150 mA	20-60	40-120	100-300
V <sub>CE</sub> (SAT) @ I <sub>C</sub> =150 mA	.4 V(max.)	.4 V(max.)	.4 V(max.)
C <sub>ob</sub> @ 10 V	8 pF	8 pF	8 pF
f <sub>T</sub> @ V <sub>CE</sub> = 20 V I <sub>C</sub> = 20 mA	400mc(typ.)	400mc(typ.)	400mc(typ.)

Sprague N-P-N SEPT<sup>®</sup> Transistors are designed for optimum emitter perimeter-to-area ratio, providing outstanding gain uniformity from 0.1 mA to 500 mA and f<sub>T</sub> (typ.) of 400 mc. Sprague epitaxial techniques guarantee high BV<sub>CEO</sub> (30V) and low V<sub>CE</sub> (SAT) (.24 V @ 150 mA).

**SEPT<sup>®</sup> TRANSISTORS FILL A WIDE RANGE OF APPLICATIONS AS SWITCHES, CORE DRIVERS, AND AMPLIFIERS!**

For application engineering assistance, write to Transistor Division, Sprague Electric Co., Concord, N. H. For technical data, write for Engineering Bulletins 32,000, 32,005 and 32,010A to Technical Literature Service, Sprague Electric Co., 35 Marshall St., North Adams, Mass.

### SPRAGUE COMPONENTS

TRANSISTORS  
CAPACITORS  
RESISTORS  
MICROCIRCUITS  
INTERFERENCE FILTERS

PULSE TRANSFORMERS  
PIEZOELECTRIC CERAMICS  
PULSE-FORMING NETWORKS  
TOROIDAL INDUCTORS  
ELECTRIC WAVE FILTERS

CERAMIC-BASE PRINTED NETWORKS  
PACKAGED COMPONENT ASSEMBLIES  
BOBBIN and TAPE WOUND MAGNETIC CORES  
SILICON RECTIFIER GATE CONTROLS  
FUNCTIONAL DIGITAL CIRCUITS



\*Sprague' and '®' are registered trademarks of the Sprague Electric Co

# SIX DIGITS!

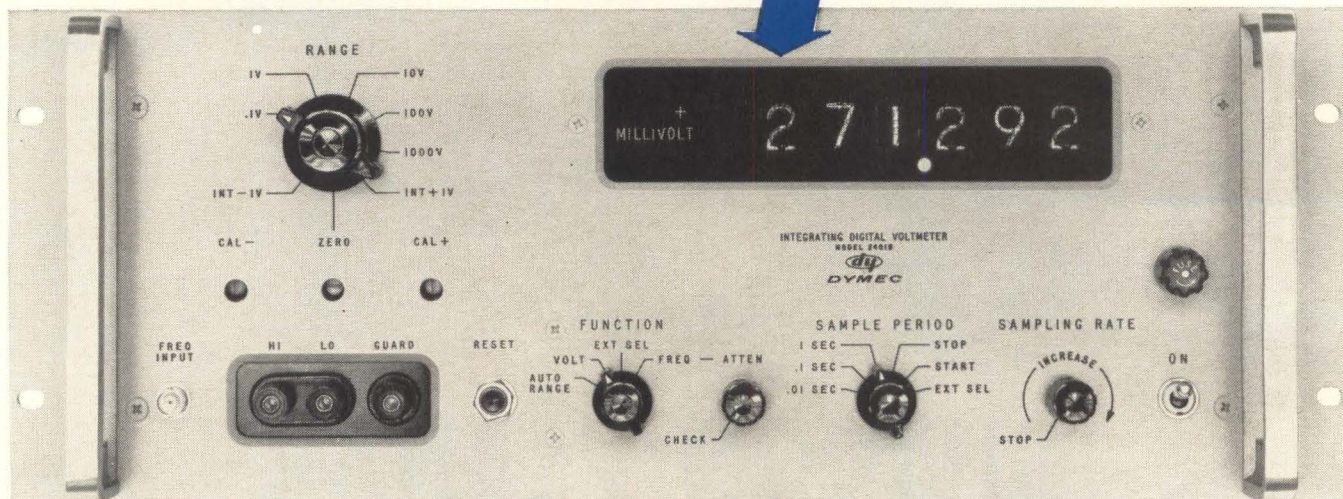

## to display full 300% overranging of the Dymec Integrating Digital Voltmeter

A new sixth digit is available on the world's first and finest integrating digital voltmeter, the DY-2401B... and here's what it gives you:

New convenience in taking advantage of the voltmeter's 300% overranging capability on the 100 millivolt, 1, 10 and 100 volt ranges. For example, you don't have to measure 3 volts on the 10 volt range, thereby losing a full decade of resolution. Measure it on the 1 volt range, taking advantage of the overranging feature. The sixth digit tells you the most significant figure.

*Additionally, an optional autoranging feature is available with the 2401B, for your maximum measuring convenience and speed (only 34 milliseconds maximum range-change time).*

The DY-2401B offers a broader measuring capability than any other digital voltmeter available. Guarded input and integrating operation permit measuring low level signals... even in the presence of high common mode

and superimposed noise. Flip a switch and the voltmeter becomes a 300 kc frequency counter. All functions are programmable by contact closures to ground; BCD output is standard.

Accessory instruments include the DY-2411A Guarded Data Amplifier, which adds a 10 mv full scale range (again, with 300% overranging). The DY-2410B AC/Ohms Converter provides floated and guarded, broadband ac voltage and resistance measurements.

Ask your Dymec/Hewlett-Packard field engineer for a demonstration of the 2401B, now available with these new options: automatic ranging with or without the sixth digit, or the sixth digit with standard manual ranging.

DY-2401B	\$3950
DY-2410B	\$2250
DY-2411A	\$1150

Data subject to change without notice. Prices f.o.b. factory,

## DYMEC

A DIVISION OF HEWLETT-PACKARD COMPANY

DEPT. E-1, 395 PAGE MILL ROAD, PALO ALTO, CALIFORNIA • PHONE (415) 326-1755 TWX 415-492-9363



69

## Industry Must Help Itself

**BOTH the Administration and the Congress** are seeking ways to cushion the effect upon the economy of cutbacks in military spending. Since the drive to cut military spending is of prime concern to the electronics industry in particular, the industry should join in a concerted effort to direct government studies into proposals that show practical promise of accelerating nonmilitary electronics market growth.

Initially, the only firm plan the Administration appears to have is what the Pentagon calls its "early warning system" giving advance notice to contractors when specific cuts are planned so that companies, or regions dependent on programs, can take steps to prepare for alternate work. Under our free-enterprise system, industry cannot expect a customer to do much more than that.

The government, however, is more than a customer. It is also committed to keeping the economy buoyant and growing. Therefore, it is reasonable to assume that the government will favor ways to take up slack and move ahead in a more positive fashion than merely telling industry to seek new customers.

Congress is talking about broadening government support of nonmilitary research. This holds promise for electronics market development, particularly if the projects undertaken fill a positive public need (*Crosstalk*, p 5, Dec. 27, 1963).

Our industry can aid this effort toward positive programs by defining and backing worthwhile projects and doing some honest, forceful lobbying in their behalf. For example, much has been said about the prospective benefits from greater use of electronics in medicine, highway-traffic control and education. In each of these fields, shortages of personnel or facilities, or both, exist. Yet the acceptance of new techniques and equipment in these fields seems to lag well behind the capabilities of electronics.

The government is already investing



VITAL STUDIES CENTER at Texas Institute for Rehabilitation and Research seeks to optimize medical treatment with the aid of computers and electronic analysis equipment

heavily in medical, educational and highway programs. Industry task forces that undertake to investigate how associated problems can be overcome more effectively should be welcomed by a cost-conscious Congress and Administration.

There is nothing radical in this suggestion. Industry-government cooperation led to development of the existing air-traffic control system, established standards for color television and other broadcast services, fostered industrial and medical applications for radioisotopes, and helped pave the way for other electronics markets.

**NOW...**

**THE FAMOUS  
JERROLD  
900-B  
SWEEP SIGNAL  
GENERATOR**



**OFFERS CENTER  
FREQUENCIES FROM  
500 kc to 2,000 mc  
without plug-ins**

The versatile Jerrold Model 900-B Sweep Signal Generator now extends its useful frequency range all the way up to 2,000 mc, with sweep widths ranging from 10 kc to 800 mc. A diode frequency doubler, priced at only \$150, increases the usefulness of the 900-B without the need for plug-ins.

**Frequency Doubler Specifications**

Input Frequency ... 500-1000 mc  
Output Frequency ... 1000-2000 mc  
Conversion loss at  
1 volt RMS ..... less than 12 db  
Output component, other  
than harmonic  
of input ..... 20 db or more below  
Maximum Input ..... 1 volt RMS  
Connectors ..... 50 ohm, BNC

The diode frequency doubler can also be used with the economical Jerrold 900-A Sweep Generator.

Model 900-B ..... \$1,980  
Model 900-A ..... \$1,260  
Frequency Doubler ..... \$ 150

Write for complete technical data.  
Jerrold Electronics Corporation, 15th  
& Lehigh Ave., Philadelphia 32, Pa.

**JERROLD  
ELECTRONICS**

A subsidiary of THE JERROLD CORPORATION

**COMMENT**

**STANDARDS**

Your recent editorial, Standard Standards (p 5, Dec. 20, 1963), elicits from us the following:

1. The calorie should be junked completely. We should use only one unit for energy (the joule)—whether it be electrical, thermal, mechanical or chemical. The electron-volt might be justified on a very restricted basis.

2. The Kelvin temperature scale should be adopted rather than the Celsius. The former must be used in all calculations involving radiant heat transfer, all thermodynamic calculations, and all solid work. The latter finds no field in which it enjoys any particular advantage over the Kelvin scale.

3. The candelas and lamberts and associated units should all be junked. The watt/meter<sup>2</sup> is entirely adequate. There is no need for illumination engineers to set up a language of their own.

4. The r/min and r/hr should be junked. The second should be our only unit for time. The use of a single unit for time will remove confusion and incessant bother with conversion factors.

R. O. WHITAKER

Rowco Engineering Company  
Indianapolis, Indiana

**AIR SURVEILLANCE**

In your excellent piece on surveillance, Army Wants Surveillance, Armament Gear for Air Arm (p 10, Nov. 29, 1963), you noted that "photographs . . . still present difficulties" in aerial reconnaissance data transmission.

You may be interested to know that we have overcome these difficulties and have recently delivered two operational photo reconnaissance systems (Photo-scan) to the Navy at the Naval Air Development Center at Johnsville, Pennsylvania. The equipment features the CBS Laboratories Reconotron III scanner and line-scan tube, and has a resolution in excess of 40 lines per millimeter.

JOSEF C. DINE

CBS Laboratories  
Stamford, Connecticut

**ELECTRONICS MARKETS**

In your totals for industrial electronics in the market report you published (p 37, Jan. 3), the total doesn't equal the sum of its parts in the figures on p 56. For 1967, you estimate the industrial electronics market to be \$6,592 million. When I add up the categories included in industrial electronics, I get \$6,133 million. Did you leave out a category, or is the total wrong?

HAROLD L. RAIZER

New York, New York

The total for industrial electronics in your market report appears as \$6,592 million on p 56, and as \$6.150 billion on p 54, both on the fold-out. Which is correct?

FRANK RIZZO

Tuscaloosa, Alabama

• We erred. The total for industrial electronics for 1967 is wrong and should be \$6,133 million. This would bring our electronics industry total for 1967 to \$21.012 billion.

**GATED PULSES**

Thank you for your excellent presentation of my manuscript, Gates Pulses Yield Selected Frequency Outputs (p 38, Dec. 20, 1963).

For the record, here are three corrections for the article:

On p 40, just before Eq. 1, the denominator of the last expression should be  $1/T(1+T/\Delta T)$ .

Equation 2 on p 40 should be  $T = 4N_{8\phi_m}/V_c$ .

In Fig. 1A, p 38, AND gate 2 should have two inputs.

J. H. FIRESTONE

General Time Corporation  
Stamford, Connecticut



New  
 7½ watt  
 RHEOSTAT

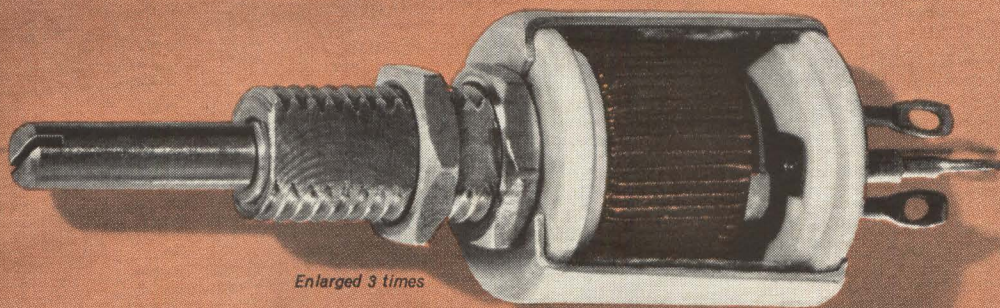

Enlarged 3 times

only .515 DIAM

**OHMITE MODEL C**

**340°C MAX HOTSPOT OPERATION...WIRE-WOUND  
 CERAMIC AND METAL CONSTRUCTION**

It's sheer magic in miniaturization!

Now you can boost power levels in your equipment without increasing size ... improve the reliability ... obtain the advantages of Ohmite power rheostats ... all at a power level previously covered only by low power, low temperature potentiometers.

Model C is the first, truly miniature, *power rheostat* on the scene. And because it employs Ohmite's famous principles of rheostat construction, the Model C will dissipate an amazing 7.5 watts at 40°C ambient (on metal panel). Like its big brothers, the resistance element of the Model C is wound on a ceramic ring, coated with vitreous enamel, and bonded to a ceramic base. Then, in addition, it is completely enclosed and insulated in a corrosion-resistant metal case.

For standard units, tolerance is  $\pm 10\%$ ; rotation,  $300^\circ \pm 5^\circ$ ; resistances, up to 5000 ohms; weight, 0.265 ounce (7.5 grams); terminals, spade type with holes or pin-type for plug-in use or push-on connectors; shafts, slotted with standard or locking bushing.

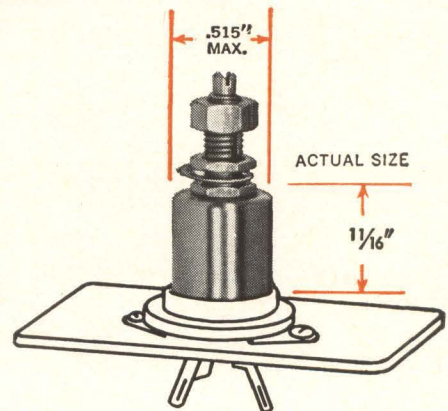

RHEOSTAT WITH PIN-TYPE TERMINALS PLUGS INTO TRANSISTOR SOCKET OR TERMINAL BOARD

WRITE NOW FOR BULLETIN 203



RHEOSTATS • POWER RESISTORS • PRECISION RESISTORS • VARIABLE TRANSFORMERS  
 TANTALUM CAPACITORS • TAP SWITCHES • RELAYS • R.F. CHOKES • SEMICONDUCTOR DIODES



**OHMITE**  
 MANUFACTURING COMPANY  
 3610 Howard Street, Skokie, Illinois 60076  
 Phone: (312) ORchard 5-2600

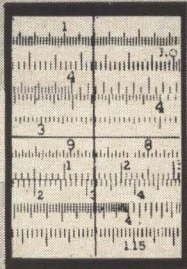

P. R. MALLORY & CO. Inc.  
**MALLORY**

P. R. MALLORY & CO. INC., INDIANAPOLIS 6, INDIANA

## High-efficiency radiation shielding

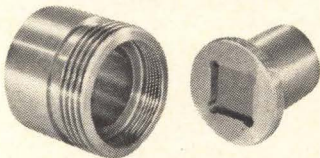

Isotope container made of Mallory 1000.

Mallory makes a line of high density materials which have excellent radiation shielding characteristics. You may find them just what you require in designs for nuclear instruments, compact reactors or isotope containers.

These materials are powder metallurgy products based on tungsten. Mallory 1000 has about 70% the tenth-layer thickness of lead, and is about twice as strong as low carbon steel. Its density is about 17 gm/cc. Even better shielding is possible with Mallory 2000 (density 18.0 gm/cc) and Mallory 2960A (density 18.5 gm/cc). And we have even newer experimental materials with densities of 19 gm/cc, approaching that of pure tungsten. Where both neutron and gamma shielding are needed, we can introduce boron-10 into the base material.

Technical data and consultation are available on request.

CIRCLE 240 ON READER SERVICE CARD

## Snap-in mounting for Printed Circuit Controls

For use in printed circuits, Mallory can supply standard types of carbon volume controls with a special

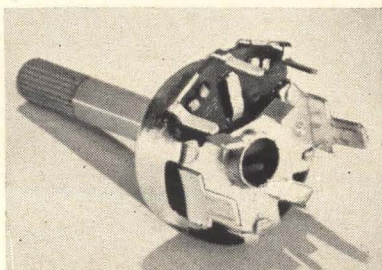

mounting bracket which greatly simplifies production line handling.

The bracket has spring tabs pointing away from the front of the control. You simply press the tabs through the slots in the circuit board. The control locks in place. No need for twisting tabs. The spring tabs hold the control in correct position for soldering. You can tilt the board, turn it over if you wish, without altering positioning of the control.

CIRCLE 241 ON READER SERVICE CARD

## New aluminum electrolytic has high reliability at moderate cost

Next time you need extra capacitor reliability without premium price, take a look at the Mallory Type TPG. It's a new kind of aluminum electrolytic, with exceptional stability and life expectancy. On tests that have run several thousand hours, the TPG shows retention of initial values of capacitance, DC leakage and equivalent series re-



sistance that you may not have thought possible in a compact-sized aluminum tubular unit. We

have run over a million piece-hours of certification testing with *only one* electrical failure. (Test conditions—rated voltage and 85°C.)

The TPG has all-welded construction. The positive lead tab is both mechanically locked and welded, to give double assurance of lead strength. Temperature rating is -40 to +85°C. Values range from 20 mfd., 150 volts to 450 mfd., 3 volts. Size:  $\frac{3}{8}$ " diameter by  $1\frac{1}{16}$ " to  $1\frac{5}{8}$ " long. Evaluate this new capacitor in circuits where you may have been planning to use tantalum. You may be able to make real economies.

CIRCLE 242 ON READER SERVICE CARD

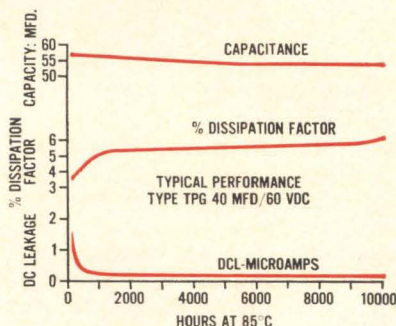

## Need an encapsulated control?

Some of our customers occasionally need a wire-wound control that is sealed against dust and humidity. For these applications, we have developed techniques of encapsulation that give protection against severe environments.

First, we use an epoxy encapsulation that surrounds the entire case of the control. Then, we build in a dual O-ring seal, one on the shaft and another between the control bushing and the mounting panel.

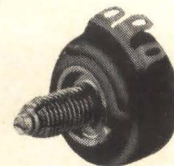

The picture shows how this construction looks on our Type SC 5-watt control.

CIRCLE 243 ON READER SERVICE CARD

# DESIGNER'S FILE

## Using Resonant Reed Relays in sequential code tone signalling

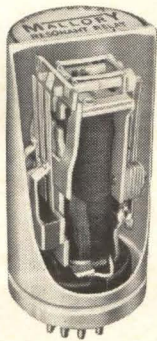

Our original self-holding resonant reed relay has such unusual characteristics as a simple tone-actuated remote switch, that we have engineered some additional functions into a model called the RRB relay.

In the RRB relay, two resonant reeds, which respond only to proper audio tones, are arranged to actuate telephone-type contact stacks. This permits many switching combinations to respond to a single tone signal.

The relay provides for an optional mechanical latching arrangement so that the signal may be removed from the carrier channel after achieving the desired switching. An auxiliary reed—tuned to a different frequency—releases the mechanical latch to restore the circuits to normal.

Additional option is provided in a sequencing mechanism. If the two working reeds are tuned to respond to tones A and B, for example, a circuit may be arranged to close only if tone A is transmitted *before* tone B. Two such relays may be operated selectively to call any 1 of 108 different stations by transmitting 4 proper tones in a required sequence. Each station (see diagram below) would have 2 of the relays with selected tone-sequence responses.

This basic system can be expanded by using additional tones or decoding relays. If 8 tones are used with three decoding relays at each station, any 1 of 134,456 stations may be selected by a proper sequence of a six tone code.

And that's not all. By reversing the sequencing mechanism of the relay, we can provide a unit which will "lock out" the system if a wrong sequence is transmitted. This permits the use of these relays in electrical lock circuits of extremely high security. The security code can be changed in seconds by simply plugging in different relays. You may find interesting possibilities in this concept for garage door openers, telemetering controls, selective calling systems, and security systems.

**CIRCLE 244 ON READER SERVICE CARD**

## When you need a lot of microfarads...

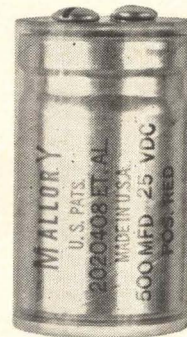

Occasionally, when you're working out a prototype, you may run into a circuit that needs microfarads by the thousands. How do you get what you need, in compact size, at compact price?

The answer is a Mallory Computer Grade (Type CG) capacitor. They were originally developed for use in computer power supplies, but you don't need to be designing computers to use them. They're made of materials—foil, separator, electrolyte—that meet highest specifications for purity. And they are assembled with extra care, in a construction which gives unusual reliability.

Their life is exceptional. We have tested them for the equivalent of 20 years service at room temperature without failure. Equivalent series resistance and DC leakage are remarkably low and stable.

In a single case (largest size 3" dia. x 5 5/8") you can get up to 115,000 mfd. at 3 volts, or 2000 mfd. at 350 volts . . . at a cost considerably less than that of conventional electrolytics paralleled together.

**CIRCLE 245 ON READER SERVICE CARD**

REMOTE SWITCHING BY SEQUENTIAL CODED TONE SIGNALS

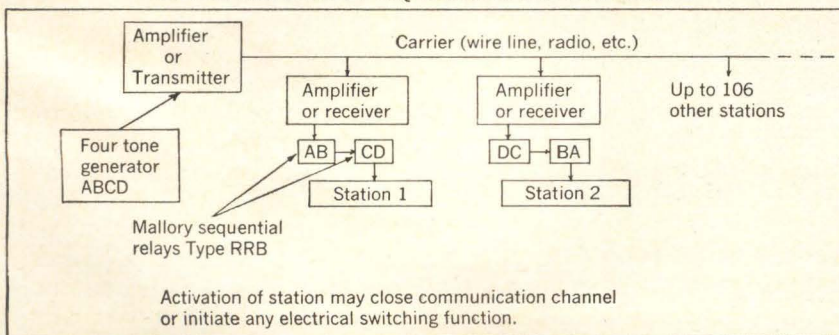

# Stage Set for U.S.-Soviet

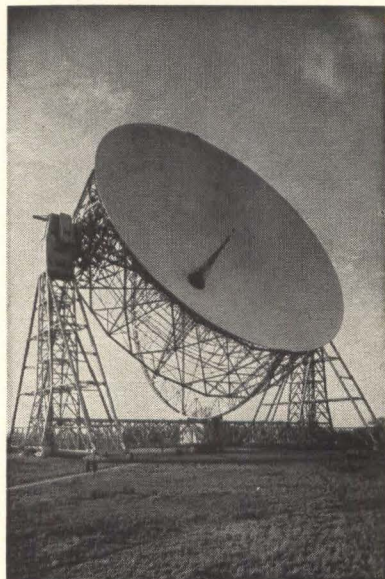

JODRELL BANK station will link U. S. with USSR via satellite to Zimenki Observatory at Gorki State University **A**

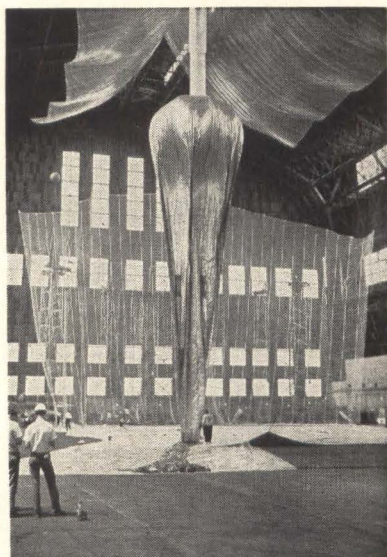

INFLATION TEST of Echo II. Balloon is 135 feet in diameter **B**



ECHO II passive communications satellite balloon is packed at G. T. Schjeldahl, Co., builder **C**

U.S., Russians and English ready tests, stations for Echo II satellite

By **JOEL A. STRASSER**  
Assistant Editor

**LAUNCH** of Echo II, scheduled for January 23 aboard a Thor-Agena B from the Pacific Missile Range will, if successful, set the stage for Soviet participation in U. S. space activities.

Under terms of the recent U. S.-USSR cooperative agreement concerning Echo II, experiments will be conducted between the Jodrell Bank station in Cheshire, England and Russia's Zimenki Observatory at the Gorki State University. Signals will be carried from the U. S. to England using conventional facilities, and then bounced to the satellite from Jodrell Bank for relay to Russia.

Soviet experiments with the passive communications satellite balloon are expected to be limited to receiving signals only, Sir Bernard Lovell, director of England's Jodrell Bank Experimental Station told **ELECTRONICS**.

Leonard Jaffe, NASA's director of communications systems, however, told **ELECTRONICS** that he feels the Russians will want to transmit back to Jodrell Bank at 162 Mc, and would be agreeable to expanding the tests to include experiments in the microwave frequencies.

If the Russians are agreeable to this expansion, the U. S. would rely on the 10-Kw transmitter at Goonhilly Downs to send signals to Russia at 1,725 Mc, Donald P. Rogers, Echo II project director at NASA headquarters, told **ELECTRONICS**. Rogers indicated that it would be technically feasible for the Russians to respond at 4,170 or 4,080 Mc. Jodrell Bank would not be used for microwave tests since the station loses efficiency above 500 Mc.

**U. S.-Soviet Test Details**—Present plans call for Jodrell Bank to transmit at 162.4 Mc. using their Mark

I 250-ft-aperture radio telescope. The power gain of the British telescope at that frequency is 40 db, according to Lovell, who plans to use a 1-kw c-w transmitter with circular polarization.

Gorki station in the USSR will receive the signals from Jodrell Bank using a radiotelescope that measures 45 ft in diameter with a gain of about 25 db at 162.4 Mc.

Distance between Gorki and Jodrell Bank is 1,850 miles and assuming Echo II to be at an altitude of 700 miles, the distance of each station to the satellite is 1,200 miles. Using these figures as a basis for calculations, Lovell has listed the following signal-to-noise ratios expected at the Gorki station from the Jodrell Bank transmissions:

- Unmodulated carrier, 17.7 db
- A-m to a depth of 50 percent by a 400-cps tone, 11.7 db
- A-m by speech, 2.3 db
- Time expanded speech, at 2:1 ratio, 5.3 db; at 4:1 ratio, 8.3 db; at 8:1 ratio, 11.3 db; at 16:1 ratio, 14.3 db
- Telegraphy, 20.7 db
- Facsimile (peak signal/mean noise), 17.7 db

**Gorki Station**—Zimenki Radio-Astronomical Observatory, sponsored by the Gorki Physiological Research Institute, is located at 57 deg, 22 min north, 45 deg, 3 min east—about 200 miles northeast of Moscow. The observatory has been used principally for measurements of solar radiation and the intensity of radio emission of the sun and some discrete sources. One reference lists the station as having a 20-ft dish and two 50-ft dishes, one of the latter probably slated for the Echo tests. Station frequencies are 75, 200, 3,000 and 9,400 Mc.

In 1947, a modulated radiotelescope was built at Gorki to measure solar radiation at 75 Mc. Microwave equipment for operation at 3,000 Mc was also constructed that year but not used immediately. The following year a 200-Mc radiotelescope was built, where modulation was achieved by rocking the scan pattern of the antenna to diminish

# Space Tests

the effects of galactic background radio emission and undirected noises. It started operating in 1949, according to a GE source.

With the 3,000-Mc radiotelescope built in 1950, data was collected on the relationship between the intensity of radio emission and sun spots. Modulation was achieved by rotating an offset dipole of the receiving antenna. In 1952, a new 3,000-Mc telescope was built that permitted use of the null method of measurement, as well as rapid thermal calibrations. By 1950, Zimenki was observing radio emissions of the sun at 9,400 Mc with apparatus similar to a Dicke radiometer.

**Antennas**—Information from various sources indicates that Zimenki has used numerous antennas for different purposes. Apart from the antenna configurations listed above, Philco advises that the station has three dishes. A 13.1-ft steerable parabolic antenna at the station reportedly operates at 9,400 Mc, 328 Mc and in the millimeter wavelengths. The company also reports 50- and 19.7-ft steerable parabolic dishes. The International Union Committee on Frequency Allocations and Space Sciences, in a report of frequencies assigned by the Geneva regulations of 1959, mentions a 16.4-ft dish operating at 2,690 to 2,700 Mc and an antenna array measuring 49.2 by 33 feet that operates from 150 to 153 Mc.

## Twin-Tube Laser



GAS LASER by Perkin-Elmer produces 100 mw c-w

## [ SPECIAL VIDICONS ]



### Which special vidicon capabilities do you need?

1. Spectral response: near infrared; S-18; near ultraviolet or x-ray.
2. Fiber optics or standard faceplates.
3. Scanned area either  $\frac{1}{2}'' \times \frac{3}{8}''$  or  $1'' \times 1''$ .

The Machlett vidicon line listed below, which offers these capabilities, reflects unusual competence in developing new and difficult to-produce vidicons for custom, military, or sponsored research applications.

### Machlett Special-Purpose Vidicons

ML-7351/ 1" High sensitivity at low light levels

ML-7351A

ML-2128G 1" High contrast; fiber-optics input

ML-S522B 1" Fast, near UV spectral response

ML-2128U 1" Near UV; fiber-optics input

ML-2058G 2" High resolution; 1.4" diagonal image

ML-589 1" X-ray sensitive; high contrast image

ML-2135G 2" X-ray sensitive; 1.4" diagonal image

For technical information write for our new brochure: Machlett Special-Purpose Vidicons. The Machlett Laboratories, Inc., Springdale, Conn. An affiliate of Raytheon Company.

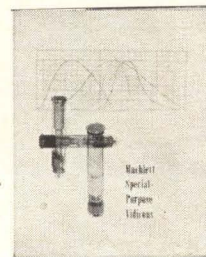

**MACHLETT**

ELECTRON TUBE SPECIALIST

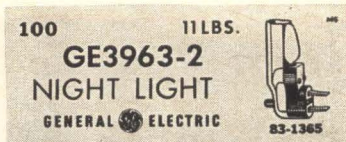

Instantly recognize shelf stock from package labels which tell all product facts — and picture the product as well. Using blank roll stock, economically print complete label in exact quantities. Change part or all of imprint in seconds.



Save costs of expensive decals, change data codes or other data in seconds. Direct printing with Markem cylindrical object printer, specialty inks and quick-change type saves label or decal purchase and application costs, permits quick changes in part or all of imprint.

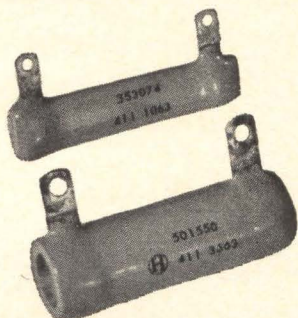

Production print irregular, concave surfaces at high speed, reduce labor costs of hand stamping or using manually-operated machine. Markem 200A offset Unitized. Printing Head prints up to 1800 pieces/hour, gives uniformly high quality prints, handles a range of sizes.

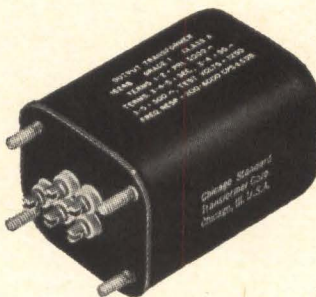

Direct-print complete identification on one or more surfaces, including all values, ratings, connection data, name and trademark — with greater speed, durability and economy than possible with hand stamping. Labeling, nameplates, etc. Direct prints can't fall off, stay clean and readable for product's life.

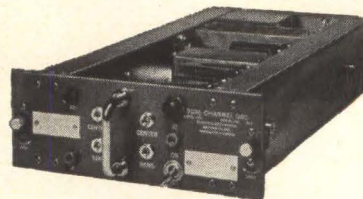

Prevent "outside source" delays, special production scheduling by using flexible, high-production in-plant Markem identification. Meet military specifications for durability and readability, print fixed and variable data simultaneously.

## The best product identification usually costs the least

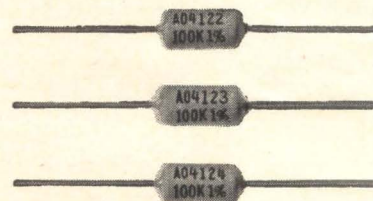

Sequentially number components and save \$50 per 1000 units. Printing the number, trademark, type number, value and date code by special Markem offset process saves label purchase, inventory, obsolescence and application costs. Change imprint, reset numbering unit in seconds. No wiping between imprints, no voiding numbers if component isn't printed.

Using proven Markem production identification techniques on your products and packages — as typified in the actual examples shown — reduces labor costs . . . prevents costly mistakes in sorting, shipping and use of the product . . . encourages reordering exact replacements made by you . . . helps establish future purchases by repeatedly registering your name with the customer.

And Markem machines, type and inks assure clean, durable and complete prints on the *surfaces, shapes* and

*materials you must mark.* Whether your identification involves MIL-spec inks, micro-miniature imprints, consecutive numbering, pilot or production runs, in-line or separate operation — Markem can tailor the right equipment and method to meet your needs and save you money. Ask your Markem Technical Representative to supply detailed recommendations — or write Electrical Industries Division, Markem Machine Co., Dept. 5, Keene, New Hampshire.

Free 12-page Catalog shows numerous electrical/electronic applications of Markem equipment. Write for your copy.

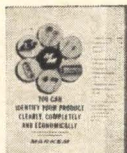

WINNER OF THE PRESIDENT'S **E** FOR-EXPORT AWARD

# MARKEM

TECHNICAL ASSISTANCE AND INDUSTRY-PROVEN EQUIPMENT  
WORLDWIDE . . . TO HELP YOUR PRODUCT SPEAK FOR ITSELF

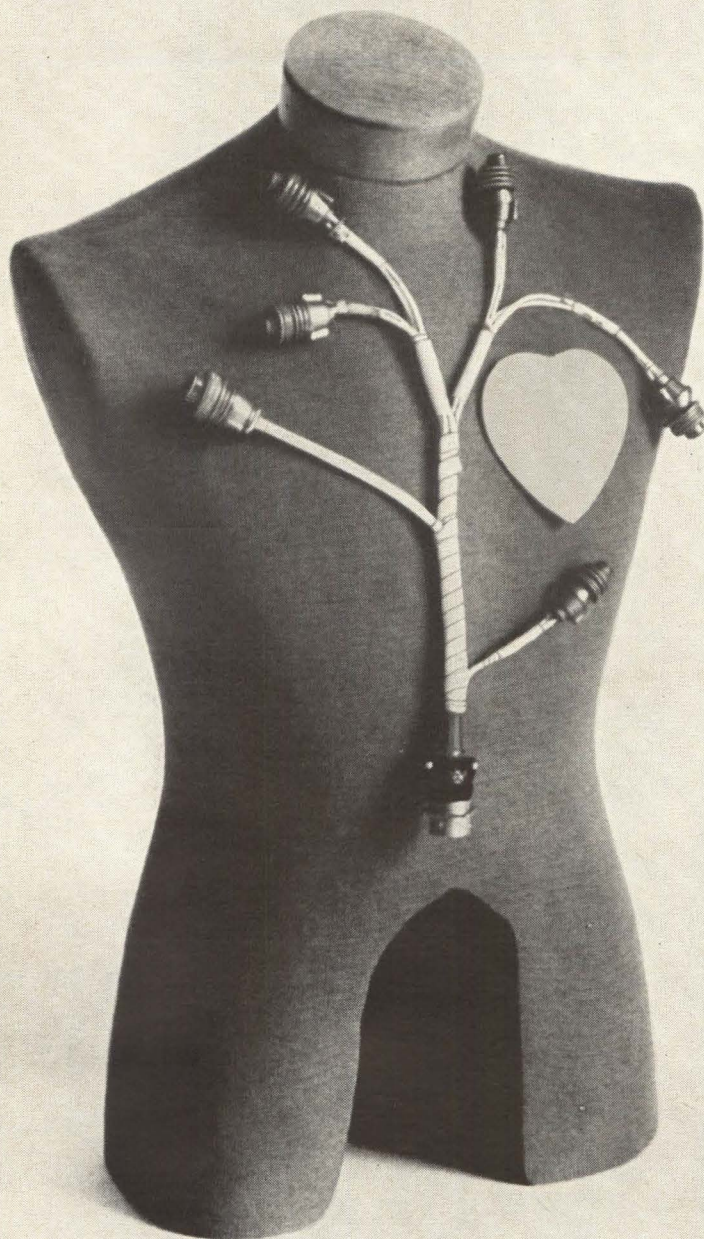

### Tailor-made nerve systems for sale

Your cable assembly may have to fit a 3-inch junction box, or stretch out 2,000 feet on a launch pad.

Maybe you're faced with linking 40,000 volts for 88,000 hours inside a radar system. Or how to keep a cable assembly intact despite high altitudes and contact with fuels and oils. We've already solved these problems at Amphenol. And more.

Like the complex interstage harness assemblies that are the backbone of Minuteman. Like shear-off disconnect assemblies on interceptor missiles. And cost-saving plug-in assemblies for communications systems.

Almost all of today's cable assemblies are tailor-made, specially engineered, individually tested. What makes one different from another?

Your Amphenol Sales Engineer can show you with a 10-minute photo presentation that may be extremely useful if you have a cable assembly or other wired product requirement. Call your Amphenol Sales Engineer. Or, if you prefer, write directly to: Dick Hall, Vice President, Marketing, Amphenol, 1830 South 54th Avenue, Chicago 50, Illinois.



A DIVISION OF AMPHENOL-BORG ELECTRONICS CORPORATION

# AMPERITE

## Thermostatic DELAY RELAYS



PROBLEM? Send for Bulletin No. TR-81

Delays:  
2 to 180 seconds

Actuated by a heater, they operate on A.C., D.C., or Pulsating Current . . . Being hermetically sealed, they are not affected by altitude, moisture, or climate changes . . . SPST only—normally open or normally closed . . . Compensated for ambient temperature changes from  $-55^{\circ}$  to  $+80^{\circ}$  C . . . Heaters consume approximately 2 W. and may be operated continuously . . . The units are rugged, explosion-proof, long-lived, and—inexpensive!

TYPES: Standard Radio Octal, and 9-Pin Miniature.  
List Price, \$4.00

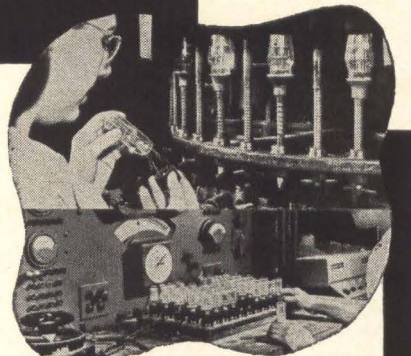

Individual inspection and double-checking assures top quality of Amperite products.

## AMPERITE BALLAST REGULATORS

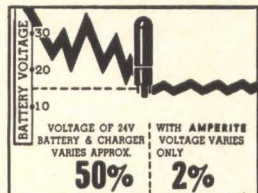

Hermetically sealed, they are not affected by changes in altitude, ambient temperature ( $-50^{\circ}$  to  $+70^{\circ}$  C.), or humidity . . . Rugged, light, compact, most inexpensive.

List Price, \$3.00

Write for 4-page Technical Bulletin No. AB-51

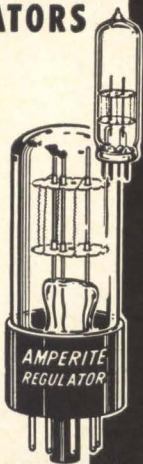

# AMPERITE

600 PALISADE AVE., UNION CITY, N.J.

Telephone: 201 UNION 4-9503

In Canada: Atlas Radio Corp., Ltd.,  
50 Wingold Ave., Toronto 10

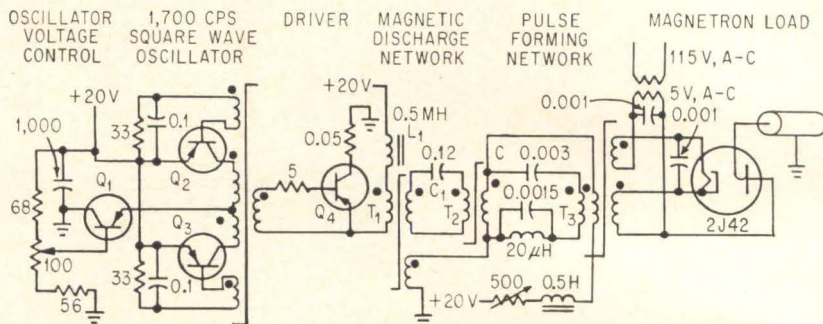
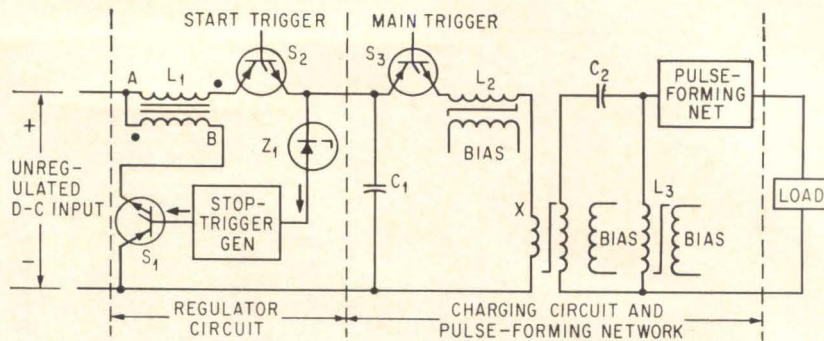

SEMICONDUCTOR-MAGNETIC pulse generator's basic circuit. Low-voltage capacitor is discharged to charge high-voltage capacitor, which is discharged through load (top). This circuit is a refined version of earlier circuit (bottom), detailed in *electronics*, p 42, July 3, 1959.

## SCR's To Pulse Radar

Solid-state circuit uses saturable inductors; radar, laser, sonar uses explored

By **THOMAS MAGUIRE**  
Regional Editor, Boston

**CAMBRIDGE, MASS.**—Research advances in solid-state generation of high-power pulses was reported this week to more than 100 industry and government specialists.

Circuit characteristics and application possibilities of the semiconductor-magnetic pulse generator were explored at a one-day seminar sponsored by the MIT Electronic Systems Laboratory and the Air Force Research and Technology Division at Wright-Patterson AF Base.

The semiconductor-magnetic pulse generator uses silicon controlled rectifiers (scr) and saturable magnetic cores rather than hydrogen thyratrons or other switching tubes.

Forerunner of the new technique was the pulse generator which used a power transistor and saturable inductors (*ELECTRONICS*, p 42, July

3, 1959). An scr was later substituted for the power transistor. This controlled-rectifier-and-saturable-inductor circuit was gradually refined and an input-voltage regulator circuit added to evolve the present-day technique.

**Unregulated Supply**—No high-voltage power supply is needed, nor a regulated voltage. A low-voltage capacitor is charged first to a regulated voltage—regulated at the capacitor on a pulse-to-pulse basis, not from a regulated supply. To minimize time jitter between trigger pulse and output, the voltage level on this capacitor from pulse to pulse is kept constant. The low-voltage capacitor is discharged with an scr through a saturable step-up transformer to charge a high-voltage capacitor, which is then discharged through the load.

**Application Range**—The MIT lab has been working on the new pulse-generation technique for several years under Air Force sponsorship. The MIT effort has been geared to radar pulse-modulator uses, but potential uses are also seen in excitation of laser pulses, sonar work, and



generation of high fields for accelerators. In radar modulation, Lawrence R. Swain, Jr., of MIT, pointed out, the technique offers the expected solid-state advantages for airborne and spaceborne radar systems: high efficiency, light weight and small size, high reliability. In work at the MIT Electronic Systems Laboratory, immediate goal is a radar modulator which would produce 1,330 pps at 1 Mw peak power, 2 kw average, and weigh about 25 pounds.

**Energy Flow**—The basic circuit of the semiconductor-magnetic pulse generator is illustrated. It generates output pulses in three steps:

- Energy is drawn from an unregulated power supply to charge low-voltage capacitor  $C_1$ . The regulator circuit halts the charging of  $C_1$  when a desired voltage is reached and returns to the power supply any energy then stored in inductor  $L_1$ .

- Energy is next transferred from  $C_1$  through a step-up saturable transformer to a high-voltage capacitor  $C_2$ , a process which takes several times as long as the desired output-pulse duration.

- Energy is then discharged from  $C_2$  through a linear pulse-forming network to the load.

If the prime power supply is a single-phase or polyphase a-c source, an unregulated rectifier filter circuit utilizing semiconductor diodes can provide the d-c input power. If the prime source is a battery, the regulator circuit provides an effective means of compensating the decrease of battery voltage during discharge.

**What's Needed**—The radar research group working at MIT under Swain has been concerned principally with the 2N680 series of scr's. Primary requisite is rapid turn-on, from a high-impedance state to fully conducting in a few microseconds. Capacitors in this circuit have to be capable of discharging rapidly without overheating and must have low self-inductance. For magnetic cores, the MIT group has been using tape-wound toroids.

According to Swain, the work thus far, in addition to developing a promising pulse technique, points up the need to learn more about existing scr's.

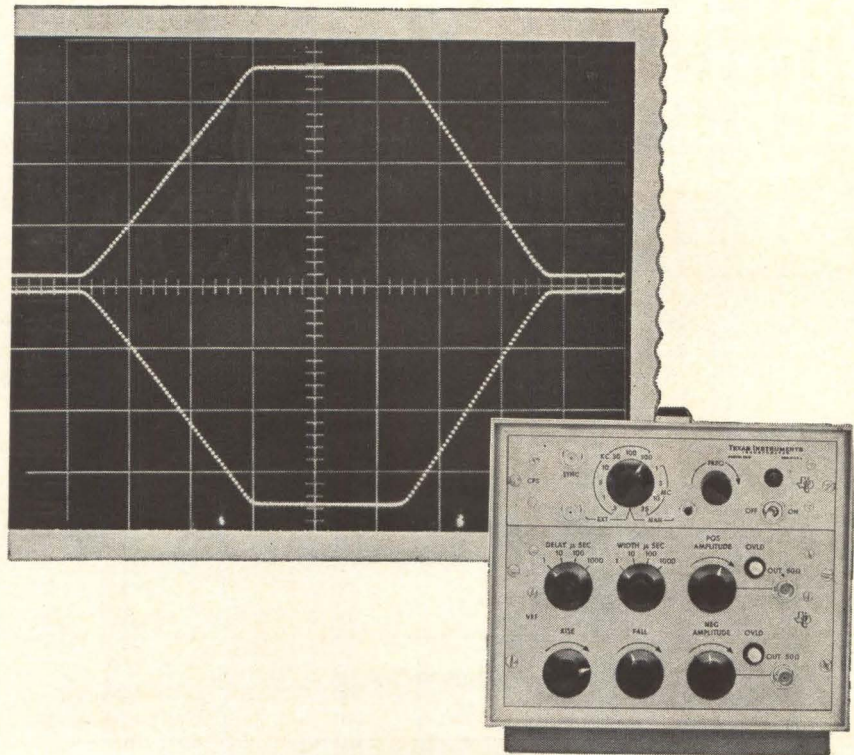

## cleaner waveforms than you can draw yourself\* with TI Pulse Generators

All TI 6000 Series Pulse Generators produce stable, clean waveforms. The Model 6605 is a variable rise and fall time unit which provides coincident positive and negative 10-volt pulses into 50 ohms with unlimited duty cycle. Both pulses can be simultaneously controlled for pulse width, rise time, fall time, and delayed with respect to the input signal. The output amplitudes are independently variable. Outputs are short-proof, with overload indicators and reset buttons. Specifications,

briefly . . . rise and fall times variable from less than 10 nanoseconds to more than 5 microseconds; width coincidentally variable from 40 nanoseconds to 1 millisecond; delay—with respect to clock—coincidentally variable from 90 nanoseconds to 1 millisecond; repetition rates to 25 megacycles. Like all Series 6000 Pulse Generators, the Model 6605 is compact, lightweight and portable, extremely convenient to use. Circuitry is all solid state.

\*We didn't draw them—actual photograph.

Write for complete information.

INDUSTRIAL  
PRODUCTS  
GROUP



**TEXAS INSTRUMENTS**  
INCORPORATED  
P. O. BOX 66027 HOUSTON, TEXAS 77006

634

# How Barden gained a 50% increase in cleaning capacity for precision bearings!



**PROBLEM:** Precision cleaning of assembled ball bearings for instruments used to be a time-consuming operation for the Barden Corporation, Danbury, Connecticut. Bearings up to 1" diameter went through a spray-cleaning machine at a relatively low production rate. Larger bearings were individually spray-cleaned.

**SOLUTION:** A new cleaning system based on an ultrasonic bath of FREON fluorocarbon solvent coupled with spray cleaning. FREON is a *selective* solvent in that it effectively removes dirt, yet has no effect on critical steel, bronze, plastic and fiber components of these bearings. Ultrasonic action combined with the extremely low surface tension of FREON digs contaminants out of the tiniest crevices. Result: Barden now cleans completely assembled bearings in *batches of hundreds*. Over-all cleaning capacity is up 50%!

And Barden reports that FREON solvents give them *better cleaning quality*. Particle count is 15% lower than before, which is a significant drop because the count was very low to start with.

Barden also points out that FREON dries quickly and leaves no residue, and that its very low toxicity and nonflammability let them operate without expensive ventilating equipment. They've found the new system economical to use, because FREON can be recovered in simple equipment—for reuse over and over again.

We'll be glad to show you how FREON solvents can improve your own cleaning operation. First, *send the coupon or Reader Service Card* for our new booklet on cleaning!

**FREON<sup>®</sup>**

solvents



BETTER THINGS FOR BETTER LIVING... THROUGH CHEMISTRY

## MAIL COUPON FOR NEW BOOKLET ON CLEANING

E. I. du Pont de Nemours & Co. (Inc.)  
FREON Products Division  
N-2420-E-1R, Wilmington 98, Delaware

Name \_\_\_\_\_ Title \_\_\_\_\_

Company \_\_\_\_\_

Address \_\_\_\_\_

Please send new booklet on FREON solvents for precision cleaning.

I am interested in cleaning \_\_\_\_\_

I would like to talk to a cleaning specialist.

# Deep-Space Laser Tracker Sought

HOUSTON—NASA's Manned Spacecraft Center has asked industry for proposals on a deep-space laser acquisition and tracking study. The center is seeking a system that would have a mean range of 50 million nautical miles.

Twenty-two companies have been invited to bid on a \$75,000 R&D contract for such a system, with the bids due at MSC by Jan. 22. MSC says it wants a system capable of handling two-way telemetry and voice communications, as well as spacecraft to ground tv. Four communications links are to be considered:

- 1) From an earth station to Manned Deep Space Vehicle (MDSV) via laser beam
- 2) From earth to satellite by radio frequency and relay to MDSV via laser beam
- 3) From earth to a lunar station via r-f and relay to MDSV by laser

4) Communications between two or more space vehicles for distances up to 300 nautical miles on deep-space missions.

MSC says its proposal calls for studies using r-f as well as laser because of laser handicaps within the earth's atmosphere.

## Eurocontrol Orders Air-Traffic Simulator

EUROCONTROL, the European Air Traffic Control organization, has ordered an air-traffic control simulator with a capacity of 300 aircraft simulations from a consortium of CSF of France, Decca Radar Ltd. of Britain and Telefunken AG of Germany. The simulator will show the air-traffic situation in an area the size of Western Europe with six

simulated primary radars and six secondary radars providing surveillance coverage. The system will be installed at the Eurocontrol Experimental Center at Bretigny, France.

## Warning Device Wanted For Clear-Air Turbulence

WASHINGTON—A feasible device that will give pilots advance warning of clear air turbulence is still a long way off, but at least three developmental efforts are being carried on that offer some hope. Eastern Air Lines is experimenting with an instrument designed to measure small temperature changes as the aircraft cruises. It is connected to the aircraft computer system and may possibly provide two or three minutes warning. Temperature change is frequently associated with clear air turbulence. Although it is still too early to predict the success of this device, Eastern has modified all of its DC-8 jets to accept it and testing is proceeding rapidly.

Collins Radio Co. is experimenting with a microwave radiometer which may be able to sense the temperature a few miles ahead of the aircraft. And Stanford Research Institute is attempting to correlate atmospheric electrical charges with clear air turbulence.

## Data Scanners Automate Engine Room

NEW ORLEANS — Avondale Ship Yards this month starts building the nation's first ship with speed and direction controlled by the bridge directly. Gone will be the bell system linking the bridge with the engineer below decks. The ship, the *S.S. Louis Lykes*, will have data scanning equipment which monitors 100 points in the engine room simultaneously, initiating corrective

## For Stereo, Matched Musical Spheres



DUMBELL-SHAPED, all-transistor stereo set introduced last week in Chicago by Clairtone Sound, Toronto uses motional velocity feedback (electronics, p 54, May 3, 1962) developed by proportional movements of the sound globes, to cancel distorting frequencies. Globes containing loud speakers in special configuration are adjustable to surroundings. Price: \$1,600. Oscar Peterson, the pianist, gets a demonstration

action when dangerous increases in pressure or temperature occur. Westinghouse and Lykes Bros. Steamship Co. designed the automated engine rooms. Westinghouse was given a \$6-million contract for work on the *S.S. Lykes* and seven other ships which will be built in the same mold.

## Incremental Recorder Applied to Retail Sales

NEW YORK — Universal Controls said last week it will use the incremental recorder made by Precision Instrument Co., Palo Alto, Calif., in its Uni-Tote point-of-sale recording system. Uni-Tote, built by Universal's American Totalizer division, is designed to keep track of retail store transactions.

The RSL-150 tape drive, which

moves magnetic tape exactly 0.005 inch per increment, packs information at 200 characters per inch. The seven-channel, 60-pound transistor recorder was originally developed for accumulators of asynchronous data.

### Automatic Ticket Taker

LONDON—First tests of an electronic barrier control system at a North London subway station started this month. Passengers entering the platforms pass through the barrier after inserting their tickets into a scanning head. If the fare and date information is correct, the ticket is returned to the passenger and the barrier gate opens. Incorrect information inhibits the gate, and illuminates a stop light to alert the station officials.

## 10-Mc Integrated Circuits Use Single Power Supply

SUNNYVALE, CALIF. — A series of 10-Mc diode-transistor-logic monolithic integrated circuits has been introduced by Siliconix. Seven circuits are designed around a basic NAND gate and all use epitaxial-collector transistors to minimize isolation capacitance and to control saturation resistance. Major design feature is operation from a single power supply without compromising circuit gain, speed and power. The Siliconix DTL gate relaxes gain restrictions by addition of an emitter follower.

Circuits are available in either modified TO-5 or a solid glass-alumina flatpack. Siliconix has set one price for quantities from 1 to 999 to encourage trial use without small-quantity price penalty.

## MEETINGS AHEAD

SYMPOSIUM ON CHARGE TRANSFER COMPLEXES, USAF Scientific Research Labs; Denver, Colo., Jan. 19-24.

ANTENNA RESEARCH APPLICATIONS FORUM, Midwest Electronics Research Center; University of Illinois, Urbana, Ill., Jan. 27-30.

MANAGEMENT CONFERENCE, ERA; New Orleans, La., Jan. 28-31.

ANNUAL MEETING-SEMINAR, Precision Potentiometer Manufacturers' Association, Hollywood Beach Hotel, Hollywood, Fla., Jan. 29-31.

INSTRUMENTATION SYMPOSIUM, ISA North Central Area; New Sheraton-Ritz Hotel, Minneapolis, Minn., Jan. 30-31.

MILITARY ELECTRONICS WINTER CONVENTION, IEEE-PTGMIL; Ambassador Hotel, Los Angeles, Calif., Feb. 5-7.

ELECTRONIC COMPONENTS INTERNATIONAL EXHIBITION, FNIE, SDSA; Paris Exhibition Park, Paris, France, Feb. 7-12.

INFORMATION STORAGE-RETRIEVAL INSTITUTE, American University; University, Washington, D. C., Feb. 17-21.

PHYSICAL METALLURGY OF SUPERCONDUCTORS MEETING, AIMPE Metallurgical Society; Hotel Astor, New York, N. Y., Feb. 18.

INTERNATIONAL SOLID STATE CIRCUITS CONFERENCE, IEEE, University of Pennsylvania; Sheraton Hotel and University of Pennsylvania, Philadelphia, Pa., Feb. 19-21.

NUMERICAL CONTROL PRESIDENTS' CONFERENCE, Numerical Control Society; Hotel Plaza, New York, N. Y., Feb. 20-21.

SOCIETY FOR INFORMATION DISPLAY NATIONAL SYMPOSIUM, SID; El Cortez Hotel, San Diego, Calif., Feb. 26-27.

WELDED ELECTRONIC PACKAGING SYMPOSIUM, WEPA; Miramar Hotel, Santa Monica, Calif., Feb. 26-27.

SCINTILLATION-SEMICONDUCTOR COUNTER SYMPOSIUM, IEEE, AEC, NBS; Hotel Shoreham, Washington, D. C., Feb. 26-28.

### ADVANCE REPORT

PRECISION ELECTROMAGNETIC MEASUREMENTS CONFERENCE, NBS, IEEE, URSI; NBS Boulder Laboratories, Boulder, Colo., June 23-25; March 15 is deadline for submitting summaries and 200-word abstracts to Charles F. Hempstead, Bell Telephone Laboratories Inc., Murray Hill, N. J. Topics include atomic frequency and time, conductivity determination and electric-magnetic susceptibilities, quantum electronics in precision radio and optical measurements, electromagnetic measurements for space navigation-exploration, statistical methods-automation and data reduction in precision measurements, radio frequency, microwave, millimeter measurements.

## Solid-State Detector

### May Track Stars by IR

CAMBRIDGE, MASS.—A light detector under development at MIT combines a gallium-arsenide photovoltaic cell with a field-effect transistor. It was designed by Sanford Cohen, of MIT's Experimental Astronomy Lab, for projected NASA requirements of interplanetary navigation. The device is packaged in a cube of about a half-inch.

The output voltage of the Ga-As *p-n* photocell is used to modulate current flow in the reverse-biased field-effect transistor. Experiments indicate the solid-state light detector is less noisy than a phototube but a little less sensitive. Cohen says studies should yield a solid-state detector equal in performance to the multiplier phototube. It should be simpler, more rugged, and less costly, he says. The detector is theoretically capable of sensing stars of the magnitude needed in extra-terrestrial navigation. Its peak sensitivity is in infrared—at 8,600 Å, which suggests another use, tracking of stars during daytime as an aid to navigation on earth.

## IN BRIEF

### Triode Gas Laser Invented

BELL TELEPHONE LABS last week reported it has invented a gas laser that can be switched and amplitude-modulated, like a triode, by varying the voltage on the grid. Excited by a beam of electrons of nearly identical energies emitted from a hot cathode, the laser oscillates without the usual glow discharge of a gas laser, said P. K. Tien, Donald McNair and H. L. Hodges, in the *Physical Review Letters*.

Cathode, grid and anode are in the form of parallel ribbons, extending about 8 inches along the laser's horizontal axis. Electrons from the cathode are controlled by the grid to have an energy spread of a fraction of a volt, instead of the tens of volts in conventional lasers. This is said to provide a hundredfold increase in excitation efficiency per electron

### Larger Ferrite Crystals Grown With Plasmas

LONDON — Joint research by Imperial College, London, and the British Oxygen Co. into methods of using plasmas for forming ferrite compounds is yielding single crystals with sizes up to 5 cm long and 1 cm in diameter. In the experimental method, powdered oxide is fed by a stream of gas into the plasma zone which is ionized initially by a 9-kw, 5-Mc r-f generator. Growth rates at present vary between 0.1 cm and 2 cm per hour, with growth periods as long as 5 hours.

### Body Scanner Helps Diagnose Tumors

LONDON — A body scanner developed by Isotope Instruments Ltd., a subsidiary of Elliott-Automation Ltd., will ease the diagnosis of tumor locations. Results are presented as a colored chart, providing for easier interpretation. The patient undergoing examination lies on a motor-driven couch with a scintillation counter positioned over the area of the body to be scanned. The couch is first driven longitudinally at constant speed providing one line of scan. Reversing the couch after

a transverse shift produces the next scanning line. A remotely-controlled multi-color printer produces a colored activity distribution pattern of the body. Pattern of the colored dots is proportional to the count rate, areas of high activity being represented by dense concentrations together with a color change so as to improve contrast.

### MIT Making Blueprint For Library of Future

CAMBRIDGE, MASS. — Interdisciplinary group at MIT will take a basic look at the technical information problem and try to start building techniques for the libraries of the 1970's. Designated Project Minerva, the effort will be headed by Carl F. J. Overhage, who will resign as director of Lincoln Laboratory and return to the main MIT campus. Nucleus of Project Minerva will also include Prof. William N. Locke, Director of MIT Libraries, and Myer M. Kessler, who has been building a pilot model of a technical information system, based on a computer-stored index of several journals. Succeeding Overhage as director of Lincoln Laboratory will be Associate Director William H. Radford. Benjamin Lax, now Head of the Solid State Division, will move up to associate director

**BURROUGHS** this week introduced a general-purpose computer aimed at the half-billion-dollar commercial accounting market, and selling for under \$20,000. The five models of the N2100 can read and write alphanumeric data from magnetic-striped ledger cards, and a choice of punchcards or punched-paper-tape output.

**INTERCONTINENTAL** Electronics Corp. has been merged into American Radio Co. Tracor Inc. has acquired Accurate Instrument Co. Interphase Corp. says it has acquired the right to purchase substantially all of the common stock of Kane Engineering Labs.

**NEW YORK** has allotted \$8 million to plan the first stage of a \$100-million electronic traffic control system (p 14, Dec. 28, 1962), covering main intersections on about 250 miles of streets.

**AEC WILL BUILD** a \$3.5-million, multi-story computer facility for the Lawrence Radiation Lab at Livermore, Calif. Facility will house a CDC 6600.

**AMPEX** has delivered a \$1-million radar recorder system to Bell Telephone Labs, White Sands, N.M., for Nike anti-missile missile system research. The recorder reproduces time-base stabilized and transient-free radar data.

**NATIONAL BUREAU** of Standards is set to begin its long-discussed efforts to centralize computer services for the federal government in the Washington D.C. area (p 12, May 17, 1963). It will operate a computer service center, selling time on its own digital computers.

**AUTOGYRO** drone aircraft has successfully completed its first series of flight tests at the Pacific Missile Range. Flight direction and altitude of the Northrop-built craft are determined by radio-controlled changes in the rotor blade angle.

**FAIRCHILD** Semiconductor has introduced a family of Micrologic elements that dissipate less than 3 mw per node with a propagation delay of about 40 nanoseconds.

**LINK** Division of General Precision has won a \$19.5-million contract from the Navy for 10 weapon-system trainers for the F4C aircraft.

**SWEDEN** is buying \$13.5 million in fm vehicular communications systems from Magnavox.

## **New Procurement Rules to Define Price Competition**

**For the first time**, the Armed Services Procurement Regulations will soon have a section defining "adequate price competition" and "established catalog or market prices." The Defense Department is calling for industry comment on a set of proposed definitions. By law, firms with Pentagon contracts over \$100,000 must give justifying cost data unless there is "adequate price competition," or catalog or market prices are established through substantial sales to the general public. The definitions would apply to dealings between prime and subcontractors as well as to those between the Pentagon and its primes. The proposals aim to satisfy contractor and procurement officer demand for more pinpointing of the terms.

## **FCC Says ComSat Buyers Must Favor Small Businesses**

**Communications Satellite Corp.** will have to get the approval of the Federal Communications Commission for all purchases of more than \$25,000. The corporation strenuously opposed FCC's attempt to require approval for all purchases over \$2,500, so FCC increased the cutoff figure. All purchases of \$25,000 or more by the corporation, prime and subcontractors must be by competitive bid wherever possible, and by negotiation only under limited circumstances. Where feasible, the FCC requires that buying be split into lots that give small business a chance to bid. Where they are competitive, small businesses, as defined by the Small Business Administration, will get the awards.

## **Federal Spending Ceiling Makes Tax Cut Certain**

**President Johnson's surprisingly low** \$97.9-billion spending plans for the fiscal year starting July 1 bear these important implications: 1) For the first time in several years, suppliers of goods and services to the government will not get the usual upward increments—there could even be a slight drop. 2) Passage of the \$11-billion cut in personal and corporate taxes is now certain. Johnson's "frugality" has impressed congressional holdouts opposed to tax cutting without a spending cut. 3) The philosophy behind the budget will gain momentum if the arms race continues to let up. Johnson is calling for a small start on civilian spending programs that can be rapidly expanded as defense spending tapers off.

## **Labor Department Drafts Law on Overtime Wages**

**In line with President Johnson's drive** against paying overtime in industries where new employees could be added instead, Labor Department experts have drafted legislation that would permit the Secretary of Labor to raise overtime rates—up to double time—in industries with high unemployment that are also deemed to be paying excessive overtime. Special business, government and labor committees would decide whether the overtime was a necessary part of doing business, and whether the higher rate would be too costly for the employer. They would also gather the statistical evidence now lacking to determine what percentage of overtime might be eliminated.

## **Air Force Plans Advisory Committee On Reliability**

**At a reliability symposium** here last week, Air Force Lt. Gen. H. M. Estes, Jr., outlined Air Force policies aimed at getting higher reliability in weapons and space systems. The problem, he said, is to precisely define desired reliability factors for specific systems. Besides going over to quantitative reliability and maintainability figures in contracts, greater stress is being placed on contractor reliability performance (for related story, see p 39). Among the measures being taken to improve capability to determine total system effectiveness "from inception to inventory," Estes said, is a plan to establish a working group to be known as the Weapons Systems Effectiveness Industry Advisory Committee.



## Tiger Country

Here, cargo is king. Here, every truck driver, operations supervisor, teletype operator, mechanic, billing clerk, pilot, cargo handler, customer service representative, and salesman is a top cargo-bearer. Trained and experienced in handling cargo because that's all the Tiger carries. Cargo.

Flying Tigers has been an all-cargo airline since the beginning. Consequently we've been able to develop the best airfreight service going—like this staff of

airfreight specialists, giant Swingtail-44's for outside shipments, pickup trucks with 2-way radios, an advance manifest system to tell where every shipment is at every minute, and a Tiger exclusive, "Sky-road," the combined air/rail/truck system that puts over 2,500 U. S. markets within easy reach.

Next time you have a shipment, call Tigers. New York or Nairobi, Cleveland or Cape Town, to our cargo-bearers, it's all Tiger Country.

*first in airfreight with airfreight first* **FLYING TIGER LINE**





SILICONE

# What you can do with General Electric's **RTV silicone compounds**

*to insulate, seal and mold from -150°F to 500°F*

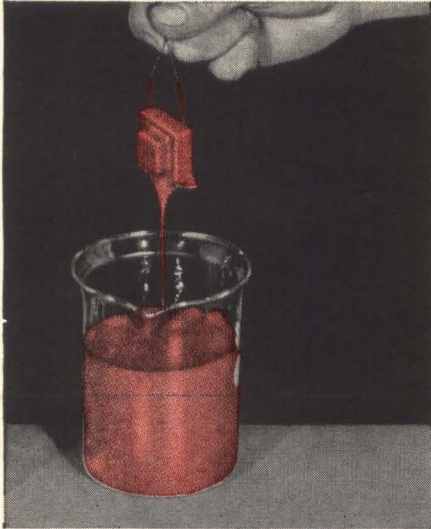

**Encapsulate it.** Fluid RTV silicone rubber penetrates deep into transformer coils. RTV has excellent dielectric strength and practically no shrinkage. Cure time at room temperature can be varied from minutes to hours.

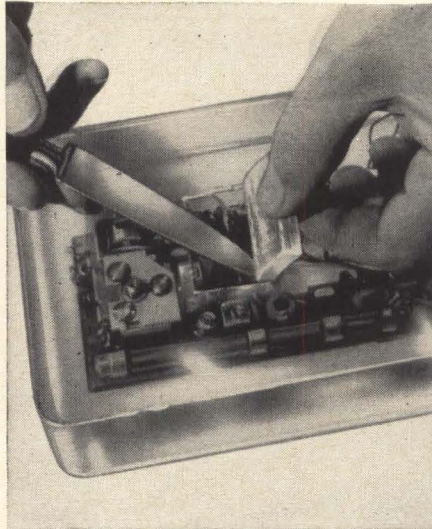

**Pot it.** Transparent or opaque, G-E silicones provide a resilient protection against moisture, ozone, thermal and mechanical shock. Flows freely around complicated parts, can be cut away to replace internal components.

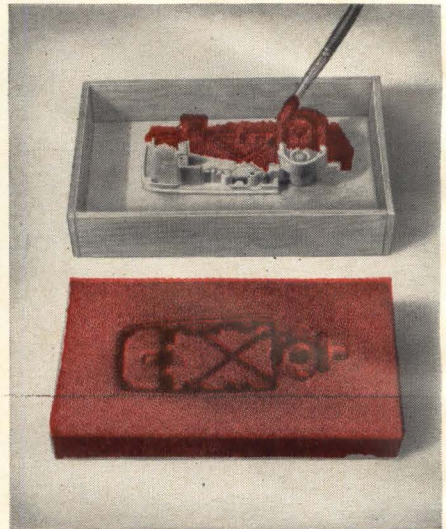

**Duplicate it.** Flexible RTV is often used to make molds for prototypes and short run production. This part requires deep undercutting, but duplicate parts flex free easily. RTV's tensile strength is as high as 850 psi.

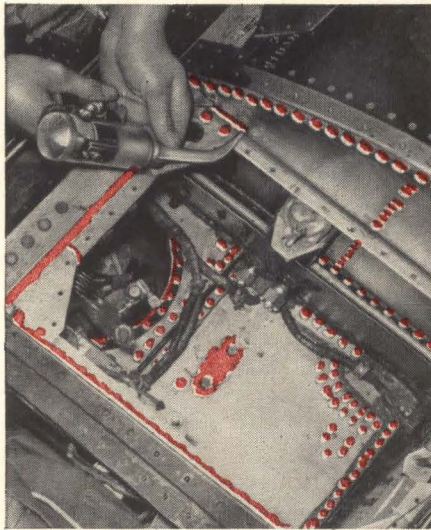

**Seal it.** Bondable RTV (when surface is properly primed) seals against moisture and vibration, ozone and chemicals. Can be used for sheet metal fabrication, shock mounts, gasketing. Viscosities range from pourable to paste.



**Insulate it.** Adhesive/sealant RTV-102 requires no mixing of catalyst, can be used to insulate open wiring, for on-the-spot caulking, gluing and soldering. RTVs are virtually ageless, will not stress-crack or weather.



**Manufacture it.** RTV adhesive/sealants are fast working assembly tools, eliminate prefabricated parts or more costly, time consuming techniques. Here an RTV adhesive laminates flexible mica strips to form cylindrical ducts.

If you would like a free sample of one of the nine General Electric RTV silicones for evaluation, write on your letterhead, describing your application. For additional information, check reader service card. Section N195 Silicone Products Dept., General Electric Company, Waterford, New York.

GENERAL  ELECTRIC



ELECTRONICS in Israel is largely concentrated in or near Tel Aviv. Haifa is second, and Jerusalem third. All three can be covered by car in just a few hours



# ELECTRONICS IN ISRAEL

Israel is on the threshold of a diversified electronics industry. It will soon be able to take care of most of its own needs and can develop specialized products for export

**ISRAEL** is on the threshold of a diversified electronics industry, give or take a year. It will soon be able to take care of most of its own needs and can in time develop specialized products for export. What these specialties will be, when and where they will find a market, cannot at this time be safely predicted. But the obvious dedication of a people moving swiftly from the communal-farming kibbutz to a modern manufacturing economy is speeding up the timetable.

The country has one natural advantage, the possession of scientist-educators second to none in quality and far above most other lands in quantity proportional to population. They have, or soon will have, physical facilities that would be envied by men working in many other places, and operate in an atmosphere that is particularly conducive to basic research. They are turning out engineers at a phenomenal rate, and these are backstopped to an unusual extent by technicians graduated from vocational schools. Research is relatively inexpensive.

Momentarily, the heavy emphasis upon basic research and education which is Israel's heritage is also a disadvantage, because many areas under investigation are primarily of academic interest, and because there is some notable tendency to consider the conversion of ideas that do have commercial value slightly "dirty". Then too, the growing crop of new engineers

By **W. W. MacDONALD**, Consultant  
Huntington, New York

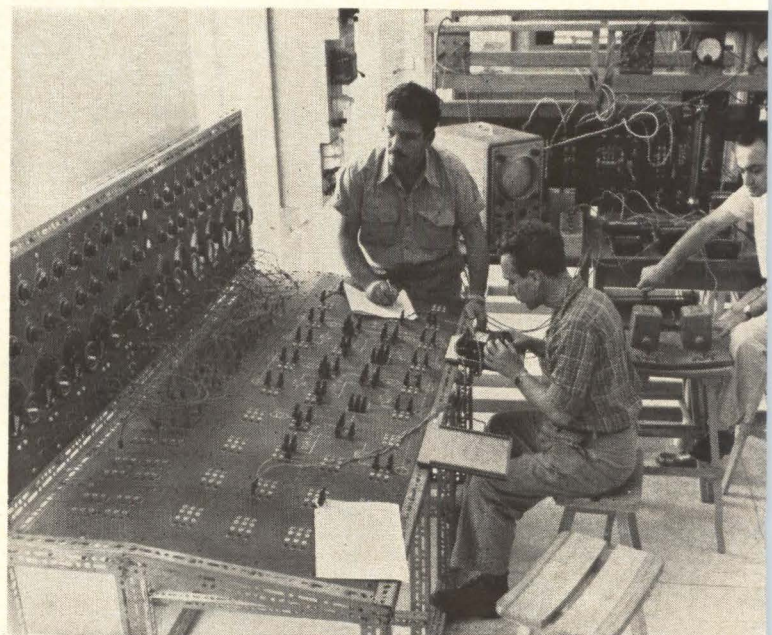

**STUDENTS** of electrical engineering at Technion measuring small magnetic fields



TECHNION, on Mount Carmel. The Valley of Zebulun is in the background, and beyond that Haifa Bay



ARITHMETIC UNIT of Weizmann Institute's Golem computer, under construction in Rehovoth

raised in this climate does not yet have within the country's borders enough industry to provide practical experience, with the result that there is a deficiency in immediate ability to develop and design. This explains why there is at one and the same time a surplus and shortage of such talent, the first in the area of basic research and the second in the area of application.

**Education and Research**—While the Department of Defense and other government agencies do directly engage in some research, and infant industry shows incipient signs of becoming more interested in the applied variety, by far the bulk of it is currently done by three institutions. Here the business of researching for the sake of research, doing it on contract for anyone anywhere who suggests the subject and provides financial support, and educating, is so intertwined among both teachers and students seeking a master's degree that it is difficult to determine where one ends and the other begins.

Technion, *Israel Institute of Technology* at Haifa, turns out most of the country's engineers. The electrical engineering department is currently engaged in applied research on a number of subjects important in the field of electronics. Such as: Analog computers. Instrumentation for measurement of physical quantities like turbulence in fluid dynamics, correlation measurements, wideband mechanical vibration measurements, low level d.c. Fast-current pulse amplifiers with nanosecond rise time. Instrumentation for nuclear research, including fast time-to-amplitude converters. Microcircuitry. Magnetic films. And systems needed for ionospheric and solar research.

An electronics institute was originally set up as a maintenance laboratory for the electrical engineering department but now also designs and builds some equipment. Among items developed here recently are:

Stabilized voltage and current supplies. Electronic switches. Audio oscillators. Pulse generators. Special-purpose sweep-frequency oscillators. Special-purpose curve tracers for semiconductors. And control instruments for asynchronous motors.

Awareness of the fact that Israel has a gap to bridge between basic research and application has caused the school to set up a more or less separate organization to explore the latter area. It will need time to get off the ground. There is also a link to a private corporation in Haifa that manufactures instruments.

World-famous *Weizmann Institute of Science*, at Rehovoth, is primarily concerned with basic research, and among its current high-level projects are the following:

- Nuclear magnetic resonance in solids
- Magnetic interactions in metals
- High sensitivity N.M.R. spectrometer for low temperature work
- Micromagnetics and nucleation
- Ordered magnetism in solids
- Magneto-optics and magnetoelectric effects
- Nonlinearity in the susceptibility tensor
- Weak ferromagnetism
- N.M.R. in magnetic materials
- Magnetochemistry
- Orthoferrites
- Instrumentation for magnetic measurements
- Photochromic effect
- Medical applications of magnetic devices
- Applications of computers in medicine
- Instrumentation for cardiology
- Propagation of sound in the ear
- Instrumentation for brain research and surgery
- Electro-optical instruments for diagnosis
- Miniaturized devices for internal applications

The institute has set up a separate corporation, Yeda, to develop devices that appear to have future market possibilities. One of these is a transistorized

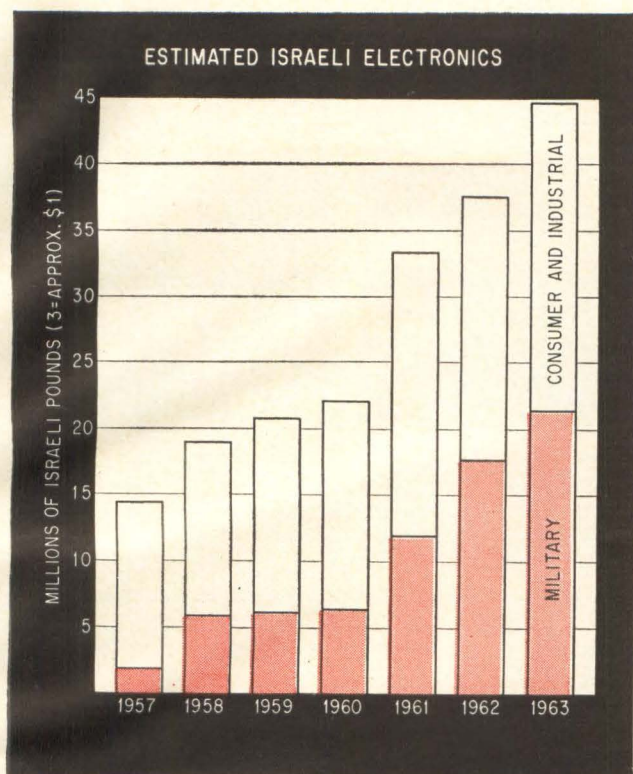

EEG amplifier and transmitter that sends electric brain potentials to a nearby receiver-recorder without interconnecting wires. Another is the Fragilograph, an instrument that provides a rapid and accurate determination of the osmotic fragility of red blood cells. A novel electrodynamic transducer design was introduced some time ago (*ELECTRONICS*, p 93, Feb. 12, 1960) to makers of loudspeakers, and a company operating under license in France has manufactured microphones employing the principle. Financial return to the institute has not, so far, been fantastic.

The department of applied mathematics is building a high-speed computer, called Golem, which in its overall organization and logic is patterned after the American Iliac II but achieves in its central processor a reduction in size by a factor of 10 and a reduction in transistor count by a factor of four. It uses epitaxial mesa transistors in combination with fast germanium diodes, on printed circuit modules, to form saturating logic elements. The two-unit memory, purchased abroad, employs coincident-current magnetic cores and will eventually be capable of handling 16,384 words. The central processor was completed last September, and placed in operation with 8,192 words of memory and paper tape input-output in November. Sometime in the first half of 1964 a magnetic-tape synchronizer and buffer is to be constructed and the computer is scheduled to be in full operation with eight tape transports by July. Sometime within the next two years a magnetic drum or disc is to be added.

Speaking generally rather than specifically, there is a tendency in Israeli institutions to build rather than to buy. This is based on the premise that the latest techniques can best be incorporated in equipment in this manner, that greater reliability can be achieved, that it can be done at substantially lower cost, and that the process of building is educational. There is merit

in this premise, and also in the opposite school of thought which holds it would be better in many cases to buy and thus gain time for devotion to more important overall objectives.

Hebrew University of Jerusalem uses a good deal of electronics in its research program, particularly in the faculty of medicine. Among experimental devices seen there is one intended to continuously watch blood pressure without requiring constriction of the patient's arm except when unusual increases or decreases occur, in which event constriction for precise measurement and recording would be accomplished automatically. Another is a blood-test device requiring transmission of high intensity and therefore very hot light through, say, a patient's finger. To avoid burning, the approach utilizes fibre optics.

While it is not yet widely known, Tel Aviv University, which has until recently been a liberal arts school, now also teaches engineering. Faculty is being initially supplied by the Israeli Atomic Energy Commission, which maintains a well-equipped electronics laboratory near its experimental nuclear reactor turning out radioactive isotopes down at Nahal Soreq. It is too early to tell how graduate students will be oriented.

**Government Manufacturing** — Much like the United States in this respect, something over 50 percent of Israel's expenditure for electronics is by the govern-

### ISRAELI MANUFACTURERS

ALHUT	Natanya	Radios
ALL ELECTRIC	Rishon leZion	Radios, components
AMRON	Herzliya	Radios, hi-fi, tape recorders
AMRON ELECTRONICS	Holon	Intercoms, transceivers, instruments, telephone equipment
COLLARON	Tel Aviv	Record-players, amplifiers, speakers, tape recorders
ELCO	Ramat Gan	Transformers, process controls
ELECTRONICS CORP	Tel Aviv	(See text)
ELRON	Haifa	(See text)
GATRON	Tel Aviv	Speakers, coils, switches
HAREL	Haifa	Car radios
INFRA	Jerusalem	Radios, components
INTERCOM	Tel Aviv	Intercoms
ISRAEL AIRCRAFT	Lod	(See text)
ISRAEL ELECTRONICS	Tel Aviv	(See text)
KEREN	Ashkelon	Communications systems
KINORI	Tel Aviv	Radios, components
LAMDA HA'AN KAMIL	Haifa	Components
LEBEL	Haifa	Radios
MOSHE BASSIN	Tel Aviv	(See text)
ORAM	Lydda	Transformers
PILOT	Tel Aviv	Radios, phonographs
RADIO HECHT	Hadera	Radios
REHOVOTH INSTRUM'TS	Rehovoth	Instruments
RONTON	Natanya	Radios
SPECTOR	Haifa	Communications and navigation equipment assembly
SUPERON	Tel Aviv	Radios, record players
SWERY	Tel Aviv	Packaging equipment
SYNTHETIC CRYSTALS	Tel Aviv	Synthetic single crystals
TELCO	Tel Aviv	Telephone equipment
TEL-RAD CONSOLIDATED	Lod	Telephone equipment
TRANSITON	Tel Aviv	Radios
ZOLOTOV	Jaffa	Resistors, potentiometers



UHF TRANSCEIVER assembly line at Israel Aircraft



TESTING transistorized cardiac pacemaker

ment, and most of this is for defense. Defense is, understandably, highly classified. But this can be said: Army equipment is American made or of similar design, Navy equipment shows both American and British influence, and Air Force equipment is largely French or its locally made equivalent.

The remarkable economic progress achieved by the country in its brief 15 years of existence can be attributed largely to the manner in which the government, often aided by the central labor union called Histadrut, has so far employed the very substantial funds contributed by its many friends abroad. Thus there is a tendency for government to continue in the manufacturing business. This appears to be at least temporarily necessary in the case of certain highly specialized needs as, for example, down in the Negev, and there is also some validity in the belief that manufacture of civilian items is a good way to keep defense plants and personnel in standby operation against a day of possible emergency need. On the other hand, it does little to encourage private industry and there is some evidence of frustration in commercial circles despite efforts on the part of government-owned plants to avoid manufacture of competitive items and despite very real tax and other concessions made within the past year-and-a-half to encourage investment of private capital.

Largest government-owned corporation in the field of electronics is *Israel Aircraft Industries* at Lod. It employs 3,500 people overall. Some 300 operate in our field, including 30 engineers and 75 technicians.

Established originally under the name Bedek to service military aircraft, this company now also expertly services engines in particular for the several commercial airlines using the nearby airport, builds a modified version of the French Fouga Magister jet trainer aircraft, and a good deal of the electronic equipment needed by the Air Force. This includes a transistorized radio compass, airborne radar, radar test equipment and uhf transceivers. It is also starting to build, for commercial sale to the medical profession, and a-c/d-c defibrillator, a pulse monitor and a cardiac pacemaker. The prototype of an electric respirator is nearing completion. A transistorized intercom system for industrial use is in process of design.

**Multiple Ownership**—It is not uncommon in Israel for a manufacturer to be financed by a plurality of investors who might, in other lands, be considered

FOUGA jet  
made by  
Israel Aircraft  
Industries  
near Lod



strange bedfellows. Such is the case at Tadiran, *Israel Electronics Industries Ltd.*, operating seven specialized plants in and near Tel Aviv. Ownership is divided between the Department of Defense, the labor union, and private capital.

This aggressive and well-managed company obviously organized with an eye to the future has so far obtained most of its research and development and needed manufacturing knowhow through working arrangements with American companies. It sold IL 1-million worth of goods in 1961 (an Israeli pound is about  $\frac{1}{3}$  of a U.S. dollar), IL 2-million in 1962, IL 3.46-million in 1963 and hopes to do IL 8-million in 1964. Its product line is already extremely broad, a trait common among even new Israeli companies of any size at this stage of market development. Diversification helps pay the immediate bills, whether or not the present product mix is destined to continue in the future. It probably will be modified but expanded.

Communications equipment is made by this company for the Army, to U.S. specifications. Most of the mechanical parts are made in plant, as are printed circuits. Machine shops are relatively plentiful in Israel but it was considered necessary in this instance to buy one and incorporate it within the company in order to secure required close tolerances to which most local shops are not yet accustomed. Plating and other finishes to military specifications also require a good deal of in-plant training. Printed circuits are made in plant for the same reason, as they are also made in several others.

A line of transistorized automobile radios has been the commercial mainstay. The company is doing well under license with air conditioners introduced within the past year or so. It also makes battery-operated lanterns, one of which employs a transistorized flasher circuit. Another model automatically provides emergency lighting when local power fails.

Up-to-date technically is a division making an extensive line of quartz crystals. So also is another operation using quite modern methods to make a wide range of germanium-transistor types from crystals imported from overseas. Present equipment, and some supervisory personnel, was imported lock, stock and barrel as a complete manufacturing unit from Long Island, New York. It is planned also to make planar silicon types and, later, to fabricate microcircuits.

Still another unit has high hopes for its line of surface-barrier detectors featuring especially rugged

construction, coaxial connections, no dead layer and individually certified test data.

**Private Industry**—Considering Israel's 2,300,000 population and tender age, it already has a great many manufacturers. Most of them are quite small, have not yet achieved great stability and are trying to get started in electronics by making radio sets or hi-fi equipment primarily for the active home market. There is some exporting to, for instance, Turkey, and long-range promise of business from Africa, but competing with conventional products in most foreign markets is difficult. For one thing, while engineering manpower is comparatively inexpensive in Israel, production and office help is not, and large-scale production methods and machinery have not so far seemed generally supportable. For another, wirewound resistors are one of the few specialized components made in the country other than the transformers most equipment manufacturers wind themselves, and the supply pipeline for parts is both a long and slow one. Too slow, many say.

Whether or not Israel should try to establish a rounded out component parts industry is controversial. There is, on the one hand, a great desire to be self sufficient, and on the other a conviction that the size of the internal market plus immediately available export business for a country whose land borders are closed probably does not warrant such an ambitious program at this time. Most manufacturers of commercial equipment would prefer to buy rather than to make components other than mechanical items. They are, however, handicapped by the relatively small quantities needed and either make them or shop around quite widely, particularly in Europe. Receiving tubes, for example, may come from England or from France. They may also come from Hungary. American components are more common in professional equipment.

Next fillip to the internal market could be television, but the manner in which it may be introduced and the date is uncertain. The government, which has long resisted television, is now understood to be receptive to the idea that an educational station up in the hills between Tel Aviv and Jerusalem could materially relieve a growing grade-school teacher shortage. A French financier and philanthropist is said to have promised all or most of the money which would be needed to build such a station. Meanwhile, an estimated 10,000 receivers are already in use, mostly in

the north, looking at programs emanating from Arab countries. At least two Israeli manufacturers have sent engineers to France to acquire television receiver design and manufacturing experience, hoping that the proposed educational station could later lead to commercial service.

Home equipment for which there is a ready though increasingly competitive market is sometimes the sole manufacturing objective when an Israeli company first enters the electronics business but more often represents just the first hopeful move toward diversification. For example, *Electronics Corporation of Israel*, in Tel Aviv, a company that has successfully weathered several changes of ownership and acquired useful management experience, attributes 65 percent of its volume to manufacture and sale of the Schneider brand of radios. The remainder, being given increased emphasis, includes contract work for the government and others, the design, manufacture, installation and maintenance of hotel electronic equipment and controls, and some telemetering system work. A public-address-system line is under development, and the company has an eye open for saleable products beyond that.

Specialized electronic instruments appear to hold particular promise for Israel in world markets because they could be the natural result of intensive research among the institutions mentioned earlier. Thus there are a number of budding instrument makers. One of these is *Elron Electronic Industries Ltd.*, Haifa, making a Geiger survey meter, a preset electronic counter, single-channel analyzers and a Mossbauer-effect spectrometer. The company believes it has at least a slight technical edge because of its understanding of how best to employ transistors as current amplifiers. Employees have increased from 25 to 55 in the past year, include 10 engineers and 14 technicians.

There are, too, highly enterprising manufacturers' representatives who import electronic equipment from abroad but rarely stop at that. For example, *Moshe Bassin Electronics & Engineering Ltd.*, of Tel Aviv specializes in American equipment. It has distribution

of a top line of mobile communications gear and has done so well with it that rumors dating back nearly two years to the effect that it might be set up for limited manufacturing persist. The company also handles four well-known non-competitive instrument lines, a professional tape recorder, a good brand of portable generators, a citizens-band transmitter-receiver kit which it assembles itself and sells to gain entre to future commercial communications accounts, and an antenna line. It also makes Yagi antennas of its own for specialized applications and designs and builds accessories needed for application of much of the apparatus it imports to specific system requirements such as those involved in telemetering or interconnection with telephone lines. Digital data transmission suitable for computer input is under study.

Two years ago this company employed 15 people. Today it employs 40, which includes eight engineers, 25 technicians and seven field engineers—"No one in Israel, among those with technical training at least, wants to be called a salesman."

**The Future**—Israel's electronics industry is on its way, and will one day be a factor in specialized world markets. The country has the most important ingredients . . . the need, the brains and, particularly, the necessary drive . . . and much of what it doesn't have it can acquire. It will not be easy, but then when has birth ever been.

The process will be aided by men such as Raanan Amir, who as an Israeli public information officer in New York suggested an on-the-ground look at the beginning of an industry, and who has since returned to his homeland to become Deputy Director of the Industrial Development Bank's Investment Corporation. And by Louis Williams of the Investment Authority in Tel Aviv who, with his associates, arranged and facilitated the trip. And by the many others in government, the institutions and in industry who were so generous with their time. To them all we say . . .

Shalom.

NEW QUARTERS for Hebrew University medical school, square structure at left, in Eim Kerem near Jerusalem. Buildings at right house Hadassah Medical Center





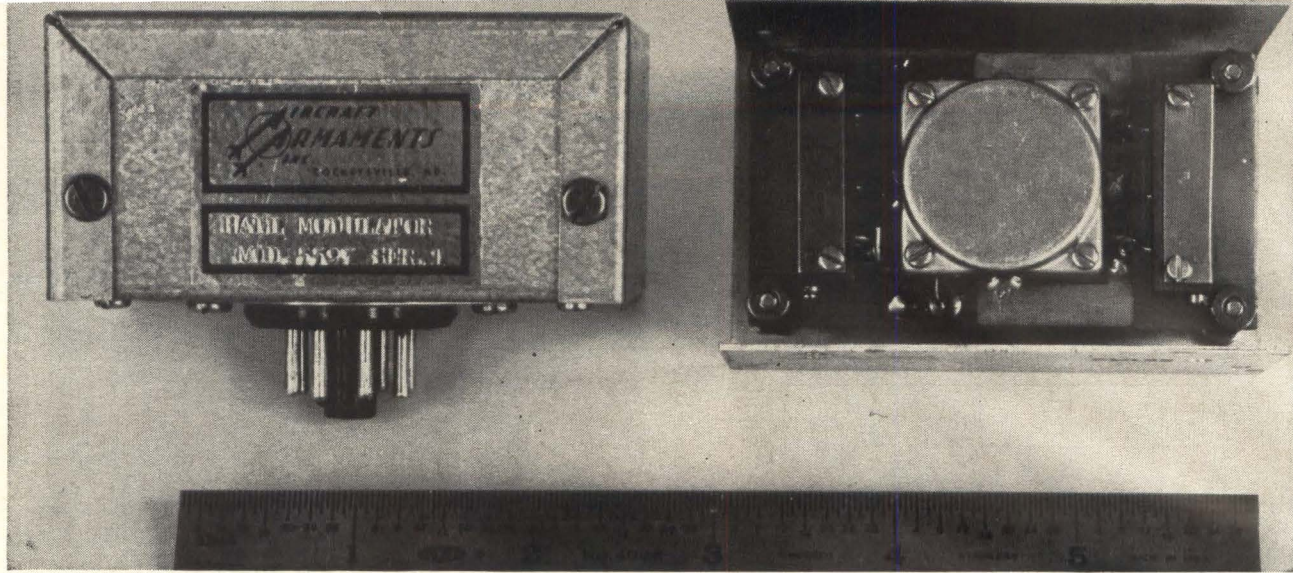

HALL MODULATORS are inherently compact. Trimmer resistors of Fig. 2B are seen in right view

# New Uses for Hall-Effect

simplicity offset the low efficiency of Hall-effect modulators. Output

## HALL EFFICIENCY

The main trouble with Hall-effect multipliers at present is their low efficiency. Whether or not this efficiency can ever be substantially raised is problematical, since it depends on a materials constant called the Hall coefficient. The Hall coefficient is much higher for semiconductors than it is for metals but still leaves much to be desired. But efficiency is only one parameter, and Hall multipliers have some important advantages.

By **ALBERT R. HILBINGER**  
Aircraft Armaments Inc.  
Cockeysville, Maryland

**HALL EFFECT DEVICES** are useful as modulators since their output voltage is proportional to the product of two input voltages or currents.<sup>1, 2, 3, 4</sup> In spite of an inherently low efficiency, Hall-effect multipliers offer the advantages of simplicity and wide dynamic range.

**Circuit**—Hall output voltage, as indicated in Fig. 1A, is

$$E_h = (R_h I_c B / t) \times 10^{-8} \text{ volt} \quad (1)$$

where  $R_h$  = Hall coefficient (a semiconductor ma-

terial constant) in  $\text{cm}^3/\text{coulomb}$ ,  $I_c$  = semiconductor element control current in amperes,  $B$  = magnetic flux density in gauss, and  $t$  = semiconductor element thickness in centimeters.

Flux density produced in an air gap in a ferromagnetic core operated below saturation can be expressed as

$$B \approx 0.4\pi N I_b / L_g \quad (2)$$

where  $N$  = number of turns in coil wound on core,  $I_b$  = coil current in amperes, and  $L_g$  = length of air gap in core in centimeters.

Substituting Eq. 2 for  $B$  in Eq. 1 and combining constants yields

$$E_h = K I_c I_b \quad (3)$$

where  $K = 0.4 \pi N R_h \times 10^{-8} / t L_g$ .

Thus the Hall voltage is a true product of two applied currents. If the currents are expressed in terms of the voltages which produced them

$$E_h = K' E_c E_b \quad (4)$$

where  $K' = K / R_c R_b$ , and  $R_c$  = resistance of control-current input circuit and  $R_b$  = resistance of field-current input circuit.

**Modulation**—If the two inputs are sinusoids  $E_c = E_{oc} \cos \omega_c t$  and  $E_b = E_{ob} \cos \omega_b t$ , the resulting output product is

$$E_h / K' = E_c E_b = E_{oc} E_{ob} \cos \omega_c t \cos \omega_b t \quad (5)$$

Letting  $E_{oc} E_{ob} = E_o$  and applying the appropriate trigonometric identity

$$E_h / K' = (E_o / 2) [\cos (\omega_c + \omega_b) t + \cos (\omega_c - \omega_b) t] \quad (6)$$

If  $E_c$  is a carrier frequency and  $E_b$  a modulating signal, Eq. 6 represents a modulated wave. The equation has two sideband terms,  $(\omega_c + \omega_b)$  and  $(\omega_c -$



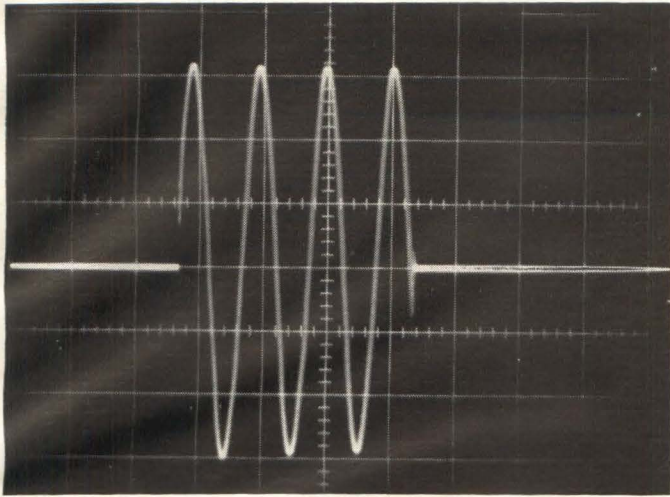

WAVEFORM of pulse-modulator output for 5-kc output

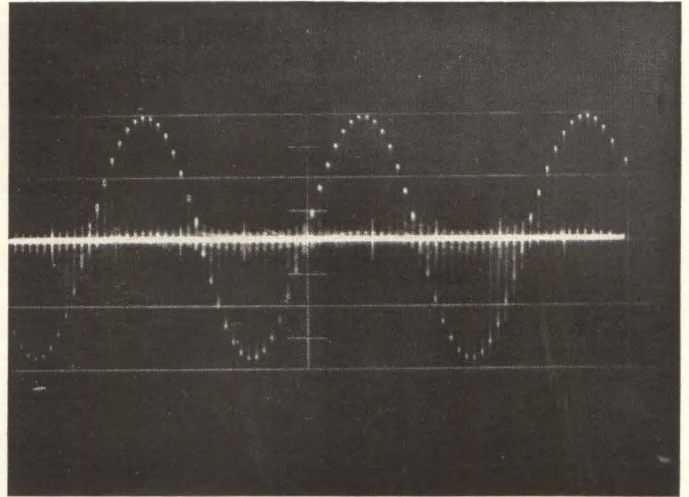

WAVEFORM of pulse-modulator output for 5-kc output

# Modulators

Dynamic range down to d-c and circuit

is a suppressed carrier signal, a true product of the two inputs

$\omega_b$ ) and no carrier term (a term in  $\omega_c$  only). Thus the resulting output is a suppressed carrier or balanced modulator signal; the Hall-effect multiplier is inherently a balanced modulator.

**Applications**—A number of applications employing Hall-effect modulators have been investigated and three will be described. In all cases the same basic physical construction was used. A rectangular indium arsenide (InAs) element is cemented to a ferrite disk and then lapped to the desired thickness. Four electrical connections are made to the semiconductor element as shown in Fig. 1B. The ferrite disk-semiconductor element assembly then becomes an integral part of the magnetic structure, as shown in Fig. 1C. The magnetic field through the semiconductor element is produced by a current flowing in a coil wound on a bobbin which is mounted around the center ferrite post of the assembly.

In one application a carrier frequency of approximately 1-Mc is modulated with a fixed frequency of 400 cps. Theoretically, either signal could be applied to either input. The practical choice, however, is to use the carrier frequency as the control current and the 400 cps as the magnetic-circuit drive, as shown in Fig. 2A. Core losses in the ferrite material used would be high at 1-Mc whereas the semiconductor element is essentially a pure resistance. The magnetic field coil is then series resonated to minimize the input power. Output is applied to a load of approximately 15 pf. Since input frequencies are fixed, it is possible to resonate the capacitance with a high-Q inductance that is link-coupled to the output of the Hall-effect multiplier.

With no modulating voltage applied, but with maxi-

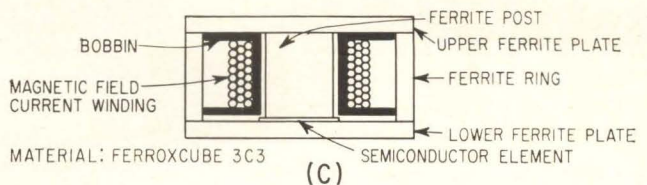
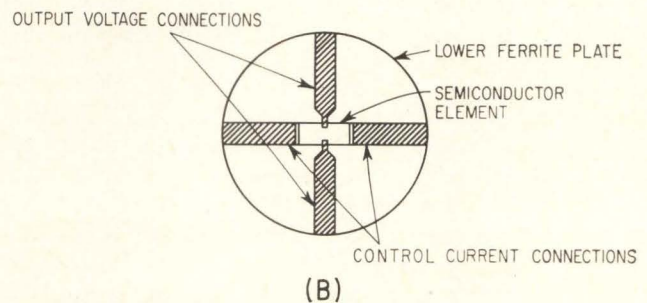
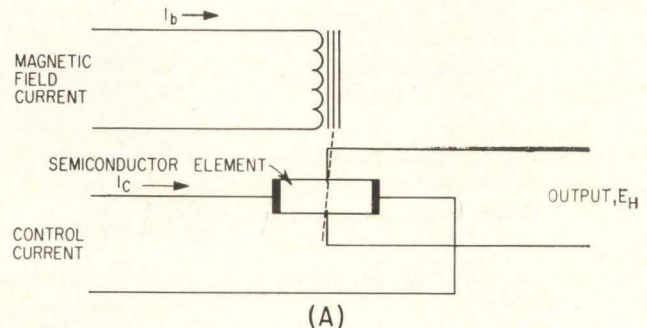

OUTPUT OF HALL-effect device (A) is a voltage proportional to the product of control current and magnetic flux. Electrical connections to semiconductor block (B) and cross section of multiplier (C). The magnetic circuit is operated in its linear region to keep saturation nonlinearities from affecting the output—Fig. 1

imum carrier input, the output voltage is nulled with  $R_1$ . This minimizes the in-phase component of what is generally called the zero-field voltage. This voltage also contains a quadrature component that is eliminated by adjusting  $C_1$ . After potentiometer  $R_1$  is adjusted, maximum modulating signal amplitude is applied and  $C_1$  is adjusted for zero output at the points of modulation envelope cross-over.

In many Hall-effect modulator applications the leakage component inductively coupled from the magnetic field to the output must be removed. In this application this component was eliminated by the narrow-band output circuit.

Modulator output voltage is linear within one percent of full scale from zero to peak-field excitation of  $\pm 12$  ampere-turns. With 850 milliwatts of carrier power and peak-field excitation of 12 ampere-turns, a modulated 100 volts peak-to-peak was obtained. The output could be increased by using a multiplier ferrite core material with a higher saturation flux density or by using a higher Q output transformer. A 50-percent increase in output level could be achieved with presently available optimum core materials for both multiplier and output transformer, with no increase in input power.

**Pulse Circuit**—In a second application a Hall-effect multiplier was used to produce bursts of audio-frequency signals, as indicated in Fig. 2B. Audio response of the unit is from d-c and is down 3db at 20 kc; there is no low-frequency cutoff. Pulse input requirements are one ampere peak at a maximum duty cycle of 0.1. For lower duty cycles peak current can be increased, with the restriction that the average pulse power dissipated in the semiconductor element does not exceed 2 watts. Resistor  $R_1$  provides the audio bandwidth and matches the audio input to a particular voltage source. Resistor  $R_2$  matches the pulse input to a 50-ohm pulse source. Potentiometer  $R_3$  is adjusted for minimum pulse output with no audio applied; potentiometer  $R_4$  is adjusted for minimum audio output between pulses. For both  $R_3$  and  $R_4$ , infinite resolution trimming potentiometers are used.

Results obtained with one-ampere peak pulses and 10 volts rms audio input include an output of 350 mv peak-to-peak, with the output more than 65 db down between pulses.

The audio input could be increased to 100 volts rms without distortion, giving an output of 3.5 volts

peak-to-peak. But the audio rejection between pulses would be degraded by approximately 20 db. Also, the peak pulse current could be increased in accordance with the power restrictions mentioned. Operation at greater pulse amplitudes with the audio input voltage held constant would improve audio rejection between pulses. For maximum audio rejection under any conditions, the pulse source should not have a d-c output level between pulses.

Oscilloscope photographs of the output waveforms of the modulator are shown and also the unit packaged as a plug-in module.

In a variation of the device, a pulse repetition rate higher than the audio frequency was used. Output characteristics are similar to those of the preceding modulator. If a number of pulses per cycle of audio are desired, the audio range is restricted by the pulse requirements. For example, at one ampere peak pulse current, if the pulse width is 10 microseconds and the duty cycle is 0.1, the maximum prf is 10 kilocycles. For ten pulses or more per cycle of audio under these conditions, the maximum audio frequency is one kilocycle. By reducing the peak pulse amplitude, a higher duty cycle could be employed, thereby allowing higher audio frequencies.

A possible application for this mode of operation is the detection of low-frequency magnetic fields. The physical construction previously described could not be used; instead, the magnetic field would be applied to the semiconductor element with flux collectors or magnetic antennas.

Other modulator applications covering a wide range of frequencies have been described in the literature.<sup>5, 6, 7</sup> The potentially rugged simplicity, low cost, and wide dynamic range of the Hall-effect modulator make it ideal for a wide range of applications where a true-product, suppressed-carrier device is required.

## REFERENCES

- (1) W. A. Scanga, A. R. Hilbinger, and C. M. Barrack, Hall Effect Multipliers, *Electronics*, July 15, 1960, p 64.
- (2) G. L. Keister, A Compact Multiplier Puts The Hall Effect to Work, *Control Engineering*, Nov., 1955, p 94.
- (3) R. P. Chasmar and E. Cohen, An Electrical Multiplier Utilizing The Hall Effect in Indium Arsenide, *Electrical Engineering*, Nov., 1958, p 661.
- (4) G. S. Glinski and J. P. Landolt, Theory and Practice of Hall Effect Multipliers, 1961 IRE International Convention Record, Part II.
- (5) Armour Research Foundation of Illinois Inst. of Technology, "Instrumentation and Measurement Techniques Study", Signal Corps Contract No. DA 36-039 SC-78269, Quarterly Progress Report Nos. 2, 3, 4, 6, 7 and 8.
- (6) E. Cohen, Hall Effect Multiplier for Use at Radio Frequencies, *Electronic Engineering*, 32 p 558, 1960.
- (7) E. Cohen, An Improved Radio Frequency Hall Effect Modulator, *Electronic Engineering*, 34 p 316, 1962.

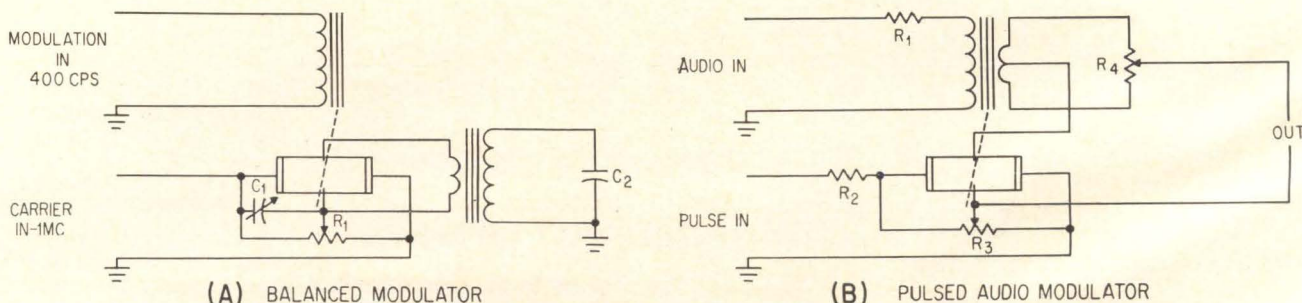

BALANCED-MODULATOR circuit (A) with low frequency applied to the inductive magnetic circuit and high frequency applied to the resistive semiconductor. Pulse-driven circuit (B) can produce pulses of audio or an audio signal sampled at a high pulse rate—Fig. 2

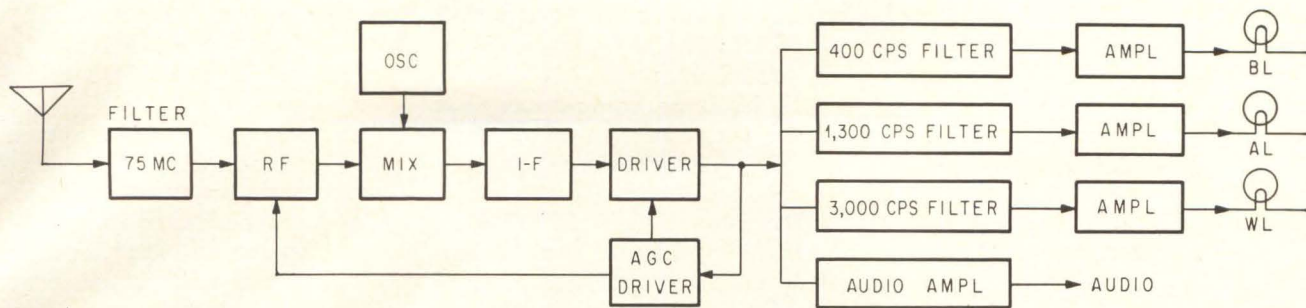

SOLID-STATE design uses automatic gain control, temperature stabilization and mismatch techniques for high-reliability performance. Power consumption is 12 v, 150 ma on receive, and total weight is 2 pounds as a lab model—Fig. 1

# Light-Airplane Marker-Beacon Receiver

Silicon transistors, combined with modern design techniques make this completely solid-state marker-beacon receiver a high-performance, compact unit for small-aircraft owners

By JAMES G. ROBERTSON, Research Asst., Univ. of Washington, Seattle, Wash.

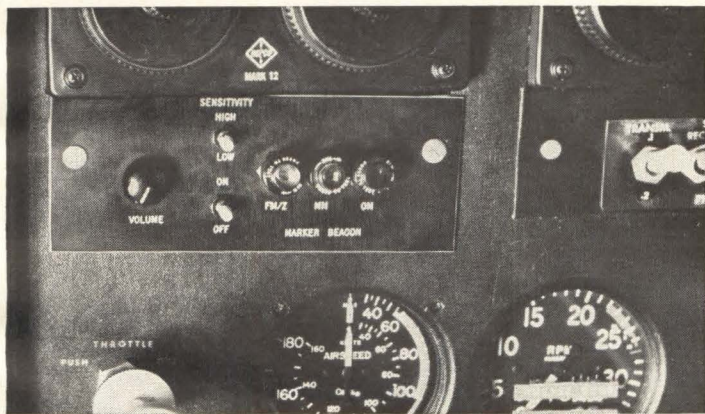

MARKER-BEACON RECEIVER controls mount on instrument panel 6¼ by 1½ by 1½ in. deep. Receiver is mounted in tail

## GENTLEMEN FLIERS

There are over 85,000 general aviation aircraft in the U. S., with the number increasing every year. Recent estimates are that some 81-percent of those aircraft have at least a radio, but few have any of the radio-navigation devices needed for practical air safety. Present equipment hasn't reached the stage of mass buying by the light-plane owner. Solid-state designs featuring high reliability at a low price are the key. Here is a design with a performance said to be superior to light-aircraft equipment presently available, yet not as elaborate as devices for heavier airplanes

**THIS RECEIVER** is a component of an airplane's instrument landing system (ILS). As the airplane makes an ILS approach it follows a radio beam radiating from the end of the runway which defines both horizontal and vertical position.

To obtain distance from touchdown three marker beacons are spaced along the approach path. As the aircraft passes over a marker beacon transmitter, the airplane's receiver responds with an indicator light and audible tone. The first beacon, blue, approximately five miles from touchdown, has a 400-cps modulated tone. The middle marker, amber, about one and one-half miles from touchdown, is modulated at 1,300-cps. The last marker, on the end of the runway, white, is 3,000-cps. Fan markers, 3,000-cps, are also located on airways to aid navigation.

All beacons use the same carrier frequency, 75-Mc, and all modulations are 95-percent. The beacon transmitters are low power, requiring the receiver to be sensitive to provide the desired 15-second response. Receiver selectivity must be high to both separate the small desired signal from the relatively large neighboring frequencies, and eliminate spurious responses, a common source of trouble with marker beacon receivers. Because of narrow bandwidth, receiver center frequency must be accurate for all levels of automatic gain control and tempera-

ture variations, and requires temperature stabilization. To pinpoint the aircraft's position, the light threshold level should be independent of temperature and agc levels.

**Operation**—The system is shown in Fig. 1 and Fig. 2.

One problem in receiver design is the close proximity of the channel-5 television carrier, 77.25-Mc., to the 75-Mc carrier frequency. To avoid first stage saturation by signals and eliminate much spurious response, a narrow bandpass filter is used before the first stage.

A separate crystal-controlled oscillator provides stability and dependability.

Four stages were necessary in the intermediate-frequency section (i-f) to get desired selectivity. A large amount of interstage mismatch is used for high inherent stability and also to reduce gain.

A single r-f stage provides isolation of the local-oscillator from the antenna, while giving about 6-db gain which approximately replaces the power lost in the input filter. Also, the r-f stage is used in the agc circuit.

Following the detector is a two-stage driver with automatically variable gain which provides most receiver agc. Variable gain control is by a dynamic emitter-feedback circuit. Variable feedback controls the gain of the system, independently of the i-f strip, for no variation of i-f center frequency, bandwidth, or indicator threshold level with agc. A two-position feedback control varies both sensitivity and indication time.

The agc provides enough control to accommodate signal strengths from 300- $\mu$ v to 50-mv.

The lamp signals are separated by tuned-emitter by-pass filters which feed the lamp power circuits.

**Input Filter**—The input-filter rejects the TV channel-5 carrier, 77.25-Mc. This required a narrow-bandpass filter of optimum design. A 4-pole butterworth filter designed specifically for this use produced nearly the theoretical 48-db down at 77.25-Mc.<sup>1, 2</sup> This was proved in operation near the channel-5 antenna while on the ILS approach to Boeing Field, Seattle.

**Neutralization**—In the r-f, local-oscillator, and i-f stages Fairchild sili-

con, planar, diffused transistors were used because of low  $I_{cbo}$  (0.3- $\mu$ a), high cutoff frequency, and low internal feedback capacitance. The 2N916 gives a beta cut-off of about 400-Mc, which provided good gain at 75-Mc. Emitter degeneration is used to give some agc at large signal levels. A low-Q tuned-circuit avoids introducing too much detuning and distortion by the variation of junction capacitance during the application of agc. Neutralization is used with the transformer designed to match the load to the output impedance of the transistor. A mismatch design destroys too much gain to be used at this high frequency. The 180 degrees phase shift for the neutralization power is obtained by tapping the transformer. This gives least chance of device failure from component aging.

**Biasing**—The biasing arrangement of all critical stages is of common-emitter design<sup>3</sup>. The circuits are designed for a stability factor of four ( $I_c = 4 I_{cbo}$ ). This is done by having the equivalent series base resistance approximately five times as great as the emitter resistor. The other major source of temperature variation, change in emitter resistance, is compensated for by a silicon diode with temperature characteristics similar to those of the emitter-base diode in the transistor. The diodes are installed so that they equalize the effects of the transistor emitter resistance variation. The temperature variation of base bias voltage is approximately the same as the emitter base junction; the bias level remains essentially constant.

**Local-Oscillator**—The crystal-controlled oscillator is stable with a variation of only 2-kc over the voltage range encountered.<sup>4</sup> The 15-pf capacitor, in series with the crystal, compensates for the phase shift in current gain (beta) at oscillation frequency. The feedback turns ratio was picked to supply the feedback voltage necessary when considering the drops across the crystal resistance and the feedback capacitor. The crystal and transistor are both neutralized to eliminate all feedback paths except that through the crystal. The oscillator signal is injected to the mixer through an impedance matching capacitor of 2.2-pf, for high output impedance and maxi-

mum isolation between circuit and oscillator.<sup>5</sup> The local-oscillator frequency is 68.75-Mc; i-f is 6.25-Mc.

**Mismatching**—Transistors, even of the best quality, have considerable capacitance between terminals. At high frequencies this capacitance introduces enough feedback to cause oscillation and interaction between input and output impedance variations.

This design has 10-db of mismatch per stage, giving no tendency for oscillation and almost complete isolation of stages during alignment. It would have been possible to achieve more gain from the i-f strip by using less mismatch and partial neutralization; however, mismatch provides more reliability.

The mixer is biased well on the knee of the emitter-base diode characteristic to give the necessary nonlinear (second order) input impedance for mixing. The high-frequency gain at the low bias level is much less than the i-f gain, so the stage serves as an i-f amplifier but blocks the high-frequency components produced by mixing.

**AGC**—The light output circuits will not tolerate much overdriving before cross talk is experienced. To avoid this, and at the same time accommodate the large signal strength variations encountered in operation, a strong agc is required.

Emitter degeneration agc could have been used on the first couple of i-f stages, but variation of the bias point would have changed the reactive output and input impedances of the transistors, in turn changing the resonant frequency of the interstage tuned-network. The change would have introduced distortion of sufficient magnitude to create spurious responses. To make the agc completely independent of the i-f strip, and to avoid distortion, variable emitter-feedback is used in the two-stage driver. This is done by a diode in series with the a-c emitter bypass. The diode bias level is varied by the agc signal, thereby controlling the feedback and gain of the stage. The less bias on the diode the higher its small signal impedance, which in turn increases input impedance of the stage and reduces gain.

At extremely large signal levels the last stage of the i-f tended to

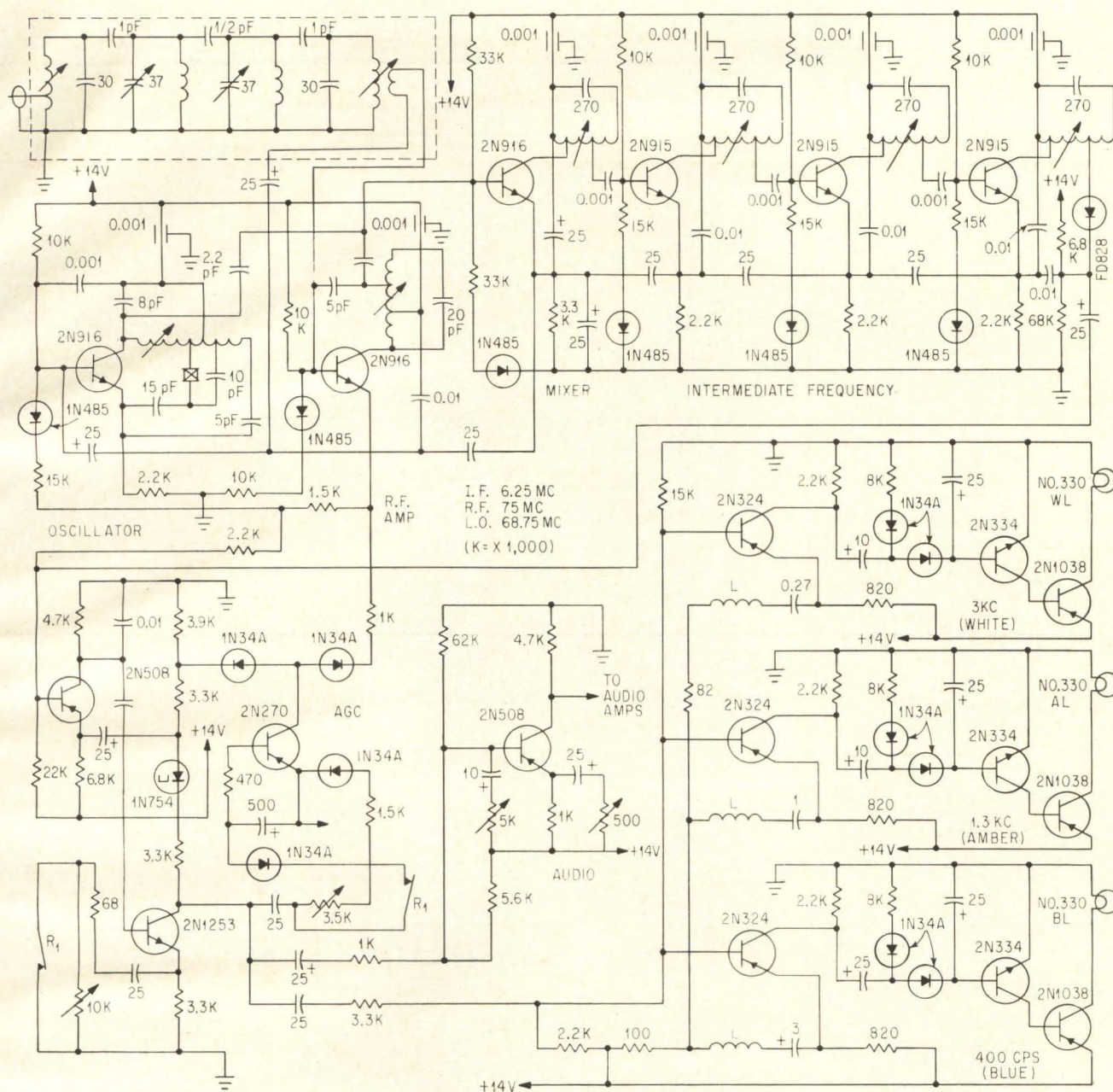

COMPACT design and layout features audio stage able to drive a multiple amplifier system. Indicator lights peak when over a marker beacon transmitter to aid in pinpointing position on airways or on an instrument-landing approach—Fig. 2

introduce distortion. To eliminate this, the agc circuit was tailored to provide emitter degeneration on the r-f stage at large signal levels only. The agc current flowing to the r-f stage reduces bias level and gain.

A remote-controlled, two-position feedback circuit is used in the driver to control the sensitivity of the receiver. This varies threshold from 500- $\mu$ V to 2,000- $\mu$ V

**Audio**—The simple one-stage audio driver with volume control provides sufficient power to drive several amplifiers in a multiple system. The emitter bypass has an adjustable feedback control allowing adjust-

ment of output level to match the particular system to which it is connected.

**Lamp-Filters**—Tuned-emitter bypass is used on germanium transistors to filter the signals which operate the separate indicator lights. Output of the filter stage is rectified and smoothed to d-c, which drives the two-stage d-c amplifier powering the lamps.

The filters have relatively low Q which, because of the small separation of the frequencies, requires the input level to the filters to be held constant to a maximum value to prevent crosstalk.

This type of output system allows the pilot to more accurately pinpoint his position because of brightness peaking of the lamps as he flies over the beacon transmitter.

#### REFERENCES

1. International Telephone and Telegraph Corporation, Reference Data For Radio Engineers, Stratford Press Inc., New York, N. Y., 1962.
2. Ernst A. Guillemin, Synthesis of Passive Networks, John Wiley & Sons, Inc., New York, N. Y., 1957.
3. Maurice V. Joyce and Kenneth K. Clarke, Transistor Circuit Analysis, Addison-Wesley Publishing Co., Inc., Reading, Mass., 1961.
4. Brian L. Jones, A 108 mc/s Crystal Controlled Transistor Oscillator, Application Data Fairchild Silicon Transistors, App-19, Fairchild Semiconductor, 1961.
5. Harry F. Cooke, Designing Television Tuners with Mesa Transistors, Design Manual for Transistor Circuits, ed. John M. Carroll McGraw-Hill Book Company, Inc., New York, N. Y. 1961.

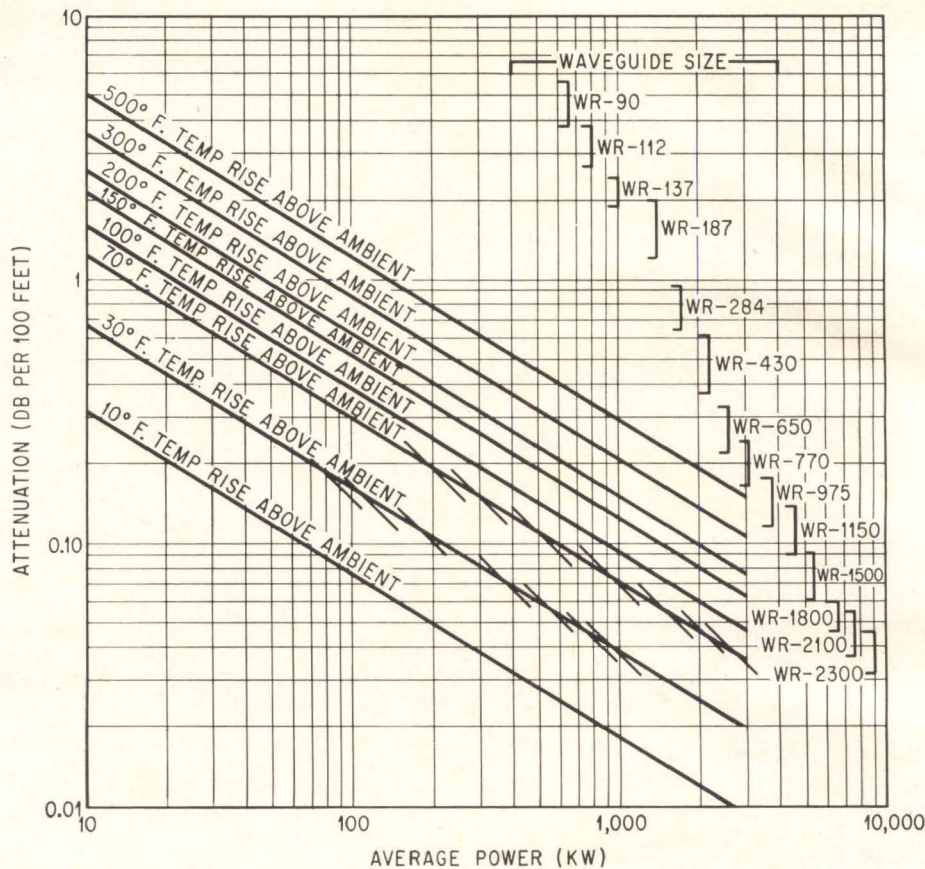

## Temperature Rise in Rigid Waveguide

By **T. J. VAUGHAN**  
Manager of Engineering  
Antenna Systems, Inc.  
Manchester, N. H.

**DESIGNERS** of waveguide components must be concerned with the temperature increase above ambient due to the average power.

Knowing the average power in watts, the temperature rise above ambient of the waveguide can be quickly determined from the graph. The heat is generated because of the power lost due to the attenuation of the guide. The calculations are based on a 2:1 aspect ratio and material emissivity of 0.5.

By plotting, attenuation of that waveguide is the bracketed figure on the right. Because the attenuation varies for different materials available, the most common material used for the respective wave-

guide size have been selected from: WR 2300 to WR 650 Aluminum 6061 T6; WR 430 to WR 284 Commercial Aluminum; and WR 187 to WR 90 Brass.

**Data**—The temperature rise plot represents averages: on the 30 and 70 F plots, for example, the slash line shows how the temperature varies within a waveguide size as a function of frequency. For example, in WR-975, operating 755 to 1120-Mc, attenuation varies from 0.115-db at 1120-Mc to 0.18-db/100 ft. at 755-Mc. For the higher temperature this represents a worst case since natural convection was assumed, for example even the smallest amount of forced convection will drop the temperature.

For any given waveguide size, from the operating frequency the attenuation per unit length can be determined from manufacturer sup-

plied charts or available handbooks. Once attenuation is known, temperature rise can be determined for the average power in question from the above chart.

**Example:** WR-975 at a frequency of 755-Mc and an average power of 100-Kw. From charts or handbook the attenuation is 0.18-db/100 ft. Laying a straightedge on the chart at this attenuation gives a temperature rise of 35 F above ambient.

This data, confirmed by myself in the 0.08db/100 ft and 1 megawatt region and by MIT-Lincoln Laboratory in 0.3/100 ft and 50 Kw region, can be useful to those who are unaware that with the high average powers now available (and required in satellite communications) there can be a serious temperature problem. This could limit the system noise temperature on a low noise tracking system.

**For oscillographers  
who refuse to  
compromise**



## The advanced **NEW** **CEC 5-133 DataGraph®** **Recording Oscillograph**

Combine the virtues of all the oscillographs you've ever used, then compare them with the 5-133 DataGraph. The versatility, performance and convenience advantages of the 5-133 will be obvious immediately. The design speaks for itself. The 5-133 DataGraph Oscillograph — rack-mounted or bench-mounted — is a direct-writing instrument producing 36 or 52 channels of data on a 12-inch-wide light-sensitive paper. It easily fulfills *and surpasses* the most demanding technological requirements.

### **Important Features**

**STATIC MAGNETIC REGULATED LAMP POWER SUPPLY** — provides proper power to lamp regardless of input voltage variations, allows start/restart times of less than one second.

**SLOT-EXIT CAPABILITY** — up to 160 inches-per-second.

**ADJUSTABLE GRID LINE INTENSITY** — continuously variable vernier control.

**TIMING LINE GENERATOR** — electronically flashes timing lines at intervals of 10, 1, 1/10, 1/100 and 1/1000 second. Every 10th line accented.

**RECORD/EVENT NUMBERING** — selected by front panel switch.

**AUTOMATIC RECORD LENGTH CONTROL** — continuously variable from 0 to 15 feet; multiplier extends range to 0 to 150 feet.

**TWELVE RECORDING SPEEDS** — pushbutton selectable speeds of .1, .4, .8, 1, 1.6, 4, 8, 10, 16, 40, 80, and 160 inches-per-second.

**TRACE IDENTIFICATION** — optical trace interruption and trace numbering.

**VIBRATION ISOLATION** — four isolator mounts on recorder and four on the drive motor/transmission assembly.

**GALVO LIGHT INTENSITY CONTROLS** — manual and automatic controls provide optimum trace quality for each galvanometer block.

**FILTERED AIR COOLING** — cools and pressurizes the optical module for maximum cleanliness.

**MODULE CONSTRUCTION** — all major modules removable as single assemblies.

For additional information on this outstanding new instrument, call your CEC sales and service office or write for Bulletin CEC 5133.

**CEC** Data Recorders Division

**CONSOLIDATED ELECTRODYNAMICS**

A Subsidiary of **Bell & Howell** • Pasadena, Calif. 91109  
International Subsidiaries: Woking, Surrey, England  
and Frankfurt/Main, Germany.

## 8 more reasons for buying CEC

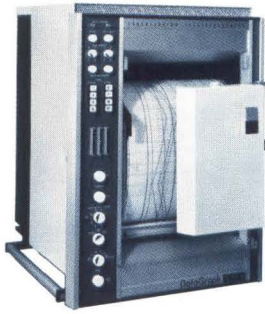

### DATAFLASH TRANSPORT

Rapid latensification is possible with the DATAFLASH Transport and lamp. Simultaneously, it applies heat and high actinic light to produce a latensified oscillogram at recording speeds to 16 ips. Data is available in less than one second after it occurs.



### HI-SPEED TRANSPORT

Standard print-out recording is accomplished by the Hi-Speed Transport providing 12 pushbutton selectable recording speeds from .1 to 160 ips. Latensification is accomplished by ambient room light (fluorescent) or the use of the Accessory Latensification Lamp Assembly.

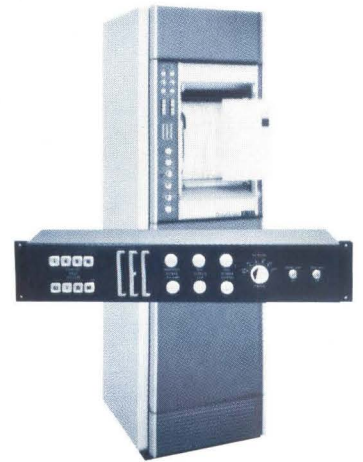

### REMOTE CONTROL UNIT

The Remote Control Unit provides operation of the 5-133 from distances up to 1000 feet. Complete remote control of all electrical functions is possible — including speed selection, power ON/OFF and recording lamp ON/OFF.

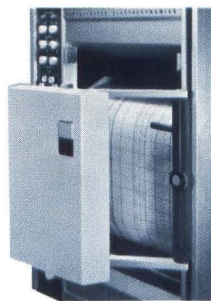

### LATENSIFICATION LAMP ASSEMBLY

The Latensification Lamp uses four 8-watt cool white fluorescent lamps to latensify slow-speed recordings on the Hi-Speed Transport. A readable record is immediately available up to 4 ips.



### AMBIENT LIGHT SHIELD

The Ambient Light Shield permits recording with no latensification, allowing the record to be chemically processed for maximum contrast needed for oscillograms of archival quality.



### TYPE 5-124 RECORDING OSCILLOGRAPH

A portable, low-cost oscillograph for print-out process recording. The 5-124 weighs only 40 lbs. and features pushbutton control with fast, easy loading. Uses standard CEC galvanometers and is available in 6-, 12-, or 18-trace types. Records are 7" wide. (Bulletin 5124)



### TYPE 1-162A GALVANOMETER DRIVER AMPLIFIER

CEC's Type 1-162A Galvanometer Driver Amplifier is a solid state, low-gain, wide-band D-C power amplifier designed to drive high frequency light beam galvanometers. Features include individual plug-in amplifiers, 1 to 7 channels per case. Separate input and output connectors. High maximum source impedance. Output zeroing control. Case can be portable or rack mounted. (Bulletin 1162)



### TYPE 1-155 D-C AMPLIFIER

The CEC Type 1-155 D-C Amplifier is a solid state, chopper-type, precision instrumentation amplifier designed to handle low-level, wide-band signals produced by grounded or ungrounded transducers. A single-ended design provides a greater degree of reliability than the more complex circuitry required by conventional differential amplifiers. Features include high-line isolation, wide-band frequency response, excellent linearity and low noise and drift. (Bulletin 1155)

**CEC** Data Recorders Division

**CONSOLIDATED ELECTRODYNAMICS**

A Subsidiary of Bell & Howell • Pasadena, Calif. 91109  
International Subsidiaries: Woking, Surrey, England  
and Frankfurt/Main, Germany.





WHAT RELIABILITY can do, said R. E. Kirby, of Westinghouse (left) is trade higher initial cost for lower maintenance cost. It won't advance state of the art, said D. C. Minton, Jr., of Battelle Memorial Institute (right), but it will help prove out existing states

## RELIABILITY OUTLOOK: Numerical Specs Soon

Military will set criteria for costs, too; industry acceptance is growing

By **WARREN KORNBERG**  
McGraw-Hill World News

**WASHINGTON** — It was evident last week at the Tenth National Symposium on Reliability and Quality Control that reliability concepts born in the electronics industry are coming of age.

The signs are broad acceptance in a range of industries, now growing to include consumer products as well as military and industrial, and a less defensive attitude on the part of reliability engineers. They absorbed last year's blasts at industrial unreliability by Vice Adm. Hyman G. Rickover and this year are seeking ways to tell the Defense Department and other customers that reliability is available—at a price.

With maintenance costs estimated as high as 1,200 percent of electronic equipment purchase price, the military is not only willing to pay more initially for reliability, but is beginning to set quantitative criteria for reliability and its costs. To help contractors meet the stiffer demands, pilot programs to rapidly disseminate reliability data are being set up.

**Maintenance Too Costly**—"What a false economy," said Westinghouse Engineering vice president R. E.

Kirby, "to buy a piece of equipment for \$1 million, which costs \$15 million over its useful life, as opposed to paying initially \$2 million for equipment which requires only \$5 million for its upkeep."

The cost of upkeep is beginning to disturb the Defense Department and it is coming to realize that reliability — with the attendant test, inspection and supervisory programs—will cost.

Maintenance costs on today's systems have risen to the point where they represent almost 30 percent of Air Force's budget (\$20 billion in fiscal 1963), Air Force Systems Command vice commander, Lt. Gen. Howell M. Estes, Jr., told the symposium.

Maintenance of some military electronics systems were estimated by K. A. Frederiksen, reliability assurance branch chief of Douglas Aircraft's Space Systems Center, to run between 60 percent and 1,200 percent of initial cost.

**Important in Contracting**—Industry and government spokesmen reject the proposition, still widely held however, that reliability is just a homely virtue that any craftsman or contractor worth his salt would deliver.

As cost-plus-fixed-fee aerospace contracts in the last year have dropped from 38 to 22.7 percent of all procurement contracts, in favor of cost-plus-incentive-fee contracts, interest in criteria for incentives and



## Hanover Fair

*Market Place for World Trade*

The Hanover Fair 1964 will have 5500 exhibitors located in 24 buildings and a total display area of 6,372,000 sq.ft.

The Hanover Fair displays materials, equipment and machinery from 25 countries for 10 days each year.

The Hanover Fair exhibits are arranged strictly according to product category—convenient, timesaving.

The Hanover Fair is a place for market analysis and direct sales negotiations.

The Hanover Fair is the world's largest international trade fair.

The Hanover Fair is many things. A visit will be a profitable one.

**April 26-May 5**  
**Hanover, Germany**

For information, room reservation forms and tickets, phone 212-JU 2-7788 or write:

**GERMAN AMERICAN  
CHAMBER OF COMMERCE**  
New York: 666 Fifth Avenue  
Chicago: 77 East Monroe St.

# Dunco REED LOGIC

... 1/2 the size  
1/10 the cost of  
solid state logic

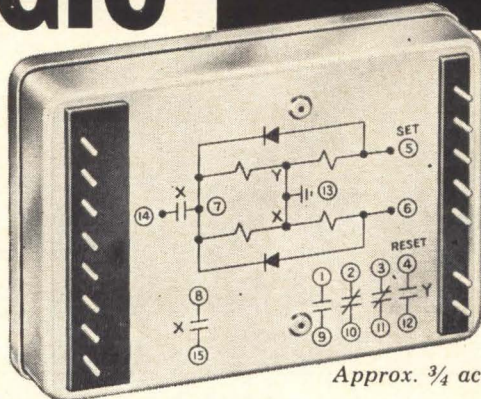

Approx. 3/4 actual size

**High speed ... long life reliability ... for ...**

- △ flip-flops
- △ binary counters
- △ binary-to-digital converters
- △ shift registers
- △ ring counters
- △ bi-directional counters
- △ read-out circuits

... or as part of your present project.

They're metal-encased, magnetically-shielded, epoxy-encapsulated ... for printed circuit mounting ... with electrical or magnetic latching action as required ... contact ratings from low level to 4 VA or 15 VA. For details, write for Dunco Reed Relay Logic Modules Bulletin LB-1A, to: STRUTHERS-DUNN, Inc., Pitman, New Jersey.

## STRUTHERS-DUNN

5,348 Relay Types

Member, National Association of Relay Manufacturers



SALES ENGINEERING OFFICES IN: Atlanta • Boston • Buffalo • Charlotte • Cincinnati • Cleveland • Dallas • Dayton • Encino • Englewood • Houston • Kansas City • Las Vegas • Memphis • Newark • New York • Orlando • Pittsburgh • St. Louis • Salt Lake City • San Antonio • San Diego • San Mateo • Scottsdale • Seattle • Southfield • Wichita • Wilmette, Canadian Licensee: Renfrew Electric Co., Ltd., Toronto. Export Department: 1505 Race St., Philadelphia 2, Pennsylvania, U.S.A.

penalties in the contracts have come under more intensive review. Incentive contracts rose from \$4.2 billion to \$7.3 billion during fiscal 1963.

"Reliability," says Gen. Estes, "is almost inseparable from any measure of contractor performance."

Future government development and procurement contracts are almost certain to contain more and more specific and more and more demanding reliability requirements. While the customer now is seeking ways to identify and specify reliability levels, the supplier is seeking ways to price them.

Gen. Estes' promise that "Air Force is going to specify mean times to failure in future contracts" is an approach at one end.

The policy may take two to three years to implement fully, he said, since existing follow-on contracts will have to be let on existing criteria. He agrees that identified levels of reliability must have identified prices.

Gen. Estes proposes a contractor data bank, where past contractor performance in achieved product reliability levels may well determine a contractor's future relationships with the government.

**Establishing Criteria**—R. O. Lyons of the Office of the Assistant Secretary of Defense for Installations and Logistics noted, "We've done a lot of talking, but there's still a lot of work to develop the concept to a point where we can talk contractually about reliability."

This involves principally, said Gen. Estes, establishing objective quantitative criteria for reliability requirements. Air Force, he said, is considering expanding its own proof-testing establishment as well as requiring of contractors specific mean times to failure at all levels up through subsystems.

"At systems levels," he said, "studies are being conducted of the value of developing success/failure ratios based on double or triple the present number of tests."

**Reliability Data Net** — Gen. Estes cited two new developments to help contractors meet more stringent demands.

A parts data bank, built initially around the substantial reliability of parts employed in the Minuteman



AIR FORCE Lt. Gen. H. M. Estes, Jr., says demands on contractors will become more specific

program, is being established so contractors can have access to parts of proven performance.

Guaranteed (100-percent) reliability, said Vice President D. C. Minton, Jr., of Battelle Memorial Institute, is probably most accessible with common, production-line, off the shelf components. He denied that reliability emphasis will advance any state of the art, but it will act to prove out existing states, while permitting contractors to work to the limits of existing technology.

Gen. Estes also cited the new Reliability Central, a communications net, being tested with a few contractors at Wright Patterson Air Force Base.

Programs in the past have gone as long as 18 months with unsatisfactory components, he said, despite the fact that somewhere in industry the proneness to failure of the component was known. By urging improved reporting of such data, he said Air Force has reduced the time lag to two months. "We are after a response time of 24 hours on this and other types of reliability information."

Reliability Central, possibly eventually tied into Defense Documentation Center, will expect to receive and store all data on faulty parts for rapid dissemination to interested contractors.

**Management Acceptance**—New reliability techniques were less a feature of this year's symposium than in the past. The greatest growth in the last year, said several military and industry sponsors of the symposium, is management acceptance of the need for reliability in the table of organization.

Reliability specialists, once gen-

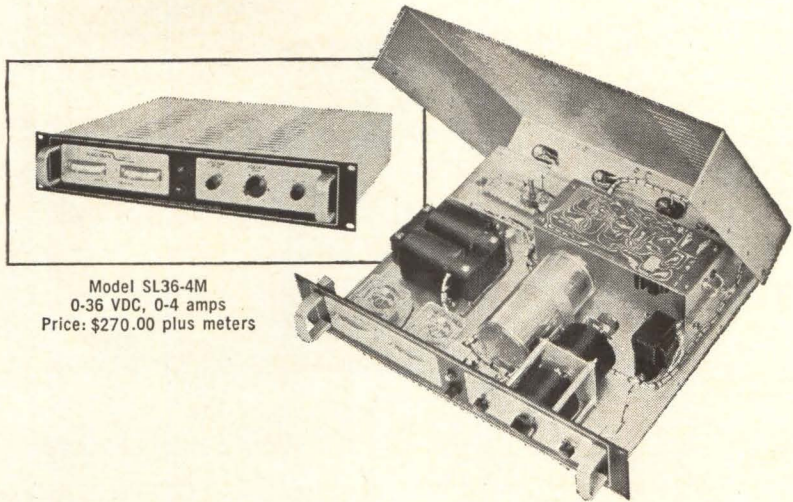

Model SL36-4M  
0-36 VDC, 0-4 amps  
Price: \$270.00 plus meters

## All new, low cost, All-Silicon Magitran® "SL" variable power supplies for systems applications.

The new Magitran "SL" series provides the high stability, high temperature operation and other benefits of silicon power supplies at costs lower than most available germanium equivalents. These all-new ERA units have been specially designed and priced for systems applications. The use of optional current and voltage meters makes them suitable for general laboratory applications as well. This flexibility plus exceptionally low prices makes these Magitran units your *best buy* in high current variable power supplies. *Write today for new literature.*

### SPECIFICATIONS

Input Voltage Range: 105-125 VAC  
Input Frequency Range: 50-400 cps  
Regulation Line:  $\pm 0.01\%$  or 5 mv  
Regulation Load: 0.05% or 8 mv  
Long Term Stability: Less than 8 mv, constant line, load and temperature  
Ripple: Less than 1 mv, RMS  
Transient Response: Less than 50  $\mu$ sec  
Operating Temperature:  $-20^{\circ}\text{C}$  to  $+65^{\circ}\text{C}$   
Temperature Coefficient:  $0.01\%/^{\circ}\text{C}$  or 2 mv

Short Circuit Protection with automatic recovery  
Automatic Overload Recovery  
Remote Sensing  
Parallel and Series Operation  
Vernier Voltage Control  
Output Terminals (Ungrounded): Location, rear  
Reverse Voltage Protection  
Cooling: Convection

MODEL	VOLTAGE VDC	CURRENT	PANEL SIZE	PRICE
SL36-2	0-36 VDC	0-2 amps	3 1/2" x 9 1/2"	\$215.
SL36-2/2	0-36 VDC Dual	0-2 amps Dual	3 1/2" x 19"	415.
SL36-4	0-36 VDC	0-4 amps	3 1/2" x 19"	270.
SL36-8	0-36 VDC	0-8 amps	5 1/4" x 19"	335.
SL36-12	0-36 VDC	0-12 amps	7" x 19"	435.

Note: Add \$30.00 and suffix M for current and voltage meters. (Model SL36-2/2 add \$60.00)



Also DC Power Modules, Inverters, Converters, Frequency Changers, Special Test Equipment.

**ELECTRONIC RESEARCH ASSOCIATES, INC.**

DEPT. E-1, 67 FACTORY PLACE • CEDAR GROVE, N. J. • (201) CENTER 9-3000

SUBSIDIARIES: ERA Electric Co. • Advanced Acoustics Co. • ERA Dynamics Corp. • ERA Pacific, Inc.

## sync performance plus 83 gear ratios for commercial and industrial projects

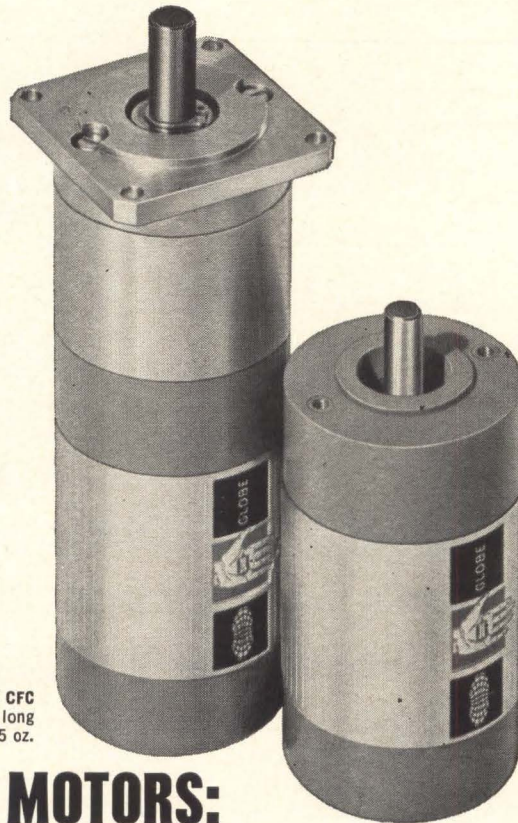

**TYPE CFC**  
Motor: 1 $\frac{1}{2}$ " dia. x 2 $\frac{1}{4}$ " long  
weight 13.5 oz.

## NEW A.C. MOTORS: 94 FEATURES: SURPRISE!

Put this new low cost precision industrial motor into your project, get unprecedented torque, and eliminate bulky older-style motors. Gain performance, longer life and save space while you save money, too! Type CFC is a rugged constant speed hysteresis synchronous capacitor motor with MIL spec ancestry, 115 v.a.c., 2 or 4 pole, 60 cps with other frequencies wound on order, 1 or 3-phase. Motors produce 1.25 oz. in. torque at 3600 rpm sync speed, 2.0 oz. in. at 1800 rpm sync speed. Life-lubed ball bearings, grease-lubed geartrain, high starting torque, totally enclosed motor, and instant reversing are standard. Induction rotors and a variety of windings are available. Integral planetary geartrains provide choice of 83 standard ratios, to 60 lb. in. continuous torque. Standard geared speeds range from 900 rpm down to 0.1 rpm. Quantity production makes this high quality motor very competitively priced. This is a designer's motor. Request Bulletin CFC. Globe Industries, Inc., 1784 Stanley Ave. Dayton, Ohio 45404. Area 513 222-3741.



**GLOBE**

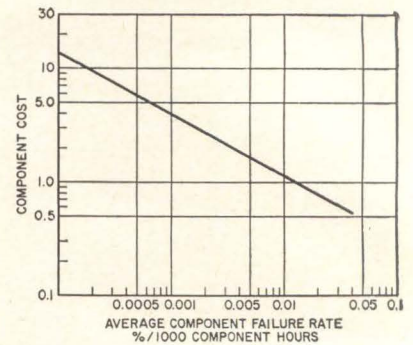

AVERAGE FAILURE rate indicates relationship between reliability and cost on this Bell Telephone Labs chart. Reliability people are seeking formulas on which to base contractor incentives

erally responsible to production engineers who resisted interruption of their schedules, are now coming into their own directly under the wings of plant managers, with whose authority they can interrupt production schedules in the interest of reliability and product performance.

This was generally true in a group of corporations polled, at the symposium including Sylvania, Martin, Westinghouse, Royal McBee and Lockheed. Generally, too, it was a recent development.

Sylvania, according to an official, feels it has a first in introducing reliability indoctrination at the production-line level. And several companies in industries ranging from electronics to typewriter manufacture are including reliability performance along with output in their incentive and award programs.

**Other Industries** — H. E. Chesebrough, Vice President of Chrysler Corp., cited communications advances as one means employed of insuring the quality of its automobiles, in line with the reliability levels necessary to make the recent 5-year, 50,000-mile warranties workable.

Chrysler, Chesebrough said, is currently preparing a random-access computer into which complete service and maintenance information on every automobile sold will be fed, for complete records of performance, reliability and maintenance requirements.

Other consumer product firms which reported applying reliability techniques included Underwood, Royal McBee, Winchester-Western (Gun) Division of Olin Mathieson, and Xerox.

# **new** Allen-Bradley Type JJV Hot Molded Variable Resistors with "built-in" vernier

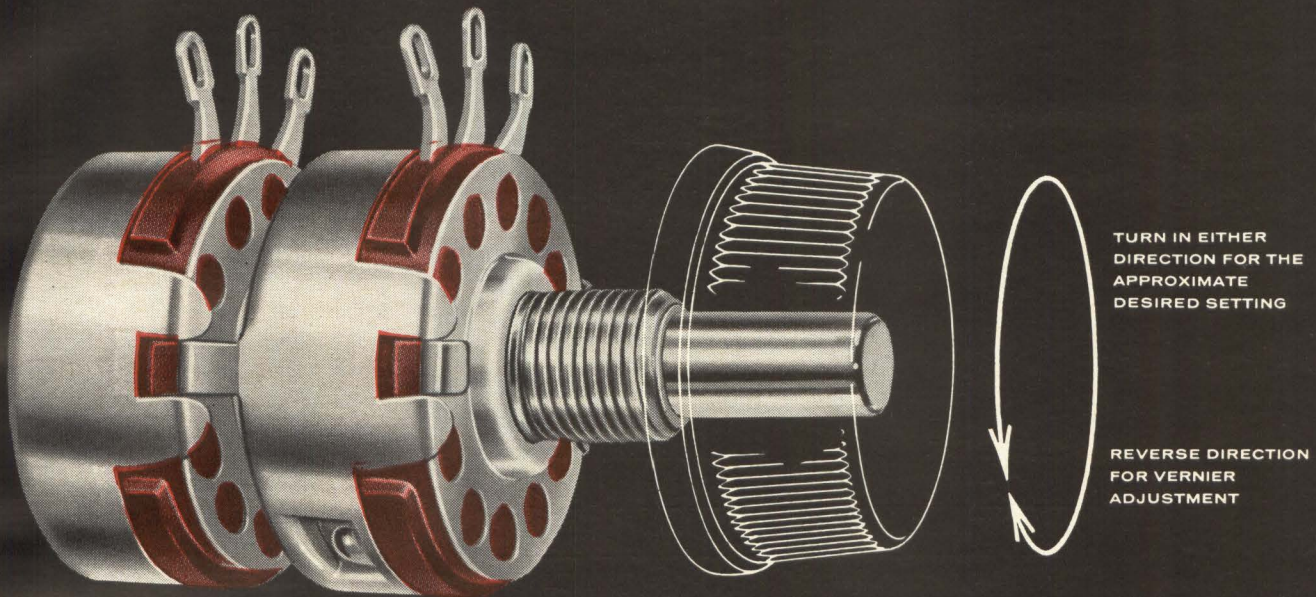

TYPE JJV VERNIER CONTROL  
Shown Twice Actual Size

TURN IN EITHER  
DIRECTION FOR THE  
APPROXIMATE  
DESIRED SETTING

REVERSE DIRECTION  
FOR VERNIER  
ADJUSTMENT

**TURN ONE KNOB**—you obtain both the approximate setting and the fine resistance adjustments . . . *in the panel space of only one control.* A unique coupling arrangement allows the approximate setting to "idle" when the operator is making the vernier adjustment. More than 12% of total rotation is available for the independent vernier adjustment, thus providing up to 20 times better resolution than is obtainable with a single element control.

**VERSATILE**—All standard tapers and resistances are available to satisfy virtually any control requirement. Can be used as a rheostat or as a modified potentiometer in a three or four terminal circuit. A triple control, having two units locked together with the third unit

providing the vernier adjustment, is available where true potentiometer circuitry is required.

**FAMOUS TYPE J PERFORMANCE**—The exclusive hot molded resistance element with its built-in stability is a guarantee of long operating life and having a low initial noise level, which is further improved with use. The control is always smooth and during adjustment is completely free of sudden changes or "steps."

Try this new Type JJV control—surprise yourself with the vernier resistance adjustment that is obtainable over a wide range. Allen-Bradley Co., 110 W. Greenfield Ave., Milwaukee, Wis. 53204. In Canada: Allen-Bradley Canada Ltd., Galt, Ont.

## ALLEN-BRADLEY TYPE J HOT MOLDED VARIABLE RESISTORS

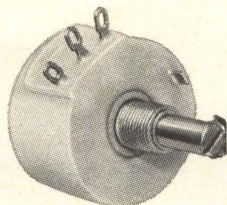

Type J  
with encapsulation

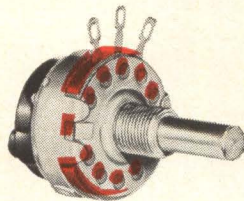

Type JS  
with line switch

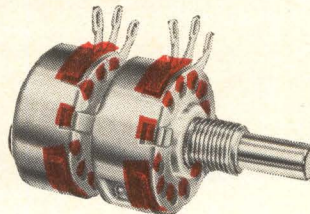

Type JJ  
standard dual unit

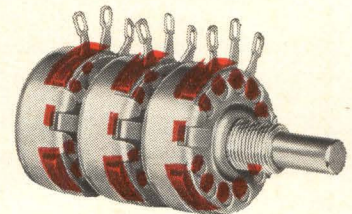

Type JJJ  
standard triple unit



# ALLEN-BRADLEY

QUALITY ELECTRONIC COMPONENTS

# Vacuum-melted alloys for glass hermetic seals



**RODAR<sup>®</sup>**  
**NIRON<sup>®</sup> 52**  
**NIROMET<sup>®</sup> 46**

Specified Industry-wide for

**PERMANENTLY-BONDED  
VACUUM-TIGHT SEALS!**

## Thermal Expansion

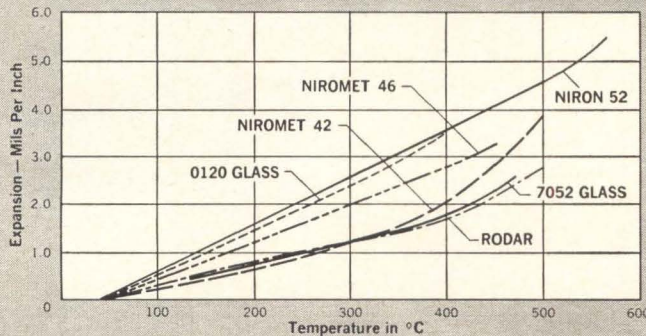

### RODAR<sup>®</sup>

**NOMINAL ANALYSIS: 29% Nickel, 17% Cobalt, 0.3% Manganese, Balance—Iron**

Rodar matches the expansivity of thermal shock resistant glasses, such as Corning 7052 and 7040. Rodar produces a permanent vacuum-tight seal with simple oxidation procedure, and resists attack by mercury. Available in bar, rod, wire, and strip to customers' specifications.

Temperature Range	Average Thermal Expansion °cm/cm/°Cx10 <sup>-7</sup>
30° To 200°C.	43.3 To 53.0
30 300	44.1 51.7
30 400	45.4 50.8
30 450	50.3 53.7
30 500	57.1 62.1

**COEFFICIENT OF LINEAR EXPANSION**  
\*As determined from cooling curves, after annealing in hydrogen for one hour at 900° C. and for 15 minutes at 1100° C.

### NIRON<sup>®</sup> 52

**NOMINAL ANALYSIS: 51% Nickel, Balance—Iron**  
For glass-to-metal seals with Corning #0120 glass.

### NIROMET<sup>®</sup> 46

**NOMINAL ANALYSIS: 46% Nickel, Balance—Iron**  
For vitreous enameled resistor terminal leads.

### NIROMET<sup>®</sup> 42

**NOMINAL ANALYSIS: 42% Nickel, Balance—Iron**  
For glass-to-metal seals with GE #1075 glass.

### CERAMVAR

**NOMINAL ANALYSIS: 27% Nickel, 25% Cobalt, Balance—Iron**  
For high alumina ceramic-to-metal seals.

Call or write for Sealing Alloy Bulletin

**WILBUR B. DRIVER CO.**  
NEWARK 4, NEW JERSEY, U.S.A.

IN CANADA: Canadian Wilbur B. Driver Company, Ltd.  
50 Ronson Drive, Rexdale (Toronto)

Precision Electrical, Electronic, Mechanical and Chemical Alloys for All Requirements

## 10-Mw Radar Ready For Missile Studies

AMRAD's first job will be getting reentry data for terminal defenses

AT WHITE SANDS Missile Range, N. M., last week, one of the world's most powerful radar systems was turned over to MIT Lincoln Laboratory for the study of missile reentry signatures.

Among principal features of AMRAD's superpower klystron transmitter is a unique waveform developed specifically for reentry measurements. Designed for a peak output power of 10 megawatts, AMRAD uses a 60-foot antenna for pencil-beam tracking of reentering missiles and acquisition of cross-section and doppler measurements.

AMRAD (Arpat Measurements Radar) was developed by Raytheon Company for the Advanced Research Projects Agency, under an Army Missile Command contract. Arpat, the study of terminal defense against ballistic missiles, is part of Project Defender, a series of possible missile defense concepts.

**Other Roles for AMRAD?**—It is believed that the powerful radar will also be used for interception experiments and electronic countermeasures designed to deceive the very same radar techniques embodied in AMRAD.

In addition to cross-section and doppler measurements, AMRAD will be employed to measure side views of reentry vehicles and radar enhancement resulting from ioniza-



60-FOOT ANTENNA provides pencil beam for tracking reentering missiles

tion heating during reentry.

The radar's prime mission is to obtain basic reentry physics measurements of ballistic missiles. Thus it will supplement two other facets of Lincoln Laboratory's work in defense against ballistic missiles: the reentry physics studies underway at Wallops Island with powered reentry rockets; and technical management of Project Press (Pacific Range Electromagnetic Signature Studies).

### Small Antenna Plugs In Isolated Areas to Syncom

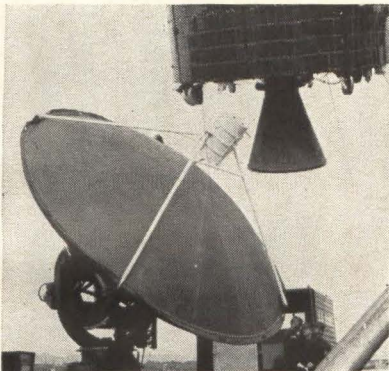

ANTENNA is air-inflated

SMALL, TRANSPORTABLE ground terminal for the Syncom communications satellite is now being tested by the Army Satellite Communications Agency. The demonstration model, built by Hughes, consists of three units: a 15-foot antenna, communications hut 6 by 8 feet, and power supply. The 5-ton system will transmit and receive telephone, teletypewriter and facsimile.

Transmitter is a solid-state, liquid-cooled unit using a klystron converter tube with a power output of 2 or 3 kw. Excess noise temperature of the parametric amplifier is 100 deg; it is uncooled, and has two-stage 40-db gain. The receiver is a phase-locked f-m tracking receiver with two i-f bandwidths in the 30- and 10-kc bandwidths, and has an i-f frequency of 30 Mc.

### British Pick Manager For Polaris Navigation

GREAT NECK, N.Y.—Management of the design, manufacture and installation of navigation systems for Brit-

**Acme**  **Electric**

**KNOWS HOW TO**

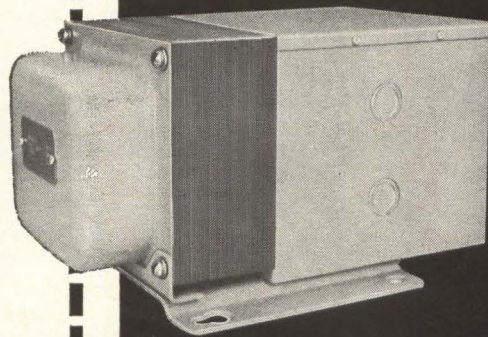

**MAKE LINE VOLTAGE BEHAVE!**

With an Acme Electric Voltage Stabilizer connected to the supply circuit, output voltage becomes precisely constant regardless of line voltage fluctuation or changes in the load.

Voltage regulation is practically instantaneous with response to either undervoltage or overvoltage variation occurring in approximately 25 milliseconds. Stabilization is held within 1% over a range of 15% line voltage variation.

Improved circuitry provides a high degree of wave-form fidelity. Protected automatically against overload or short circuit by its current limiting design. Sturdily constructed, no moving parts, practically no maintenance.

**A STANDARD DESIGN FOR EVERY APPLICATION**

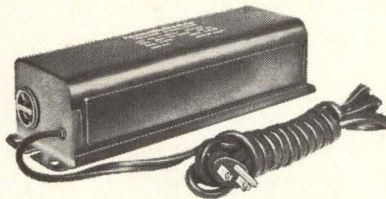

Dependable, approved designs are available in ratings from 15 VA to 5 KVA. Secondary voltage outputs of 6.3; 120; 240; 480 volts.

SAA-3740-3055

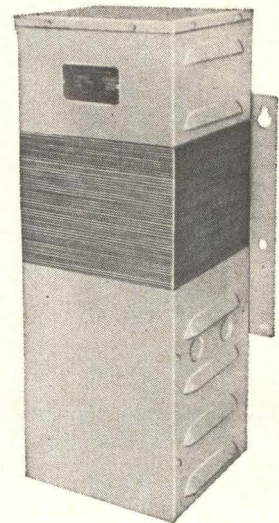

**Acme**  **Electric**

**Engineers and Builders of...**

311 WATER STREET, CUBA, NEW YORK

In Canada: Acme Electric Corp. Ltd.  
50 Northline Rd., Toronto, Ont.

REGULATED POWER SUPPLIES  
STATIC POWER RECTIFIERS  
VOLTAGE STABILIZERS  
VOLTAGE REGULATORS

# Standard 0-50 mv output from resistance temperature sensors

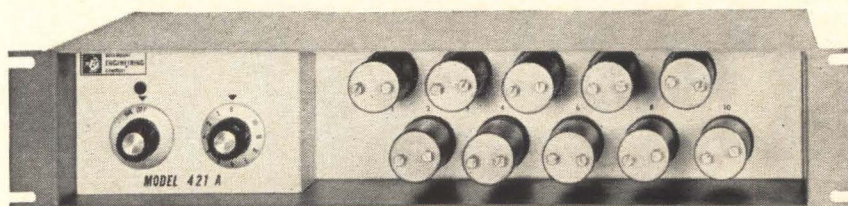

## REC's new resistance bridge system

The REC resistance bridge system provides a convenient, ready-made link between resistance temperature sensors and any standard recorder, indicator, controller or computer.

It converts the variable resistance of the sensor to a standard 0 to 50 millivolt output signal for any temperature range—calibrated to an accuracy of 0.1 per cent of span. The high signal level is ideal for computer applications. The Kelvin double bridge modification of the conventional Wheatstone bridge increases accuracy by suppressing errors due to variations in lead wire resistance.

Model 400 resistance bridges are plug-in modules. Stock units for standard ranges are matched to REC platinum sensors. Models are available to match other sensors, to provide special temperature ranges or outputs, and for differential temperature measurement.

Model 410 (single) and 420 (multi-channel) bridge chassis accommodate the plug-in bridges. They incorporate a solid state, regulated 10 volt dc power supply operating from 115 volt ac sources. Mounting can be panel, bench or standard relay rack.

Write for Bulletin 7632.

### A complete precision line

Rosemount Engineering Company designs and manufactures high quality precision equipment in these lines:

- |   |   |
|---|---|
| Air data sensors                                    | Surface temperature sensors                   |
| Total temperature                                   | Pressure sensors                              |
| Pitot-static tubes (de-iced)                        | Accessory equipment and aeronautical research |
| Immersion temperature sensors (including cryogenic) |   |

For more information please write for the REC catalog. Specific questions on any temperature or pressure problems are welcomed.



**ROSEMOUNT ENGINEERING COMPANY**

4900 West 78th Street • Minneapolis 24, Minn.

**SPECIALISTS IN TEMPERATURE & PRESSURE MEASUREMENT**

ain's four nuclear-powered Polaris submarines will be handled by Sperry Gyroscope, it was announced last week. Initial contract award totaled \$4,325,000. Final amount is expected to hit \$10 million. Sub-contractors will be selected from both British and U. S. firms.

Great Britain will build the submarines, their atomic power plants and the missiles' nuclear warheads. The missiles, fire control systems and navigation systems will be bought from the U. S. First submarine is expected to be operational in five years.

Main elements of the navigation system include SINS (Ship's Inertial Navigation System) which have been built by both Sperry and North American's Autonetics for the U. S. ships; Navdac computer, built by Sperry; navigation control console, built by Sperry; star tracking periscope; a sonar bottom profiler for map making; and radio aids.

Sperry will produce the radio navigation gear, navigation data assimilation computers, navigation control consoles, checkout consoles, and high-speed repeater units that transfer navigation data to the missile fire control system.

The Mk 84 fire control system (ELECTRONICS, p 61, Oct. 25, 1963) will be built by General Electric's Ordnance department, Pittsfield, Mass.

### British Chop Price of General-Purpose Computer

LONDON—Basic price of the National-Elliott 803 computer has been chopped by nearly 25 percent from \$81,200 to \$61,600. The price cut was credited to savings in components and manufacturing.

Elliott-Automation makes and markets the 803 for use in scientific research and on-line control. National Cash Register Electronics markets it for data processing.

Some 180 have been sold in four years. More than half the production has been for export markets. Ten percent went to the U. S. where the 803 is marketed by Information Systems Inc.

The price of peripheral equipment was similarly trimmed.



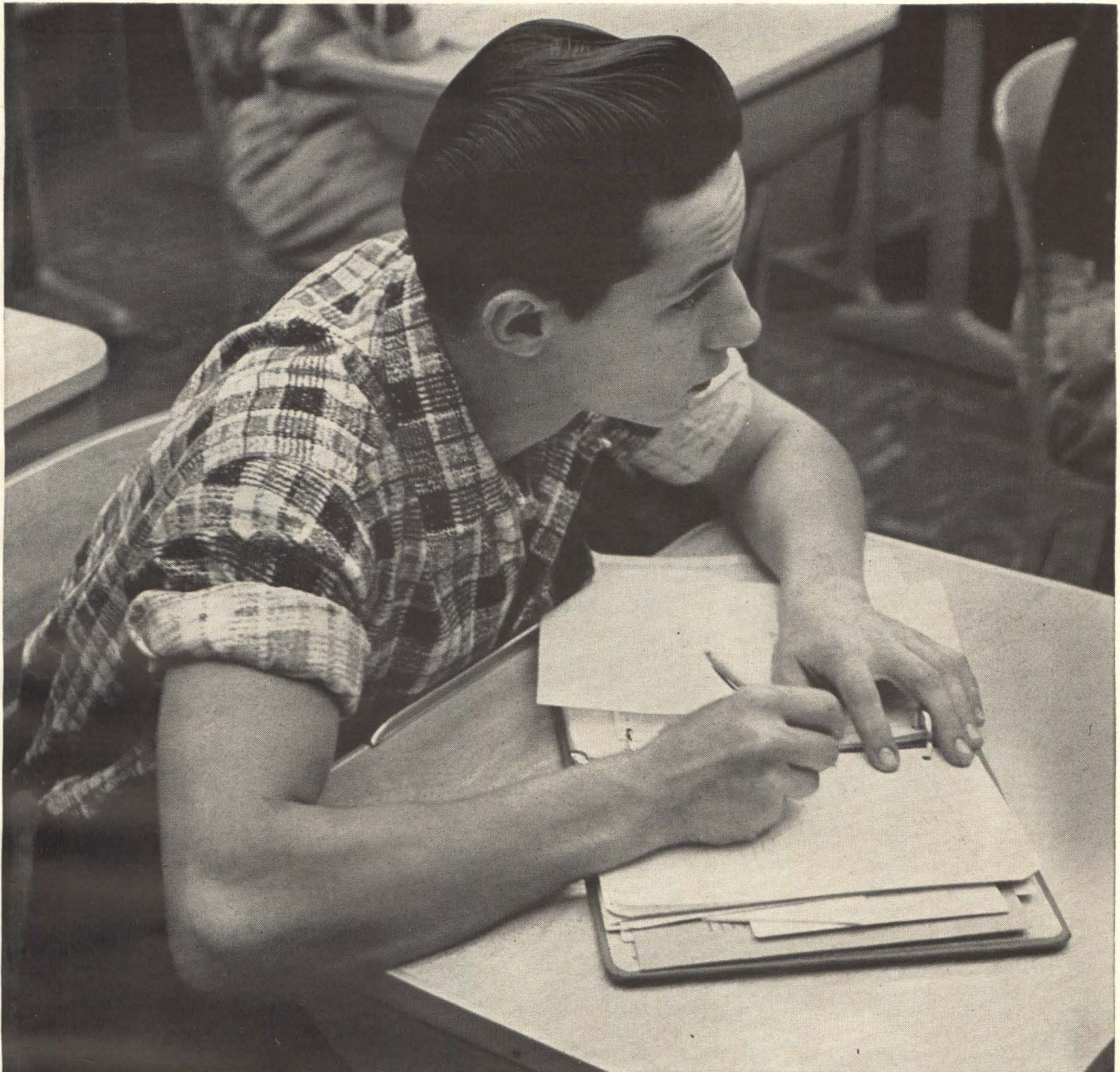

## Investment Opportunity

The tools this young apprentice is learning to make will one day be used to turn out your company's products.

A great investment in time, money, effort and faith will have to go into making him productive. Every one of us has a stake in his success—and every one of us must invest something—for on the developing skills of America's young tool-makers depends the continued functioning of all industries.

You can protect your investment by joining with other leading American businessmen to promote the Treasury's Payroll Savings Plan for U.S. Savings Bonds. The Treasury Department's Plan helps safeguard the individ-

ual liberties, and encourages the industrious and responsible attitudes so necessary for the growth of our economy and the well-being of our society.

When you bring the Payroll Savings Plan into your plant—*when you encourage your employees to enroll*—you are investing in the next generation of America's skilled craftsmen and technicians. You are investing in our future. In freedom itself.

Don't pass this investment opportunity by. Call your State Savings Bonds Director. Or write today to the Treasury Department, United States Savings Bonds Division, Washington, D.C., 20226.



**in your plant...promote the PAYROLL SAVINGS PLAN for U.S. SAVINGS BONDS**



# New Lasers Chemically Pumped

Chemical pumping yields lighter lasers—continuous action may be possible

**CHEMICALLY PUMPED LASERS** offer promise of higher energy-weight ratios than conventional lasers. Chemical pumping eliminates electrical power supply, capacitor bank, and pulse circuits. For example, a 40-lb chemically-pumped laser could equal or exceed the energy output of a present-day 1,000-lb laser, according to a North American Aviation scientist.

There are two basic methods for chemically pumping a laser, both under vigorous pursuit by research scientists: by using the light given off by a chemical reaction, or by using the shock wave of an explosion to generate light in a flash tube, which then triggers the laser.

The quest is for higher color temperatures, higher efficiency, and matching the chemical light output to the necessary triggering wavelengths. Present chemical lasers have already achieved very high brightness levels considering the very small quantities of chemicals used (typically, 100 mg at Picatinny).

**North American** — Chemically-pumped laser light (Fig. 1) has been produced by exploding chemical powders in research at the Los Angeles Division of North American Aviation (ELECTRONICS, Dec. 13, 64, p 17). Resultant pulse-type lasers yield high energy, and are portable. They also have a potential for continuous laser action, according to John Pierro, principal scientists on the project. Reduction of laser weight was the motivation behind the work, begun in November, 1962.

Frequency range of the lasers in the optimum absorption band is 5,000 to 9,000 Å using a neodymium-glass rod measuring  $\frac{1}{4}$  in. dia. by

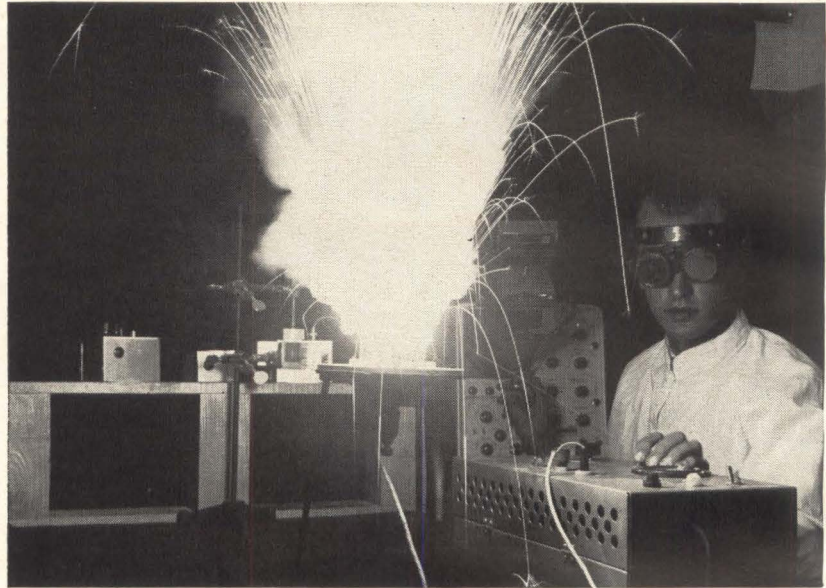

SPARKS FLY in all directions as research engineer at North American Aviation checks light output of chemical reaction—Fig. 1

2 in. In the beginning, 3,500 K-4,000 K temperatures were achieved using aluminum and sodium perchlorate. Temperatures up to 5,500 K-6,000 K were later recorded with combinations of other metals and oxygen. Temperatures of 7,000 K-9,000 K are considered possible, with an auxiliary energy converter.

Once the feasibility of the experiment had been established, efficiency was increased and higher absorption region temperatures developed. Dopants in the chemical mixture shift energy to that region of the spectrum where it is used. Wasted energy, pumped to the desired absorption band, helps achieve a chemical reaction giving off light enhanced in the absorption band of the neodymium or ruby laser rod. Figure 2 shows the test setup used by North American.

**Picatinny Arsenal** — Successful pumping of lasers by pyrotechnic reactions has been reported by S. Sage, C. L. Smith and P. J. Kisatsky. Brightnesses of the order of 4,300 deg K have been achieved with calcium tungstenate doped with neo-

dymium; using zirconium/potassium perchlorate squibs for pumping. Further work, using fuels such as thorium, is expected to result in even higher black-body temperatures. Brightness temperatures for some of the materials tested at Picatinny Arsenal are given in the Table, p. 50.

**Squibs**—The peak brightness of unmodified squibs was approximately 3,700 deg K. Brightness was increased to an average over 4,000 deg K by sealing the squib in a piece of steel with a  $\frac{1}{4}$ -inch sheet of Lucite that both confined the

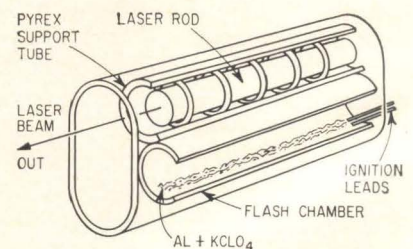

CONFIGURATION first lased by North American scientists in December 1962; a  $\frac{1}{4}$ -inch by 2-inch neodymium glass rod was used—Fig. 2

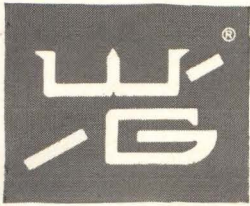

# Produces the most complete line of Optical Shaft-Angle Encoders

## DIGISEC® Highest Accuracy Direct Reading Encoders . . . .

Patents Pending



### 1 Arcsecond, Peak and Better

DIGISEC achieves highest accuracy in small case sizes with direct reading, continuous outputs — without code conversion, gears, brushes or reference rotor.

Optical Unit Diameter	Resolution
2.25"	to 40 arcseconds
3.5"	to 10 arcseconds
5.5"	to 2 arcseconds
10"	to 1 arcsecond

Outputs available in decimal or natural binary codes. Accuracy is  $\pm 1$  quantum, peak. For example a  $2^{20}$  DIGISEC provides resolution of 1.24 arcseconds and accuracy of  $\pm 1.24$  arcseconds, peak. Complete system consists of Optical Unit and Translator containing electronics and display. The standard Translator weighs 15 lbs., is 6.5" x 17" x 7.5", and can be miniaturized. Total input power for standard system is 30 watts. Bulletin 6310-1.

## ARCSEC™ Highest Accuracy Incremental Encoders

Similar to DIGISEC Encoders in resolution, accuracy and size of Optical Unit, but providing incremental output with reduced electronic complexity. Available with direction sensing and zero reset signal. Bulletin 6310-1.

## DIGISYN® Direct Reading Encoders for tracking, navigation, sampled data servos, indexing and positioning systems, and other readout applications.

### CYCLIC CODE

$2^{10}$  to  $2^{15}$  Digits  
Case Diameter: 3.5"  
Bulletin 760-1C

(photo: RD-15)



### CYCLIC CODE

$2^{16}$  to  $2^{17}$  Digits  
Case Diameter: 10"  
Bulletin 162-1

(photo: RD-17)



### NATURAL BINARY

$2^5$  to  $2^{17}$  Digits  
Case Diameters: 2.625" to 10"  
Bulletin 6302-2

(photo: NB-10)



## DIGITAK® Incremental Encoders for rate measurement, angle counting, machine control, inertial platform systems — available with direction sensing and zero reset signal.

### MINIATURE SYNCHROMOUNT

$2^{10}$  to  $2^{12}$  Digits  
Case Diameter: 1.437"  
Bulletin 6212-1

(photo: RI-12M)



### STANDARD SYNCHROMOUNT

$2^{13}$  to  $2^{15}$  Digits  
Case Diameter: 3.5"  
Bulletin 861-1C

(photo: RI-20K)



### PANCAKE

$2^{13}$  to  $2^{15}$  Digits  
Case Diameter: 3.5"  
Bulletin 862-2

(photo: RI-15S)



Special encoders can be designed to meet particular requirements. Available accessories include Power Supplies and Test and Display Sets. Other Wayne-George products include inertial test systems and fluid bearings.



# WAYNE-GEORGE CORPORATION

322 NEEDHAM STREET, NEWTON 64, MASSACHUSETTS (617) 969-7300

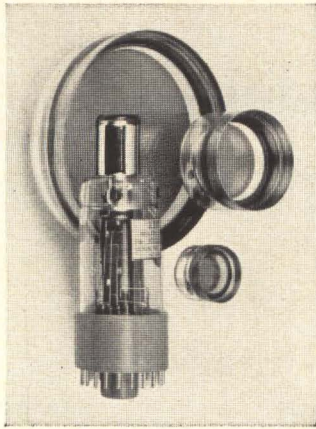

To: ITT INDUSTRIAL LABORATORIES  
 Dept. 61200  
 3700 East Pontiac Street  
 Fort Wayne, Indiana

Please send me additional information on  
 multiplier phototubes,  biplanar photodiodes. The application I have in mind is:

\_\_\_\_\_

NAME \_\_\_\_\_

TITLE \_\_\_\_\_

COMPANY \_\_\_\_\_

ADDRESS \_\_\_\_\_

CITY \_\_\_\_\_ ZONE \_\_\_\_\_ STATE \_\_\_\_\_

**This coupon  
 will bring you data on  
 LASER DETECTORS  
 with single photoelectron sensitivity**

**Deflectable multiplier phototubes with single photoelectron sensitivity; diode phototubes with half nanosecond response and current-carrying capacities linear from one-billionth amp to 50 amps.**

Characteristics like these—so vital in laser research—are available today in the new ITT line of multiplier phototubes and biplanar photodiodes. These devices, covering the entire spectrum from infrared to far ultraviolet, have pulse-counting characteristics and signal-to-noise ratios superior to any other tube or device now available.

ITT photomultipliers have a response range from dc to approximately 100 Mc, a sensitivity extending down to  $10^{-17}$  watts, a capability of detecting single photoelectrons, and magnetic deflection for alignment and tracking purposes.

ITT biplanar photodiodes cover a tremendous dynamic range of currents from  $10^{-9}$  amps to 50 amps. Their extremely short transit time of less than  $\frac{1}{2}$  nanosecond makes possible very high frequency response.

If you are working on the fundamental properties of laser radiation or investigating new laser applications, look into ITT's new line of photo detectors. Send in above for complete specifications. ITT Industrial Laboratories, a division of International Telephone and Telegraph Corporation, Dept. 61200, 3700 East Pontiac St., Fort Wayne, Ind.



**Brightness Temperatures of Various Pyrotechnic Compositions TABLE**

Composition	Brightness Temperature deg K
PETN/Barium Nitrate (78/22).....	4,300
PETN Control.....	4,000
Flash Bulbs, commercial.	3,800
Zirconium/Potassium Perchlorate (57/43) unconfined.....	3,700
Zirconium/Potassium Perchlorate (57/43) confined.....	4,800-5,000
Xenon Lamp XF 100 (20 $\mu$ f, 1,400 volts).	8,000
M-48 (Fired into conical hole).....	7,000
Laser Activating Grid (Zirconium/Potassium) Perchlorate (57/43) 400 mg....	4,200

gasses and acted as a window. With gaskets added, the maximum brightness was about 4,900 deg. K.

**Cylindrical Matrix**—One configuration considered promising by the Picatinny researchers is a cylindrical matrix of bridge wires, 44 to the inch, coated with pyrotechnic material (Fig. 3). This configuration was designed to improve simultaneity of burning by multiple ignition. The first trial, using a planar matrix, resulted in a brightness of 4,200 deg K at the center of the burning area, but higher temperatures are considered probable.

A promising approach for producing higher temperatures—in excess of 5,000 deg K—has been the use of pure-metal-and-oxygen reactions, using pressurized oxygen, triggered by an electric spark.

**Stanford Research Institute**—Basic approach used at SRI was to place a shaped charge under a box with mirrored sides and one transparent end (Fig. 4). The box was filled with one of the noble gases at atmospheric pressure—in this case argon. The argon output is rich in the shorter wavelengths required to get laser action in terbium and neodymium glass. Xenon flash tubes, commonly used to flash ruby laser crystals, have an equivalent temperature of 5-10,000 deg K. Equivalent temperature of the argon

source is about 30,000 deg K.

When the charge is detonated, the forward shock wave compresses the gas, causing intense radiation, rich in the ultraviolet wavelengths. Because the light pulse is relatively short, a series of mylar diaphragms are placed in the box, parallel to the transparent end. With the gas separated, the shock wave moves into cold gas each time a diaphragm breaks, lengthening the pulse and providing more pump power.

**Optics**—The intense radiation from the box is reflected by a mirror into a mirrored parabolic-shaped collector—a searchlight lens—and concentrated on the laser rod. Three types of laser rods have been used: ruby, terbium borate glass, and neodymium glass.

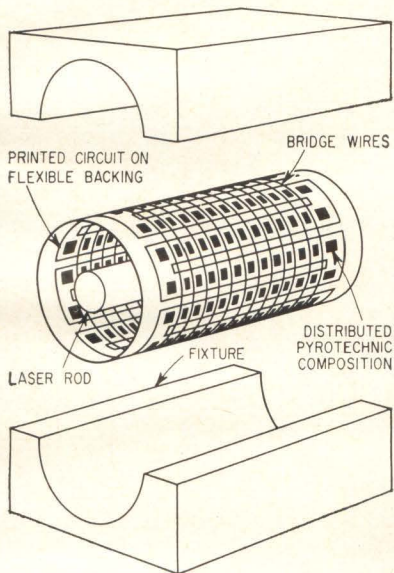

CONFIGURATION PROPOSED by Picatinny Arsenal scientists surrounds laser rod with pyrotechnic material. Printed circuit matrix ignites pyrotechnic material to produce simultaneous burning—Fig. 3

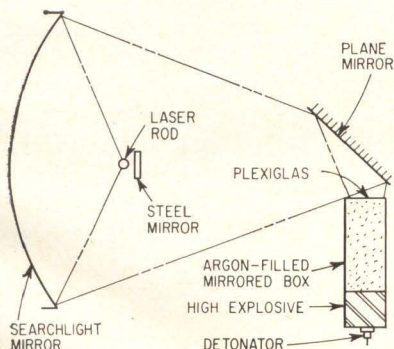
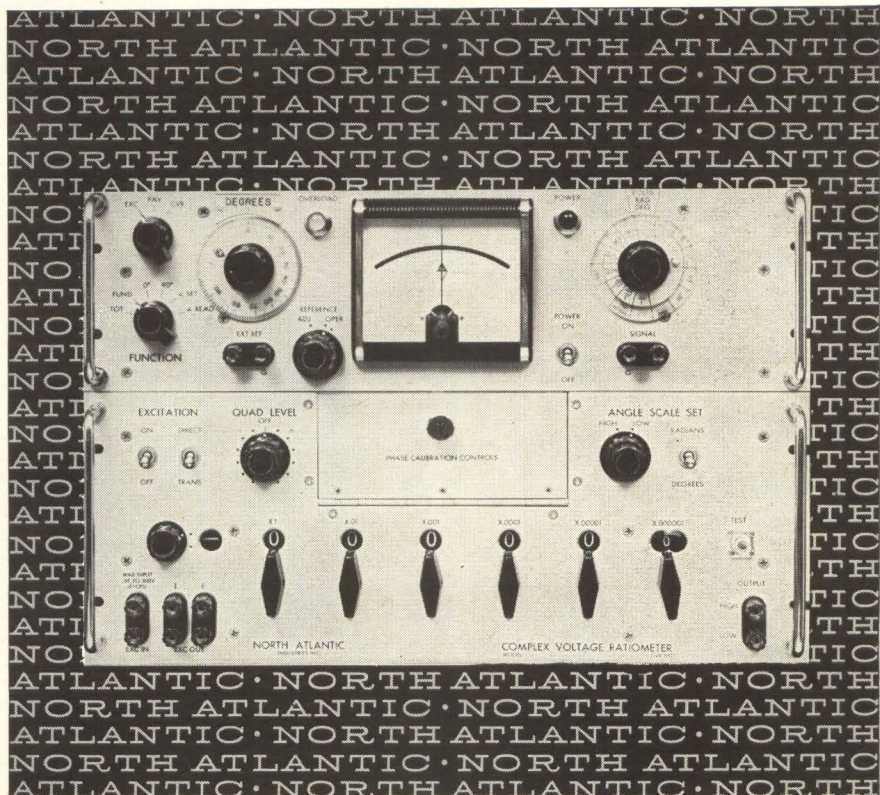

DIAGRAM OF OPTICS used by Stanford Research Institute scientists in chemically-pumped laser experiments—Fig. 4



## how to measure ac ratios regardless of quadrature

North Atlantic's **Complex Voltage Ratiometer** is a completely integrated test set for measuring grounded 3 terminal networks. By providing self-calibrated quadrature injection, the Model CVR-551 permits calibrated meter readings of phase angle up to 30° or 300 milliradians full scale, and, in addition, provides direct readings of in-phase and quadrature voltages. As an added feature, the integral Phase Angle Voltmeter\* and AC Ratio Box can be used independently. Abridged specs follow:

- In-Phase Ratio Range,  $R_I$  .....000000 to  $\pm 1.111110$  with full accuracy
- In-Phase Ratio Error,  $\Delta R_I$  ..... 10ppm (typical for small angles)
- Phase Angle Range,  $\alpha$  .....  $\pm 1.0$  to  $\pm 300$ mr. (6 calibrated ranges)  
 $\pm 0.1$  to  $\pm 30^\circ$  (6 calibrated ranges)
- Phase Angle Error,  $\Delta \alpha$  ..... 0.1mr. or  $.006^\circ$  (for lowest ranges)  
10mr. or  $1^\circ$  (for highest ranges)
- Frequency ..... Any specified frequency, 50cps to 3KC
- Bandwidth .....  $\pm 5\%$  with full accuracy
- Phase Angle Voltmeter (used independently) .....  $\pm 2\%$  full scale  
300 microvolts to 300 volts (13 calibrated ranges)
- Inverting AC Ratio Box (used independently) .. 2 ppm terminal linearity  
.35f volts (300 volts max.)

North Atlantic's CVR\* line includes 2 and 3 frequency models. All models available with optional 10 ppm Ratio Box control of quadrature injection.

Send for data sheet or contact your local North Atlantic sales representative now for complete information.

\*Trademarks



**NORTH ATLANTIC industries, inc.**  
TERMINAL DRIVE, PLAINVIEW, L. I., NEW YORK • Overbrook 1-8600

# Standards Proposed for Flatpacks

Will be based on form factor preferred for integrated circuits

**THE SUBJECT** of flatpack standardization came up again last week, when Signetics offered the electronics industry their own standard flat package for integrated circuits (see photo). Signetics selected a ¼-inch square package, says unit has necessary mechanical strength to overcome heat sink problems. Materials selected for fabrication were a hard glass (Corning 7052) and gold-plated Kovar.

This package is now being produced for Signetics by several suppliers who have been licensed to manufacture and sell it to the industry at large.

Industry sources estimate that 60 to 70 percent of all integrated circuits sold today are in the flatpack configuration. Texas Instruments expects that figure to reach 90 percent in the near future.

**Efficient**—TI pioneered integrated circuits in 1959. Their primary reason for adopting the flatpack is that it was found to be the most efficient form factor for systems packaging. Moreover, the flatpack permits shorter bonding leads, giving the user a much more rugged device. Also, the flatpack is easily adopted to the users mechanized assembly to printed circuit boards.

Many integrated circuit manufacturers note a trend away from the TO-5 package, towards the flatpack for microcircuits. Most manufacturers agree on the advantages of standardization, but companies do not always agree on whose standards to meet.

Sprague Electric believes that flat packages are the preferred packaging for integrated microcircuits because of ease of interconnections, according to Samuel E. Church, marketing manager for integrated

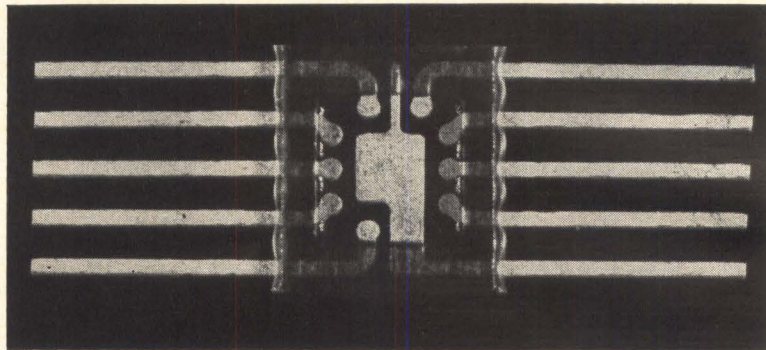

SIGNETICS flat package showing embodiment of leads in glass and circuit mounting pad as extension of one lead. Note wide shoulder provided for final seal

and microcircuits. Church says, "While our present package is 0.160-in.  $\times$  0.265-in. in size, we would undoubtedly be amenable to any package this size or larger standardized through the cognizant JEDEC (Joint Electron Device Engineering Council) committee."

Motorola selected a flat form factor as permitting the best package density. They have a ceramic-glass package. "Allowing 20,000 mils of internal mounting area, a ¼  $\times$  ¼-in. package permits five leads to be placed on each of the two sides with 0.50-in. lead spacing", according to spokesmen. "Such a package is expendable to 18 leads if all four sides are to be used. A study of circuits indicated that 18 leads will handle almost all circuit functions", company says.

**Specifications**—According to C. L. Hogan, Motorola believes that industry should and will standardize on package dimensions. However, specific methods of manufacturing a package fitting within industry standard dimensions are as important to the ultimate cost of any operation as are the processing steps by which a monolithic device itself is manufactured.

Therefore, Motorola believes that it would be unwise to attempt to regulate the method by which each company actually builds any par-

ticular package, providing the package meets external dimensions of a standard configuration.

As to the dimensions of the package, Motorola spokesmen say that standardization, desirable as it may be, can come only after efficient field experience has indicated that the majority of circuits, present and future, can be handled in one package, optimum as to size, number and arrangement of leads, price and construction.

For the present, Hogan suggests that Motorola's approach of providing the specific type of package best suited for the user's requirements, will provide the experience for this necessary evaluation.

General Instruments is working on a flat package made of phenolic resin impregnated with epoxy. Company says it is capable of withstanding 100 percent relative humidity for 72 hours at 75 C.

General Electric has flatpacks with six or twelve leads and custom designs for integrated circuits. Westinghouse has a family of flatpacks, will develop techniques required for manufacturing packages to specifications.

One responsible industry spokesman said "We don't want anyone to go off by their lonesome" on standardization.

Packaging standards for microcircuit chips will be worked out by

**PROTECTS AGAINST** • Bent Pointers • Burned-Out Resistors  
 • Damaged Pivots • Overheated Springs • Burned-Out Meter  
 • Changes in Accuracy Due to Overheating

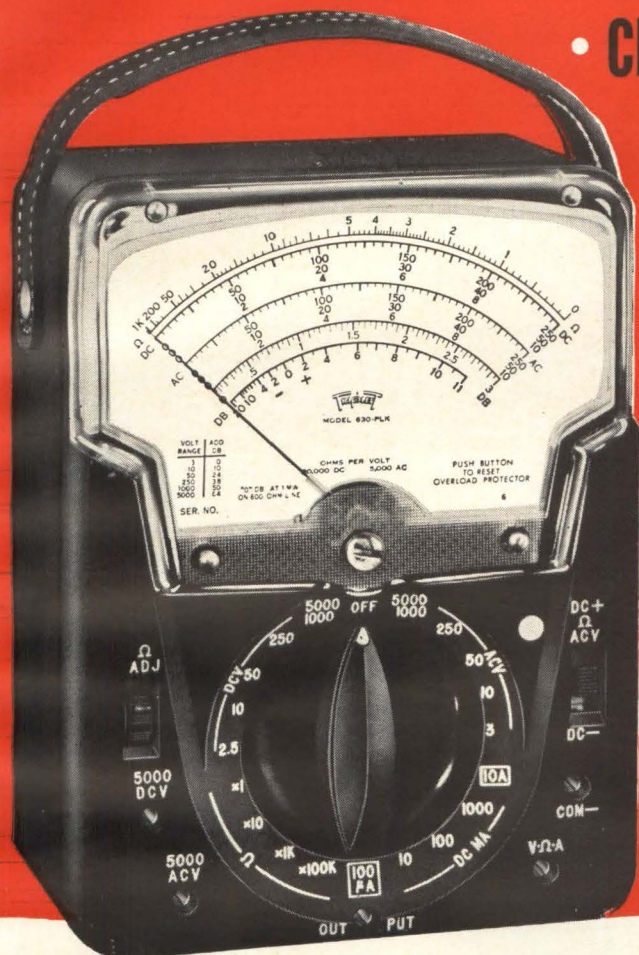

**Model 630-PLK**

# BURNOUT PROOF V-O-M

**\$79.50**

Suggested  
U.S.A. User Net

## USES UNLIMITED

School Classrooms • Field Engineers • Application Engineers  
 • Electrical, Radio, TV, and Appliance Servicemen • Electrical  
 Contractors • Factory Maintenance Men • Industrial Elec-  
 tronic Maintenance Technicians • Home Owners, Hobbyists

## FACTS MAKE FEATURES:

- 1** Comprehensive overload protection.
- 2** One selector switch minimizes chance of incorrect settings
- 3** Polarity reversing switch

Additional protection is provided by Model 630-PLK's new transistorized relay circuit. Transistorized overload sensing device does not load circuit under test, eliminating the possibility of damaging circuit components. A special meter shorting feature on "off" position offers high damping when moving tester. The exclusive patented Bar Ring Movement provides self-shielding and is not affected by stray magnetic fields. Wider spread scales, and unbreakable clear plastic window assure maximum readability. Diode network across meter protects against instantaneous transient voltage.

**TRIPLET ELECTRICAL INSTRUMENT COMPANY, BLUFFTON, OHIO**

## RANGES

<b>DC Volts:</b>	0-2.5-10-50-250-1,000-5,000 at 20,000 ohms/volt. 0-0.25 at 100 microamperes.
<b>AC Volts:</b>	0-3-10-50-250-1,000-5,000 at 5,000 ohms/volt.
<b>Decibels:</b>	-20 to +11, +21, +35, +49, +61, +75; "0" DB at 1 MW on 600 ohm line.
<b>DC Microamperes:</b>	0-100 at 250 Mv.
<b>DC Milliamperes:</b>	0-10-100-1,000 at 250 Mv.
<b>DC Amperes:</b>	0-10 at 250 Mv.
<b>Ohms:</b>	0-1,000-10,000 (4.4-44 at center scale).
<b>Megohms:</b>	0-1-100 (4,400-440,000 at center scale).

**Output Volts (AC):** 0-3-10-50-250-1,000 at 5,000 ohms/volt; jack with condenser in series with AC ranges.

## CARRYING CASE

Model 639-OS black leather carrying case, built-in stand, Flaps open to permit use of tester in the case. Suggested U.S.A. User Net.....\$12.10

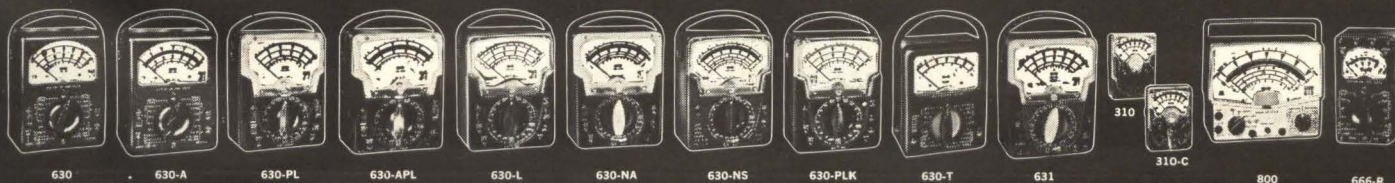

**THE WORLD'S MOST COMPLETE LINE OF V-O-M'S. AVAILABLE FROM YOUR TRIPLET DISTRIBUTOR'S STOCK**

## WHO GOES THERE?

### Briefs on the Kind of Assignments You Can Expect at SES-West

Hide-and-seek can be a deadly serious game when it involves protection of America's ICBM bases.

Requirement: a very advanced, high-reliability electronic security system, combining extremely high probability of detection with very low false alarm rate...

e. g., respond to the presence of a man, but not to a jack rabbit.

SES-West engineers scored a technical breakthrough in 1961 with a system using bistatic doppler radar. From this forerunner model SES developed presently-in-use equipment, described by a military spokesman as the most sophisticated electronic sentry systems ever designed.

SES-West is a "Quick Reaction" facility developing systems and hardware that are on the forefront of our nation's defense technology. Job assignments are as vital and varied as the unique projects we handle. You put your ideas to work on projects in advanced antenna development, arms control, space vehicle guidance, RF systems, reconnaissance, microwaves.

Expansions in size and scope continue at SES-West—creating exceptional opportunities for you. See listing on next page.



**SYLVANIA ELECTRONIC SYSTEMS-WEST**  
DEPT. 260 P. O. Box 188, Mountain View, California

*An Equal Opportunity Employer*

9027



## CURRENT OPENINGS

### AT SES-WEST (a partial listing)

#### SCIENTIFIC PROGRAMMER

Consult with SES engineers and administrators to determine operations analysis, science and engineering applications for digital computers service... direct preparation of data for processing... formulate problems in computable form, selecting best algorithms and methods. Plan, program new systems. BS, MS in Mathematics or Statistics with knowledge of numerical analysis and digital computer applications.

#### ENGINEERS

##### PRODUCT

Design power distribution, control circuits, equipment layout for electronic systems. Design circuit packaging of electronic circuits for fabrication into finished systems. Also will assist with system and customer acceptance tests and become familiar with printed circuit board processes.

##### RELIABILITY

Perform functional, worst case, and transient and failure analyses. Will predict circuit outputs as a function of time, operating stresses and part parameters... recommend alternate designs where necessary; prepare reliability reports. Knowledge of semiconductor devices and their applications in digital and analog circuitry desirable.

##### ANTENNA

Develop advanced medium- and high-gain antennas for SES-West Electronic Defense Systems. Interesting and varied work on both portable and fixed position antennas.

**BSEE Required. Advanced Degree and Experience Desirable.**

SES-West is located on the beautiful San Francisco Peninsula, in an ideal geographical, cultural and social climate. Excellent facilities for SES-West-sponsored advanced courses at nearby Stanford, and other Bay Area universities.

For complete information on these and other openings contact: *H. J. Sheppard*. A prompt, confidential reply is promised.

### SYLVANIA ELECTRONIC SYSTEMS-WEST

DEPT. 260 P.O. BOX 188  
Mountain View, California

*An Equal Opportunity Employer*

appropriate JS (Joint Semiconductor Committees) of JEDEC. Standardization recommendations on user requirements to committees within Electronics Industries Association (EIA) and JEDEC (Joint Electron Device Engineering Council) will come through the Microelectronic Advisory Committee (MCA), headed up by Ed Keonjian. The MCA is set up to monitor the state of the art on microsystem electronics. Subcommittee MCA-1 encompasses mechanical form factors. The MCA reports will be reviewed by groups represented by all semiconductor manufacturers of integrated circuits and representatives

**Signetics package** — Three firms have passed company's requirements for making the package: Corning Glass Works, Ultra-Carbon Corp., and Glasstite Industries.

The gold-plated Kovar mounting pad for the silicon chip is an integral part of one of the leads. Attachment of the chip to this surface with the type of standard gold preform used in the transistor industry automatically provides a means for connection from the common substrate of the circuit to the outside.

The internal pattern of the leads with respect to this pad is similar to that of the TO-5 can.

After chip attach, the standard techniques of thermocompression ball bonding and microwelding can be used to complete connections between lands on the circuit chip and the tips of the leads expressed within the pocket.

The internal lead length in this package is shorter than the TO-5.

Signetics has developed a molded Delrin carrier slide in which the individual packages can be inserted after final seal.

The Signetics package meets tests in accordance with MIL-STD-750.

### Japanese Firm Offers New Micro Packages

TOKYO—Mitsubishi Electric says it will produce a series of low-cost microcircuits that are designed for civilian use and packaged in transistor cans.

Ten will be thin film circuits with pico transistors and diodes, and two will be integrated circuits. One of

the integrated silicon circuits is described as a universal linear circuit matrix containing four *npn* transistors, four diodes and 27 resistors fabricated by planar techniques.

Low value resistors are made during the *p* base-region diffusion. High-value resistors are made while the *n* emitters are diffused. This leaves only a 0.5 micron *p* layer between two *n* layers. The transistor base region is also 0.5 micron. Sheet resistance of thin *p* region is 5,000 ohms per square, which is 25 times that of original region.

Resistors made from 200-ohm sheet resistance regions are two each 50 ohm, 100 ohm, 200 ohm, 400 ohm, 1 kohm, 2 kohm, and 4 kohm. Temperature coefficient of these resistors is 0.15 percent per deg C. Resistors made from 5,000-ohm sheet resistance regions are two each 2.5 kohm, 5 kohm, 10 kohm, 25 kohm, 50 kohm, 100 kohm and one 200-kohm resistor. Temperature coefficient of these resistors is 0.6 per cent per deg C. High value of temperature coefficient and difficulty of accurately controlling thickness of thin region to control resistance values are drawbacks of this method of obtaining high values.

### Motor is Dialed For Specific Rpm

DIRECT-CURRENT motors, developed by Orbito-Dynamics, Inc., Cranford, New Jersey, can be dialed for a specific rpm output. Performance characteristics can be varied simply by adjusting a calibrated ring on the motor itself, company says. No additional wiring is required for speed alteration. The adjustment is built into the case.

Prototypes have been delivered to meet military requirements. Company president, Marvin Brown, aims for commercial markets, says principle can be applied to any motor having pole piece and commutator. The adjustment alters the pole piece's relationship to the commutator.

Company is working on an a-c version which will be ready in February. Orbito now offers two 28-v d-c types: a dual series field motor and a permanent-magnet type. Both weigh 15 ounces or less and offer up to 57 ounce-inches of torque.

# Welder Bonds Smaller Leads

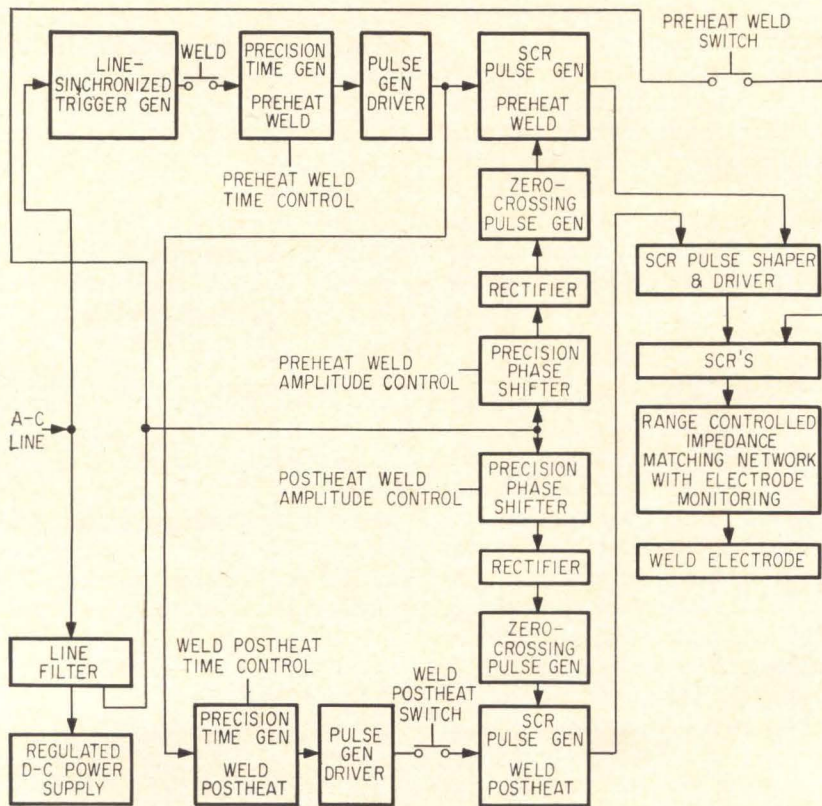

WELDER ELECTRONICS provides variable pulse trains by scr's to perform preheat and postheat of weldments. Voltage across electrodes is constantly monitored

Single point and a-c pulses weld 1/2-mil leads on 0.003-inch centers

**WELDING** of interconnections within integrated circuits with a high degree of reliability poses a problem in production because of the microscopic dimensions involved, says manager Glen Rose of Aerojet-General's commercial division.

To solve their problem of linking micro-size components in an important military satellite, Aerojet's F. R. Sullivan developed a welding machine that includes a special welding tip energized by a synchronously timed train of a-c pulses.

**Tip Details**—The special molybdenum tip consisting of two electrodes separated by a very thin insulator is of such dimensions (0.002 inch) that welding is possible to conductors having diameters of 0.0005 inch. These conductors can be located on centers to 0.003 inch.

Pressure on the tip is controlled by the placement of gram weights on the tip. These weights provide force control within a range of 10 to 1,600 grains. The tip can be smoothly adjusted in the x and y axes. After physical contact is made to the work it floats free of the holder and is subject to the pressure of the weights only.

**Synchronous Timing** — A precise control of welding energy that provides identical weld pulses is achieved by the solid-state power supply, says Sullivan. Called synchronous timing, the initial pulse has exactly the same energy value

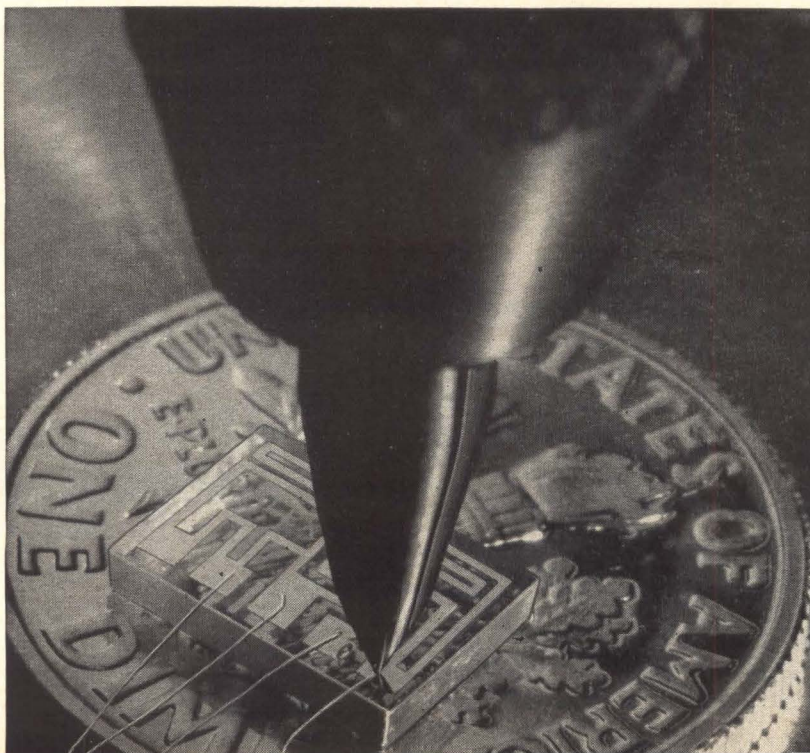

**SINGLE POINT** includes both electrodes and a tiny insulator. Tip has 0.002-inch diameter. Gold and silver wires are welded to a thin-film (gold on chrome on glass) circuit

**think neat** With LTCO electronic lacing cords and tapes. Write today for illustrated handbook of proper cords and tapes for your lacing operation. We make them all.



**THE LINEN THREAD CO.**  
Blue Mountain, Alabama  
A DIVISION OF INDIAN HEAD MILLS, INC.

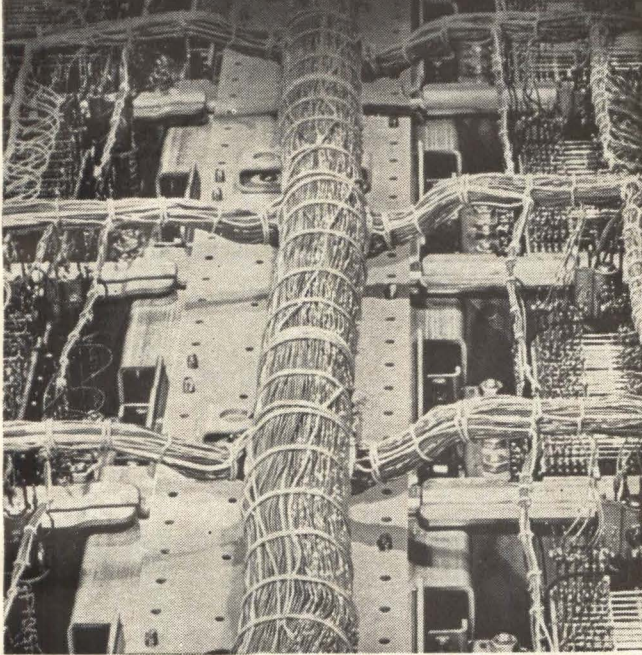

CIRCLE 201 ON READER SERVICE CARD

## New! MINIATURE AXIAL FANS

with up to 4 times greater cooling efficiency!

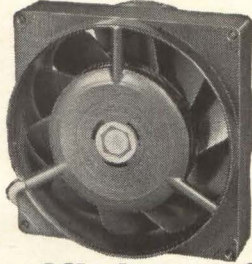

FULLY GUARANTEED FOR 10,000 HRS. UNDER NORMAL OPERATING CONDITIONS

Characteristic	PAMOTOR Model 1000	Conventional Fan
Type of Motor	induction (capacitor-type squirrel cage)	shaded-pole
Housing	die cast warp-free Zymec	plastic
Output @ 60 cps (0 back pressure) (.25" back pressure) (.3" back pressure)	125 cfm 75 cfm 50 cfm	100 cfm 20 cfm 0
Output @ 50 cps (0 back pressure) (.25" back pressure)	100 cfm 62.5 cfm	75 cfm 5 cfm
Operating Temp. Range	-55°C to +85°C	-18°C to +44°C

The PAMOTOR Model 1000 Miniature Fan is completely interchangeable with conventional units now in use (4 1/8" center-to-center mounting holes). But the similarity ends there.

check this comparison chart!

Model 1000 meets MIL-T-5422E (Class 2), and MIL-STD-202 Environmental specs. Inside-outside rotating motor design gives fly-wheel effect, resulting in constant, quiet fan speed. Large surface sleeve bearings mean minimum maintenance, maximum reliability.

For complete specifications and name of nearest stocking distributor, write to:

**PAMOTOR, Inc.**  
312 Seventh Street • San Francisco 3, Calif.

CIRCLE 202 ON READER SERVICE CARD

electronics January 17, 1964

TO BE  
**PRECISE:**  
SPECIFY MELPAR  
**TUNING FORKS**  
-  
**FREQUENCY STANDARDS**  
-  
**TIMING SYSTEMS**

- RUGGED
- RELIABLE
- COMPACT



SELECTED BY GOVERNMENT AND INDUSTRY FOR WIDE-RANGING APPLICATIONS:

**FOR TIME BASE:**

- Real Time
- Interval Time
- Teletype Communications Equipment

**FOR FREQUENCY REFERENCE:**

- Servo Speed Controls
- Inverters
- SSB Communications

**FOR TONE GENERATION:**

- Selective Signaling
- ASW
- Mobile Communications

SIZE AND PERFORMANCE TO MEET ANY REQUIREMENT

FREQUENCIES: 0 to 6400 cps  
ACCURACIES: 0.1 to 0.005%\*  
TEMPERATURE RANGES: -55°C to +125°C  
\*accuracies to ± 0.001% over narrower temperature ranges

If you have a special frequency generation problem, or would like more detailed technical data and list of representatives nationwide, please write or phone:

SPECIAL PRODUCTS DIVISION

**MELPAR INC**

A SUBSIDIARY OF WESTINGHOUSE AIR BRAKE COMPANY

3511 ARLINGTON BLVD. • FALLS CHURCH, VA. • JEFFERSON 4-6000

CIRCLE 57 ON READER SERVICE CARD

57

# Gertsch CRB bridges measure both in-phase and quadrature voltage ratios —with high accuracy



MODEL CRB-8

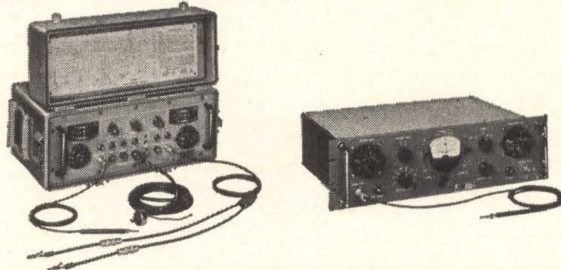

Complex Ratio Bridges are ideal for precision voltage and phase comparisons between signal and reference vectors. Instruments are designed for testing transformers, tach-generators, rate gyros, all types of transducers, AC amplifiers, AC networks, and AC systems. All CRB instruments feature self-contained, phase-sensitive null indicators.

**Model CRB-8**—a new broad-band bridge providing continuous frequency coverage from 350-5100 cps—with no plug-ins. Instrument measures angles as small as  $.001^\circ$ , and is accurate to  $.001\%$  (10ppm). 6-digit readouts are provided for both in-phase and quadrature ratios. Loading on the device under test is virtually eliminated by extremely high signal input impedance—better than 20,000 megohms at null.

A wide variety of CRB instruments is available in both cabinet and rack mounted designs. Compact all-transistorized units feature accuracies to  $.005\%$ . A militarized model is certified per MIL-T-21200 . . . meets stringent environmental requirements. Gertsch also manufactures an automatic complex ratio bridge which displays both in-phase and quadrature ratios on 5-place Nixie readouts.

*Write for complete literature on the CRB line.*

## **Gertsch**

GERTSCH PRODUCTS, INC.

3211 S. La Cienega Blvd., Los Angeles 16, Calif. • Upton 0-2761 • Vermont 9-2201



MICROWELDER lowers tip to work but pressure is dependent only on gram weights shown on right. Weights are placed on tip shaft

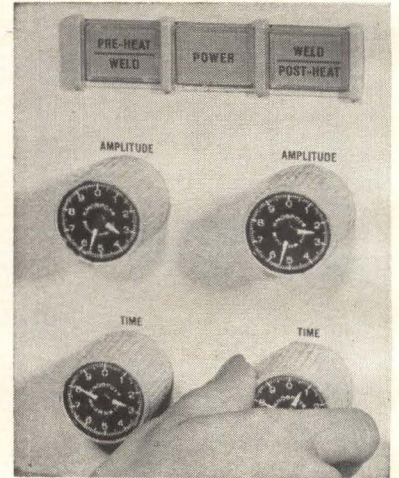

HIGH-RESOLUTION readout potentiometers permit accurate adjustments and easy resetability

as the following pulses in the train. These pulses are controlled by 10-turn potentiometers that allow precision adjustment to the schedule and permit easy, accurate resetability of the welding parameters.

**Power Supply**—An a-c power supply using silicon controlled rectifiers provides a continuously adjustable control of the three major electronic parameters of the weld in three ranges. These ranges are obtained by three different firing voltages applied to the scr gates. The portions of the a-c wave permitted through the device have different time bases.

Since the weld energy depends not only on the width of the pulse, finely divided increments are obtained by also controlling the amplitude. The time required for welding is determined by the number of pulses applied to the work. This parameter is also continuously controlled.

**Weld Modes** — Control settings change with characteristics of ma-

terials and relative positioning.

If the lead material is stiff or has a rough, irregular surface, a preheat is desirable to allow the electrode to seat more intimately on the lead and provide a better contact surface.

A post-weld operation is required to prevent undesirable thermal shock. Most glass and ceramic materials are relatively poor thermal conductors and have very low strength under tension. It is possible, by raising the temperature of the weld and abruptly terminating the heat input, to cause a chilling effect (due to the high thermal conductivity of the metals) that contracts the surface of the ceramic or glass. This creates a thermal stress resulting in hemispherical failure below the weld zone.

The post-weld mode is used with a relatively low amplitude and long time setting for the weld and a setting somewhat below these values to post-heat the material and prevent rapid chilling and possible destruction of the substrate.

### Tester on Lead Former Sorts Resistors, Too

PALO ALTO—Automatic testing of resistors and diodes after leads are formed is a new capability just added to lead-forming machines made by Develop-Amatic Engineering here (ELECTRONICS, p 52, Jan. 10).

For testing resistors, a new all solid-state limit bridge is used in conjunction with machine enabling it to test resistors from 10 ohms to 1.111 megohms to tolerance limits of plus or minus, 1, 2, 5, 10 or 20 percent. Tester automatically sorts resistors according to tolerance preset on machine and can be operated by nontechnical personnel. Thus it provides 100-percent inspection of all components up to moment they are placed into a circuit, and guards against component failure or change in value due to lead forming.

Develop-Amatic will announce shortly an automatic diode tester capable of handling diodes in the same manner. These automatic testers are self calibrating against independent standards contained within the unit. System, called the Type 501, can handle up to 4,200 pieces per hour.



# BRISTOL sub-miniature chopper 0.1 CU. IN.

(shown actual size)



Featuring □ airborne environmental ratings and complete shielding for military applications. □ Unmatched noise level for low level instrument applications. Write for detailed spec sheet.

**The Bristol Company, Aircraft Equipment Division, 152 Bristol Road, Waterbury 20, Conn.** A Subsidiary of American Chain & Cable Company, Inc. In Canada: The Bristol Company of Canada Ltd. 71-79 Duchess Street, Toronto 2, Ontario.

3.4



## BRISTOL

...engineers for precision, builds for reliability.

# CHESTER

## MULTI-CONDUCTOR CABLES

Custom constructions to meet your exact requirements. Any combination of conductors, Plastico<sup>®</sup> insulations, shields, jackets, color coding, etc.

Send for brochure, today!

**CHESTER CABLE CORP.**  
CHESTER, NEW YORK  
a subsidiary of  
TENNESSEE CORPORATION



## NEW PRODUCTS

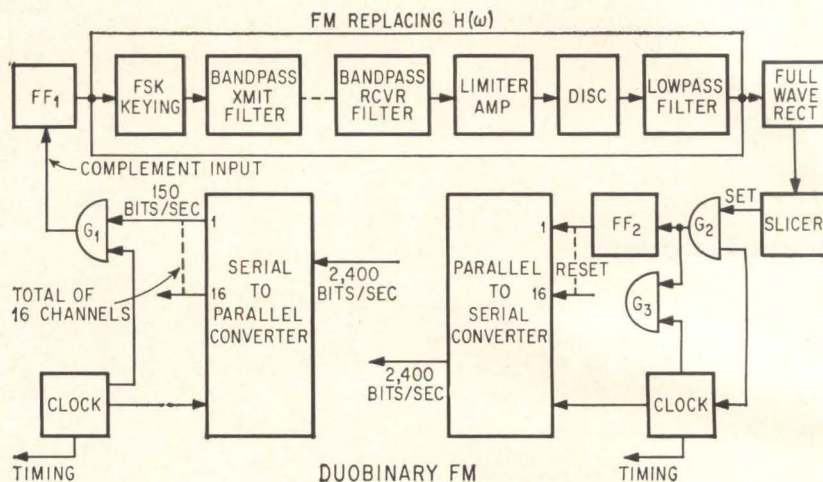

## System Increases Digital Rates

Duobinary coding doubles information-carrying capacity

**MODEL 27A** Duobinary-Datatel system makes possible short-wave transmission of high-quality voice communications in digital form when used with speech-scrambling equipment. Digital signals are transmitted at 2,400 bits per second, representing twice the traditional digital-transmission rate over short-wave or h-f radio, while substantially improving voice quality.

Duobinary Datatel will soon be adapted into 16 narrow channels of 150 bits each that will permit business machines operating at rates below 2,400-bit speeds to communicate simultaneously over one h-f radio circuit. The system presently uses a single stream of 2,400-bit data.

The transmitting terminal accepts synchronous data at 2,400 bits per second. The serial-to-parallel converter separates serial data into 16 channels, each operating at 150 bits per second. The duobinary logic circuit encodes the binary signal, and the output of the logic circuit is applied to an FSK oscillator. Sixteen f-m FSK oscillator outputs are then frequency-multiplexed into a 3-kc bandwidth. Channel frequency multiplexing is based on 170-cps spacing. The low channel

is centered at 425 cps, the top at 2,975 cps. In the receiving terminal, diversity reception is employed to combat selective fading of h-f transmission. Diversity combiners are provided on each of the 16 channels. The best input path is enhanced by a ratio-squared post detection combiner. The signal is then demodulated and fed out as serial-binary data at a synchronous speed of 2,400 bits per second.

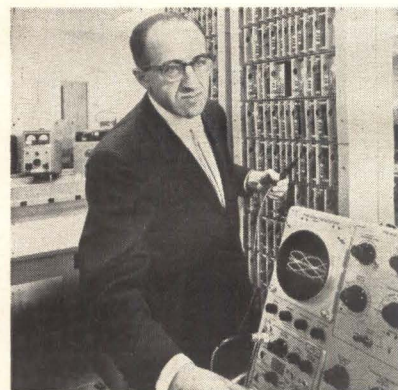

According to the manufacturer, the duobinary technique combined with f-m provides a system relatively immune to noise. The system uses transistor circuits and card-type mechanics for reliability and flexibility. Lenkurt Electric Co., Inc., Subsidiary of General Telephone & Electronics, 1105 County Rd., San Carlos, Calif.

CIRCLE 301, READER SERVICE CARD

# FREE TO COMPANY OFFICIALS LOOKING FOR A NEW PLANT SITE

WE WILL PREPARE FOR YOU A  
**CONFIDENTIAL SURVEY**  
OF SELECTED LOCATIONS  
FOR YOUR NEW PLANT IN  
**NEW YORK STATE**



## TABLE OF CONTENTS

SUBJECT	PAGES
Introduction .....	1
Growth Trends .....	2-3
Climate .....	4-6
Public Utilities .....	7-22
Financial .....	23
Government Services.....	24-44
Taxes	
Protective Services	
Water Supply & Sewerage	
Community Facilities .....	45-73
Housing	
Education	
Recreation & Culture	
Industrial History .....	74-79
Labor .....	80-92
Natural Resources .....	93-94
Transportation & Markets..	95-104
Sites .....	105-133

**TAILOR-MADE.** This confidential report is not taken off the shelf. It will be prepared specifically for you, based on the requirements for your new plant as you give them to us. Send these requirements on your business letterhead to Commissioner Keith S. McHugh, N.Y. State Dept. of Commerce, Room 256R, 112 State St., Albany 7, N.Y.

Keith S. McHugh, Commissioner  
New York State Department of Commerce

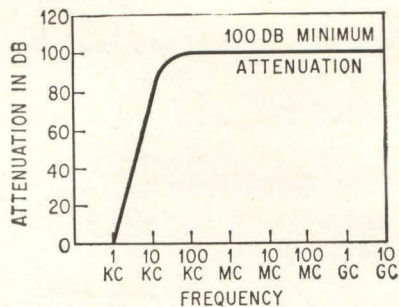

## Filter Provides High Attenuation

RADIO-FREQUENCY interference filter provides more than 100 db of attenuation at frequencies as low as 14 kc and as high as 10 Gc. Moreover, it is essentially resistive at 400 cycles, handles 250 v a-c at 400 cps, is capable of continuous duty over an operating temperature range from  $-55^{\circ}\text{C}$  to  $+85^{\circ}\text{C}$ .

According to the manufacturer, the filter will be especially useful in screen rooms or other shielded enclosures, where equipment subject to military radio-frequency interference specifications must be tested.

The unit substantially reduces reactive currents experienced in standard screen rooms, and can reduce a conventional 10 amperes of reactive current to less than 1 ampere at 400 cps.

Filter can be supplied in 25, 50 and 100 ampere models, weighs  $14\frac{1}{2}$  pounds and measures 22 inches  $\times$   $3\frac{5}{8}$  inches  $\times$   $3\frac{5}{8}$  inches. Capehart Corp., 87-46 123rd St., Richmond Hill, N. Y. (302)

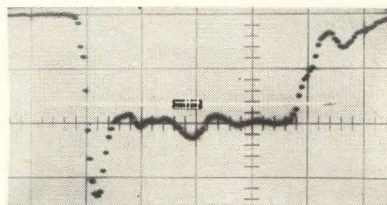

## Computer Diode Features Picosecond Switching

COMPUTER diode with a logic-switching speed of less than 10 picoseconds has a typical recovery time of 500 picoseconds and a guaranteed recovery time of 700 picoseconds.

Designated the FD-700, the diode has a forward current of 50 ma at a maximum forward voltage of 1.1

## COAXIAL CABLES



Accepted by industry as the quality line of Coaxial cables.

Conform to Military Specifications including MIL-C-17C—or your own special requirements. Send for complete Coaxial Cable catalog.

**CHESTER  
CABLE CORP.,  
CHESTER, NEW YORK**  
a subsidiary of  
TENNESSEE CORPORATION

# CHESTER

Ultra-Stable — even in "rough" mobile applications

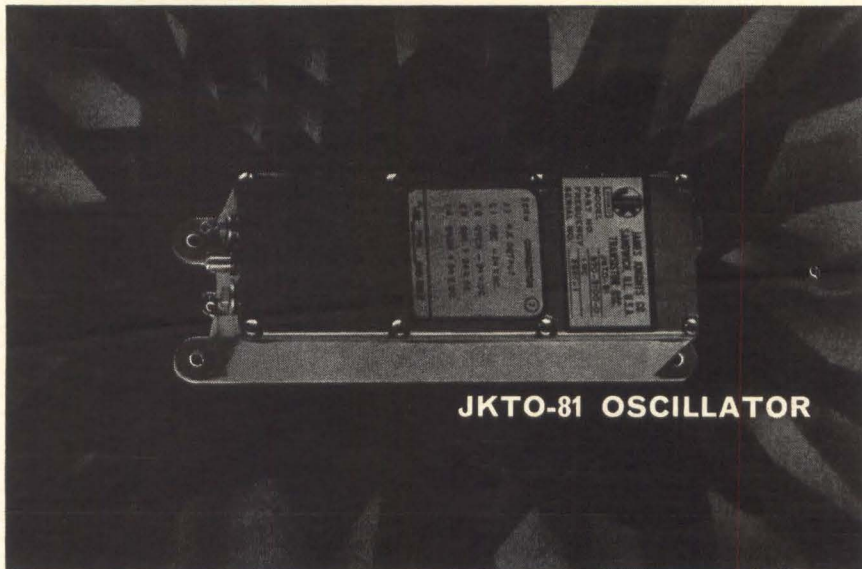

**JKTO-81 OSCILLATOR**

For additional technical data, WRITE:



PRODUCTS

**THE  
JAMES  
KNIGHTS  
COMPANY**

SANDWICH, ILLINOIS

**JKTO-81 1.0 mc Oscillator:** Prime frequency source for vehicular or aeronautical single sideband and data transmission equipment. Shock and vibration resistant high-Q glass-enclosed crystal, oscillator-buffer, voltage regulator circuitry plus full proportionally controlled temperature control of package. Maximum required power @  $-40^{\circ}\text{C}$ : 7.25 watts. Signal output: sine or square wave. Daily aging stability performance:  $5 \times 10^{-9}$  or better after initial 10 days.

CIRCLE 203 ON READER SERVICE CARD

vdc, and 0.01 ma at 0.5 vdc ma, at 25 C. Reverse current is 50 na maximum at  $V_R = 20$  volts. Specifications are guaranteed because of the parameter stability and reliability of the planar epitaxial process used in the diode's manufacture. The FD-700 is priced at \$15 in quantities between 1 and 99 and \$10 in quantities between 100 and 999. Fairchild Semiconductor, Div. of Fairchild Camera & Instrument Corp., 545 Whisman Rd., Mountain View, Calif.

CIRCLE 303, READER SERVICE CARD

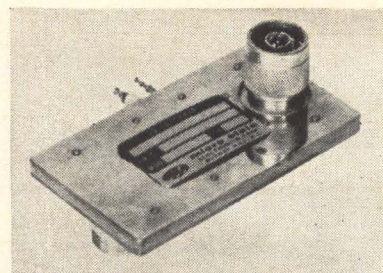

**Active Limiter Covers  
3,100 to 3,500 Mc**

S-BAND active limiter, model S-3301, is designed to give an isolation of greater than 40 db over the frequency range of 3,100 to 3,500 Mc with a nominal loss of 1 db over this range. Input vswr over the frequency range is in the order of 1.1. The switching bias voltage for the high isolation characteristic is 50 to 100 ma at  $-50$  v. Micro State Electronics Corp., 152 Floral Ave., Murray Hill, N. J. (304)

**HERE IS THE WORLD'S SMALLEST MOTOR  
YET IT'S SO POWERFUL . . .**

**MITSUMI MICRO MOTOR**



**MODEL MI-100**

Less than 20mm in diameter, the new Mitsumi Micromotor provides a startling efficiency of over 50%, the barrier which miniature motors are not allowed to pass.

A novel construction principle helped to make this accomplishment possible. The form is more simplified by setting all the terminals at one position. Because the entire mechanism is given full protection against irregular revolution and above all, electrical noise is entirely eliminated, you may call this the most perfect micromotor yet devised. Please write for complete information on Mitsumi Micromotor, and we will send you specifications and data.



**MITSUMI PARTS**  
**MITSUMI ELECTRIC CO., LTD.**  
TOKYO • OSAKA • NEW YORK

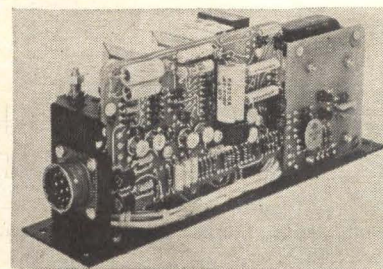

**Servo Amplifier in  
Reduced Size**

FRACTIONAL HORSEPOWER d-c servo amplifier, model A470, is designed to drive d-c servo motors and torquers up to 0.6 h-p. The bi-directional full wave scr output stage permits a new advancement



# HOW TO USE YOUR ELECTRONICS BUYERS' GUIDE\*

## The Two-Way Product Locator

\* \* \*

Most products advertised in the ELECTRONICS BUYERS' GUIDE are listed twice for your convenience. After the Product Heading, advertising page numbers appear where appropriate (when advertisements of one kind are grouped together in the book). Next to the individual product listing, the page number of associated advertising material is cited. Thus you can locate all of the advertisements for a particular product category, or any specific advertisement, quickly, accurately, and conveniently. Keep your ELECTRONICS BUYERS' GUIDE close to your work area at all times.

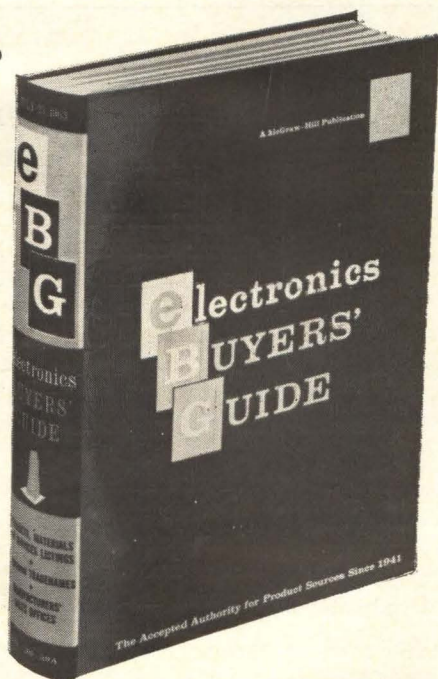

## not new BUT STILL UNIQUE FM DEVIATION METER

**\$960**



MODEL 791D  
(6625-060-3320)

### FREQUENCY:

4 to 1024 mc

DEVIATION:  $\pm 5$ ,  $\pm 25$ ,

$\pm 75$ ,  $\pm 125$  kc

ACCURACY:  $\pm 3\%$  fsd.

MODULATING FREQ.:

20 cps to 35 kc

Spurious FM on CW as low as 10 cps may be measured using xtal lock facilities.

Write for detailed catalog sheet.

# MARCONI INSTRUMENTS

DIVISION OF ENGLISH ELECTRIC CORPORATION  
111 CEDAR LANE • ENGLEWOOD, NEW JERSEY  
MAIN PLANT: ST. ALBANS, ENGLAND

specify the new Sperry Products  
contact Avnet for best service

# AVNET

on-time delivery of the latest  
Sperry Semiconductors

including NPN and PNP silicon  
planar & PNP silicon alloy transistors (many types QPL approved),  
silicon planar differential & darlington amplifiers, dual emitter  
differential choppers

many other Sperry products are  
available immediately from Avnet

# SPERRY

call your local Avnet Headquarters  
The Avnet System, coast to coast

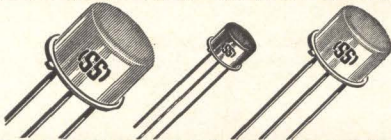

Westbury, L. I.; Chicago; Phoenix;  
Burlington, Mass.; Syracuse, N. Y.;

# LOCAL

Salt Lake City; Bellevue, Wash.;  
San Diego, L. A., Sunnyvale, Cal.

CIRCLE 204 ON READER SERVICE CARD

free...  
information  
on the  
world's  
happiest  
hobby!

ASSEMBLE IT AT HOME

# THE Artisan

## ELECTRONIC ORGAN KITS

for home, school, church, clubs.

The Original "Build-it-Yourself" Organ  
sounds like a glorious pipe organ

SAVE 70%  
up to

Anyone Can Do It! Here's What You Get



Manuals & Couplers, Tone Generator, Tone Changers, Pedal Keyboards, Consoles

Mail coupon below, and receive . . . absolutely  
**FREE** . . . complete information on Artisan's new  
1963 Organ-Building Kit! Illustrated instructions  
lead you through every step of this happy hobby,  
as you assemble-at-home a magnificent custom  
Artisan electronic organ - the best in tone and  
styling! No technical skill required, and you save  
up to 70% of comparable ready-built organ costs  
by skipping dealer profits and factory labor! You  
can play as you build and pay as you build. From  
\$1750 to \$7500. Write today!

ARTISAN ORGANS 2476-X N. Lake Ave., Altadena, Calif.

NAME \_\_\_\_\_

ADDRESS \_\_\_\_\_

CITY \_\_\_\_\_

ZONE STATE \_\_\_\_\_

CIRCLE 205 ON READER SERVICE CARD

in frequency response and size and  
weight reduction. The A470 is  
capable of a gain of 1,000 v/v with  
a 100,000-ohm input impedance.  
Westamp, Inc., 11529 W. Pico  
Blvd., Los Angeles 64, Calif.  
CIRCLE 305, READER SERVICE CARD

## Conductor Alloy Has High Tensile Strength

NEW CONDUCTOR ALLOY, Insoloy  
105, has been developed to meet  
expanding flexibility and tensile re-  
quirements. The combination of In-  
soloy 105 and TFE light wall fused  
laminate insulation produces an  
extremely flexible wire having a  
minimum tensile strength of 55,000  
psi capable of maximum perform-  
ance at temperatures of 200 C.  
These structural integrity and re-  
liability assets are in addition to  
significant weight and installation  
volume economies, company says.  
Inso Electronic Products, Inc., Park  
Ave., Nutley 10, N.J. (306)

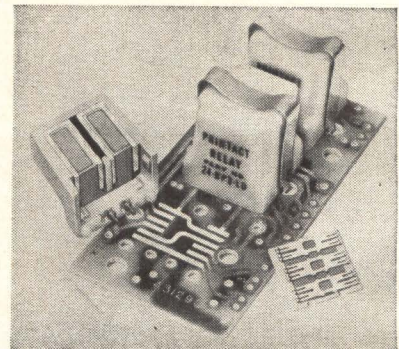

## Latching Relays Use Ceramic Magnets

AVAILABILITY of Printact single and  
double coil latching relays is an-  
nounced. Employing ceramic mag-  
nets, instead of mechanical link-  
age, the Printact LS and LD series do  
not require hold-in power to remain  
in either latch position. Only a  
momentary d-c pulse of 7 millise-  
c at rated voltage is required to switch  
Printact latching relays which are  
available with 6, 12, or 24 v d-c  
coils. Substantial savings in space,  
weight and assembly costs are possi-  
ble with the 7/8 in. cube, 0.8 oz plug-  
in unit. Printact Relay Division,  
Executone Inc., 41-37 Austell Place,  
Long Island City 1, N. Y. (307)

# DYNAMICS

## DC MILLIVOLTMETER



-large-scale meter  
assures 1% accuracy  
full scale

PRICE: \$295.00

Model 6352 - low-level unit featuring zero-center, taut-band meter, with mirror-back  
scale 7.2" long, for accurate readings. Operates for 1000 hours on 4 standard, D-cell  
flashlight batteries. Input is fully-guarded differential, and/or 2-terminal type.

Voltage range... millivolts:  $\pm 10$ ,  $\pm 30$ ,  $\pm 100$ ,  $\pm 300$ ;  
volts:  $\pm 1$ ,  $\pm 3$ ,  $\pm 10$ ,  $\pm 30$ ,  $\pm 100$ ,  $\pm 300$ ,  $\pm 1000$   
- full scale.

Input impedance... 100 megohms on ranges above  
3 volts.  
10 megohms on lower ranges.

Battery operating life... 1000 hours, min.  
(1.2 ma discharge rate.)

Size... 83/16" high x 83/16" wide x 53/16" deep.

Typical applications... Potentiometric measurements,  
null indication, measuring thermocouple output...  
diode matching.

Write for complete literature on the Dynamics meter line.

**DYNAMICS INSTRUMENTATION COMPANY**  
583 Monterey Pass Rd., Monterey Park, Calif. - Phone: CUMberland 3-7773

## LITERATURE OF THE WEEK

**TRANSDUCERS** Bourns, Inc., 6135 Magnolia Ave., Riverside, Calif. Brochure lists specifications and performance characteristics on pressure, position, and acceleration transducers and instrument systems. (361)

**HIGH-VACUUM ACCESSORIES** Consolidated Vacuum Corp., 1775 Mt. Read Blvd., Rochester 3, N.Y. A 16-page brochure on high-vacuum and ultra-high-vacuum accessories is now available. (362)

**LASER SYSTEM** Maser Optics, Inc., 89 Brighton Ave., Boston 34, Mass. A technical specification bulletin gives complete details on the model 3100 laser system. (363)

**OPERATING IMPEDANCE BRIDGE** Delta Electronics, Inc., 4206 Wheeler Ave., Alexandria, Va. 22304. Six-page bulletin describes measurements that can be made with the OIB-1 operating impedance bridge. (364)

**PIEZOELECTRIC ACCELEROMETER** Massa Division of Cohu Electronics, Inc., 280 Lincoln St., Hingham, Mass. A data sheet describing a miniature piezoelectric accelerometer is available. (365)

**RELIABILITY & QUALITY ASSURANCE** ITT Cannon Electric Inc., 3208 Humboldt St., Los Angeles, Calif. 90031, has available a brochure describing and illustrating its reliability and quality assurance capabilities. (366)

**COMPUTER CONTROL SYSTEM** Honeywell, Special Systems Division, Pottstown, Pa. 19464. Capabilities of the 610 digital computer control system are outlined in a brochure. (367)

**RESISTOR CATALOG** Shallcross Mfg. Co., Selma, N. C. Catalog PR200 in 23 pages describes seven complete precision wirewound resistor groups. (368)

**FUNCTION MODULES** Consolidated Electrodynamics Corp., 360 Sierra Madre Villa, Pasadena, Calif. Function modules, a new approach to analog control system design, are described in six bulletins now available. (369)

**RIBBON CABLE** Tensolite Insulated Wire Co., Inc., West Main St., Tarrytown, N. Y. A new round conductor/flat cable construction that utilizes a thin, high-temperature film to bond conductors into an ultra-compact cable is described in a technical bulletin. (370)

**LIGHT-SENSITIVE SEMICONDUCTOR DEVICES** Amperex Electronic Corp., Hicksville, L. I., N. Y. 11802. Treatise of basics and practical applications of light sensitive semiconductor devices may be obtained by writing on company stationery.

**DECADE COUNTERS** Raytheon Co., 55 Chapel St., Newton, Mass. 02158. Decade counters and their applications are discussed in a 16-page illustrated brochure. (371)



Basic and special REED RELAYS and/or COILS for high reliability and sophisticated switching.

Operating Inputs: low as 1mA. and 15mW.

Standard Coil Voltages: 6, 12, 24, 32, 48V in stock for immediate delivery.

Special Voltage or Resistance, multiple windings for flip flop, memory and crosspoint selection applications — to customer specifications.

New Type SP Coils: for high voltage vacuum-type reeds, 1 1/4" lg.

Standard Coil Termination: 3" flexible leads. Also available with solid copper leads, printed circuit pins and rigid lugs — silver plated or tinned.

Relay Contacts in Form A, B, C and latching.

**Coto-Coil** Write for Prices  
COMPANY, INC.  
65 Pavilion Ave.  
Providence, R. I. 02905

CIRCLE 206 ON READER SERVICE CARD

specify the new Microdot Products contact Avnet for best service

# AVNET

on-time delivery of Microdot Connectors and cable

Multipin connectors with up to 61 power or 19 coaxial contacts in 1/8" o.d. plug; microminiature coax connectors in 50, 70, 90 ohm types; coax, twinax, triaxial cables (RG types approved to MIL-C-17C).

many other Microdot Products are available immediately from Avnet

# MICRODOT

call your local Avnet Headquarters  
The Avnet System, coast to coast

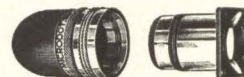

Westbury, L. I.; Chicago; Phoenix; Burlington, Mass.; Syracuse, N. Y.;

# LOCAL

Salt Lake City; Bellevue, Wash.; San Diego, L. A.; Sunnyvale, Cal.

CIRCLE 207 ON READER SERVICE CARD

## 20 to 200 D.P.

Send your prints for quotations

- SPURS
- HELICALS
- WORM AND WORM GEARS
- STRAIGHT BEVELS
- LEAD SCREWS
- RATCHETS
- CLUSTER GEARS
- RACKS
- INTERNALS
- ODD SHAPES

Production of fine-pitch gears of extreme accuracy for all kinds of instruments is a specialty of ours.

FOR INSTRUMENTS

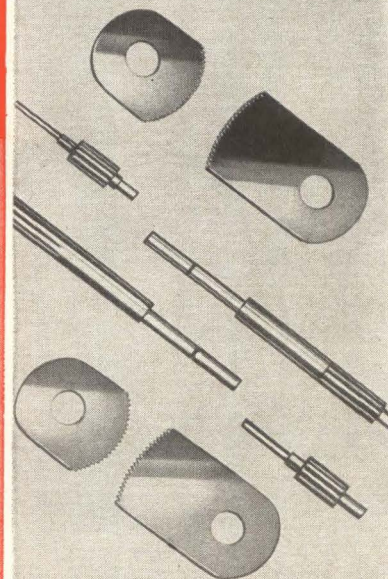

THE *Finest* IN GEARS

## Beaver Gear Works Inc.

1021 PARMELE STREET, ROCKFORD, ILLINOIS





**NOW!!**  
a bright new  
name in space

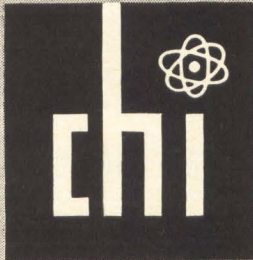

COLLEGE HILL  
INDUSTRIES, INC.  
formerly

**Speidel** CORPORATION  
INDUSTRIAL DIVISION

**Manufacturers of...  
Recorder-Reproducers  
& Pressure Switches**

CHI has taken over completely, the former Speidel Industrial Division... plant, equipment, personnel and products. This means the same people will continue to make the famous Inertia Compensated Recorder-Reproducers and Pressure Switches you have known as Speidel. On this foundation, we are building CHI, a new and growing company with new products to be announced soon.

So watch for this name — College Hill Industries, Inc. — it will play a star role in outer space achievements.

WARWICK  
INDUSTRIAL  
DRIVE,  
WARWICK  
RHODE  
ISLAND



College Hill Industries, Inc.

## PEOPLE AND PLANTS

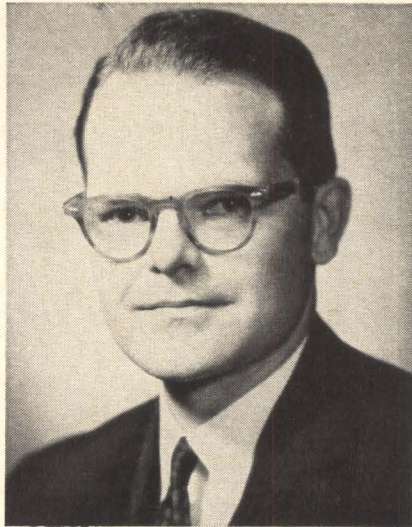

P. W. Knaplund



T. R. Horton

## IBM Promotes Two Executives

INTERNATIONAL BUSINESS MACHINES Corporation has announced the promotion of Paul W. Knaplund to assistant group executive for product and profit planning. He was general manager of the company's Advanced Systems Development division.

In this newly created position, Knaplund will have group responsibility for directing the planning of product development programs of the General Products, Data Systems and Components divisions. He reports to John W. Gibson, group executive of these engineering and manufacturing groups.

Thomas R. Horton, formerly corporate director of systems and application engineering, succeeds Knaplund as general manager of the Advanced Systems Development division.

### Westinghouse Fills Seven Key Posts

APPOINTMENTS of Frank B. Gunter and six others to key management posts at the Westinghouse Defense and Space Center, Baltimore, Md., have been announced.

James M. Beggs, Defense and Space Center vice president in charge of the Surface division, named Gunter manager of the division's radar department. Gunter is a 19-year veteran of Westinghouse.

Other appointments in the department include: C. H. McAdie as manager of advanced radar programs, J. L. Mitchell as program manager of tactical radar programs, F. J. Rutter as program manager of shipborne radar programs, and W. R. Donsbach as program manager of fixed radar programs.

E. G. Hamer was named European managing director for the Westinghouse electronics defense group and W. A. Carlson was appointed marketing manager of the surface radar department.

### Borg-Warner Elevates Cook

BORG-WARNER CORPORATION has announced the elevation of William L. Cook to president and general manager of its Controls Division in Santa Ana, Calif.

Formerly manager of Borg-Warner's Pesco Products Division Western Branch in Burbank, Calif., Cook has been acting as vice president and general manager of the Controls Division since it was combined with the Burbank operation under the overall supervision of Pesco presi-

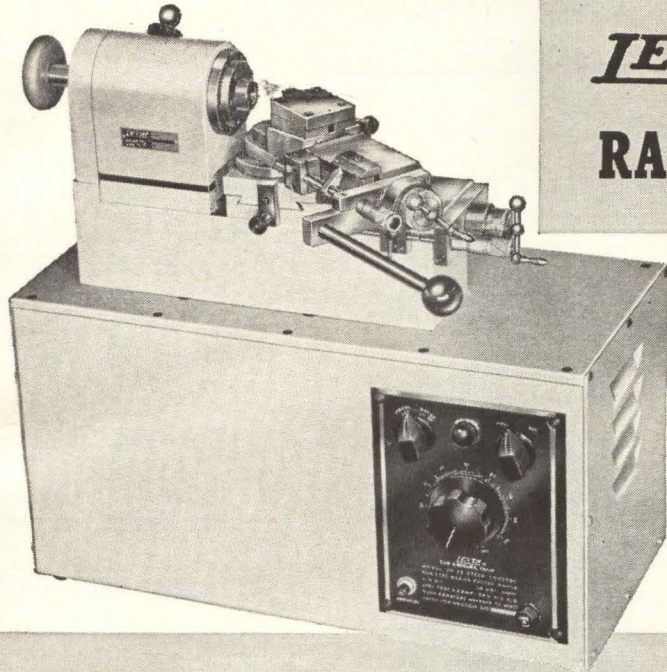

## ***LEVIN* PRECISION MICRO-RADIUS TURNING MACHINE**

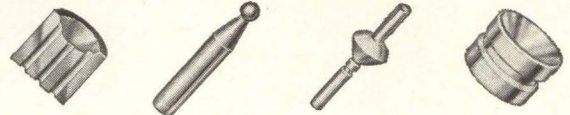

**RADII FROM .000" UP TO ONE INCH – CONCAVE OR CONVEX**

Here is a machine designed specifically for turning of accurate short radii in second operation work. This is not a lathe attachment, but rather a completely self-contained unit. It is available in  $\frac{3}{16}$ ",  $\frac{5}{16}$ ", and  $\frac{1}{2}$ " collet capacities, with and without a production collet closer.

For full information and the name of your nearest authorized Levin representative, write

# ***LEVIN***®

**LOUIS LEVIN & SON, INC.**

3573 Hayden Ave.

Culver City, California

**CIRCLE 67 ON READER SERVICE CARD**

### **TO ORDER REPRINTS**

**Fill in, cut out coupon below, insert in envelope and mail to:**

**electronics**

**Reprint Dept.**

**330 W. 42nd Street, New York, N. Y. 10036**

### **REPRINT ORDER FORM**

**For Listing of Reprints Available See Reader Service Card**

**(To help expedite mailing of your reprints please send cash, check or money order with your order.)**

**For Reprints of the latest Special Report; Electronics Markets, New Directions 1963-64-67**

Send me . . . . . Reprints of Key No. R-47 at 50¢ each.

For Reprints of previous **Special Reports** or **Feature Articles** fill in below:

Send me . . . . . Reprints of Key No.(s) . . . . . @ . . . . . ¢ each. (For prices, see Reader Service Card.)

**\*For orders of Bulk Reprints of other editorial articles in this issue or past issues:**

Send me . . . . . Reprints of pages no.(s) . . . . . of issue date . . . . . of article entitled . . . . .

**\*Minimum bulk order 100 copies. You will be advised of costs by return mail.**

**Name** . . . . .

**Number and Street** . . . . .

**City, Zone No., State** . . . . .

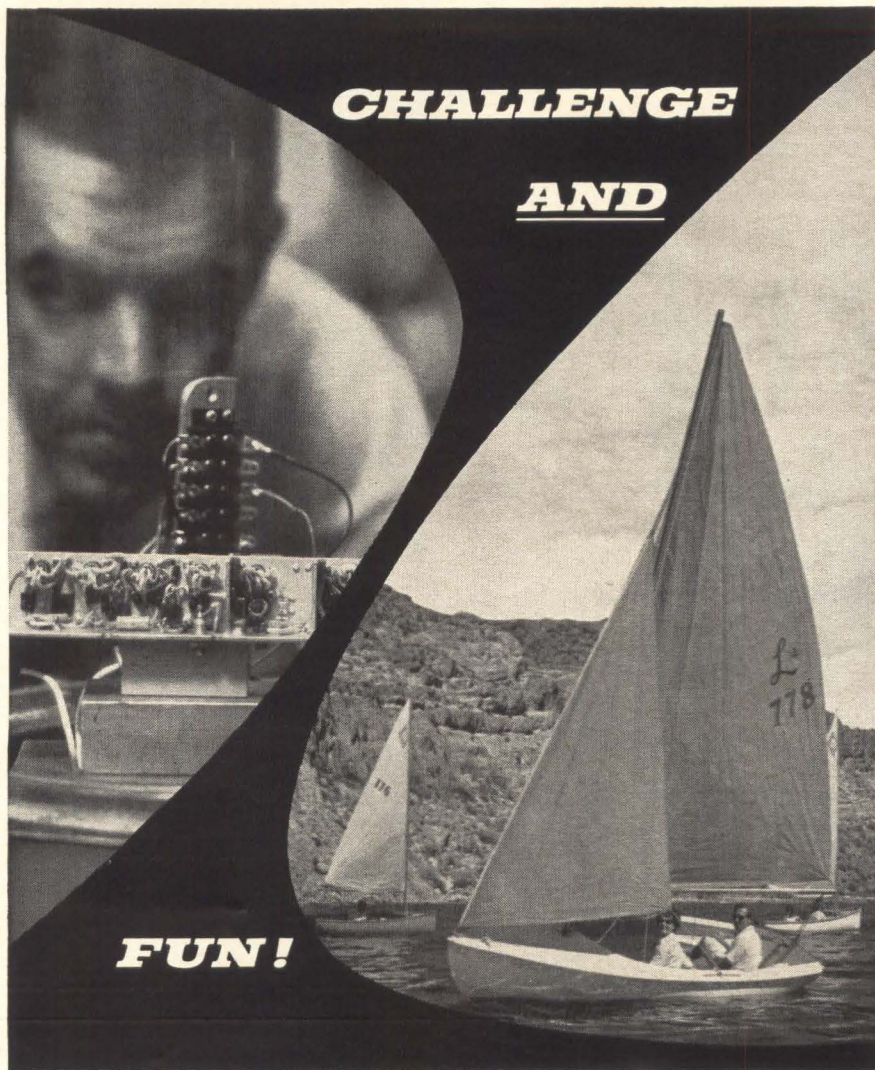

### *Ideal combination at Motorola/Phoenix*

If you are seeking a challenge in aerospace electronics and a new world of year-round outdoor enjoyment for your family, consider Motorola in Phoenix. Here you will find intriguing challenges in advanced projects such as Gemini, Apollo and a host of others ranging from inner space to deep space exploration. All the splendor of Arizona beckons you and your family to a friendly, relaxed western way of life featuring healthful dry climate, scenic deserts, mountains and canyon lakes.

For the ideal balance of professional challenge and fun in the sun, check these outstanding opportunities at Motorola in Phoenix.

- |                                 |  |                         |
|---------------------------------|--|-------------------------|
| Antennas & Propagation          | Reliability Analysis                   | Guidance & Navigation   |
| Solid State R. F.               | Parts Reliability                      | Command & Control       |
| Microwave Techniques            | Reliability Program Coordination       | Space Communications    |
| Missile & Space Instrumentation | Data Acquisition, Processing & Display | Signal Processing       |
| Operational Support Equipment   | CW Transponders                        | ECM, CCM & Surveillance |
| Integrated Circuitry            | Radar & Radar Transponders             | Tracking & Telemetry    |

*Contact Phil Nienstedt, Manager of Recruitment, Department 651*



**Military Electronics Division** • Western Center • P.O. Box 1417, Scottsdale, Arizona  
 MOTOROLA ALSO OFFERS OPPORTUNITIES AT CHICAGO, ILLINOIS — AN EQUAL OPPORTUNITY EMPLOYER

dent Donald R. Spotz a little over a year ago. Spotz continues as president of the Pesco Products Division in Bedford, O.

### **Assembly Products Elects Crowdes**

GEORGE J. CROWDES, JR., has been elected vice president-engineering of Assembly Products, Inc., Chesterland, O.

Since joining API in 1957, Crowdes has headed design and development work on indicating and controlling instruments.

### **PEOPLE IN BRIEF**

**Edward Hoover** promoted to director of engineering at Correlated Data Systems Corp. **Stanley J. Golembiewski** leaves RCA to join International Resistance Co.'s Instrumentation & Systems div. as mgr. of logic systems. **John A. Chartz** advances to exec v-p of Dalmo Victor Co. **Lloyd R. Morrow**, formerly with Struthers-Dunn, Inc., named product mgr. in charge of relays and electrical components for Cook Electric Co.'s Wirecom div. **Robert W. Sanders** moves up to mgr. of engineering of the Consumer Products div., The Magnavox Co. **W. J. Tejral** raised to mfg. mgr. at Markite Corp. **Frank Lowell**, ex-Bulova Watch Co., appointed g-m of Guidance Controls Corp. **John L. Boyer**, previously with Westinghouse Electric, named senior engineering consultant at International Rectifier Corp. **Frank Gard Jameson** elevated to v-p and asst. to the president of Ryan Aeronautical Co. **Kenneth A. McQueeney**, mgr. of engineering, elected v-p and g-m of Alto Scientific Co., Inc. The Bendix Corp. ups **Victor D. Ellison** to chief engineer for instruments at its Montrose div. **Herbert U. Erston**, from Induction Heating Corp. to Lepel High Frequency Laboratories, Inc. as chief of mechanical engineering. He succeeds **Anthony Vescuso**, now director of R&D. **Seymour L. Blum** leaves Raytheon Co. to become asst. director of research to head the ceramics operations of IIT Research Institute.

## SEARCHLIGHT SECTION

(Classified Advertising)

**BUSINESS OPPORTUNITIES**  
EQUIPMENT - USED or RESALE

### DISPLAYED RATE

The advertising rate is \$27.25 per inch for all advertising appearing on other than a contract basis. Contract rates quoted on request. AN ADVERTISING INCH is measured 7/8 inch vertically on one column, 3 columns—30 inches—to a page. EQUIPMENT WANTED or FOR SALE ADVERTISEMENTS acceptable only in Displayed Style.

### UNDISPLAYED RATE

\$2.70 a line, minimum 3 lines. To figure advance payment count 5 average words as a line.

PROPOSALS, \$2.70 a line an insertion.

BOX NUMBERS count as one line additional in undisplayed ads.

DISCOUNT OF 10% if full payment is made in advance for four consecutive insertions of undisplayed ads (not including proposals).

## ARROW

FREIGHT FORWARDERS

Div. of LIFSCHULTZ TRANSPORT, Inc.

### FASTEST COAST TO COAST

5th DAY from EAST COAST to CALIFORNIA, ARIZONA and NEVADA

7th DAY to EAST COAST from CALIFORNIA, ARIZONA and NEVADA

Specialists in Shipment of Electronics Products  
Call for information

NEW YORK — PHILADELPHIA  
BALTIMORE — BOSTON — NEW JERSEY  
HOLYOKE — NEW HAVEN — PROVIDENCE  
LOS ANGELES — SAN FRANCISCO

CIRCLE 950 ON READER SERVICE CARD

RADAR AUTO-TRACK & TELEMETRY ANTENNA PEDESTALS 3 & 10 CM. SCR 584 AUTOTRACK RADARS. M-33 RADAR TPS-1D SEARCH. APS-45 TPS-10D HT. FINDERS. WX RADARS. FPN-32CA. APS-10. APS-15B. APS-27 (AMTI) SEARCH. ■ ■ ■ APN-102 DOPPLER. DOZENS MORE. CARCINOTRONS. PFN'S. .25-.5-1.2-3-6 MEGAWATT PULSE MODULATORS. CAVITIES. PULSE TRANSFORMERS. IF STRIPS. WAVEGUIDE. BENDS 200 MC. 1 KMC. 3 KMC. 6 KMC. 9 KMC. 24 KMC. RF PKGS.

**RADIO RESEARCH INSTRUMENT CO.**  
550 5TH AVE., NEW YORK 36, N. Y. JU 6-4691

CIRCLE 951 ON READER SERVICE CARD

## OPTICAL BENCHES

\$13. to \$13,000. New Catalog

THE **Ealing** CORP.

2250 Massachusetts Avenue, Cambridge, Mass., 02140

CIRCLE 952 ON READER SERVICE CARD

### LOOKING FOR USED/SURPLUS ELECTRONIC EQUIPMENT/COMPONENTS?

For an up-to-date listing of such equipment see Searchlight Section of January 10th.

## EMPLOYMENT OPPORTUNITIES

The advertisements in this section include all employment opportunities—executive, management, technical, selling, office, skilled, manual, etc.

Look in the forward section of the magazine for additional Employment Opportunities advertising.

# Wisconsin Openings

The Louis Allis Co. is expanding its research and development activity and has immediate openings for engineers interested in:

## Digital Control Electronics

### SENIOR SCIENTIST

Experience necessary in design and development in small special purpose computers.

### ADVANCED RESEARCH ENGINEER

Must be capable of highly creative work and systems utilizing digital electronic controls.

### ELECTRICAL ENGINEERS

Experience required in control logic for static power conversion equipment. Must have skill in digital control logic circuitry including oscillators, counters and shift registers.

### SYSTEM ANALYST

Experience necessary in complete preliminary analysis of engine, generator, static power and digital control systems.

### SENIOR ENGINEER

Experience necessary in design and development of advanced static inverters, converters and controls or related power electronics.

### ELECTRICAL ENGINEER

Experience necessary in controlled rectifier conversion equipment including inverters, converters, cycloconverters. Skill necessary in high frequency switching with stepped wave fronts.

Send Resume Giving Details of Education,  
Experience and Salary Requirements to  
**Kirby Stanat**

# THE LOUIS ALLIS CO.

Milwaukee 1, Wis.

An Equal Opportunity Employer

### POSITION VACANT

Electronic Engineers, Mechanical Engineers, Consultants, Managers—Work for leading firm of licensed professional Engineers. Write to United Engineers, 150 Causeway Street, Boston 14, Mass.

### EMPLOYMENT SERVICES

Resumes and application letters that make employers want you. Composed, printed by Executive Resumes, Dept. F, Executive Suite, 744 Broad St., Newark, N. J.

### • WANTED

Anything within reason that is wanted in the field served by Electronics can be quickly located through bringing it to the attention of thousands of men whose interest is assured because this is the business paper they read.



## E. E.'s

for FEE-PAID Positions  
**WRITE US FIRST!**

Use our confidential application for professional, individualized service . . . a complete national technical employment agency.

**ATOMIC PERSONNEL, INC.**

Suite 1207L, 1518 Walnut St., Phila. 2, Pa.

### EMPLOYMENT PROBLEM?

When you are in need of specialized men for specialized jobs, contact them through an employment ad in this publication.

# INDEX TO ADVERTISERS

• Acme Electric Corp.....	45
Allen-Bradley Co.....	43
Amperite.....	14
• Amphenol A Div. of Amphenol-Borg Electronics Corp.....	13
Artisan Organs.....	64
• Avnet Electronics Corp.....	64, 65
Beaver Gear Works, Inc.....	65
Bristol Company, The.....	59
Brush Instruments Div. of Clevite Corp.....	3rd cover

• Chester Cable Corp.....	60, 61
College Hill Industries, Inc.....	66
Consolidated Electroynamics Corp.....	37, 38
Coto-Coil Co., Inc.....	65

• Driver Co., Wilbur B.....	44
duPont de Nemours & Co., Inc., E. I.....	16
• Dymec A Division of Hewlett-Packard Co.....	4
Dynamics Instrumentation Co.....	64

Electronic Research Associates, Inc.....	41
---	----

Flying Tiger Line .....	21
-------------------------	----

General Electric Co. Silicone Products Dept.....	22
General Radio Co.....	2nd cover
German American Chamber of Commerce.....	39
Gertsch Products, Inc.....	58
• Globe Industries Inc.....	42

• ITT Industrial Laboratories... ..	50
-------------------------------------	----

Jerrold Electronics Corp.....	6
-------------------------------	---

• Knights Company, James .....	62
--------------------------------	----

Levin and Son, Inc., Louis .....	67
• Linen Thread Co., Inc., The .....	57

Machlett Laboratories Inc., The .....	11
Mallory and Co., Inc., P. R. .....	8, 9
Marconi Instruments .....	63
Markem Machine Co. ....	12
Melpar Inc.....	57
Mitsumi Electric Co., Ltd.....	62

New York State Dept. of Commerce .....	61
• North Atlantic Industries, Inc... ..	51

• Ohmite Mfg. Co.....	7
-----------------------	---

Pamotor Inc. ....	57
-------------------	----

Radio Corporation of America 4th cover	
• Rosemount Engineering Co....	46

Sprague Electric Co.....	3
Struthers-Dunn Inc.....	40
Sylvania Electronic Systems- West .....	54, 55

Texas Instruments Incorporated Industrial Products Group .....	15
Triplett Electrical Instrument Co.	53

Wayne George Corp.....	49
------------------------	----



## CLASSIFIED ADVERTISING

F. J. Eberle, Business Mgr. (2557)

## EMPLOYMENT OPPORTUNITIES 68-69

## EQUIPMENT

(Used or Surplus New)  
For Sale .....

CLASSIFIED ADVERTISERS INDEX	
Allis Co., Lewis .....	69
Arrow Freight Forwarders .....	69
Atomic Personnel Inc.....	69
Ealing Corp.....	69
Motorola Inc.....	68
• Radio Research Instrument Co.	69



• See advertisement in the July 25, 1963 Issue of electronics Buyers' Guide for complete line of products or services.

---

This Index and our Reader Service Numbers are published as a service. Every precaution is taken to make them accurate, but **electronics** assumes no responsibilities for errors or omissions.

---

## electronics

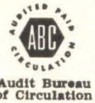

Audit Bureau  
of Circulation



Associated Business  
Publications

AUDITED PAID CIRCULATION

**JAMES T. HAUPTLI (2210)**  
Advertising Sales Manager

**HENRY M. SHAW (3485)**  
Market Research Manager

**DAVID M. TEMPEST (3139)**  
Promotion Manager

### electronics Buyers' Guide

**R. S. QUINT (2335)**  
General Manager

**RICHARD J. TOMLINSON (3191)**  
Business Manager

**THEODORE R. GEIPEL (2044)**  
Production Manager

**NEW YORK TELEPHONE:** Dial Direct:  
971 plus number in parenthesis,  
Area Code 212

## ADVERTISING REPRESENTATIVES

**ATLANTA, GA. 30309**  
Michael H. Miller, Robert C. Johnson  
1375 Peachtree St. N.E.,  
Trinity 5-0523 (area code 404)

**BOSTON, MASS. 02116**  
William S. Hodgkinson  
McGraw-Hill Building, Copley Square,  
Congress 2-1160 (area code 617)

**CHICAGO, ILL. 60611**  
Harvey W. Wernecke,  
Robert M. Denmead  
645 North Michigan Avenue,  
Mohawk 4-5800 (area code 312)

**CLEVELAND, OHIO 44113**  
Paul T. Fegley  
55 Public Square, Superior 1-7000  
(area code 216)

**DALLAS, TEXAS 75201**  
Frank Le Beau  
The Vaughn Bldg.,  
1712 Commerce St.  
Riverside 7-9721 (area code 214)

**DENVER, COLO. 80202**  
John W. Patten  
Tower Bldg., 1700 Broadway,  
Alpine 5-2981 (area code 303)

**HOUSTON, TEXAS 77025**  
Kenneth George  
Prudential Bldg., Halcombe Blvd.,  
Riverside 8-1280 (area code 713)

**LOS ANGELES, CALIF. 90017**  
Ashley P. Hartman, John G. Zisch,  
1125 W. 6th St., Huntley 2-5450  
(area code 213)

**NEW YORK, N. Y. 10036**  
Donald H. Miller (212) 971 3615  
George F. Werner (212) 971 3617  
Donald R. Furth (212) 971 3616  
500 Fifth Avenue

**PHILADELPHIA, PA. 19103**  
Warren H. Gardner, William J. Boyle  
6 Penn Center Plaza,  
LOcust 8-6161 (area code 215)

**SAN FRANCISCO, CALIF. 94111**  
Richard C. Alcorn  
255 California Street,  
Douglas 2-4600 (area code 415)

**LONDON W1:**  
Edwin S. Murphy Jr.  
34 Dover St.

**FRANKFURT/Main:**  
Matthee Herfurth  
85 Westendstrasse

**GENEVA:**  
Michael R. Zeynel  
2 Place du Port

**TOKYO:**  
George Olcott,  
1, Kotohiracho, Shiba, Minato-ku



Brush  
lightbeam  
recorder  
eliminates  
RFI with  
silent light!

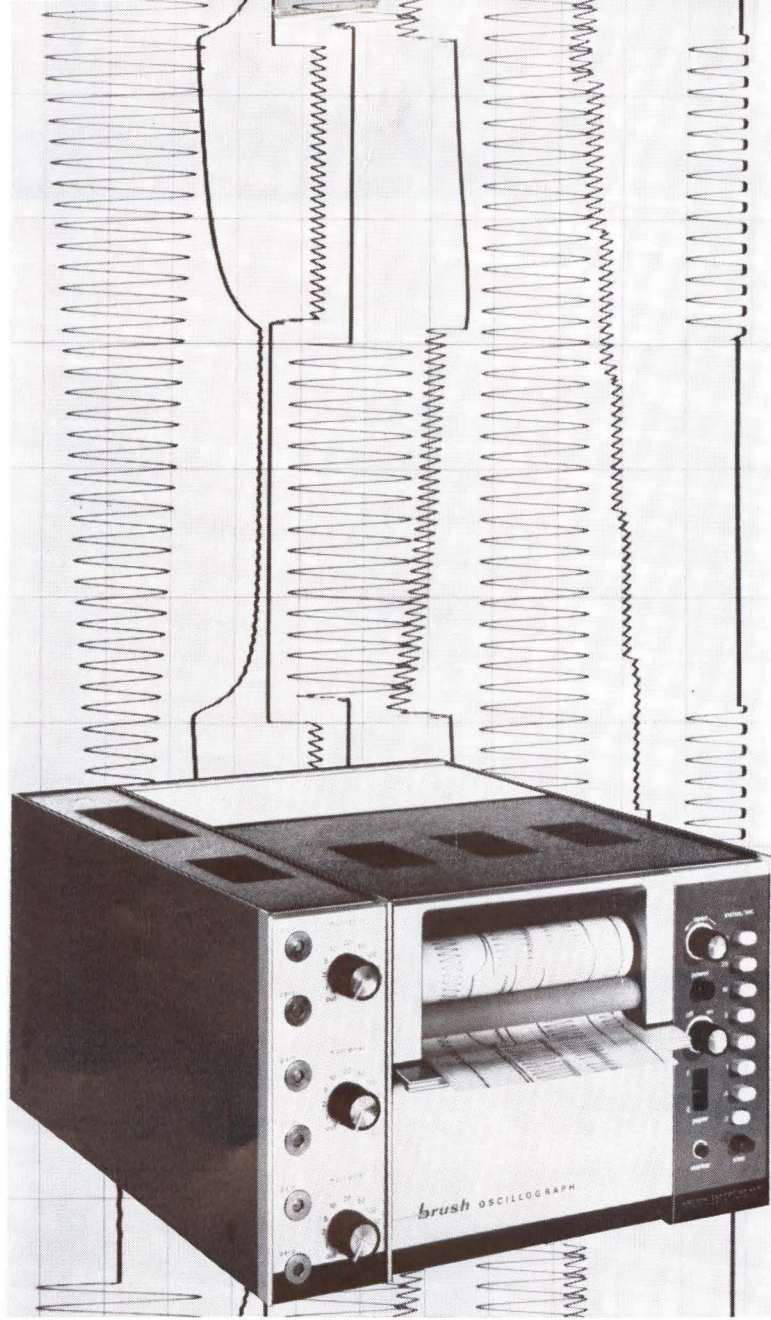

The unique incandescent optical system of this new direct-print oscillograph completely eliminates confused data caused by generation of RF interference into associated equipment. It is the only lightbeam recorder that meets RFI specs . . . MIL-I-26600 and MIL-I-6181D. Whether your application is industrial or aero-space, check out these important facts.

**Start and Re-start Recording time . . . 50 milliseconds**

**Writing Speed . . . Greater than 30,000 in./sec.**

**Companion Amplifiers . . . Especially Designed**

**Complete Line of Accessories**

**8 Pushbutton Record Speeds**

**Internal Chart Take-up**

**High Contrast Traces**

**16 Channels**

Now you can record over the whole range of most-used frequencies with Brush systems incorporating all the known refinements in oscillography. Write for full details.

**brush INSTRUMENTS**

DIVISION OF CLEVITE 37TH AND PERKINS, CLEVELAND 14, OHIO

CIRCLE 901 ON READER SERVICE CARD



**7" Direct-View DST—RCA-C73983**—The ability to store information for many seconds at initial brightness levels makes the C73983 highly suitable for use in display systems employing very slow scanning speeds such as long-range radar, slow-scan TV, and sonar. A selective erasing feature permits the displayed information to be retained at full brightness until it is to be replaced by new information. The C73983 provides a 5¼-inch-diameter display having sufficient brightness to permit viewing in well-lighted areas.

**10" Direct-View DST—RCA-4412**—The ability to store information for many seconds while continuously presenting it in a large non-flickering display makes the 4412 a highly recommended tube for special electronic display systems. The range of possible applications in which the 4412 may be used is extended to the most sophisticated military-airborne equipment by an extremely rugged tube structure.

**5" Direct-View DST—RCA-7268**—High brightness and an adjustable rate of information decay make the 7268 highly useful for the display of information under daylight-viewing conditions in airborne fire-control radar systems. This tube provides a full 4-inch-diameter display having excellent uniformity and positional accuracy under the severe environmental conditions encountered in airborne military equipment.

## RCA DISPLAY STORAGE TUBES

### A Line Tailored to Your Application

Reliability, high resolution, and writing speeds tailored to your application make RCA Display Storage Tubes ideal for data readout, sonar, radar, or your special electronic display system. Offering a wide choice of levels of brightness and resolution in half-tone display, most of these tubes are ruggedly designed to withstand severe environmental conditions of altitude, temperature, humidity, vibration, and shock.

RCA's Display Storage Tube line offers you a choice of display area, single or multiple writing guns, and electrostatic or magnetic deflection. Ask about them locally at your authorized RCA Industrial Tube Distributor.

**RCA FIELD OFFICES—OEM SALES:** Newark 2, N. J., 32-36 Green St., (201) 485-3900 • Chicago 54, Ill., Suite 1154, Merchandise Mart Plaza, (312) 527-2900 • Los Angeles 22, Calif., 6801 E. Washington Blvd., (213) RA 3-8361 • **GOVERNMENT SALES:** Harrison, N. J., 415 South Fifth St., (201) 485-3900 • Dayton 2, Ohio, 224 N. Wilkinson St., (513) 461-5420 • Washington 6, D. C., 1725 "K" St., N.W., (202) FE 7-8500 • **INTERNATIONAL SALES:** RCA International Div., Clark, N. J., (201) 382-1000

**ALSO AVAILABLE FROM YOUR AUTHORIZED RCA INDUSTRIAL TUBE DISTRIBUTOR**

**SEND FOR NEW RCA DISPLAY STORAGE TUBE BOOKLET, 1G1144**

This booklet, 1G1144, contains information on RCA's Display Storage Tube line. It is available by writing: Commercial Engineering, Section A-19-Q-3, RCA Electronic Components and Devices, Harrison, N. J.

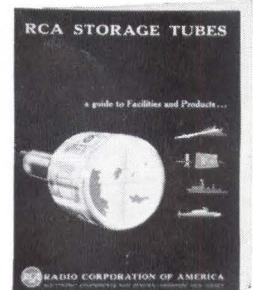

**The Most Trusted Name in Electronics**