

8050

II

CONTROL DATA[®] 8050
INFORMATION CONTROL SYSTEM
USER'S MANUAL

8050

II

CONTROL DATA[®] 8050
INFORMATION CONTROL SYSTEM
USER'S MANUAL

Any comments concerning this manual should be addressed to:

CONTROL DATA CORPORATION

Publication Department

9549 PENN AVENUE SOUTH

MINNEAPOLIS, MINNESOTA 55431

CONTENTS

INTRODUCTION	1
FUNDAMENTAL 8050 CONCEPT	1
SYSTEM FEATURES	3
THE COMMUNICATION NETWORK	3
A. Number of Lines	3
B. Line Speed	3
C. Terminal Equipment	3
D. Terminal Addressing	5
E. Types of Terminals	5
1. Polled	5
2. Non-Polled Send/Receive	5
3. Send Only	5
4. Receive Only	5
5. Mixed	5
INPUT FROM THE NETWORK	7
A. Single-Message Transmissions	7
1. Format	7
2. Length	8
B. Multiple-Message Transmissions	9
1. Format	9
2. Length	9
SYSTEM CONTROL OF NETWORK INPUT	10
A. Polled Terminals	10
B. Non-Polled Terminals	10
PROCESSING NETWORK INPUT	11
A. Processing Modes	11
1. Modified Store and Forward	11
2. Store and Forward	11
B. Routing	11
1. Normal	11
2. Priority	12
3. Alternate	12
4. Intercept	12

C. Editing	12
1. Leader and Trailer Characters	12
2. Spurious Characters	12
3. Blanks	13
4. Call – Directing Codes	13
SYSTEM OUTPUT TO THE NETWORK.	13
A. Transmission Algorithms	13
1. Single Line or Line-Sharing Terminals	13
2. Multi-Line Terminals	13
B. Transmission Format	13
OTHER SYSTEM INPUT AND OUTPUT	14
A. Traffic Volume and Distribution Data	14
B. Magnetic Tape	14
ERROR DETECTION AND REPORTING.	14
A. Hardware Failures	14
B. Traffic Errors	14
C. System Operator Errors	17
SYSTEM CONTROL	17
A. Internal Compensation for System Abnormality	17
1. Core Storage Overload	17
2. Drum Storage Overload	17
3. Major Line or Network Failure	17
4. Drum Failure	17
5. Magnetic Tape Failure	18
B. Operator Control	18
1. Controls which Affect Network Input	18
2. Controls which Affect Message Routing	18
3. Controls for Extracting Accumulated Data.	18
4. Controls for Generating Test and Emergency Output	19
5. Controls which Affect Magnetic Tape	19
SYSTEM UTILITY PACKAGE	19
A. Network Definition or Modification	19

B. Program Maintenance	19
APPENDICES	21
A. Minimum Simplex 8050 Configuration	21
B. Minimum Duplex 8050 Configuration	22
C. 5 Level Baudet Code	23
D. 8050 Optional Features	24

FIGURES

1. 8050 System	vi
2. Network Flow	2
3. Terminal Types	4
4. 8076 Communication Terminal Controller (Containing Telegraph Terminal)	6
5. Single-Message Input Transmission Format	9
6. Single-Message Output Transmission Format	13
7. 8050 System Console Closeup	16

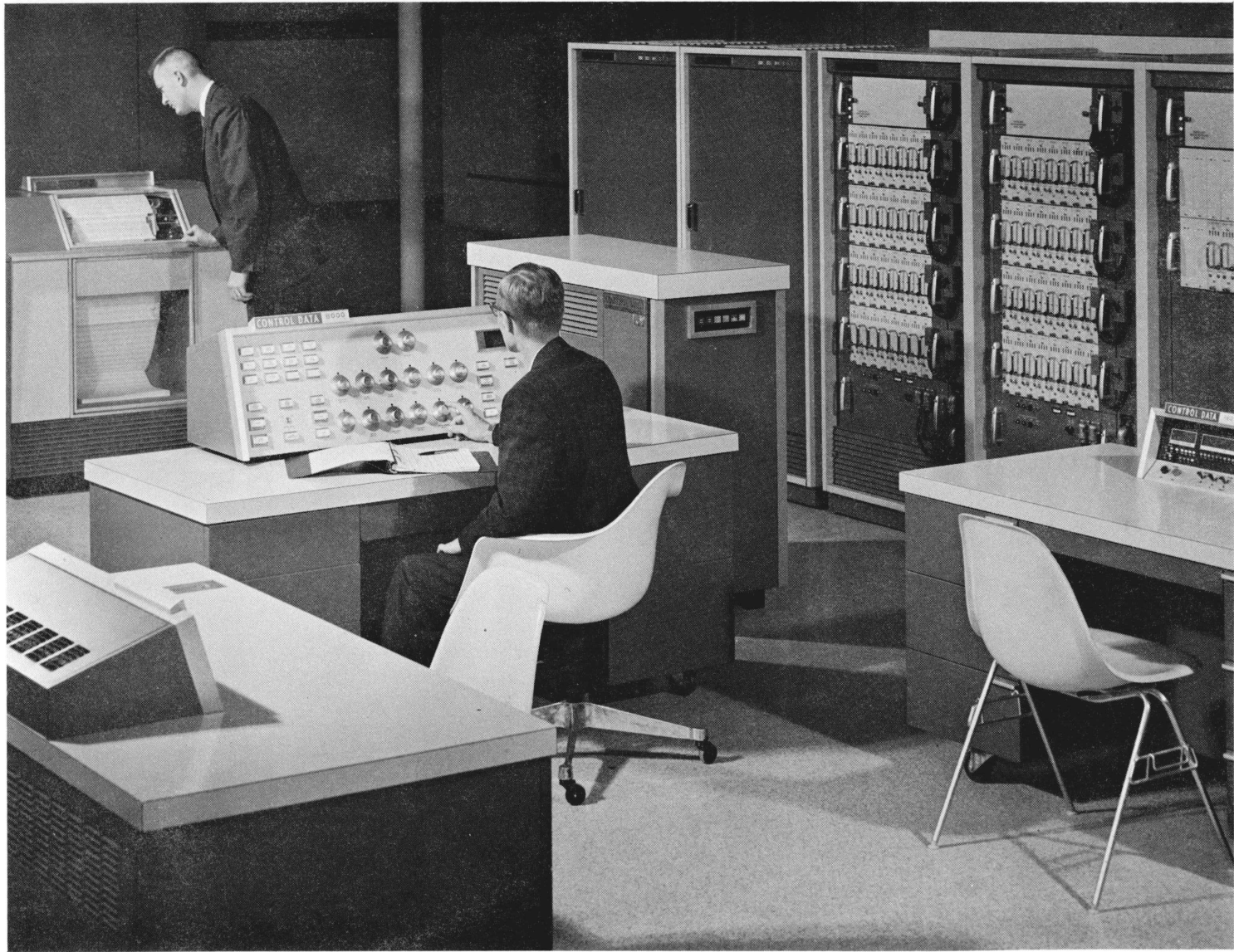

Figure 1. 8050 System

INTRODUCTION

This document describes the performance of the Control Data 8050 Information Control System as implemented on the Control Data 8090 Computer. The hardware and software required to achieve this performance is currently available for installation as a complete package.

These specifications provide traffic formats and identification characteristics similar to those used on electromechanical equipment such as:

- Finac
- Functional Torn Tape
- Belfast
- 81-D-1
- 83
- Plan 111
- Plan 115
- Plan 116
- Plan 51
- Plan 54
- Plan 56
- Plan 57

These are offerings by American Telephone and Telegraph Company and Western Union.

Conversion from this type of electromechanical equipment to the Control Data 8050 is simple and straightforward. Very little change, if any, is required for existing terminals although the increased efficiency and speed of the 8050 will sometimes suggest alternate line arrangements.

FUNDAMENTAL 8050 CONCEPT

The Control Data 8050 Information Control System can be thought of as a central routing and process function operating in a modified store and forward mode.

All traffic introduced into the communication network goes directly to the 8050. There traffic is analyzed to determine ultimate destination and retransmitted as outbound paths become available. Assuming path availability, retransmission is initiated prior to completion of input (the modified store and forward concept) to minimize point-to-point elapsed time.

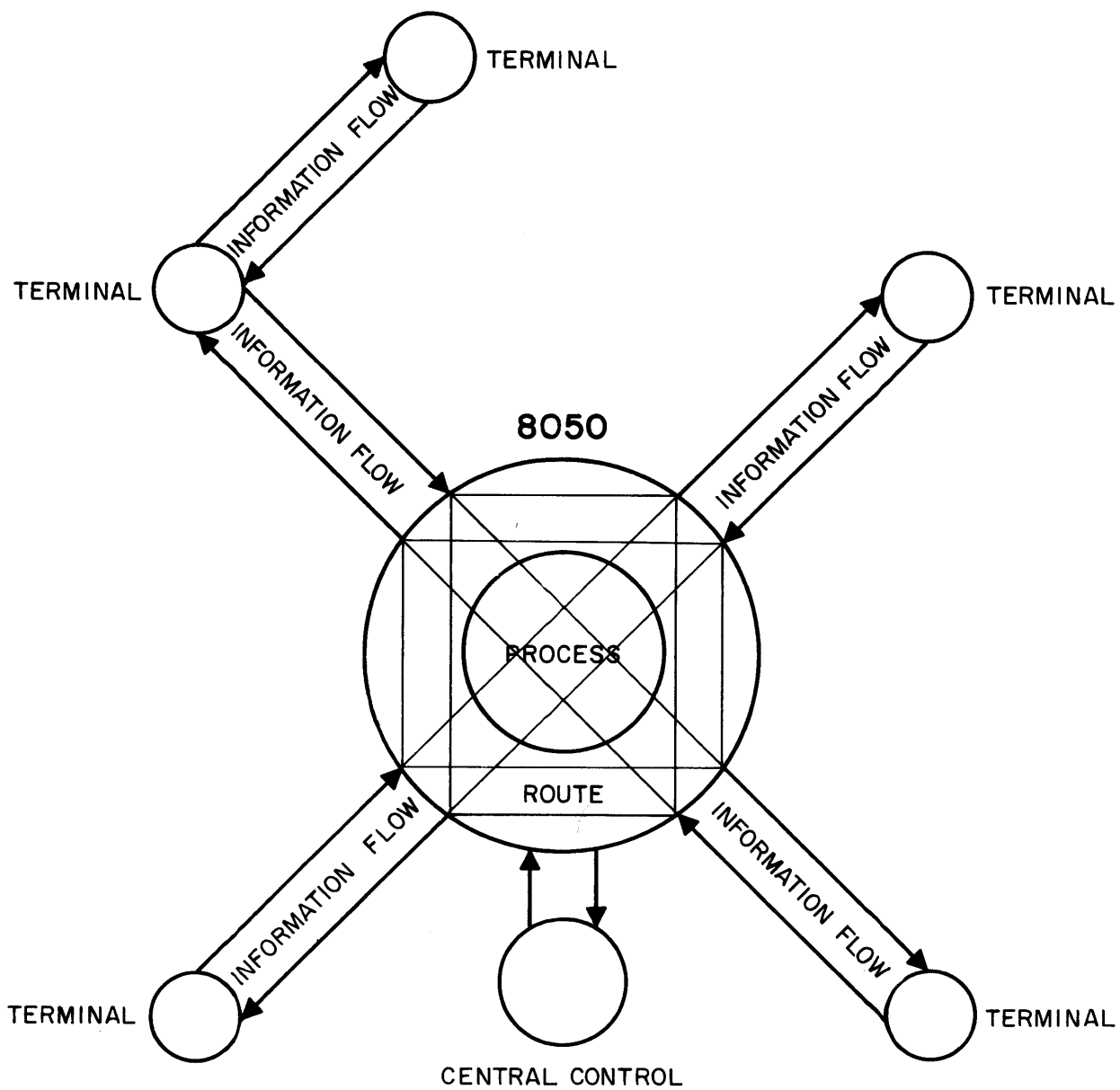

Figure 2. Network Flow

SYSTEM FEATURES

- ◆ Up to 104 Network Terminals
- ◆ Short point-to-point elapsed time through modified store and forward technique
- ◆ Two levels of message priority
- ◆ Multiple and group addressing
- ◆ Extensive error detection and reporting
- ◆ Operator modification of system behavior in real time
- ◆ Accumulation of traffic volume and distribution information
- ◆ Magnetic tape journal of all system traffic
- ◆ Comprehensive utility package for network definition and updating
- ◆ Simple line and terminal reorganization procedures to permit minimum network cost

THE COMMUNICATION NETWORK

The communication network consists of terminals and the transmission links which connect these terminals to the 8050. A **terminal** is a traffic source and/or destination and can be comprised of one or more equipments. Transmission links can be conveniently thought of as **lines**. Output lines carry traffic from 8050 to terminals; input lines carry traffic from terminals to 8050.

A. Number of Lines

The network may include up to 16 input and 16 output lines. A minimum of three output lines are used by the 8050 as **intercept** and **operator advisory** lines; the remainder can be used for normal network traffic.

B. Line Speed

The minimum permissible line speed is 60 words per minute; the maximum is 100 words per minute. Any combination of 60, 66, 75 or 100-word-per-minute lines is acceptable.

C. Terminal Equipment

All terminal equipment (page printers, tape readers, tape reperforators, etc.) must use standard 5-level teletypewriter (Baudot) code. (See Appendix C)

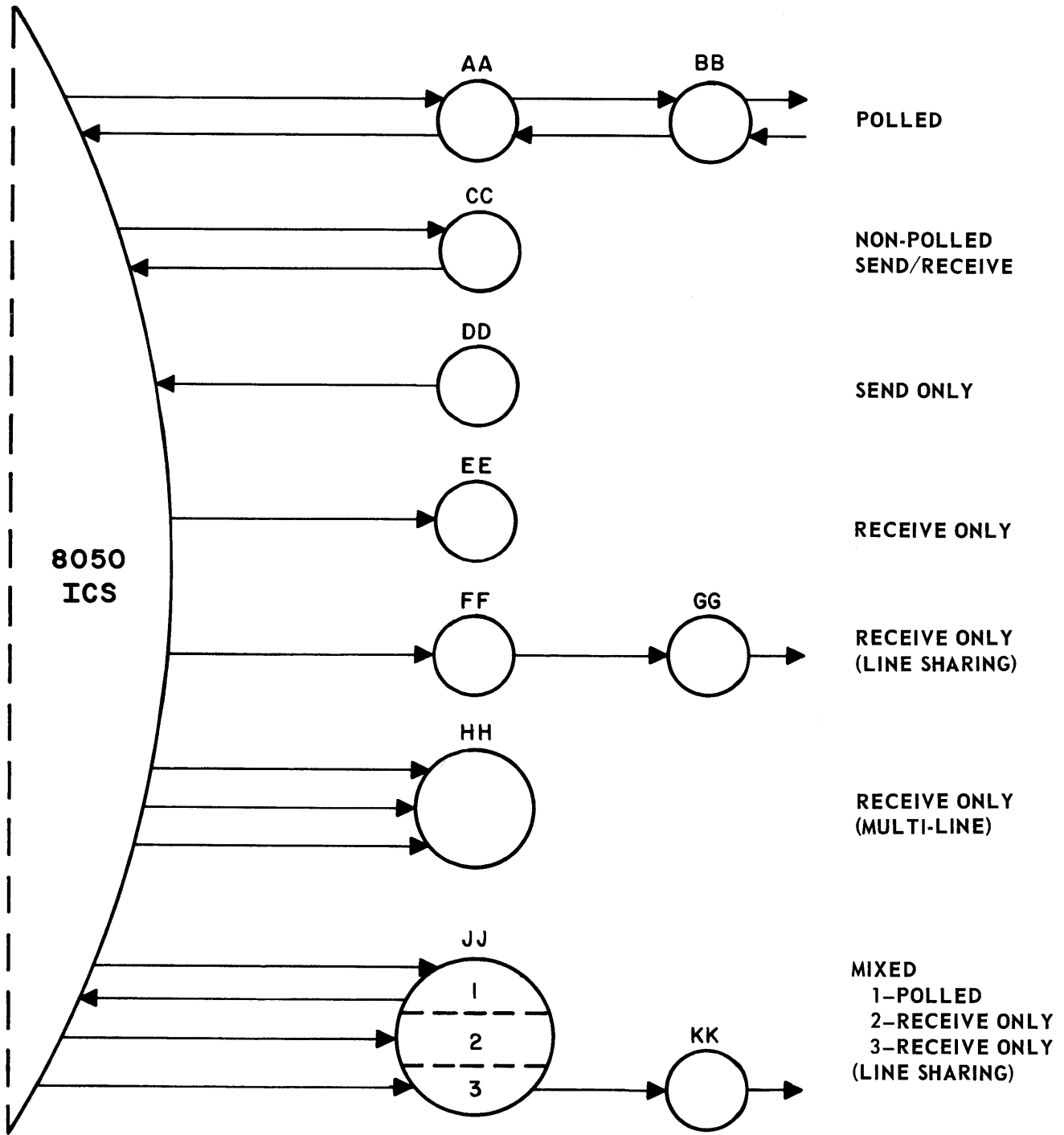

Figure 3. Terminal Types

D. Terminal Addressing

Each terminal is uniquely identified by a two-character alphabetic call-directing code. Where a terminal uses equipment which selectively reproduces only a portion of the traffic on an output line, the turn-on (Select) code must be the same as the terminal's call-directing code. Equipment of this type may also select in response to other codes, to facilitate group addressing.

E. Types of Terminals

The network may include any or all of the following terminal types.

1. Polled

A polled terminal uses one input and one output line assembled as a full duplex circuit. Invitations to send (transmitter start codes) are transmitted from the 8050 on the output line and traffic waiting at the terminal flows to the 8050 on the input line. The output line is also used to deliver traffic to the terminal.

Up to 12 polled terminals can share a single full-duplex circuit and there can be up to 8 polled circuits. Polled terminals are the **only** terminals which can share an input line.

2. Non-Polled Send/Receive

A terminal which can send and receive. This terminal requires no invitation from the 8050 to send and uses one input and one output line assembled as a full-duplex circuit. Many terminals can share the output line with this terminal but only one terminal of this type can occupy any input line.

3. Send Only

A send only terminal uses one or more input lines exclusively and can transmit to the 8050 at any time.

4. Receive Only

A receive only terminal can share an output line with other receive only terminals, use an output line exclusively, or, if traffic volume warrants, use several output lines.

5. Mixed

A terminal which is an assembly of other terminal types is permissible.

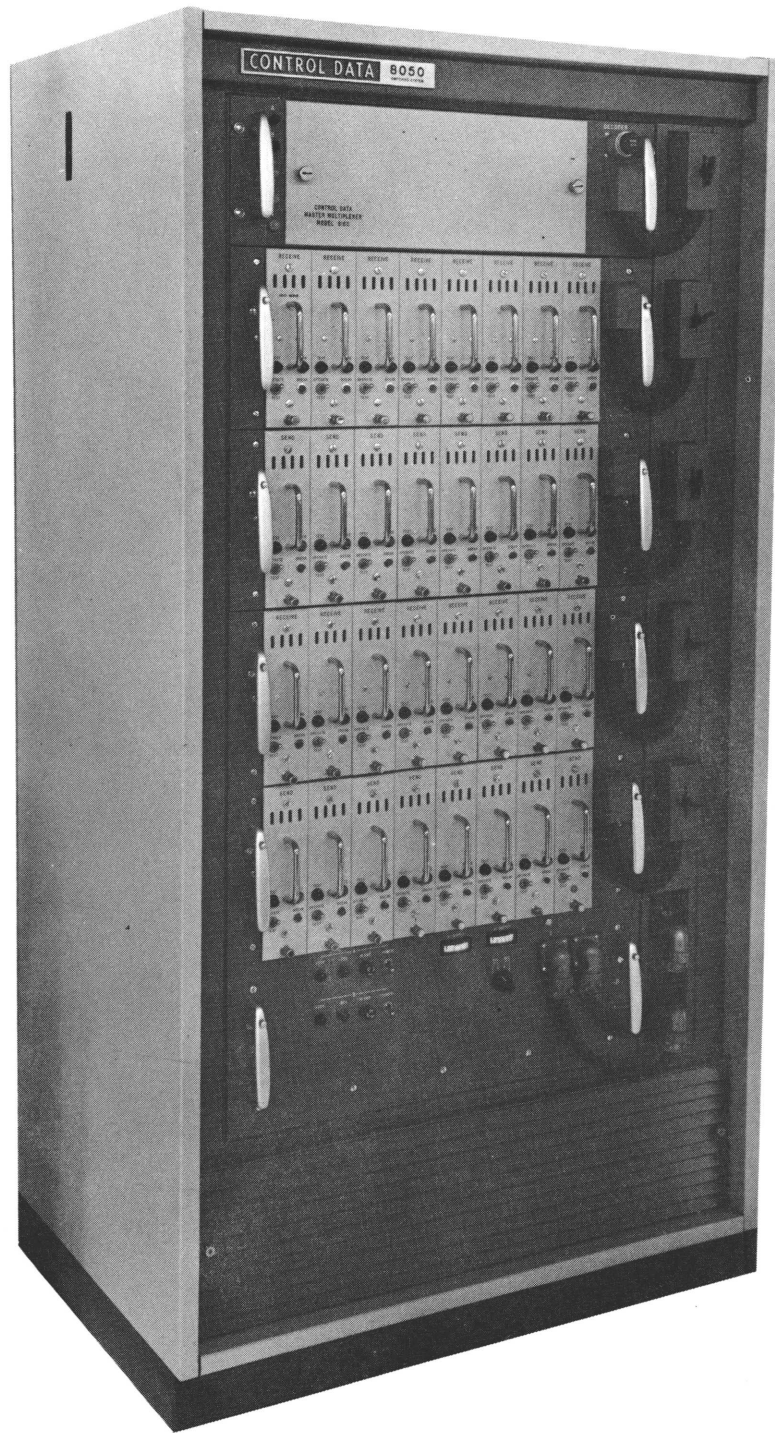

Figure 4. 8076 Communication Terminal Controller
(Containing Telegraph Terminal)

INPUT FROM THE NETWORK

The basic network input to the 8050 is a terminal transmission comprised of one or more messages.

A. Single-Message Transmissions

1. Format

The format for single-message transmissions is:

1)	2)	3)	4)	5)	6)
	Start of Message	Address and Control Information	Message Body	End of Message	
Leader	SOM	Header	Text	EOM	Trailer

1) Leader:

Consists of any number of ↓ (LTRS) characters.

2) Start-of-Message (SOM):

A message must commence with a specific 3-character code group:

↑ Z ↓

(FIGS, Z, LTRS)

3) Header:

The header immediately follows the SOM and consists of two lines.

First Line

The first line specifies only those terminals to which the message must be delivered. Each terminal is identified by two consecutive alphabetic characters (its call-directing code) which govern system routing and also select the equipment at the addressed terminal upon transmission. Call directing codes must be separated by one or more ↓ (LTRS) characters.

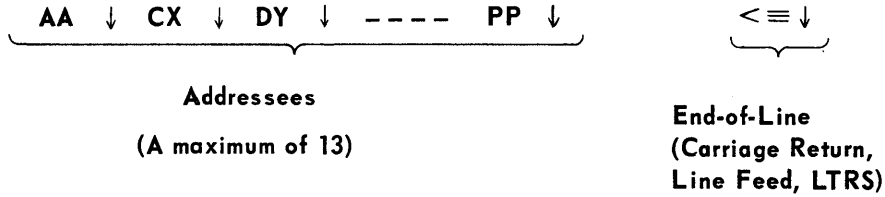

Second Line

The second line contains the originator's call directing code and a sequence number.

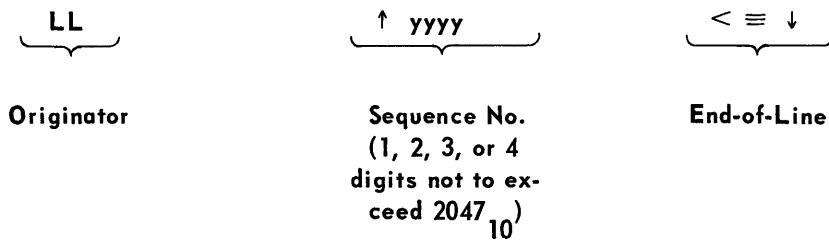

4) Text

The text is not scrutinized by the system and can include any combination of alphanumeric and control characters **except** the start-of-message or end-of-message groups.

5) End-of-Message (EOM)

End-of-Message is indicated by a specific 3-character group:

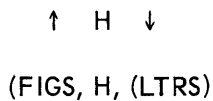

6) Trailer

Consists of any number of ↓ (LTRS) characters.

2. Length

The 8050 imposes no specific restriction on the length of any message text. The practical limitation for this length is related to relative network activity and size of queue storage. Messages whose text exceeds 5000 characters should be sent at times when the overall activity of the 8050 is low.

B. Multiple-Message Transmissions

1. Format

A multiple-message transmission is two or more messages which arrive as a single continuous input transmission. Each message must be in the previously described message format. Any number of ↓ (LTRS) characters can appear between messages.

2. Length

There is no limitation on the number of messages within a multi-message transmission.

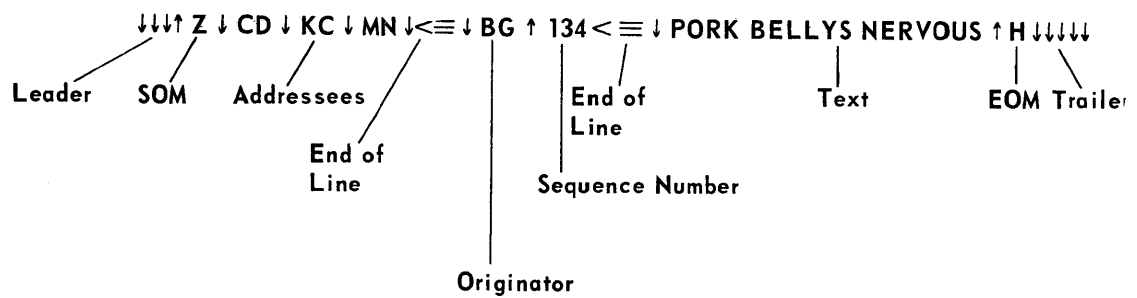

Figure 5. Single-Message Input Transmission Format

SYSTEM CONTROL OF NETWORK INPUT

A. Polled Terminals

There is usually, but not necessarily, more than one polled terminal on a circuit. Polled terminals must be invited to transmit by the 8050. This process is called **polling** and operates as follows:

Whenever input ceases on the input line of a polled circuit, the 8050 seizes the output line (momentarily stopping traffic output, if there is any) and then transmits

blank J blank

To blind a printer which may be presently selected so that it will not print the remainder of the polling sequence. (In order to minimize output degradation this sequence is transmitted in three consecutive character periods.)

A

A one character **Transmitter Start Code** (TSC) inviting a specific terminal on the line to transmit.

After transmitting the TSC the 8050 waits one second for a response. A **V** received by the 8050 indicates that the terminal just polled has no traffic and the next TSC is issued. Any other response from the terminal is interpreted as traffic and polling is terminated by transmitting the unblinding character **N** and resuming interrupted output. If the 8050 receives no response within one second, this fact is reported to the system operator and the next TSC is issued. If all terminals on the circuit are polled without receiving traffic, the polling sequence is terminated and output is resumed. The 8050 then initiates a delay (variable by the system operator in increments of ten seconds). After the delay a new polling sequence is initiated.

Each polled circuit is independently serviced.

B. Non-Polled Terminals

Non-polled terminals may transmit to the 8050 at will. Under certain emergency conditions the 8050 exercises passive control over input transmission by automatically broadcasting a **stop sending** request to all terminals.

PROCESSING NETWORK INPUT

A. Processing Modes

1. Modified Store and Forward

Traffic entering the system via 100 wpm lines is accumulated until the first 58 characters (or an EOM) have been received. At this point the address information is analyzed and output begins on available scheduled lines.

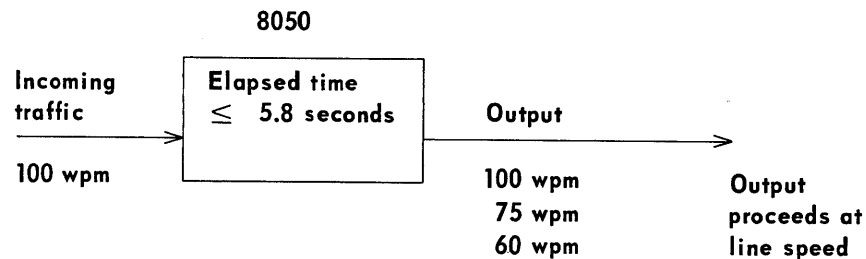

2. Store and Forward

Traffic entering the system via a slow speed line (i.e., less than 100 wpm) is accumulated until an entire message has been received. As each message is complete it is released for output. This prevents degradation of higher speed output lines.

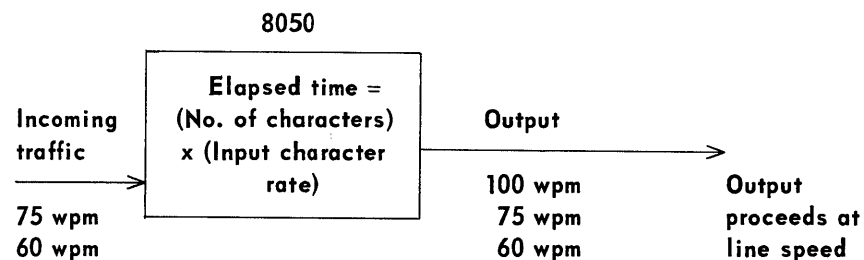

B. Routing

1. Normal

The call-directing codes in the header portion of a message are analyzed and the message is scheduled for transmission over the minimum number of output lines required to reach all addressees. Delivery is scheduled on a first-in, first-out basis.

Regardless of the number of addressees on an output line, delivery is scheduled only once. When the message is transmitted, the call-directing codes in the header select all terminal equipment on that line which will receive the message.

2. Priority

Traffic received from a priority line is scheduled for delivery ahead of non-priority traffic. Within the priority category messages are scheduled so that delivery is on a first-in, first-out basis.

3. Alternate

The system has the capacity to re-route traffic directed to a particular terminal in the network.

4. Intercept

One or more terminals can be placed in **willful intercept** status. Traffic directed to terminals in this status is automatically diverted to the **willful intercept terminal**.

The 8050 automatically routes all invalid traffic to a **miscellaneous intercept terminal** either in lieu of, or in addition to, the destinations specified by the header.

C. Editing

1. Leader and Trailer Characters

All ↓ (LTRS) characters between EOM and the first non ↓ (LTRS) character, are edited out of the system.

2. Spurious Characters

Spurious characters are edited out of the system. To avoid data loss, the extremely stringent set of editing rules illustrated below is followed.

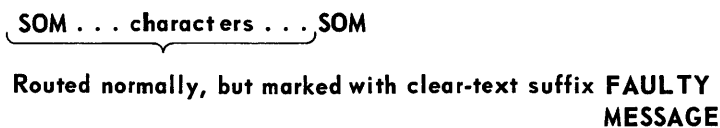
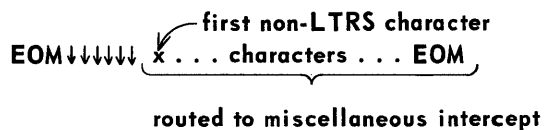
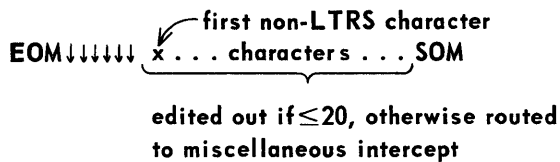

3. Blanks

All blanks are edited out of input traffic. A blank is a character whose value is zero (sprocket hole only).

4. Call-Directing Codes

When traffic is re-routed, the call-directing code of the original addressee is replaced by that of the ultimate addressee.

When a multiple address includes a terminal in willfull intercept status, the call-directing code of that terminal is edited out of the multiple address. A new header, containing only the address of the terminal in willful intercept status, is generated internally and substituted for the original header when the traffic is transmitted to the willful intercept terminal.

SYSTEM OUTPUT TO THE NETWORK

A. Transmission Algorithms

1. Single-Line or Line-Sharing Terminals

Traffic scheduled for output is transmitted as soon as the line is available. All priority traffic is transmitted prior to any non-priority traffic.

2. Multi-Line Terminals

Traffic for terminals which can be reached via more than one line is actually scheduled for transmission to the terminal, rather than to a particular line. The 8050 transmits the traffic on the first available line to that terminal. This results in maximum line usage and minimum traffic queue and is often referred to as **trunk hunting**.

B. Transmission Format

Output transmission format is the same as input format, with two exceptions:

1. No LTRS characters follow an EOM or precede an SOM (Leader-trailer has been edited out).
2. On polled circuits the start-of-message code group, $\uparrow Z \downarrow$, has been transformed internally by the system into an end-of-message code group, $\uparrow H \downarrow$.

Input Format $\downarrow\downarrow\downarrow \uparrow Z \downarrow AB \downarrow CD \downarrow < \equiv \downarrow SK \uparrow 42 \downarrow \underline{\text{text}} \uparrow H \downarrow\downarrow$

Output Format $\uparrow H \downarrow AB \downarrow CD \downarrow < \equiv \downarrow SK \uparrow 42 \downarrow \underline{\text{text}} \uparrow H \downarrow$

Figure 6. Single-Message Output Transmission Format

OTHER SYSTEM INPUT AND OUTPUT

A. Traffic Volume and Distribution Data

The following data is accumulated during system operation and can be extracted by the operator.

Character Count

Input character count is maintained by originating terminal, output character count is maintained by line.

Message Count

Input message count is maintained by originating terminal.

B. Magnetic Tape

See optional features.

ERROR DETECTION AND REPORTING

System errors and failures are detected and reported to the System Operator. Reports always include a teletypewriter operator advisory which contains time of day and error/failure description. The 8050 transmits these reports to the operator advisory terminal. Video output, consisting of console lights, and audio outputs are also generated when the error or failure represents a persisting state rather than a transient event (a drum failure as opposed to a message structural error, for example). Traffic in error is generally sent to miscellaneous intercept.

The following errors and failures are detected and reported:

A. Hardware Failures

	<u>Advisory</u>	<u>Video</u>	<u>Audio</u>
Loss of Marking Current on Input Line	yes	yes	yes
Failure of terminal to respond to polling	yes	no	no
Continuous stream of unintelligible garble on input line	yes	yes	yes

Drum parity errors or missed words*	yes	yes	yes
Magnetic tape parity errors*	yes	yes	yes
Console failure*	yes	no	no
Line terminal unit timing failure*	yes	no	no

* 8050 Equipments

B. Traffic Errors

	<u>Advisory</u>	<u>Video</u>	<u>Audio</u>	<u>Intercept</u>
<u>Format Violation</u>	yes	no	no	yes
When the structure of a message through the end of the second line is not within specification, the message is routed exclusively to miscellaneous intercept.				
<u>Invalid Address</u>	yes	no	no	yes
If message structure is correct but one or more destination address does not exist in the network, the message is routed to valid addressees and also to miscellaneous intercept.				
<u>Invalid Originator</u>	yes	no	no	yes
If the originator's call-directing code appearing in the second line of message does not exist in the network, the message is routed normally and is also routed to miscellaneous intercept.				
<u>Sequence Error</u>	yes	no	no	yes
If the input sequence number in the second line of a message is incorrect, an operator advisory containing the differential is generated. The message is routed normally and is also routed to miscellaneous intercept.				

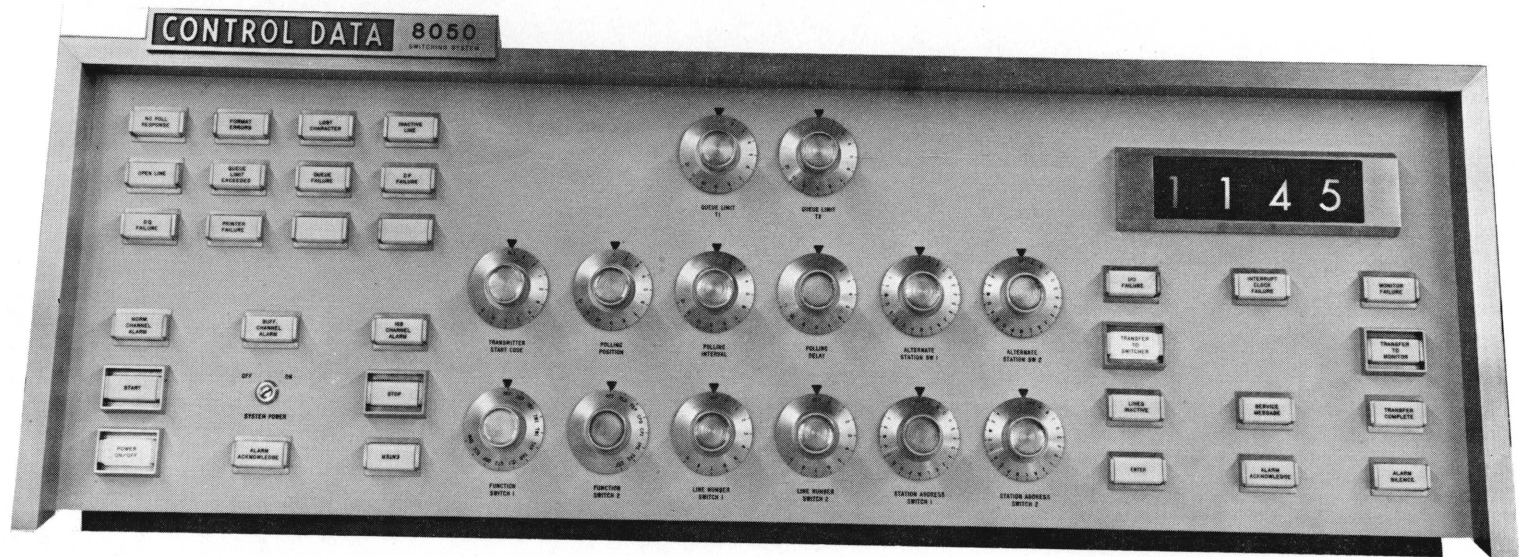

Figure 7. 8050 System Console Closeup

C. System Operator Errors

Actions requested by the system operator are carefully evaluated before the operating characteristics of the system are altered. Inconsistent parameters, invalid parameters, and untimely actions result in system rejection of the operator request. A rejection is signaled by an operator advisory message which specifies the reason for rejection.

SYSTEM CONTROL

A. Internal Compensation for System Abnormality

1. Core Storage Overload

Data and bookkeeping storages are divided into a normal component and a reserve component. If overflow into the reserve component occurs, polling is suppressed and the operator is notified by video and audio alarms.

Polling suppression tends to maximize output and minimize input and has the effect of unloading storage. When a storage balance is restored, polling is resumed and the operator is notified.

2. Drum Storage Overload

Drum loading is monitored similar to core loading except that two thresholds are employed. When the first threshold is reached, polling is suppressed. When the second threshold is reached, a message which requests all terminals to stop sending is automatically transmitted. When loading returns to normal, the operator is notified and polling is resumed.

3. Major Line or Network Failure

If an input line or a group of input lines start presenting continuous garble, or if one transmitter monopolizes an input line by repeating a single character, the line or lines are **logically isolated** from the system. The operator is notified by operator advisory (designating transmitter and line(s), and video and audio alarms. Polling of the line or lines is suppressed and input is **discarded** until the line is returned to normal by the operator.

4. Drum Failure

Provision is made for operation of the system with one or two drums. When two drums are used and one fails, the system will operate exclusively with the other.

5. Magnetic Tape Failure

If the magnetic tape subsystem fails so that the tape functions cannot be performed, the system will stop the function(s) and notify the operator by operator advisory, video and audio alarms. The switching function will not be impaired.

B. Operator Control

The system operator can alter system functional characteristics, extract and display information available with the system, and generate output to the network for test or emergency purposes.

For each operator action which **initiates** a system functional change there is a corresponding **action** which **terminates** or cancels the change. Every operator action produces an operator advisory which contains time of day and description of the action performed.

1. Controls which Affect Network Input:

- Initiate polling of all polled circuits
- Initiate polling of a particular polled terminal or circuit
- Alter the TSC sequence for a particular circuit
- Alter the time interval to be applied by the system between polling sequences
- Return to normal status an input line which has been logically isolated by the system.

2. Controls which Affect Message Routing:

- Initiate intercept (paper tape reperforation) of traffic for a particular terminal or line
- Divert traffic from one or more lines of a multi-line terminal to its remaining line(s)
- Re-route traffic from a given terminal to any other terminal.

3. Controls for Extracting Accumulated Data:

- Extract current character count
- Extract current message count
- Extract last sequence number.

4. Controls for Generating Test or Emergency Output:
 - Generate a test message to any line or terminal while it is in intercept or alternate route status
 - Generate a test message to a particular line of a multi-line terminal while normal traffic is diverted from that line
 - Generate an EMERGENCY STOP SENDING message to all terminals.
5. Controls which Affect Magnetic Tape:
 - Initiate Journal Recording
 - Reassign tape units without interruption of journal recording.

SYSTEM UTILITY PACKAGE

A. Network Definition or Modification

A utility program is used to generate or modify network definition control tables. Input to this program is Baudot-coded paper tape which specifies the operation to be performed (DEFINE or UPDATE) and the network parameters. Output is a set of internal control tables, and a Baudot coded paper tape which describes the entire network after execution of the utility program. The output tape can subsequently be used as an input tape and/or used to prepare a hard copy network description.

B. Program Maintenance

Additional utility programs to transfer operational programs from paper tape to the drum, to alter drum-stored operational programs, to copy drum-stored operational programs on magnetic tape and to load the drum from magnetic tape are available.

APPENDIX A

MINIMUM SIMPLEX 8050 CONFIGURATION

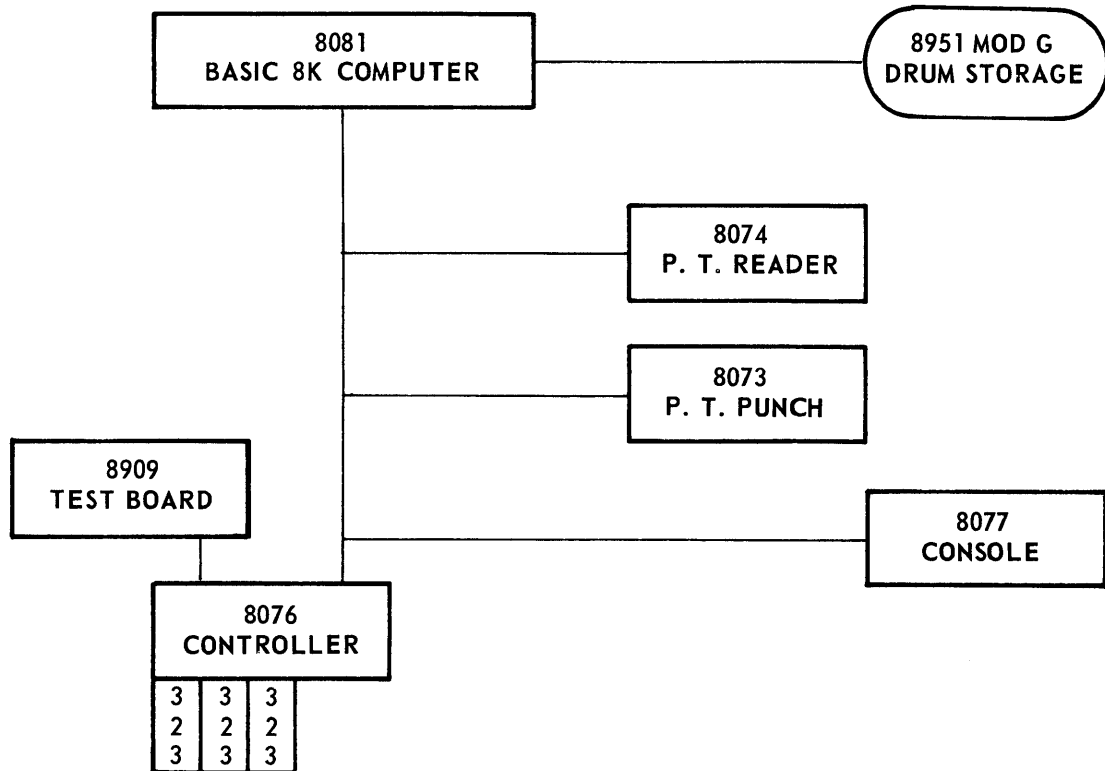

The equipment required for a minimum 8050 Information Control System is:

- 1 8081 Basic 8K Computer
- 1 8951 Drum Storage (Model G)
- 1 8077 Console
- 1 8073 Paper Tape Punch
- 1 8074 Paper Tape Reader
- 1 8909 Line Test Board
- 1 8076 Communications Terminal Controller
- 3 323 Telegraph Terminals
- ♦ Plus additional 321, 323 Terminals to accommodate all lines to and from the network.
- ♦ One additional 8951 Drum may be added to increase available queue storage and offer a back-up for the basic queue.
- ♦ 8952 Drums may be substituted for the 8951 Drums to increase available queue storage.

APPENDIX B

MINIMUM DUPLEX 8050 CONFIGURATION

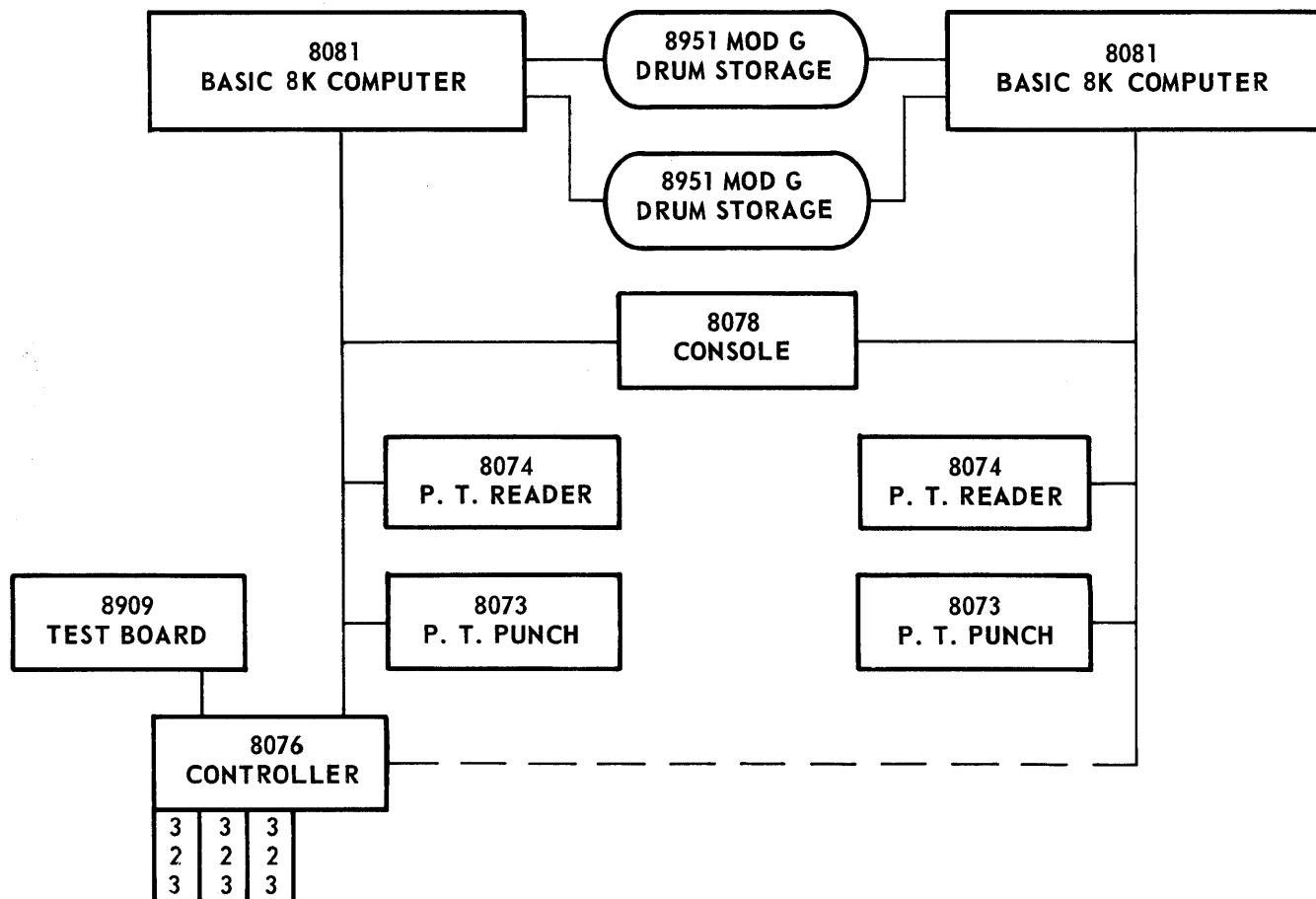

The equipment required for a minimum duplex 8050 Information Control System is:

- 2 8081 Basic 8K Computer
- 2 8951 Drum Storage (Model G)
- 1 8078 Console
- 2 8073 Paper Tape Punch
- 2 8074 Paper Tape Reader
- 1 8909 Line Test Board
- 1 8076 Communications Terminal Controller
- 3 323 Telegraph Terminals
- ♦ Plus additional 321, 323 Terminals to accommodate all lines to and from the network.
- ♦ 8952 Drums may be substituted for the 8951 Drums to increase available queue storage and offer a back-up to the basic queue.

APPENDIX C

5 LEVEL CODES

5 LEVEL CODES

BIT POSITION						AMERICAN				CCITT #2		
4	3	2	1	0		LETTERS		FIGURES			LETTERS	FIGURES
TAPE LEVEL								①	②	③		
b ₁	b ₂	b ₃	b ₄	b ₅								
0	0	0	0	0		BLANK T CARRIAGE RET 0	- 5 CARRIAGE RET 9	BLANK 5 CARRIAGE RET 9	∞ 5 CARRIAGE RET 9		BLANK 5 CARRIAGE RET 9	BLANK 5 CARRIAGE RET 9
0	0	1	0	0		SPACE H N M	SPACE ↓ ⊕ .	SPACE BLANK 7/8 .	SPACE # , .		SPACE H N M	SPACE BLANK , .
0	1	0	0	0		LINE FEED L R G	LINE FEED ↙ 4 ↘	LINE FEED 3/4 4 &	LINE FEED) 4 &		LINE FEED L R G	LINE FEED ↙ 4 BLANK
0	1	1	0	0		I P C V	8 0 ⊙ ⊕	8 0 1/8 3/8	8 0 : ;		I P C V	8 0 BLANK =
1	0	0	0	0		E Z D B	3 + ⊕	3 " \$ 5/8	3 " \$?		E Z D B	3 + WHO ARE YOU? ?
1	0	1	0	0		S Y F X	BELL 6 → /	BELL 6 1/4 /	BELL 6 ! /		S Y F X	, 6 BLANK /
1	1	0	0	0		A W J FIG. SHIFT	↑ 2 ↙ FIG. SHIFT	- 2 , FIG. SHIFT	- 2 , FIG. SHIFT		A W J FIG. SHIFT	- 2 BELL FIG. SHIFT
1	1	1	0	0		U Q K LTR. SHIFT	7 1 ← LTR. SHIFT	7 1 1/2 LTR. SHIFT	7 1 (LTR. SHIFT		U Q K LTR. SHIFT	7 1 BLANK LTR. SHIFT

① WEATHER ② FRACTIONS ③ COMMUNICATIONS

8050 OPTIONAL FEATURES

In addition to the basic 8050 functions described in this manual a number of optional features are available which increase the utility of the system. The following pages list these features and describe their function. For information on additional optional features which may be available consult your local Control Data sales representative.

BASIC MAGNETIC TAPE FEATURE

DESCRIPTION

Provides Magnetic Tape Recording and consists of the following equipment:

Simplex

Option A

- 1 8070 Magnetic Tape Synchronizer
- 2 601 Magnetic Tape Units

Option B

- 1 8071 Magnetic Tape Synchronizer
- 2 603 Magnetic Tape Units

Duplex System

Option A

- 2 8070 Magnetic Tape Synchronizer
- 2 603 Magnetic Tape Units

Option B

- 2 8071 Magnetic Tape Synchronizer
- 2 603 Magnetic Tape Units

PREREQUISITE

Minimum Simplex 8050 Configuration

MAGNETIC TAPE JOURNAL FEATURE

DESCRIPTION

Each message which passes through the system is written to magnetic tape. The tape record includes the time the message arrived at the 8050. When a reel of magnetic tape is full the 8050 will close out the reel and automatically initiate journal recording on the alternate tape unit. The journal is terminated at the end of each day. If a situation arises in which there is no tape unit available on which to write the journal, the Journal Recording function will be bypassed until a unit becomes available. In the case where no unit is available, the journal will be incomplete.

PREREQUISITE

Basic magnetic tape feature

KEYBOARD INPUT FEATURE

DESCRIPTION

This feature permits traffic to be input to the 8050 from teletypewriter keyboards. The basic 8050 permits input only from paper tape reading devices. This feature makes both types of input acceptable.

PREREQUISITE

Minimum 8050 Configuration plus the appropriate keyboard terminal devices.

GROUP CODE FEATURE

DESCRIPTION

One call-directing code is chosen as a group routing code. All traffic addressed to this CDC will be routed by the 8050 to a specified list of other call-directing codes. This list may include all valid call-directing codes in the network or a subset of these codes.

PREREQUISITE

Minimum 8050 Configuration

CONTROL DATA
CORPORATION

**INDUSTRIAL DATA
PROCESSING DIVISION**

9549 PENN AVENUE SOUTH, MINNEAPOLIS 31, MINNESOTA

LITHO IN U.S.A.