

CONTROL DATA® 6400/6600 COMPUTER SYSTEMS
EXPORT/IMPORT 8231 Reference Manual

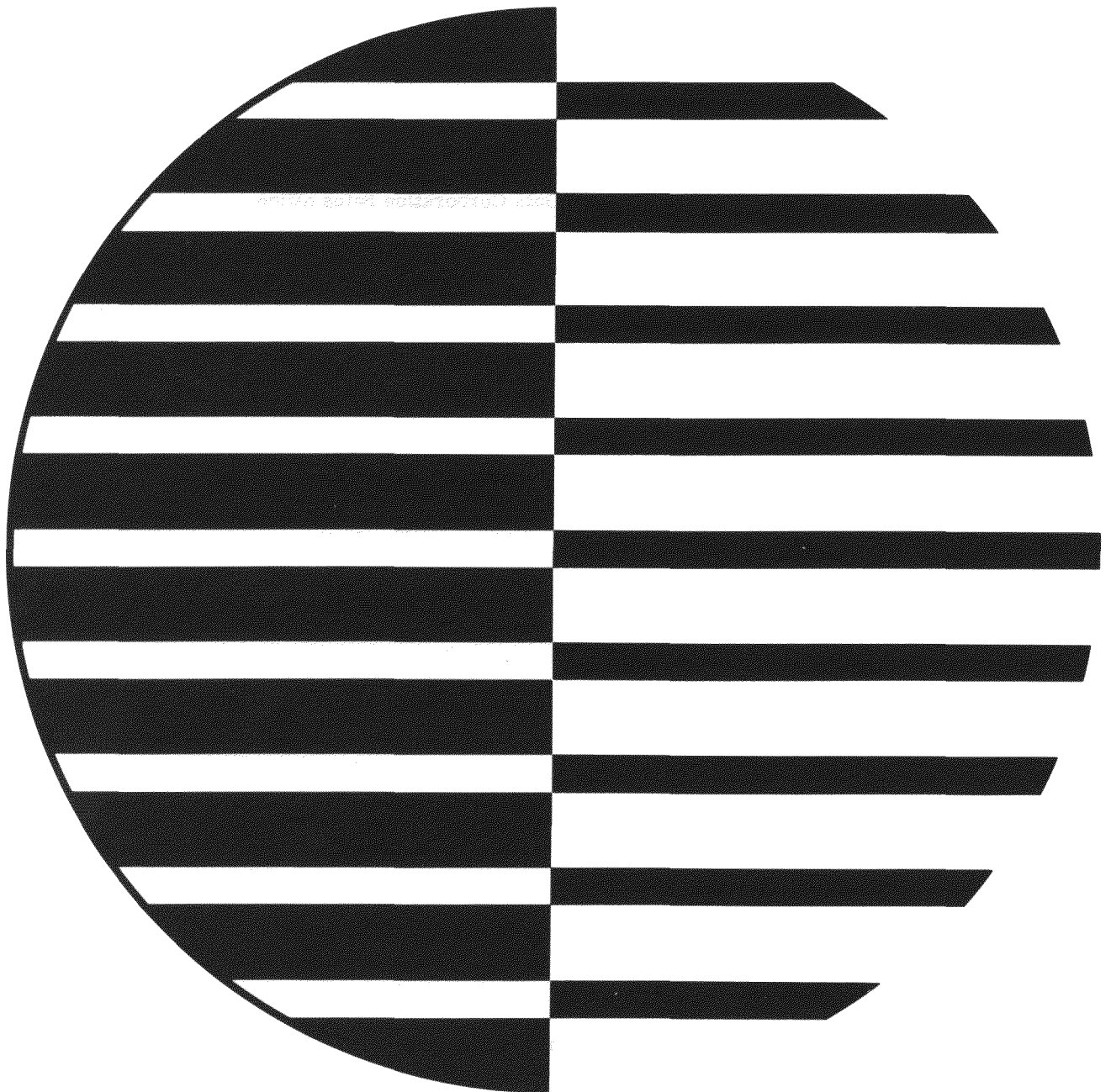

Additional copies of this manual may be obtained
from the nearest Control Data Corporation Sales office.

CONTENTS

	INTRODUCTION	v
CHAPTER 1	BASIC CONCEPTS	1-1
	1.1 System Components	1-1
	1.1.1 EXPORT	1-1
	1.1.2 IMPORT	1-1
	1.2 System Dependencies	1-2
CHAPTER 2	HARDWARE REQUIREMENTS	2-1
	2.1 Central Computer	2-1
	2.2 Remote Computer Terminal	2-1
	2.3 Communications Equipment	2-2
CHAPTER 3	JOB FLOW	3-1
	3.1 Simplified Job Flow	3-1
	3.2 SCOPE Interface	3-2
	3.2.1 Initialization of EXPORT	3-2
	3.2.2 Job Processing	3-2
	3.3 Termination of EXPORT	3-2
	3.4 Job Flow Diagrams	3-2
CHAPTER 4	OPERATOR REQUESTS	4-1
	4.1 Central Operator Actions	4-1
	4.2 Remote Operator Actions	4-2
	4.2.1 Startup Procedure	4-2
	4.2.2 Typewriter Input	4-3
	4.2.3 Typewriter Messages	4-4
	4.2.4 Input/Output Messages	4-5
	4.2.5 Recovery Procedures	4-5
	4.2.6 Jump Keys	4-6
CHAPTER 5	EXCHANGE LOGIC	5-1
	5.1 Communication Rules	5-1
	5.2 Transfer Formats	5-2
	5.2.1 Status Transfer Format	5-2
	5.2.2 Directive Transfer Format	5-3
	5.3 Character Set	5-3
	5.4 Initiation Procedure	5-3

	5.5	Error Detection Scheme	5-3
	5.5.1	Error Causes	5-4
	5.5.2	Detection Logic	5-4
	5.5.3	Detection Capability and Features	5-5
	5.5.4	Error Compensation	5-6
CHAPTER 6		EXPORT PROGRAM	6-1
	6.1	Initialization of EXPORT	6-1
	6.2	Overall Flow	6-1
	6.2.1	Resident Activities	6-1
	6.2.2	Communications Overlay	6-2
	6.2.3	Processor Overlay	6-3
	6.3	Central Memory Requirements	6-5
	6.4	Special Routine	6-6
CHAPTER 7		IMPORT PROGRAM	7-1
	7.1	Initialization of IMPORT	7-1
	7.2	IMPORT Processing Routines	7-2
	7.2.1	Determine Directive Code (CC)	7-2
	7.2.2	Line Printer Driver (LP)	7-2
	7.2.3	Card Reader Driver (CR)	7-3
	7.2.4	Card Punch Driver (CP)	7-3
	7.2.5	Typewriter Driver (TW)	7-3
	7.2.6	Interrupt Processing (INT)	7-4
	7.3	Utility Functions	7-5
		INDEX	Index-1

INTRODUCTION

6400/6600 EXPORT/IMPORT 8231 is a system of programs which provides multi-access to a central CONTROL DATA® 6400 or 6600 computer system from remotely located terminal stations. Users at remote sites may submit jobs under the EXPORT/IMPORT system and may enter input to the system. They will receive output in the same manner in which the user would receive it at the central computer. An operator at any remote terminal has extensive access to the central processor, almost as if he actually were working at the site of the central processor. In addition, off-line utility operations are available with EXPORT/IMPORT.

During operation, parts of EXPORT/IMPORT reside, not only in different portions of the central computer system, but also in each remote station. Three basic elements comprise the system:

IMPORT, the remote computer resident program

EXPORT, the peripheral processor resident program

SCOPE, the central computer operating system

A familiarity with SCOPE is a prerequisite for the use of this manual.

1.1 SYSTEM COMPONENTS

6400/6600 EXPORT/IMPORT 8231 runs under the SCOPE Version 3.0 operating system on the 6400 and 6600 CONTROL DATA computer systems. It is composed of two separate but dependent programs:

The Executive Processor of Remote Tasks (EXPORT) resides in each peripheral processor[†] (PP) assigned to remote communications by the central facility.

The Input/Output Monitor for Processing of Remote Tasks (IMPORT) resides in each remote facility.

Features of SCOPE for remote job processing supplement these two programs.

1.1.1 EXPORT

EXPORT consists of a resident program with two main overlays: one for handling communications and another for processing data. In addition, several SCOPE system overlays are called as needed.

EXPORT communicates with transient SCOPE input and output routines in another PP through central memory buffers and flags. EXPORT communicates with IMPORT through the data communications facility. With the data received from IMPORT, EXPORT prepares input files for processing under SCOPE; and EXPORT intercepts output files for transmission back to IMPORT. Operator communication is accomplished through the system display console.

1.1.2 IMPORT

IMPORT is a monitor program which resides in an 8231 remote computer terminal. IMPORT communicates with EXPORT over the data communications facility. It is interrupt controlled for transmitting data to EXPORT. Operator communication is carried out through the on-line typewriter attached to the 8231. Utility operations may be performed when IMPORT is not communicating with EXPORT.

[†]In a 6400 or 6600 computer, ten peripheral processors operate independently and simultaneously as stored program computers.

1.2 SYSTEM DEPENDENCIES

Since EXPORT/IMPORT runs under the SCOPE operating system, any modifications to or restrictions on SCOPE must be made with full consideration of the requirements that EXPORT places on the system. Efficient use by EXPORT of the data communications facility is dependent upon consistently good disk access and upon the availability of transient PP's.

The basic minimum hardware configuration for SCOPE also applies to EXPORT/IMPORT. In addition, certain other equipment is required to provide the data communications facility and its interface with access to the central computer and the remote 8231 computer terminal.

2.1 CENTRAL COMPUTER

At least one 6675 data set controller (DSC) model B or D is required on a dedicated 6400 or 6600 data channel. A 6675 DSC provides adapters for the 301-B DATA PHONE[†] data sets and connects directly to a data channel. More than one 6675 DSC may be attached to the computer system; however, each DSC must be on a separate channel. Model B of the 6675 DSC connects one or two 301-B data sets; model D connects one to four 301-B data sets.

2.2 REMOTE COMPUTER TERMINAL

The remote computer terminal consists of an 8231 system with the following components:

- Computer (with 8K memory)
- On-line I/O typewriter
- Data channel converter
- Card reader controller (buffered)
- Card reader (1200 cards per minute)
- Line printer controller (buffered)
- Line printer (1000 lines per minute)
- Data set controller

[†] A registered trademark of AT & T and the Bell System.

The following optional equipment may be attached to the 8231 system:

- 3446 Card punch controller
- 415 Card punch (250 cards per minute)
- 8073 Paper tape perforator
- 8074 Paper tape reader

2.3 COMMUNICATIONS EQUIPMENT

A 301-B DATA PHONE data set, which operates at a nominal data rate of 40,800 bits per second, is the standard communications MODEM (modulator demodulator) used with EXPORT/IMPORT. This data set provides the interface between the DSC and the communications line.

The communications line may be either a Telpak-A[†] facility, which is available from a telephone company, or a private coaxial cable. Transmission is half duplex, except for the SYNC word acknowledgment which is provided in full duplex mode.

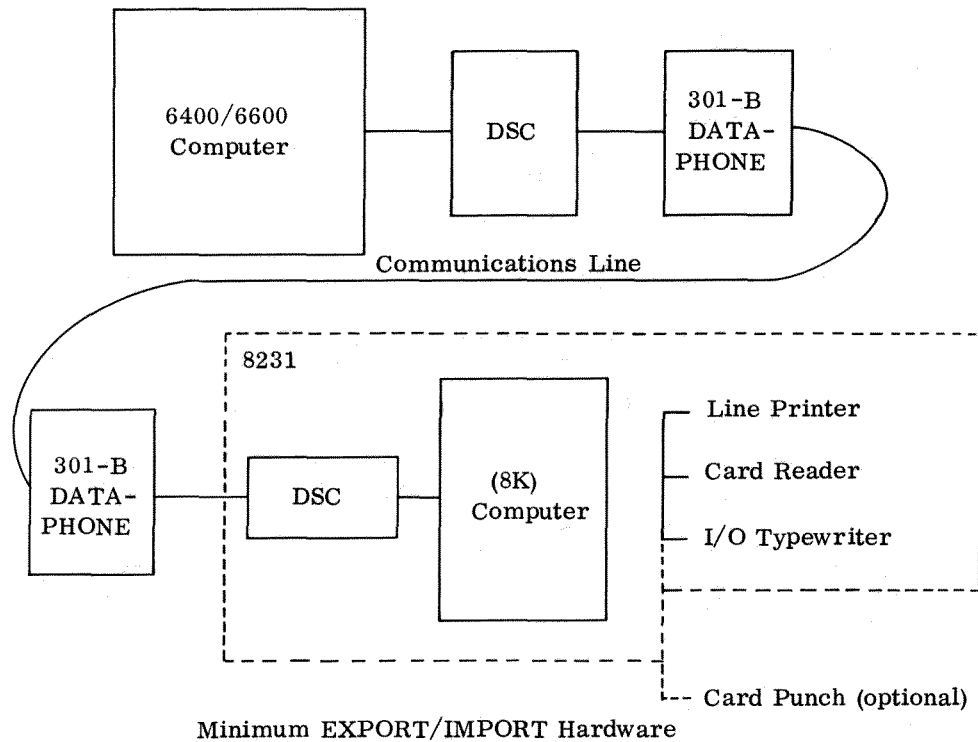

[†] A registered trademark of AT & T and the Bell System.

3.1 SIMPLIFIED JOB FLOW

A simplified description of the overall job flow for both input and output (with respect to only one terminal) follows. General input/output functions are identical to the read and output packages under SCOPE.

INITIALIZATION

- Load IMPORT program deck.
- Prepare to read cards.
- Call EXPORT to a control point.

INPUT FROM CARDS

- Cards are read by IMPORT.
- Trailing blanks are deleted.
- Internal BCD is converted to display code.
- Data is packed into buffers equal in size to 64 central memory words (one disk sector).
- Full buffers and end-of-record (EOR) or end-of-file (EOF) indicators are transmitted to EXPORT.
- EXPORT requests SCOPE to write data from buffers to disk.
- At EOF, the file is set to INPUT and released to SCOPE.

OUTPUT TO PRINTER AND PUNCH

- File Name Table/File Status Table (FNT/FST) is scanned by EXPORT for remote OUTPUT files.
- Sectors are read by SCOPE to central memory (CM)
- Output is transmitted to IMPORT in one-sector blocks.
- IMPORT deblocks print lines and punch cards.
- Lines are printed with carriage control.
- Cards are punched.

3.2 SCOPE INTERFACE

Before EXPORT/IMPORT can be used, the following initialization activities must be completed:

- Entries should be made to the Equipment Status Table (EST) for each 6675 DSC attached to the computer system.
- Care must be taken to determine the correct equipment number and channel number for each 6675 and the number of units attached to it.
- It may be desirable to reassemble EXPORT to make adjustments for 32K systems or for other core management problems, since the number of disk sectors buffered into central memory is a system parameter.

3.2.1 INITIALIZATION OF EXPORT

The EXPORT initialization program is called manually by operator request. The operator enters: n. EXPORT which calls the routine to control point n.

3.2.2 JOB PROCESSING

The files associated with remote jobs are identified by the remote bit (highest order bit) of the 12-bit disposition code (dc) in the FNT/FST. Normally, this bit is not interpreted until the job has been processed completely. At that time, print and punch files are ignored by SCOPE if the remote bit is set, and the disposition is handled by EXPORT. The remaining bits of the dc field are used by EXPORT to identify the file for printing or punching. In all other respects, the job is processed identically to non-remote jobs.

3.3 TERMINATION OF EXPORT

Each terminal notifies EXPORT when communication is finished. When all lines become inactive, EXPORT enters PP recall at its control point. The operator may drop EXPORT if he wishes to free the control point.

3.4 JOB FLOW DIAGRAMS

The following diagrams illustrate the flow of data and control from the beginning to the end of a job. The diagrams assume that EXPORT has been assigned and loaded into a peripheral processor at the central site and that IMPORT has been loaded into the remote facility.

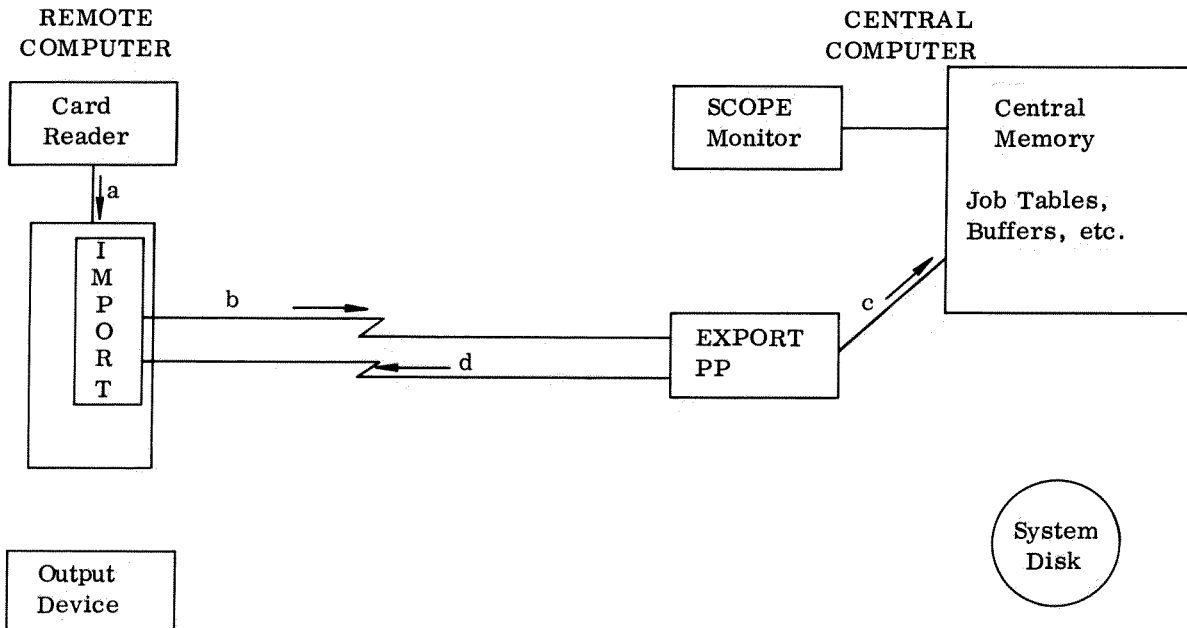

IMPORT:

- Reads job card (a)
- Requests permission to send job (b)

EXPORT:

- Obtains central memory buffer area (c)
- Notifies remote site that it is ready to accept job (d)

JOB FLOW, STEP 1, REQUEST TO LOAD

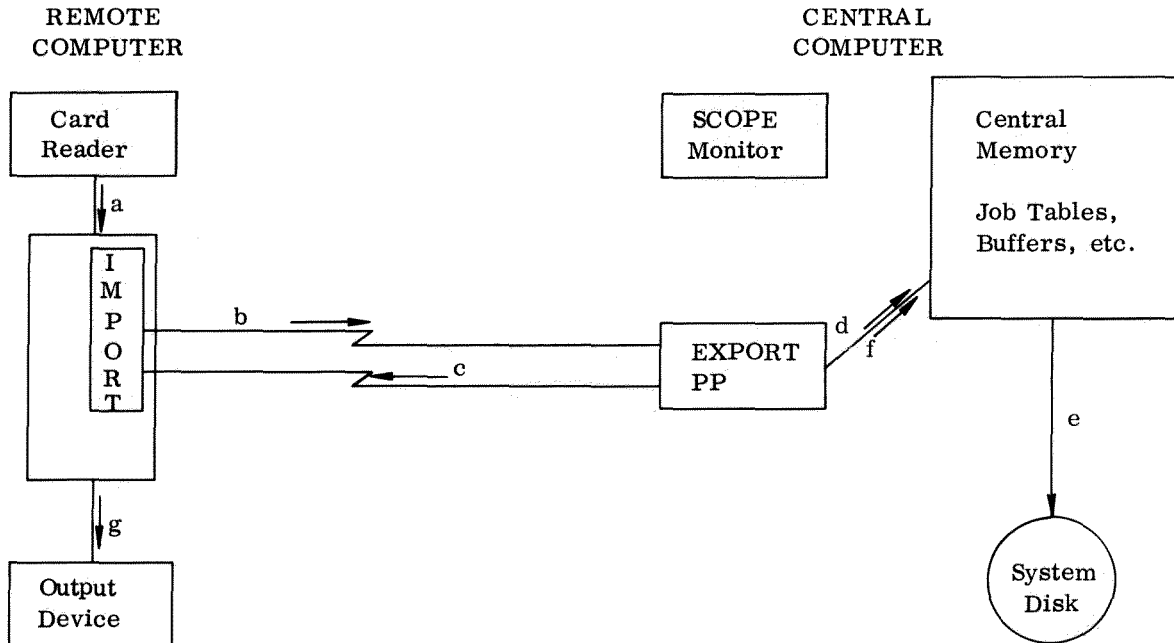

IMPORT:

Reads job into remote computer (a)
Transmits data to central site (b)

EXPORT:

Acknowledges receipt of each block of data (c)
Transfers data to buffer area in central memory (d)

SCOPE:

Transfers data from buffer area onto system disk (e)
Records job in job table upon receipt of last card (f)

IMPORT:

Remote operator is notified when job transmission is completed (g)

JOB FLOW, STEP 2, LOAD JOB

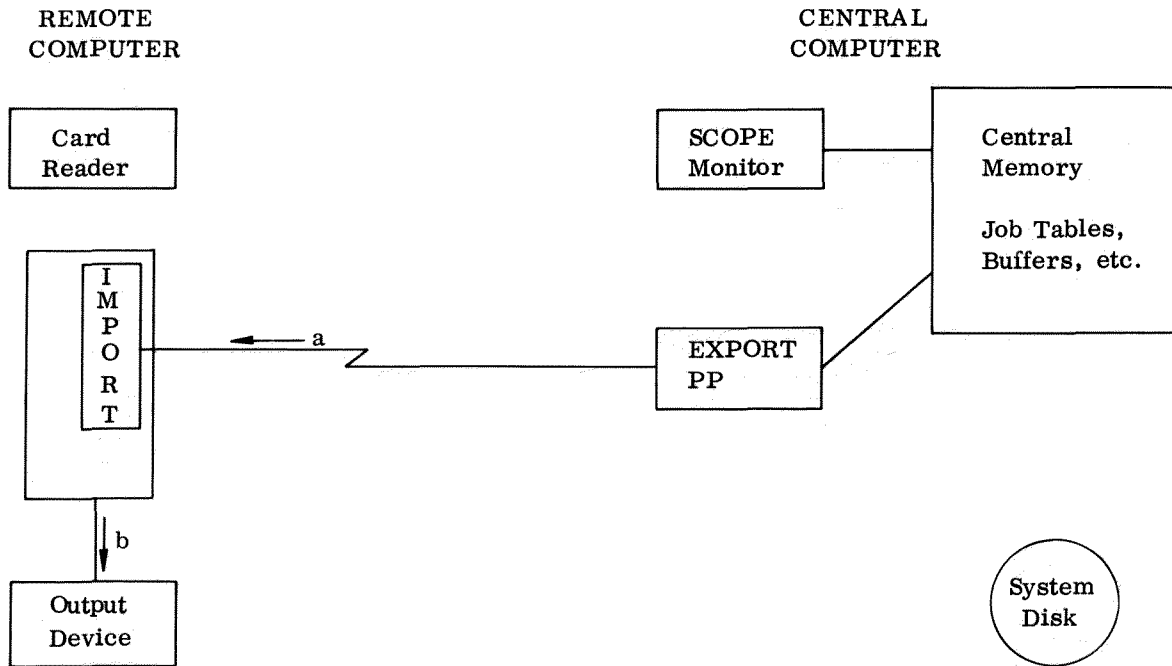

SCOPE:

Processes job

EXPORT:

Obtains remote job status by monitoring the job table and jobs in memory
 Notifies IMPORT of messages pertinent to remote jobs (a)

IMPORT:

Outputs message to operator (b)

JOB FLOW, STEP 3, JOB PROCESSING

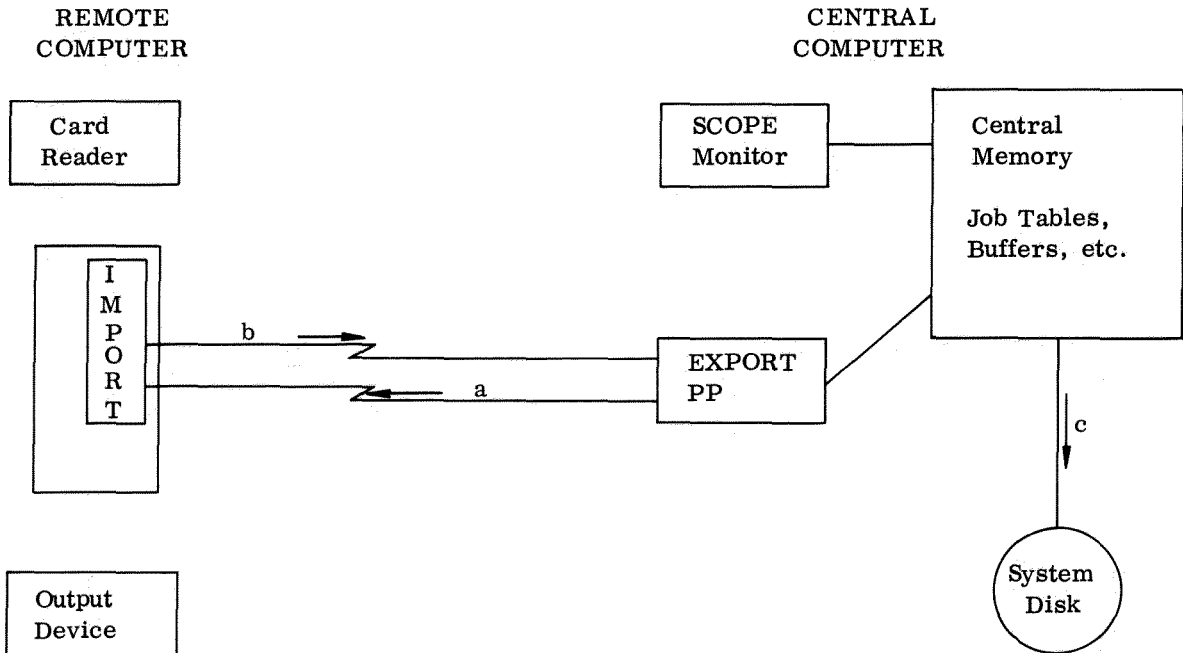

SCOPE:

Directs job output data to system disk (c)

EXPORT:

Searches job table for job ready for output (a)
 Notifies import that output is ready

IMPORT:

Requests output which it currently can handle (b)

JOB FLOW, STEP 4, JOB TERMINATION

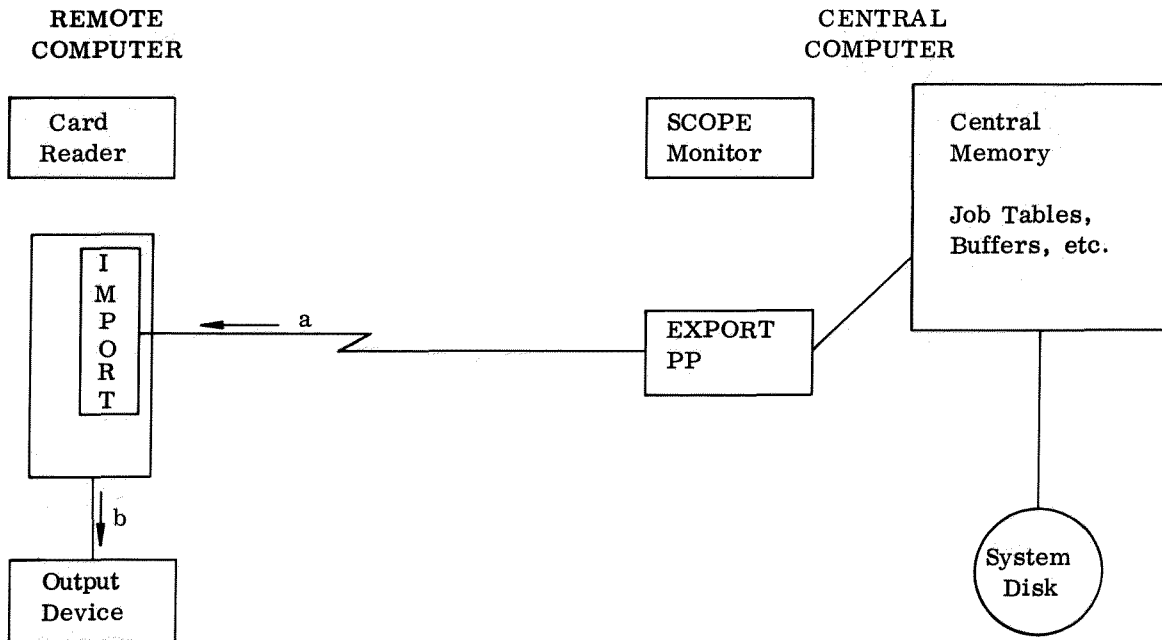

EXPORT:

Issues request to transfer output from disk to buffer
 Transmits data from buffer to remote site (a)

IMPORT:

Receives data and outputs it to appropriate device (b)

JOB FLOW, STEP 5, JOB OUTPUT

The requests, commands, and responses used by the central and remote operators are described below.

**4.1
CENTRAL
OPERATOR
ACTIONS**

The central operator initiates the operation of the EXPORT/IMPORT system by entering n.EXPORT from the system display console keyboard, where n is an available control point. All messages from the remote operators, and messages generated internally by EXPORT, are displayed at the control point of EXPORT. Messages pertaining to a particular job are entered into the dayfile for that job.

All messages from remote terminals are displayed at the second line of the message area in the form x.Message, where x is the remote terminal identification. Before another message can be displayed, each message must be acknowledged by the central operator's typing n.GO. A message may be sent to a particular remote terminal by the central operator's typing n.TMR. x.Message, where n is the control point of EXPORT and x is the terminal identification.

Information and action messages are displayed separately for each terminal at the first line of the message area. They appear in the following form:

A. Message B. Message C. Message D. Message

A, B, C, and D represent terminal identifications; the messages are listed below.

Information Only:

<u>Message</u>	<u>Description</u>
IDLE	Not transmitting data
READ	Receiving card reader data
PRINT	Sending printer data
PUNCH	Sending punch data
SHUTDOWN	Inactive or shutdown

<u>Message</u>	<u>Description</u>
CYCLIC	Cyclic error detected
LOST	Communication lost
(blank)	Line not attached

Messages Which Require Operator Action:

STORAGE	Free CM storage for EXPORT
MESSAGE	Acknowledge by entering n.GO.
ERR = yyyy	DSC status error yyyy
REX = mmmm	mmmm transmissions

} hardware failure

4.2 REMOTE OPERATOR ACTIONS

Communications between EXPORT and IMPORT are initiated by the remote operator. Once begun, the operation of IMPORT is controlled by the cards read and by the messages input at the typewriter.

4.2.1 STARTUP PROCEDURE

The following sequence is required to load the IMPORT program:

- Press Master Clear.
- Set the Enter-Sweep switch to Enter.
- Set the P register to 7000.
- Set the Z register to the following values, pressing the Run-Step switch once after each value is entered.

The value in the P register advances by 1 with each entry.

0060
7500
6004
2200
3000
7677
7500
6020
7202
7132
7012

- Both the P and Z registers should contain 7012.
- Set the P register to 7000. Select jump keys, if desired.
- Place the IMPORT program deck in the card reader. Press Motor Power and Ready.
- Set the Run-Step switch to Run.
- IMPORT 8231 IS NOW OPERATING appears when communications are established with EXPORT.

4.2.2 TYPEWRITER INPUT

The following steps are necessary to enter a statement on the typewriter:

- Initiate a carriage return.
- Type the statement.
- Backspace once to re-enter an erroneous statement.
- Terminate with a carriage return.

If an error is detected in the statement, the carriage is tabbed and **U, **J, or **P is typed on the same line. These indicate an unidentified operation, an improper job name, or an improper priority value, respectively. Valid typewriter input statements are listed below; job name is the name returned from EXPORT.

<u>Statement</u>	<u>Function</u>
STAT, job name	Obtain information on status of job.
CPR, job name, priority	Change priority of job; priority is octal.
CPT, job name, seconds	Change central processor (CP) run time limit; maximum of 5 octal digits.
RPNT or RPNT, n	Reprint entire job currently being output on the printer if n is not given; if n is given, the output file is backed up n sectors and reprinted from that point.
RPCH	Repunch entire job currently being output on card punch.
DVT, job name	Divert all remote output for job named to central facility.
TERM, dt	Terminate output on device specified by dt for job currently being output, dt = LP (line printer) or CP (card punch).

<u>Statement</u>	<u>Function</u>
ABT, job name	Abort job named; receive output generated up to this point.
DISP, message	Transmit display message (one line of 40 characters).
LIST	List current contents of IMPORT job table.
END	Shut down remote communications.

4.2.3

TYPEWRITER MESSAGES Messages that may appear on the typewriter include responses to a status request and messages from IMPORT. Messages relating to peripheral equipment operations are given by a two-character code of the form *nx.

<u>Monitor Message</u>	<u>Definition</u>
*job name IN STACK	Job name has been loaded at the remote site and is in the input stack waiting to be assigned a control point; this message supplies the SCOPE job name, which differs (characters 5-7) from the name supplied on the job card.
*job name AT CP n status CPT sec	SCOPE has loaded the job from disk to control point n; status equals X, W, A, etc.; CPT is the accumulated central processor run time in octal seconds.
*job name IN OUTPUT STACK	Central processor has completed execution of job named.
*job name NOT IN SYSTEM	Job has been completed, or it never existed.
JOB TABLE FULL, STOP LOADING	IMPORT job table is full; temporarily stop loading jobs.
job name PR C	Printing is complete for the job named.
job name PU C	Punching is complete for the job named.
job name JOB CARD ERROR	The batch loader has detected an illegal job card; IMPORT continues to read cards looking for a correct job card; when it is found, IMPORT transmits that job to the central site. It does not transmit the job with the illegal job card until the card has been corrected and the job reloaded.

<u>Monitor Message</u>	<u>Definition</u>
CL	IMPORT has lost communication with the central facility; IMPORT automatically attempts to re-establish communication.
DSC FAIL TO CONNECT	The remote data set controller is not connected, not installed, or in the test mode; fatal error.
INOPERATIVE DSC	The line carrier signal is lost and/or a malfunction has occurred in the local data set; equipment failure.

(Messages preceded by an asterisk are generated in response to a STAT request.)

**4.2.4
INPUT/OUTPUT
MESSAGES**

<u>n</u>	<u>x</u>	<u>Definition</u>	
3		Card reader operation	
4		Card punch operation	
5		Line printer operation	
	C	Connect reject	} Equipment failure
	S	Select reject	
	I	Input reject	
	O	Output reject	
	R	Read error or punch deck	
	F	Failure to feed (check for card jam)	
	P	Out of paper (line printer only)	
	N	Device not ready (ready device)	

**4.2.5
RECOVERY
PROCEDURES**

The following descriptions apply to the I/O error messages given above; n is 3, 4, or 5, depending upon the device in error. If equipment failures persist, a customer engineer should be consulted.

- nC - Connect reject
Device n cannot be connected. Correct the equipment select code if necessary; otherwise, an equipment malfunction exists.
- nS - Select reject
Device n has rejected a function select (such as printer spacing) which indicates an equipment malfunction.
- nI - Input reject
The channel has rejected the last input command for device n, which indicates equipment malfunction.
- nO - Output reject
The channel has rejected the last output command for device n, which indicates equipment malfunction.
- nR - Read error or punch deck
For the card reader (n = 3), reload the last card from the output tray and ready the reader. For the card punch (n = 4), feed three blank cards and throw away the new cards which appear in output tray. Ready the punch; and after punching resumes, remove the three blank cards.
- nF - Failure to feed
Device n is not feeding properly. Check the input tray for possible card jam or damaged cards. Ready the reader when the cards are loaded properly.
- nP - Out of paper
Check the printer for paper tear, jam, or out-of-paper condition. If it appears that information was lost, the RPNT typewriter command should be used to recover.
- nN - Device not ready
Ready device n.

4.2.6
JUMP KEYS

The following functions are performed when jump keys on the 8231 are selected.

Key

- 1 Suppress COMMUNICATIONS LOST message
- 2 Bypass remote communications
- 4 Bypass use of typewriter

The EXPORT and IMPORT programs communicate through the hardware and communications equipment described in Chapter 2. The equipment is connected serially in the following sequence from the central computer to the 8231 remote terminal:

6675 data set controller
301-B DATA PHONE data set
Telpak-A line or coaxial cable
301-B DATA PHONE data set
8231 data set controller

The data set controller converts the 12-bit parallel data from the central computer channel to serial bit data for the data set. The data set, in turn, converts the serial bit patterns for wide band transmission. Conversely, at the opposite end of the line, data is converted to serial bits by the data set and then to 12-bit parallel form for the data channel of the remote terminal. Transmission from the remote terminal to the central computer is accomplished in the same manner, but in reverse order.

5.1 COMMUNICATION RULES

Transfer of data between the central computer and the remote terminal involves an exchange of control information which has a fixed format and an unambiguous meaning. The information sent from EXPORT to IMPORT is contained in a status word of 12 bits. This status word specifies the types of data EXPORT is prepared to handle. IMPORT sends control information in the form of a 12-bit directive word. This directive word selects one or more of the options offered by the last EXPORT status word, or it makes a special request. In either case, data may accompany the status word or directive word, in which case the transmission is called a status transfer or a directive transfer.

IMPORT must select only from the options offered in the latest status word, and EXPORT must accept the directive word sent. Data included in a status transfer must correspond to the latest directive received, and data in a directive transfer is always of the type indicated in the attached directive word.

5.2 TRANSFER FORMATS

The first 12-bit word of each status and directive transfer contains a sequence bit and a 9-bit transfer length. The sequence bit indicates to the transmitting site whether or not its messages are being received properly. The transfer length gives the count of the total number of 12-bit words contained in the message, including the first word but excluding the hardware-appended cyclic code word. A typical transfer would contain 322 12-bit words (the maximum length), since, normally, data blocks corresponding to 64 central memory words are transmitted. The minimum transfer length is two words.

5.2.1 STATUS TRANSFER FORMAT

The format of a status transfer depends upon whether or not data is included in the message. A fixed-length message without any data consists of only two 12-bit words. The first word contains the sequence bit and transfer length; the second is the status word. A variable-length message with data may contain up to 322 words (12-bit) and is simply an extension of the first format with data appended after the status word.

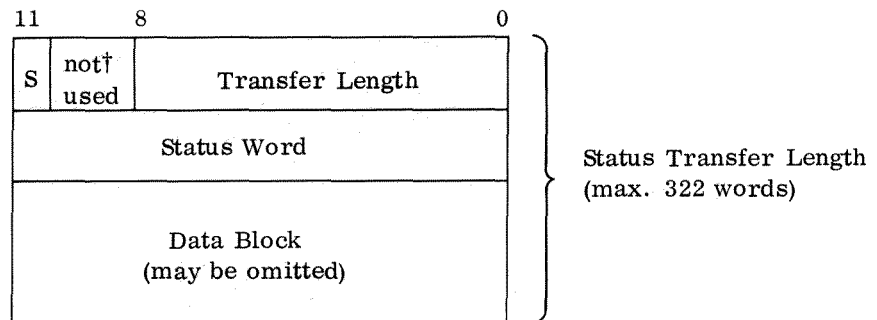

S sequence bit (0 or 1)

† reserved for future use

**5.2.2
DIRECTIVE
TRANSFER FORMAT**

The formats for directive transfer differ from those for status transfer only in that the second word of each message is the directive word.

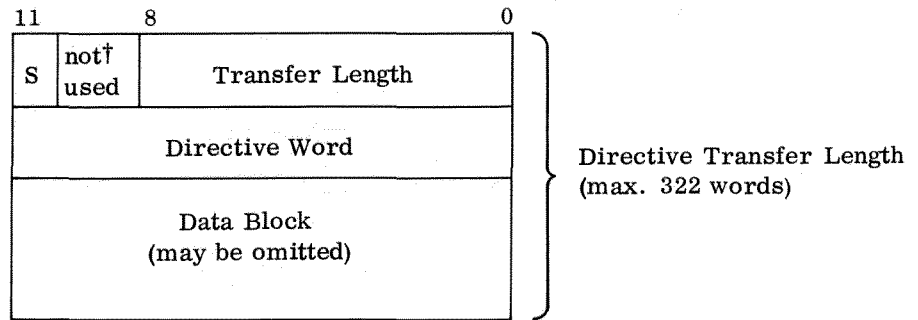

S sequence bit (0 or 1)
† reserved for future use

**5.3
CHARACTER SET**

The EXPORT program handles all typewriter, card (except binary), and line printer data in 6-bit display code using the SCOPE character set. Two display-code characters are packed into one 12-bit PP word. IMPORT converts card and typed input to display code before transmission.

Printer, punch, and typewriter data are converted from display code to BCD or to typewriter code for the peripheral equipment. For cards, binary information is carried as column binary card images.

**5.4
INITIATION
PROCEDURE**

IMPORT communication is initiated by request of the remote site operator. The first transmission is a function operation which sets the interrupt bit at the 6675 DSC and directs EXPORT to activate that line.

**5.5
ERROR DETECTION
SCHEME**

During each data transmission, the data set controller generates a 12-bit cyclic code word which is appended to the data block. This code word is based on the bit pattern of the data block. The receiving controller also generates a 12-bit cyclic code word during data reception and compares its generated word with the word received from the other end. When an error-free data block is received, the decoder signals that the next data block may be transmitted. This means of error detection has a reliability factor in excess of 99.9 percent for this communication scheme.

In this scheme, the central and remote control programs are governed by the following rules:

- Only error-free transmissions are acknowledged.
- Acknowledgment is indicated by a bit in the subsequent transfer.
- Absence of an acknowledgment implies a retransmission request.

Conditions that are checked by each computer before initiating input or output include malfunctions that may occur in the communications facilities. Operators receive messages concerning any malfunctions.

Whenever the message received is not identical to the message sent (bit for bit), a transmission error occurs. If the error is not detected, incorrect information is received. Several error types and conditions are described in the following sections. Only errors in the communication facility are considered here.

5.5.1 ERROR CAUSES

Message Lost Completely

The leading SYNC words may be lost or mutilated so that the entire message is passed over as noise on the line.

Message Garbled

Lightning, electrical disturbances, and random noise may introduce errors on the communications line or between the MODEM and the DSC.

Bit Loss

Inaccurate timing in the MODEM may cause the entire message to be shifted forward by 1 bit.

5.5.2 DETECTION LOGIC

The primary error detection capability is provided by the 6675 DSC and the 8231 DSC hardware in the form of a 12-bit cyclic code encoder. Continuously, a 12-bit cyclic code word is generated automatically by the transmitting data set adapter and appended as the last transmitted word. Likewise, the receiving DSC generates a 12-bit word which is compared to the last word received. When the two cyclic code words are identical, no errors have been detected and transmission is assumed to be correct as received.

The detection logic flows as follows: The data stream may be considered to be equivalent to a binary polynomial, where the 1's and 0's of data are the coefficients of the terms in the polynomial. The first bit transmitted (the high order bit of the first word) corresponds to the highest order term of the polynomial. Each data set adapter divides (Exclusive OR) the data polynomial by a fixed 12-bit divisor. At the end of transmission, the remainder is appended to the data stream by the transmitting DSC. The receiving DSC continues dividing to include the remainder transmitted, yielding a new remainder of zero if the data polynomials are identical.

By terminating input or output on the line, the computer indicates to the DSC when to expect the cyclic code word. For example, when a message is being received, the transfer length is used by the receiving program to read the exact number of words in the transfer. After the last word is read, the program allows the maximum time between words (about 290 microseconds) to be exceeded, indicating to the DSC that the next word to be read is the cyclic code word. A subsequent status check of the DSC will indicate if a cyclic code error occurred. If the transfer length is received incorrectly, the wrong word will be signaled as the cyclic code word, which usually results in a cyclic code error.

In some cases, a transmission error is detected apart from the cyclic code check. This occurs when analysis of the control data received shows an impossible condition (such as an invalid transfer length) or an inconsistent request. In these cases, the transmission is treated as if a cyclic code error has been detected.

5.5.3 DETECTION CAPABILITY AND FEATURES

The scheme outlined in the previous section provides the following error detection checks:

- Any odd number of errors
- All error bursts of 12 bits or less in length
- 99.95 percent of all error bursts 13 bits long
- 99.98 percent of all error bursts longer than 13 bits

An error burst is defined as any pattern of errors with length equal to the number of bits between the first and last errors of the transmission.

This cyclic code protection scheme is highly efficient, since only 12 parity bits are required for the entire transmission. For the usual 322 word transmission, only one extra word is added — the transfer is 99.7 percent data. Each 12-bit word contains two 6-bit characters in display code. Since each data bit in the polynomial has positional value, any bit or word loss is detectable.

5.5.4 ERROR COMPENSATION

With each transmission of EXPORT/IMPORT, the sequence bit normally alternates between 0 and 1. However, when the receiving computer detects an error, the sequence bit for its next transmission is not changed, and the previous transfer is retransmitted.

Therefore, when a transfer is received with a sequence bit that has not changed from the last transmission, the receiver must retransmit its previous transfer.

This scheme may be summarized in the following rules which are observed by both EXPORT and IMPORT:

Acknowledge only error-free transmissions.

Retransmit until acknowledgment is received.

(Acknowledgment means a change in the sequence bit.)

An additional error recovery scheme provides for recovery from a SYNC word error. Should both computers be in the transmit mode, the remote computer will be placed in the receive mode when it has attempted to transmit n^\dagger times without receiving a SYNC word acknowledgment.

If, for any reason, the communications line goes down between transfers, the data set controllers detect and inform the computers of the malfunction. This is one of several conditions that are checked by each computer before initiating input or output. Should communications go down, EXPORT and IMPORT also output messages to their respective operators, notifying them of the malfunction.

For example, when a computer goes down while transmitting, the receiving computer inputs idle characters for the remainder of the transfer. Then, at the conclusion of input, the cyclic code indicates that a malfunction occurred. Further attempts to retransmit will not hang up the sending computer, but the sending computer continues to detect that the other computer is down or off-line.

If either computer goes down before or during input or output, however, the other computer detects this and informs its operator of the malfunction.

[†] Assembly time parameter.

6.1 INITIALIZATION OF EXPORT

When EXPORT is called to a control point by the operator request n. EXPORT, an initialization program is loaded into an available PP and started running. Sufficient central memory storage for working storage and overlays is requested immediately. EXPORT overlays are read from disk into the PP and then placed in central memory at its control point for rapid accessibility. The communications overlay is intercepted before it is written to central memory; and a routine is entered to initialize it for the appropriate channel (of the 6675), to build function codes from the Equipment Status Table entry, etc. Finally, the resident program is loaded and the initialization of EXPORT is complete.

6.2 OVERALL FLOW

Processing is controlled by the EXPORT resident which resides in PP memory until all lines become inactive. The main control loop of the EXPORT program cycles among several activities in the resident routine and two overlays called from central memory. The first overlay handles all communications with IMPORT. The second overlay processes directives from all active remote terminals.

6.2.1 RESIDENT ACTIVITIES

The resident routine described below is one of the three major areas through which the main control loop of the EXPORT program passes.

Check SCOPE Write Requests

The CM card input buffer status is checked for each active line; and if a completed write is indicated, the buffer parameters are updated. Status is set to indicate Reader Buffer Empty.

Central Operator to Remote Messages

The buffer that contains messages from the central operator is checked for an entry. The message buffer for the terminal specified by the entry is checked and if there is sufficient space, the message is moved to the buffer. The indicator is cleared to allow additional operator messages. Status is set to indicate that a message is waiting.

Display Messages for Central Operator

This activity determines whether or not the last message was acknowledged by the operator's entering n.GO. for EXPORT's control point. Status is set for the appropriate terminal to indicate that another message may be sent.

Check SCOPE Read Requests

The CM print and punch buffer status is checked for each active line; and if a completed read is indicated, the status is set to indicate Printer Data Available or Punch Data Available. A check also is made to determine whether or not the end of information has been read. If so, status is set to indicate the completion of printing or punching.

Scan FNT for Remote Output Files

The entire FNT is scanned for remote print or punch file entries for the terminals attached to this DSC. This activity is performed whenever a remote terminal is not printing or punching.

6.2.2 COMMUNICATIONS OVERLAY

The EXPORT communications overlay program controls simultaneously an output status transfer and a responding input directive transfer for each active remote terminal. The program is composed of three major sections: pre-processing, exchange executive, and post-processing.

Preprocessing Section

The preprocessing section of the communications overlay prepares the status transfers for each active line. If a line is inactive, a status check is made; and if the interrupt bit is set, the line is made active. The line is made inactive if the previous directive transfer indicated end of operations. Other lines are checked for active status; and if all lines are inactive, the channel and the PP are released and EXPORT enters PP recall.

The status transfer is set up in the proper PP buffer for each line. Buffer status for the print or punch files is checked, and requests are made to SCOPE for any nearly empty buffers. When the EOF is reached for print or punch files, they are released.

Exchange Executive

All transfers between EXPORT and IMPORT are handled by the exchange executive. All four lines are operated synchronously, one word at a time, every 290 microseconds. The output status transfer that is set up by the preprocessing section is sent first to each line, and then the input directive transfer is received immediately. All outputs are started at the same time; however, later in the cycle, some lines may be in their input phase before the output of long transfer is completed for other lines. The executive maintains control until the input phase of all lines is completed. Each active line is processed through the phases listed below:

- Begin output to remote terminal
- Output to remote terminal
- Check SYNC word acknowledge
- Begin input
- Input first word
- Input from remote terminal
- Check cyclic code
- Finish transfer

If an error is detected in any of the phases, a flag is set.

Post-Processing Section

The post-processing section updates, for each active line, several counts which are maintained in central memory; blocks received and transmitted, retransmissions, cyclic errors, and SYNC errors. Also, the current status code and directive codes are preserved. These statistics are kept in the control point area, in the control statement buffer.

6.2.3 PROCESSOR OVERLAY

The processor overlay program processes the directives received from all currently active remote terminals. When all lines have been checked and all directives have been processed, control returns to the resident. Directives which result from activities of the remote operator are described below:

Request Status (STAT)

If the job is assigned to a control point, the job status and the central processor (CP) time and current time of day are included in a message to IMPORT with a code for "job assigned to CP." For jobs not assigned to a control point, the FNT is searched, and a message is generated for transmission to IMPORT with a code for "not in system", "in stack", or "in output stack." IMPORT uses the message code to select the message for typing.

Load Message (DISP)

The display-coded message is checked for maximum length (40 characters) and written to the central memory remote-to-central message buffer.

Change Time Limit (CPT)

If the job specified is not at a control point, this request is ignored; otherwise, a SCOPE request is issued to change the time limit at the control point to which the job is assigned. The 12-bit time limit parameter is interpreted as tens of octal seconds. The maximum limit is 77770 octal seconds or 9.1 hours.

Change Priority (CPR)

The control points are scanned for the name of the job specified; if it is found, a SCOPE request is issued to change the priority for the job. Otherwise, the FNT is searched for the job name; and, if found, the new priority is inserted in the FNT entry. The request is ignored if the job cannot be located.

Reprint Current Job (RPNT or RPNT,n)

The reprint indicator is set for the job being printed. If printing is complete, the request is ignored. If n is specified, the print file is backspaced n sectors.

Repunch Current Job (RPCH)

The repunch indicator is set for the job being punched. If punching is complete, the request is ignored.

Abort Job (ABT)

If the job specified is currently at a control point, the operator drop bit is set in the error word in the control point area. The job name is checked against the name of the job currently being input; and if they are the same, the file is deleted. Otherwise, the FNT/FST is scanned; if the job is in the input stack, the file is deleted. If the job is in the output stack, output is not affected.

Terminate Output on Device (TERM dt)

The device code dt is checked and the appropriate file is deleted. The device code dt is either LP (line printer) or CP (card punch) in BCD.

Dispose of Punch Files at Central Site

This code directs that punch files be disposed of or punched at the central site according to an EXPORT installation parameter in the EST. This directive is generated automatically by IMPORT when a card punch is not attached.

Change Destination of Output to Central (DVT)

The FNT is scanned for files with this job name; and if they are found, the remote bit is cleared in the FNT/FST entry. If the job is being currently output, this request is ineffective.

6.3 CENTRAL MEMORY REQUIREMENTS

Central memory at the reference address (RA) of EXPORT is divided into three sections. The first two sections are fixed in size by parameters and are required when EXPORT has an active line.

The first section is the working storage area containing flags and pointers for communication with the central operator. The central-to-remote and remote-to-central messages are located here along with the File Environment Tables (FET) for each unit buffer.

The second section contains the EXPORT overlays.

The third section is of variable length and contains the unit buffers for each active line. As many as 12 unit buffers may be present. They contain the sector buffers for each device on the remote terminal. Normally, the unit buffer is eight sectors in size or 512 words. Unit buffer size is an assembly time parameter.

6.4
SPECIAL ROUTINE

Occasionally, a special peripheral routine is used by EXPORT; it is kept in the peripheral library on the system disk.

DEL - Delete Files

This peripheral program deletes a file from the system. Upon entry, the low order 18 bits of the input register point to the FNT entry. The FNT/FST entries are cleared, and the equipment and disk tracks are dropped. This routine is called at the end of normal processing for a remote job and also at certain terminating error conditions or requests.

The IMPORT program, which resides in the 8231 computer, consists of a series of processing routines and related subroutines that perform the functions required at the remote computer facility. The six major routines of IMPORT are described in detail in the following sections:

<u>Routine</u>	<u>Tag</u>
Determine Directive Code	CC
Line Printer Driver	LP
Card Reader Driver	CR
Card Punch Driver	CP
Typewriter Driver	TW
Interrupt Processing	INT

Except for the interrupt processing routine, IMPORT enters each routine in sequence, executing the functions currently required. After completing the last routine (TW), IMPORT returns to re-enter the first routine (CC). The Interrupt Processing routine (INT) is entered automatically, whenever the 8231 computer senses an interrupt. INT saves the contents of the registers for the routine interrupted and performs the processing required. Then the interrupt processor restores the registers and returns control to the interrupted routine.

Although the initialization routine is actually a subroutine, it is treated as a major routine and is described first, because it establishes communication with EXPORT.

7.1 INITIALIZATION OF IMPORT

The initialization routine establishes contact with the central computer. Jump key 2 is checked to determine if remote communications should be established. This jump key is tested only during the initialization process. If communications are to be established, the 8231 DSC sends an interrupt condition to the central 6675 DSC. The routine idles in receive mode until EXPORT can be loaded and until the first status transfer is sent.

7.2 IMPORT PROCESSING ROUTINES

Following are descriptions of the six major processing routines of IMPORT.

7.2.1 DETERMINE DIRECTIVE CODE (CC)

This activity checks the status indicators set by the drivers and creates a new directive for the next directive transfer. The Operator Request flag is checked; and if it is set, the directive for the special request is loaded. Status of central and remote buffers is checked, and if for any device the appropriate buffers are full and/or empty, the directive is loaded. The directive code is stored, and the transfer length is set, before the routine exits to the line printer driver.

7.2.2 LINE PRINTER DRIVER (LP)

The printer is checked; and if status indicates that the printer is busy, the routine exits to the card reader driver. Otherwise, a control jump is executed which allows the driver to alternate between printing a line and spacing during different passes through the main loop of IMPORT. The normal sequence has three parts. The third and first parts are accomplished during the same pass.

1. First, the next line is formed: The buffer is checked, and the two characters in the next word are converted to BCD code. These characters are inserted into the line, and the line position and word count are incremented. A check is made for the end of data. If the last block is indicated, the output in progress flag is cleared. The control jump is initialized for spacing.
2. The space control is checked, and the forms movement is initiated. The control jump is initialized for printing.
3. The first column is blanked out, and the entire line is output to the printer controller buffer. Immediately, another line is formed.

7.2.3 CARD READER DRIVER (CR)

The card reader is checked, and if status indicates that the reader is busy, the routine exits to the card punch driver. Otherwise, a control jump, which allows the driver to sequence through several activities, is executed.

The first card is processed separately; and if it is not Hollerith, CR exits, thereby ignoring initial binary cards. If column one is blank, a utility function is assumed. Otherwise, the card is processed as a job card. However, if the job table is full (24 entries), the control jump is set to return to this point and CR exits. The job card parameters are checked, and the job name is inserted into the table. The control jump is set for loading a job.

The load job routine processes Hollerith, binary, EOR, and EOF cards, and handles buffer switching. For Hollerith cards, trailing blanks are deleted in groups of ten characters, and the image is converted to display code. The image is transferred to the proper buffer unless it is full, in which case the control jump is set to return to this point. Binary cards are transferred directly. At an EOR, buffers are switched; and the EOR is noted. At an EOF, buffers are switched; and the EOF is noted. Also, the control jump is set for the Process-First-Card section.

7.2.4 CARD PUNCH DRIVER (CP)

The card punch is checked; and if status indicates that the punch is busy, the routine exits to the typewriter driver. Otherwise a control jump is executed, which allows the driver to sequence through several activities.

The card image is formed: The buffer is checked; and if it is empty, the control jump is set to return to this point. If the card is binary, the word count and function are set; and the entire card is moved directly to the punch area. For Hollerith cards, the two characters in each word are converted to BCD; and they are inserted into the punch area. Mode is selected, and the card is output to the buffer of the card punch controller.

7.2.5 TYPEWRITER DRIVER (TW)

The typewriter driver controls input from and output to the remote operator. Since I/O on the typewriter is very slow, only one character at a time is processed by the driver; and a control jump is used to sequence each operation. Message input begins after a carriage return. When message input is completed, the typewriter input table is scanned for a routine to process the request. Any parameters are coded, and a directive is created. The Operator Request flag is set, and the driver exits to the CC routine. If no carriage return occurs, the error stack is checked for any entries.

Three types of entries are possible: for operator error messages and I/O messages, a tab function is output to the typewriter, and the two-character error code is printed, preceded by an asterisk; for a normal entry, a subroutine is entered to handle the condition. The error stack is moved down, and the driver exits to CC routine.

If there were no entries in the error stack, a check is made for a message from EXPORT. For valid message codes, a subroutine is entered to format the information received for the typewriter. Finally, control returns to the first routine (CC).

7.2.6 **INTERRUPT** **PROCESSING (INT)**

Interrupt processing is controlled by a small interrupt resident which saves the registers and memory bank controls, jumps to the proper interrupt routine, and restores the registers and bank controls before exiting to the interrupted program. Input and output are initiated in separate routines as described below. Any manual interrupts are ignored.

Input

Input from the communications line is begun by obtaining the status of the 8231 DSC. A buffered input is initiated; and the interrupt control jump is set for the Wait-Receive routine. The Wait-Receive routine checks the sequence bit of the status transfer, and if it did not change, enters the Output Initiate routine to retransmit. Directive and status sequence bits are changed.

The routine checks for a cyclic code error and, if it is indicated, enters the Output Initiate routine to retransmit. Directive and status sequence bits are changed.

Output

Output to EXPORT is identical for a normal request and a retransmission, since the buffer address and sequence bits are set outside the Output Initiate routine. After DSC status is checked, the transmit mode is selected, the buffer channel registers are set, and the output is initiated. The interrupt control jump is set to End-of-Transmit.

The End-of-Transmit routine checks the DSC status to determine that the SYNC word has been acknowledged. If so, the input routine is entered immediately. Otherwise, a retransmission is initiated until eight† tries have been made, at which time the 8231 is placed in the receive mode by entering the input routine.

7.3 UTILITY FUNCTIONS

Two utility operations, card-to-printer and card-reproducing, are possible when the IMPORT program is in the non-communications mode (jump switch 2 is set initially). The first card read selects the operation to be performed. Column one must be blank; and, if column two is blank, the deck is listed; otherwise, the deck is reproduced. Listing is single-spaced, and binary cards are ignored. Both BCD and binary cards are reproduced. To establish communication, IMPORT must be restarted and jump switch 2 must be reset.

† Installation parameter

INDEX

- Bit loss 5-4

- Card punch 2-2
 - Controller 2-2
 - Driver (CP) 7-1, 3
- Card reader 2-1, 2
 - Controller 2-1
 - Driver (CR) 7-1, 3
- CC 7-1, 2
- Central computer 2-1
- Central memory requirements 6-5
- Central operator actions 4-1
- Character set 5-3
- Coaxial cable 2-2; 5-1
- Communications
 - equipment 2-2
 - line 2-2
 - overlay 6-2, 3
 - rules 5-1
- COMMUNICATIONS LOST 4-6
- CP 7-1, 3
- CR 7-1, 3
- CYCLIC 4-2

- Data block 5-2
- Data channel converter 2-1
- DATA PHONE 2-1, 2; 5-1
- Data set controller 2-1; 5-1, 4
- Dayfile 4-1
- DEL 6-6
- Detection capability 5-5
- Detection logic 5-4, 5
- Determine directive code (CC) 7-1, 2
- Directive transfer 5-1
 - format 5-3
 - length 5-3

- Directive word 5-1, 3
- Disk sector 3-1

- Enter-Sweep switch 4-2
- EOF 3-1
- EOR 3-1
- ERR 4-2
- Errors,
 - burst 5-5
 - causes 5-4
 - compensation 5-6
 - detection scheme 5-3, 4
- EST 3-2
- Exchange logic 5-1
- EXPORT 1-1; 3-3, 4, 5, 6, 7; 5-1
- EXPORT program 6-1

- FET 6-5
- FNT/FST 3-1, 2; 6-4, 5, 6

- Hardware requirements 2-1

- IDLE 4-1
- IMPORT 1-1; 3-3, 4, 5, 6, 7; 5-1; 7-1
- IMPORT processing routines 7-2
- Information messages 4-1, 2
- Initialization 3-1
 - EXPORT 3-2; 6-1
 - IMPORT 5-3; 7-1
- Input from cards 3-1
- Input/output messages 5-4
- INT 7-1, 4
- Internal BCD 3-1
- Interrupt processing (INT) 7-1, 4
- I/O typewriter 2-2

- **J 4-3
- Job flow 3-1, 3, 4, 5, 6, 7
 - output 3-7
 - processing 3-2, 5
 - termination 3-6
- Jump keys 4-6

Line printer 2-1, 2
 Controller 2-1
 Driver (LP) 7-1, 2
Load job 3-4
LOST 4-2
LP 7-1, 2

Master Clear switch 4-2
MESSAGE 4-2
Message garbled 5-4
 lost completely 5-4
MODEM 2-2; 5-4
Motor Power switch 4-3

On-Line I/O typewriter 2-1
Operator action messages 4-2
 requests 4-1
Output to printer and punch 3-1
Overall flow 6-1

**P 4-3
Paper tape perforator 2-2
 reader 2-2
P register 4-2
PRINT 4-1
Processor overlay 6-3, 4, 5
PUNCH 4-1

READ 4-1
Ready switch 4-3
Recovery procedures 4-5
Remote computer terminal 2-1
Remote operator actions 4-2
Request to load 3-3
Resident activities 6-1, 2
REX 4-2
Run-Step switch 4-2, 3

SCOPE 1-1, 2; 3-1, 5, 6; 5-3
SCOPE interface 3-2, 4
Sequence bit 5-2, 3, 6

SHUTDOWN 4-1
Special routine 6-6
Startup procedure 4-2
Status transfer 5-1
 format 5-2
 length 5-2
Status word 5-1, 2
STORAGE 4-2
SYNC word error 5-6
System components 1-1
System dependencies 1-2

Telpak-A line 2-2; 5-1
Termination of EXPORT 3-2
Trailing blanks 3-1
Transfer formats 5-2
Transfer length 5-2, 3
TW 7-1, 3
Typewriter
 Driver (TW) 7-1, 3
 input statements 4-3, 4
 messages 4-4, 5

**U 4-3
Utility
 functions 7-5
 operations 1-1

Z register 4-2

CONTROL DATA

C O R P O R A T I O N

COMMENT AND EVALUATION SHEET
6400/6600 EXPORT/IMPORT
8231 Reference Manual

Pub. No. 60189100

April, 1967

THIS FORM IS NOT INTENDED TO BE USED AS AN ORDER BLANK. YOUR EVALUATION OF THIS MANUAL WILL BE WELCOMED BY CONTROL DATA CORPORATION. ANY ERRORS, SUGGESTED ADDITIONS OR DELETIONS, OR GENERAL COMMENTS MAY BE MADE BELOW. PLEASE INCLUDE PAGE NUMBER REFERENCE.

FROM NAME : _____

BUSINESS ADDRESS : _____

NO POSTAGE STAMP NECESSARY IF MAILED IN U. S. A.

FOLD ON DOTTED LINES AND STAPLE

STAPLE

STAPLE

FOLD

FOLD

FIRST CLASS
PERMIT NO. 8241
MINNEAPOLIS, MINN.

BUSINESS REPLY MAIL
NO POSTAGE STAMP NECESSARY IF MAILED IN U.S.A.

POSTAGE WILL BE PAID BY

CONTROL DATA CORPORATION
Documentation Department
3145 PORTER DRIVE
PALO ALTO, CALIFORNIA

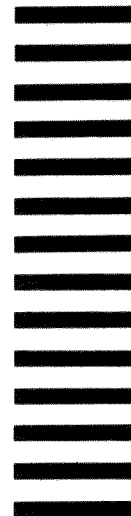

FOLD

FOLD

STAPLE

STAPLE