



**CDC[®] 721-301 ENHANCED
GRAPHICS/FIRMWARE OPTION**

<u>Functions</u>			
<u>Key Legend</u>	<u>Highlight</u>	<u>Other</u>	<u>Comments</u>
ERASE	Erases while backspacing alpha cursor.	BS code is transmitted to host system.	Operates similar to backspace, but erases the character to be changed.
← or ←	Backspaces alpha cursor.	BS code is transmitted to the host system.	Backspaces the alpha cursor without changing the display.
DATA] (closing bracket).] code is transmitted to the host system.	The closing bracket (]) is an often-used key in some application, but it is an uppercase entry. The DATA key provides a convenient single-key entry.
□	Clears screen.	Selects Alpha mode; places alpha cursor in home position.	Same as CLEAR key, but at a more convenient location for the operator.
↑ (shift) and □	Moves alpha cursor to home position.	Selects Alpha mode; selects size 1 characters.	Same as HOME key (shifted 5/HOME key), but at a more convenient location for the operator.
CLEAR	Clears screen.	Selects Alpha mode; places alpha cursor in home position.	The P/CLEAR/EOL key (shifted or unshifted) always performs a local page clearing function; that is, no signal transmitted to the host system.
HOME	Moves alpha cursor to home position.	Selects Alpha mode; selects size 1 characters.	Must be shifted 5/HOME key. Pressing 5/HOME key when shift-lock is selected and lock is active, does not perform a home function, but selects Block mode.
→	Tab.	HT code is transmitted to host system.	
NEXT	Carriage return.	CR code is transmitted to host system.	
M REL	Reinitializes graphics firmware.		Must be shifted M REL/BREAK key. Does not break connection with the host system. Does not change line, duplex, lock or baud-rate selections.
SETUP	Operator parameters are displayed.		Allows operator to change operator parameter selections.



**CDC® 721-301 ENHANCED
GRAPHICS/FIRMWARE OPTION**

REVISION RECORD

REVISION	DESCRIPTION
01 (05-12-83)	Preliminary release. Manual reflects graphics firmware at revision 2.1.
02 (06-15-83)	Preliminary release. Manual reflects graphics firmware at revision 2.1.
A (08-03-83)	Manual released. Manual reflects graphics firmware at revision 2.2. This printing obsoletes all previous editions.

Publication No.

62950116

Address comments concerning this manual to:

Control Data Corporation
 Publications and Graphics Div.
 2401 North Fairview Avenue
 St. Paul, Minnesota 55113

REVISION LETTERS I, O, Q AND X ARE NOT USED

©1983

by Control Data Corporation
 Printed in the United States of America

or use Comment Sheet in
 the back of this manual.



**CDC® 721-301 ENHANCED
GRAPHICS/FIRMWARE OPTION**

REVISION RECORD

REVISION	DESCRIPTION
01 (05-12-83)	Preliminary release. Manual reflects graphics firmware at revision 2.1.
02 (06-15-83)	Preliminary release. Manual reflects graphics firmware at revision 2.1.
A (08-03-83)	Manual released. Manual reflects graphics firmware at revision 2.2. This printing obsoletes all previous editions.

Publication No.
62950116

Address comments concerning this manual to:

Control Data Corporation
Publications and Graphics Div.
2401 North Fairview Avenue
St. Paul, Minnesota 55113

REVISION LETTERS I, O, Q AND X ARE NOT USED

©1983

by Control Data Corporation
Printed in the United States of America

or use Comment Sheet in
the back of this manual.

LIST OF EFFECTIVE PAGES

New features, as well as changes, deletions, and additions to information in this manual are indicated by bars in the margins or by a dot near the page number if the entire page is affected. A bar by the page number indicates pagination rather than content has changed.

PAGE	REV	PAGE	REV	PAGE	REV
Cover Page	-				
Title Page	-				
ii thru xii	A				
1-1 thru 1-5	A				
2-1 thru 2-16	A				
3-1 thru 3-26	A				
4-1 thru 4-11	A				
5-1 thru 5-8	A				
A-1 thru A-4	A				
B-1 thru B-9	A				
C-1 thru C-9	A				
D-1 thru D-3	A				
E-1/E-2	A				
Comment Sheet	A				
Mailer	-				
Back Cover	-				



PREFACE

This manual contains operating and reference information for the CDC® 721-301 Enhanced Graphics/Firmware Option. The graphics firmware resides in a memory module to be installed in the CDC 721-30/31 Graphics/PLATO Display Terminal.

Operationally, the CDC enhanced graphics firmware used with the 721-30/31 terminal closely emulates the Tektronix 4010-Series Graphic Display Terminal. Differences are discussed in section 1.

Information related to the enhanced graphics firmware discussed in this manual includes:

- General description
- Graphics operation
- Graphics modes
- Peripheral equipment
- Coordinate conversion

AUDIENCE

This manual is intended for use primarily by applications programmers whose programming directly deals with the terminal's detailed operational characteristics. Familiarity with Tektronix 4010-Series graphics terminals is useful, but not required.

NOTE

Readers concerned primarily with the option's installation and use with prewritten graphics applications should refer to appendix B. Installation and preparation of a graphics tablet (optional) is covered in appendix E.

RELATED PUBLICATIONS

Associated manuals include:

<u>Title</u>	<u>Publication Number</u>
CDC 721 Display Terminal Operator's Guide/ Installation Instructions Manual	62940019
CDC 721 Enhanced Display Terminal Operator's Guide/Installation Instructions Manual	62950101
CDC 721-X0 Display Terminal Hardware Reference Manual	62940020
CDC 721-X0 Enhanced Display Terminal Hardware Reference Manual	62950102
Tektronix 4010 and 4010-1 Computer Display Terminal User's Manual	070-1225-00
Tektronix 4014 and 4014-1 Computer Display Terminal User's Manual	070-1647-00

The Control Data manuals may be ordered from:

Control Data Corporation
Literature and Distribution Services
308 North Dale Street
St. Paul, Minnesota 55103

CONTENTS

1. GENERAL DESCRIPTION

Equipment Configuration	1-2
Control Data Graphics Operation Features	1-3
Compatibility with Tektronix 4010-Series Graphic Display Terminal	1-3
Data Entry	1-4
Data Display	1-5

2. GRAPHICS OPERATION

Graphics Display Orientation	2-1
Coordinates	2-2
Coordinate Precision	2-2
Coordinate Scaling	2-2
Selection of Coordinate Scaling and Origin Bias	2-3
Scaled 10-Bit Coordinates	2-3
Scaled 12-Bit Coordinates	2-4
Unscaled 10- and 12-Bit Coordinates	2-5
Keyboard Operation	2-6
Principal Keys and Their Functions	2-6
Shift Keys	2-6
Lock Key	2-6
CTRL (Control) Key	2-7
Character Writing Methods	2-7
Parameters	2-8
Terminal Installation and Mode Installation Parameters	2-8
Operator Parameters	2-8
Initial Conditions	2-9
Aborts and Recovery	2-9
Setting Operator Parameters	2-10
Host System Communications	2-13
Data Flow Control	2-13
Buffer Control	2-12
X-ON/X-OFF Control	2-13
Enabling/Disabling X-ON/X-OFF Control	2-13
Protocol	2-14
Additional Flow Control Precautions	2-14
Status Monitoring	2-14
Switching Between Graphics Operation and CYBER Mode	2-15
Off-Line Operation	2-16

3. GRAPHICS MODES

Graphics Mode Selection.	3-1
Coordinates.	3-2
Display Bypass	3-3
Escape Sequences	3-3
Escape Enquiry (ESC ENQ) Character Sequence for Graphics Modes	3-3
Graphics Modes in Detail	3-5
Alpha Mode	3-5
Alpha Mode Character Writing Methods	3-7
Alpha Mode Margin Operation	3-8
Alpha Mode Page-Full Operation	3-8
Transition to Alpha Mode	3-9
Alpha Mode Control Characters.	3-9
Alpha Mode Escape Sequences.	3-10
Graph Mode	3-11
Transition to Graph Mode	3-12
Graph Mode Escape Sequences.	3-12
Point Plot Mode.	3-13
Transition to Point Plot Mode.	3-13
Point Plot Mode Escape Sequences	3-13
Special Point Plot Mode	3-14
Transition to Special Point Plot Mode	3-14
Special Point Plot Mode Escape Sequences	3-15
Incremental Plot Mode	3-16
Transition to Incremental Plot Mode	3-16
Incremental Plot Mode Escape Sequences	3-16
Block Mode	3-16
Transition to Block Mode	3-16
Block Mode Escape Sequences.	3-17
Graphics Input (GIN) Mode.	3-17
Transition to GIN Mode	3-17
Cursor Positioning in GIN Mode	3-18
GIN Mode Escape Sequences.	3-19
GIN Mode Transmission.	3-19
Control Codes and Escape Sequences for Graphics Operation.	3-20

4. PERIPHERAL EQUIPMENT

Print Options.	4-1
Screen Copy Mode	4-1
Screen Copy Printing	4-1
Stopping Screen Copy Printing Early.	4-2
Printer Errors in Screen Copy Mode	4-2
Parallel Printer	4-2
Serial Printer	4-2
Printer Error Recovery in Screen Copy Mode	4-2
Duty Cycle Protection (Parallel Printer Only)	4-3
Screen Copy Performance.	4-3

Communications Print Mode	4-4
Select Communications Print Mode	4-4
Deselect Communications Print Mode	4-5
Printer Errors in Communications Print Mode	4-5
Printer Error Recovery in Communications Print Mode	4-5
Parallel Printer	4-5
Serial Printer	4-6
Communications Print Performance	4-6
Graphics Tablet Operation	4-6
Connection to the Graphics Tablet	4-7
Graphics Tablet Cursor Control	4-7
Transmission of Graphics Tablet Cursor Position to the Host System	4-7
Graphics Tablet Activity	4-9
Graphics Tablet Operation States	4-9
Select Graphics Tablet	4-10
Graphics Table Under Arming Sequence Control	4-10
Deselect Graphics Tablet	4-11

5. COORDINATE CONVERSION	5-1
--------------------------	-----

APPENDIXES

A. GLOSSARY	A-1
B. INSTALLATION PROCEDURE AND PARAMETER SETTINGS	B-1
C. KEYBOARD CODES	C-1
D. PERFORMANCE CONSIDERATIONS	D-1
E. GRAPHICS TABLET SWITCH SETTINGS	E-1

FIGURES

1. GENERAL DESCRIPTION	
1-1 Graphics Firmware Memory Module	1-1
1-2 Equipment Configuration	1-2
1-3 Keyboard and Touchpanel	1-5

2. GRAPHICS OPERATION

2-1	Display Screen Layout	2-1
2-2	Display With Scaled 10-Bit Coordinates	2-4
2-3	Display With Scaled 12-Bit Coordinates	2-5
2-4	Display With Unscaled 10-Bit and 12-Bit Coordinates	2-5
2-5	Operator Parameters Display	2-10
2-6	Terminal Indicators	2-15

3. GRAPHICS MODE

3-1	Control Codes and Sequences Used to Select Graphics Modes	3-2
3-2	Character Size Samples	3-5

B. INSTALLATION PROCEDURE AND PARAMETER SETTINGS

B-1	Memory Module Insertion	B-2
B-2	Mode Select Menu	B-3
B-3	Terminal Installation Parameters	B-3
B-4	Mode Installation Parameters	B-6
B-5	Operator Parameters	B-8

C. KEYBOARD CODES

C-1	721-30/31 Standard Keyboard	C-2
C-2	Keystation Assignments	C-2

TABLES

3. GRAPHICS MODE

3-1	ESC ENQ Character Sequence for Graphics Modes	3-4
3-2	ESC ENQ Byte 1 Values for Graphics Modes	3-4
3-3	Character Size and Format	3-6
3-4	Dot Matrix Sizes	3-6
3-5	Cursor Home Position Versus Character Size	3-7
3-6	Incremental Plot Mode Command Characters	3-15
3-7	GIN Mode Cursor Positioning Keys	3-18
3-8	GIN Mode Character Sequence	3-20
3-9	Graphics Operation Control Codes	3-21

- 4. PERIPHERAL EQUIPMENT
 - 4-1 Graphics Tablet Cursor Position Format for
10-Bit Coordinates 4-8
 - 4-2 Graphics Tablet Cursor Position Format for
12-Bit Coordinates 4-8

- 5. COORDINATE CONVERSION
 - 5-1 Coordinate Position Bit Assignments - 10-Bit
Coordinates 5-2
 - 5-2 Coordinate Position Bit Assignments - 12-Bit
Coordinates 5-2
 - 5-3 Coordinate Byte Transmission Requirements. 5-4
 - 5-4 Ten-Bit Coordinate Conversion (ASCII Operations) . . 5-5

- B. INSTALLATION PROCEDURE AND PARAMETER SETTINGS
 - B-1 Terminal Installation Parameter Settings B-4
 - B-2 Transmit/Receive Baud Rate Settings B-5
 - B-3 F3 and F4 Mode Installation Parameter Settings . . B-7

- C. KEYBOARD CODES
 - C-1 Keyboard Legends and Codes C-3
 - C-2 Character Codes C-8
 - C-3 ASCII Control Characters C-9

- E. GRAPHICS TABLET SWITCH SETTINGS
 - E-1 Graphics Tablet Data Format E-2



The 721-301 enhanced graphics firmware resides in a memory module (refer to figure 1-1) that plugs into the back of a 721-30/31 Graphics/PLATO Display Terminal. Appendix B includes detailed installation information.

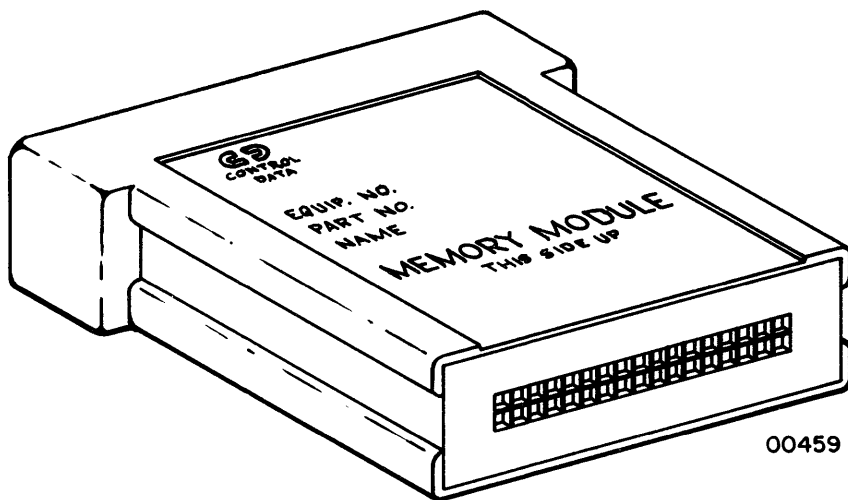
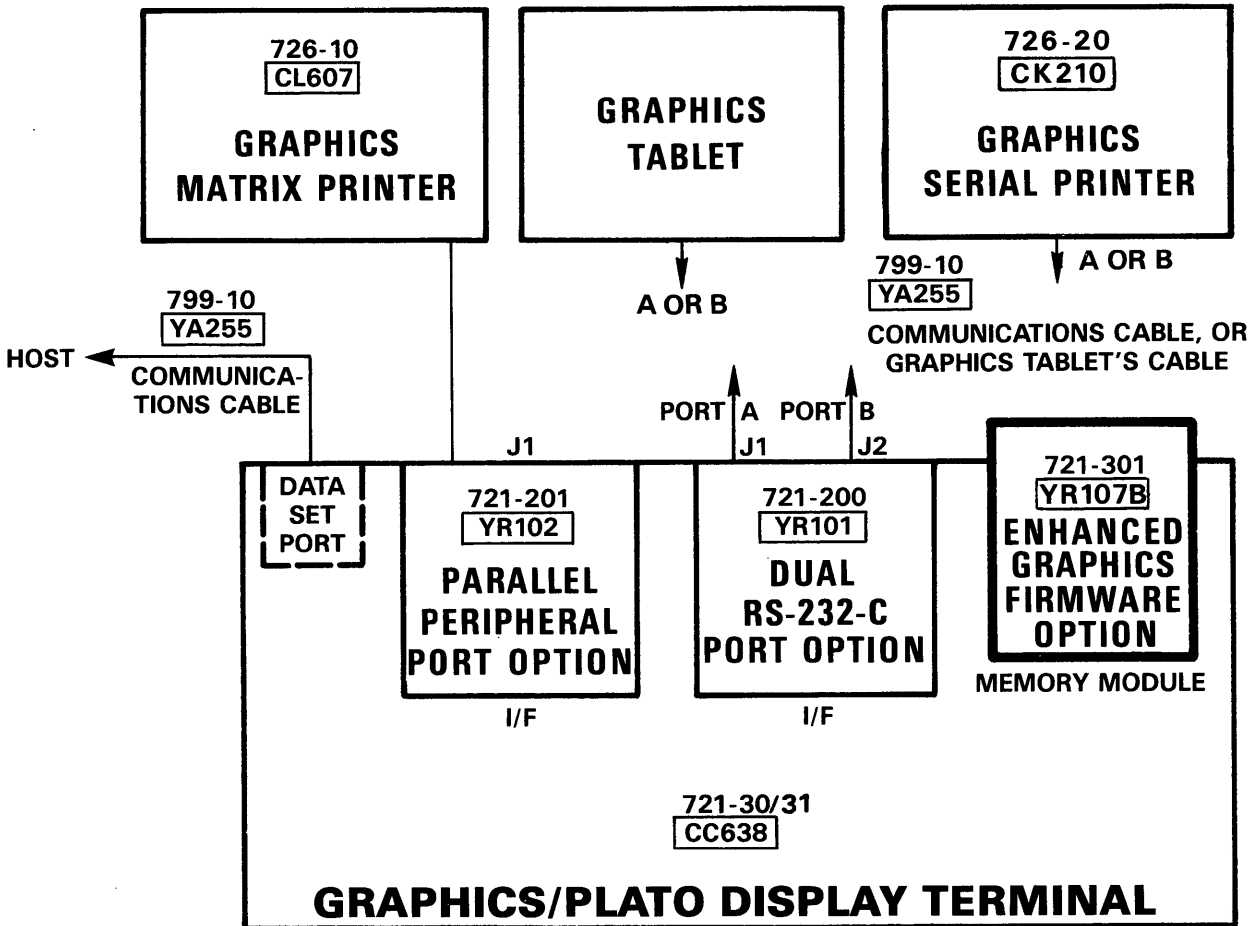

Figure 1-1. Enhanced Graphics Firmware Memory Module

The enhanced graphics firmware supports the following peripheral equipment (refer to figure 1-2).

- A CDC 726-10 Graphics Matrix Printer connected via the CDC 721-201 Parallel Peripheral Port Option.
- A CDC 726-20 (Graphics Serial Printer connected via port A or B of the CDC 721-200 Dual RS-232-C Port Option.
- A graphics tablet connected via port A or B of the CDC 721-200 Dual RS-232-C Port Option.



05070

Figure 1-2. Equipment Configuration

The enhanced graphics firmware does not require use of the printer, graphics tablet, or either port. Refer to appendix E for information on the supported graphics tablets.

CONTROL DATA GRAPHICS OPERATION FEATURES

The performance of the CDC enhanced graphics firmware with the 721-30/31 terminal is compatible with the capabilities of the Tektronix 4010-Series graphics terminal. The graphics firmware communications protocol matches that of the Tektronix 4010-Series. In addition, the CDC graphics firmware provides features not available with the Tektronix 4010-Series. These include:

- Selective erasure of points, lines, or characters without clearing the display screen.
- The capability to erase or write (fill) rectangular areas of the screen by specifying two opposite corners of each area.
- Communication speeds selectable up to 19 200 baud.
- A coordinate display area that is effectively 30 percent larger than that of Tektronix 4010-Series.

COMPATIBILITY WITH TEKTRONIX 4010-SERIES GRAPHIC DISPLAY TERMINAL

Though compatible, the CDC enhanced graphics firmware with the 721-30/31 terminal and a Tektronix 4010-Series terminal differ as follows:

- The CDC terminal displays 512 by 512 addressable points on a touch-sensitive area of the screen; Tektronix terminals display either 780 by 1024 or 3120 by 4096 addressable points. For Tektronix-patterned applications, the CDC enhanced graphics firmware downscales coordinates by a factor of 2 or 8, respectively.
- The CDC terminal displays the crosshair cursor used for graphics input as a plus sign (+); Tektronix terminals display the cursor as two intersecting lines extending the full height and width of the screen.
- Manual positioning of the crosshair cursor on the CDC terminal is done using the touchpanel, numeric keypad, and/or graphics tablet; manual cursor positioning on Tektronix terminals is done using thumbwheel controls.

- The CDC enhanced graphics firmware supports five character sizes, four of which approximate the Tektronix terminal character sizes within the limits of the 512 by 512 resolution. (The two smallest character sizes are extremely small and provided only for compatibility purposes; their use should be limited.)
- The CDC enhanced graphics firmware does not support an alternate character set.
- The CDC host system-to-terminal communications rate may be limited in some situations if data flow control is not utilized (refer to X-ON/X-OFF Control in section 2).
- The CDC enhanced graphics firmware automatically transmits a CR (carriage return) character following transmission of the cursor position to the host system. Other automatic characters available with Tektronix terminals are not supported.
- The CDC terminal does not support intensity control of the graphics display beam.

DATA ENTRY

Data entry is done via the 721-30/31 keyboard and display screen touchpanel shown in figure 1-3. A graphics tablet may also be used for data entry; refer to Graphics Tablet Operation in section 4.

The keyboard consists of data entry keys which, when used alone or with other keys, transmit ASCII codes to the host system. Refer to Keyboard Operation in section 2 for further discussion of the keyboard.

The touchpanel occupies a central, square area of the display screen. It consists of 256 pressure-sensitive areas overlaying the display screen in a 16 by 16 matrix, as shown in figure 1-3. In terminal modes supporting touchpanel input, touching the touchpanel surface captures the intersecting X/Y coordinates for processing and produces an audible tone.

The touchpanel and numeric keypad keys (1 through 4 and 6 through 9 at the right on the keyboard) are used to position the crosshair cursor for entering graphics data. Refer to Cursor Positioning in Graphics Input (GIN) Mode in section 3 for detailed information. Additional characteristics of the graphics tablet are discussed in section 4 under Graphics Tablet Operation.

MATRIX LINES IN TOUCHPANEL
ARE NEARLY INVISIBLE AND
ARE EXAGGERATED HERE FOR
ILLUSTRATING PURPOSES

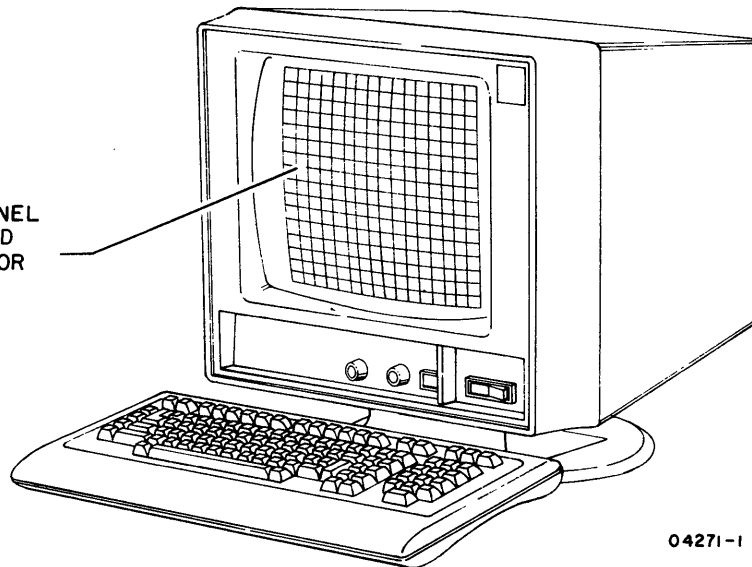

04271-1

Figure 1-3. Keyboard and Touchpanel

DATA DISPLAY

The cathode-ray tube (CRT) screen displays data in an array of dots, each of which may be on or off. As such, host system or terminal keyboard data may be displayed in various combinations as points, lines, characters, or solid rectangular blocks.



This section describes graphics display orientation, coordinate precision keyboard operation, operator parameters, and host system communications.

GRAPHICS DISPLAY ORIENTATION

The CDC 721-30/31 terminal provides a graphics display area with a square 512 by 512 resolution (refer to figure 2-1). The unenhanced Tektronix 4010-Series terminal provides a graphics display area with a rectangular 1024 (horizontal) by 780 (vertical) resolution. The enhanced Tektronix 4010-Series terminal provides a graphic display area with a rectangular 4096 (horizontal) by 3120 (vertical) resolution.

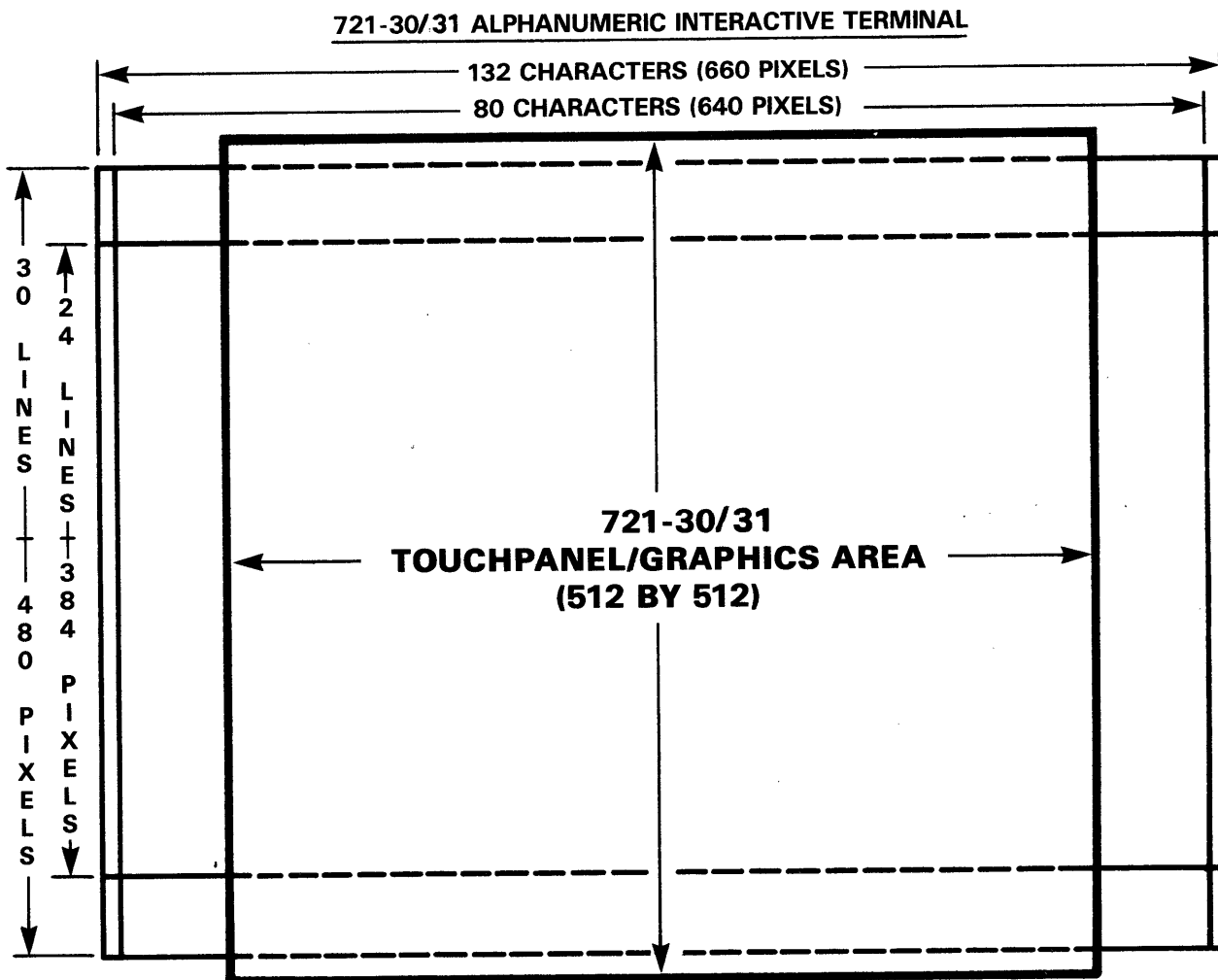

Figure 2-1. Display Screen Layout

COORDINATES

Data coordinates used with CDC enhanced graphics firmware may be represented with 10- or 12-bit precision, scaled or unscaled, and represented in ASCII, hexadecimal, or decimal form. Coordinate precision and coordinate scaling are discussed in this section, and coordinate conversion is discussed in section 5.

Coordinate Precision

The enhanced graphics firmware operates with either 10 or 12 bits of precision with coordinates sent to or received from the host system. Though the 721-30/31 terminal display screen can display to a resolution of 9 bits (512 by 512), all coordinates are represented to 12-bit precision by the 721-30/31 terminal firmware. The 9 most significant bits of the internal coordinates are used when displaying data on the screen (the 3 least significant bits are disregarded by the display).

Graphics tablet coordinates are generated to 12-bit precision, although these may be sent to the host system with either 10- or 12-bit precision (refer to Graphics Tablet Operation in section 4). Display coordinates may be received from the host system with 10- or 12-bit precision. When a 10-bit coordinate is received, it is multiplied by four, with the 2 least significant bits of the resulting coordinate set to zeros. The formats used for transmission of 10- and 12-bit coordinates are shown in tables 5-1 and 5-2 in section 5, Coordinate Transmission and Conversion.

Coordinate Scaling

Data coordinates received from the host system may be scaled or unscaled, as selected by the programmer/operator (refer to Setting Operator Parameters in this section). Scaling refers to reducing each coordinate by a factor of 2 or 8, which allows the CDC 721-30/31 terminal to use applications designed for the Tektronix 4010-Series terminal. Applications developed for the 512 by 512 resolution use unscaled coordinates.

Scaled coordinates may be displayed with or without Y bias. Y bias moves the origin of the display upward and creates two logically separate display areas.

Selection of Coordinate Scaling and Origin Bias

Selection of scaled or unscaled coordinates and biased or unbiased origin position is done using the F7 function key as described under Setting Operator Parameters later in this section, or by escape sequences as described in the following paragraph.

Receipt of ESC < from the host system selects scaled coordinates with Y bias. Receipt of ESC = from the host system selects scaled coordinates without Y bias. Receipt of ESC > from the host system selects unscaled coordinates.

Scaled 10-Bit Coordinates

When using scaled 10-bit coordinates without Y bias, the display screen is addressed as shown in figure 2-2(A). The original X coordinate range of 0 through 1023 is reduced by one-half to a range of 0 through 511. The original Y coordinate range of 0 through 779 is reduced by one-half to a range of 0 through 389.

When using scaled 10-bit coordinates with Y bias, the display screen is addressed as shown in figure 2-2(B). The 10-bit X and Y coordinates are scaled in the same way as when no Y bias is used, except that the origin is moved upward 122 positions, creating two logically separate areas. The upper 512 by 390 area corresponds proportionately to the 1024 by 780 area coordinates of the Tektronix 4010-Series terminal. The lower 512 by 122 area (Y coordinates 780 through 1023) is intended for use as a dialog area.

NOTE

Unpredictable results may occur if these areas are not treated as two independent and separate areas when the origin is biased upward (Y bias).

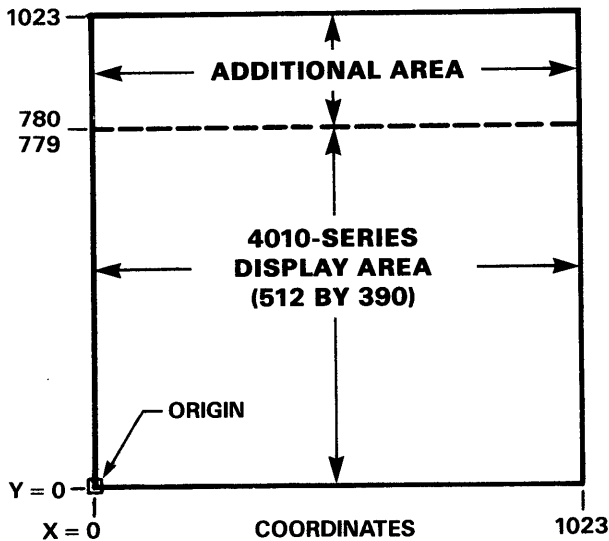

(A) SCALED-UNBIASED

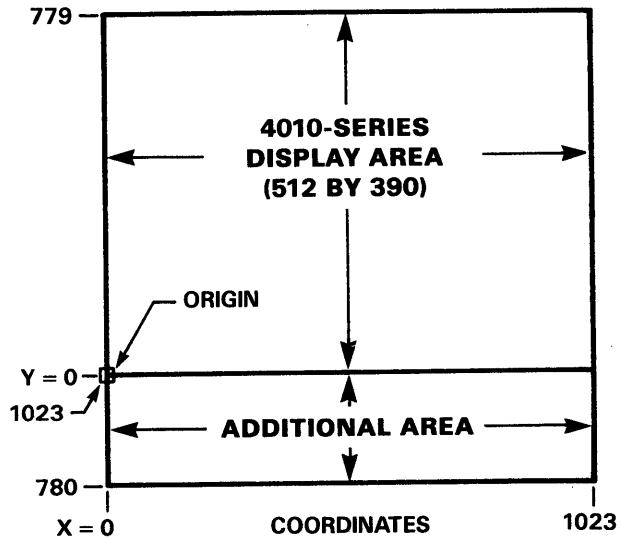

(B) SCALED-BIASED

Figure 2-2. Display With Scaled 10-Bit Coordinates

Scaled 12-Bit Coordinates

When using scaled 12-bit coordinates without Y bias, the display screen is addressed as shown in figure 2-3(A). The original X coordinate range of 0 through 1023 is quadrupled to a range of 0 through 4095. The original Y coordinate range of 0 through 1023 is quadrupled to a range of 0 through 4095.

When using scaled 12-bit coordinates with Y bias, the display screen is addressed as shown in figure 2-3(B). The 12-bit X and Y coordinates are scaled in the same way as when no Y bias is used, except that the origin is moved upward 122 positions, creating two logically separate areas. The upper 4096 by 3120 area corresponds proportionately to the 1024 by 780 area coordinates of the unenhanced Tektronix 4010-Series terminal. The lower 4096 by 976 area (Y coordinates 3120 through 4095) is intended for use as a dialog area.

NOTE

Unpredictable results may occur if these areas are not treated as two independent and separate areas.

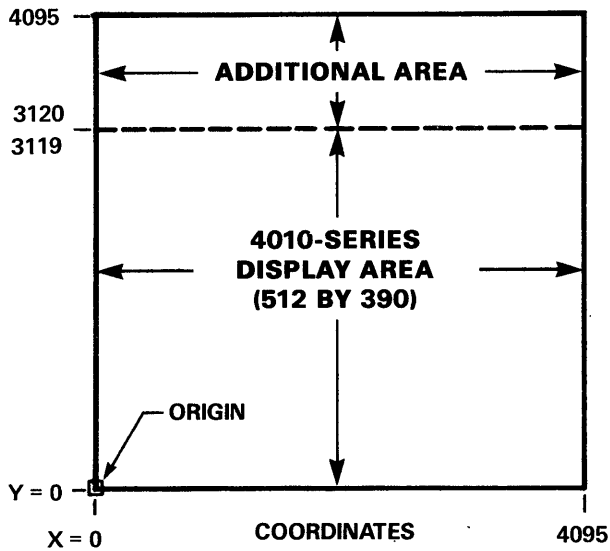

(A) SCALED-UNBIASED

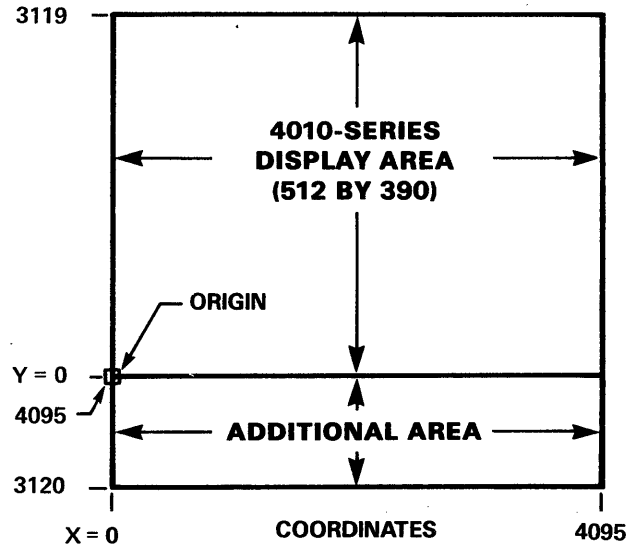

(B) SCALED-BIASED

Figure 2-3. Display With Scaled 12-Bit Coordinates

Unscaled 10- and 12-Bit Coordinates

When using unscaled coordinates, the display screen is addressed as shown in figure 2-4. The X and Y coordinates both range from 0 to 511 (10-bit coordinates) or 0 to 2047 (12-bit coordinates).

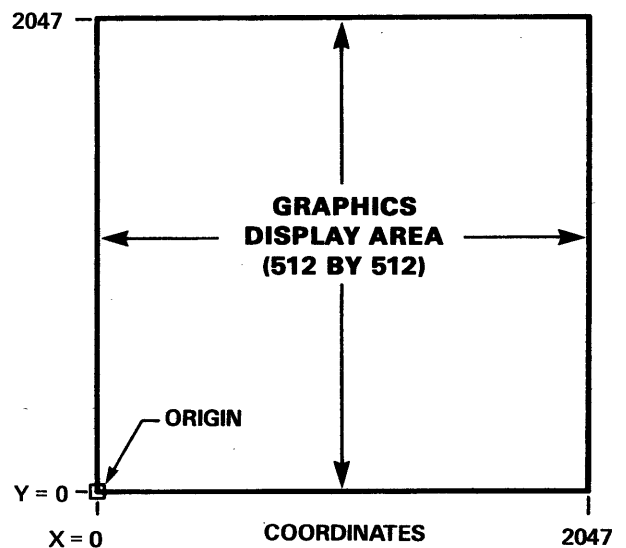
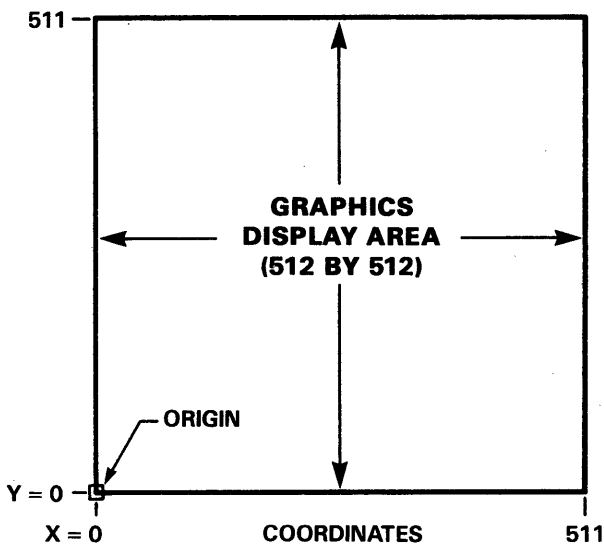

Figure 2-4. Display With Unscaled 10-Bit and 12-Bit Coordinates

KEYBOARD OPERATION

The 128 ASCII graphic and control character codes are entered using the data entry keys on the 721-30/31 terminal keyboard. These codes are displayed or transmitted as directed by the DUPLEX and LINE parameter settings (refer to Operator Parameters later in this section).

The multifunction keyboard and keystation assignments, complete with the corresponding keyboard legends and codes table, are described in appendix C.

PRINCIPAL KEYS AND THEIR FUNCTIONS

When entering graphic and control character codes, the following keys are frequently used.

↑ (Shift) Keys

Pressing either of the two shift keys along with any key that has only one symbol on it transmits an uppercase code for that key. Pressing either shift key along with any key that has two symbols on it transmits the upper symbol of the key. Refer to table C-1 in appendix C for a complete listing of shifted and unshifted codes relating to each key.

Ⓛ (Lock) Key

The function of this key is determined when the operator sets the parameters (described later in this section under Operator Parameters). The operator selects one of two modes, alpha-lock or shift-lock, to govern use of the lock key. The lock key's indicator is lit when the key is in lock mode.

Alpha-lock disables the generation of lowercase codes. With the lock key activated, all alphabetic keys pressed transmit only the uppercase code. Special function, control, and numeric keys are unaffected in alpha-lock mode.

Shift-lock, when activated, causes any keys pressed to transmit the control function represented by the upper symbol (unless modified by a specific mode). Exceptions are the key, the M REL/BREAK key, the CR/DEL key, and the LF/ESC key, which remain unshifted.

CTRL (Control) Key

Pressing the CTRL key in conjunction with any data entry key or combination of data entry and shift keys transmits the codes depicted in table C-1 of appendix C (unless modified by a specific mode).

CHARACTER WRITING METHODS

The 721-30/31 terminal offers four methods of displaying characters. For each method, the character dot pattern is represented differently in display memory. The four methods and their characteristics are:

- Overstrike Write (OS W) - The character dot pattern is superimposed over the existing dot pattern in display memory, which allows characters to be written over graphic figures on the screen without losing any of the figures' dot patterns. The characters are light on a dark background. Characters are written on the display screen in overstrike write unless otherwise selected from the host system, or the operator changes the writing method by pressing the F9 key. (Refer to Setting Operator Parameters later in this section.)
- Overstrike Erase (OS E) - The character dot pattern is erased from the existing dot pattern in display memory. If overstrike erase is used over a light background (for example, Block mode rectangular fill), the characters appear dark on the light background. If overstrike erase is used over a dark background, no characters appear on the screen.
- Clear Write (CLR) - The character dot pattern replaces the existing dot pattern in display memory. The characters are light on a dark background.
- Inverse Video (INV) - The character dot pattern is the same as clear write, but inverted. The characters are dark on a light background.

PARAMETERS

Three types of parameters define the characteristics of graphics operation:

- Terminal installation parameters
- Mode installation parameters
- Operator parameters

TERMINAL INSTALLATION AND MODE INSTALLATION PARAMETERS

The descriptions of these parameters are detailed in the 721-X0 Display Terminal Hardware Reference Manual or the 721-X0 Enhanced Display Terminal Hardware Reference Manual listed in the preface. Suggested settings and possible options are shown in appendix B.

OPERATOR PARAMETERS

These parameters define:

- On-line or off-line communications
- Printing of display screen or communications data
- Half-duplex or full-duplex communications
- Baud rate
- Alpha-lock or shift-lock mode
- Coordinate scaling/bias
- Data flow control from host system
- Writing method
- Mode of graphics operation
- Margin 1 or 2 operation with page-full condition
- Bidirectional or unidirectional screen copy printing with serial graphics printer
- Graphics tablet control method

Initial Conditions

The initial state of some operator parameters is set when the mode installation parameters are fixed in the nonvolatile memory (NVM). The remaining operator parameters may be set or changed to the desired settings during graphics operation. The following initial conditions exist after the firmware has been accessed from the memory module and initialized:

- The display screen is erased.
- Margin 1 operation is selected.
- Size 1 characters are displayed.
- Alpha mode is selected and the alpha cursor is in the home (upper left corner) position.
- The character writing method is overstrike write.
- Display screen printing is enabled and communications printing is disabled.
- Page-full operation is disabled.
- The terminal is set to on-line or off-line, half duplex or full duplex, alpha-lock or shift-lock, and the appropriate baud rate, all determined by the previously selected mode installation parameters.
- Coordinate scaling without Y bias is selected.
- Buffered data flow control (X-ON/X-OFF) is enabled.
- The graphics revision level is displayed.
- The $\text{\textcircled{f}}$ (lock) key is inactive so the key is not lit.
- The graphics tablet (if present) is active.

Aborts and Recovery

The firmware can be reset to initial conditions by pressing the M REL key. The LINE, DUPLEX, LOCK, and BAUD selections are left the same as selected before pressing the M REL key. Pressing the RESET button causes the terminal to exit from graphics operation and reinitialize.

Setting Operator Parameters

Setting or changing operator parameters is accomplished using the operator parameters display shown in figure 2-5. (The graphics information below the boxes appears alternately upon pressing the corresponding function key; the second line of the operator parameters display appears by pressing the F10 key (MORE SELECT) in the first line.) The display screen data (if any) that appeared before the operator parameters display was accessed is retained. Loading the firmware from the memory module (refer to appendix B) transfers applicable parameters from nonvolatile memory (NVM) to an active section of random access memory (RAM). Accessing the operator parameters display allows the parameters to be set or changed. The parameter settings in NVM do not change regardless of whether terminal power is on or off.

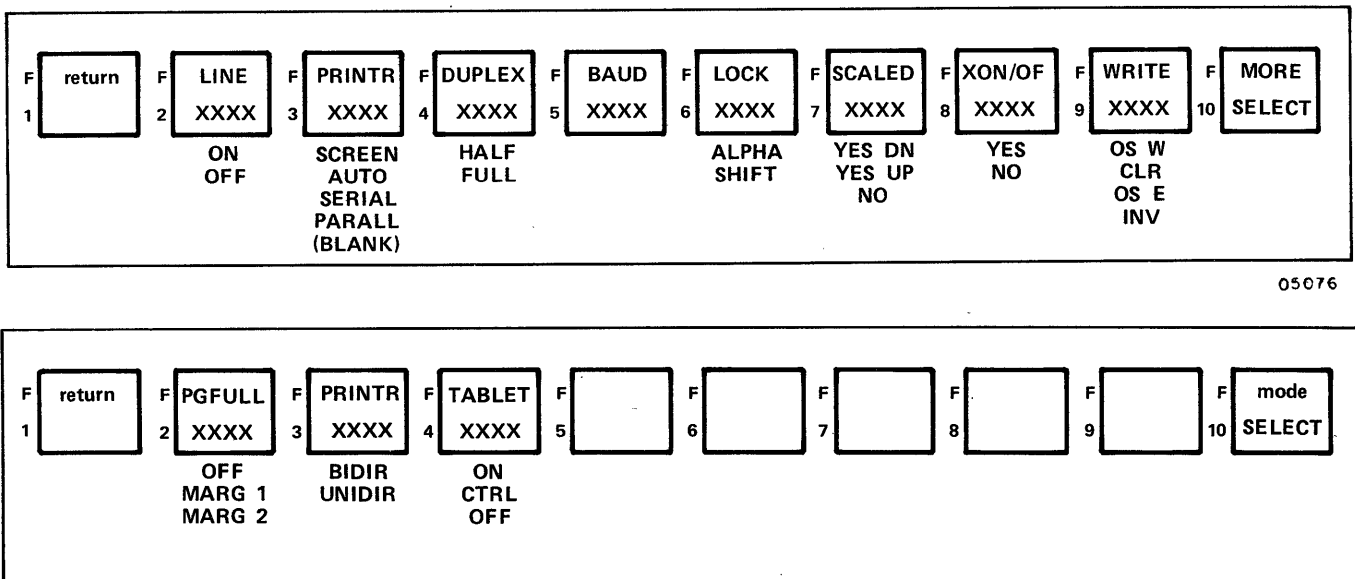

05076

Figure 2-5. Operator Parameters Display

The following list describes the functions of the SETUP and function keys when used with the first line of the operator parameters display (figure 2-5). When locating keys F1 through F10, note the raised lettering immediately below the top row of keys. Any keycap marking on these keys should be ignored.

<u>Key Pressed</u>	<u>Function</u>
SETUP	Access operator parameters display.
F1 (return)	Exit operator parameters display to graphics operation mode.
F2 (LINE)	Select on-line (ON) or off-line (OFF) communications.

Key Pressed

Function

F3 (PRINTR)	Select printing of graphics or communications. SCREEN selects printing of display screen graphics; AUTO selects automatic printing of display screen graphics in response to a page-full condition. SERIAL selects communications printing on the serial printer; PARALL selects communications printing on the parallel printer. If the space is blank, no printer is installed.
F4 (DUPLEX)	Select half-duplex (local echo) or full-duplex communications.
F5 (BAUD)	Select baud rate at 75, 110, 150, 200, 300, 600, 1200, 1800, 2400, 4800, 9600, or 19 200.
F6 (LOCK)	Select alpha-lock or shift-lock mode (refer to Principal Keys And Their Functions earlier in this section).
F7 (SCALED)	Select scaled or unscaled coordinates and biased or unbiased origin position (refer to Coordinate Scaling earlier in this section). YES DN selects scaling without Y bias; YES UP selects scaling with Y bias (DN and UP refer to the origin position). NO selects nonscaled coordinates.
F8 (XON/OF)	Select YES (flow control on) or NO (flow control off) buffered data flow control from the host system. Refer to X-ON/X-OFF Control later in this section for further details of operation.
F9 (WRITE)	Select writing method. OS W (overstrike write), CLR (clear write), OS E (overstrike erase), or INV (inverse video). Refer to Character Writing Methods earlier in this section.
F10 (MORE SELECT)	Exit operator parameters line 1 to operator parameters line 2.

The following list describes the functions of the function keys when used with the second line of the operator parameters display (figure 2-5).

<u>Key Pressed</u>	<u>Function</u>
F1 (return)	Exit operator parameters display to graphics operation mode.
F2 (PGFULL)	Select page-full condition characteristics. OFF disables page-full condition; MARG 1 selects page-full condition to occur when line-feeding past bottom of screen with either margin 1 or 2 active; MARG 2 selects page-full condition to occur when line-feeding past bottom of screen with margin 2 active.
F3 (PRINTR)	Select bidirectional (BIDIR) or unidirectional (UNIDIR) screen copy printing with serial graphics printer.
F4 (TABLET)	Select graphics tablet control method. ON selects the graphics tablet always active; CTRL sets the graphics tablet to recognize the arming/disarming control command; OFF disables the graphics tablet.
F10 (MODE SELECT)	Exit graphics operation mode to initial mode-select menu. Exiting graphics operation mode this way does not break connection with the host, nor does entering another mode or reentering graphics operation. However, exiting this way nullifies temporary operator parameter settings, and returns the parameters to their initial state upon reentry to graphics operation mode.

HOST SYSTEM COMMUNICATIONS

Communication with a host system that supports ASCII occurs over the RS-232-C data set port of the 721-30/31 terminal (refer to the equipment configuration shown in figure 1-2). Operator-selectable parameters involving host system communications are data flow (baud) rate, number of data bits, parity, and number of stop bits (refer to appendix B and either the 721 Display Terminal Operator's Guide/Installation Instructions manual or the 721 Enhanced Display Terminal Operator's Guide/Installation Instructions manual listed in the preface). Host system communications are subject to data flow control, described as follows.

DATA FLOW CONTROL

Because the 721-30/31 terminal takes varying amounts of time to perform different commands sent from the host system, data flow control is used to balance the data supply (host system) and processing (terminal) rates. Data flow control consists of buffer control and X-ON/X-OFF control.

Buffer Control

A 990-byte buffer receives data from the host system and transmits it to the terminal at a compatible rate. In most cases, the buffer is large enough so that the 721-30/31 terminal with X-ON/X-OFF control not used can be operated at up to 2400 baud without losing data.

X-ON/X-OFF Control

X-ON/X-OFF (transmission-on/transmission-off) flow control is used to provide the maximum data flow rate from host system to terminal without losing data from buffer overflow. This is accomplished by temporarily stopping transmissions from the host system when needed.

X-ON/X-OFF combines buffer control with terminal-initiated commands to the host system (refer to Protocol, following). When the buffer fills beyond a predefined limit, data flow from the host system is stopped until the buffer empties below another limit, after which data flow resumes. X-ON/X-OFF may be used at rates up to 19 200 baud.

Enabling/Disabling X-ON/X-OFF Control

X-ON/X-OFF control is initially enabled. It can be disabled/reenabled using the F8 function key when operator parameters are displayed (refer to Setting Parameters in appendix B), or by receipt of the ESC [(enable) or ESC] (disable) sequences.

Protocol

The protocol for X-ON/X-OFF data flow control is as follows:

1. When the 990-byte receive buffer fills beyond 767 characters, the terminal sends a DC3 control character to the host system, indicating X-OFF (turn transmission off).
2. The host system responds to the DC3 by stopping data transmission (usually within one or two characters) before the buffer is full.
3. After the buffer empties to less than 256 characters, the terminal sends a DC1 control character to the host system, indicating X-ON (turn transmission on).
4. The host system responds to the DC1 by continuing transmission from where it had stopped.

Additional Flow Control Precautions

When the host system does not control data transmissions to the terminal in accordance with the flow control protocol, or flow control is not used for some other reason, terminal performance must be considered as described in appendix D. If the time required to execute host system commands to the terminal is known to be excessive, the host system may add SYN control characters to the command code to give the terminal time to perform the commands. In this way, should the receive buffer overflow, only the nonessential SYN characters and no meaningful data will be lost.

STATUS MONITORING

Host system communications line status is displayed by an indicator on the terminal indicator panel (refer to figure 2-6). The red ERROR indicator lights if a communications parity or framing error is detected on received data. The ERROR indicator will remain lit until the operator initiates a transmission to the host system. Refer to the 721 Operator's Guide/Installation Instructions Manual listed in the preface for corrective actions.

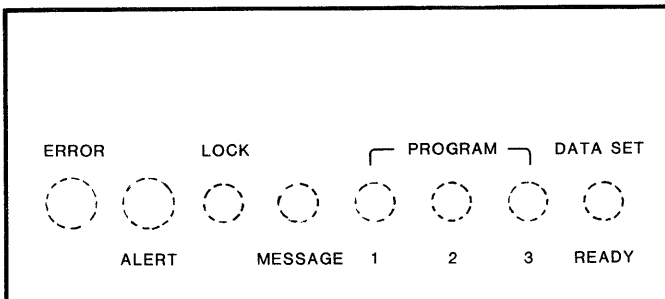
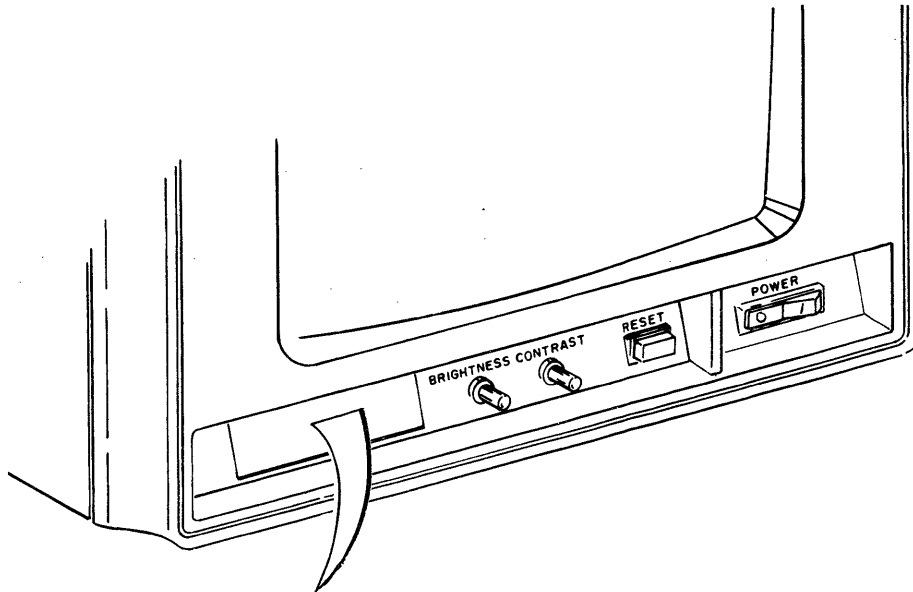

04218

Figure 2-6. Terminal Indicators

SWITCHING BETWEEN GRAPHICS AND CYBER MODES

The enhanced graphics firmware allows the host system or operator to switch from graphics operation to CYBER mode operation and back again without leaving the loaded mode. When either mode switch occurs, the terminal screen is cleared but the operator parameters are not changed. (Auto answer cannot be performed in this version of CYBER mode.)

The host system can switch the terminal from graphics operation to CYBER mode operation by sending an ESC ETX character sequence to the terminal. Switching back to graphics operation is accomplished by sending an ESC SOH character sequence to the terminal.

OFF-LINE OPERATION

Local operations can be performed at the terminal after selecting off-line communications. Off-line is selected by pressing the F2 key while the operator parameters are being displayed, as discussed under Setting Operator Parameters earlier in this section. Pressing NEXT puts the cursor at the beginning of the next line; that is, it performs a carriage return and line feed.

This section describes the seven graphics modes of the CDC graphics firmware, and lists the control codes and escape sequences for graphics operation.

The seven modes, and their primary use, are:

- Alpha mode - To display characters.
- Graph mode - To draw a line between two sets of coordinates or perform random positioning.
- Point Plot mode - To display one point at specified coordinates.
- Special Point Plot mode - To display one point at specified coordinates (functionally identical to Point Plot mode; ensures compatible data format with applications developed for the same mode in Tektronix 4010-Series graphic terminals).
- Incremental Plot mode - To simulate the operation of an incremental digital plotter on the display screen.
- Block mode - To write or erase rectangular blocks.
- Graphics Input (GIN) mode - To transmit coordinates and status to the host system.

GRAPHICS MODE SELECTION

ASCII control characters are used to select a mode and certain functions within that mode. Table C-3 in appendix C lists the control characters, related keystrokes, and control codes. Figure 3-1 shows the control codes and sequences used to select a mode.

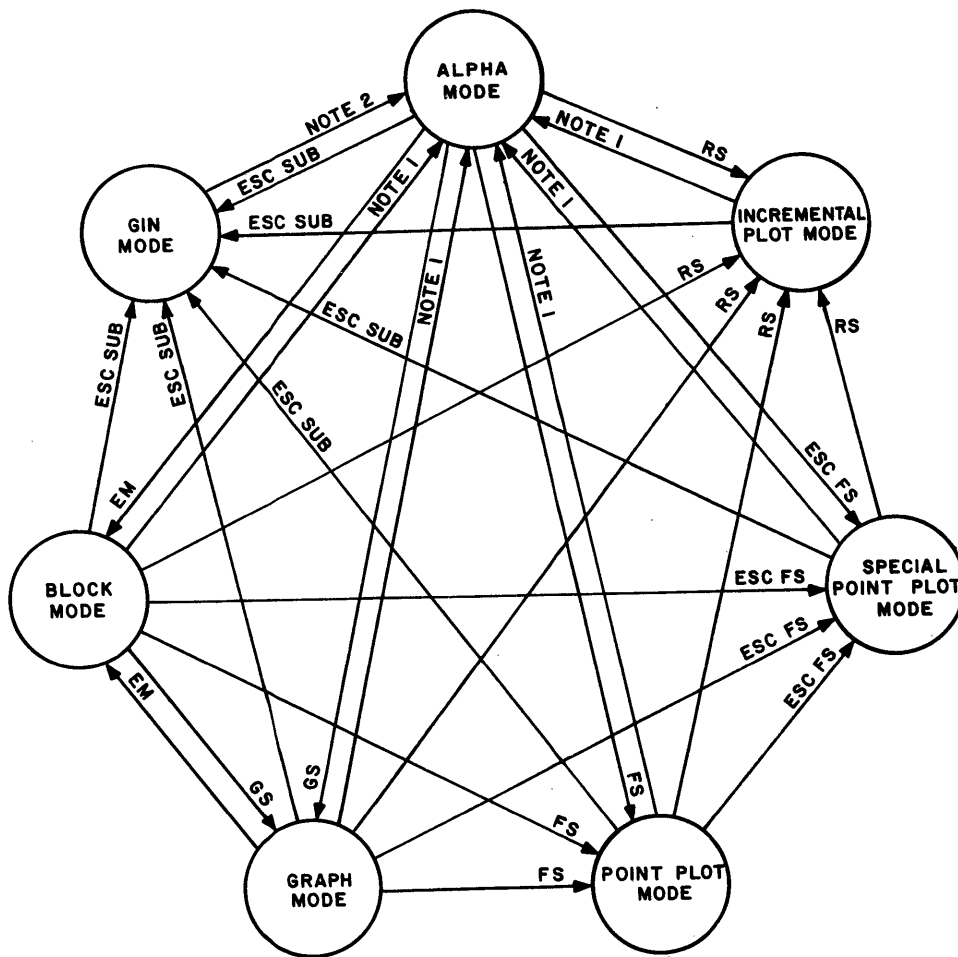

Figure 3-1. Control Codes and Sequences Used to Select Graphics Modes

COORDINATES

The Graph, Point Plot, Special Point Plot, and Block modes all require coordinate data to be passed between the host system and the graphics terminal. The coordinate data is represented by ASCII character codes. The conversion of coordinate data to ASCII character codes is described in section 5. An understanding of the information presented in section 5 is necessary to use the graphics features efficiently.

DISPLAY BYPASS

Display bypass prevents the screen display of data passed to and from a host system. The following program commands set and clear display bypass, in addition to performing their primary functions described in the following pages.

- Set display bypass

ESC CAN
ESC SUB

- Clear display bypass

BEL ESC BEL
BS ESC BS
CR
HT ESC HT
LF
VT ESC VT
 ESC FF
US ESC US

ESCAPE SEQUENCES

Escape sequences are used to select functions, deselect previously selected functions, and provide terminal status and cursor position to a host system. These sequences begin with an ESC control code. Valid escape sequences for each of the seven graphics modes are described later in this section. Escape sequences can be entered by the host system or from the terminal keyboard.

Escape Enquiry (ESC ENQ) Character Sequence for Graphics Modes

The ESC ENQ sequence causes the terminal to automatically transmit terminal status and the mode's current X,Y position to the host system. Display bypass is not affected but when in GIN mode, an exit occurs to Alpha mode. If a screen copy (print) operation is active when this sequence is received, the terminal transmission is deferred until the copy operation terminates. The response character sequence for all modes is shown in table 3-1. The hexadecimal value for ESC ENQ byte 1 for each mode is shown in table 3-2.

TABLE 3-1. ESC ENQ CHARACTER SEQUENCE FOR GRAPHICS MODES

BYTE	ITEM	DATA (HEXADECIMAL)*
1	Terminal status**	Status byte**
2	High bits of X coordinate	5 MSB X + 20 ₁₆
3	Low bits of X coordinate	5 LSB X + 20 ₁₆
4	High bits of Y coordinate	5 MSB Y + 20 ₁₆
5	Low bits of Y coordinate	5 LSB Y + 20 ₁₆
6	CR	0D ₁₆

*MSB and LSB in this column are most significant bits and least significant bits, respectively.

**Refer to table 3-2 for specific values. For GIN mode, byte 1 does not transmit to the host system; only five bytes (2 through 6) transmit.

TABLE 3-2. ESC ENQ BYTE 1 VALUES FOR GRAPHICS MODES

BYTE	ITEM	BYTE 1 (HEXADECIMAL)
Alpha	Terminal status	35*
Graph	Terminal status	39*
Point Plot	Terminal status	31*
Block	Terminal status	31*

*Subtract 10₁₆ if graphics printer is attached, ready to print, and Screen Copy mode is selected. For example, 25₁₆ would be returned as the status byte for Alpha mode.

GRAPHICS MODES IN DETAIL

Following is a description of each of the seven graphics modes.

ALPHA MODE

The terminal is set to Alpha mode upon entering graphics operation. In Alpha mode, the terminal displays the 95 ASCII graphics characters (including the space character) and displays. The DEL character is ignored.

Alpha mode provides five character sizes: the 721-30/31 terminal's standard large size (size 0), plus four smaller sizes that closely emulate the four Tektronix 4014 character sizes. Refer to figure 3-2 for samples of each character size as displayed on the screen.

Size 0 !"#\$%&'()*+,-./0123456789:;<=>?
@ABCDEFGHIJKLMNPOQRSTUVWXYZ[\]^_
`abcdefghijklmnopqrstuvwxy{ }~■

Size 1 !"#\$%&'()*+,-./0123456789:;<=>?
@ABCDEFGHIJKLMNPOQRSTUVWXYZ[\]^_
`abcdefghijklmnopqrstuvwxy{ }~■

Size 2 !"#\$%&'()*+,-./0123456789:;<=>?
@ABCDEFGHIJKLMNPOQRSTUVWXYZ[\]^_
`abcdefghijklmnopqrstuvwxy{ }~■

Size 3 !"#\$%&'()*+,-./0123456789:;<=>?
@ABCDEFGHIJKLMNPOQRSTUVWXYZ[\]^_
`abcdefghijklmnopqrstuvwxy{ }~■

Size 4 !"#\$%&'()*+,-./0123456789:;<=>?
@ABCDEFGHIJKLMNPOQRSTUVWXYZ[\]^_
`abcdefghijklmnopqrstuvwxy{ }~■

Figure 3-2. Character Size Samples

The terminal is set to size 1 display characters upon entering graphics operation. Other sizes are selected using escape sequences. Table 3-3 lists the five character sizes and compares the number of characters that can be displayed on the screen for each size.

TABLE 3-3. CHARACTER SIZE AND FORMAT

ESCAPE SEQUENCES	CHAR-ACTER SIZES	TEKTRONIX 4014 GRAPHICS DISPLAY AREA (CHARACTERS)		CDC GRAPHICS FIRMWARE			
		WIDTH	LINES	4010-SERIES DISPLAY AREA (CHARACTERS)		DISPLAY AREA TOTAL GRAPHICS DISPLAY AREA (CHARACTERS)	
				WIDTH	LINES	WIDTH	LINES
ESC 7	0	-	-	64	by 24	64	by 32
ESC 8	1	74	by 35	73	by 39	73	by 51
ESC 9	2	81	by 38	85	by 43	85	by 56
ESC :	3	121	by 58	128	by 55	128	by 73
ESC ;	4	133	by 64	128	by 65	128	by 85

Each character is made up of a series of dots in a rectangular dot matrix. Five dot matrix sizes correspond to the five character sizes (refer to table 3-4).

TABLE 3-4. DOT MATRIX SIZES

CHARACTER SIZE	DOT MATRIX SIZES	
	HORIZONTAL	VERTICAL
0	8	by 16
1	7	by 10
2	6	by 9
3	4	by 7
4	4	by 6

NOTE

Sizes 3 and 4 are very small, but are provided to accommodate existing programs.

A cursor, which appears as a blinking underline, occupies the lower dots of the character matrix and marks the position on the display screen where the next character will usually appear. Entering the character moves the cursor one position to the right. When the end of a line is reached, the cursor moves to the leftmost position on the next line. The cursor is nondestructive. Cursor home position relative to each character size is shown in table 3-5.

TABLE 3-5. CURSOR HOME POSITION VERSUS CHARACTER SIZE*

CHARACTER SIZE	CURSOR HOME POSITION		
	SCALED, NO BIAS	SCALED, WITH BIAS	UNSCALED
0	X = 0, Y = 992	X = 0, Y = 748	X = 0, Y = 496
1	X = 0, Y = 1004	X = 0, Y = 760	X = 0, Y = 502
2	X = 0, Y = 1006	X = 0, Y = 762	X = 0, Y = 503
3	X = 0, Y = 1010	X = 0, Y = 766	X = 0, Y = 505
4	X = 0, Y = 1012	X = 0, Y = 768	X = 0, Y = 506

*Coordinate values shown are for 10-bit host system coordinates; multiply these values by four for 12-bit host system coordinates.

Alpha Mode Character Writing Methods

The four methods of writing characters described in section 2 under Character Writing Methods are applicable in Alpha mode. These are:

- Overstrike write
- Clear write
- Overstrike erase
- Inverse video

Application of the writing methods is discussed under Alpha Mode Escape Sequences.

Alpha Mode Margin Operation

Alpha mode provides two margin positions for writing characters in a one- or two-column format: margin 1 and margin 2. Margin 1 exists at the left side of the display screen, and margin 2 exists at the horizontal center of the display screen. Margin 1 operation automatically applies to all graphics modes. Margin 2 operation can only be used in Alpha mode.

The effective margin in use may be margin 1 or 2, and determines which column the alpha characters appear. The effective margin switches each time the alpha cursor line-feeds past the bottom line, and the alpha cursor moves to the top line in the new effective margin. The margin 2 position is ignored when writing characters to the screen while margin 1 is the effective margin. Dual-column formatting requires that margin 2 information be kept to one-half or less of the maximum number of characters per line for the selected character size.

Receipt of CR (or equivalent operation from the keyboard) returns the alpha cursor to the effective margin position. Receipt of ESC FF or pressing the , shifted , CLEAR, or HOME key resets the terminal to margin 1 operation.

Alpha Mode Page-Full Operation

A page-full condition may occur in Alpha mode when a line-feed passes the bottom line on the display screen. The response to the condition (page-full operation) is determined by the PGFULL operator parameter (refer to Setting Operator Parameters in section 2).

When a page-full condition occurs, the ALERT indicator on the front of the terminal lights. The indicator remains lit and no further data from the host system is processed until the page-full condition is cleared, which occurs by pressing the F1 function key (without the operator parameters display present) or by transmitting a character from the keyboard to the host system. If an automatic screen copy is the response to the page-full condition, the screen will clear after the screen copy completes (clearing the page-full condition) and data from the host system will again be processed.

Transition to Alpha Mode

Control characters and keys used for transition to Alpha mode are:

- CR - This control character resets the terminal to Alpha mode, positions the alpha cursor to the effective margin position in the current line, and clears display bypass.
- ESC FF - This control character sequence resets the terminal to Alpha mode, selects margin 1 operation, positions the alpha cursor to the leftmost character position of the top line (home position), clears the display, and clears display bypass.
- US - This control character resets the terminal to Alpha mode, leaves the alpha cursor at the last Graph mode address, and clears display bypass. This character is nonfunctional in Graphics Input (GIN) mode, so it cannot be used to transfer from GIN mode to Alpha mode.
- Pressing the key or the CLEAR key resets the terminal to Alpha mode, selects margin 1 operation, positions the alpha cursor to home position, and clears the display. This function operates locally in the terminal.
- Pressing the shifted key or shifted HOME key resets the terminal to Alpha mode, selects margin 1 operation, positions the alpha cursor to home position, and selects character size 1. This function operates locally in the terminal.

Alpha Mode Control Characters

In Alpha mode, the following control characters are operational. All other control characters have no effect on graphics operation in Alpha mode.

- CR (Carriage Return) - This character moves the cursor to the effective margin position in the current line and clears display bypass. With off-line communications, or if automatic line-feed is selected, a line feed operation also occurs.
- LF (Line Feed) - This character moves the cursor down one line and clears display bypass. When the cursor passes the bottom line, the effective margin is switched and the cursor moves to the new effective margin position in the top line.

- BS (Backspace) - This character moves the cursor one position to the left and clears display bypass. When the beginning of the line is reached, the cursor moves to the last position of the line above. When the first position of the top line is reached, the cursor moves to the last position of the top (same) line.
- HT (Horizontal Tabulation) - This character moves the cursor one position to the right and clears display bypass. Spacing past the end of a line moves the cursor to the effective margin of the next lower line. If the cursor passes the last position of the bottom line, the effective margin is switched and the cursor moves to the new effective margin position in the top line.
- VT (Vertical Tabulation) - This character moves the cursor up one line and clears display bypass. When the top line is reached, no further cursor movement occurs.
- BEL (Bell) - This character sounds the audible alarm and clears display bypass.

Alpha Mode Escape Sequences

Valid escape sequences for Alpha mode are:

- ESC DC1 - This sequence sets inverse video for characters.
- ESC DC2 - This sequence sets character overstrike write.
- ESC DC3 - This sequence sets character overstrike erase.
- ESC DC4 - This sequence sets clear write.
- ESC CAN - This sequence sets display bypass, which prevents the display of data on the screen.
- ESC ENQ - Refer to Escape Enquiry (ESC ENQ) Character Sequence for Graphics Modes earlier in this section.
- ESC ! X - This triple-character sequence sets the graphics tablet under control of an arming sequence. (X is a non-control code ASCII command with a format as described under Graphics Tablet Under Arming Sequence Control in section 4.)
- ESC _ A - This triple-character sequence selects the graphics tablet for continuous operation. Refer to Select Graphics Tablet in section 4 for further details.

- ESC _ B - This triple-character sequence sets the graphics tablet under control of subsequent ESC ! X arming sequences, where X is a non-control code ASCII command with a format as described under Graphics Tablet Under Arming Sequence Control in section 4.
- ESC _ C - This triple-character sequence deselects the graphics tablet. Refer to Deselect Graphics Tablet in section 4 for further details.
- ESC _ D - This triple-character sequence causes the terminal to transmit the graphics firmware revision level to the host system. This transmission is the four ASCII characters #.#CR.
- ESC ETB - This sequence initiates a screen copy operation (refer to section 4 under Screen Copy Mode). Display bypass and the selected mode are not affected. The alpha cursor is inhibited until the copy operation terminates.
- ESC FF - This sequence clears the display, clears display bypass, and positions the alpha cursor to the leftmost character position of the top line (home position).
- ESC 7 - This sequence selects size 0 characters.
- ESC 8 - This sequence selects size 1 characters.
- ESC 9 - This sequence selects size 2 characters.
- ESC : - This sequence selects size 3 characters.
- ESC ; - This sequence selects size 4 characters.
- ESC BS, ESC HT, ESC VT, and ESC BEL operate the same as BS, HT, VT, and BEL, respectively.

CR, LF, and NUL leave the ESC condition set if it is already set.

GRAPH MODE

In Graph mode, the terminal writes and erases vectors in response to ASCII code sequences. To set vector coordinate positions, the 10- or 12-bit X and Y coordinates must be converted to ASCII characters (table 5-4 shows 10-bit coordinate conversion).

The terminal interprets these characters to define a vector. Receiving the low X coordinate initiates a vector operation. Table 5-3 shows which coordinates must be sent when coordinate values change.

The firmware ignores line feed (LF) characters received in Graph mode. When exiting Graph mode, normal vectors are selected by receiving a CR or ESC FF, or by performing a keyboard page clear or keyboard home.

Transition to Graph Mode

The GS (group separator) control character sets the terminal to Graph mode. This establishes the most recently defined coordinates, regardless of mode, as the initial Graph mode coordinates.

Initial coordinates that are set immediately after the GS character do not cause a vector to be written unless GS is immediately followed by a BEL character. This is called a dark or unwritten vector. The GS character can be sent at any time to allow the coordinate base position to be changed without causing a solid-line vector to be written.

The terminal retains the last high Y, low Y, high X, and extra byte coordinates set by Graph, Point Plot, Special Point Plot, or Block mode when switched to another mode. When entering Graph mode, only low X must be received to reset the terminal to these previous coordinates.

Graph Mode Escape Sequences

Valid escape sequences for Graph mode are:

- ESC DC1 or ESC DC3 - Either sequence is used prior to erasing the specified vector(s). All other characteristics of Graph mode remain the same.
- ESC DC2 or ESC DC4 - Either sequence is used prior to writing the specified vector(s). All other characteristics of Graph mode remain the same.
- ESC \ or ESC h or ESC p - Each sequence selects solid vectors.
- ESC a or ESC i or ESC q - Each sequence selects dotted vectors.
- ESC b or ESC j or ESC r - Each sequence selects dot-dashed vectors.

- ESC c or ESC k or ESC s - Each sequence selects short-dashed vectors.
- ESC d or ESC l or ESC t - Each sequence selects long-dashed vectors.
- ESC ENQ - Refer to Escape Enquiry (ESC ENQ) Character Sequence for Graphics Modes earlier in this section.
- ESC ETB - This sequence initiates a screen copy operation (refer to Screen Copy Mode in section 4). Display bypass and the selected mode are not affected.

NUL and CR leave the ESC condition set if already set.

POINT PLOT MODE

In Point Plot mode, a point is written or erased at the specified X,Y position.

The firmware ignores line feed (LF) characters received in Point Plot mode.

Transition to Point Plot Mode

The FS (file separator) control character sets the terminal to Point Plot mode and establishes the most recently defined coordinates (regardless of mode) as the initial Point Plot coordinates.

The terminal retains the last high Y, low Y, high X, and extra byte coordinates set by Graph, Point Plot, Special Point Plot, or Block mode when switched to another mode. When entering Point Plot mode, only low X must be received to reset the terminal to these previous coordinates.

Point Plot Mode Escape Sequences

Valid escape sequences for Point Plot mode are:

- ESC DC1 or ESC DC3 - Either sequence is used prior to erasing the specified point.

- ESC DC2 or ESC DC4 - Either sequence is used prior to writing the specified point.
- ESC ENQ - Refer to Escape Enquiry (ESC ENQ) Character Sequence for Graphics Modes earlier in this section.
- ESC ETB - This sequence initiates a screen copy operation (refer to Screen Copy Mode in section 4). Display bypass and the selected mode are not affected.

NUL and CR leave the ESC condition set if it is already set.

SPECIAL POINT PLOT MODE

CDC graphics operation provides this mode solely to achieve data format compatibility with the same mode of the Tektronix 4010-Series graphic terminal. On the 4010-Series terminal this mode allows the display beam intensity to be varied. The 721-30/31 terminal hardware does not support beam intensity control, so this mode is functionally identical to Point Plot mode.

In Special Point Plot mode operation, the ESC FS sequence must be followed by an intensity control character in the hexadecimal range of 20 through 7D. The intensity control character must also precede each successive point address. The graphics firmware functionally disregards the intensity character. Point Plot mode or Incremental Plot mode may be selected following the intensity character.

Special Point Plot mode uses the same graphics address method as Point Plot mode.

Transition to Special Point Plot Mode

The ESC FS character sequence selects Special Point Plot mode. This establishes the most recently defined coordinates (regardless of mode) as the initial Special Point Plot mode coordinates.

The terminal retains the last high Y, low Y, high X, and extra byte coordinates set by Graph, Point Plot, Special Point Plot or Block mode when switched to another mode. When entering Special Point Plot mode, only low X must be received by the terminal to reset it to these previous coordinates.

Special Point Plot Mode Escape Sequences

Valid escape sequences for Special Point Plot mode are the same as those for Point Plot mode. Refer to Point Plot Mode Escape Sequences earlier in this section.

INCREMENTAL PLOT MODE

Incremental Plot mode allows the 721-30/31 terminal to simulate the operation of the incremental digital plotter on the display screen. This mode inhibits the normal X/Y addressing used with the other graphics operation modes. Instead, this mode interprets each data byte either as a command to move one step in any of eight directions (refer to table 3-6), or to disable or reenable the display beam while the beam is being moved. With scaled coordinates, a step moves the X/Y coordinate one position; with unscaled coordinates, a step moves the X/Y coordinate two position.

TABLE 3-6. INCREMENTAL PLOT MODE COMMAND CHARACTERS

ASCII CHARACTER	HEXADECIMAL VALUE	ACTION
Space	20	Beam off*
P	50	Beam on*
D	44	Move up (+Y)
E	45	Move up and right (+X, +Y)
A	41	Move right (+X)
I	49	Move down and right (+X, -Y)
H	48	Move down (-Y)
J	4A	Move down and left (-X, -Y)
B	42	Move left (-X)
F	46	Move up and left (-X, +Y)

*When the beam is off, positioning occurs but no display screen writing is performed. When the beam is on, positioning occurs and display screen writing occurs in the selected writing code (write or erase).

Entering Incremental Plot mode establishes the most recently defined coordinates (regardless of mode) as the initial Incremental Plot mode coordinates.

Transition to Incremental Plot Mode

The record separator (RS) control character selects Incremental Plot mode.

Incremental Plot Mode Escape Sequences

- ESC DC1 or ESC DC3 - Either sequence is used prior to erasing a point.
- ESC DC2 or ESC DC4 - Either sequence is used prior to writing a point.
- ESC ENQ - Refer to Escape Enquiry (ESC ENQ) Character Sequence for Graphics Modes earlier in this section.
- ESC ETB - This sequence initiates a screen copy operation (refer to Screen Copy Mode in section 4). Display bypass and the selected mode are not affected.

NUL and CR leave the ESC condition set if it is already set.

BLOCK MODE

Block mode is used to fill or erase a rectangular area defined by two diagonally-opposite coordinate positions. After filling or erasing the rectangular area, the alpha cursor appears one character height (of whichever character size is selected; refer to table 3-2) below the first corner position given. Section 5 specifies the coordinate format. Writing or erasing is determined by escape sequences received prior to reception of the coordinates.

The firmware ignores line feed (LF) characters received in Block mode.

Transition to Block Mode

The EM (end-of-message) control character selects Block mode.

The terminal retains the last high Y, low Y, high X, and extra byte coordinates set by Graph, Point Plot, Special Point Plot or Block mode when switched to another mode. When entering Block mode, only low X must be received by the terminal to reset it to these previous coordinates.

Block Mode Escape Sequences

Valid escape sequences for Block mode are:

- ESC DC1 or ESC DC3 - Either sequence is used prior to erasing the specified rectangular area.
- ESC DC2 or ESC DC4 - Either sequence is used prior to filling the specified rectangular area.
- ESC ENQ - Refer to Escape Enquiry (ESC ENQ) Character Sequence for Graphics Modes earlier in this section.
- ESC ETB - This sequence initiates a screen copy operation (refer to Screen Copy Mode in section 4). Display bypass and the selected mode are not affected.

NUL and CR leave the ESC condition set if it is already set.

GRAPHICS INPUT (GIN) MODE

The Graphics Input (GIN) mode is interactive in that it involves computer requests for information and operator response to the requests.

A crosshair cursor, which appears as a blinking plus sign, is enabled in GIN mode. The intersect address of the crosshair cursor is the X,Y position. The cursor is nondestructive.

Transition to GIN Mode

The ESC SUB sequence selects GIN mode, activates display bypass, and enables the crosshair cursor and touchpanel. This sequence should not be entered from the keyboard when on-line to the host system.









The crosshair cursor appears at the same position it was at when the most recent GIN-to-Alpha mode transition occurred. The initial crosshair position is near the center of screen.

Cursor Positioning in GIN Mode

The following list describes ways to position the cursor with various degrees of precision. No data is transmitted to the host system when positioning the cursor by these means.

- Touchpanel - The cursor can be positioned using the display screen touchpanel. The touchpanel is sectioned into 256 pressure-sensitive areas, each 32 dots by 32 dots, which, when touched, position the cursor to the center of the selected area. An audible alarm sounds as feedback.
- Coarse movement - Pressing a key on the numeric keypad at the right of the keyboard while pressing the CTRL key moves the cursor 64 dots. Table 3-7 shows the active keys and direction of movement.
- Medium movement - Pressing a shifted key on the numeric keypad at the right of the keyboard moves the cursor eight dots. Table 3-7 shows the active keys and direction of movements.
- Fine movement - Pressing an unshifted key on the numeric keypad at the right of the keyboard moves the cursor one dot. Table 3-7 shows the active keys and direction of movement.

TABLE 3-7. GIN MODE CURSOR POSITIONING KEYS

KEYPAD KEY PRESSED	DIRECTION OF CURSOR MOVEMENT
1	 Down and Left
2	 Down
3	 Down and Right
4	 Left
6	 Right
7	 Up and Left
8	 Up
9	 Up and Right

- Graphics tablet cursor positioning - The graphics tablet cursor overrides operation of the GIN cursor. As such, the GIN cursor position is the same as the tablet cursor position in GIN mode while the tablet cursor is displayed. The graphics tablet stylus can thus be used to position the GIN cursor if the stylus tip is not raised from the tablet before exiting from GIN mode to Alpha mode. (Refer to Graphics Tablet Operation in section 4 for further information.)

GIN Mode Escape Sequences

Valid escape sequences for GIN mode are:

- ESC ENQ - Refer to Escape Enquiry (ESC ENQ) Character Sequence for Graphics Modes earlier in this section.
- ESC ETB - This sequence initiates a screen copy operation (refer to Screen Copy Mode in section 4). Display bypass and the selected mode are not affected. The crosshair cursor is inhibited until the copy operation terminates.
- ESC FF - This sequence clears the display, sets the terminal to Alpha mode, clears display bypass, and positions the alpha cursor to the leftmost character position of the top line (home position).

The firmware ignores LF characters received in GIN mode.

GIN Mode Transmission

Both of the following methods of initiating transmission to the host system also reset the terminal to Alpha mode. Display bypass is not cleared until a subsequent character or character sequence that clears display bypass is received. The response to ESC ENQ does not include a status byte while in GIN mode (refer to table 3-1). Upon exiting GIN mode the alpha cursor appears at the position where the GIN cursor was located.

Methods of initiating GIN mode transmission to the host system involve using:

- Character keys other than cursor movement keys - Character keys of this type cause transmission of the entered character and X,Y position of the crosshair cursor. The character sequence in table 3-8 is transmitted.

TABLE 3-8. GIN MODE CHARACTER SEQUENCE

BYTE	ITEM	DATA (HEXADECIMAL)*
1	Keyboard key	KB character code
2	High bits of X coordinate	5 MSB X + 20 ₁₆
3	Low bits of X coordinate	5 LSB X + 20 ₁₆
4	High bits of Y coordinate	5 MSB Y + 20 ₁₆
5	Low bits of Y coordinate	5 LSB Y + 20 ₁₆
6	CR	0D ₁₆

*MSB and LSB in this column are most significant bits and least significant bits, respectively.

- ESC ENQ - This sequence causes the GIN mode cursor position to be transmitted to the host system. Refer to table 3-1.

CONTROL CODES AND ESCAPE SEQUENCES FOR GRAPHICS OPERATION

Table 3-9 lists the ASCII control codes used for graphics operation, and their effect when used with or without escape sequences.

TABLE 3-9. GRAPHICS OPERATION CONTROL CODES

ASCII CHAR.	HEX. CODE	KEY-STROKES	EFFECT WITH ESC CONDITION CLEARED*	EFFECT WITH ESC CONDITION SET*
NUL	00	CTRL @	No effect.	Leaves ESC condition set.
SOH	01	CTRL a	No effect.	Selects graphics operation.
STX	02	CTRL b	No effect.	No effect. (Reserved.)
ETX	03	CTRL c	No effect.	Selects CYBER mode operation.
EOT	04	CTRL d	No effect.	No effect.
ENQ	05	CTRL e	No effect.	<p><u>Alpha mode</u> - Causes terminal to transmit status and alpha cursor position, and does not change display bypass.</p> <p><u>GIN mode</u> - Causes terminal to transmit GIN cursor position, selects Alpha mode, and does not change display bypass.</p> <p><u>Other modes</u> - Causes terminal to transmit status and X,Y position, and does not change display bypass.</p>
ACK	06	CTRL f	No effect.	No effect.
BEL	07	CTRL g	<p><u>Graph mode</u> - Following GS, causes the first vector to be written, clears display bypass, and sounds audible alarm.</p> <p><u>Other modes</u> - Clears display bypass and sounds audible alarm.</p>	<p><u>Graph mode</u> - Following GS, causes the first vector to be written, clears display bypass, and sounds audible alarm.</p> <p><u>Other modes</u> - Clears display bypass and sounds audible alarm.</p>

TABLE 3-9. GRAPHICS OPERATION CONTROL CODES (CONTD)

ASCII CHAR.	HEX. CODE	KEY-STROKES	EFFECT WITH ESC CONDITION CLEARED*	EFFECT WITH ESC CONDITION SET*
BS	08	ERASE or CTRL h or ← or ←	Moves cursor one position to the left and clears display bypass. If at margin position on a line, cursor moves to rightmost position on line above. If at margin position of topmost line, cursor moves to last position of top line. ERASE or ← additionally erases character if off-line or half duplex is selected.	Moves cursor one position to the left and clears display bypass. If at margin position on a line, cursor moves to margin position on line above. If at margin position of topmost line, cursor moves to last position of top line. ERASE or ← additionally erases character if off-line or half duplex is selected.
HT	09	→ or CTRL i	Moves cursor one position to the right and clears display bypass. If at rightmost position on a line, cursor moves to margin position on next lower line. If at last position of bottom line, cursor moves to new margin position on top line.	Moves cursor one position to the right and clears display bypass. If at margin position on a line, cursor moves to margin position on next lower line. If at last position of bottom line, cursor moves to new margin position on top line.
LF	0A	LF or CTRL j	Moves cursor down one line and clears display bypass. If at bottom line, cursor moves to top line. No effect if not in Alpha mode. May cause page-full condition to occur.	No effect. Leaves ESC condition set.
VT	0B	CTRL k	Moves cursor up one line and clears display bypass. If at top line, cursor does not move.	Moves cursor up one line and clears display bypass. If at top line, cursor does not move.

TABLE 3-9. GRAPHICS OPERATION CONTROL CODES (CONTD)

ASCII CHAR.	HEX. CODE	KEY-STROKES	EFFECT WITH ESC CONDITION CLEARED*	EFFECT WITH ESC CONDITION SET*
FF	OC	CTRL l	No effect.	Clears screen, selects Alpha mode, moves position to upper left corner of display, and clears display bypass.
CR	OD	NEXT or CTRL m or CR	Moves cursor to margin position of current line, resets terminal to Alpha mode, and clears display bypass.	Leaves ESC condition set.
SO	OE	CTRL n	No effect.	No effect.
SI	OF	CTRL o	No effect.	No effect.
DLE	10	CTRL p	No effect.	No effect.
DC1	11	CTRL q	No effect.	<u>Alpha mode</u> - Selects inverse video write. <u>Other modes</u> - Selects erase.
DC2	12	CTRL r	No effect.	<u>Alpha mode</u> - Selects overstrike write. <u>Other modes</u> - Selects write.
DC3	13	CTRL s	No effect.	<u>Alpha mode</u> - Selects overstrike erase. <u>Other modes</u> - Selects erase.
DC4	14	CTRL t	No effect.	<u>Alpha mode</u> - Selects clear write. <u>Other modes</u> - Selects write.
NAK	15	CTRL u	No effect.	No effect.
SYN	16	CTRL v	No effect.	No effect.
ETB	17	CTRL w	No effect.	Make screen copy.

TABLE 3-9. GRAPHICS OPERATION CONTROL CODES (CONTD)

ASCII CHAR.	HEX. CODE	KEY-STROKES	EFFECT WITH ESC CONDITION CLEARED*	EFFECT WITH ESC CONDITION SET*
CAN	18	CTRL x	No effect.	Sets display bypass.
EM	18	CTRL y	Selects Block mode and clears display bypass.	Undefined.
SUB	1A	CTRL z	No effect.	Selects GIN mode and sets display bypass.
ESC	1B	ESC	Sets ESC condition (beginning of an ESC sequence).	Leaves ESC condition set.
FS	1C	CTRL \	Selects Point Plot mode and clears display bypass.	Selects Special Point Plot mode and clears display bypass.
GS	1D	CTRL]	Selects Graph mode and clears display bypass.	Selects Graph mode and clears display bypass.
RS	1E	CTRL =	Selects Incremental Plot mode and clears display bypass.	Undefined.
US	1F	CTRL _	GIN mode - No effect. <u>Other modes</u> - Selects Alpha mode and clears display bypass.	GIN mode - No effect. <u>Other modes</u> - Selects Alpha mode and clears display bypass.
!	21	!	**	No effect if graphics tablet is deselected (character following ! is discarded). Character following ! is used for tablet control if tablet is selected.
7	37	7	**	Selects size 0 alpha characters (largest).
8	38	8	**	Selects size 1 alpha characters.
9	39	9	**	Selects size 2 alpha characters.

TABLE 3-9. GRAPHICS OPERATION CONTROL CODES (CONTD)

ASCII CHAR.	HEX. CODE	KEY-STROKES	EFFECT WITH ESC CONDITION CLEARED*	EFFECT WITH ESC CONDITION SET*
:	3A	:	**	Selects size 3 alpha characters.
;	3B	;	**	Selects size 4 alpha characters (smallest).
<	3C	<	**	Selects scaled coordinates with Y bias.
=	3D	=	**	Selects scaled coordinates without Y bias.
>	3E	>	**	Selects unscaled coordinates.
[5B	[**	Selects X-ON/X-OFF flow control.
]	5D]	**	Deselects X-ON/X-OFF flow control.
_	5F	_	**	Character after _ controls: A. Selects tablet continuously active B. Allows tablet arming via ESC ! X (refer to Graphics Tablet Operation States). C. Deselects tablet. D. Causes transmission of graphics firmware revision to host system.
	60		**	Selects solid vectors.
a	61	a	**	Selects dotted vectors.
b	62	b	**	Selects dot-dashed vectors.
c	63	c	**	Selects short-dashed vectors.
d	64	d	**	Selects long-dashed vectors.

TABLE 3-9. GRAPHICS OPERATION CONTROL CODES (CONTD)

ASCII CHAR.	HEX. CODE	KEY-STROKES	EFFECT WITH ESC CONDITION CLEARED*	EFFECT WITH ESC CONDITION SET*
h	68	h	**	Selects solid vectors.***
i	69	i	**	Selects dotted vectors.***
j	6A	j	**	Selects dot-dashed vectors.***
k	6B	k	**	Selects short-dashed vectors.***
l	6C	l	**	Selects long-dashed vectors.***
p	70	p	**	Selects solid vectors.***
q	71	q	**	Selects dotted vectors.***
r	72	r	**	Selects dot-dashed vectors.***
s	73	s	**	Selects short-dashed vectors.***
t	74	t	**	Selects long-dashed vectors.***
All Others	--		**	No effect.

*ESC condition is initiated by reception of an ESC character and terminates following reception of the following character, unless otherwise shown.

**The code is a displayable character in Alpha Mode, or part of a coordinate in Point-Plot, Special Point-Plot, Graph, and Block modes.

***Provided only for compatibility with Tektronix 401X terminals. Do not use for new applications.

PRINT OPTIONS

The CDC 721-30/31 terminal with the enhanced graphics firmware option supports the CDC 726-10 parallel graphic matrix printer and the CDC 726-20 serial graphic printer. Printing may be done in Screen Copy mode or in a Communications Print mode (both print modes can be active at the same time, with screen copy overriding communications printing).

The selected baud rate, number of data bits, and parity of terminal printer port and serial graphics printer must match. The serial graphics printer must be set to X-ON/X-OFF flow control, and printer error status must be set to DTR.

SCREEN COPY MODE

In Screen Copy mode the printer prints a dot-for-dot reproduction of information on the terminal display screen. The screen-print firmware is available for use at any time during graphics operation.

Screen Copy Printing

Printer operation is enabled by pressing the PRINT switch on the printer, which lights the PRINT switch indicator. Pressing the PRINT key on the terminal keyboard creates a screen copy. When the copy completes, the printer ejects paper to the next top-of-form and is ready to make another copy.

In graphics operation, the host system may initiate the screen copy by sending an ESC ETB escape sequence to the terminal. Operation of the screen copy is the same as if the operator had started the operation from the keyboard. The ESC ENQ escape sequence can be used to determine when the screen copy has completed.

All keyboard keys except the STOP and M REL keys are ignored while a screen copy is in process. The graphics tablet is also ignored. Host system communications are received within the input buffer limits (refer to Buffer Control in section 2), but are not processed until the screen copy operation completes.

Stopping Screen Copy Printing Early

Printing of the screen copy may be aborted by pressing the STOP key. The printer ejects paper to the next top-of-form and no signal is transmitted to the host system.

Printer Errors in Screen Copy Mode

Certain printer error conditions may occur during a screen copy operation. When an error occurs, one of the following error messages flashes in the lower right area of the display screen.

Parallel Printer

- DESEL - The printer is disabled or off-line, evidenced by the unlit PRINT switch indicator on the printer.
- PAPER - The printer is out of paper, loading paper improperly, or the platen yoke is not closed. The operator must reload paper or close the platen yoke, and press the FEED switch on the printer to stop the flashing display.
- REJECT - A hardware error condition exists.

Error recovery is accomplished by correcting the error or by pressing the STOP key. Both responses terminate the screen copy and the error message. While an error message is present, no signal transmits to the communications line, and all other keyboard keys except STOP and M REL are disabled. However, the graphics tablet is still active (if so selected) and can transmit data on the communications line.

Serial Printer

- DESEL - The printer is disabled or off-line, evidenced by the unlit select indicator. This error can be caused either by leaving the forms lever in the LOAD position or by the printer being uncabled from the serial port. Recovery from this error is done by correcting the error condition at the printer and reselecting it. If desired, the screen copy can be terminated by pressing the STOP key.

- PAPER - The printer is out of paper. The screen copy will terminate upon reloading the paper and reselecting the printer, or by pressing the STOP key.
- REJECT - A printer-receive error condition exists. The screen copy will terminate upon reselecting the printer, or by pressing the STOP key.

When the screen copy is terminated, any error message display also terminates, but no signal transmits to the communications line.

Duty Cycle Protection (Parallel Printer Only)

A gradual-slowdown algorithm built into the screen copy controlware keeps the printer duty cycle low enough to protect the printer. This algorithm maintains a running average of the screen copy density by tracking and combining a separate average for each printer solenoid. If the running average is too high, printer speed is reduced.

Screen Copy Performance

Parallel Printer - The nominal screen copy time is 30 to 40 seconds. High-density (dark) images on paper may cause the printer to reduce its rated speed from 30 to 50 percent, which prevents printer solenoid overheating. The maximum screen copy time for the darkest image is 120 seconds. The fastest possible screen copy time is 4 seconds.

Screen copy time for the parallel printer depends on the number of horizontal screen rows that have dots turned on. If a row has one or more dots turned on, that row will be printed in 65 milliseconds. If a row has no dots turned on, that row will be printed in 4 milliseconds. These times are reduced if the duty cycle algorithm has reduced printer speed.

Serial Printer - The nominal screen copy time is 45 seconds (bidirectional) or 60 seconds (unidirectional). The maximum print time is about 135 seconds (bidirectional) or 165 seconds (unidirectional). The fastest possible screen copy time is about 5 seconds. Generally on a screen copy, the terminal will be ready for input about 5 seconds before the printer is finished. These times assume the printer interface is operating at 9600 baud or higher.

Screen copy time for the serial printer is proportional to the percentage of dots turned on, and the number of consecutive horizontal dots.

COMMUNICATIONS PRINT MODE

In Communications Print mode, the printer prints alphanumeric data as it is received from the communications line. While being printed, the alphanumeric data is also displayed on the terminal display screen.

Select Communications Print Mode

Communications Print mode is selected by pressing the F3 function key while the operator parameter line is displayed (refer to Setting Operator Parameters in section 2).

While Communications Print mode is active, ASCII characters received from the communications line (and also those generated from the keyboard with half-duplex communications) transmit to the printer (parallel or serial) for printing and to the terminal for display.

The parallel printer prints an entire line of characters at a time, rather than one character at a time. Therefore, no character appears until the parallel printer receives a CR or LF character. Once a line of characters is printed, the parallel printer advances to the next line. Overstrike printing of characters is not possible. A printer switch setting selects line printing at 6 or 8 lines per inch.

Disabling the parallel printer while unprinted characters are in the printer buffer can only occur if the printer FEED and PRINT pushbutton switches are simultaneously pressed. This forces the parallel printer to print the remaining characters in its buffer and enables the deselection.

Deselect Communications Print Mode

Communications Print mode is deselected by pressing the F3 function key while the operator parameter line is displayed and no errors are present (refer to Initiating Graphics Operation in appendix B). Terminal operation may then proceed as if no printer were present.

If a printer error condition is present, Communications Print mode may be terminated by pressing the STOP key. Refer to the following paragraphs for more information.

Printer Errors in Communications Print Mode

Printer errors in Communications Print mode are identical to those in Screen Copy mode (refer to Printer Errors in Screen Copy Mode earlier in this section). However, printer error recovery in Communications Print mode differs slightly (refer to following paragraphs).

Printer Error Recovery in Communications Print Mode

Recovery from printer error conditions in Communications Print mode occurs as follows.

Parallel Printer

- DESEL - Error recovery is accomplished by pressing the PRINT switch to light the indicator. Sometimes it may be necessary to press the PRINT and FEED switch simultaneously before the PRINT indicator will light.
- PAPER - Error recovery is accomplished by reloading the paper or closing the platen yoke, and pressing the FEED switch on the printer to stop the flashing display.
- REJECT - Error recovery may be attempted by toggling printer power off and back on and pressing the PRINT switch.

Serial Printer

- DESEL - Error recovery is accomplished by correcting the error condition at the printer and then reselecting it.
- PAPER - Error recovery is accomplished by reloading paper and reselecting the printer.
- REJECT - Error recovery may be attempted by reselecting the printer.

Correcting the error terminates the flashing error message on the display screen, and communications printing resumes.

Pressing the STOP key terminates both Communications Print mode and the flashing error message. No signal transmits to the communications line, and all other keyboard keys operate normally.

COMMUNICATIONS PRINT PERFORMANCE

The maximum parallel printer communications print rate is 115 lines per minute, regardless of the number of printable characters on a line. Hence, the parallel printer should be able to keep up with a 1200-baud transfer rate if there are at least 65 characters per line. It should be able to keep up with a 300-baud transfer rate if there are at least 16 characters per line. This limitation is due to the parallel printer and not the graphics firmware. Loss of data may be avoided for communications rates up through 4800 baud if the host system is subject to X-ON/X-OFF flow control described in section 2.

The maximum serial printer communications print rate is 200 characters per second, which does not include time for printer head turnaround and line feeding.

GRAPHICS TABLET OPERATION

Graphics data may be entered using a graphics tablet. The graphics tablet stylus can be used to position a crosshair cursor on the terminal screen and to send the crosshair cursor position to the host system.

CONNECTION TO THE GRAPHICS TABLET

The graphics tablet connects to the terminal's serial port A or B as shown in figure 1-2. (The 721-200 Dual Serial Port Option must be installed in the terminal.)

The tablet's data rate can be up to 19 200 baud asynchronous with continuous transmission to the terminal whenever the stylus tip is in close proximity to the tablet. Slower data rates may be selected if desired. Data rate selection on the terminal is done with the port A or B terminal installation parameter. This parameter must match the rate selected on the tablet (refer to appendix E). Refer to appendix B for information regarding terminal installation parameters. The port to which the graphics tablet is connected must be designated as a bidirectional port when setting terminal installation parameters.

GRAPHICS TABLET CURSOR CONTROL

A crosshair cursor appears on the screen when the graphics tablet stylus tip is in close proximity to the graphics tablet surface. The cursor follows the stylus movements as long as the stylus tip is near the tablet surface.

The graphics tablet cursor overrides operation of the Alpha mode and GIN mode cursors. These cursors are restored when the graphics tablet cursor disappears.

Host system output may override the graphics tablet cursor at any time without loss of position; that is, host system output to the terminal may occur whether or not the tablet cursor is active.

TRANSMISSION OF GRAPHICS TABLET CURSOR POSITION TO THE HOST SYSTEM

The X,Y position of the graphics tablet cursor on the display screen may be transmitted to the host system by pressing the tablet stylus so that the switch in the stylus is activated. Activating the stylus switch sends the package of data to the host system as shown in table 4-1 (10-bit coordinates) or table 4-2 (12-bit coordinates), and occurs regardless of the data mode active in the terminal.

TABLE 4-1. GRAPHICS TABLET CURSOR POSITION FORMAT FOR 10-BIT COORDINATES

BYTE	ITEM	DATA*
1	GS	1D ₁₆
2	High bits of Y coordinate	5 MSB Y + 20 ₁₆
3	Low bits of Y coordinate	5 LSB Y + 20 ₁₆
4	High bits of X coordinate	5 MSB X + 20 ₁₆
5	Low bits of X coordinate	5 LSB X + 20 ₁₆
6	CR	0D ₁₆

*MSB and LSB are most significant bits and least significant bits, respectively.

TABLE 4-2. GRAPHICS TABLET CURSOR POSITION FORMAT FOR 12-BIT COORDINATES

BYTE	ITEM	DATA*
1	GS	1D ₁₆
2	High bits of Y coordinate	5 MSB Y + 20 ₁₆
3	Extra byte	**
4	Low bits of Y coordinate	5 LSB Y + 20 ₁₆
5	High bits of X coordinate	5 MSB X + 20 ₁₆
6	Low bits of X coordinate	5 LSB X + 20 ₁₆
7	CR	0D ₁₆

*MSB and LSB are most significant bits and least significant bits, respectively.

**Bit 0 = X₀; bit 1 = X₁; bit 2 = Y₀; bit 3 = Y₁; bit 4 = 1 if margin 2 is set active, 0 if margin 1 is set active; bit 5 = 1; bit 6 = 0, and bit 7 = parity bit.

The X and Y coordinates represent the screen coordinates of the tablet cursor (scaled or unscaled). Each byte may contain a parity bit.

When a graphics tablet cursor coordinate is sent to the host system, an audible alarm sounds and a dot is plotted at the cursor position as feedback to the operator. The dot is written (bright) or erased (dark) dependent on the currently selected write or erase escape sequence defined for Point Plot mode.

GRAPHICS TABLET ACTIVITY

Type-ahead inputs are enabled when the graphics tablet is selected and active.

If a printer screen copy operation is active, the tablet crosshair and terminal inputs from the graphics tablet are disabled.

NOTE

Data sent to the host system by the tablet should not be echoed back to the terminal by the host system (echoplex) or unpredictable results may occur. This may happen with full-duplex communications selected. The operator should not use the type-ahead capability of the tablet with full-duplex communications selected.

GRAPHICS TABLET OPERATION STATES

The graphics tablet has three states of operation: selected, under control of an arming sequence, or deselected. Initially the graphics tablet is selected and 10-bit coordinate transmission is specified. The three operation states may be chosen either via triple-character Alpha mode escape sequences, or the TABLET operator parameter. The triple character escape sequences override the TABLET parameter setting in actual operation.

Select Graphics Tablet

The graphics tablet is selected always active, either by receipt of the triple-character sequence ESC _ A or by setting the TABLET operator parameter to ON (refer to Setting Operator Parameters in section 2). In the former case, subsequent triple-character ESC ! X command sequences are honored, where X is a non-control code ASCII command with the following format:

	X Command Format - Select							
Bit	7	6	5	4	3	2	1	0
Data	P	C6	C5	C4	0	0	0	0

Where: C6 and C5 cannot simultaneously be zero or the host system will interpret a control code.

C4 = 0 causes 10-bit graphics tablet coordinates to transmit to the host system; C4 = 1 causes 12-bit graphics tablet coordinates to transmit to the host system.

P is a parity bit.

Graphics Tablet Under Arming Sequence Control

Arming the graphics tablet allows it to transmit coordinates to the host system either a single point at a time or in a continuous stream (drawing a line). When disarmed, the graphics tablet is disabled; the tablet cursor does not appear and no tablet data can be sent to the host system.

The graphics tablet is set active under arming sequence control either by receipt of the ESC _ B sequence or by having the TABLET operator parameter set to CTRL (refer to Setting Operator Parameters in section 2).

Subsequent triple-character ESC ! X command sequences are honored, where X is a non-control code ASCII command with the following format:

X Command Format - Arming Control								
Bit	7	6	5	4	3	2	1	0
Data	P	C6	C5	C4	C3	C2	C1	0

Where: If C3 = 1 and C1 = 0, the graphics tablet is disarmed (disabled).

If C3 = 0 and C1 = 0, the graphics tablet is armed to send a single tablet coordinate to the host system each time the stylus is pressed. The tablet is disarmed after each coordinate transmission, and must be re-armed with another ESC ! X command before the stylus can be used to send another tablet coordinate to the host system.

If C1 = 1, the graphics tablet is armed to send multiple tablet coordinates as long as the stylus tip is depressed (as in drawing a continuous line). With the stylus tip depressed, coordinate transmission continues as desired until a command is received to disarm the tablet or change graphics operation modes. C2 = 1 sends approximately 15 coordinates per second while the stylus is pressed (no alarm occurs while C2 = 1). If C2 = 0, only one coordinate will be sent each time the stylus is pressed.

C4 = 0 causes 10-bit graphics tablet coordinates to transmit to the host system; C4 = 1 causes 12-bit coordinates to transmit to the host system.

C6 and C5 cannot simultaneously be zero or the host system will interpret a control code.

P is a parity bit.

Deselect Graphics Tablet

The graphics tablet is deselected either by receipt of the ESC _ C sequence or by having the TABLET operator parameter set to OFF. The tablet is disabled; the tablet cursor does not appear and no tablet data can be sent to the host system.



The Graph, Point Plot, Special Point Plot, and Block modes require sets of coordinates to be transmitted to the terminal from the host system. Coordinate precision may be represented by 10 or 12 bits (refer to Graphics Display Orientation in section 2). To transmit this data, the host system first sends a control code to the terminal to indicate the next data transmitted will be coordinate data. The specific control codes are GS, FS, FS-intensity control character, and EM for Graph, Point Plot, Special Point Plot, and Block mode, respectively.

Ten data bits are required to describe each X or Y coordinate ranging from 0 through 1023, so a coordinate position is completely described by 20 bits. Twelve data bits are required to describe each X or Y coordinate ranging from 0 through 4095, so a coordinate position is completely described by 24 bits. The 4 extra bits of precision with a set of 12-bit coordinates represent an "extra byte" which is sent from the host system to the terminal.

Because ASCII data transmits in 7-bit packets (one byte), two bytes are used to describe each X or Y coordinate. The 10 coordinate bits are divided into the 5 most significant bits (high byte) and the 5 least significant bits (low byte). An X,Y position therefore has two high bytes and two low bytes. The remaining 2 bits in each byte identify one of these four bytes: high X, low X, high Y, and low Y.

For 10-bit coordinates, the bits identifying the four bytes, plus the location of the most and least significant coordinate bits within the bytes, are shown in table 5-1.

For 12-bit coordinates, the bits identifying the four bytes and the extra byte, plus the location of the most and the least significant coordinate bits within the bytes, are shown in table 5-2.

TABLE 5-1. COORDINATE POSITION BIT ASSIGNMENTS -
10-BIT COORDINATES

BYTE	BIT 6	BIT 5	BITS 4 THROUGH 0*
High Y	0	1	5 MSB of Y coordinate**
Low Y	1	1	5 LSB of Y coordinate
High X	0	1	5 MSB of X coordinate**
Low X	1	0	5 LSB of X coordinate

*MSB and LSB in this column are most significant bits and least significant bits, respectively.

**Since the 721-30/31 terminal resolution is 512 by 512, the MSB (bit 10) of each coordinate (when unscaled) is outside the screen display area. Unscaled coordinates exceeding 511 produce unpredictable results. If coordinate scaling is selected, all X and Y coordinates are reduced by a factor of 2, allowing coordinates up to 1023. If Y bias is selected, the Y coordinate is biased upward 122 positions.

TABLE 5-2. COORDINATE POSITION BIT ASSIGNMENTS -
12-BIT COORDINATES

BYTE	BIT 6	BIT 5	BITS 4 THROUGH 0*
High Y	0	1	Y11 through Y7
Extra	1	1	**
Low Y	1	1	Y6 through Y5
High X	0	1	X11 through X7
Low X	1	0	X6 through X2

*MSB and LSB in this column are most significant bits and least significant bits, respectively. If coordinate scaling is selected, all X and Y coordinates are reduced by a factor of 8, allowing coordinates up to 4095. If Y bias is selected, the Y coordinate is biased upward 122 positions.

**The format for bits 4 through 0 of the extra byte is: bit 5 = 1 sets margin 2 active, bit 5 = 0 sets margin 1 only active; bit 4 = Y1; bit 3 = Y0; bit 2 = X1, and bit 1 = X0.

NOTE

Transmissions of coordinate data from the host system to the terminal, and transmissions of graphics tablet coordinate data from the terminal to the host system, are in the order of high Y, low Y, high X, and low X. All other transmissions of coordinate data from the terminal to the host system are in the order of high X, low X, high Y, and low Y (this includes GIN mode entries and responses to host system enquiries).

The terminal retains the last high Y, extra byte, low Y, and high X addresses when switched to other operations not requiring coordinate information. When returning to an operation requiring coordinate information, the terminal must receive only low X to reset the previous coordinates.

It is not necessary that all four ASCII characters describing a 10-bit coordinate, or all five ASCII characters describing a 12-bit coordinate, be transmitted to the terminal from the host system. The following rules apply:

1. If the high Y byte changes, the high Y byte must be received by the terminal.
2. If the extra byte changes, both the extra byte and the low Y byte must be received by the terminal.
3. If the low Y byte changes, the low Y byte must be received by the terminal.
4. If the high X byte changes, both the low Y byte and the high X byte must be received by the terminal.
5. The low X byte must always be received, whether or not it changes.

Table 5-3 shows the coordinate byte transmission requirements.

TABLE 5-3. COORDINATE BYTE TRANSMISSION REQUIREMENTS

BYTES THAT CHANGE				BYTE TRANSMISSION REQUIRED			
HIGH Y	LOW Y	HIGH X	LOW X	HIGH Y	LOW Y	HIGH X	LOW X
			*				*
		*			*	*	*
		*	*		*	*	*
	*				*		*
	*		*		*		*
	*	*			*	*	*
	*	*	*		*	*	*
*				*			*
*			*	*			*
*		*		*	*	*	*
*		*	*	*	*	*	*
*	*			*	*		*
*	*		*	*	*		*
*	*	*		*	*	*	*
*	*	*	*	*	*	*	*
Sending to Initial Coordinate				*	*	*	*
Returning to Remembered Coordinate							*

Table 5-4 shows the conversion of 10-bit X and Y coordinates to hexadecimal, decimal, and ASCII codes.

To use the table, first locate the X or Y coordinate value, then follow the column that value is in to the bottom of the chart to find the hexadecimal value, decimal value, or ASCII character representing the high Y or high X byte. Then, returning to the X or Y coordinate value, follow the row that value is in to find the low Y byte right of the chart or low X byte (left of the chart). For example, the Y,X position (200,48) corresponds to the hexadecimal value of 26 68 21 50, the ASCII value of & h ! P, and the decimal value of 38 104 33 80.

TABLE 5-4. TEN-BIT COORDINATE CONVERSION (ASCII OPERATIONS)
(SHEET 1 OF 4)

LOW ORDER X			X OR Y COORDINATE								LOW ORDER Y		
ASCII	DEC.	HEX.									HEX.	DEC.	ASCII
@	64	40	0	32	64	96	128	160	192	224	60	96	`
A	65	41	1	33	65	97	129	161	193	225	61	97	a
B	66	42	2	34	66	98	130	162	194	226	62	98	b
C	67	43	3	35	67	99	131	163	195	227	63	99	c
D	68	44	4	36	68	100	132	164	196	228	64	100	d
E	69	45	5	37	69	101	133	165	197	229	65	101	e
F	70	46	6	38	70	102	134	166	198	230	66	102	f
G	71	47	7	39	71	103	135	167	199	231	67	103	g
H	72	48	8	40	72	104	136	168	200	232	68	104	h
I	73	49	9	41	73	105	137	169	201	233	69	105	i
J	74	4A	10	42	74	106	138	170	202	234	6A	106	j
K	75	4B	11	43	75	107	139	171	203	235	6B	107	k
L	76	4C	12	44	76	108	140	172	204	236	6C	108	l
M	77	4D	13	45	77	109	141	173	205	237	6D	109	m
N	78	4E	14	46	78	110	142	174	206	238	6E	110	n
O	79	4F	15	47	79	111	143	175	207	239	6F	111	o
P	80	50	16	48	80	112	144	176	208	240	70	112	p
Q	81	51	17	49	81	113	145	177	209	241	71	113	q
R	82	52	18	50	82	114	146	178	210	242	72	114	r
S	83	53	19	51	83	115	147	179	211	243	73	115	s
T	84	54	20	52	84	116	148	180	212	244	74	116	t
U	85	55	21	53	85	117	149	181	213	245	75	117	u
V	86	56	22	54	86	118	150	182	214	246	76	118	v
W	87	57	23	55	87	119	151	183	215	247	77	119	w
X	88	58	24	56	88	120	152	184	216	248	78	120	x
Y	89	59	25	57	89	121	153	185	217	249	79	121	y
Z	90	5A	26	58	90	122	154	186	218	250	7A	122	z
[91	5B	27	59	91	123	155	187	219	251	7B	123	{
\	92	5C	28	60	92	124	156	188	220	252	7C	124	
]	93	5D	29	61	93	125	157	189	221	253	7D	125	}
^	94	5E	30	62	94	126	158	190	222	254	7E	126	~
_	95	5F	31	63	95	127	159	191	223	255	7F	127	DEL
Hexadecimal			20	21	22	23	24	25	26	27			
Decimal			32	33	34	35	36	37	38	39			
ASCII			SP	!	"	#	\$	%	&	'			
High Order X and Y Byte Values													

TABLE 5-4. TEN-BIT COORDINATE CONVERSION (ASCII OPERATIONS)
(SHEET 2 OF 4)

LOW ORDER X			X OR Y COORDINATE									LOW ORDER Y		
ASCII	DEC.	HEX.										HEX.	DEC.	ASCII
@	64	40	256	288	320	352	384	416	448	480	60	96	\	
A	65	41	257	289	321	353	385	417	449	481	61	97	a	
B	66	42	258	290	322	354	386	418	450	482	62	98	b	
C	67	43	259	291	323	355	387	419	451	483	63	99	c	
D	68	44	260	292	324	356	388	420	452	484	64	100	d	
E	69	45	261	293	325	357	389	421	453	485	65	101	e	
F	70	46	262	294	326	358	390	422	454	486	66	102	f	
G	71	47	263	295	327	359	391	423	455	487	67	103	g	
H	72	48	264	296	328	360	392	424	456	488	68	104	h	
I	73	49	265	297	329	361	393	425	457	489	69	105	i	
J	74	4A	266	298	330	362	394	426	458	490	6A	106	j	
K	75	4B	267	299	331	363	395	427	459	491	6B	107	k	
L	76	4C	268	300	332	364	396	428	460	492	6C	108	l	
M	77	4D	269	301	333	365	397	429	461	493	6D	109	m	
N	78	4E	270	302	334	366	398	430	462	494	6E	110	n	
O	79	4F	271	303	335	367	399	431	463	495	6F	111	o	
P	80	50	272	304	336	368	400	432	464	496	70	112	p	
Q	81	51	273	305	337	369	401	433	465	497	71	113	q	
R	82	52	274	306	338	370	402	434	466	498	72	114	r	
S	83	53	275	307	339	371	403	435	467	499	73	115	s	
T	84	54	276	308	340	372	404	436	468	500	74	116	t	
U	85	55	277	309	341	373	405	437	469	501	75	117	u	
V	86	56	278	310	342	374	406	438	470	502	76	118	v	
W	87	57	279	311	343	375	407	439	471	503	77	119	w	
X	88	58	280	312	344	376	408	440	472	504	78	120	x	
Y	89	59	281	313	345	377	409	441	473	505	79	121	y	
Z	90	5A	282	314	346	378	410	442	474	506	7A	122	z	
[91	5B	283	315	347	379	411	443	475	507	7B	123	{	
\	92	5C	284	316	348	380	412	444	476	508	7C	124		
]	93	5D	285	317	349	381	413	445	477	509	7D	125	}	
^	94	5E	286	318	350	382	414	446	478	510	7E	126	~	
-	95	5F	287	319	351	383	415	447	479	511	7F	127	DEL	

Hexadecimal	28	29	2A	2B	2C	2D	2E	2F
Decimal	40	41	42	43	44	45	46	47
ASCII	()	*	+	,	-	.	/

High Order X and Y Byte Values

TABLE 5-4. TEN-BIT COORDINATE CONVERSION (ASCII OPERATIONS)
(SHEET 3 OF 4)

LOW ORDER X			X OR Y COORDINATE									LOW ORDER Y		
ASCII	DEC.	HEX.										HEX.	DEC.	ASCII
@	64	40	512	544	576	608	640	672	704	736	60	96	\	
A	65	41	513	545	577	609	641	673	705	737	61	97	a	
B	66	42	514	546	578	610	642	674	706	738	62	98	b	
C	67	43	515	547	579	611	643	675	707	739	63	99	c	
D	68	44	516	548	580	612	644	676	708	740	64	100	d	
E	69	45	517	549	581	613	645	677	709	741	65	101	e	
F	70	46	518	550	582	614	646	678	710	742	66	102	f	
G	71	47	519	551	583	615	647	679	711	743	67	103	g	
H	72	48	520	552	584	616	648	680	712	744	68	104	h	
I	73	49	521	553	585	617	649	681	713	745	69	105	i	
J	74	4A	522	554	586	618	650	682	714	746	6A	106	j	
K	75	4B	523	555	587	619	651	683	715	747	6B	107	k	
L	76	4C	524	556	588	620	652	684	716	748	6C	108	l	
M	77	4D	525	557	589	621	653	685	717	749	6D	109	m	
N	78	4E	526	558	590	622	654	686	718	750	6E	110	n	
O	79	4F	527	559	591	623	655	687	719	751	6F	111	o	
P	80	50	528	560	592	624	656	688	720	752	70	112	p	
Q	81	51	529	561	593	625	657	689	721	753	71	113	q	
R	82	52	530	562	594	626	658	690	722	754	72	114	r	
S	83	53	531	563	595	627	659	691	723	755	73	115	s	
T	84	54	532	564	596	628	660	692	724	756	74	116	t	
U	85	55	533	565	597	629	661	693	725	757	75	117	u	
V	86	56	534	566	598	630	662	694	726	758	76	118	v	
W	87	57	535	567	599	631	663	695	727	759	77	119	w	
X	88	58	536	568	600	632	664	696	728	760	78	120	x	
Y	89	59	537	569	601	633	665	697	729	761	79	121	y	
Z	90	5A	538	570	602	634	666	698	730	762	7A	122	z	
[91	5B	539	571	603	635	667	699	731	763	7B	123	{	
\	92	5C	540	572	604	636	668	700	732	764	7C	124		
]	93	5D	541	573	605	637	669	701	733	765	7D	125	}	
^	94	5E	542	574	606	638	670	702	734	766	7E	126	~	
_	95	5F	543	575	607	639	671	703	735	767	7F	127	DEL	

Hexadecimal	30	31	32	33	34	35	36	37
Decimal	48	49	50	51	52	53	54	55
ASCII	0	1	2	3	4	5	6	7

High Order X and Y Byte Values

TABLE 5-4. TEN-BIT COORDINATE CONVERSION (ASCII OPERATIONS)
(SHEET 3 OF 4)

LOW ORDER X			X OR Y COORDINATE								LOW ORDER Y		
ASCII	DEC.	HEX.									HEX.	DEC.	ASCII
@	64	40	768	800	832	864	896	928	960	992	60	96	`
A	65	41	769	801	833	865	897	929	961	993	61	97	a
B	66	42	770	802	834	866	898	930	962	994	62	98	b
C	67	43	771	803	835	867	899	931	963	995	63	99	c
D	68	44	772	804	836	868	900	932	964	996	64	100	d
E	69	45	773	805	837	869	901	933	965	997	65	101	e
F	70	46	774	806	838	870	902	934	966	998	66	102	f
G	71	47	775	807	839	871	903	935	967	999	67	103	g
H	72	48	776	808	840	872	904	936	968	1000	68	104	h
I	73	49	777	809	841	873	905	937	969	1001	69	105	i
J	74	4A	778	810	842	874	906	938	970	1002	6A	106	j
K	75	4B	779	811	843	875	907	939	971	1003	6B	107	k
L	76	4C	780	812	844	876	908	940	972	1004	6C	108	l
M	77	4D	781	813	845	877	909	941	973	1005	6D	109	m
N	78	4E	782	814	846	878	910	942	974	1006	6E	110	n
O	79	4F	783	815	847	879	911	943	975	1007	6F	111	o
P	80	50	784	816	848	880	912	944	976	1008	70	112	p
Q	81	51	785	817	849	881	913	945	977	1009	71	113	q
R	82	52	786	818	850	882	914	946	978	1010	72	114	r
S	83	53	787	819	851	883	915	947	979	1011	73	115	s
T	84	54	788	820	852	884	916	948	980	1012	74	116	t
U	85	55	789	821	853	885	917	949	981	1013	75	117	u
V	86	56	790	822	854	886	918	950	982	1014	76	118	v
W	87	57	791	823	855	887	919	951	983	1015	77	119	w
X	88	58	792	824	856	888	920	952	984	1016	78	120	x
Y	89	59	793	825	857	889	921	953	985	1017	79	121	y
Z	90	5A	794	826	858	890	922	954	986	1018	7A	122	z
[91	5B	795	827	859	891	923	955	987	1019	7B	123	{
\	92	5C	796	828	860	892	924	956	988	1020	7C	124	
]	93	5D	797	829	861	893	925	957	989	1021	7D	125	}
^	94	5E	798	830	862	894	926	958	990	1022	7E	126	~
-	95	5F	799	831	863	895	927	959	991	1023	7F	127	DEL

Hexadecimal	38	39	3A	3B	3C	3D	3E	3F
Decimal	56	57	58	59	60	61	62	63
ASCII	8	9	:	;	<	=	>	?

High Order X and Y Byte Values

Address	On the display screen, the coded representation of a specific point (position) defined by a horizontal coordinate (X) and a vertical coordinate (Y).
Address Conversion	Changing an address to a combination of characters that describe the address in hexadecimal, decimal, or ASCII form; also, the reverse operation.
Alpha Cursor	A nondestructive, blinking underline used in Alpha mode to show the next character writing position. The underline occupies the lowest dot positions of the character space.
ASCII Code	The seven-digit binary numbers that express any of the 128 ASCII characters.
Baud Rate	Data communications speed expressed in baud (bits per second).
Break	A signal sent from the terminal to the host system to interrupt computer transmission in some installations, or the command that initiates the signal.
Buffer	A storage device used to compensate for a difference in data flow rate when transmitting data from one device to another.
Bypass Condition	Refer to Display Bypass.
Clear	A command that erases a display, sets Alpha mode, and returns the alpha cursor to home position.
Control Character	The ASCII representation of hexadecimal codes which are used to control equipment operation.
Coordinate Conversion	The change of a horizontal (X) or vertical (Y) coordinate to a combination of characters in hexadecimal, decimal, or ASCII form; also the reverse operation.

Cursor	A position indicator displayed on the screen.
Dark Vector	Movement of screen position from one address to another (in Graph mode) without displaying the movement on the screen.
Data Set	Refer to Modem.
Display Bypass	A condition that inhibits the screen display of information transmitted to or from a host system. The condition automatically occurs when GIN mode is selected and can also be program-selected.
Display Memory	The area of random access memory (RAM) in which screen image data is stored.
Dot Matrix	A rectangular matrix used to represent points, lines, or characters.
Echoplex	The return of transmitted data to the transmitting device.
ESC (Escape Character)	A control character used to modify the meaning of one or more of the characters that follow it.
Escape Sequence	A sequence of characters beginning with an ESC control character. It is used to select functions, deselect previously selected functions, and enable a host system to obtain terminal status and cursor position.
Inverse Video	On the screen, dark images on a light background; the opposite of normal video, which has light images on a dark background.
Local Echo	Simulating echoing within the terminal so that the terminal executes the data it transmits without having it echoed by the receiving device. Used when half duplex is selected or terminal is in off-line operation.
Local Operation	Refer to Off-Line (Local) Operation.
Mode Parameters	Parameters stored in nonvolatile memory which identify certain conditions for each of six terminal modes.

Modem (Data Set)	Acronym for MOdulator DEModulation, a device that converts data from a form compatible with data-processing equipment to a form compatible with transmission facilities, and vice-versa.
Nondestructive	On the display screen, an image such as a cursor which, when written and then removed, does not alter the displayed image.
Nonvolatile Memory (NVM)	The memory that retains terminal and mode parameter settings when external power is off. A battery inside the terminal supplies the necessary power.
Numeric Keypad	The group of 13 keys, including mnemonic keys 0 through 9, at the right end of the keyboard.
Off-Line (Local) Operation	An operating status that isolates the terminal from the host system, and sets up a local echoplexing condition.
On-Line Operation	Interactive communication with a host system.
Pixel	The smallest picture element displayable on the screen. Also referred to as a dot.
Random Access Memory (RAM)	Memory that provides immediate access to storage location point in the memory.
Read-Only Memory (ROM)	Memory in which data is stored and accessed but which cannot be altered during operation.
RS-232-C	Standardized method for the uniform interfacing of data communication equipment and terminals.
Status Byte	Data bits that indicate the status of the terminal and certain peripherals.
Touchpanel	A pressure-sensitive screen overlay that detects when any of 256 areas of the screen are touched by the operator.
Unwritten Vector	Refer to Dark Vector.

Vector

Movement of screen position from one address to another (in Graph mode), with or without displaying the movement on the screen. (Refer to Written Vector or to Dark Vector.)

Written Vector

Movement of screen position from one address to another, which writes or erases a straight line between the two points.

The 721-301 Enhanced Graphics Firmware Option consists of controlware contained in a memory module to be installed in the 721-30/31 Graphics/PLATO Display Terminal.

This appendix focuses on:

- Installing the memory module
- Setting parameters
- Initiation procedure for use of graphics terminal
- Installation parameters summary

For more detailed terminal setup information, consult appendix A in the 721 Display Terminal Operator's Guide/Installation Instructions manual listed in the preface.

INSTALLING THE MEMORY MODULE

The following instructions for installing the memory module assume the terminal has been installed and is operational. Refer to figure B-1 and perform the following steps.

CAUTION

Never install or remove a memory module while terminal power is on. Doing so may damage the terminal and/or the memory module.

1. Press the terminal POWER switch to 0 (off) position.
2. Remove the memory module cover by unscrewing the screw that holds the cover in place. Use a medium-sized Phillips screwdriver.
3. Carefully insert the memory module (label side up) in exposed connector. The module must be firmly seated.
4. Reattach the memory module cover with the screw removed in step 2.

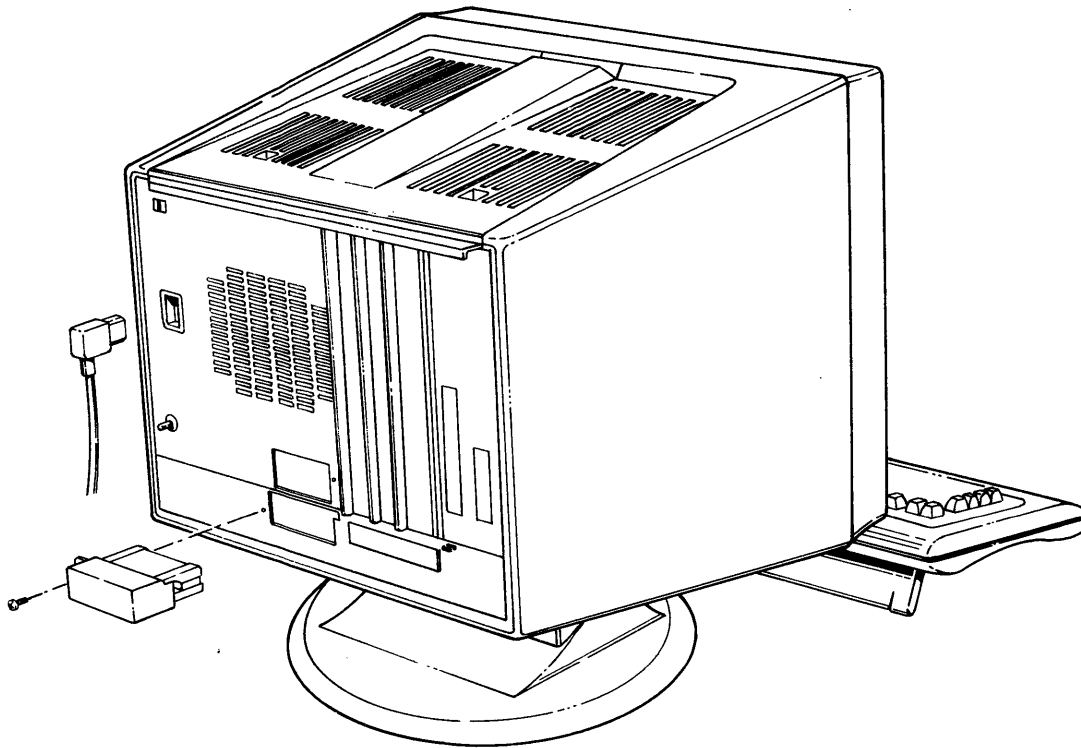

Figure B-1. Memory Module Insertion

SETTING PARAMETERS

The terminal can be configured with a variety of options. The parameter settings below offer some combinations that will allow the terminal to perform as an interactive graphics terminal on a CDC CYBER 170 Computer System at a communication speed of 1200, 4800, or 9600 baud. To select parameters other than those given below, refer to the 721 Display Terminal Operator's Guide/Installation Instructions manual listed in the preface.

1. Turn the BRIGHTNESS and CONTRAST knobs on front of terminal fully clockwise. This ensures visibility of the images that will be displayed when power is applied.
2. Apply power to the terminal and all related peripheral equipment. The terminal performs brief internal diagnostics tests and, if mode selections are unchanged from factory-set parameters, displays (figure B-2):

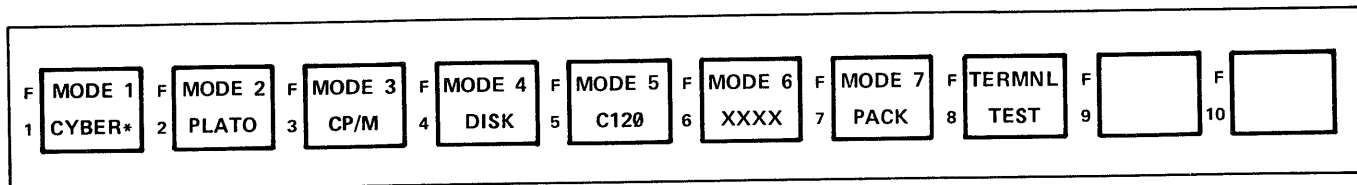

Figure B-2. Mode Select Menu

05077

NOTE

If the display in figure B-2 does not appear after the terminal has had ample time (1 minute) to warm up, the existing mode selection parameters are changed from the factory-set parameters. If the mode select menu does not appear, refer to the 721 Operator's Guide/Installation Instructions manual listed in the preface.

3. Adjust BRIGHTNESS and CONTRAST knobs for comfortable viewing.
4. While pressing the CTRL key, press the SETUP key. Parameters appear at bottom of screen, with a blinking cursor in the first character position of the F2 CONFIG box (figure B-3):

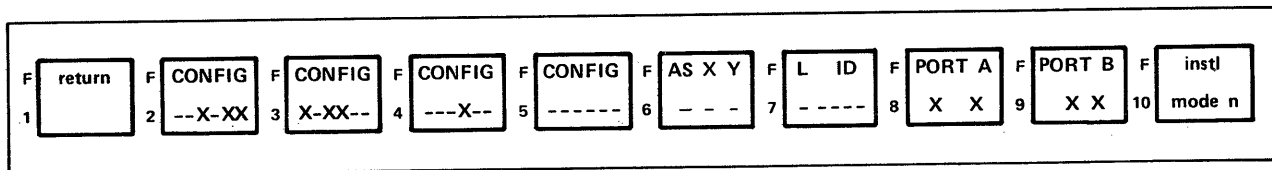

Figure B-3. Terminal Installation Parameters

05078

5. Set the terminal installation parameters F2, F3, F4, F8, and F9 boxes by referring to table B-1 and entering the desired settings on the lower line inside these boxes (refer to figure B-3). All settings indicated by a hyphen (-) within the boxes in figure B-3 do not apply to enhanced graphics firmware operation and should be left as they appear on the display screen. The cursor automatically advances from left to right as parameters are entered; pressing the space bar advances the cursor without affecting the settings.

TABLE B-1. TERMINAL INSTALLATION PARAMETER SETTINGS

CONFIG	SETTING	COMMENT
F2	3	Set to 1 if dual-serial interface option is installed; otherwise set to 0. (Option required to support serial printer and/or graphics tablet.)
	4	Set to 1 if parallel printer attached; otherwise set to 0.
	6	Set to 1 if serial printer attached to port A or B; otherwise set to 0.
F3	1	Set to 1 if 1200/1200 internal modem option is installed and being used; otherwise set to 0.
	3	Set to 1 (required to load enhanced graphics firmware from memory module); otherwise set to 0.
	4	Set to 1 if parallel port option is installed (required if parallel printer is used); otherwise set to 0.
F4	4	Set to 1 for pulse dialing with 1200/1200 internal modem; set to 0 for tone dialing with 1200/1200 internal modem.
F8 and F9	1	Set bit 3 to 1 (bidirectional) on port used with graphics tablet; set bit 3 to 0 (printer) on port used with serial printer. If both ports are set up as printer ports, port A will be the printer port and port B cannot be used. If both ports are set up as bidirectional ports, port B will be the graphics tablet port and port A cannot be used. (Bits 2, 1, and 0 should be set up to match the parity and word length of the connected device. For the graphics tablet, refer to appendix E. For further information, see the 721-X0 Enhanced Display Terminal Hardware Reference manual.)
	2	Set to match baud rate of connected device (refer to table B-2).

TABLE B-2. TRANSMIT/RECEIVE BAUD RATE SETTINGS

SETTING	BAUD RATE	SETTING	BAUD RATE
0	75	8	2400
1	110	9	4800
2	150	A	9600
3	200	B	19 200
4	300	C	19 200
5	600	D	19 200
6	1200	E	19 200
7	1800	F	19 200

6. Preserve terminal installation parameters by pressing the COPY key.
7. Enable entry of installation mode parameter settings by pressing the F10 function key. The display is as follows:

ENTER MODE n (1 - 6)
8. Select the standard graphics mode by entering a 6 (not F6). The operator can use 3, 4, or 5 to select a mode other than 6.

NOTE

Do not use mode 7; it is not intended for selection of graphics mode.

The display is as follows:

ENTER MODE NAME

9. Enter GRFX or any other name of four letters or less that suggests graphics. (This name will appear in the mode selection menu.) The terminal displays a set of mode installation parameters at the bottom of the screen (figure B-4), with the cursor in the first position of the F2 CONFIG box.

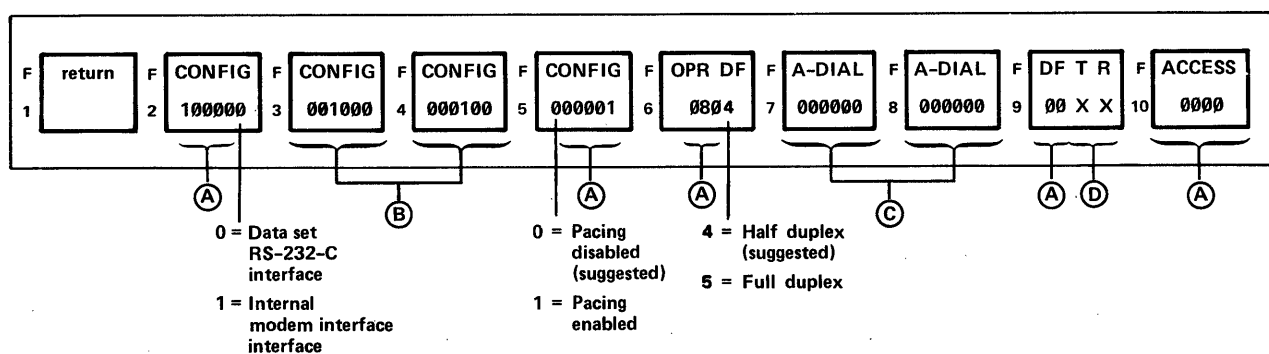

LEGEND

(A) ENTER SETTINGS SHOWN.

(B) REFER TO TABLE B-3.

(C) USED ONLY IF AUTO-DIAL IS SELECTED. UP TO 12 (TELEPHONE NUMBER) DIGITS CAN BE USED. IF LESS THAN 12 DIGITS ARE USED, THEY MUST BE LEFT-JUSTIFIED WITH THE LETTER F ENTERED FOR EACH OF THE REMAINING DIGITS.

(D) REFER TO TABLE B-2 TO SELECT BAUD RATE, WHICH MUST MATCH BAUD RATE USED BY HOST SYSTEM.

Figure B-4. Mode Installation Parameters

10. Set mode installation parameters as shown in figure B-4. (For more detailed parameter setting information refer to either the 721-X0 Display Terminal Hardware Reference Manual or the Enhanced 721-X0 Display Terminal Hardware Reference Manual listed in the preface.) The cursor automatically advances left to right upon entry of parameters.

TABLE B-3. F3 AND F4 MODE INSTALLATION PARAMETER SETTINGS

BIT	F3 PARAMETER SETTING		F4 PARAMETER SETTING	
	ZERO	ONE	ZERO	ONE
1	Dial once	Continuous dial	DTR constant or not applicable	DTR switched
2	Auto-dial off	Auto-dial on	RTS constant or not applicable	RTS switched
3	Host 7 bits (data)	Host 8 bits (data)	Key-repeating off*	Key-repeating on*
4	Host parity disable	Host parity enable	Honor modem control signals	Ignore modem control signals
5	Host parity odd	Host parity even	Must be zero	-
6	Host 1 stop bit	Host 2 stop bit	Carriage return	Carriage return plus line feed

*Typamatic operation only supported with enhanced 721 display terminal.

11. Preserve mode installation parameters by pressing the COPY key.

The terminal and mode parameters are stored in nonvolatile memory, which receives power from a battery when terminal power is off. If the battery fails or the stored parameter data is otherwise lost, parameters revert to factory-set values as detailed in either the 721-X0 Display Terminal Hardware Reference Manual or the Enhanced 721-X0 Display Terminal Hardware Reference Manual listed in the preface. Repeating steps 2 through 11 reloads the desired parameters. Replacing the battery with terminal power on prevents losing parameter data.

12. Return to Mode Select Menu display (figure B-2) by pressing the F1 function key. GRFX, or an alternative name chosen in step 9, appears under MODE 6 in the F6 parameter box (or in the parameter box corresponding to the alternative mode selected in step 8).

13. Load the firmware from the memory module by pressing the F6 key (or the function key corresponding to the alternative mode selected in step 8). When loading completes, the word Graphics is displayed followed by a revision level number.

INITIATING GRAPHICS OPERATION

Once the graphics firmware has been loaded, the terminal is ready to be used as an interactive graphics terminal. Before beginning, check the operating parameters as follows.

1. Display operator parameters by pressing the SETUP key. The settings shown in figure B-5 will appear (with baud rate as selected in step 10 of Setting Parameters earlier in this appendix). Pressing the F10 key (MORE SELECT) accesses the second line shown in figure B-5.

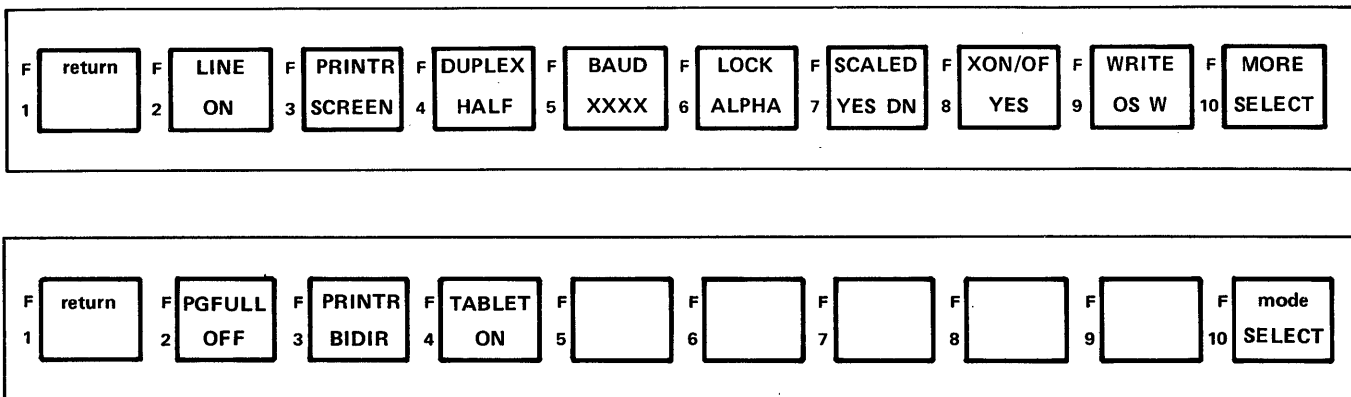

Figure B-5. Operator Parameters

05078

Settings may be changed by pressing the appropriate function keys.

2. Exit SETUP by pressing the F1 function key.
3. Clear the screen by pressing the key or the page clear (P/CLEAR/EOL) key.
4. Proceed with the terminal log-in procedure appropriate for the host computer system with which the terminal is to be used.

INSTALLATION PARAMETERS

The terminal and mode installation parameters that apply to the 721-301 Enhanced Graphics/Firmware Option are found in appendix A in the 721 Display Terminal Operator's Guide/Installation Instructions manual or the Enhanced 721 Display Terminal Operator's Guide/Installation Instructions manual.

NOTE

The enhanced graphics firmware option is supported by the 721-301 terminal at both the 3.0 and 4.0 revision levels. As such, the terminal and mode installation parameters may differ. Be sure to consult the appropriate Operator's Guide/Installation Instructions manual listed in the preface.



The 721-30/31 keyboard provides for operator entry of specific symbol and control codes that are displayed or transmitted. Terminal function keys are provided in addition to the alphanumeric and control code entry keys. The keyboard is capable of generating all 128 ASCII, ANSI-STD X3.4 codes. The keyboard incorporates N-key rollover, which ensures a response to every key pressed even if pressed simultaneously.

Pressing an alphanumeric symbol key or a control code key causes the code for that key to be transferred to the terminal control logic.

Figures C-1 and C-2 show the 721-30/31 keyboard layout and the numerical assignment of each keystation. Table C-1, Keyboard Legends and Codes, follows these figures as a reference. Tables C-2 and C-3 list the 128 ASCII character codes and the 33 ASCII control characters, respectively.

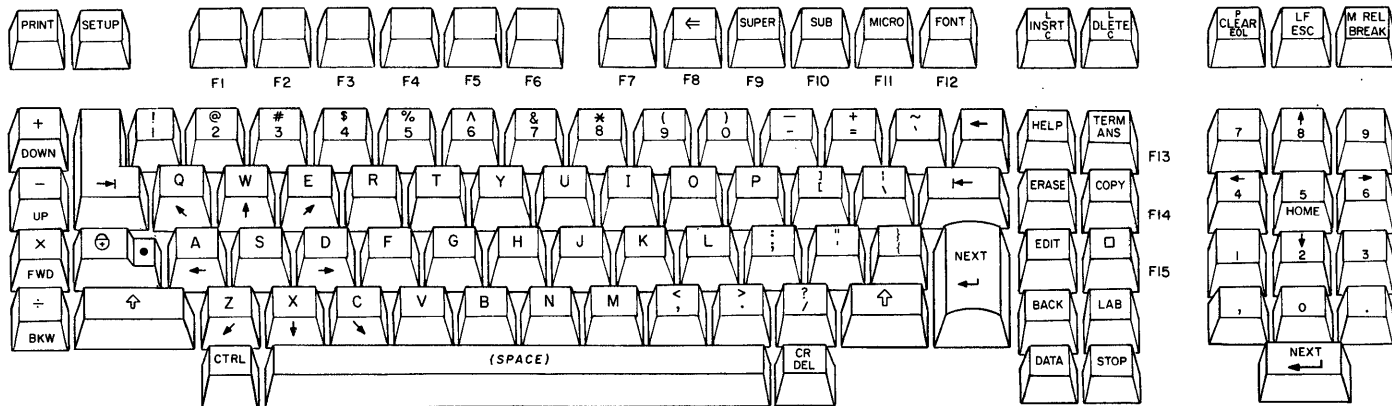

03942-6

Figure C-1. 721-30/31 Standard Keyboard

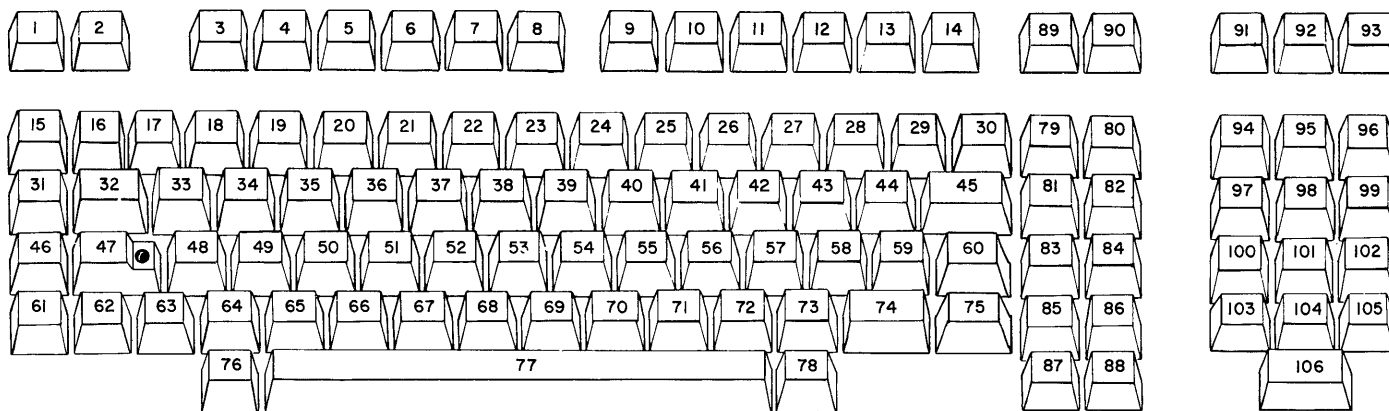

03942-11

Figure C-2. Keystation Assignments

TABLE C-1. KEYBOARD LEGENDS AND CODES (SHEET 1 OF 5)

KEY LEGENDS					CODES GENERATED			
KEY NUMBER	UPPER	CENTER	LOWER	SKIRT	KEY UNSHIFTED	↑ + KEY (SHIFTED)	CTRL + KEY	↑+ CTRL + KEY
1		PRINT			*	*	*	*
2		SETUP			*	*	*	*
3				F1**	*	*	*	*
4				F2**	*	*	*	*
5				F3**	*	*	*	*
6				F4**	*	*	*	*
7				F5**	*	*	*	*
8				F6**	*	*	*	*
9				F7**	*	*	*	*
10		←		F8**	*	*	*	*
11		SUPER		F9**	*	*	*	*
12		SUB		F10**	*	*	*	*
13		MICRO		F11**	--	--	--	--
14		FONT		F12**	--	--	--	--
15		+		DOWN	--	--	--	--
16***								
17	!		1		31	21	31	21
18	@		2		32	40	00	00
19	#		3		33	23	33	23
20	\$		4		34	24	34	24
21	%		5		35	25	35	25
22	^		6		36	5E	36	5E
23	&		7		37	26	37	26
24	*		8		38	2A	38	2A
	(char- acter)							

*Local function is performed.
 **Embossed on keyboard.
 ***Not used; included as part of key number 32.
 --No function is performed.

TABLE C-1. KEYBOARD LEGENDS AND CODES (SHEET 2 OF 5)

KEY LEGENDS					CODES GENERATED			
KEY NUMBER	UPPER	CENTER	LOWER	SKIRT	KEY UNSHIFTED	↑ + KEY (SHIFTED)	CTRL + KEY	↑+ CTRL + KEY
25	(9		39	28	39	28
26)		0		30	29	30	29
27	_		-		2D	5F	1F	1F
28	+		=		3D	2B	1E	1E
29	~		*		60	7E	60	7E
30		←			08	08	08	08
31		-		UP	--	--	--	--
32		→			09	09	09	09
33		Q		↘	71	51	11	11
34		W		↑	77	57	17	17
35		E		↗	65	45	05	05
36		R			72	52	12	12
37		T			74	54	14	14
38		Y			79	59	19	19
39		U			75	55	15	15
40		I			69	49	09	09
41		O			6F	4F	0F	0F
42		P			70	50	10	10
43]		[5B	5D	1D	1D
44			\		5C	7C	1C	1C
45		←			08	08	08	08
46		X		FWD	--	--	--	--
47*		⊕			**	**	**	**

*When shift-lock is selected and the lock key is activated, the lock key's indicator is lit; pressing the M REL key leaves the lock key active but extinguishes the lock key indicator.

**Local function performed.

--No function is performed.

TABLE C-1. KEYBOARD LEGENDS AND CODES (SHEET 3 OF 5)

KEY LEGENDS					CODES GENERATED			
KEY NUMBER	UPPER	CENTER	LOWER	SKIRT	KEY UNSHIFTED	+ KEY (SHIFTED)	CTRL + KEY	+ CTRL + KEY
48		A		←	61	41	01	01
49		S			73	53	13	13
50		D		→	64	44	04	04
51		F			66	46	06	06
52		G			67	47	07	07
53		H			68	48	08	08
54		J			6A	4A	0A	0A
55		K			6B	4B	0B	0B
56		L			6C	4C	0C	0C
57	:		;		3B	3A	3B	3A
58	"		'		27	22	27	22
59	}		{		7B	7D	7B	7D
60*								
61		÷		BKW	--	--	--	--
62		↑			**	**	**	**
63***								
64		Z		↙	7A	5A	1A	1A
65		X		↓	78	58	18	18
66		C		↘	63	43	03	03
67		V			76	56	16	16
68		B			62	42	02	02
69		N			6E	4E	0E	0E
70		M			6D	4D	0D	0D
71	<		,		2C	3C	2C	3C

*Not used; included as part of key number 75.
 **Local function is performed.
 ***Not used; included as part of key number 62.
 --No function is performed.

TABLE C-1. KEYBOARD LEGENDS AND CODES (SHEET 4 OF 5)

KEY LEGENDS					CODES GENERATED			
KEY NUMBER	UPPER	CENTER	LOWER	SKIRT	KEY UNSHIFTED	+ KEY (SHIFTED)	CTRL + KEY	+ CTRL + KEY
72	>		.		2E	3E	2E	3E
73	?		/		2F	3F	2F	3F
74		↑			*	*	*	*
75	NEXT		↓		OD	OD	OD	OD
76		CTRL			*	*	*	*
77		(space)			20	20	20	20
78	CR		DEL		7F	OD	7F	OD
79		HELP			--	--	--	--
80	TERM		ANS	F13	--	--	--	--
81		ERASE			08	08	08	08
82		COPY		F14	--	--	--	--
83		EDIT			--	--	--	--
84		□		F15	*	*	*	*
85		BACK			--	--	--	--
86		LAB			--	--	--	--
87		DATA			5D	5D	5D	5D
88		STOP			*	*	*	*
89	L	INSRT	C		--	--	--	--
90	L	DLETE	C		--	--	--	--
91	P	CLEAR	EOL		*	*	*	*
92	LF		ESC		1B	OA	1B	OA
93**	M REL		BREAK		BREAK	*	BREAK	*

*Local function is performed.

**When shift-lock is selected and the lock key is activated, the lock key's indicator is lit; pressing the M REL key leaves the lock key active but extinguishes lock key indicator.

--No function is performed.

TABLE C-1. KEYBOARD LEGENDS AND CODES (SHEET 5 OF 5)

KEY LEGENDS					CODES GENERATED			
KEY NUMBER	UPPER	CENTER	LOWER	SKIRT	KEY UNSHIFTED	↑ + KEY (SHIFTED)	CTRL + KEY	↑+ CTRL + KEY
94*			7		37	--	37	--
95*	↑		8		38	17	38	17
96*			9		39	--	39	--
97*	←		4		34	08	34	08
98**			5	HOME	35	***	35	***
99*	→		6		36	18	36	18
100*			1		31	--	31	--
101*	↓		2		32	1A	32	1A
102*			3		33	--	33	--
103			,		2C	--	2C	--
104			0		30	--	30	--
105			.		2E	--	2E	--
106	NEXT		←		OD	OD	OD	OD

*Local function is performed in GIN mode (no characters are transmitted).

**When shift-lock is selected and the lock key is activated, the 5/HOME key transmits a 19 code.

***Local function is performed.

--No function is performed.

TABLE C-2. CHARACTER CODES

2ND DIGIT	1ST DIGIT					0	1	2	3	4	5	6	7	
	B	I	T	S		0	0	0	0	1	1	1	1	
	B7	B6	B5	B4	B3	B2	B1	CONTROL		HIGH X & Y GRAPHIC INPUT		LOW X		LOW Y
0	0	0	0	0	0	NUL	DLE	SP	0	@	P	\	p	
1	0	0	0	1	1	SOH	DC1	!	1	A	Q	a	q	
2	0	0	1	0	0	STX	DC2	"	2	B	R	b	r	
3	0	0	1	1	1	ETX	DC3	#	3	C	S	c	s	
4	0	1	0	0	0	EOT	DC4	\$	4	D	T	d	t	
5	0	1	0	1	1	ENQ	NAK	%	5	E	U	e	u	
6	0	1	1	0	0	ACK	SYN	&	6	F	V	f	v	
7	0	1	1	1	1	BEL	ETB	'	7	G	W	g	w	
8	1	0	0	0	0	BS	CAN	(8	H	X	h	x	
9	1	0	0	1	1	HT	EM)	9	I	Y	i	y	
A	1	0	1	0	0	LF	SUB	*	:	J	Z	j	z	
B	1	0	1	1	1	VT	ESC	+	;	K	[k	{	
C	1	1	0	0	0	FF	FS	,	<	L	\	l		
D	1	1	0	1	1	CR	GS	-	=	M]	m	}	
E	1	1	1	0	0	SO	RS	.	>	N	^	n	~	
F	1	1	1	1	1	SI	US	/	?	O	_	o	DEL	

TABLE C-3. ASCII CONTROL CHARACTERS

HEXADECIMAL CODE	KEYSTROKES*	MNEMONIC	AND MEANING
00	CTRL ?	NUL	Null
01	CTRL A	SOH	Start of Heading
02	CTRL B	STX	Start of Text
03	CTRL C	ETX	End of Text
04	CTRL D	EOT	End of Transmission
05	CTRL E	ENQ	Enquiry
06	CTRL F	ACK	Acknowledge
07	CTRL G	BEL	Bell
08	CTRL H	BS	Backspace
09	CTRL I	HT	Horizontal Tabulation
0A	CTRL J	LF	Line Feed
0B	CTRL K	VT	Vertical Tabulation
0C	CTRL L	FF	Form Feed
0D	CTRL M	CR	Carriage Return
0E	CTRL N	SO	Shift Out
0F	CTRL O	SI	Shift In
10	CTRL P	DLE	Data Link Escape
11	CTRL Q	DC1	Device Control 1
12	CTRL R	DC2	Device Control 2
13	CTRL S	DC3	Device Control 3
14	CTRL T	DC4	Device Control 4
15	CTRL U	NAK	Negative Acknowledge
16	CTRL V	SYN	Synchronous Idle
17	CTRL W	ETB	End of Transmission Block
18	CTRL X	CAN	Cancel
19	CTRL Y	EM	End of Medium
1A	CTRL Z	SUB	Substitute
1B	ESC	ESC	Escape
1C	CTRL ®	FS	File Separator
1D	CTRL]	GS	Group Separator
1E	CTRL =	RS	Record Separator
1F	CTRL _	US	Unit Separator
7F	DEL	DEL	Delete

* The keystrokes shown may not be the only keystrokes which will produce a particular control character (hexadecimal code). For example, lowercase alpha characters can be used as well as uppercase alpha characters. Only primary relationships are shown.



The graphics firmware can communicate with an ASCII host system at an input/output rate up to 19,200 baud in either half-duplex or full-duplex operation.

Execution times for the various graphics firmware commands are shown as follows. These are typical times only and are not intended as required specifications. Within all routines, various program paths can be taken that alter the execution times. Those routines that vary significantly are described by a method to approximate the execution time. These times are based on measured timings and serve as an aid for those writing application programs. The timings do not include the overhead of the idle loop, nor do they include communications with the host system or graphics printer. Response to the ENQ control character may be used for timing the longer and more variable operations such as block write/erase and printer operations.

For those data sequences composed of more than one character, only the execution time of the final character is included in the times. Typical execution times for characters other than the last character in these multiple character sequences range from 100 to 150 microseconds. These typical execution times do not include communications receive overhead time.

PERFORMANCE CONSIDERATIONS BY MODE

Performance considerations for data in each of the five graphics modes are described in the following paragraphs.

ALPHA MODE DATA

<u>Character Size</u>	<u>Execution Time (Microseconds)</u>		
	<u>Minimum</u>	<u>Maximum</u>	<u>Average</u>
0	1000	2000	1500
1	800	1600	1200
2	700	1500	1100
3	650	1250	950
4	600	1200	900

GRAPH MODE DATA

For horizontal or vertical lines: $T = 800 + 20 * N$
For a 45-degree diagonal line: $T = 800 + 23 * N$

where T is the time in microseconds to write or erase the vector.
N is the length of the vector in screen dots.

The time to draw a 512-dot, 45-degree vector is approximately 12 600 microseconds. (This is the maximum time it takes to write or erase a vector.)

BLOCK MODE DATA

$$T = 0.657 * X * Y + 3 * X + 13 * Y + 700$$

where T is the time in microseconds to write or erase the block.
X is the width of the block in screen dots.
Y is the height of the block in screen dots.

The time to write or erase a block with $X = Y = 512$ dots is approximately 182 000 microseconds. (This is the maximum time it takes to write or erase a block.)

POINT PLOT MODE DATA

It takes approximately 250 microseconds to write or erase a point (one screen dot).

GIN MODE DATA

Data received from the host system during GIN mode is discarded.

OTHER CONSIDERATIONS

IDLE LOOP OVERHEAD

Each pass through the idle loop takes approximately 100 microseconds and determines whether there is any graphics firmware task to perform.

COMMUNICATIONS RECEIVE OVERHEAD

Each character received from the host system takes approximately 200 microseconds of overhead time to be placed into the communications receive buffer.

GRAPHICS TABLET OVERHEAD

Each character received from the graphics tablet takes approximately 300 microseconds of overhead time as long as the graphics tablet is sending data to the terminal (that is, when the graphics tablet stylus is in proximity to the tablet surface). Therefore, the operator can maximize the drawing rate on the screen by keeping the stylus away from the graphics tablet surface when the stylus is not in use.

SCREEN CLEAR TIME

The time it takes to perform a screen clear operation when pressing the P/CLEAR/EOL or key, or when receiving an ESC FF sequence from the host system, is approximately 10,600 microseconds.

Other Host System Commands

Other host system commands execute in approximately 100 to 500 microseconds.



SUMMAGRAPHS BIT PAD ONE

The Summagraphics Bit Pad One is supported by the CDC Enhanced Graphics/Firmware Option.

SWITCH SETTINGS

Set up the hardware for RS-232-C binary output format, even parity, 2 stop bits, and the desired baud rate. The following list shows the settings for each switch involved in this process.

Switch 1 Position:

- 1 Set by factory. DO NOT CHANGE.
- 2 Set by factory. DO NOT CHANGE.
- 3 Set by factory. DO NOT CHANGE.
- 4 Set by factory. DO NOT CHANGE.
- 5 Set by factory. DO NOT CHANGE.
- 6 Not used.
- 7 ON for serial binary output.
- 8 CRLF switch. Not applicable for binary.
- 9 ON for 0.005-in resolution.

Switch 2 Position:

- 1 ON.
- 2 OFF. Maximum continuous input rate.
- 3 ON.
- 4 ON.
- 5 ON.

Switch 7 Position On:*

- 1 19 200
- 2 9600
- 3 4800
- 4 2400
- 5 1200
- 6 600
- 7 300
- 8 150
- 9 75
- 10 --

*Selection of the desired baud rate requires setting both switch 7 and pluggable strap BA. Exactly one of the 10 positions on switch 7 must be set to ON, and the blue pluggable strap must be over the center pin and the B pin. Note that only one position on switch 7 may be on at a time. Baud rate is factory set with position 2 ON on switch 7, and pluggable strap BA over pin B and the center pin.

OTHER GRAPHICS TABLETS

Graphics tablets from vendors other than Summagraphics can be supported by the CDC 721-30/31 terminal with the 721-301 Enhanced Graphics/Firmware Option.

The graphics tablet must be able to communicate via either of the terminal's RS-232-C serial ports (port A or B), supplying binary data to the terminal in packages of five bytes each, as shown in table E-1.

TABLE E-1. GRAPHICS TABLET DATA FORMAT

BYTE	ITEM	DATA*
1	Flags	S + 40 ₁₆ **
2	High bits of X coordinate	6 MSB X
3	Low bits of X coordinate	6 LSB X
4	High bits of Y coordinate	6 MSB Y
5	Low bits of Y coordinate	6 LSB Y

*MSB and LSB in this column are most significant bits and least significant bits, respectively.

**S equals 4 if the stylus switch is depressed; otherwise, S equals 0.

Each 8-bit byte's uppermost bit (not shown) is a parity bit.

The graphics tablet must provide continuous coordinate sampling and transmission to the terminal while the graphics tablet stylus tip is in proximity to the graphics tablet surface.

COMMENT SHEET

MANUAL TITLE: CDC 721-301 Enhanced Graphics/Firmware Option
Reference Manual

PUBLICATION NO.: 62950116

REVISION: A

NAME: _____

COMPANY: _____

STREET ADDRESS: _____

CITY: _____ STATE: _____ ZIP CODE: _____

This form is not intended to be used as an order blank. Control Data Corporation welcomes your evaluation of this manual. Please indicate any errors, suggested additions or deletions, or general comments below (please include page number references).

STAPLE

STAPLE

FOLD

FOLD



NO POSTAGE
NECESSARY
IF MAILED
IN THE
UNITED STATES

BUSINESS REPLY MAIL
FIRST CLASS PERMIT NO. 8241 MINNEAPOLIS, MINN.

POSTAGE WILL BE PAID BY
CONTROL DATA CORPORATION
Technical Publications Department
2401 North Fairview Avenue
St. Paul, Minnesota 55113

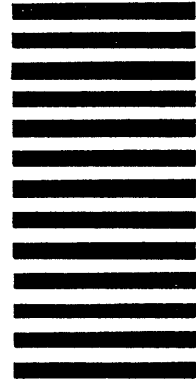

CUT ALONG LINE

FOLD

FOLD

03377

BLOCK MODE

When giving the coordinates for Block mode, it is usually best to specify the top left corner of the area first, then the bottom right corner. The alpha cursor is then in the correct position to begin writing within the area at the upper left corner. Refer also to Write/Erase Selection, following.

WRITE/ERASE SELECTION

The write/erase selection is common for Alpha, Graph, Point Plot, and Block mode. Therefore, if the erase condition is selected for use in one mode, erase will still be selected when another mode is entered.

The WRITE operator parameter (F9) shows the write/erase condition selected with reference to Alpha mode. The parameter will change when ESC DC1 through DC4 command sequences are performed. Refer also to Operator Parameters, following.

OPERATOR PARAMETERS

The operator parameters SCALED (F7), XON/OFF (F8), and WRITE (F9) can be changed when the associated command sequences are performed. Performing these command sequences will change the operator parameters display, but not while the parameters are being displayed. To update the operator parameters display, press the F1 key to remove the display from the screen, then press the SETUP key to display the updated parameters.

SCROLLING

The operator can change to CYBER mode operation to make use of scrolling capability, without losing connection with the host system, by using the following key sequence:

SETUP, F10, F1

The operator can return to graphics operation from CYBER mode by using the following key sequence:

SETUP, F10, F10, Graphics Mode (F3, F4, F5, or F6)

GRAPHICS TABLET

The graphics tablet is always active, causing the terminal to continuously track the tablet cursor whenever the stylus is near the tablet surface. (This occurs regardless of whether or not the stylus is in use, and consumes terminal processing time.) Keeping the stylus away from the tablet surface when not in use prevents unnecessary tracking by the terminal. Also, the tablet cursor overrides the display of both the alpha cursor and GIN cursor, which obscures their locations from the operator.

Since the graphics tablet is always active, when half duplex is selected tablet point selections (picks) can be transmitted to the host system one after the other without waiting for the host system to respond to each pick. (This applies to those host systems that can handle multiple inputs; known on CDC systems as type-ahead.)

When full-duplex communications are selected, tablet picks should not be made until the host system is ready (has responded to previous picks), or the output of a previous pick becomes confused with the echo response to a premature pick.

CORPORATE HEADQUARTERS, P.O. BOX 0, MINNEAPOLIS, MINN. 55440
SALES OFFICES AND SERVICE CENTERS IN MAJOR CITIES THROUGHOUT THE WORLD

LITHO IN U.S.A.

0

0

0

0

0



CONTROL DATA CORPORATION

0

0