

PDP-10

SITE PREPARATION GUIDE

This manual does not purport to cover all details or variations of the PDP-10 System, nor to provide for every possible contingency to be met in connection with the installation, operation, or maintenance of the PDP-10 System.

Copyright © 1970 by Digital Equipment Corporation

The material in this manual is for information purposes and is subject to change without notice.

The following are trademarks of Digital Equipment Corporation, Maynard, Massachusetts:

DEC
FLIP CHIP
DIGITAL

PDP
FOCAL
COMPUTER LAB

CONTENTS

	Page
SITE PLANNING	
Introduction	1
Schedule of Site Preparation Prior to System Delivery	1
Site Considerations	2
Floor Construction	2
Acoustical Considerations	3
Fire and Safety Precautions	4
General Precautions	4
Site Cleanliness	4
Electrical Service	5
Power Failure	5
System Component Layout	5
Cabling Considerations	6
Environmental Requirements	7
Air Conditioning	7
Humidity and Temperature	7
System Environment vs System Reliability	7
Other Environmental Considerations	10
Communications Data Sets	10
Power Requirements – 60-Hz Systems	12
Power Requirements – 50-Hz Systems	12
Ground Mesh Specifications	14
INSTALLATION DATA SHEETS	
KA10 Arithmetic Processor	17
DK10 Real-Time Clock	19
MA10 and MA10A Core Memory	21
MB10 Core Memory	23
MD10 Core Memory	25
MX10 Memory Data Multiplexor	27
DF10 Data Channel	29
RC10 Disk Control	31
RM10B Fixed Head Drum	33
RD10 Fixed Head Disk	35
RP10 Disk Pack Control	37
RP01 Disk Pack Drive	41
RP02 Disk Pack Drive	43
TD10 DECTape Control	45
TU55 DECTape Transport	47
TM10A and TM10B Magnetic Tape Control	49
TU20A and TU20B Magnetic Tape Transport	51
TU30A and TU30B Magnetic Tape Transport	53
BA10 Hard Copy Control	55

CONTENTS (Cont)

	Page
INSTALLATION DATA SHEETS (Cont)	
CP10A Card Punch	57
CR10A Card Reader	59
LP10A Line Printer	61
LP10B Line Printer	63
LP10C, LP10D, and LP10E Line Printers	65
XY10A Incremental Plotter	67
XY10B Incremental Plotter	69
DC10 Data Line Scanner	71
DC68A Data Communications System	73
LT33A and LT33C Teletypewriters	75
LT33B and LT33H Teletypewriters	77
LT35A and LT35C Teletypewriters	79
LT37AC Teletypewriter	81
346/340B Precision Incremental CRT Display	83
348/VR30 Precision Display	85
VP10 Display Control	87
DA10 PDP-8/PDP-9 Interface	89
GP10 PDP-10 I/O Bus Interface	91

ILLUSTRATIONS

Figure 1	The Pedestal Type of Flooring	3
Figure 2	The Raceway Type of Flooring	3
Figure 3	Psychrometric Chart (English Units)	9
Figure 4	Psychrometric Chart (Metric Units)	9
Figure 5	60-Hz Connectors Used in PDP-10 Systems	13
Figure 6	PDP-10 System Ground Connections	14

TABLES

Equipment Environmental and Physical Specifications	93
---	----

INTRODUCTION

This site preparation guide is intended to provide the PDP-10 customer with electrical, physical, and environmental data which should be helpful in planning an efficient computer installation. More detailed information can be obtained from sources such as:

Plant Engineering Handbook, by William Staniar; 2nd edition; Publisher – McGraw-Hill, New York City, New York
ASHRAE Handbook, by American Society of Heating, Refrigeration and Air Conditioning Engineers; New York City, New York

SCHEDULE OF SITE PREPARATION PRIOR TO SYSTEM DELIVERY

The site preparation schedule recommended below will ensure optimum installation of a PDP-10 system.

Six months prior to system delivery:

- a. Determine power requirements, air conditioning requirements, floor requirements, etc.
- b. Determine the location and layout of the PDP-10 system (using the layout kit provided).
- c. Check door sizes, elevators, or other restrictions which may affect system installation.
- d. Check on delivery of power and air conditioning equipment and ensure that this equipment is installed prior to system delivery.

Four months prior to system delivery:

- a. Ensure that the final installation layout is resolved so that all cabling may be ordered. No changes should be made thereafter that would change cable lengths.
- b. Determine placement of power receptacles.

One month prior to system delivery:

- a. Have a local Digital Equipment Corporation sales representative visit the site to determine specific requirements for moving the system components from the truck, or loading platform, to the installation site.

- b. Check that all air conditioning equipment, electrical facilities, lighting, painting, flooring, etc, will be ready prior to system delivery. The air conditioning should be tested and operating before the system is delivered.

SITE CONSIDERATIONS

The following items should be considered in selecting the computer site:

- a. Availability of adequate power
- b. Efficient work-flow pattern to other work areas
- c. Proper air conditioning facilities
- d. Floor loading capacity
- e. Proper fire and safety requirements
- f. Sufficient storage space for an adequate supply of line printer paper, magnetic tape, and any other supplies which are necessary to the operation of the PDP-10 system.
- g. Future system expansion
- h. Location of telephone and data sets.

FLOOR CONSTRUCTION

Although the PDP-10 system does not require special flooring, a raised floor is desirable, because it provides the following advantages:

- a. Minimum cost for future layout changes.
- b. Protection of power and interconnecting cabling.
- c. Safety of personnel (no cabling to trip on).
- d. Enhancement of the overall site.

One type of flooring suitable for a PDP-10 site is the Pedestal Type shown in Figure 1. This flooring allows cable routing in any direction (under the floor); it also allows flexibility in the system layout, and minimizes cable lengths.

Another type of flooring is the Raceway Type shown in Figure 2. This type of flooring does not allow the cable routing flexibility provided by the Pedestal type.

The floor should be constructed to allow access to the cabling. The floor must also be capable of withstanding the weight requirements of the system, personnel, and any other equipment which is to be positioned on the raised floor. The floor covering should be anti-static in nature. Flooring constructed with metal panels must be properly grounded.

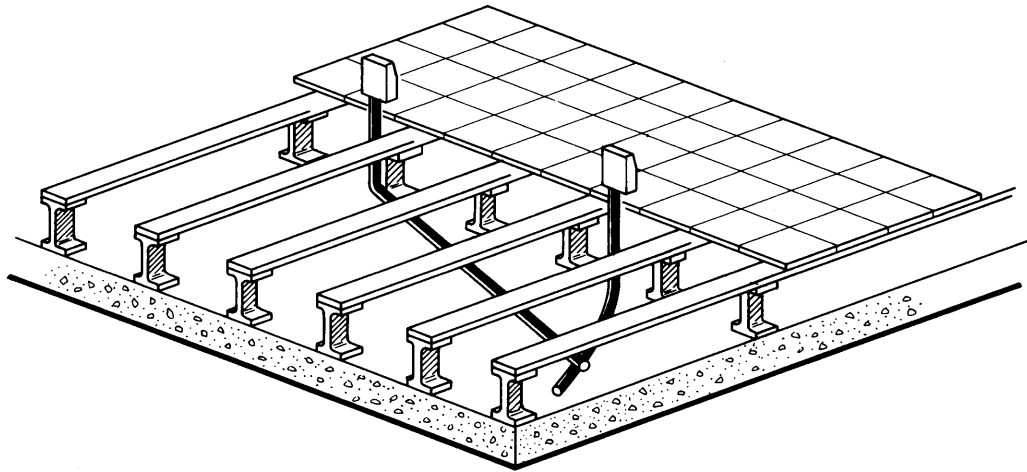

10-0479

Figure 1 The Pedestal Type of Flooring

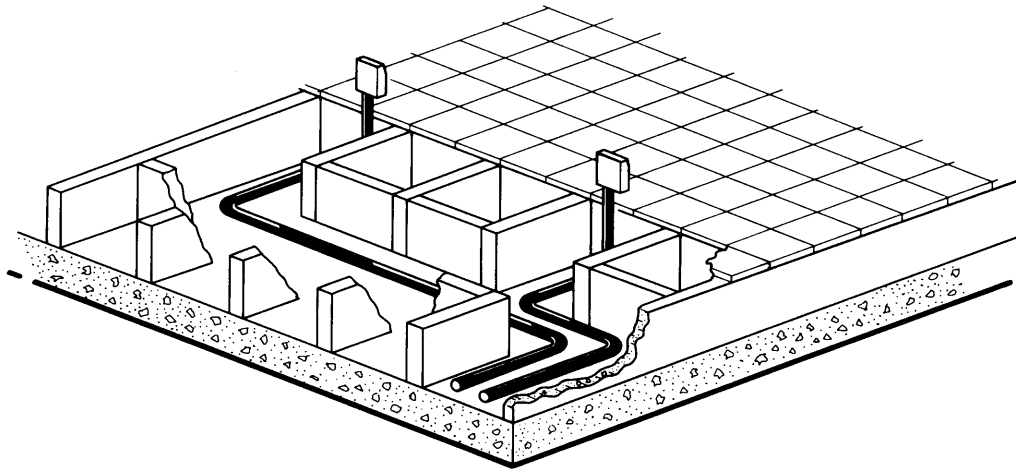

10-0478

Figure 2 The Raceway Type of Flooring

The weight of each component is listed in this manual so that the total system weight can be determined prior to selecting the proper site and flooring.

ACOUSTICAL CONSIDERATIONS

Some degree of acoustical treatment is desirable in most sites. Acoustic dampening will depend on variables such as ceiling height, room size, type and number of components, the value placed on low sound level, etc. Principal noise sources are mechanical devices such as line printers, tape drives, card readers, and cooling blowers.

It is suggested that the floor be constructed of materials which will dampen noise vibration to other areas. Walls should be structured with a dead-air space between two sound-retardant wall surfaces. Ceilings properly treated with acoustic dampeners or acoustic materials will provide the greatest reduction in noise levels. Duct work should also be acoustically treated to prevent noise transmission to other areas.

FIRE AND SAFETY PRECAUTIONS

When planning a computer site, the following should be considered:

- a. The site should be located in an area removed from any explosive materials or gases.
- b. The site should be watertight to the degree that the site will not be subject to flooding, wind-driven rain, etc.
- c. The normal fire and safety precautions specified by local codes and/or insurance requirements should be followed.

Fire prevention equipment recommended for the site is listed below.

- a. Carbon dioxide extinguishers of 15 lbs or their equivalent should be readily accessible. These extinguishers should be inspected regularly to insure proper operation.
- b. Overhead sprinkler systems are often required by local authorities or insurance carriers.

It is also recommended that a remote, fire-proof storage space, such as a vault, be provided for storing master files which may be recorded on magnetic tape, paper tape, or other storage media.

General Precautions

All incoming services such as water, power, etc, should be regularly inspected. Pipes should be checked for excess condensation, leaks, or corrosion.

SITE CLEANLINESS

Because of variations in computer sites, the methods used to keep the areas clean vary accordingly. However, certain cleaning precautions are recommended to ensure optimum efficiency of the PDP-10 System. The recommended cleaning precautions are as follows:

- a. Keep waxing to a minimum. Some waxes tend to flake and this can seriously jeopardize the operating efficiency of the installation. Some waxes also tend to build up a static charge. The method of wax application should be such that wax is applied only on intended surfaces.
- b. Clean only with a damp mop, never dry or wet. Do not sweep when magnetic tapes, disks, or drums are included in the system.
- c. Make sure that any vacuum cleaner used is connected to an external vacuum or an adequate sealed or filtered container (e.g., a water type tank).
- d. Use a nonconductor type of nozzle when vacuuming under the equipment to minimize the possibility of an electrical accident.

- e. Do not permit smoking in the computer room, especially while handling tape, attending tape drives, or in the tape storage area. Smoke, dust, and ashes adversely affect equipment operation.
- f. Do not place material on top of the equipment, where it could restrict the air flow or fall inside the cabinet.
- g. Before installing the system, clean all subfloor areas (including cable raceways). The cleaning schedule should include periodic cleaning of these areas.
- h. A schedule should be planned which will ensure site cleanliness, even though it is not possible to recommend a fixed cleaning schedule which would apply to each installation.
- i. Consult the manufacturer of the specific floor covering used regarding acceptable floor cleaning procedures.

ELECTRICAL SERVICE

The following items should be considered when providing electrical service for the installation:

- a. Electrical service to the computer area should be protected by a main line circuit breaker. This circuit breaker should be readily accessible to operating personnel.
- b. A battery-operated light source should be installed to provide emergency lighting in case of a power failure. The light source should come on automatically when a power failure occurs.
- c. Lightning surges should be countered by the installation of arrestors mounted on the secondary power source. The most effective suppression can be effected when the utility company installs protection on the primary source.
- d. Waterproof power receptacles and connectors should be used for locations under false floors.

Power Failure

In case of a power failure, the PDP-10 system will shut down automatically, with no damage to system hardware.

SYSTEM COMPONENT LAYOUT

Major factors in determining optimum system layout include site space, number of components, service clearances, work space, aisles, storage cabinets, maximum cable lengths, etc. To assist in formulating the most efficient layout, a kit is provided containing the floor plans of each component in the PDP-10 system. These floor plans, scaled ½ in. to the foot, contain all the information necessary to accurately prepare an efficient site. They show the load point, casters, service clearances, door swing, cooling air ducts, and cables access openings for each component.

These points should also be considered when preparing the system layout:

- a. Visibility of control units and input/output devices to operating personnel.
- b. Proper light-levels (not too bright) in areas where illuminated display and read-out devices reside.

- c. Remote processing equipment (data sets, Teletypes®, etc) should be reviewed with the local telephone company. The communication lines should be installed prior to system delivery.

CABLING CONSIDERATIONS

The following cabling restrictions apply when laying out a PDP-10 system:

PDP-10 I/O BUS – The sum of lengths of cable from the processor to the farthest device on the I/O Bus must be less than 150 ft (45 meters). Allow 5 ft (1.5m) per free-standing peripheral cabinet for cable routing inside of the cabinet. The maximum number of connections to the I/O Bus is 40.

PDP-10 MEMORY BUSES – The sum of lengths of cable from a processor to the farthest memory cabinet must be less than 100 ft (30m). Allow 5 ft (1.5m) per free-standing memory cabinet for cable routing inside of the cabinet. The KA10 Arithmetic Processor must be at one end of its memory bus. The DF10 may be located anywhere along its memory bus, with up to 100 ft (30m) of cable on either side of it. The MX10 is equivalent to 20 ft (6m) of memory bus cable in any path in which it occurs. The maximum number of memory connections to a memory bus is 16.

PDP-10 CHANNEL BUS – The sum of lengths of cable from the DF10 to the farthest channel device must be less than 100 ft (30m) of standard PDP-10 cable. Allow 5 ft (1.5m) per free-standing channel device cabinet for cable routing inside the cabinet. The maximum number of channel device connections to the channel bus is 16.

PDP-8 I/O BUS or PDP-12 I/O BUS – In PDP-10 systems utilizing devices such as the DA10 PDP-8/9 Interface, the following data is pertinent. The recommended maximum cable length from the interface device to a PDP-8 family computer with a negative I/O Bus is 20 ft (6m). The recommended maximum cable length from the device to a PDP-8 family computer, with a positive-to-negative or negative-to-positive I/O Bus converter, is 23 ft (7m). The PDP-8 System specification limits the absolute maximum cable length between the PDP-8 processor and the last device on its I/O Bus to 50 ft (15m); the maximum length when using flexprint cable is 15 ft (4.5m).

PDP-9 I/O BUS or PDP-15 I/O BUS – In PDP-10 systems utilizing devices such as the DA10 PDP-8/9 Interface, the following data is pertinent. The maximum cable length between the interface device and the PDP-9 or PDP-9L computer is 50 ft (15m). The maximum length of cable between the device and a PDP-15 computer, with a positive-to-negative I/O Bus converter, is 30 ft (9m).

DEVICE CABLES – The maximum length of peripheral device cables is specified in the individual data sheets that appear in this manual (beginning on page 17). Most devices accommodate up to 25 ft (7.5m) of cable.

NOTE

For cabling interconnect data, refer to the corresponding equipment maintenance manuals.

® Teletype is the registered trademark of Teletype Corporation.

ENVIRONMENTAL REQUIREMENTS

Air Conditioning

Heat dissipation figures in Btu/hr and watts are given for each component. To estimate air-conditioning requirements, total the heat dissipation figures for all components in the system. Other factors to consider are the number of personnel; heat radiation from other areas through walls, ceilings, and floors; sun exposure through windows, etc. A separate computer room air-conditioning system is recommended for large computer sites.

Humidity and Temperature

PDP-10 system components are designed to operate within specified temperature and humidity ranges. Since individual peripheral devices may deviate from overall system specifications, consult the individual data sheets for these figures. Overall system operating and storage requirements are as follows:

OPERATING REQUIREMENTS

Temperature: 60 to 95°F

15 to 35°C

Relative Humidity: 20 to 80 %

(see Note 1)

STORAGE REQUIREMENTS

Temperature: 40 to 110°F

5 to 45°C (see Note 2)

Relative Humidity: 10 to 80%

(no condensation)

NOTES

1. Certain peripheral devices require a relative humidity of 40 to 60%.
2. The "Storage Temperature" shown on the individual data sheets denotes the recommended temperature limits when the system is in its operating configuration without power applied. When suitably packed for shipment, the system may be placed in short-term storage with temperature limits of -20°F to +140°F (-30°C to +60°C), provided that no condensation occurs and that rapid temperature changes are ameliorated by the packing materials. For long-term storage, or more extreme temperature ranges, consult Digital Equipment Corporation.

SYSTEM ENVIRONMENT vs SYSTEM RELIABILITY

The reliability of a computer system is a complex function of the task it is expected to perform and its environment.

The task the computer is expected to perform establishes criteria which define when the system has failed and to what extent. A computerized telephone switching center might allow a total of only two hours of complete inoperativeness in twenty years time, but might not consider computation errors or failure of parts of the system as serious errors. An on-line laboratory computer, on the other hand, may require complete error-free operation for several hours, but allow substantial amounts

of scheduled down-time before and after the experiment. The requirements and techniques for any individual application are beyond the scope of this publication; however, some of the non-environmental factors to be considered are listed below:

- a. Time interval before data is irretrievably lost.
- b. Use of a small, independent subsystem for data capture.
- c. Significance of a data error.
- d. Significance of extended down-time.
- e. Partially or completely redundant system with manual or automatic system changeover.
- f. Graceful system degradation upon subsystem failure.
- g. I/O device-independent software.

The environment of a computer system has a marked effect on the reliability of the system. Numerical Mean-Time-Between-Failure statistics are merely another way of expressing average ignorance of the fundamental failure mechanisms in a system. As these fundamental failure mechanisms become known, they are designed out of systems and the systems become more reliable; that is, the technology becomes more mature. Another way to increase reliability is to maintain a more controlled environment.

High temperatures increase the rate of deterioration of virtually every material. Temperature cycling and thermal gradients induce temporary and permanent microscopic changes in materials. High absolute humidity (dewpoint) causes moisture absorption and dimensional and handling changes in paper and plastic media (line printer paper, cards, paper tape, magnetic tape, etc).

Low humidity allows the build up of static electricity. Lack of air cleanliness results in reduced life of tapes and early data errors in all moving magnetic storage media (drums, disks). The combination of static electricity and air-borne dust is particularly detrimental to magnetic tapes. Vibration can cause slow degradation of mechanical parts and, when severe, may cause data errors on disks and drums.

Electrical noise can cause problems similar to static and, when severe, may cause hardware logic errors. All of these environmental factors cause slowly accumulated sources of eventual failure.

Although the PDP-10 system is substantially more reliable in a hostile environment than many other systems of a similar size, relatively close control of the environment usually results in more reliable system operation. The optimum temperature is $70^{\circ}\text{F} \pm 3^{\circ}\text{F}$ ($20^{\circ}\text{C} \pm 2^{\circ}\text{C}$); the optimum relative humidity is $50\% \pm 10\%$. The use of a flooring material which conducts (dissipates) static electricity and does not require waxing is preferable. (Wax tends to flake off and turn into air-borne dust.)

Figures 3 and 4 contain psychrometric charts which show the relationship between temperature, absolute humidity, and relative humidity.

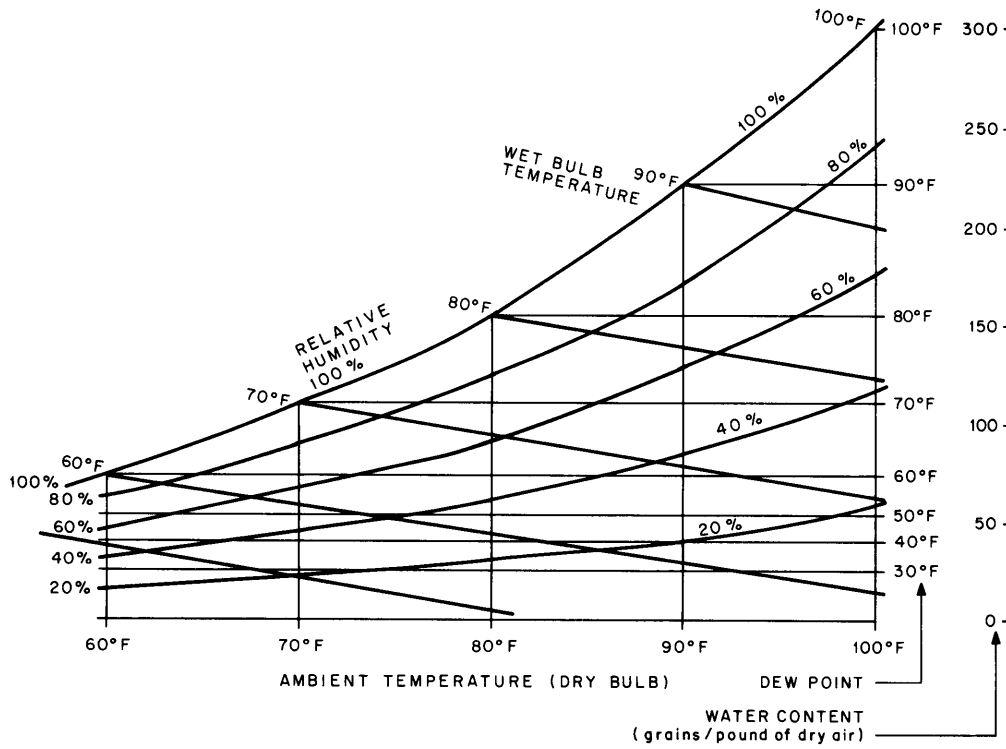

10-0440

Figure 3 Psychrometric Chart (English Units)

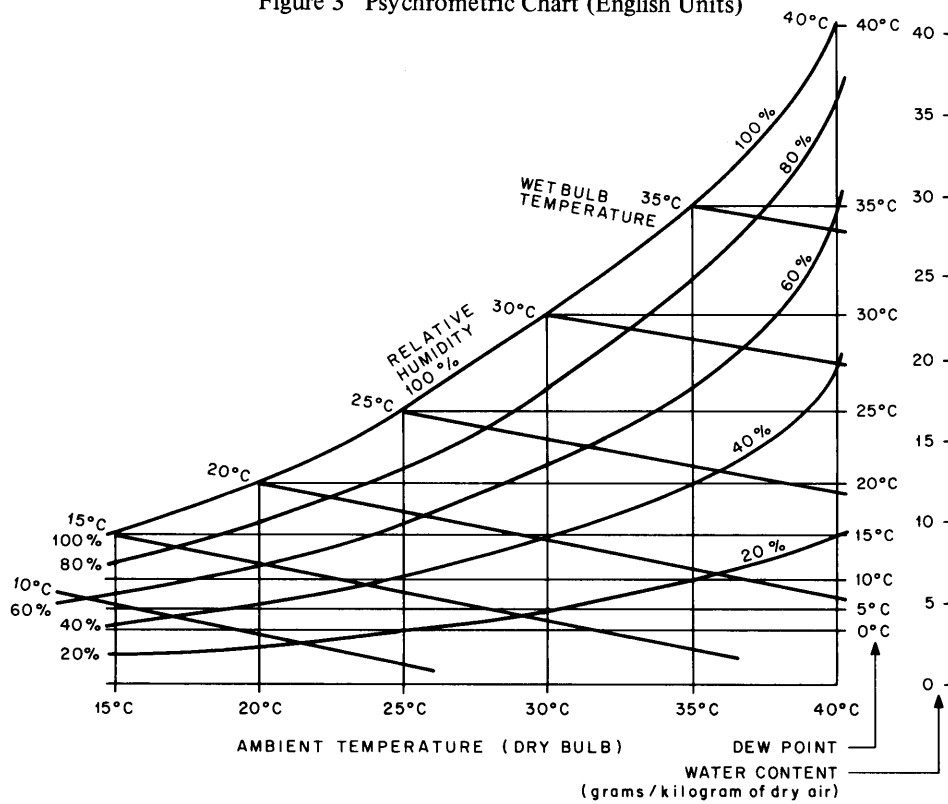

10-0439

Figure 4 Psychrometric Chart (Metric Units)

OTHER ENVIRONMENTAL CONSIDERATIONS

When it is necessary to increase the relative humidity, one of the following procedures is advised:

- a. A commercially available humidifier capable of raising and maintaining the proper humidity
- b. Steam cups
- c. Steam grids or jets.

Temperature and humidity recording instruments should be installed at the system site to continually monitor and record these conditions. Certain advantages are realized from such records.

- a. The customer can easily determine if the required operating conditions are met on a constant basis, and if the air conditioning equipment is functioning properly.
- b. If humidity requirements are exceeded, the customer can determine if a drying-out period is required to prevent card and tape damage and to ensure efficient operation.

As noted earlier, sufficient storage facilities must be provided for line printer paper, magnetic tape, and any other supplies which are necessary in the operation of a PDP-10 system. The environmental requirements for these storage facilities are the same as that for the overall system. Operating supplies such as magnetic recording media, card decks, etc, should be stored in a closed cabinet to eliminate contamination by foreign matter.

COMMUNICATIONS DATA SETS

Communications data sets may be used with the DC68A Communications System or DC10 Data Line Scanner. Digital Equipment Corporation does not sell data sets; therefore, the customer must purchase this equipment from some other source. Data sets should be ordered well in advance of the PDP-10 installation date, as the delay between ordering and installation of data sets may vary from two weeks to two years, depending upon the model and supplier.

Although there are a large number of possible data sets and data set configurations, the System 103A and 103E type data sets are most common. For timesharing applications which use software supplied by Digital Equipment Corporation, the following options are recommended:

BELL SYSTEM 103A2 – This type is recommended for systems which require a small number of data sets.

Recommended Features:

- a. Automatic Answer – Never, Key-Controlled (Push Button), Always: The Key-Controlled, Automatic Answer feature is recommended when there is little likelihood of unauthorized tampering with the data set controls. The Always, Automatic Answer feature is recommended when unauthorized tampering is a possibility. (In either case, the data set will not answer automatically unless the computer allows it to do so.)
- b. Initiate “Long Space” Disconnect – Yes, No: The Yes, Initiate “Long Space” Disconnect feature is recommended. This feature allows the data set to disconnect the call and re-initialize other data sets in spite of certain features of the telephone network.

- c. Respond to “Long Space” Disconnect – Yes, No: The Yes, Respond to “Long Space” Disconnect feature is recommended. It allows a remote data set to disconnect the call and reinitialize the data set, in spite of certain features of the telephone network.
- d. Mark Hold or Space Hold. The Mark Hold feature is recommended to prevent the “running open” of the DC10 or DC68A Communications Systems.

BELL SYSTEM 103E5 – This type is recommended for systems which require a large number of data sets.

Recommended Features:

- a. CE off, CE on: The CE off feature is recommended. It allows distinction between a call requesting answering and a call in progress.
- b. Send Disconnect – Yes, No: The Yes, Send Disconnect feature is recommended. It allows the data set to disconnect the call and reinitialize other data sets, in spite of certain features of the telephone network.
- c. Space Disconnect – Long, Short, None: The Long, Space Disconnect feature is recommended. It allows certain other data sets to disconnect the call and reinitialize the data set without causing false disconnects due to “Break” signaling.
- d. Answer Control – Manual, Key-Controlled (Push-Button), Automatic: The Key-Controlled, Answer Control feature is recommended when there is little likelihood of unauthorized tampering with the data set controls. The Automatic, Answer Control feature is recommended when unauthorized tampering is a possibility. (In either case, the data set will not automatically answer until the computer allows it to do so.)
- e. Loss of Carrier Disconnect – Yes, No: The Yes, Loss of Carrier Disconnect feature is recommended. This feature allows the call to be disconnected and frees the data set for further use if the call is interrupted, or if the distant location disconnects without properly terminating the call.
- f. CB and CF Indications – Separate, Common: The Common CB and CF Indications feature is recommended. This feature provides compatibility with Type 103A2 data sets.
- g. Dialing Feature – Rotary Dial, Rotary Dial with Card Dialer, Touch-Tone Dial, Touch-Tone Dial with Card Dialer: No recommendation is made, as this decision depends on the user’s preference and the availability of Touch-Tone features in the user’s area.
- h. Computer Make Busy – Yes, No: The No, Computer Make Busy feature is recommended. This feature provides compatibility with presently available DIGITAL software.
- i. Signal Ground Connected to Protective Ground – Yes, No: The Yes, Signal Ground Connected to Protective Ground feature is recommended.
- j. Mark Hold, Space Hold: The Mark Hold feature is recommended.
- k. Frequency Assignments – Normal, Inverted: The Normal, Frequency Assignments feature is recommended. The protection from unauthorized callers allegedly provided by inverted frequency assignments is not required in the PDP-10 system.
- l. Restraint Detection – Yes, No: The No, Restraint Detection feature is recommended. No provision for restraint detection is provided in present DIGITAL software.

POWER REQUIREMENTS – 60-Hz SYSTEMS

PDP-10 60-Hz Systems operate from a $115/200V \pm 10\%$, $60 \text{ Hz} \pm 2\%$, 3-phase WYE-connected power system. Power requirements for the system components vary as follows:

- a. Some devices, such as the KA10, require an input of $115/200V \pm 10\%$, $60 \text{ Hz} \pm 2\%$, 3-phase, 4-wire plus ground, and are supplied with 25 ft (7.5m) of 5-conductor wire and a Hubbell 3521 cord cap (male plug), which mates with a Hubbell 3520 receptacle. A 20A circuit is recommended for this type of service.
- b. Other devices, such as the TD10, require an input of $115V \pm 10\%$, $60 \text{ Hz} \pm 2\%$, single-phase, 2-wire plus ground, and are supplied with a Hubbell 3331 cord cap (male plug) which mates with a Hubbell 3330 receptacle. A 30A circuit is recommended for this type of service.
- c. Some smaller devices, such as plotters, require an input of $115V \pm 10\%$, $60 \text{ Hz} \pm 2\%$, single-phase, 2-wire plus ground and are supplied with 3-wire caps for use with standard 3-wire grounding type convenience outlets. A standard appliance circuit is recommended. (The console Teletype plugs into the central processor and does not require a receptacle.)

In most systems it is convenient to provide a separate load center or breaker panel for the computer and connect each 20A or 30A receptacle to its own circuit breaker, supplying single-phase receptacles from phase to neutral connections.

In addition to power, each computer system should have a substantial earth ground connection to the central processor frame ground with a #4 AWG (0.20 in., 5 mm) copper wire. A building beam or large water pipe is adequate in many cases, although some systems may require direct connection to a grounding stake or other high-quality ground.

A 25 ft (7.5m) ac power cord is provided with each individual component. This cable is routed through the bottom of each cabinet via a cable access hole to the power receptacle. The ac power requirements for each component are listed on its Installation Data Sheet.

Figure 5 illustrates the various types of 60-Hz connectors used in PDP-10 Systems.

POWER REQUIREMENTS – 50-Hz SYSTEMS

PDP-10 50-Hz Systems operate from $230/400V \pm 10\%$, $50 \text{ Hz} \pm 2\%$, 3-phase WYE connected power mains. Single-phase and three-phase loads are present in the system. Other main supply voltages can be accommodated upon request. Power requirements for the system components vary as follows:

- a. Some devices, such as the KA10, require an input of $230/400V \pm 10\%$, $50 \text{ Hz} \pm 2\%$, 3-phase, 4-wire plus ground, and are supplied with a 5-terminal pressure connector block and 25 ft (7.5m) of 5-conductor wire. Male caps and receptacles are not supplied by DEC. A 10A circuit is recommended for this type of service.
- b. Other devices, such as the TD10, require an input of $230V \pm 10\%$, $50 \text{ Hz} \pm 2\%$, single-phase, 2-wire plus ground and are supplied with a 3-terminal pressure connector block and 25 ft (7.5m) of 3-conductor wire. Male caps and receptacles are not supplied by DEC. A 15A circuit is recommended for this type of service.

115/200V, 60Hz, 3-PHASE, 20A
(PIN VIEW OF MALE PLUG)

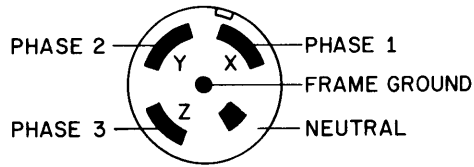

HUBBELL CONNECTOR
PART NUMBERS:
RECEPTACLE 3520
CAP 3521

115V, 60Hz, SINGLE-PHASE, 15A
(PIN VIEW OF MALE PLUG)

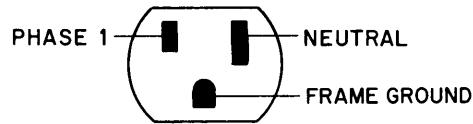

IF NEUTRAL IS NOT
AVAILABLE, A RECEPTACLE
OF THIS DESIGN WILL BE
USED, BUT BOTH PARALLEL
SLOTS SHALL BE SHORT SO
THAT POLARIZED BLADE
PLUGS (CAPS) WILL NOT FIT.

115V, 60Hz, SINGLE-PHASE, 30A
(PIN VIEW OF MALE PLUG)

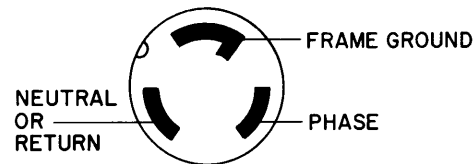

HUBBELL CONNECTOR
PART NUMBERS
RECEPTACLE 3330-G
(3330 MAY BE USED)
CAP 3331-G
(3331 MAY BE USED)

Figure 5 60-Hz Connectors Used in PDP-10 Systems

10-0438

- c. Plotters and other small devices require an input of $115V \pm 10\%$, $50 \text{ Hz} \pm 2\%$, single-phase, 2-wire plus ground, and are supplied with 3-wire caps for use with standard North American 3-wire grounding type convenience outlets. During equipment installation, these caps may be removed and replaced with other caps. A standard appliance circuit is recommended for these devices. (The console Teletype plugs into the processor, and does not require a receptacle.)

In most systems it is convenient to provide a separate load center or circuit breaker panel for the computer, and to connect each 10A or 15A receptacle to its own circuit breaker, supplying single-phase receptacles from phase to neutral connections.

In addition to power, each computer system should have a substantial earth ground connection to the processor frame ground made with a #4 AWG (.20-in., 5mm) copper wire. A building beam or large water pipe is adequate in many cases, although some systems may require direct connection to a grounding stake or other high-quality earth ground.

GROUND MESH SPECIFICATIONS

In order to keep electrical noise and differential potentials under control in the PDP-10 system, the following ground system is recommended. Other schemes may provide adequate grounding; however, any alternate system should be carefully studied to ensure that adequate grounding is provided.

Each cabinet of the PDP-10 system is provided with ground lug terminals. These grounding terminals should be connected as shown in Figure 6 with #4 gauge (0.20 in., 5 mm) copper wire or its equivalent. Ordinary stranded #4 gauge wire is adequate for this purpose, although #4 gauge welding cable (extra flexible stranding) may be preferred by some. Digital Equipment Corporation supplies a standard grounding conductor with each I/O and memory cabinet. A Burndy QA4C-B solderless lug (or equivalent) is recommended for the cable, and is included on standard Digital Equipment Corporation ground cables. Upon installation, the purchaser should supply a good earth ground connection to each processor through #4 gauge copper wire or its equivalent. In general, an adequate earth ground is provided by a steel beam of a building frame, or a reasonably large water pipe. The quality of the earth ground required depends somewhat on the use of the system.

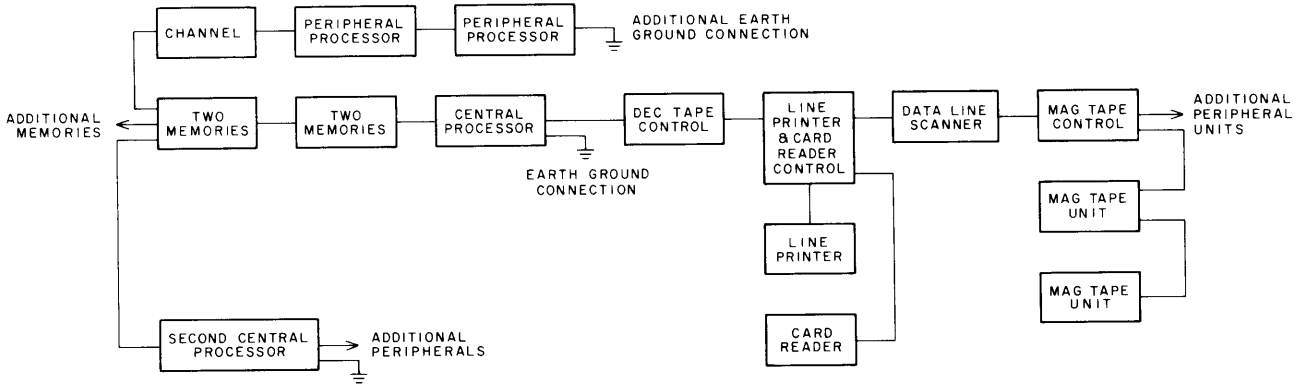

Figure 6 PDP-10 System Ground Connections

A system involving a digital/analog interface usually requires that the digital system ground be tied to the analog system ground at a single point, often at the analog/digital interface. A good ground connection is usually required in these cases. In small systems where no analog interface is involved, the grounding provided by a large electrical conduit may be adequate, although electrical conduit systems often are connected together poorly in terms of a low resistance path to ground. In large systems, additional connections to earth ground may also be advisable. All of these ground connections are in addition to (not in place of) the ground leads carried through the various signal buses (memory, I/O multiplexer, and channel buses) and the ground conductors contained in the power cables. The green grounding wire in the power cable must also be returned to ground, usually through the conduit of the electrical distribution system.

When two cabinets are bolted together, they should be electrically bonded together by connecting the two cabinets by means of a #4 gauge conductor or several copper mesh straps.

Auxiliary units such as the line printer and card reader should be grounded to their associated control cabinets with #4 gauge (.20 in., 5 mm) copper wire.

In general, ground conductors should follow the path of the data buses through the system (i.e., in parallel with the memory buses, the I/O bus, the channel bus, etc).

This page intentionally left blank.

**KA10
ARITHMETIC PROCESSOR**

DESCRIPTION

The KA10 is the central processing unit for all PDP-10 systems. It is provided with:

- A PC09 Paper Tape Reader/Punch
- An LT35A Console Teleprinter (LT37AC when available)
- A KE10 Extended Order Code feature which provides floating point and byte manipulation
- An Operator Console and Chair

The following options are housed in the KA10 cabinet:

- KM10 Fast Registers
- KT10A Dual Memory Protection and Relocation Registers

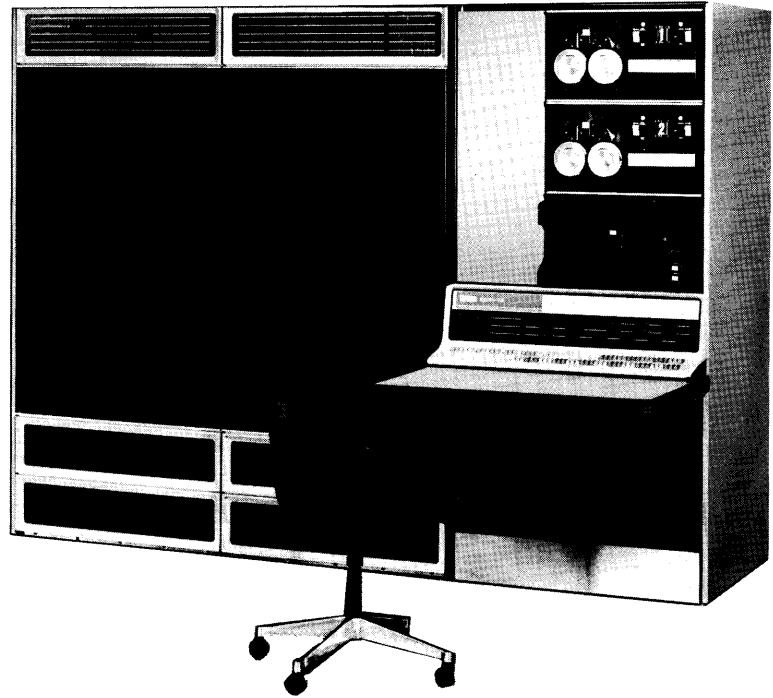

INSTALLATION DATA

Voltage	Current @ 115 Vac	Power/Heat Dissipation	Dimensions			Weight	Operating Temperature	Storage Temperature	Relative Humidity	Maximum Cable Length		
			Height	Width	Depth					I/O	Memory	Device
See Notes 1 and 2	11A, phase 1 (16A with punch on) 11A, phase 2 14A, phase 3 Surge: 25A/phase	4300W 14,720 Btu/hr	69 in. 1.75m	96.5 in. 2.45m	49.5 in. 1.26m	1930 lb 875 kg	60° to 95°F 15° to 35°C	40° to 110°F 5° to 45°C	20% to 80%	150 ft 45m	100 ft 30m	

Note 1: 60 Hz Systems – This device requires an input of 115/200V ± 10%, 60 Hz ± 2%, 3-phase, 4-wire plus ground and is supplied with 25 ft (7.5m) of 5-conductor wire and a Hubbell #3521 cord cap (male plug) which mates with a Hubbell #3520 receptacle. A 20A circuit is recommended for this type of service.

Note 2: 50 Hz Systems – This device requires an input of 230/400V ± 10%, 50 Hz ± 2%, 3-phase, 4-wire plus ground and is supplied with a 5-terminal pressure connector block and 25 ft (7.5m) of 5-conductor wire. Male caps and receptacles are not supplied by DEC. A 10A circuit is recommended for this type of service.

KA10
ARITHMETIC PROCESSOR

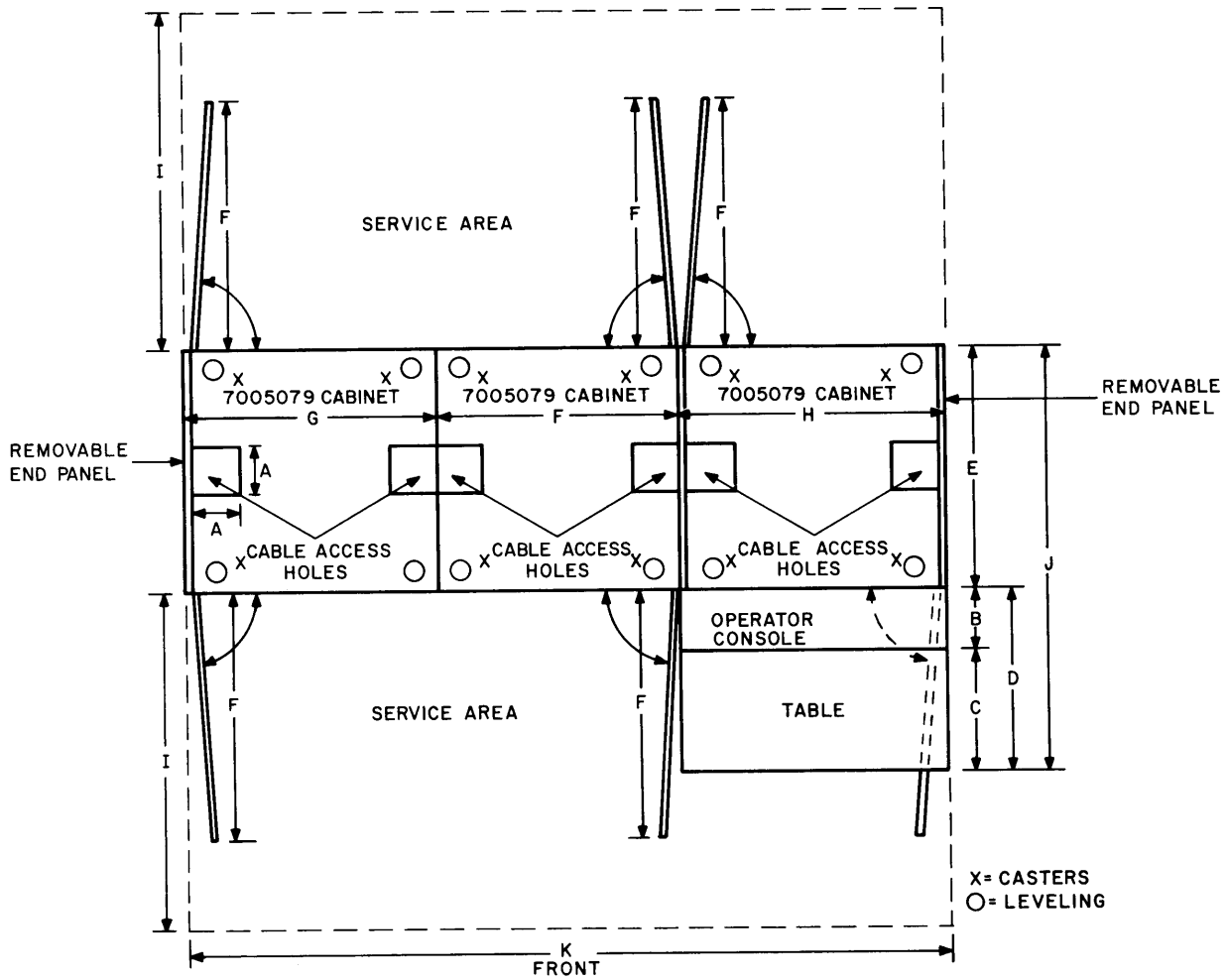

DIMENSIONS	A	B	C	D	E	F	G	H	I	J	K
INCHES	6.0	7.3	15.0	22.3	28.0	31.0	31.8	33.8	42.0	49.5	96.5
METERS	0.15	0.18	0.38	0.56	0.71	0.79	0.80	0.86	1.07	1.25	2.45

10-0450

**DK10
REAL-TIME CLOCK**

DESCRIPTION

The DK10 Real-Time Clock provides the user with a precise time measurement in either the Executive mode, User mode, or Real-Time mode.

It contains an internal crystal clock with a frequency of 100 kHz \pm .01%.

The DK10 may also use an external clock having a frequency of up to 400 kHz.

The DK10 can be mounted in place of a TU55 DECTape Transport or in the lower portion of the TD10B Expander cabinet.

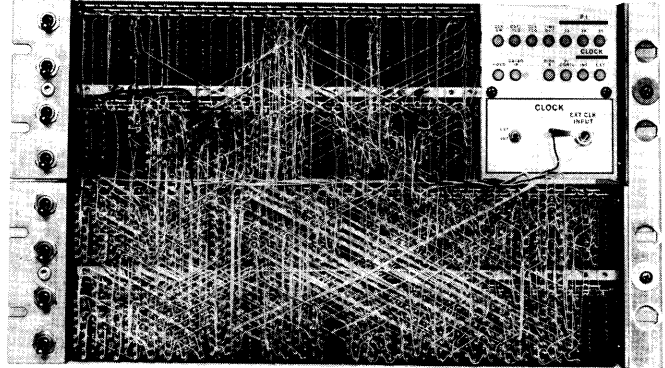

INSTALLATION DATA

Voltage	Current	Power/Heat Dissipation	Dimensions			Weight	Operating Temperature	Storage Temperature	Relative Humidity	Maximum Cable Length		
			Height	Width	Depth					I/O	Memory	Device
See Note 1	0.5A @ + 10Vdc 2.0A @ -15 Vdc	35W 120 Btu/hr	10.5 in. 0.27m	19.0 in. 0.48m	6.5 in. 0.17m	25 lb 11 kg	60° to 95°F 15° to 35°C	40° to 110°F 5° to 45°C	20% to 80%	150 ft 45m	None	Processor Conditions cable 15 ft (4.5m)

Note 1: +10 Vdc and -15Vdc are provided by the TD10 DECTape Control. No ac power is required.

Note 2: The DK10 is mounted in place of a TU55 DECTape Transport or in the lower half of the TD10B cabinet.

This page intentionally left blank.

MA10 AND MA10A CORE MEMORY

DESCRIPTION

The MA10 Core Memory contains 16,384 37-bit storage locations. The MA10A Core Memory contains 8,192 37-bit storage locations. Each storage location consists of 36 data bits and 1 parity bit. Both memories have a 1 μ s cycle time. The KA10 Arithmetic Processor can directly access up to 262,144 words of core memory.

A memory bus connects the processor to each memory via one of four MC10 memory ports. Up to four processors can access any one memory.

The first memory module should be within 3 ft (0.91m) of the left side of the KA10 in order to realize published instruction times. Up to four MA10 Core Memory cabinets may be bolted together with short interconnecting cables routed inside the cabinets.

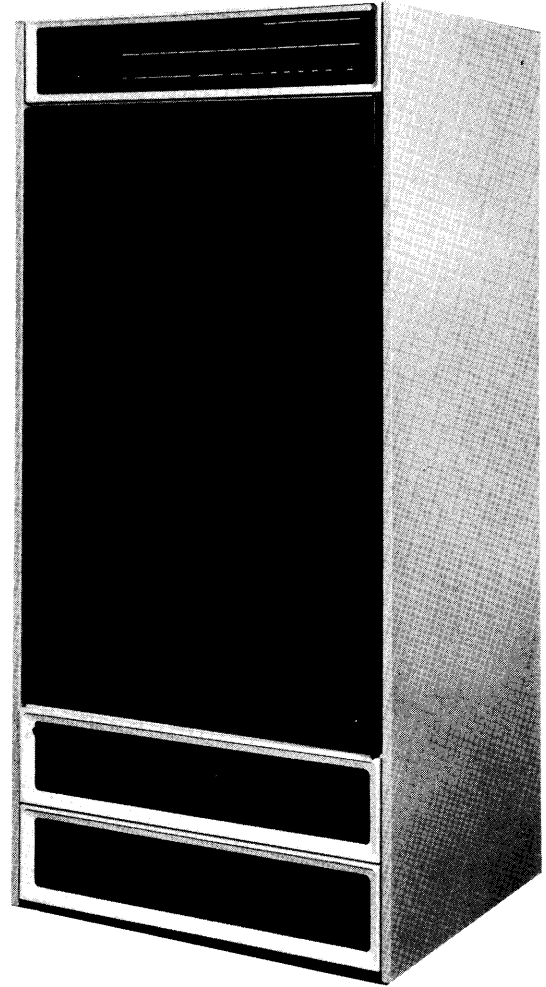

INSTALLATION DATA

Voltage	Current @ 115 Vac	Power/Heat Dissipation	Dimensions			Weight	Operating Temperature	Storage Temperature	Relative Humidity	Maximum Cable Length		
			Height	Width	Depth					I/O	Memory	Device
See Notes 1 and 2	15A Surge: 24A	1600W 5400 Btu/hr	69 in. 1.75m	32.5 in. 0.84m	28 in. 0.71m	750 lb 340 kg	60° to 95°F 15° to 35°C	40° to 110°F 5° to 45°C	20% to 80%	None	100 ft 30m	None

Note 1: 60 Hz Systems – This device requires an input of 115V \pm 10%, 60 Hz \pm 2%, single phase, 2-wire plus ground and is supplied with 25 ft (7.5m) of 3-conductor wire and a Hubbell #3331 cord cap (male plug) which mates with a Hubbell #3330 receptacle. A 30A circuit is recommended for this type of service.

Note 2: 50 Hz Systems – This device requires an input of 230V \pm 10%, 50 Hz \pm 2%, single phase, 2-wire plus ground and is supplied with a 3-terminal pressure connector block and 25 ft (7.5m) of 3-conductor wire. Male caps and receptacles are not supplied by DEC. A 15A circuit is recommended for this type of service.

**MA10 AND MA10A
CORE MEMORY**

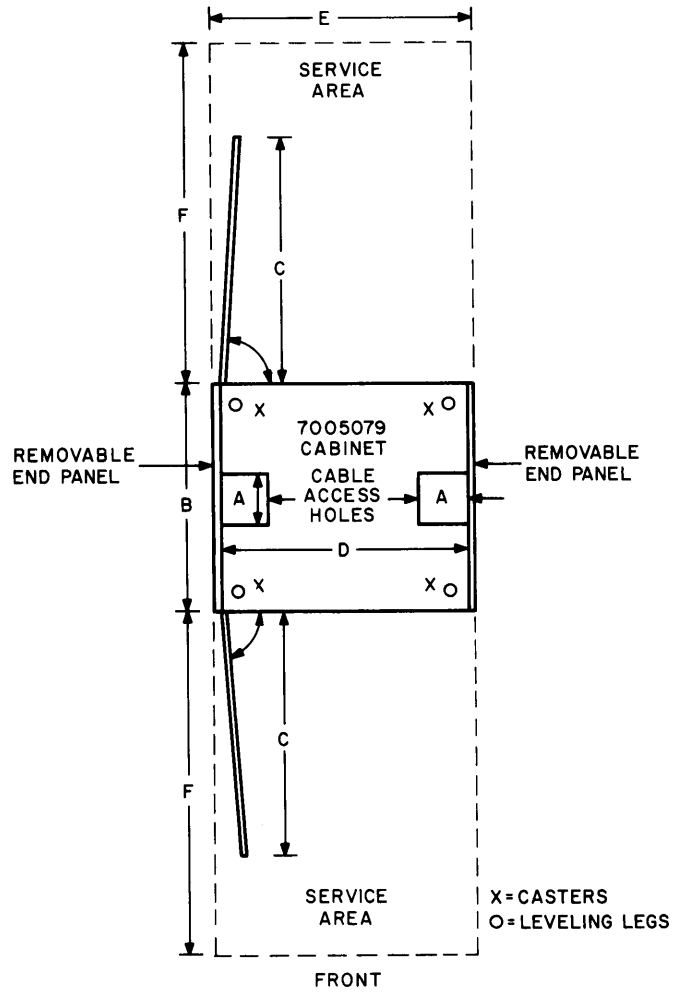

DIMENSIONS	A	B	C	D	E	F
INCHES	6.0	28.0	31.0	31.0	32.5	42.0
METERS	0.15	0.71	0.79	0.79	0.84	1.07

10-0451

**MB10
CORE MEMORY
(manufacture discontinued)**

DESCRIPTION

The MB10 Core Memory contains 16,384 37-bit storage locations. Each location contains 36 data bits and 1 parity bit. The KA10 Arithmetic Processor can directly access 262,144 words of core memory. The MB10 has a 1.65 μ s cycle time.

A memory bus connects the processor to each memory via one of four MC10 memory ports. Up to four processors can access any one memory. Up to four MB10 Core Memory cabinets can be bolted together with short interconnecting cables routed inside the cabinets.

Optimum timing and cabling simplicity require that the MB10 memories be located on the end of the memory bus in systems containing both MA10 and MB10 Core Memories. In systems using only MB10s, the first memory unit must be within 3 ft (0.91m) of the left side of the KA10 in order to realize published instruction times.

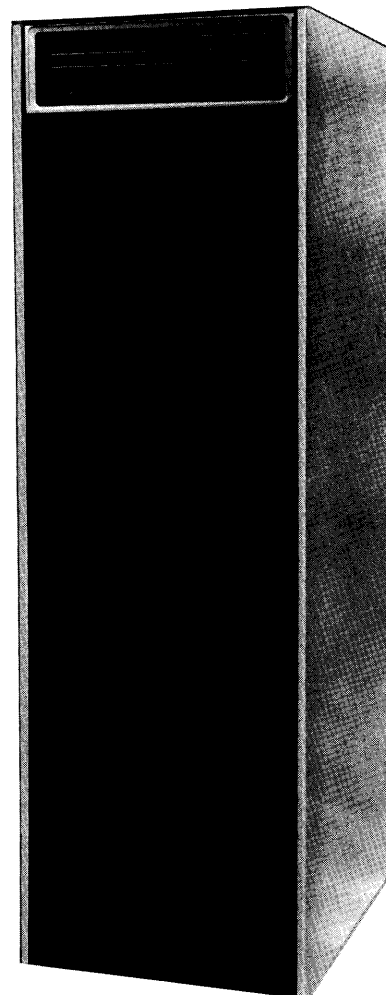

INSTALLATION DATA

Voltage	Current @ 115 Vac	Power/Heat Dissipation	Dimensions				Operating Temperature	Storage Temperature	Relative Humidity	Maximum Cable Length		
			Height	Width	Depth	Weight				I/O	Memory	Device
See Notes 1 and 2	11A Surge: 15A	1200W 4000 Btu/hr	69 in. 1.75m	22 in. 0.56m	29 in. 0.72m	560 lb 260 kg	60° to 95°F 15° to 35°C	40° to 110°F 5° to 45°C	20% to 80%	None	100 ft 30m	None

Note 1: 60 Hz Systems – This device requires an input of 115V \pm 10%, 60 Hz \pm 2%, single phase, 2-wire plus ground and is supplied with 25 ft (7.5m) of 3-conductor wire and a Hubbell #3331 cord cap (male plug) which mates with a Hubbell #3330 receptacle. A 30A circuit is recommended for this type of service.

Note 2: 50 Hz Systems – This device requires an input of 230V \pm 10%, 50 Hz \pm 2%, single phase, 2-wire plus ground and is supplied with a 3-terminal pressure connector block and 25 ft (7.5m) of 3-conductor wire. Male caps and receptacles are not supplied by DEC. A 15A circuit is recommended for this type of service.

**MB10
CORE MEMORY**

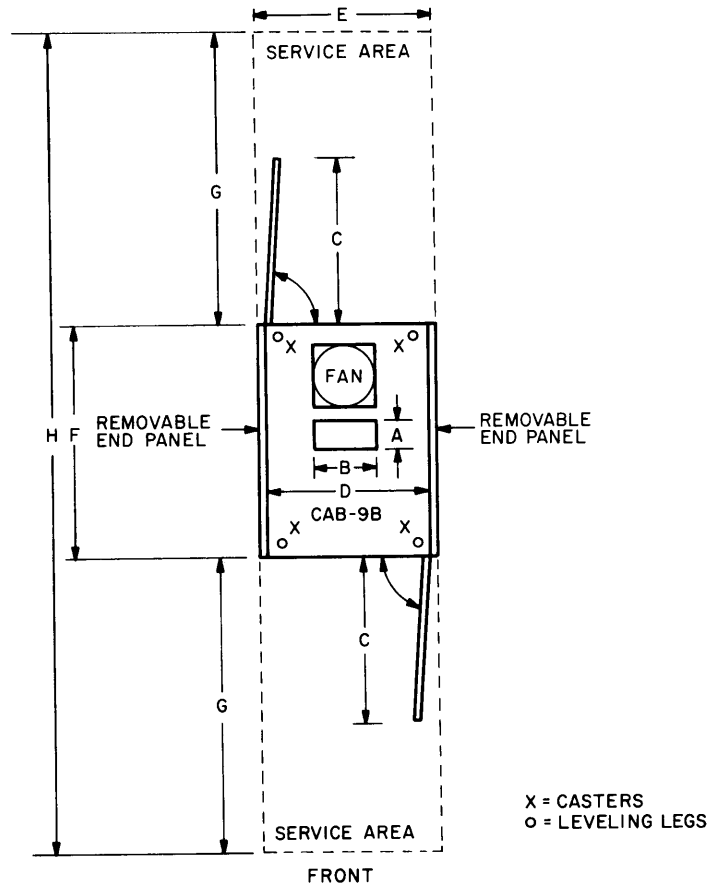

DIMENSIONS	A	B	C	D	E	F	G	H
INCHES	3.5	7.0	19.3	20.3	22.0	29.0	36.0	100
METERS	0.09	0.18	0.49	0.52	0.54	0.72	0.90	2.50

10-0452

**MD10
CORE MEMORY**

DESCRIPTION

The basic MD10 Core Memory Unit has a storage capacity of 32,768 37-bit words. It has a cycle time of 1.8 μ s and a read access time of 800 ns.

The MD10 Core Memory Unit can be expanded in 32K increments up to 128K words. The expansion modules, designated MD10E, are housed in the MD10 cabinet.

The MD10 is supplied with one BS10A cable set to gain access to one of four access ports. Access to the remaining three ports is achieved by installing another BS10A cable set for each port.

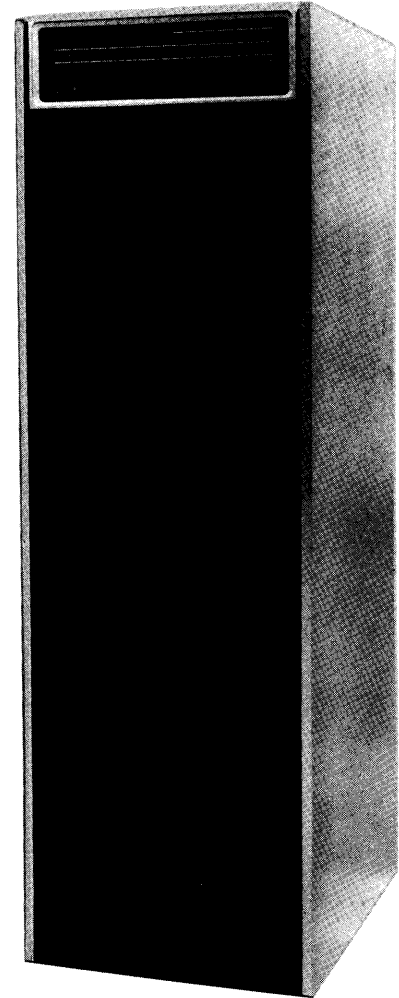

INSTALLATION DATA

Voltage	Current @ 115 Vac	Power/Heat Dissipation	Dimensions			Weight	Operating Temperature	Storage Temperature	Relative Humidity	Maximum Cable Length		
			Height	Width	Depth					I/O	Memory	Device
See Notes 1 and 2	12A Surge: 20A	1150W 3900 Btu/hr	72 in. 1.83m	22 in. 0.56m	30 in. 0.76m	600 lb 280 kg	60° to 95°F 15° to 35°C	40° to 110°F 5° to 45°C	20% to 80%	None	100 ft 30m	None

Note 1: 60 Hz Systems – This device requires an input of 115V \pm 10%, 60 Hz \pm 2%, single-phase, 2-wire plus ground and is supplied with 25 ft (7.6m) of 3-conductor wire and a Hubbell #3331 cord cap (male plug) which mates with a Hubbell #3330 receptacle. A 30A circuit is recommended for this type of service.

Note 2: 50 Hz Systems – This device requires an input of 230V \pm 10%, 50 Hz \pm 2%, single-phase, 2-wire plus ground and is supplied with a 3-terminal pressure connector block and 25 ft (7.5m) of 3-conductor wire. Male caps and receptacles are not supplied by DEC. A 15A circuit is recommended for this type of service.

**MD10
CORE MEMORY**

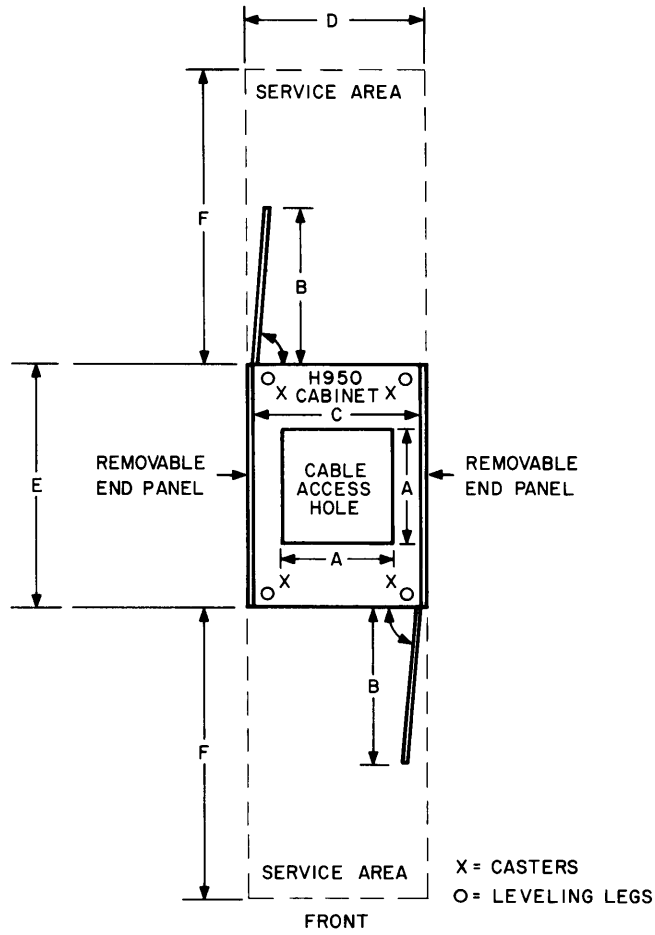

DIMENSIONS	A	B	C	D	E	F
INCHES	14.0	19.0	20.5	22.0	30.0	36.0
METERS	0.36	0.48	0.52	0.56	0.76	0.91

10-0470

**MX10
MEMORY DATA MULTIPLEXOR**

DESCRIPTION

The MX10 Memory Data Multiplexor is a PDP-10 option which permits up to eight I/O processors, such as the DF10 Data Channel, to access one of the four ports within the PDP-10 Memories.

The MX10 is usually housed in a DF10 Data Channel cabinet.

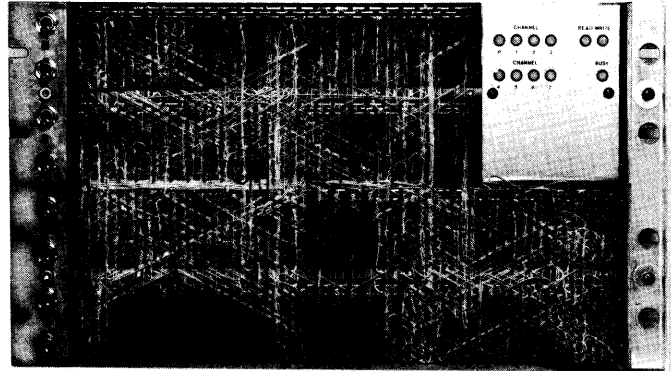

INSTALLATION DATA

Voltage	Current	Power/Heat Dissipation	Dimensions			Weight	Operating Temperature	Storage Temperature	Relative Humidity	Maximum Cable Length		
			Height	Width	Depth					I/O	Memory	Multiplexer
See Note 1	0.5A @ +10 Vdc 3.0A @ -15 Vdc	50W 170 Btu/hr	10.5 in. 0.27m	19.0 in. 0.48m	6.5 in. 0.17m	25 lb 11 kg	60° to 95°F 15° to 35°C	40° to 110°F 5° to 45°C	20% to 80%	None	100 ft 30m	100 ft 30m
											(See Note 2)	

Note 1: This device is normally housed in the DF10 Data Channel cabinet which supplies dc power to the unit.

Note 2: Refer to Cabling Considerations, PDP-10 Memory Buses.

This page intentionally left blank.

**DF10
DATA CHANNEL**

DESCRIPTION

The DF10 Data Channel controls high speed data transfers between external devices and the PDP-10 Memory independent of the arithmetic processor.

The DF10 is an I/O processor which allows block transfers, scatter transfers, and jump-type operations. It is capable of servicing up to sixteen external devices.

The DF10 is used with the RP10 Disk Pack System, the RD10 Fixed Head Disk System, the RM10B Fixed Head Drum System, and the TM10B Magnetic Tape System.

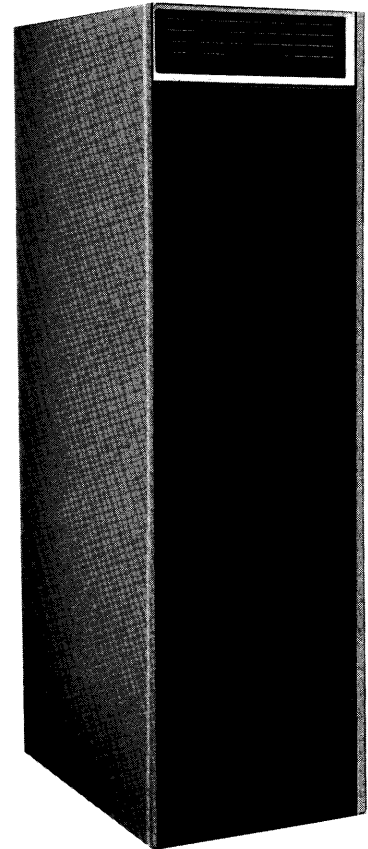

INSTALLATION DATA

Voltage	Current @ 115 Vac	Power/Heat Dissipation	Dimensions				Operating Temperature	Storage Temperature	Relative Humidity	Maximum Cable Length		
			Height	Width	Depth	Weight				I/O	Memory	Channel
See Notes 1 and 2	5A Surge: 12A	550W 1900 Btu/hr	69 in. 1.75m	22 in. 0.56m	29 in. 0.72m	450 lb 200 kg	60° to 95°F 15° to 35°C	40° to 110°F 5° to 45°C	20% to 80%	None	100 ft 30m	100 ft 30m

Note 1: 60 Hz Systems – This device requires an input of 115V ± 10%, 60 Hz ± 2%, single phase, 2-wire plus ground and is supplied with 25 ft (7.5m) of 3-conductor wire and a Hubbell #3331 cord cap (male plug) which mates with a Hubbell #3330 receptacle. A 30A circuit is recommended for this type of service.

Note 2: 50 Hz Systems – This device requires an input of 230V ± 10%, 50 Hz ± 2%, single phase, 2-wire plus ground and is supplied with a 3-terminal pressure connector block and 25 ft (7.5m) of 3-conductor wire. Male caps and receptacles are not supplied by DEC. A 15A circuit is recommended for this type of service.

**DF10
DATA CHANNEL**

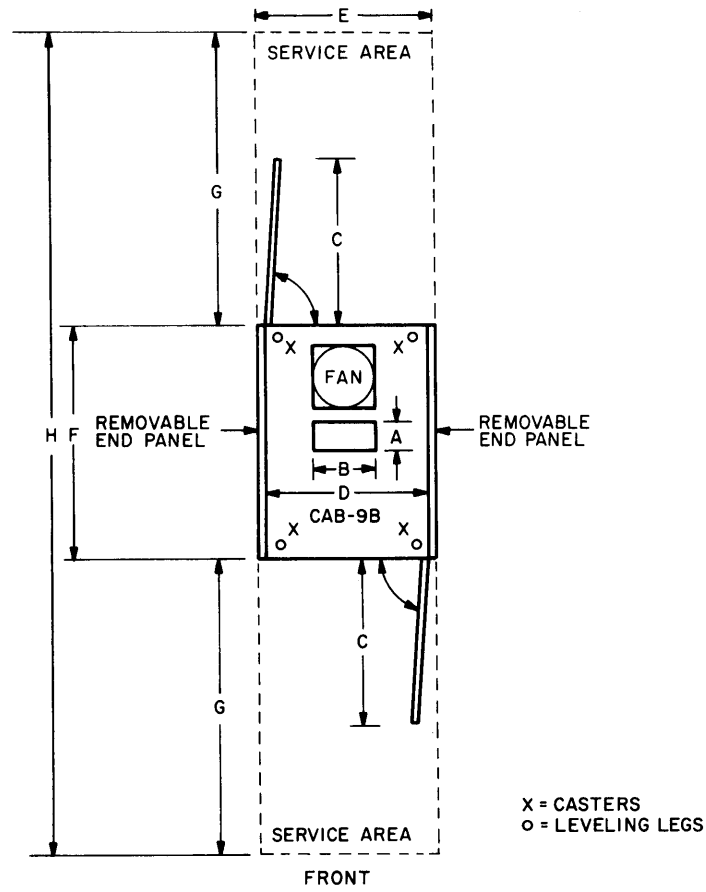

DIMENSIONS	A	B	C	D	E	F	G	H
INCHES	3.5	7.0	19.3	20.3	22.0	29.0	36.0	100
METERS	0.09	0.18	0.49	0.52	0.54	0.72	0.90	2.50

10-0452

**RC10
DISK CONTROL**

DESCRIPTION

The RC10 Disk Control is used to control the RD10 Fixed Head Disk or RM10B Fixed Head Drum. It will control a maximum of four RD10s and RM10Bs (used in any combination).

The RC10 Disk Control interfaces with the PDP-10 I/O Bus, the DF10 Data Channel, and the storage devices.

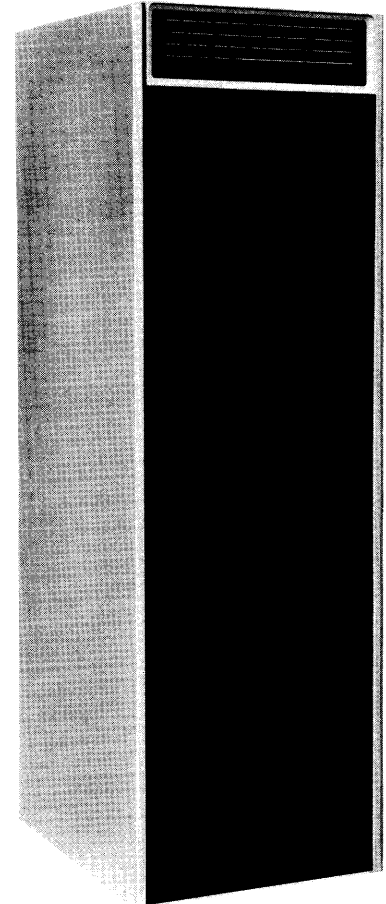

INSTALLATION DATA

Voltage	Current @ 115 Vac	Power/Heat Dissipation	Dimensions			Weight	Operating Temperature	Storage Temperature	Relative Humidity	Maximum Cable Length		
			Height	Width	Depth					I/O	Memory	Channel
See Notes 1 and 2	5.5A Surge: 9A	650W 2200 Btu/hr	69 in. 1.75m	22 in. 0.56m	29 in. 0.72m	350 lb 160 kg	60° to 95°F 15° to 35°C	40° to 110°F 5° to 45°C	20% to 80%	150 ft 45m	None	100 ft 30m

Note 1: 60 Hz Systems -- This device requires an input of 115V ± 10%, 60 Hz ± 2%, single phase, 2-wire plus ground and is supplied with 25 ft (7.5m) of 3-conductor wire and a Hubbell #3331 cord cap (male plug) which mates with a Hubbell #3330 receptacle. A 30A circuit is recommended for this type of service.

Note 2: 50 Hz Systems -- This device requires an input of 230V ± 10%, 50 Hz ± 2%, single phase, 2-wire plus ground and is supplied with a 3-terminal pressure connector block and 25 ft (7.5m) of 3-conductor wire. Male caps and receptacles are not supplied by DEC. A 15A circuit is recommended for this type of service.

RC10
DISK CONTROL

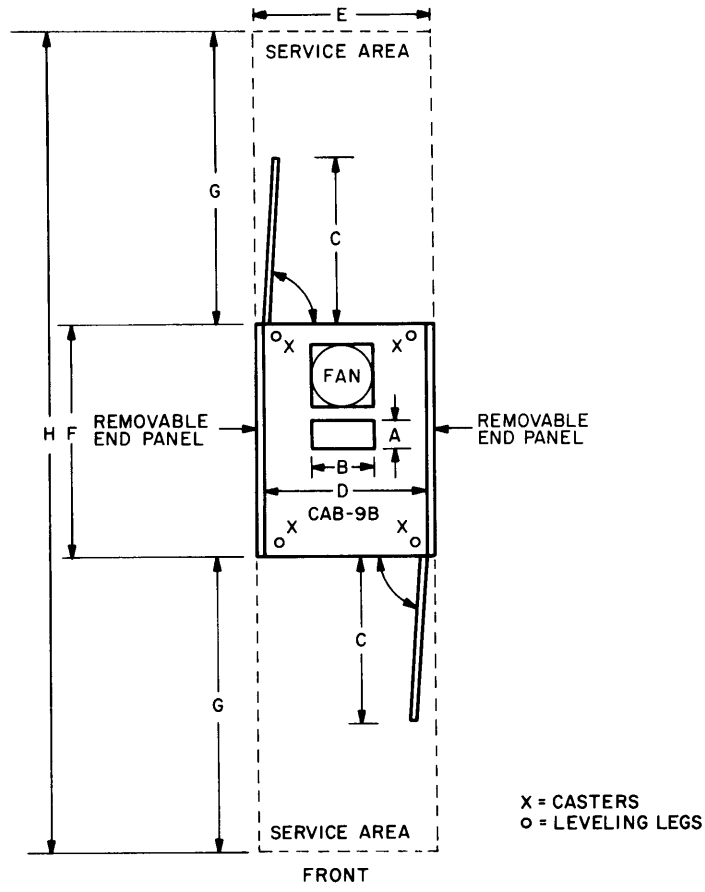

X = CASTERS
O = LEVELING LEGS

DIMENSIONS	A	B	C	D	E	F	G	H
INCHES	3.5	7.0	19.3	20.3	22.0	29.0	36.0	100
METERS	0.09	0.18	0.49	0.52	0.54	0.72	0.90	2.50

10-0452

**RM10B
FIXED HEAD DRUM**

DESCRIPTION

The RM10B Fixed Head Drum is a high-speed, random-access storage device, especially suited for applications demanding minimum access time and a high data transfer rate.

The recording surface of the drum is formatted into 90 tracks; each track is divided into 61 sectors of 64 36-bit words.

Each RM10B has a program-accessible storage capacity of 345,600 36-bit words.

The RM10B Fixed Head Drum and the RD10 Fixed Head Disk operate under the control of the RC10 Disk Control, which may service up to four of these storage devices, used in any combination.

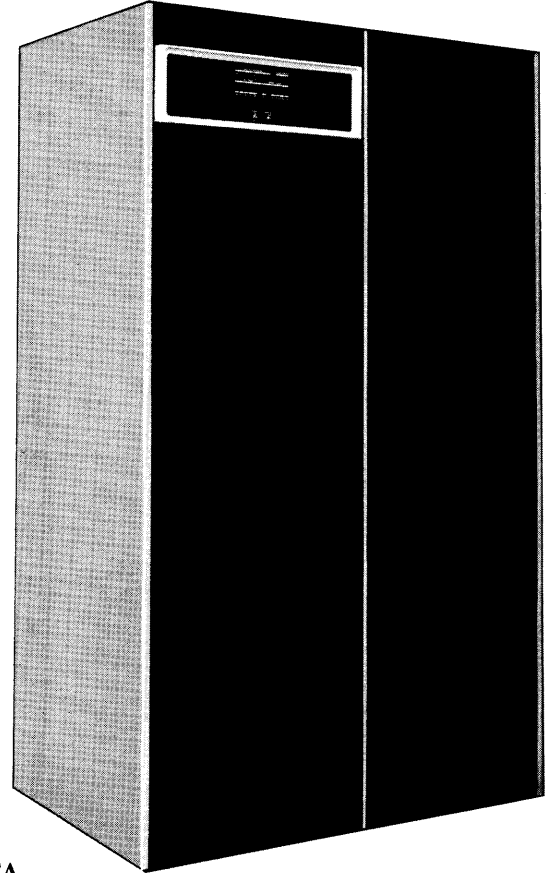

INSTALLATION DATA

Voltage	Current @ 115 Vac	Power/Heat Dissipation	Dimensions			Weight	Operating Temperature	Storage Temperature	Relative Humidity	Maximum Cable Length		
			Height	Width	Depth					I/O	Memory	Device
See Notes 1, 2, and 3	7A, phase 1 1.5A, phase 2 1.5A, phase 3 Surge: 15A/phase	1100W 4000 Btu/hr	72 in. 1.83m	43 in. 1.09m	30 in. 0.76m	950 lb 400 kg	60° to 90°F 15° to 32°C	40° to 110°F 5° to 45°C	20% to 80%	None	None	25 ft 7.5m

Note 1: 60 Hz Systems – This device requires an input of 115/200V ± 10%, 60 Hz ± 2%, 3-phase, 4-wire plus ground and is supplied with 25 ft (7.5m) of 5-conductor wire and a Hubbell #3521 cord cap (male plug) which mates with a Hubbell #3520 receptacle. A 20A circuit is recommended for this type of service.

Note 2: 50 Hz Systems – This device requires an input of 230/400V ± 10%, 50 Hz ± 2%, 3-phase, 4-wire plus ground and is supplied with a 5-terminal pressure connector block and 25 ft (7.5m) of 5-conductor wire. Male caps and receptacles are not supplied by DEC. A 10A circuit is recommended for this type of service.

Note 3: System phase unbalance should be corrected by rotating the phase sequence of this and other unbalanced loads.

**RM10B
FIXED HEAD DRUM**

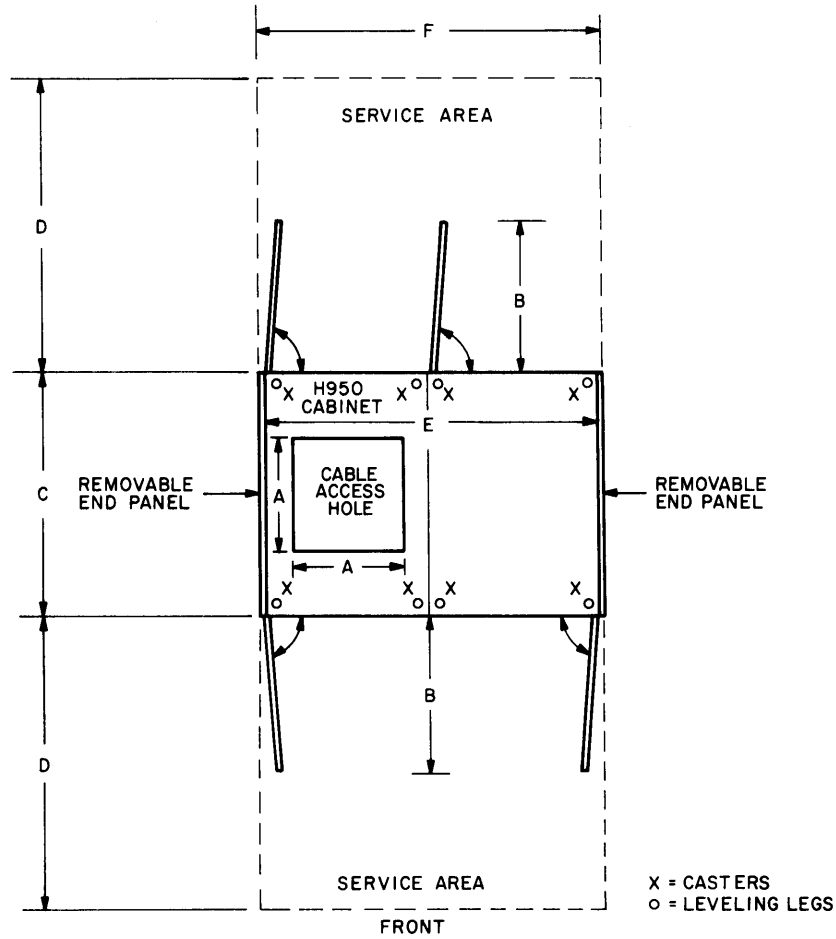

DIMENSIONS	A	B	C	D	E	F
INCHES	14.0	19.0	30.0	36.0	41.0	43.0
METERS	0.36	0.48	0.76	0.91	1.06	1.09

10-0468

**RD10
FIXED HEAD DISK**

DESCRIPTION

The RD10 Fixed Head Disk has a storage capacity of 512,000 36-bit words. The disk surface is organized in 200 tracks; each track is divided into 80 segments, each containing 32 words. Error checking is performed on each segment.

The RD10 Fixed Head Disk operates under control of the RC10 Disk Control.

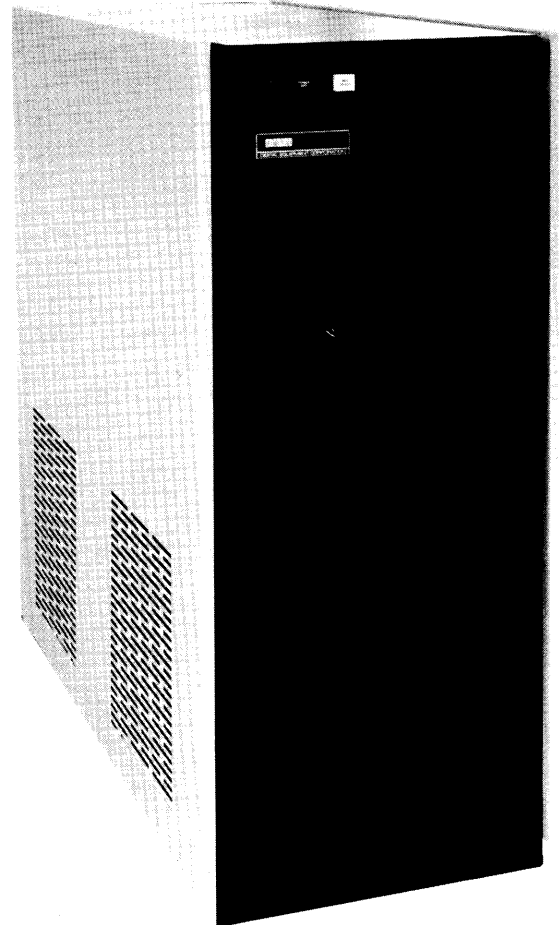

INSTALLATION DATA

Voltage	Current	Power/Heat Dissipation	Dimensions			Weight	Operating Temperature	Storage Temperature	Relative Humidity	Maximum Cable Length		
			Height	Width	Depth					I/O	Memory	Device
See Note 1	See Note 1	800W 2700 Btu/hr	45 in. 1.14m	22 in. 0.56m	45 in. 1.14m	225 lb 100 kg	60° to 95°F 15° to 35°C	40° to 110°F 5° to 45°C	20% to 80%	None	None	25 ft 7.5m

Note 1: 60 Hz versions of this device operate from phase 1 and 2 of a 115/200V ± 10%, 60 Hz ± 1 Hz, 3-phase, 4-wire plus ground power source. The RD10 requires 4A (12A surge) from each phase. When two or more RD10 Disks are used, the phases should be rotated at the receptacles to balance the electrical load. The device is supplied with 25 ft (7.5m) of 5-conductor wire and a Hubbell #3521 cord cap (male plug) which mates with a Hubbell #3520 receptacle. A 20A circuit is recommended. 50 Hz versions of this device operate from a 230V ± 10%, 50 Hz ± 1 Hz, single-phase, 2-wire plus ground power source and require 3.5A (10A surge). The device is supplied with 25 ft (7.5m) of 3-conductor wire. Male caps and receptacles are not supplied by DEC. A 10A circuit is recommended.

**RD10
FIXED HEAD DISK**

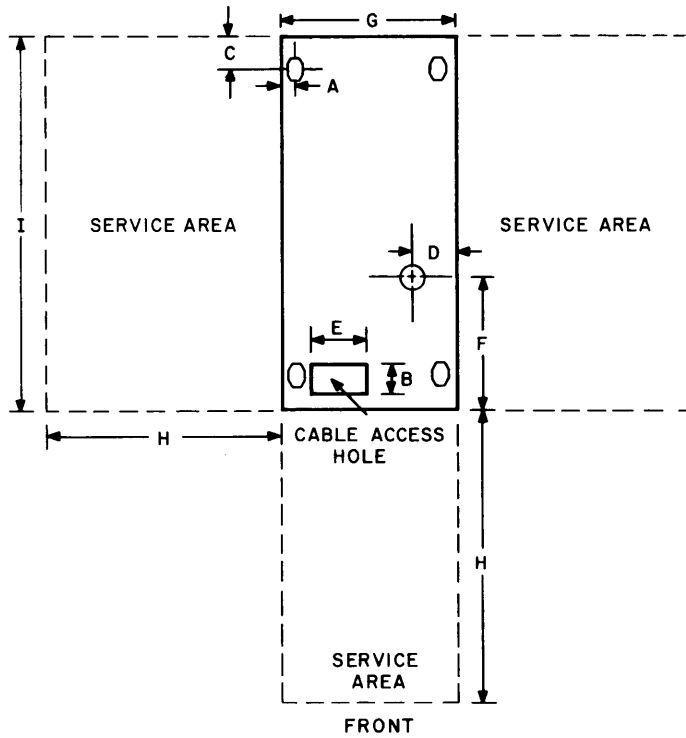

DIMENSIONS	A	B	C	D	E	F	G	H	I
INCHES	1.0	3.5	4.0	5.0	6.5	16.5	21.0	30.0	46.0
METERS	0.02	0.09	0.11	0.13	0.16	0.42	0.53	0.76	1.17

10-0453

**RP10
DISK PACK CONTROL**

DESCRIPTION

The RP10 Disk Pack Control will control any combination of up to eight RP01 and RP02 Disk Pack Drives. The RP10 Disk Pack System provides an on-line, random access, economical, expandable file storage medium.

The RP10 interfaces with the PDP-10 I/O Bus, the DF10 Data Channel, and the RP01 or RP02 Disk Pack Drives.

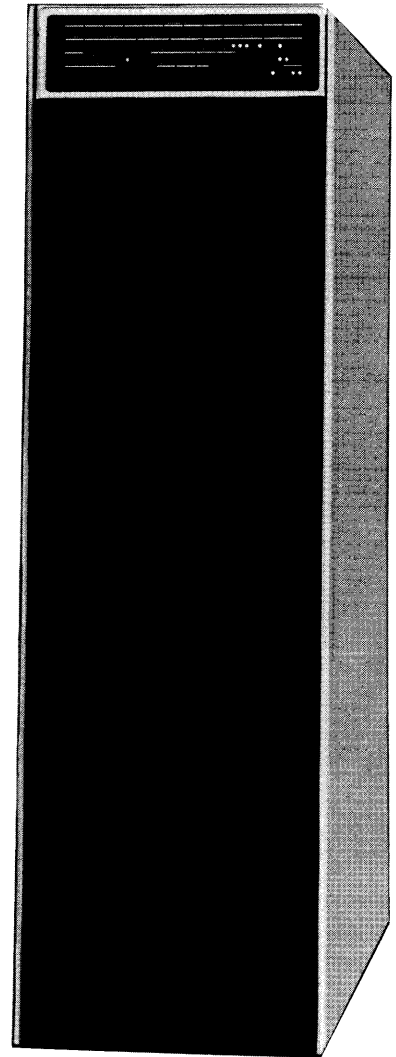

INSTALLATION DATA

Voltage	Current @ 115 Vac	Power/Heat Dissipation	Dimensions			Weight	Operating Temperature	Storage Temperature	Relative Humidity	Maximum Cable Length		
			Height	Width	Depth					I/O	Channel	Device
See Notes 1 and 2	8A Surge: 15A	900W 3000 Btu/hr	69 in. 1.75m	22 in. 0.56m	29 in. 0.72m	500 lb 230 kg	60° to 95°F 15° to 35°C	40° to 110°F 5° to 45°C	20% to 80%	150 ft 45m	100 ft 30m	See RP10 Cabling Req.

Note 1: 60 Hz Systems – This device requires an input of 115V ± 10%, 60 Hz ± 2%, single phase, 2-wire plus ground and is supplied with 25 ft of 3-conductor wire and a Hubbell #3331 cord cap (male plug) which mates with a Hubbell #3330 receptacle. A 30A circuit is recommended for this type of service.

Note 2: 50 Hz Systems – This device requires an input of 230V ± 10%, 50 Hz ± 2%, single phase, 2-wire plus ground and is supplied with a 3-terminal pressure block and 25 ft (7.5m) of 3-conductor wire. Male caps and receptacles are not supplied by DEC. A 15A circuit is recommended for this type of service.

**RP10
DISK PACK CONTROL**

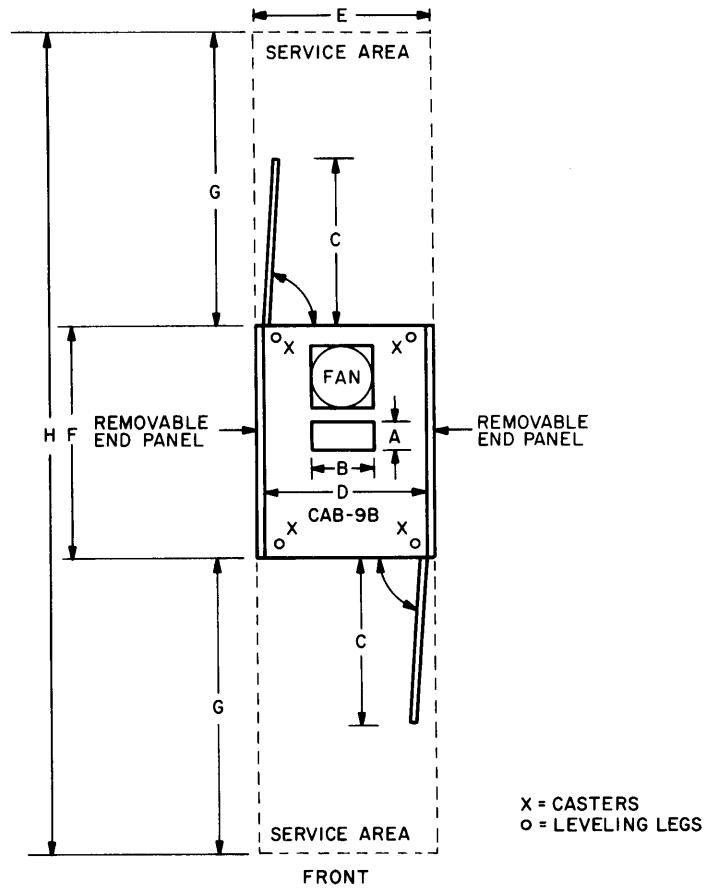

DIMENSIONS	A	B	C	D	E	F	G	H
INCHES	3.5	7.0	19.3	20.3	22.0	29.0	36.0	100
METERS	0.09	0.18	0.49	0.52	0.54	0.72	0.90	2.50

10-0452

**RP10
DISK PACK CONTROL**

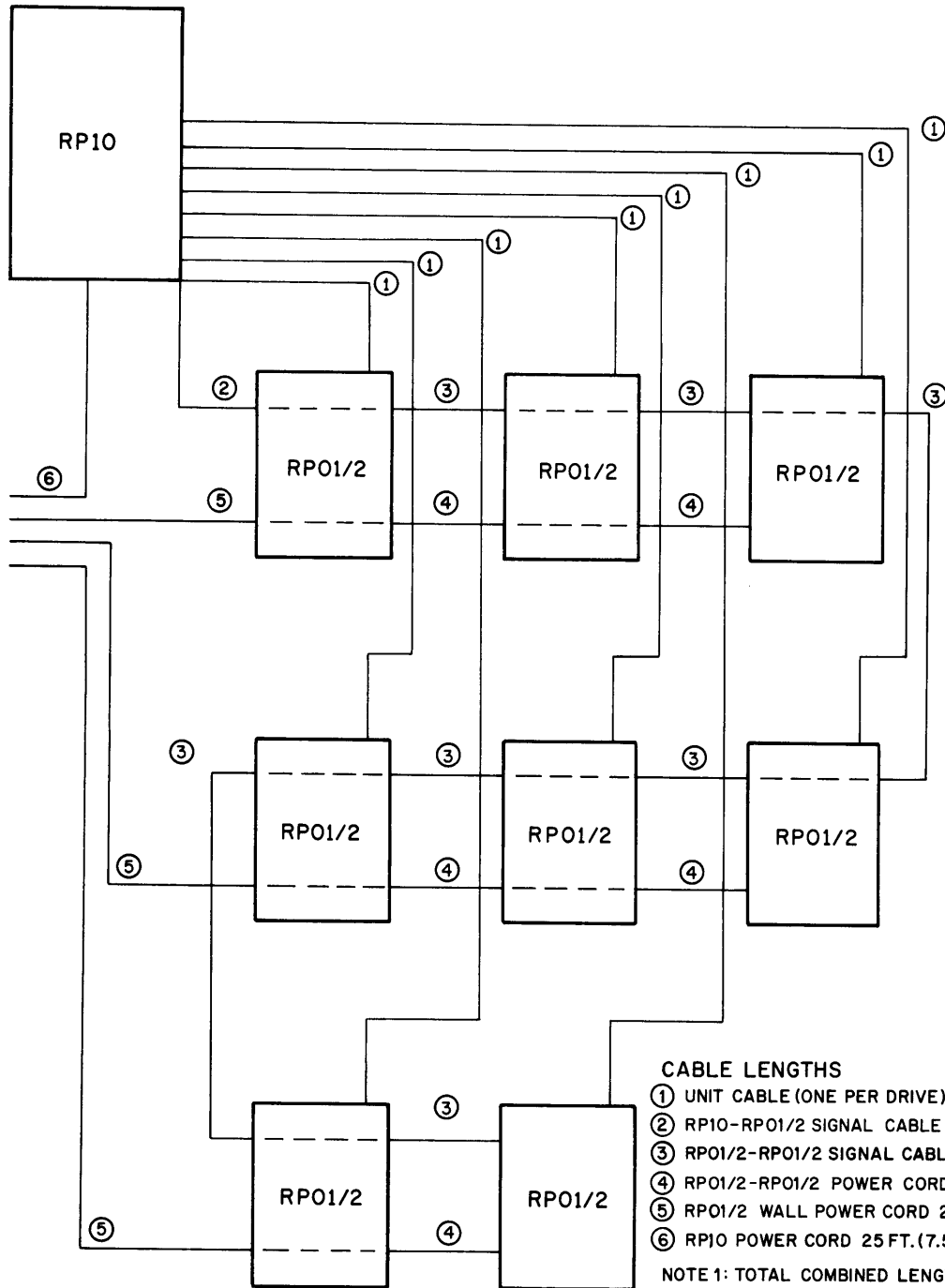

CABLE LENGTHS

- ① UNIT CABLE (ONE PER DRIVE) 15 FT. (4.5 m) OR 40 FT. (12 m)
- ② RP10-RP01/2 SIGNAL CABLE 25 FT. (7.5 m)
- ③ RP01/2-RP01/2 SIGNAL CABLE 8 FT. (3.6 m) OR 25 FT. (7.5 m)
- ④ RP01/2-RP01/2 POWER CORD 8 FT. (3.6 m) OR 25 FT. (7.5 m)
- ⑤ RP01/2 WALL POWER CORD 25 FT. (7.5 m)
- ⑥ RP10 POWER CORD 25 FT. (7.5 m)

NOTE 1: TOTAL COMBINED LENGTHS OF 2,3 CANNOT EXCEED 100 FT. (30 m)

NOTE 2: ALL RP10 SYSTEM POWER CORDS MUST BE PLUGGED IN SOCKETS LOCATED PHYSICALLY AND ELECTRICALLY NEAR EACH OTHER.

NOTE 3: ONE WALL POWER CORD IS REQUIRED FOR EACH GROUP OF 3 RP01/2's

10-0437

This page intentionally left blank.

**RP01
DISK PACK DRIVE**

DESCRIPTION

The RP01 Disk Pack Drive provides a storage capacity of 1,300,000 words per disk pack. It operates under the control of the RP10 Disk Pack Control.

The RP10 Disk Pack System provides an economical, on-line, random access, expandable file storage medium.

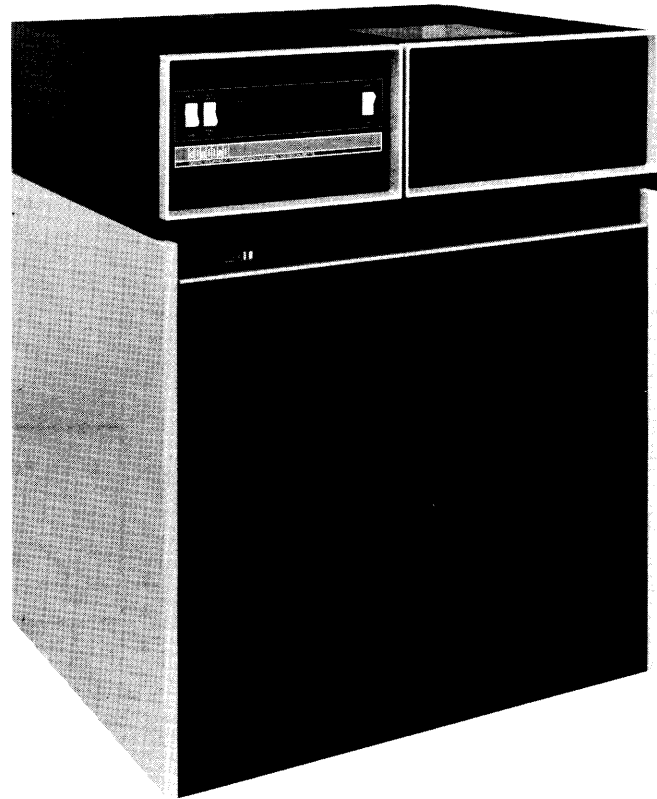

INSTALLATION DATA

Voltage	Current @ 115 Vac	Power/Heat Dissipation	Dimensions			Weight	Operating Temperature	Storage Temperature	Relative Humidity	Maximum Cable Length		
			Height	Width	Depth					I/O	Memory	Device
See Notes 1 and 2	See Note 3	1000W 3500 Btu/hr	38 in. 0.97m	30 in. 0.76m	24 in. 0.61m	300 lb 140 kg	60° to 90°F 15° to 32°C	40° to 100°F 5° to 38°C	10% to 80%	None	None	See RP10 Cabling Req.

Note 1: 60 Hz Systems – Each group of three or fewer drives require an input of 115/200V ± 10%, 60 Hz ± 2%, 3-phase, 4-wire plus ground and is supplied with 25 ft (7.5m) of 5-conductor wire and a Hubbell #3521 cord cap (male plug) which mates with a Hubbell #3520 receptacle. A 20A circuit is recommended for this type of service.

Note 2: 50 Hz Systems – Each group of three or fewer drives require an input of 230/400V ± 10%, 50 Hz ± 2%, 3-phase, 4-wire plus ground and is supplied with 25 ft (7.5m) of 5-conductor wire. The black, red, and yellow wires should be connected to phases 1, 2, and 3. The white wire should be connected to the neutral. The green wire should be connected to frame ground. Male caps and receptacles are not supplied by DEC. A 10A circuit is recommended for this type of service.

Note 3: Total Current Requirements (nominal)

1 to 3 drives: 8A/phase	7 to 8 drives: 23A/phase
4 to 6 drives: 16A/phase	Surge current: 25A/drive

**RP01
DISK PACK DRIVE**

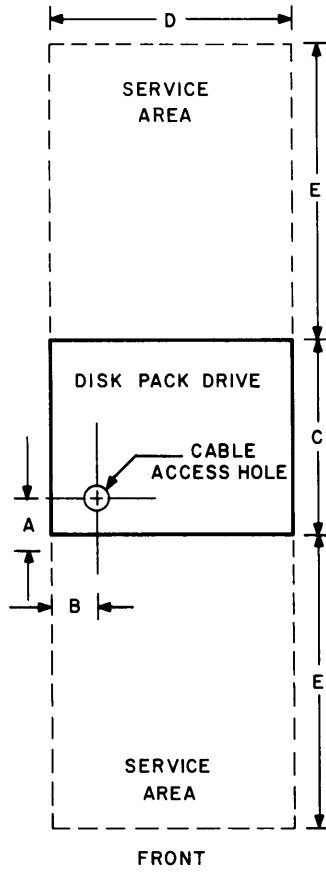

DIMENSIONS	A	B	C	D	E
INCHES	4.5	5.5	24.0	30.0	36.0
METERS	0.11	0.14	0.61	0.76	0.91

10-0454

**RP02
DISK PACK DRIVE**

DESCRIPTION

The RP02 Disk Pack Drive provides a storage capacity of 5,100,000 words per disk pack. It operates under the control of the RP10 Disk Pack Control.

The RP10 Disk Pack System provides an economical, on-line, random access, expandable file storage medium.

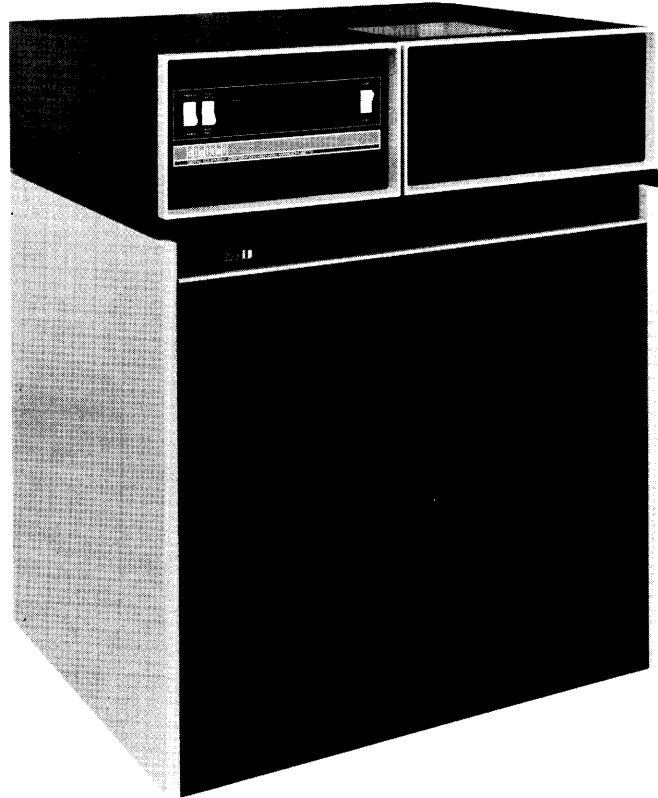

INSTALLATION DATA

Voltage	Current @ 115 Vac	Power/Heat Dissipation	Dimensions			Weight	Operating Temperature	Storage Temperature	Relative Humidity	Maximum Cable Length		
			Height	Width	Depth					I/O	Memory	Device
See Notes 1 and 2	See Note 3	1500W 5100 Btu/ hr	39 in. 0.99m	30 in. 0.76m	24 in. 0.61m	300 lb 140 kg	60° to 90°F 15° to 32°C	40° to 100°F 15° to 38°C	10% to 80%	None	None	See RP10 Cabling Req.

Note 1: 60 Hz Systems – Each group of three or fewer drives requires an input of 115/200V ±10%, 60 Hz ±2%, 3-phase, 4-wire plus ground and is supplied with 25 ft (7.5m) of 5-conductor wire and a Hubbell #3521 cord cap (male plug) which mates with a Hubbell #3520 receptacle. A 20A circuit is recommended for this type of service.

Note 2: 50 Hz Systems – Each group of three or fewer drives requires an input of 230/400V ±10%, 50 Hz ±2%, 3-phase, 4-wire plus ground and is supplied with 25 ft (7.5m) of 5-conductor wire. The black, red, and yellow wires should be connected to phases 1, 2, and 3. The white wire should be connected to the neutral. The green wire should be connected to frame ground. Male caps and receptacles are not supplied by DEC. A 10A circuit is recommended for this type of service.

Note 3: Total Current Requirements (nominal)

1 to 3 drives:	12A/phase	4 to 6 drives:	24A/phase
7 to 8 drives:	36A/phase	Surge current:	25A/drive

**RP02
DISK PACK DRIVE**

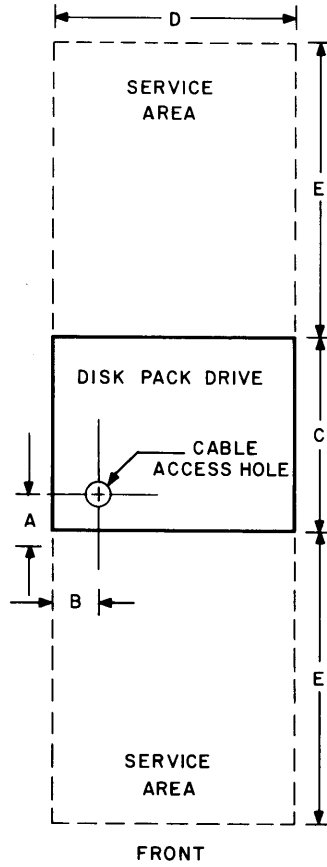

DIMENSIONS	A	B	C	D	E
INCHES	4.5	5.5	24.0	30.0	36.0
METERS	0.11	0.14	0.61	0.76	0.91

10-0454

**TD10
DECTAPE CONTROL**

DESCRIPTION

The TD10 DECTape Control can service up to eight TU55 DECTape Transports. The TD10 DECTape System is a fixed-address, magnetic tape storage system that provides random access for high-speed reading or writing of files on a 3-1/2-in. diameter, 260-ft reel of magnetic tape. Each DECTape reel can store up to 73,984 36-bit words.

Two TU55 DECTape Transports may be housed in the KA10 Arithmetic Processor, up to three in the TD10A DECTape Control cabinet, and up to three in a TD10B Expander cabinet. The TD10A has provisions for mounting an XY10 Plotter Control.

The DK10 Real-Time Clock can be mounted in place of a TU55 DECTape Transport in the TD10A cabinet, or in the lower portion of the TD10B Expander cabinet.

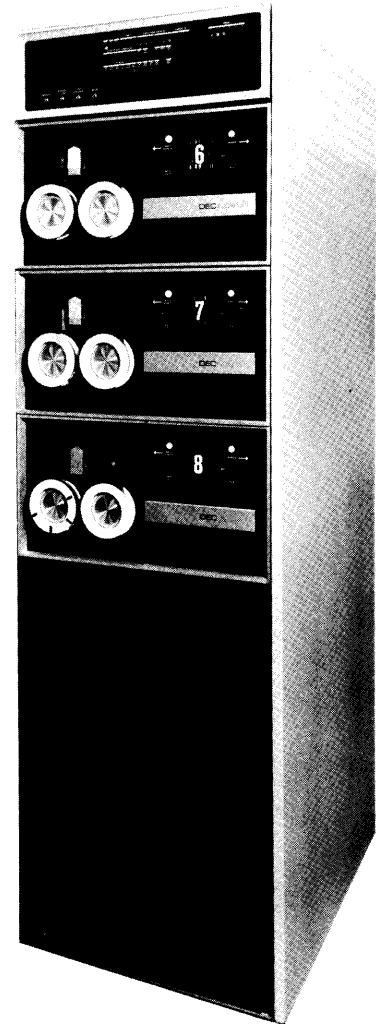

INSTALLATION DATA

Voltage	Current @ 115 Vac	Power/Heat Dissipation	Dimensions			Weight	Operating Temperature	Storage Temperature	Relative Humidity	Maximum Cable Length		
			Height	Width	Depth					I/O	Memory	Device
See Notes 1 and 2	4A Surge: 8A See Note 3	450W 1500 Btu/hr	69 in. 1.75m	22 in. 0.56m	29 in. 0.72m	350 lb 160 kg See Note 3	60° to 95°F 15° to 35°C	40° to 110°F 5° to 45°C	20% to 80%	150 ft 45m	None	35 ft 10m

- Note 1:** 60 Hz Systems – This device requires an input of 115V ± 10%, 60 Hz ± 2%, single-phase, 2-wire plus ground and is supplied with 25 ft (7.5m) of three conductor wire and a Hubbell #3331 cord cap (male plug) which mates with a Hubbell #3330 receptacle. A 30A circuit is recommended for this type of service.
- Note 2:** 50 Hz Systems – This device requires an input of 230V ± 10%, 50 Hz ± 2%, single-phase, 2-wire plus ground and is supplied with a 3-terminal pressure connector block and 25 ft (7.5m) of 3-conductor wire. Male caps and receptacles are not supplied by DEC. A 15A circuit is recommended for this type of service.
- Note 3:** The TD10A cabinet provides all power to the TU55 DECTape transports. Each TU55 weighs 40 lb (18 kg). Up to three TU55's may be mounted in the TD10A cabinet. The overall weight of each TU55 must be added to the weight of the TD10 cabinet. Eight TU55's together draw approximately 11A @ 115 Vac via the TD10A.

**TD10
DECTAPE CONTROL**

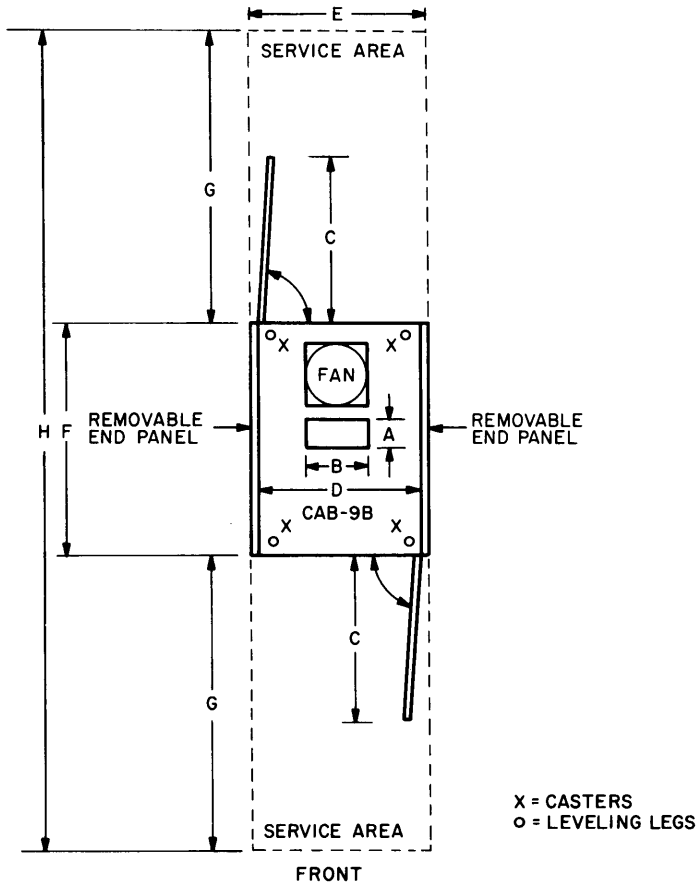

DIMENSIONS	A	B	C	D	E	F	G	H
INCHES	3.5	7.0	19.3	20.3	22.0	29.0	36.0	100
METERS	0.09	0.18	0.49	0.52	0.54	0.72	0.90	2.50

10-0452

**TU55
DECTAPE TRANSPORT**

DESCRIPTION

The TU55 DECTape Transport is a fixed head, magnetic tape storage system which provides random access for high-speed reading or writing of files on a reel of magnetic tape. A reel of magnetic tape is 3-1/2 in. in diameter and 260 ft long, and stores up to 73,984 36-bit words.

Two TU55s may be housed in the KA10 Arithmetic Processor, up to three in the TD10A DECTape Control cabinet, and up to three in a TD10B Expander cabinet.

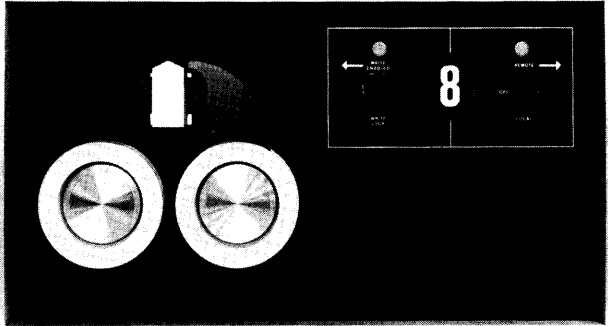

INSTALLATION DATA

Voltage	Current @ 115 Vac	Power/Heat Dissipation	Dimensions			Weight	Operating Temperature	Storage Temperature	Relative Humidity	Maximum Cable Length		
			Height	Width	Depth					I/O	Memory	Device
See Note 1	2.2A Surge: 2.5A	250W 850 Btu/hr	10.5 in. 0.27m	19 in. 0.48m	10 in. 0.25m	40 lb 18 kg	60° to 95°F 15° to 35°C	40° to 110°F 5° to 45°C	40% to 60%	None	None	35 ft 10m See Note 2

Note 1: Power is supplied by the TD10A cabinet.

Note 2: A minimum of 3 ft (1m) of cable is required between TU55's for servicing.

This page intentionally left blank.

TM10A AND TM10B MAGNETIC TAPE CONTROL

DESCRIPTION

The TM10 Magnetic Tape Control system can service any combination of up to eight TU20 or TU30 Magnetic Tape Transports. The tape transports may be either seven- or nine-channel versions, or a mixture of both.

The TM10A Magnetic Tape Control transmits data to or from the PDP-10 Memory system via the KA10 Arithmetic Processor.

The TM10B Magnetic Tape Control is identical to the TM10A, except that data is transmitted to or from the PDP-10 Memory system via a DF10 Data Channel, independent of the KA10 Arithmetic Processor.

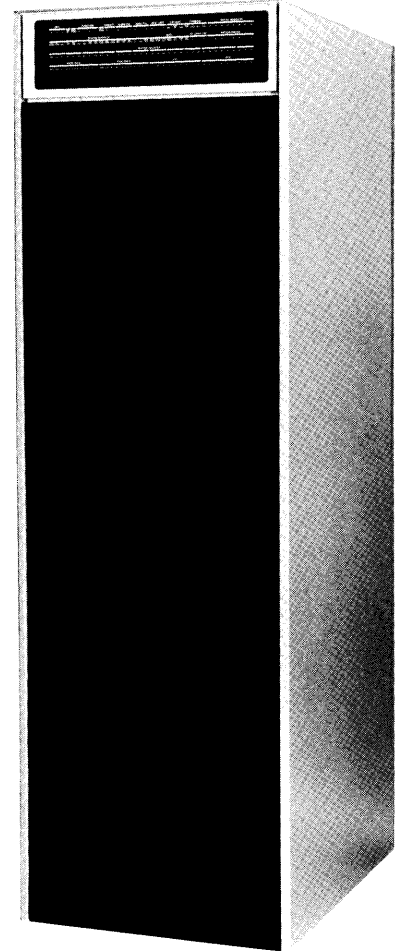

INSTALLATION DATA

Voltage	Current @ 115 Vac	Power/Heat Dissipation	Dimensions			Weight	Operating Temperature	Storage Temperature	Relative Humidity	Maximum Cable Length		
			Height	Width	Depth					I/O	Channel	Device
See Notes 1 and 2	2A	300W	69 in.	22 in.	29 in.	450 lb	60° to 95°F	40° to 110°F	20% to 80%	150 ft	TM10B only	100 ft
	Surge: 4A	1000 Btu/hr	1.75m	0.56m	0.72m	200 kg	15° to 35°C	5° to 45°C		45m		100 ft 30m

Note 1: 60 Hz Systems – This device requires an input of 115V \pm 10%, 60 Hz \pm 2%, single phase, 2-wire plus ground and is supplied with 25 ft (7.5m) of 3-conductor wire and a Hubbell #3331 cord cap (male plug) which mates with a Hubbell #3330 receptacle. A 30A circuit is recommended for this type of service.

Note 2: 50 Hz Systems – This device requires an input of 230V \pm 10%, 50 Hz \pm 2%, single phase, 2-wire plus ground and is supplied with a 3-terminal pressure connector block and 25 ft (7.5m) of 3-conductor wire. Male caps and receptacles are not supplied by DEC. A 15A circuit is recommended for this type of service.

TM10A AND TM10B
MAGNETIC TAPE CONTROL

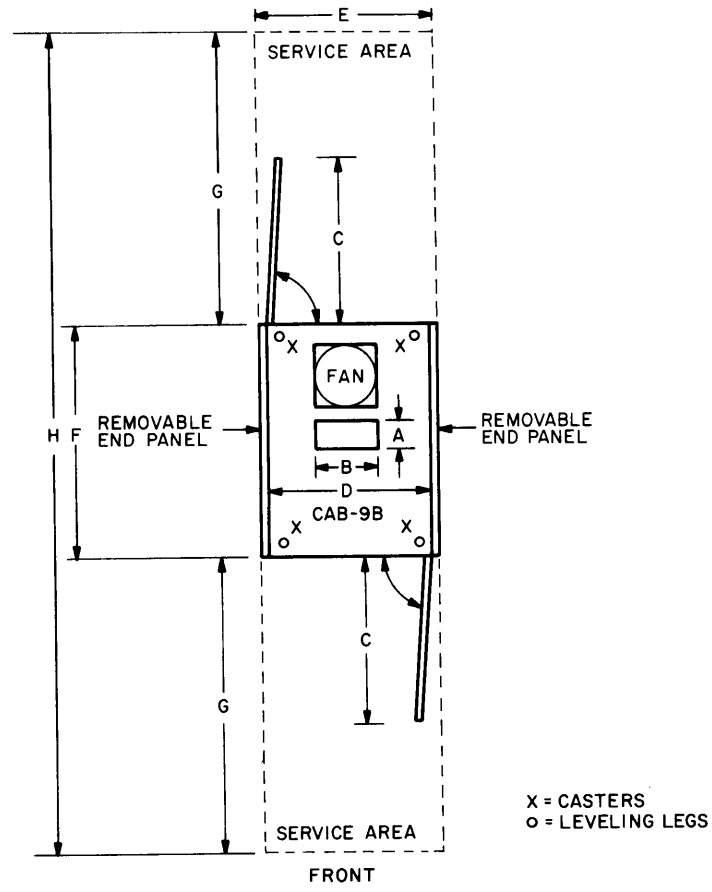

DIMENSIONS	A	B	C	D	E	F	G	H
INCHES	3.5	7.0	19.3	20.3	22.0	29.0	36.0	100
METERS	0.09	0.18	0.49	0.52	0.54	0.72	0.90	2.50

10-0452

TU20A AND TU20B MAGNETIC TAPE TRANSPORT

DESCRIPTION

The TU20 Magnetic Tape Transport is capable of reading or writing on magnetic tape at a rate of 36,000 characters per second. Recording densities of 200, 556, and 800 bits per inch at a tape speed of 45 in. (1.14m) per second are program selectable. The TU20 operates under the control of the TM10 Magnetic Tape Control.

Two versions of TU20 Magnetic Tape Transports are available:

The TU20A is a nine-channel, half-inch (12.2 mm), industry standard (USASI compatible) tape transport.

The TU20B is a seven-channel, half-inch (12.2 mm) industry standard (USASI compatible) tape transport.

The TU20 cabinets may be attached by means of the interconnecting cables routed inside the cabinets.

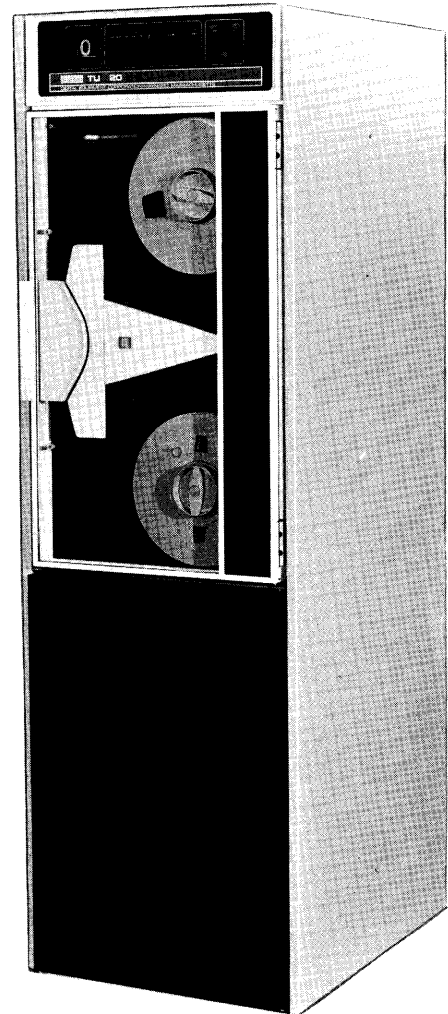

INSTALLATION DATA

Voltage	Current @ 115 Vac	Power/Heat Dissipation	Dimensions			Weight	Operating Temperature	Storage Temperature	Relative Humidity	Maximum Cable Length		
			Height	Width	Depth					I/O	Memory	Device
See Notes 1 and 2	6.7A Surge: 10A	800W 2700 Btu/hr	69 in. 1.75m	22 in. 0.56m	29 in. 0.72m	300 lb 140 kg	60° to 95°F 15° to 35°C See Note 3	40° to 110°F 5° to 45°C	40% to 80% See Note 3	None	None	100 ft 30m

Note 1: 60 Hz Systems – This device requires an input of 115V ±10%, 60 Hz ±2%, single phase, 2-wire plus ground and is supplied with 25 ft (7.5m) of 3-conductor wire and a Hubbell #3331 cord cap (male plug) which mates with a Hubbell #3330 receptacle. A 30A circuit is recommended for this type of service.

Note 2: 50 Hz Systems – This device requires an input of 230V ± 10%, 50 Hz ± 2%, single phase, 2-wire plus ground and is supplied with 25 ft (7.5m) of 3-conductor wire. The black and white wires should be connected to the power mains with the white wire connected to the neutral wire. The green wire should be connected to frame ground. Male caps and receptacles are not supplied by DEC. A 15A circuit is recommended for this type of service.

Note 3: Magnetic tape must meet dimensional and handling characteristics, which usually limit the temperature and humidity range.

TU20A AND TU20B
MAGNETIC TAPE TRANSPORT

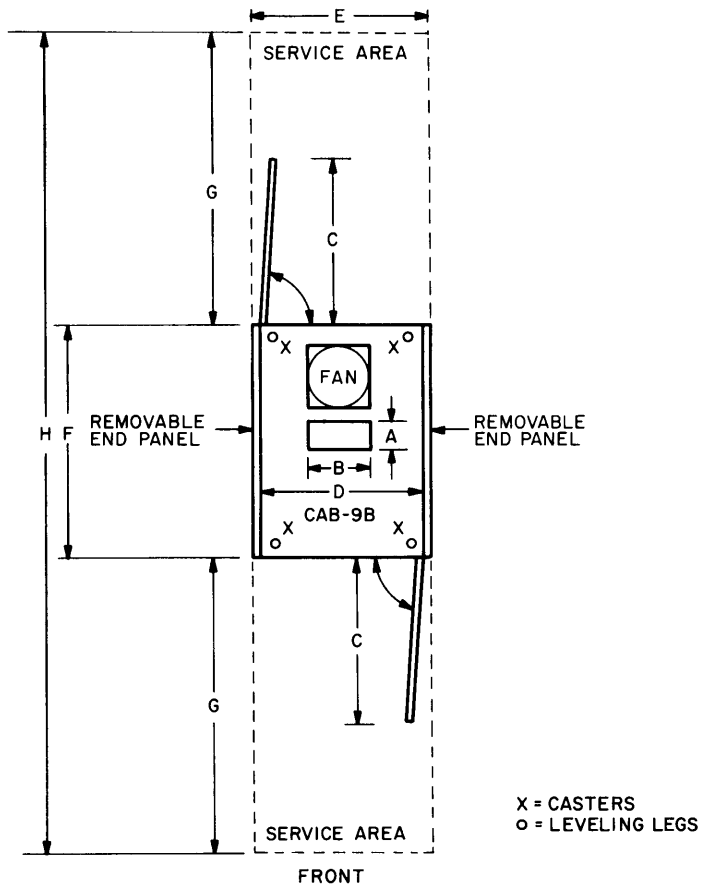

DIMENSIONS	A	B	C	D	E	F	G	H
INCHES	3.5	7.0	19.3	20.3	22.0	29.0	36.0	100
METERS	0.09	0.18	0.49	0.52	0.54	0.72	0.90	2.50

10-0452

TU30A AND TU30B MAGNETIC TAPE TRANSPORT

DESCRIPTION

The TU30 Magnetic Tape Transport is capable of reading or writing on magnetic tape at a rate of 60,000 characters per inch. Recording densities of 200, 556, and 800 bits per inch, at a tape speed of 75 in. (1.9m) per second are program selectable. The TU30 operates under the control of the TM10 Magnetic Tape Control.

Two versions of TU30 Magnetic Tape Transports are available:

The TU30A is a nine channel, half-inch (12.2 mm), industry standard (USASI compatible) tape transport.

The TU30B is a seven channel, half-inch (12.2 mm), industry standard (USASI compatible) tape transport.

The TU30 Magnetic Tape Transports are free-standing units, and all interconnecting cabling is accomplished externally to the units.

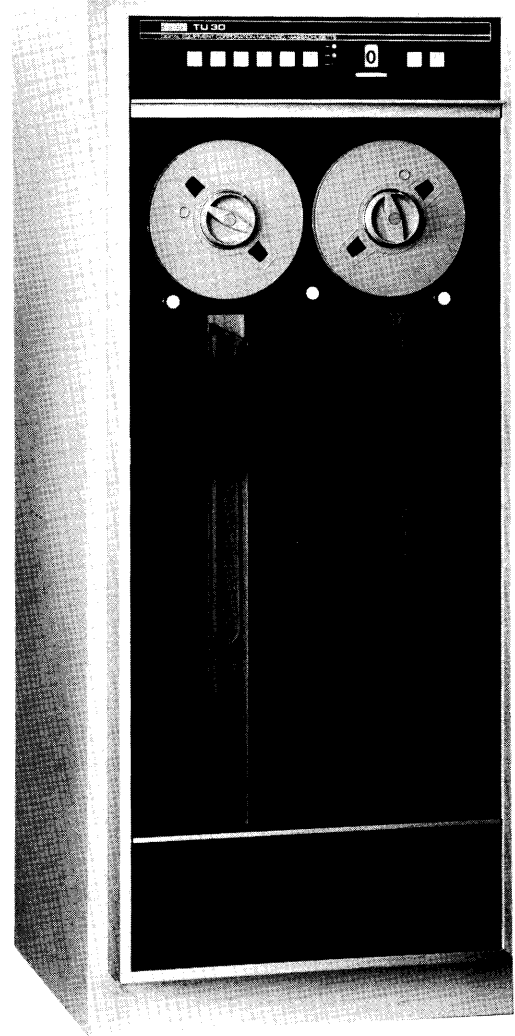

INSTALLATION DATA

Voltage	Current @ 115 Vac	Power/Heat Dissipation	Dimensions			Weight	Operating Temperature	Storage Temperature	Relative Humidity	Maximum Cable Length		
			Height	Width	Depth					I/O	Memory	Device
See Notes 1 and 2	6A Surge: 11A	650W 2300 Btu/hr	69 in. 1.75m	30 in. 0.76m	25 in. 0.64m	800 lb 360 kg	60° to 95°F 15° to 35°C See Note 3	40° to 110°F 5° to 45°C	40% to 80% See Note 3	None	None	100 ft 30m

Note 1: 60 Hz Systems – This device requires an input of 115V ±10%, 60 Hz ±2%, single phase, 2-wire plus ground and is supplied with 25 ft (7.5m) of 3-conductor wire and a Hubbell #3331 cord cap (male plug) which mates with a Hubbell #3330 receptacle. A 30A circuit is recommended for this type of service.

Note 2: 50 Hz Systems – This device requires an input of 230V ±10%, 50 Hz ±2%, single phase, 2-wire plus ground and is supplied with a 3-terminal pressure connector block and 25 ft (7.5m) of 3-conductor wire. Male caps and receptacles are not supplied by DEC. A 15A circuit is recommended for this type of service.

Note 3: Magnetic tape must meet dimensional and handling characteristics, which usually limit the temperature and humidity range.

**TU30A AND TU30B
MAGNETIC TAPE TRANSPORT**

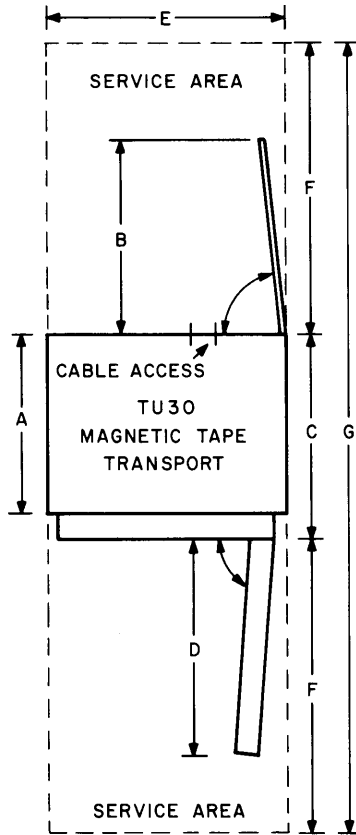

DIMENSIONS	A	B	C	D	E	F	G
INCHES	22.0	24.0	25.0	27.0	30.0	36.0	97.0
METERS	0.54	0.61	0.64	0.69	0.76	0.91	2.50

10-0455

**BA10
HARD COPY CONTROL**

DESCRIPTION

The BA10 Hard Copy Control services the CP10 Card Punch, CR10 Card Reader, LP10 Line Printer, and XY10 Plotter. The BA10 can interface with the PDP-10 I/O Bus and not more than one of each type device.

In 50-Hz systems the BA10 supplies ac power to the CR10 and XY10 devices. The LP10 obtains its ac power via an independent power source. The XY10 Plotter Control logic may, at customer option, be located in the TD10 DECTape Control. In 50-Hz systems the TD10 DECTape Control must then provide ac power to the XY10 Plotter.

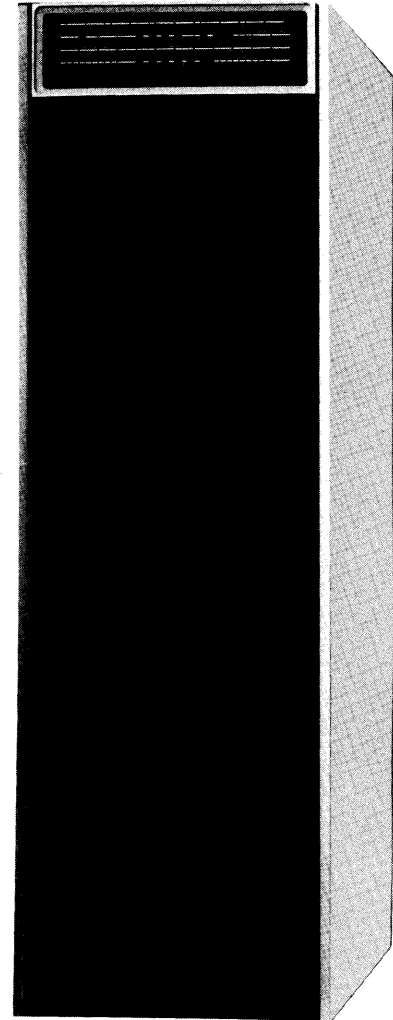

INSTALLATION DATA

Voltage	Current @ 115 Vac	Power/Heat Dissipation	Dimensions			Weight	Operating Temperature	Storage Temperature	Relative Humidity	Maximum Cable Length		
			Height	Width	Depth					I/O	Memory	Device
See Notes 1 and 2	7A Surge: 24A	800W 2700 Btu/hr	69 in. 1.75m	22 in. 0.56m	29 in. 0.72m	350 lb 150 kg	60° to 95°F 15° to 35°C	40° to 110°F 5° to 45°C	20% to 80%	150 ft 45m	None	See Device Data Sheet

Note 1: 60 Hz Systems – This device requires an input of 115V ±10%, 60 Hz ±2%, single phase, 2-wire plus ground and is supplied with 25 ft (7.5m) of 3-conductor wire and a Hubbell #3331 cord cap (male plug) which mates with a Hubbell #3330 receptacle. A 30A circuit is recommended for this type of service.

Note 2: 50 Hz Systems – This device requires an input of 230V ±10%, 50 Hz ±2%, single phase, 2-wire plus ground and is supplied with a 3-terminal pressure connector block and 25 ft (7.5m) of 3-conductor wire. Male caps and receptacles are not supplied by DEC. A 30A circuit is recommended for this type of service.

BA10
HARD COPY CONTROL

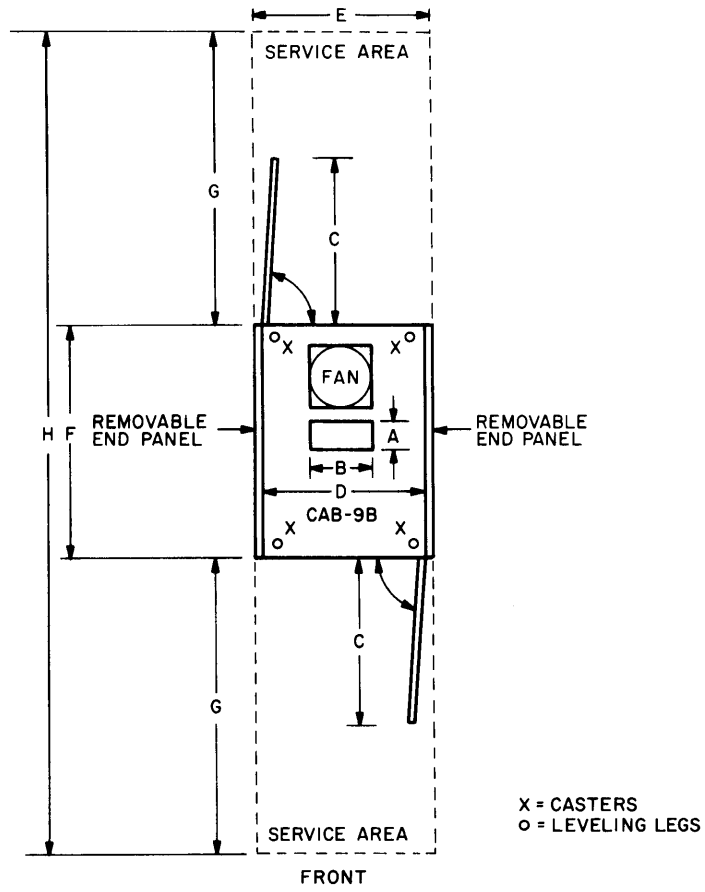

DIMENSIONS	A	B	C	D	E	F	G	H
INCHES	3.5	7.0	19.3	20.3	22.0	29.0	36.0	100
METERS	0.09	0.18	0.49	0.52	0.54	0.72	0.90	2.50

10-0452

**CP10A
CARD PUNCH**

DESCRIPTION

The CP10A Card Punch has an operating rate of 200 cards per minute when punching all 80 columns. A maximum rate of 365 cards per minute is attained by punching only the first 16 columns.

The card hopper and stacker have a capacity of 1000 cards.

The CP10A Card Punch operates under the control of the BA10 Hard Copy Control.

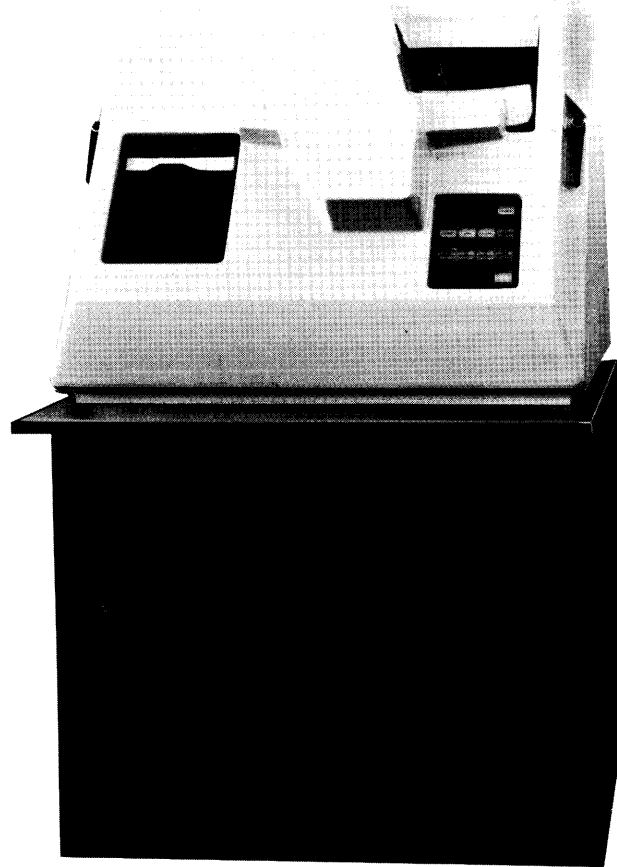

INSTALLATION DATA

Voltage	Current @ 115 Vac	Power/Heat Dissipation	Dimensions			Weight	Operating Temperature	Storage Temperature	Relative Humidity	Maximum Cable Length		
			Height	Width	Depth					I/O	Memory	Device
See Notes 1 and 2	20A Surge: 50A	2500W 8500 Btu/hr	60 in. 1.52m	36 in. 0.91m	36 in. 0.91m	500 lb 230 kg	60° to 95°F 15° to 35°C See Note 3	40° to 110°F 5° to 45°C	20% to 80% See Note 3	None	None	25 ft 7.5m

Note 1: 60 Hz Systems – This device requires an input of 115V ±10%, 60 Hz ±2%, single phase, 2-wire plus ground and is supplied with 25 ft (7.5m) of 3-conductor wire and a Hubbell #3331 cord cap (male plug) which mates with a Hubbell #3330 receptacle. A 30A circuit is recommended for this type of service.

Note 2: 50 Hz Systems – This device requires an input of 230V ±10%, 50 Hz ±2%, single phase, 2-wire plus ground and is supplied with a 3-terminal pressure connector block and 25 ft (7.5m) of 3-conductor wire. Male caps and receptacles are not supplied by DEC. A 15A circuit is recommended for this type of service.

Note 3: Cards must meet dimensional requirements which usually limit the temperature and humidity range.

CP10A
CARD PUNCH

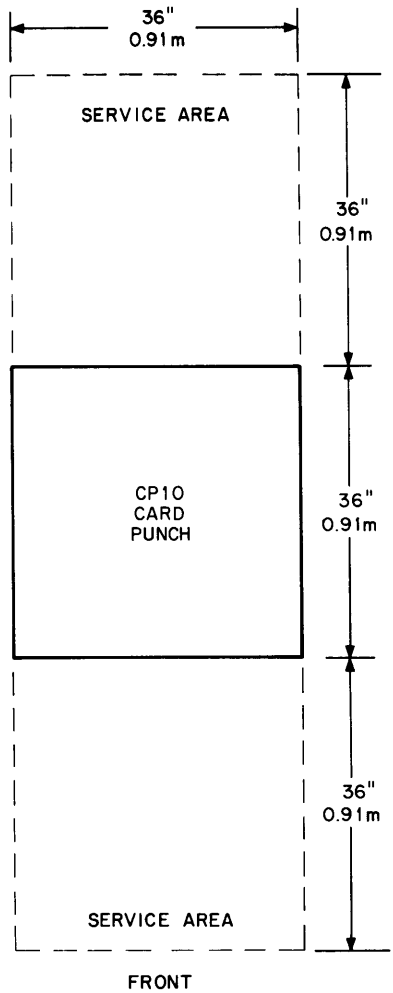

10-0456

**CR10A
CARD READER**

DESCRIPTION

The CR10A Card Reader reads standard 80-column, 12-row punched cards at a rate of 1000 cards per minute (800 cards per minute in 50-Hz systems).

The CR10A Card Reader operates under the control of the BA10 Hard Copy Control.

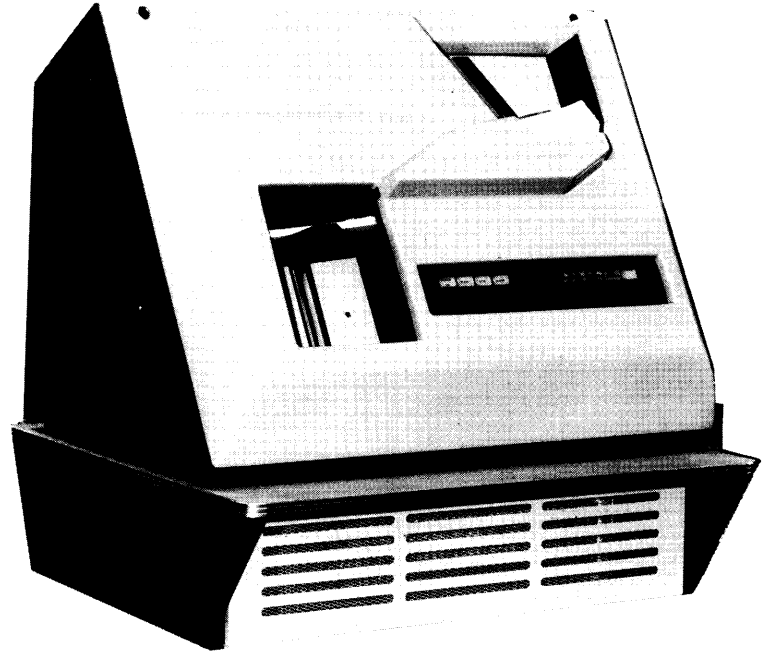

INSTALLATION DATA

Voltage	Current @ 115 Vac	Power/Heat Dissipation	Dimensions			Weight	Operating Temperature	Storage Temperature	Relative Humidity	Maximum Cable Length		
			Height	Width	Depth					I/O	Memory	Device
See Notes 1 and 2	16A Surge: 40A	1700W 5800 Btu/hr	37 in. 0.94m See Note 3	36 in. 0.91m See Note 3	36 in. 0.91m See Note 3	500 lb 230 kg	60° to 95°F 15° to 35°C See Note 4	40° to 110°F 5° to 45°C	30% to 90% See Note 4	None	None	25 ft 7.5m

- Note 1: 60 Hz Systems – This device requires an input of 115V ± 10%, 60 Hz ± 2%, single phase, 2-wire plus ground and is supplied with 25 ft (7.5m) of 3-conductor wire and a Hubbell #3331 cord cap (male plug) which mates with a Hubbell #3330 receptacle. A 30A circuit is recommended for this type of service.
- Note 2: 50 Hz Systems – The BA10 Hard Copy Control supplies an input of 115V ± 10%, 50 Hz ± 2%, single phase, 2-wire plus ground and is supplied with 25 ft (7.5m) of 3-conductor wire.
- Note 3: The CR10 is supplied with a table which makes the overall dimensions: Height – 56 in.(1.37m), Width – 64 in.(1.67m), Depth – 36 in. (0.91m)
- Note 4: Cards must meet dimensional requirements which usually limit the temperature and humidity range.

**CR10A
CARD READER**

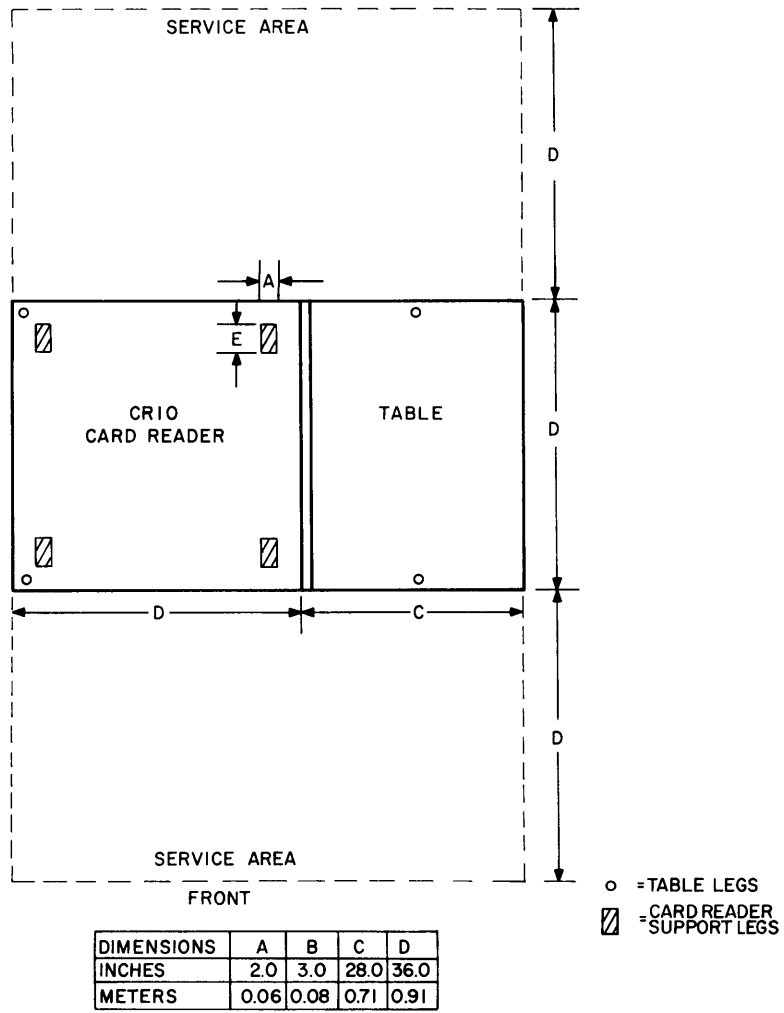

10-0457

**LP10A
LINE PRINTER**

DESCRIPTION

The LP10A Line Printer has a 64-character font, 132 columns, and a printing speed of up to 300 lines per minute.

It uses the PDP-10 modified USASCII code.

The LP10A Line Printer operates under the control of the BA10 Hard Copy Control.

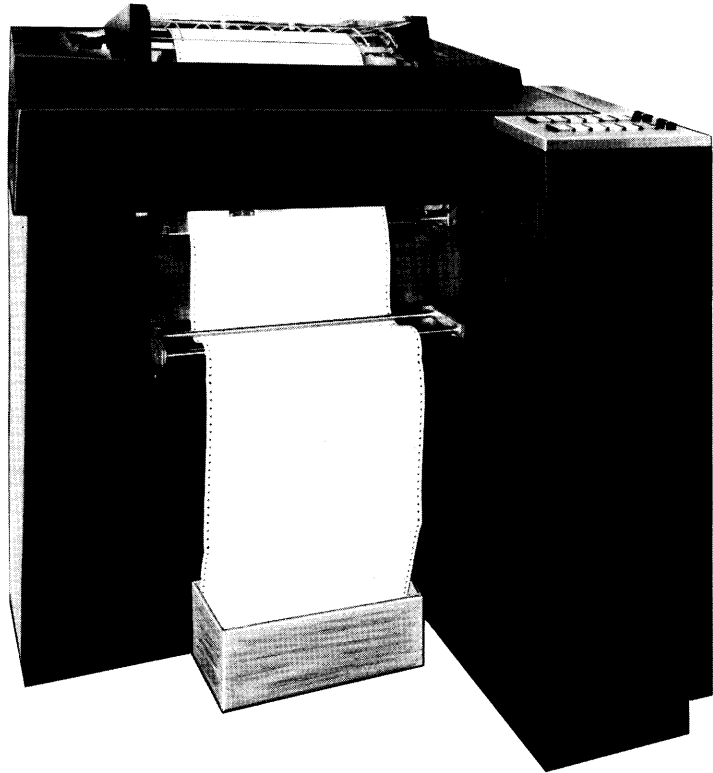

INSTALLATION DATA

Voltage	Current @ 115 Vac	Power/Heat Dissipation	Dimensions			Weight	Operating Temperature	Storage Temperature	Relative Humidity	Maximum Cable Length		
			Height	Width	Depth					I/O	Memory	Device
See Notes 1 and 2	11A Surge: 15A	1300W 4300 Btu/hr	51 in. 1.30m	43 in. 1.09m	30 in. 0.76m	1100 lb 500 kg	60° to 95°F 15° to 35°C	0° to 125°F -18° to 52°C	40% to 80%	None	None	25 ft 7.5m

Note 1: 60 Hz Systems – This device requires an input of 115V ± 10%, 60 Hz ± 2%, single phase, 2-wire plus ground and is supplied with 25 ft (7.5m) of 3-conductor wire and a Hubbell #3331 cord cap (male plug) which mates with a Hubbell #3330 receptacle. A 30A circuit is recommended for this type of service.

Note 2: 50 Hz Systems – This device requires an input of 230V ± 10%, 50 Hz ± 2%, single phase, 2-wire plus ground and is supplied with a 3-terminal pressure connector block and 25 ft (7.5m) of 3-conductor wire. Male caps and receptacles are not supplied by DEC. A 15A circuit is recommended for this type of service.

**LP10A
LINE PRINTER**

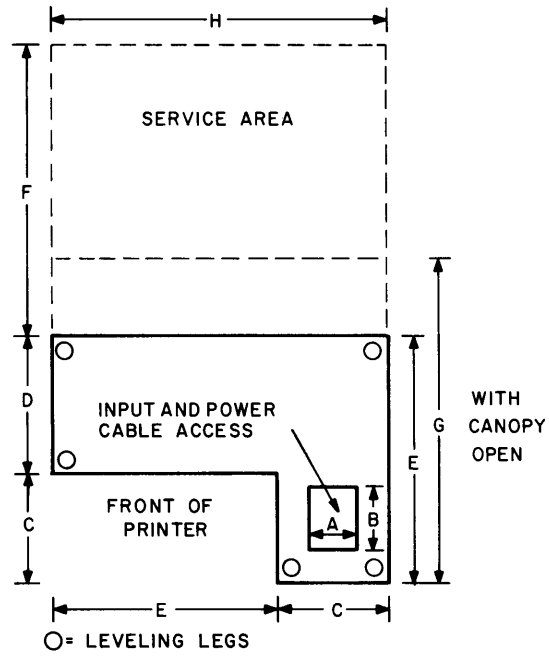

DIMENSIONS	A	B	C	D	E	F	G	H
INCHES	6.0	8.0	13.5	16.5	30.0	36.0	40.0	43.0
METERS	0.15	0.22	0.34	0.42	0.76	0.91	1.02	1.09

10-0458

**LP10B
LINE PRINTER
(manufacture discontinued)**

DESCRIPTION

The LP10B Line Printer has a 64-character font, 132 columns, and a printing speed of up to 600 lines per minute.

It uses the PDP-10 modified USASCII code.

The LP10B Line Printer operates under the control of the BA10 Hard Copy Control.

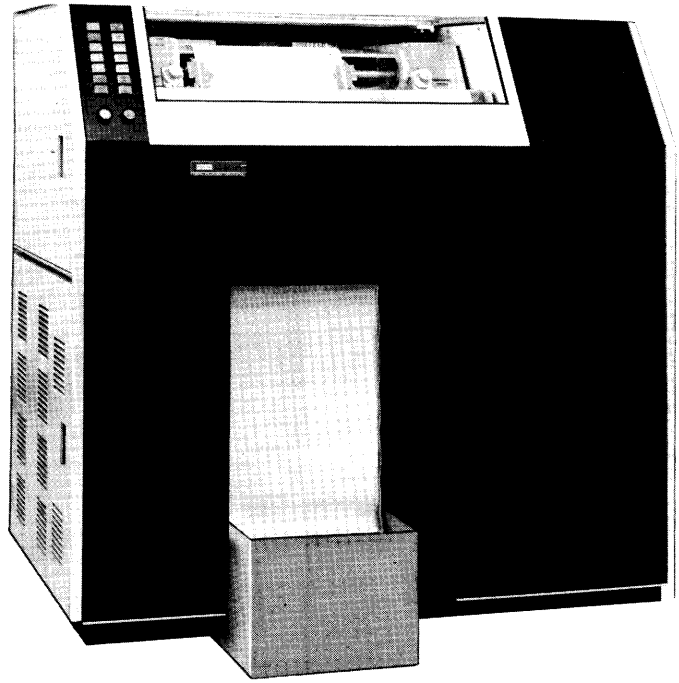

INSTALLATION DATA

Voltage	Current (@ 115 Vac)	Power/Heat Dissipation	Dimensions			Weight	Operating Temperature	Storage Temperature	Relative Humidity	Maximum Cable Length		
			Height	Width	Depth					I/O	Memory	Device
See Notes 1 and 2	20A Surge: 30A	2300W 7800 Btu/hr	56 in. 1.42m	56 in. 1.42m	30 in. 0.76m	1600 lb 725 kg	60° to 95°F 15° to 35°C	0° to 125°F -18° to 52°C	40% to 80%	None	None	25 ft 7.5m

Note 1: 60 Hz Systems – This device requires an input of 115V ± 10%, 60 Hz ± 2%, single phase, 2-wire plus ground and is supplied with 25 ft (7.5m) of 3-conductor wire and a Hubbell #3331 cord cap (male plug) which mates with a Hubbell #3330 receptacle. A 30A circuit is recommended for this type of service.

Note 2: 50 Hz Systems – This device requires an input of 230V ± 10%, 50 Hz ± 2%, single phase, 2-wire plus ground and is supplied with a 3-terminal pressure connector block and 25 ft (7.5m) of 3-conductor wire. Male caps and receptacles are not supplied by DEC. A 15A circuit is recommended for this type of service.

**LP10B
LINE PRINTER**

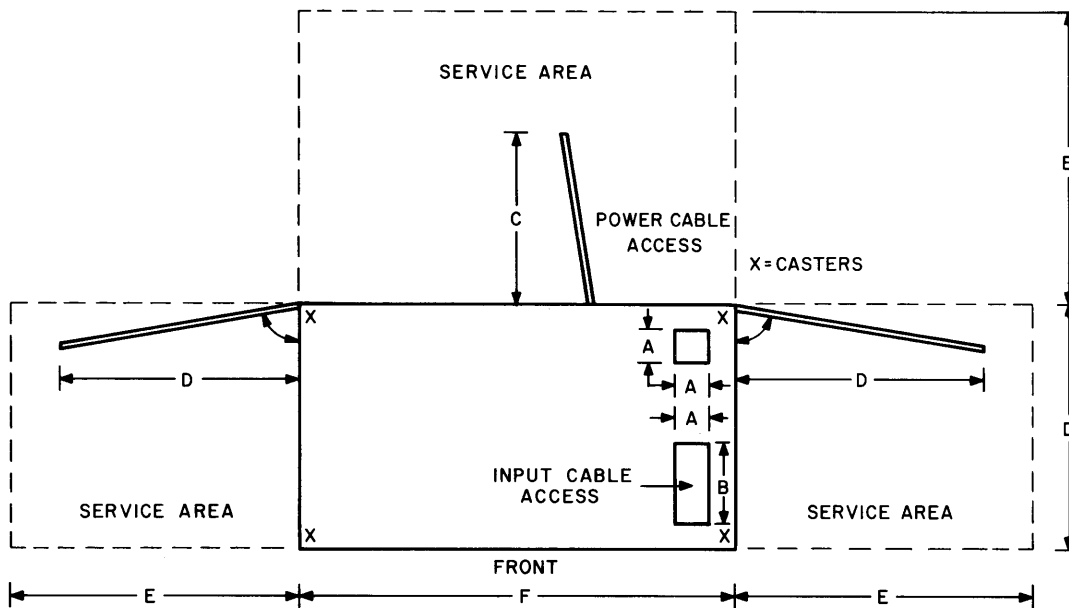

DIMENSIONS	A	B	C	D	E	F
INCHES	4.0	10.0	21.0	30.0	36.0	56.0
METERS	0.10	0.25	0.53	0.76	0.91	1.42

10-0459

**LP10C, LP10D, AND LP10E
LINE PRINTERS**

DESCRIPTION

The LP10 Line Printers operate under the control of the BA10 Hard Copy Control. Each printer uses the PDP-10 modified USASCII code.

The LP10C Line Printer has a 64-character font, 132 columns, and a printing speed of up to 1000 lines per minute.

The LP10D Line Printer has a 95-character font, 132 columns, and a printing speed of up to 600 lines per minute.

The LP10E Line Printer has a 128-character font, 132 columns, and a printing speed of up to 500 lines per minute. Thirty-three of the available characters are special mathematical and logical symbols.

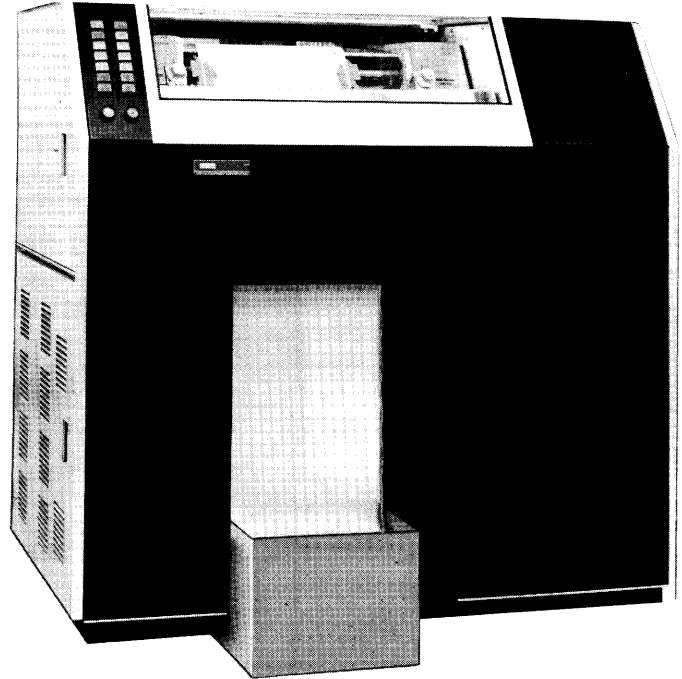

INSTALLATION DATA

Voltage	Current @ 115 Vac	Power/Heat Dissipation	Dimensions			Weight	Operating Temperature	Storage Temperature	Relative Humidity	Maximum Cable Length		
			Height	Width	Depth					I/O	Memory	Device
See Notes 1 and 2	20A Surge: 35A	2300W 7800 Btu/hr	56 in. 1.42m	56 in. 1.42m	30 in. 0.76m	1900 lb 850 kg	60° to 95°F 15° to 35°C	0° to 125°F -18° to 52°C	40% to 80%	None	None	25 ft 7.5m

Note 1: 60 Hz Systems – This device requires an input of 115V ± 10%, 60 Hz ± 2%, single phase, 2-wire plus ground and is supplied with 25 ft (7.5m) of 3-conductor wire and a Hubbell #3331 cord cap (male plug) which mates with a Hubbell #3330 receptacle. A 30A circuit is recommended for this type of service.

Note 2: 50 Hz Systems – This device requires an input of 230V ± 10%, 50 Hz ± 2%, single phase, 2-wire plus ground and is supplied with a 3-terminal pressure connector block and 25 ft (7.5m) of 3-conductor wire. Male caps and receptacles are not supplied by DEC. A 15A circuit is recommended for this type of service.

**XY10A
INCREMENTAL PLOTTER**

DESCRIPTION

The XY10A Incremental Plotter is a table-top, high-speed, drum-type pen and ink plotter. The drum or pen carriage is stepped in fixed increments in either a positive or negative direction. The size of the increment (.01 in., .005 in., or 0.1 mm) must be specified when ordering the plotter. The plotter operates at a speed of up to 300 steps per second.

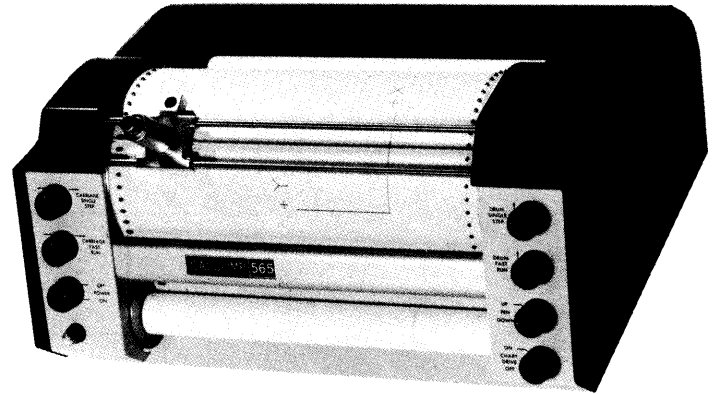

The XY10A Incremental Plotter operates under the control of the XY10 Plotter Control, which may be housed in the BA10 Hard Copy Control or the TD10 DECTape Control.

In 60-Hz systems, ac power is supplied via a standard convenience plug.

In 50-Hz systems, ac power is supplied from the BA10 Hard Copy Control or the TD10 DECTape Control cabinet.

INSTALLATION DATA

Voltage	Current @ 115 Vac	Power/Heat Dissipation	Dimensions			Weight	Operating Temperature	Storage Temperature	Relative Humidity	Maximum Cable Length		
			Height	Width	Depth					I/O	Memory	Device
See Notes 1 and 2	1.5A Surge: 1.5A	170W 600 Btu/hr	10 in. 0.25m	18 in. 0.46m	15 in. 0.38m	33 lb 15 kg	60° to 95°F 15° to 35°C	40° to 110°F 5° to 45°C	20% to 80%	None	None	25 ft 7.5m

Note 1: 60 Hz Systems – This device requires an input of 115V ± 10%, 60 Hz ± 2%, single phase, 2-wire plus ground and is supplied with 3-wire caps for use with standard 3-wire grounding type convenience outlets. A standard appliance circuit is recommended.

Note 2: 50 Hz Systems – The BA10 Hard Copy Control or the TD10A DECTape Control supplies an input of 115V ± 10%, 50 Hz ± 2%, single phase, 2-wire plus ground and is supplied with 25 ft (7.5m) of 3-conductor wire.

**XY10A
INCREMENTAL PLOTTER**

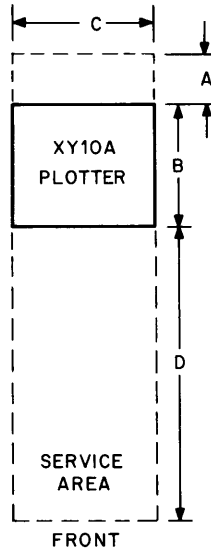

DIMENSIONS	A	B	C	D
INCHES	6.0	15.0	18.0	36.0
METERS	0.15	0.38	0.46	0.90

10-0460

**XY10B
INCREMENTAL PLOTTER**

DESCRIPTION

The XY10B Incremental Plotter is a table-top, high-speed, drum-type pen-and-ink plotter. The drum or pen carriage is stepped in fixed increments in either a positive or negative direction. The size of the increment (.01 in., .005 in., or 0.1 mm) must be specified when ordering the plotter. The plotter operates at a speed of up to 300 steps per second.

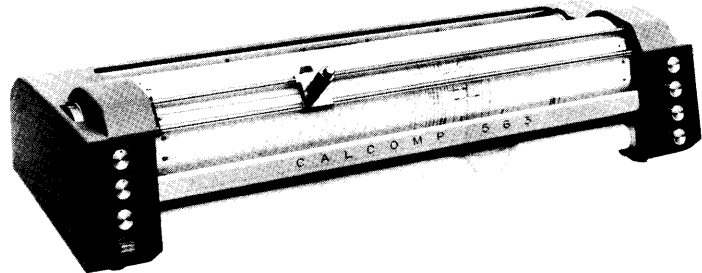

The XY10B Incremental Plotter operates under the control of the XY10 Plotter control, which may be housed in the BA10 Hard Copy Control or the TD10 DECTape Control.

In 60-Hz systems, ac power is supplied via a standard convenience plug.

In 50-Hz systems, ac power is supplied from the BA10 Hard Copy Control or the TD10 DECTape Control cabinet.

A table is provided with the XY10B Incremental Plotter.

INSTALLATION DATA

Voltage	Current @ 115 Vac	Power/Heat Dissipation	Dimensions			Weight	Operating Temperature	Storage Temperature	Relative Humidity	Maximum Cable Length		
			Height	Width	Depth					I/O	Memory	Device
See Notes 1 and 2	1.5A Surge: 1.5A	170W 600 Btu/hr	10 in. 0.25m See Note 3	40 in. 1.02m See Note 3	15 in. 0.38m See Note 3	53 lb 24 kg	60° to 95°F 15° to 35°C	40° to 110°F 5° to 45°C	20% to 80%	None	None	25 ft 7.5m

Note 1: 60 Hz Systems – This device requires an input of 115V ± 10%, 60 Hz ± 2%, single phase, 2-wire plus ground and is supplied with 3-wire caps for use with standard 3-wire grounding type convenience outlets. A standard appliance circuit is recommended.

Note 2: 50 Hz Systems – The BA10 Hard Copy Control or the TD10A DECTape Control supplies an input of 115V ± 10%, 50 Hz ± 2%, single phase, 2-wire plus ground and is supplied with 25 ft (7.5m) of 3-conductor wire.

Note 3: This device is provided with a table which makes the overall dimensions and weight – Height: 40 in.(1.02m) Depth: 22 in.(0.56m) Width: 54 in.(1.37m) Weight: 130 lb(60 kg)

**XY10B
INCREMENTAL PLOTTER**

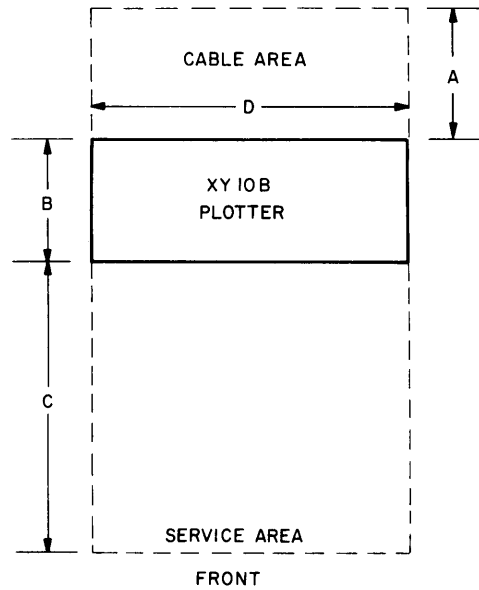

FRONT

DIMENSIONS	A	B	C	D
INCHES	6.0	15.0	36.0	40.0
METERS	0.15	0.38	0.91	1.02

10 - 0461

**DC10
DATA LINE SCANNER**

DESCRIPTION

The DC10 Data Line Scanner provides a capability for on-line servicing of up to 64 communication lines. It will accommodate any device which uses 5-level or 8-level serial Teletype code, at speeds up to 100 kilobaud. Full duplex, full duplex with local copy, and half duplex (simplex) data line modes are available on each line serviced. Send-only and receive stations can be used.

The DC10A Control Unit is the line scanner and central control unit for the DC10 series. It provides three separate line speeds. It also provides four units of logic space and power supplies for various combinations of line equipment.

The DC10B 8-Line Group Unit provides Teletype interfaces for up to eight full duplex local lines, or to full duplex data sets or full duplex with local copy. It requires one unit of cabinet space in a DC10A or DC10F cabinet.

The DC10C 8-line Telegraph Relay Assembly provides conversion from local to long lines using full- or half-duplex facilities. It requires two units of space in a DC10A or DC10F cabinet.

The DC10D Telegraph Power Supply is the standard line-voltage power supply used with the DC10C. It is housed in the DC10A (no additional cabinet space required).

The DC10E Expanded Dataset Control provides expanded control of eight data sets in the DC10 system, and will service two automatic dialing units. It requires two units of space in the DC10A or DC10F cabinet.

The DC10F Expander Cabinet provides eight units of cabinet space and the power supplies for expansion beyond the capacity of the DC10A.

The customer must provide the signal cabling from the DC10 to the Teletypes and data sets.

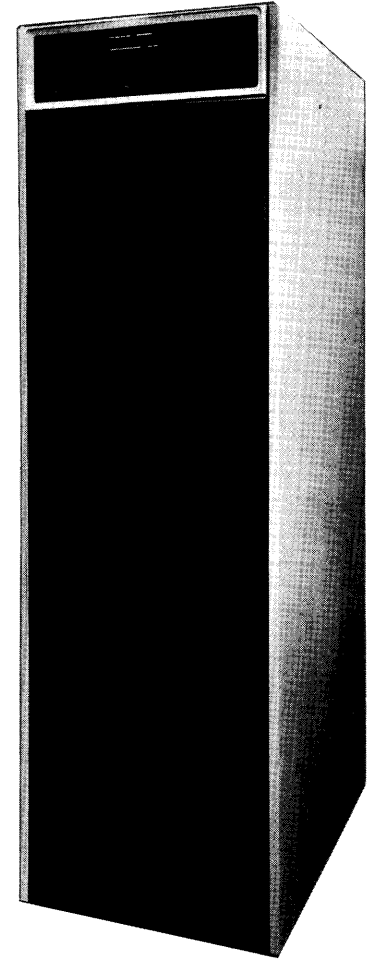

INSTALLATION DATA

Voltage	Current @ 115 Vac	Power/Heat Dissipation	Dimensions			Weight	Operating Temperature	Storage Temperature	Relative Humidity	Maximum Cable Length		
			Height	Width	Depth					I/O	Memory	Device
See Notes 1 and 2	11 A Surge: 18 A	1000W 3500 Btu/hr	69 in. 1.75m	22 in. 0.56m	29 in. 0.72m	500 lb 230 kg	60° to 95°F 15° to 35°C	40° to 110°F 5° to 45°C	20% to 80%	150 ft 45m	None	See Terminal Specifica- tions

Note 1: 60 Hz Systems – This device requires an input of 115V ± 10%, 60 Hz ± 2%, single phase, 2-wire plus ground and is supplied with 25 ft (7.5m) of 3-conductor wire and a Hubbell #3331 cord cap (male plug) which mates with a Hubbell #3330 receptacle. A 30A circuit is recommended for this type of service.

Note 2: 50 Hz Systems – This device requires an input of 230V ± 10%, 50 Hz ± 2%, single phase, 2-wire plus ground and is supplied with a 3-terminal pressure connector block and 25 ft (7.5m) of 3-conductor wire. Male caps and receptacles are not supplied by DEC. A 15A circuit is recommended for this type of service.

DC10
DATA LINE SCANNER

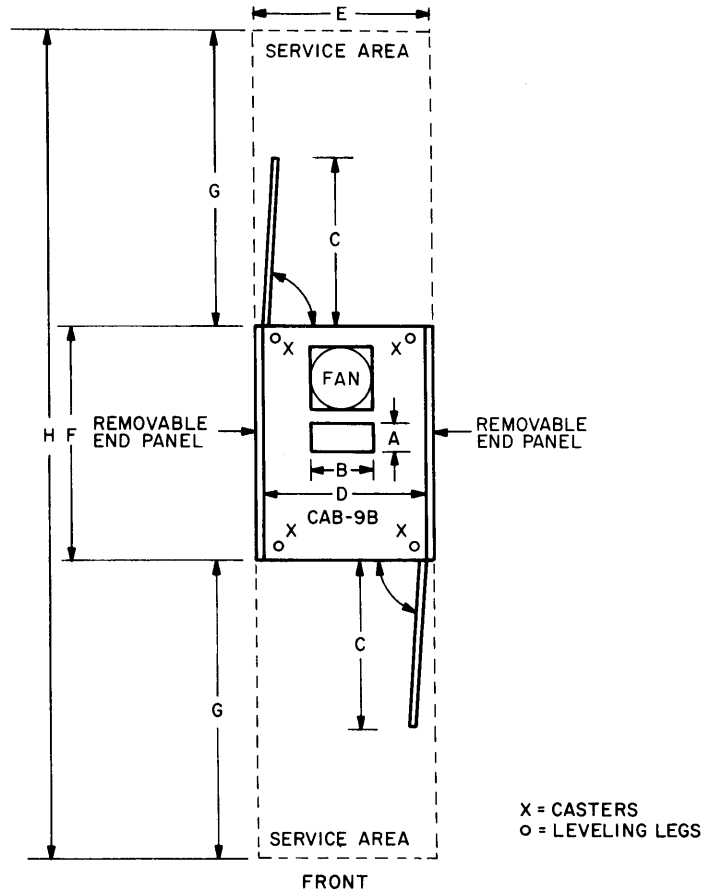

DIMENSIONS	A	B	C	D	E	F	G	H
INCHES	3.5	7.0	19.3	20.3	22.0	29.0	36.0	100
METERS	0.09	0.18	0.49	0.52	0.54	0.72	0.90	2.50

10-0452

NOTE

When additional panel mounting space is required, the DC10F Expander Cabinet may be used. The DC10A and DC10F cabinet dimensions are identical. All DC10 cabinets should be bolted together.

DESCRIPTION

The DC68A Data Communications System is based on a PDP-8/I computer which provides a powerful processing capability and a wide range of applications.

It offers semiautomatic and automatic interface capability with most privately owned and common carrier-supplied communication facilities.

The DC68A Data Communications System interfaces with the KA10 Arithmetic Processor via a DA10 PDP-8/PDP-9 Interface.

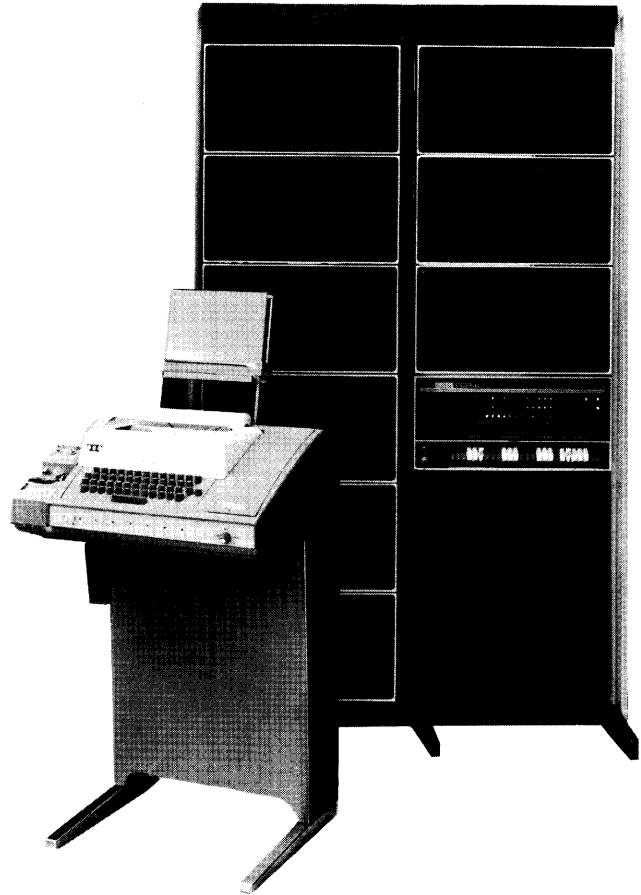

INSTALLATION DATA

Voltage	Current @ 115 Vac	Power/Heat Dissipation	Dimensions			Weight	Operating Temperature	Storage Temperature	Relative Humidity	Maximum Cable Length		
			Height	Width	Depth					I/O	Memory	Device
See Notes 1 and 2	8A Surge: 13A See Note 3	900W 3100 Btu/hr See Note 3	72 in. 1.83 m	43 in. 1.09 m	30 in. 0.76 m	550 lb 250 kg	60° to 95°F 15° to 35°C	40° to 110°F 5° to 45°C	20% to 80%	None	None	20 ft 6m

Note 1: 60 Hz Systems – This device requires an input of 115V ± 10%, 60 Hz ± 2%, single phase, 2-wire plus ground and is supplied with 25 ft (7.5m) of 3-conductor wire and a Hubbell #3331 cord cap (male plug) which mates with a Hubbell #3330 receptacle. A 30A circuit is recommended for this type of service.

Note 2: 50 Hz Systems – This device requires an input of 230V ± 10%, 50 Hz ± 2%, single phase, 2-wire plus ground and is supplied with 25 ft (7.5m) of 3-conductor wire. The black and white wires should be connected to the power mains (with the white wire connected to the neutral wire if present). The green wire should be connected to frame ground. Male caps and receptacles are not supplied by DEC. A 15A circuit is recommended for this type of service.

Note 3: Values are given for a typical system.

DC68A
 DATA COMMUNICATIONS SYSTEM

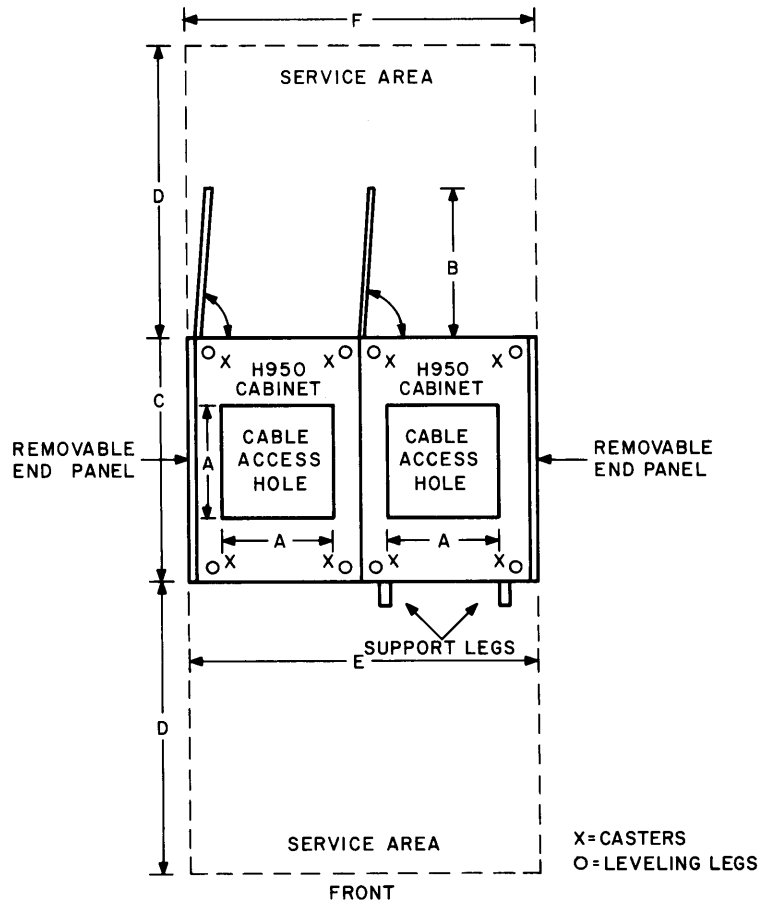

DIMENSIONS	A	B	C	D	E	F
INCHES	14.0	19.0	30.0	36.0	41.0	43.0
METERS	0.36	0.48	0.76	0.91	1.06	1.09

10-0462

LT33A AND LT33C TELETYPEWRITERS

DESCRIPTION

The LT33A and LT33C Teletypewriters provide the user with an economical, light-duty, keyboard-printer (KSR) communications medium to the computer.

The LT33A connects to a 4-pin telephone type jack (supplied), which can be wired to the DC10 Data Line Scanner with up to 1500 ft (450m) of cable. It is provided with a 6-ft (2m) signal cable.

The LT33C connects directly to a DC08B (680/I) or a 682 (680) Local Line Panel using a W076 connector module (supplied). It is provided with a 25-ft (7.5m) signal cable.

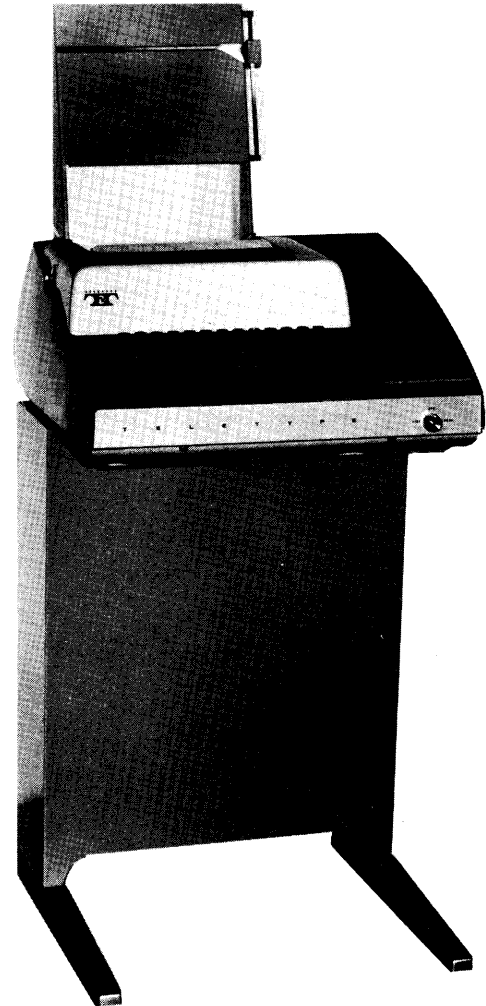

INSTALLATION DATA

Voltage	Current @ 115 Vac	Power/Heat Dissipation	Dimensions			Weight	Operating Temperature	Storage Temperature	Relative Humidity	Maximum Cable Length		
			Height	Width	Depth					I/O	Memory	Device
See Notes 1 and 2	1.7A Surge: 2.5A	200W 680 Btu/hr	34 in. 0.86m	19 in. 0.48m	19 in. 0.48m	52 lb 24 kg	60° to 95°F 15° to 35°C	40° to 110°F 5° to 45°C	20% to 80%	None	None	See Description Above

Note 1: 60 Hz Systems – This device requires an input of 115V ± 10%, 60 Hz ± .45 Hz, single phase, 2-wire plus ground and is supplied with 3-wire caps for use with standard 3-wire grounding type convenience outlets. A standard appliance circuit is recommended. (The console Teletype plugs into the central processor and does not require a receptacle.)

Note 2: 50 Hz Systems – This device requires an input of 230V ± 10%, 50 Hz ± .40 Hz, single phase, 2-wire plus ground and is supplied with 3-wire caps for use with North American standard 3-wire grounding type convenience outlets. During equipment installation, these caps may be removed and replaced with other caps. A standard appliance circuit is recommended for these devices. (The console Teletype plugs into the central processor and does not require a receptacle.)

**LT33A AND LT33C
TELETYPEWRITERS**

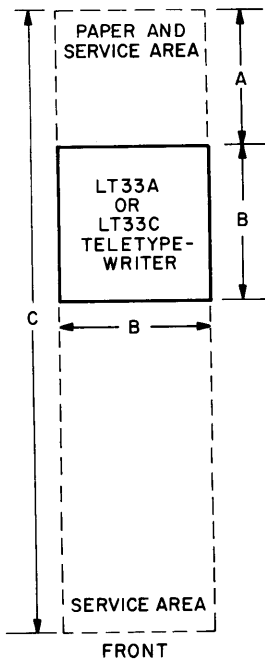

DIMENSIONS	A	B	C
INCHES	18.0	19.0	78.0
METERS	0.46	0.48	1.78

10-0463

LT33B AND LT33H TELETYPEWRITERS

DESCRIPTION

The LT33B and LT33H Teletypewriters provide the user with an economical, light-duty, automatic keyboard-reader-printer-punch (ASR) communications medium to the computer. The LT33B and LT33H provide the user with timesharing-compatible punched paper-tape input and output.

The LT33B connects to a 4-pin telephone type jack (supplied) which can be wired to the DC10 Data Line Scanner with up to 1500 ft (450m) of cable. It is provided with a 6-ft (2m) signal cable.

The LT33H connects directly to a DC08B (680/I) or 682 (680) Local Line Unit Panel, using a W076 connector module (supplied). It is provided with a 25-ft (7.5m) signal cable.

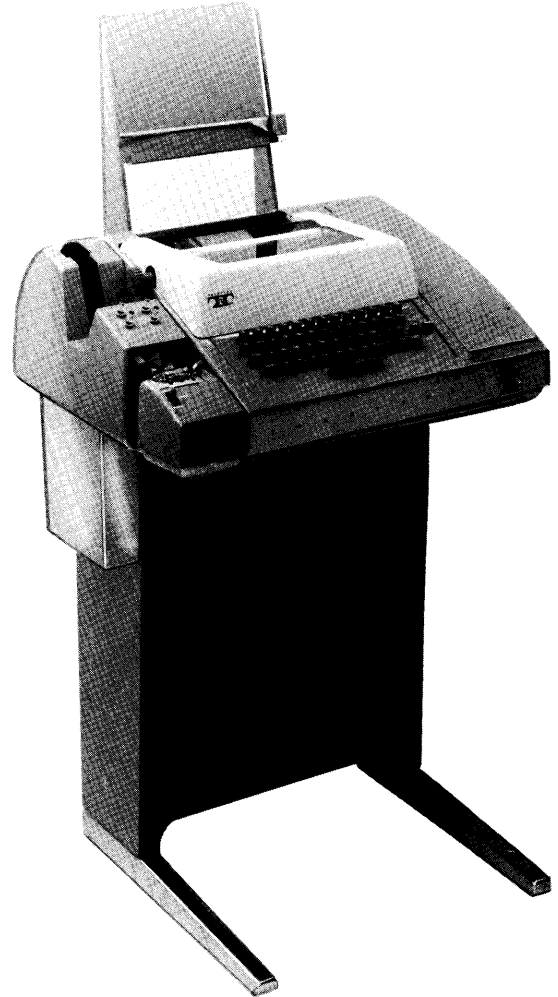

INSTALLATION DATA

Voltage	Current @ 115 Vac	Power/Heat Dissipation	Dimensions			Weight	Operating Temperature	Storage Temperature	Relative Humidity	Maximum Cable Length		
			Height	Width	Depth					I/O	Memory	Device
See Notes 1 and 2	1.8A Surge: 2.5A	200W 680 Btu/hr	34 in. 0.86m	22 in. 0.56m	19 in. 0.48m	56 lb 26 kg	60° to 95°F 15° to 35°C	40° to 110°F 5° to 45°C	20% to 80%	None	None	See Description Above

Note 1: 60 Hz Systems – This device requires an input of 115V ± 10%, 60 Hz ± .45 Hz, single phase, 2-wire plus ground and is supplied with 3-wire caps for use with standard 3-wire grounding type convenience outlets. A standard appliance circuit is recommended. (The console Teletype plugs into the central processor and does not require a receptacle.)

Note 2: 50 Hz Systems – This device requires an input of 230V ± 10%, 50 Hz ± .40 Hz, single phase, 2-wire plus ground and is supplied with 3-wire caps for use with North American standard 3-wire grounding type convenience outlets. During equipment installation, these caps may be removed and replaced with other caps. A standard appliance circuit is recommended for these devices. (The console Teletype plugs into the central processor and does not require a receptacle.)

**LT33B AND LT33H
TELETYPEWRITERS**

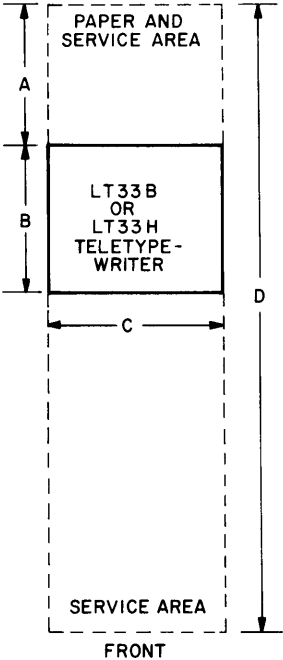

DIMENSIONS	A	B	C	D
INCHES	18.0	19.0	22.0	78.0
METERS	0.46	0.48	0.56	1.78

10-0464

LT35A AND LT35C TELETYPEWRITERS

DESCRIPTION

The LT35A and LT35C Teletypewriters provide the user with an economical, heavy-duty, keyboard-printer (KSR) communications medium to the computer.

The LT35A connects to a 4-pin telephone type jack (supplied), which can be wired to the DC10 Data Line Scanner with up to 1500 ft (450m) of cable. It is provided with a 6-ft (2m) signal cable.

The LT35C connects directly to a DC08B (680/I) or 682 (680) Local Line Panel, using a W076 connector module (supplied). It is provided with a 25-ft (7.5m) signal cable.



INSTALLATION DATA

Voltage	Current @ 115 Vac	Power/Heat Dissipation	Dimensions			Weight	Operating Temperature	Storage Temperature	Relative Humidity	Maximum Cable Length		
			Height	Width	Depth					I/O	Memory	Device
See Notes 1 and 2	1.7A Surge: 3A	200W 680 Btu/hr	40 in. 1.02m	20 in. 0.51m	28 in. 0.71m	150 lb 70 kg	60° to 95°F 15° to 35°C	40° to 110°F 5° to 45°C	20% to 80%	None	None	See Description Above

Note 1: 60 Hz Systems – This device requires an input of 115V ± 10%, 60 Hz ± .45 Hz, single phase, 2-wire plus ground and is supplied with 3-wire caps for use with standard 3-wire grounding type convenience outlets. A standard appliance circuit is recommended. (The console Teletype plugs into the central processor and does not require a receptacle.)

Note 2: 50 Hz Systems – This device requires an input of 230V ± 10%, 50 Hz ± .40 Hz, single phase, 2-wire plus ground and is supplied with standard North American 3-wire caps for use with standard 3-wire grounding type convenience outlets. During equipment installation, these caps may be removed and replaced with other caps. A standard appliance circuit is recommended for these devices. (The console Teletype plugs into the central processor and does not require a receptacle.)

**LT35A AND LT35C
TELETYPEWRITERS**

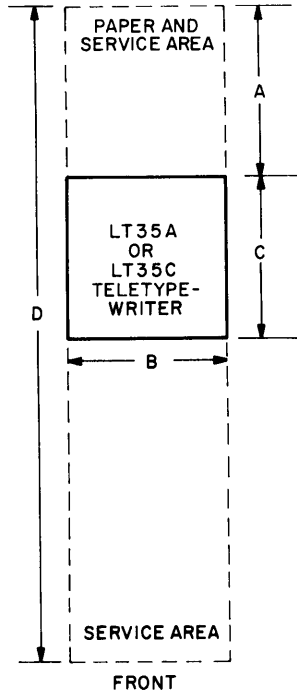

DIMENSIONS	A	B	C	D
INCHES	18.0	20.0	28.0	78.0
METERS	0.46	0.51	0.71	1.78

10-0465

**LT37AC
TELETYPEWRITER**

DESCRIPTION

The LT37AC Teletypewriter is a high-speed, heavy-duty communications medium to the computer. It provides the standard 128 character ASCII code set. The LT37AC prints upper and lower case letters and has an operating speed of 15 characters per second.

The LT37AC is provided with a 3-ft (1m) signal cable for direct connection to a Bell System 103-type data set or equivalent.

When ordered with a DC10, or provided as the KA10 Console Teleprinter, the LT37AC is provided with a 9-ft (3m) signal cable and a 4-pin telephone type plug and mating jack.

When ordered with a DC08B (680/I), the LT37AC is provided with a 25-ft (7.5m) BC10E signal cable adapter, which connects directly to the DC08B.



INSTALLATION DATA

Voltage	Current @ 115 Vac	Power/Heat Dissipation	Dimensions			Weight	Operating Temperature	Storage Temperature	Relative Humidity	Maximum Cable Length		
			Height	Width	Depth					I/O	Memory	Device
See Note 1	2.2A Surge: 3.5A	250W 860 Btu/hr	37 in. 0.94m	33 in. 0.84m	28 in. 0.71m	220 lb 100 kg	60° to 95°F 15° to 35°C	40° to 110°F 5° to 45°C	20% to 80%	None	None	See Description Above

Note 1: This device operates from a 115 Vac, 60 Hz \pm 0.45 Hz, single-phase power source, only. It is provided with a 3-wire connection (cap) which fits a North American standard, 3-wire grounding type convenience outlet.

**LT37AC
TELETYPEWRITER**

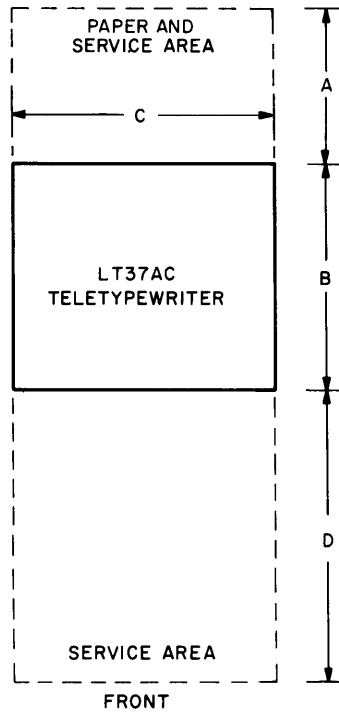

DIMENSIONS	A	B	C	D
INCHES	15.0	28.0	33.0	36.0
METERS	0.41	0.71	0.84	0.91

10-0466

346/340B
PRECISION INCREMENTAL CRT DISPLAY

DESCRIPTION

The 346/340B Precision Incremental CRT Display plots points, straight lines, and curves at a high speed.

The 340B Display accepts digital data from the computer in the form of vector, point increment, and control commands. There are 1024 x 1024 scope face locations within a 9.375-in. (238.1 mm) square display area.

A Type 370 light pen is included.

The optional 342B Character Generator permits the generation of alphanumeric characters and is housed in the 346/340B cabinet.

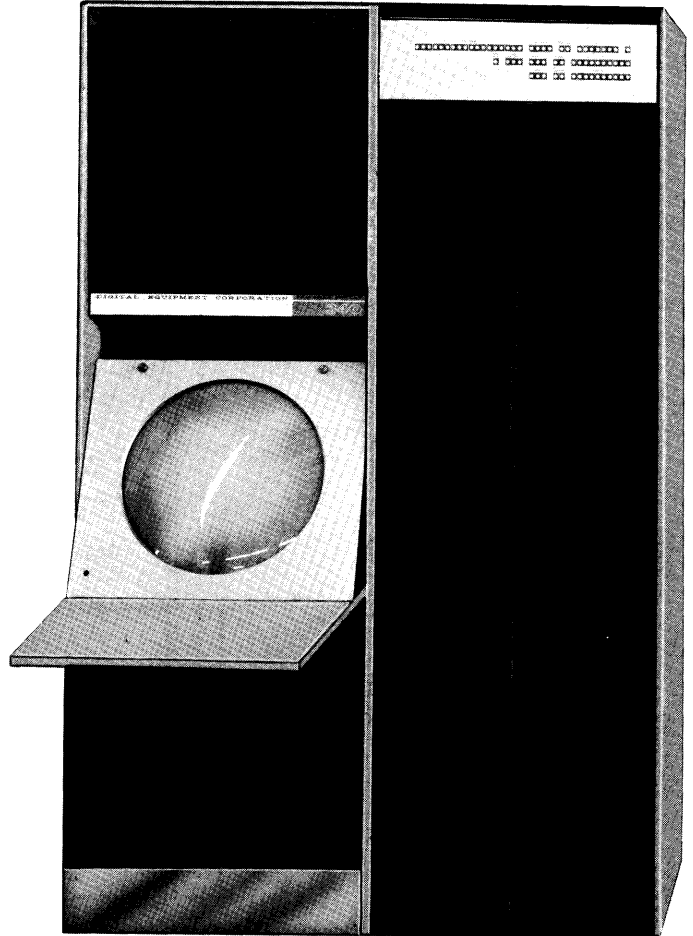

INSTALLATION DATA

Voltage	Current @ 115 Vac	Power/Heat Dissipation	Dimensions			Weight	Operating Temperature	Storage Temperature	Relative Humidity	Maximum Cable Length		
			Height	Width	Depth					I/O	Memory	Device
See Notes 1 and 2	15A Surge: 20A	1700W 6000 Btu/hr	69 in. 1.75m	42 in. 1.07m	53 in. 1.35m	700 lb 320 kg	60° to 95°F 15° to 35°C	40° to 110°F 5° to 45°C	20% to 80%	150 ft 45m	None	None

Note 1: 60 Hz Systems – This device requires an input of 115V ± 10%, 60 Hz ± 2%, single phase, 2-wire plus ground and is supplied with 25 ft (7.5m) of 3-conductor wire and a Hubbell #3331 cord cap (male plug) which mates with a Hubbell #3330 receptacle. A 30A circuit is recommended for this type of service.

Note 2: 50 Hz Systems – This device requires an input of 230V ± 10%, 50 Hz ± 2%, single phase, 2-wire plus ground and is supplied with 25 ft (7.5m) of 3-conductor wire. The black and white wires should be connected to the power mains with the white wire connected to the neutral wire. The green wire should be connected to frame ground. Male caps and receptacles are not supplied by DEC. A 15A circuit is recommended for this type of service.

346/340B
 PRECISION INCREMENTAL CRT DISPLAY

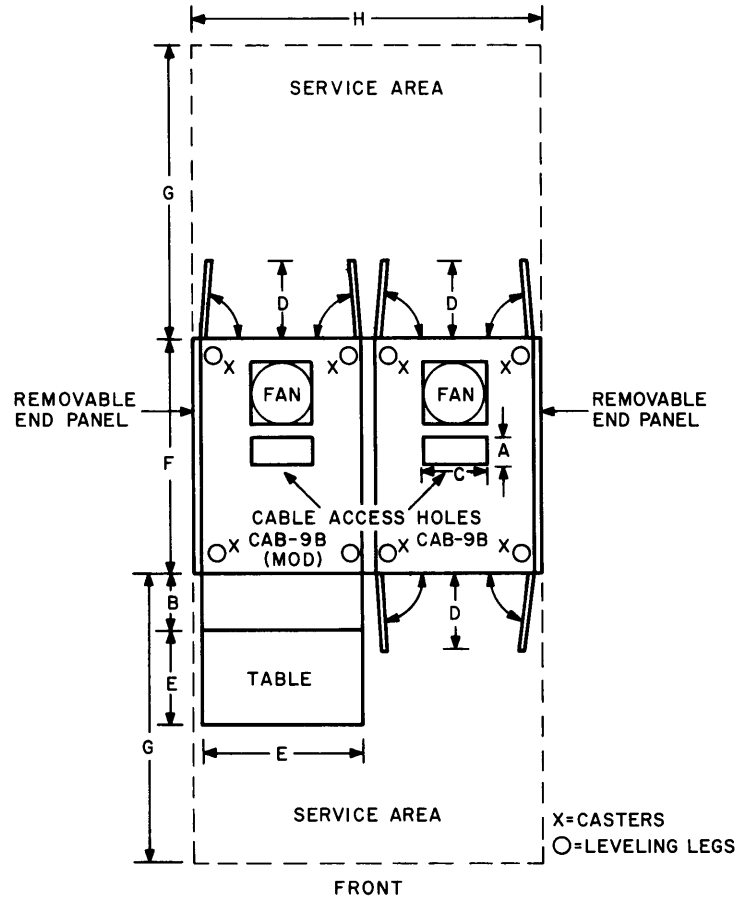

DIMENSIONS	A	B	C	D	E	F	G	H
INCHES	3.5	7.0	7.2	9.5	19.0	27.0	36.0	43.0
METERS	0.09	0.18	0.18	0.24	0.48	0.68	0.91	1.08

10-0467

DESCRIPTION

The 348/VR30 Precision Display is a low-cost point-plotting display with the same precision as larger DEC displays.

It operates at a maximum plotting rate of 20 kHz, or one point every 50 μ s, on a display area of 9.375 x 9.375 in. (238.1 x 238.1 mm).

The number of addressable points along each axis is 1024.

A Type 370 light pen is included.

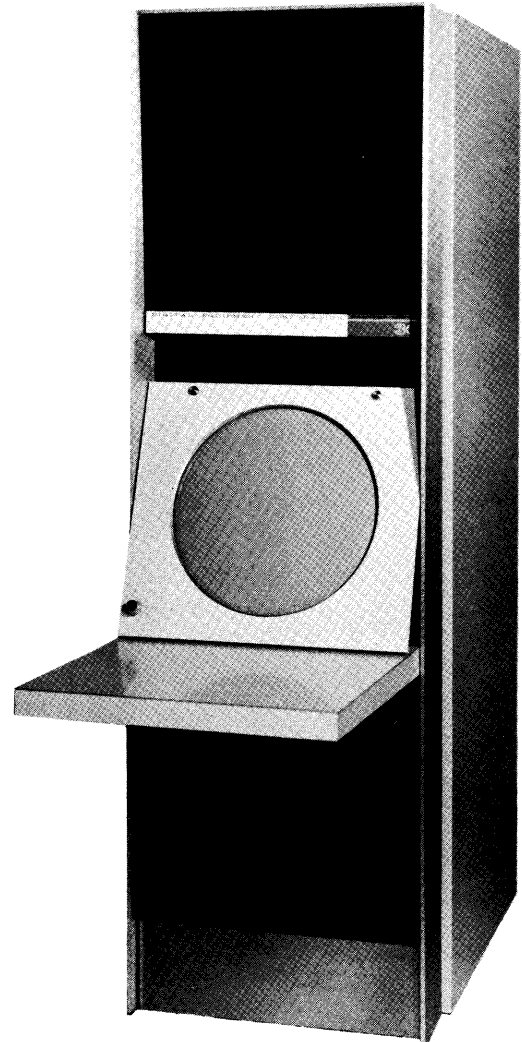

INSTALLATION DATA

Voltage	Current @ 115 Vac	Power/Heat Dissipation	Dimensions			Weight	Operating Temperature	Storage Temperature	Relative Humidity	Maximum Cable Length		
			Height	Width	Depth					I/O	Memory	Device
See Notes 1 and 2	12A Surge: 17A	1400W 4700 Btu/hr	69 in. 1.75m	22 in. 0.56m	53 in. 1.35m	360 lb 170 kg	60° to 95°F 15° to 35°C	40° to 110°F 5° to 45°C	20% to 80%	150 ft 45m	None	None

Note 1: 60 Hz Systems – This device requires an input of 115V \pm 10%, 60 Hz \pm 2%, single phase, 2-wire plus ground and is supplied with 25 ft (7.5m) of 3-conductor wire and a Hubbell #3331 cord cap (male plug) which mates with a Hubbell #3330 receptacle. A 30A circuit is recommended for this type of service.

Note 2: 50 Hz Systems – This device requires an input of 230V \pm 10%, 50 Hz \pm 2%, single phase, 2-wire plus ground and is supplied with 25 ft (7.5m) of 3-conductor wire. The black and white wires should be connected to the power mains with the white wire connected to the neutral wire. The green wire should be connected to frame ground. Male caps and receptacles are not supplied by DEC. A 15A circuit is recommended for this type of service.

348/VR30
PRECISION DISPLAY

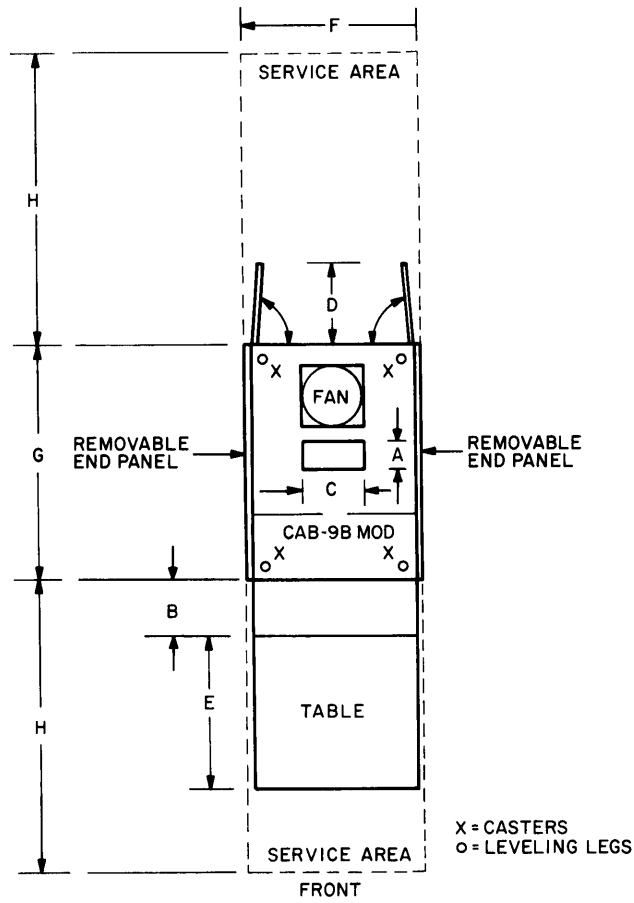

DIMENSIONS	A	B	C	D	E	F	G	H
INCHES	3.5	7.0	7.2	9.5	19.0	22.0	27.0	36.0
METERS	0.09	0.18	0.18	0.24	0.48	0.54	0.68	0.91

10-0469

**VP10
DISPLAY CONTROL**

DESCRIPTION

The VP10 Display Control, in conjunction with an X-Y oscilloscope such as the Tektronix RM503, provides a point-plotting Cathode-Ray-Tube display.

The optional Type 370 light pen mounts in the VP10 cabinet. Logic within the VP10 allows the light pen to control or communicate with the program via the priority interrupt system.

The VP10 Display Control is program compatible with the type 348/VR30 Display. It operates at either of 2 maximum plotting rates: 10 kHz (1 point every 100 μ sec) or 50 kHz (1 point every 20 μ sec).

The VP10 is included in a standard 19-inch DEC cabinet mounted on casters for easy positioning. Models for 230V, 50 Hz operation and 115V, 60 Hz operation are available. The cabinet is equipped with cooling fans; therefore, no additional cooling is required in a normal installation. All interconnecting cables enter through access cutouts in the bottom of the cabinet.

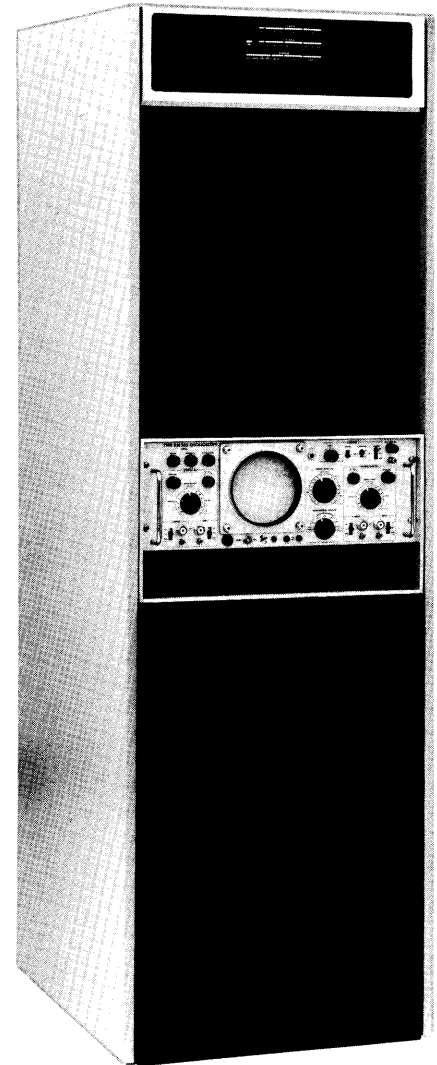

INSTALLATION DATA

Voltage	Current @ 115 Vac	Power/Heat Dissipation	Dimensions			Weight	Operating Temperature	Storage Temperature	Relative Humidity	Maximum Cable Length		
			Height	Width	Depth					I/O	Memory	Device
See Notes 1 and 2	2A Surge: 4A	230W 780 Btu/hr	69 in. 1.75m	22 in. 0.56m	29 in. 0.72m	260 lb 120 kg	60° to 95°F 15° to 35°C	40° to 110°F 5° to 45°C	20% to 80%	150 ft 45m	None	10 ft 3m at full speed

Note 1: 60 Hz Systems – This device requires an input of 115V \pm 10%, 60 Hz \pm 2%, single phase, 2-wire plus ground and is supplied with 25 ft (7.5m) of 3-conductor wire and a Hubbell #3331 cord cap (male plug) which mates with a Hubbell #3330 receptacle. A 30A circuit is recommended for this type of service.

Note 2: 50 Hz Systems – This device requires an input of 230V \pm 10%, 50 Hz \pm 2%, single phase, 2-wire plus ground and is supplied with a 3-terminal pressure connector block and 25 ft (7.5m) of 3-conductor wire. Male caps and receptacles are not supplied by DEC. A 15A circuit is recommended for this type of service.

VP10
DISPLAY CONTROL

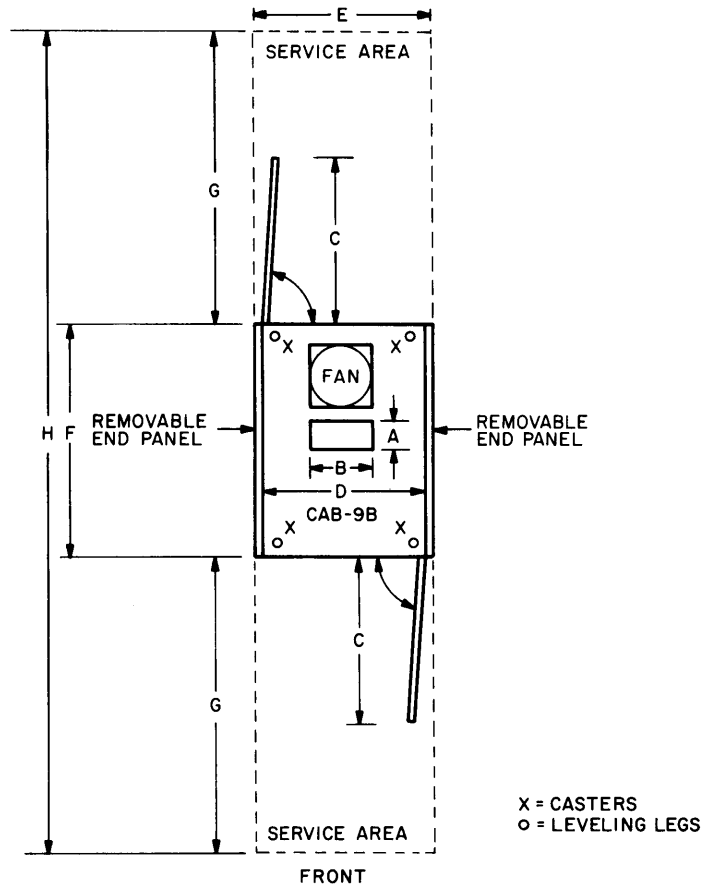

DIMENSIONS	A	B	C	D	E	F	G	H
INCHES	3.5	7.0	19.3	20.3	22.0	29.0	36.0	100
METERS	0.09	0.18	0.49	0.52	0.54	0.72	0.90	2.50

10-0452

DA10
PDP-8/PDP-9 INTERFACE

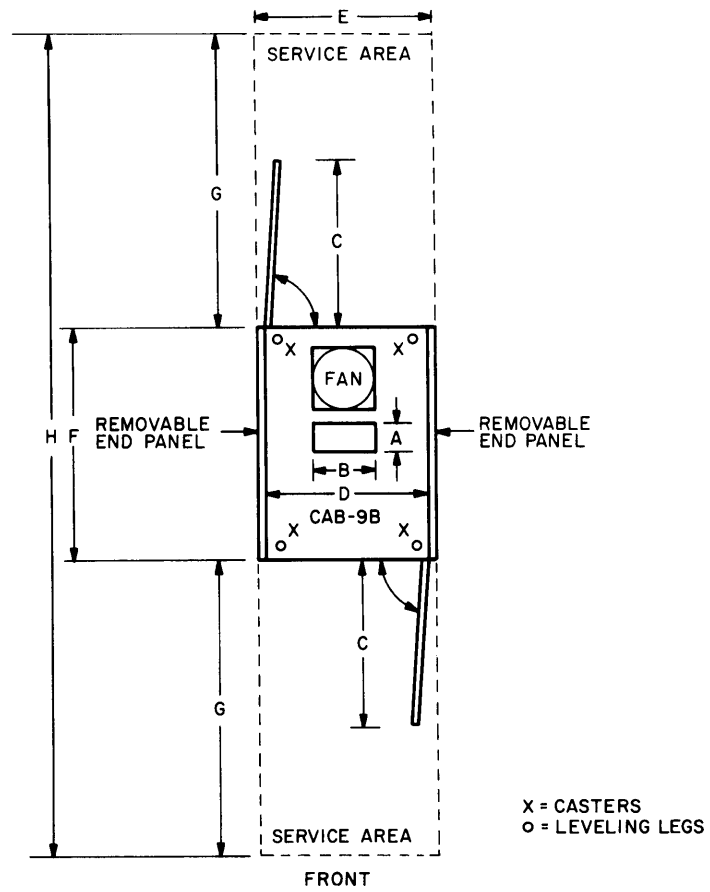

X = CASTERS
O = LEVELING LEGS

DIMENSIONS	A	B	C	D	E	F	G	H
INCHES	3.5	7.0	19.3	20.3	22.0	29.0	36.0	100
METERS	0.09	0.18	0.49	0.52	0.54	0.72	0.90	2.50

10-0452

GP10
PDP-10 I/O BUS INTERFACE

DESCRIPTION

The GP10 PDP-10 I/O Bus Interface provides the user with the logic, power supplies, power control, indicators, fans, and cables necessary to interface special equipment to the PDP-10 I/O Bus.

The logic contains a status register, device decoding, read-in gating, and line buffering.

The GP10L consists of the logic and BS10A cable set only. The GP10M consists of the GP10, without the logic.

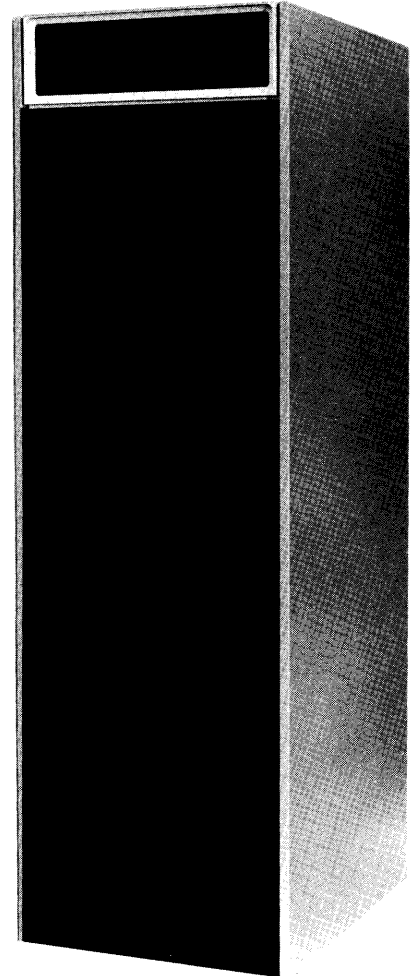

INSTALLATION DATA

Voltage	Current @ 115 Vac	Power/Heat Dissipation	Dimensions			Weight	Operating Temperature	Storage Temperature	Relative Humidity	Maximum Cable Length		
			Height	Width	Depth					I/O	Memory	Device
See Notes 1 and 2	2A Surge: 5A	300W 1000 Btu/hr	69 in. 1.75m	22 in. 0.56m	29 in. 0.72m	300 lbs 140 kg	60° to 95°F 15° to 35°C	40° to 110°F 5° to 45°C	20% to 80%	150 ft 45m	None	None

Note 1: 60 Hz Systems – This unit requires an input of 115V ± 10%, 60 Hz ± 2%, single phase, 2-wire plus ground and is supplied with 25 ft (7.5m) of 3-conductor wire and a Hubbell #3331 cord cap (male plug) which mates with a Hubbell #3330 receptacle. A 30A circuit is recommended for this type of service.

Note 2: 50 Hz Systems – This unit requires an input of 230V ± 10%, 50 Hz ± 2%, single phase, 2-wire plus ground and is supplied with a 3-terminal pressure connector block and 25 ft (7.5m) of 3-conductor wire. Male caps and receptacles are not supplied by DEC. A 15A circuit is recommended for this type of service.

GP10
PDP-10 I/O BUS INTERFACE

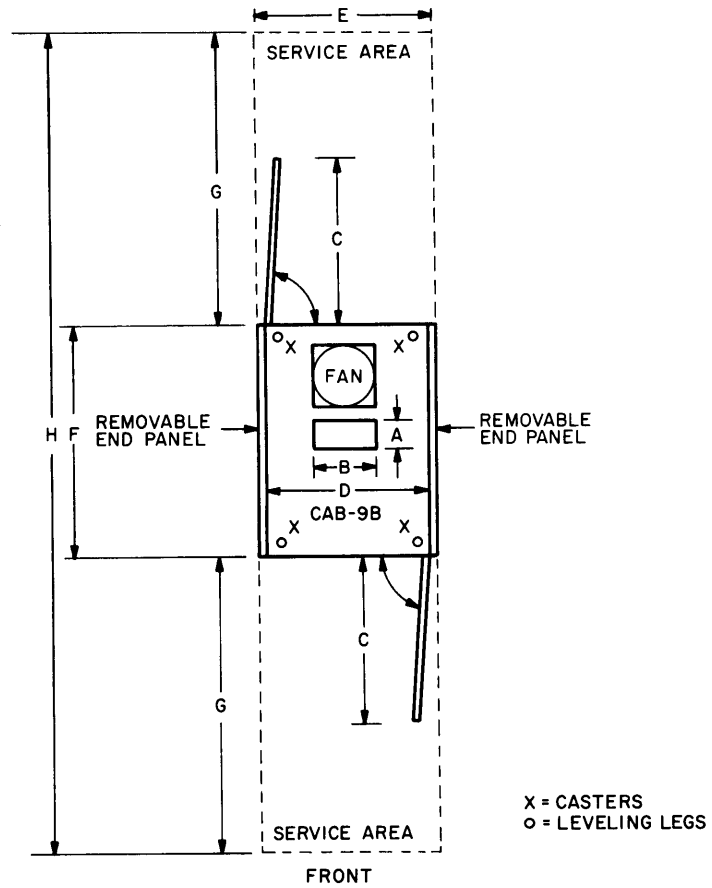

DIMENSIONS	A	B	C	D	E	F	G	H
INCHES	3.5	7.0	19.3	20.3	22.0	29.0	36.0	100
METERS	0.09	0.18	0.49	0.52	0.54	0.72	0.90	2.50

10-0452

PDP-10 Equipment Environmental and Physical Specifications

	Voltage	Current @ 115V	Power/Heat Dissipation	Dimensions			Weight	Operating Temperature	Storage Temperature	Relative Humidity
				Height	Width	Depth				
KA10	115V 60 Hz 230V 50 Hz Three-phase	See Data Sheet	4300W 14,720 Btu/hr	69 in. 1.75m	96.5 in. 2.45m	49.5 in. 1.26m	1930 lb 875 kg	60° to 95°F 15° to 35°C	40° to 110°F 5° to 45°C	20% to 80%
DK10	dc Power supplied by TD10	0.5A @ + 10 Vdc 2.0A @ - 15 Vdc	35W 120 Btu/hr	10.5 in. 0.27m	19 in. 0.48m	6.5 in. 0.17m	25 lb 11 kg	60° to 95°F 15° to 35°C	40° to 110°F 5° to 45°C	20% to 80%
MA10	115V 60 Hz 230V 50 Hz Single-phase	15A Surge: 24A	1600W 5400 Btu/hr	69 in. 1.75m	32.5 in. 0.84m	28 in. 0.71m	750 lb 340 kg	60° to 95°F 15° to 35°C	40° to 110°F 5° to 45°C	20% to 80%
MB10	115V 60 Hz 230V 50 Hz Single-phase	11A Surge: 15A	1200W 4000 Btu/hr	69 in. 1.75m	22 in. 0.56m	29 in. 0.72m	560 lb 260 kg	60° to 95°F 15° to 35°C	40° to 110°F 5° to 45°C	20% to 80%
MD10	115V 60 Hz 230V 50 Hz Single-phase	12A Surge: 20A	1150W 3900 Btu/hr	72 in. 1.83m	22 in. 0.56m	30 in. 0.76m	600 lb 280 kg	60° to 95°F 15° to 35°C	40° to 110°F 5° to 45°C	20% to 80%
MX10	dc Power supplied by DF10	0.5A @ + 10 Vdc 3A @ - 15 Vdc	50W 170 Btu/hr	10.5 in. 0.27m	19.0 in. 0.48m	6.5 in. 0.17m	25 lb 11 kg	60° to 95°F 15° to 35°C	40° to 110°F 5° to 45°C	20% to 80%
DF10	115V 60 Hz 230V 50 Hz Single-phase	5A Surge: 12A	550W 1900 Btu/hr	69 in. 1.75m	22 in. 0.56m	29 in. 0.72m	450 lb 200 kg	60° to 95°F 15° to 35°C	40° to 110°F 5° to 45°C	20% to 80%
RC10	115V 60 Hz 230V 50 Hz Single-phase	5.5A Surge: 9A	650W 2200 Btu/hr	69 in. 1.75m	22 in. 0.56m	29 in. 0.72m	350 lb 160 kg	60° to 95°F 15° to 35°C	40° to 110°F 5° to 45°C	20% to 80%
RM10B	115V 60 Hz 230V 50 Hz Three-phase	See Data Sheet	1100W 4000 Btu/hr	72 in. 1.83m	43 in. 1.09m	30 in. 0.76m	950 lb 400 kg	60° to 90°F 15° to 32°C	40° to 110°F 5° to 45°C	20% to 80%
RD10	115V 60 Hz Three-phase 230V 50 Hz Single-phase	See Data Sheet	800W 2700 Btu/hr	45 in. 1.14m	22 in. 0.56m	45 in. 1.14m	225 lb 100 kg	60° to 95°F 15° to 35°C	40° to 110°F 5° to 45°C	20% to 80%
RP10	115V 60 Hz 230V 50 Hz Single-phase	8A Surge: 15A	900W 3000 Btu/hr	69 in. 1.75m	22 in. 0.56m	29 in. 0.72m	500 lb 230 kg	60° to 95°F 15° to 35°C	40° to 110°F 5° to 45°C	20% to 80%
RP01	115V 60 Hz 230V 50 Hz Three-phase	8A each three drives Surge: 25A	1000W 3500 Btu/hr	38 in. 0.97m	30 in. 0.76m	24 in. 0.61m	300 lb 140 kg	60° to 90°F 15° to 32°C	40° to 100°F 5° to 38°C	10% to 80%
RP02	115V 60 Hz 230V 50 Hz Three-phase	12A each three drives Surge: 25A	1500W 5100 Btu/hr	39 in. 0.99m	30 in. 0.76m	24 in. 0.61m	300 lb 140 kg	60° to 90°F 15° to 32°C	40° to 100°F 5° to 38°C	10% to 80%
TD10	115V 60 Hz 230V 50 Hz Single-phase	4A Surge: 8A	450W 1500 Btu/hr	69 in. 1.75m	22 in. 0.56m	29 in. 0.72m	350 lb 160 kg	60° to 95°F 15° to 35°C	40° to 110°F 5° to 45°C	20% to 80%
TU55	See Data Sheet	2.2A Surge: 2.5A	250W 850 Btu/hr	10.5 in. 0.27m	19.0 in. 0.48m	10 in. 0.25m	40 lb 18 kg	60° to 95°F 15° to 35°C	40° to 110°F 5° to 45°C	40% to 60%

PDP-10 Equipment Environmental and Physical Specifications

	Voltage	Current @ 115V	Power/Heat Dissipation	Dimensions			Weight	Operating Temperature	Storage Temperature	Relative Humidity
				Height	Width	Depth				
TM10	115V 60 Hz 230V 50 Hz Single-phase	2A Surge: 4A	300W 1000 Btu/hr	69 in. 1.75m	22 in. 0.56m	29 in. 0.72m	450 lb 200 kg	60° to 95°F 15° to 35°C	40° to 110°F 5° to 45°C	20% to 80%
TU20	115V 60 Hz 230V 50 Hz Single-phase	6.7A Surge: 10A	800W 2700 Btu/hr	69 in. 1.75m	22 in. 0.56m	29 in. 0.72m	300 lb 140 kg	60° to 95°F 15° to 35°C See Note 1	40° to 110°F 5° to 45°C	40% to 80% See Note 1
TU30	115V 60 Hz 230V 50 Hz Single-phase	6A Surge: 11A	650W 2300 Btu/hr	69 in. 1.75m	30 in. 0.76m	25 in. 0.64m	800 lb 360 kg	60° to 95°F 15° to 35°C See Note 1	40° to 110°F 5° to 45°C	40% to 80% See Note 1
BA10	115V 60 Hz 230V 50 Hz Single-phase	7A Surge: 24A	800W 2700 Btu/hr	69 in. 1.75m	22 in. 0.56m	29 in. 0.72m	350 lb 150 kg	60° to 95°F 15° to 35°C	40° to 110°F 5° to 45°C	20% to 80%
CP10	115V 60 Hz 230V 50 Hz Single-phase	20A Surge: 50A	2500W 8500 Btu/hr	60 in. 1.52m	36 in. 0.91m	36 in. 0.91m	500 lb 230 kg	60° to 95°F 15° to 35°C See Note 1	40° to 110°F 5° to 45°C	20% to 80% See Note 1
CR10	115V 60 Hz 115V 50 Hz Single-phase	16A Surge: 40A	1700 W 5800 Btu/hr	56 in. 1.37m	64 in. 1.67m	36 in. 0.91m	500 lb 230 kg	60° to 95°F 15° to 35°C See Note 1	40° to 110°F 5° to 45°C See Note 1	30% to 90%
				See Data Sheet						
LP10A	115V 60 Hz 230V 50 Hz Single-phase	11A Surge: 15A	1300W 4300 Btu/hr	51 in. 1.30m	43 in. 1.09m	30 in. 0.76m	1100 lb 500 kg	60° to 95°F 15° to 35°C	0° to 125°F -18° to 52°C	40% to 80%
LP10B	115V 60 Hz 230V 50 Hz Single-phase	20A Surge: 30A	2300W 7800 Btu/hr	56 in. 1.42m	56 in. 1.42m	30 in. 0.76m	1600 lb 725 kg	60° to 95°F 15° to 35°C	0° to 125°F -18° to 52°C	40% to 80%
LP10C	115V 60 Hz 230V 50 Hz Single-phase	20A Surge: 35A	2300W 7800 Btu/hr	56 in. 1.42m	56 in. 1.42m	30 in. 0.76m	1900 lb 850 kg	60° to 95°F 15° to 35°C	0° to 125°F -18° to 52°C	40% to 80%
LP10D	115V 60 Hz 230V 50 Hz Single-phase	20A Surge: 35A	2300W 7800 Btu/hr	56 in. 1.42m	56 in. 1.42m	30 in. 0.76m	1900 lb 850 kg	60° to 95°F 15° to 35°C	0° to 125°F -18° to 52°C	40% to 80%
LP10E	115V 60 Hz 230V 50 Hz Single-phase	20A Surge: 35A	2300W 7800 Btu/hr	56 in. 1.42m	56 in. 1.42m	30 in. 0.76m	1900 lb 850 kg	60° to 95°F 15° to 35°C	0° to 125°F -18° to 52°C	40% to 80%
XY10A	See Data Sheet	1.5A Surge: 1.5A	170W 600 Btu/hr	10 in. 0.25m	18 in. 0.46m	15 in. 0.38m	33 lb 15 kg	60° to 95°F 15° to 35°C	40° to 110°F 5° to 45°C	20% to 80%
XY10B	See Data Sheet	1.5A Surge: 1.5A	170W 600 Btu/hr	40 in. 1.02m	54 in. 1.37m	22 in. 0.56m	130 lb 60 kg	60° to 95°F 15° to 35°C	40° to 110°F 5° to 45°C	20% to 80%
				See Data Sheet						
DC10	115V 60 Hz 230V 50 Hz Single-phase	11A Surge: 18A	1000W 3500 Btu/hr	69 in. 1.75m	22 in. 0.56m	29 in. 0.72m	500 lb 230kg	60° to 95°F 15° to 35°C	40° to 110°F 5° to 45°C	20% to 80%
DC68A	115V 60 Hz 230V 50 Hz Single-phase	8A Surge: 13A	900W 3100 Btu/hr	72 in. 1.83m	43 in. 1.09m	30 in. 0.76m	550 lb 250 kg	60° to 95°F 15° to 35°C	40° to 110°F 5° to 45°C	20% to 80%

Note 1: Magnetic tape and punched cards must meet dimensional and handling characteristics, which usually limit the temperature and humidity range.

PDP-10 Equipment Environmental and Physical Specifications

	Voltage	Current @ 115V	Power/Heat Dissipation	Dimensions			Weight	Operating Temperature	Storage Temperature	Relative Humidity
				Height	Width	Depth				
LT33A LT33C	115V 60 Hz 230V 50 Hz Single-phase	1.7A Surge: 2.5A	200W 680 Btu/hr	34 in. 0.86m	19 in. 0.48m	19 in. 0.48m	52 lb 24 kg	60° to 95°F 15° to 35°C	40° to 110°F 5° to 45°C	20% to 80%
LT33B LT33H	115V 60 Hz 230V 50 Hz Single-phase	1.8A Surge: 2.5A	200W 680 Btu/hr	34 in. 0.86m	22 in. 0.56m	19 in. 0.48m	56 lb 26 kg	60° to 95°F 15° to 35°C	40° to 110°F 5° to 45°C	20% to 80%
LT35A LT35C	115V 60 Hz 230V 50 Hz Single-phase	1.7A Surge: 3A	200W 680 Btu/hr	40 in. 1.02m	20 in. 0.51m	28 in. 0.71m	150 lb 70 kg	60° to 95°F 15° to 35°C	40° to 110°F 5° to 45°C	20% to 80%
LT37AC	115V 60 Hz Single-phase	2.2A Surge: 3.5A	250W 860 Btu/hr	37 in. 0.94m	33 in. 0.84m	28 in. 0.71m	220 lb 100 kg	60° to 95°F 15° to 35°C	40° to 110°F 5° to 45°C	20% to 80%
346/340B	115V 60 Hz 230V 50 Hz Single-phase	15A Surge: 20A	1700W 6000 Btu/hr	69 in. 1.75m	42 in. 1.07m	53 in. 1.35m	700 lb 320 kg	60° to 95°F 15° to 35°C	40° to 110°F 5° to 45°C	20% to 80%
348/VR30	115V 60 Hz 230V 50 Hz Single-phase	12A Surge: 17A	1400W 4700 Btu/hr	69 in. 1.75m	22 in. 0.56m	53 in. 1.35m	360 lb 170 kg	60° to 95°F 15° to 35°C	40° to 110°F 5° to 45°C	20% to 80%
VP10	115V 60 Hz 230V 50 Hz Single-phase	2A Surge: 4A	230W 780 Btu/hr	69 in. 1.75m	22 in. 0.56m	29 in. 0.72m	260 lb 120 kg	60° to 95°F 15° to 35°C	40° to 110°F 5° to 45°C	20% to 80%
DA10	115V 60 Hz 230V 50 Hz Single-phase	2A Surge: 6A	200W 700 Btu/hr	69 in. 1.75m	22 in. 0.56m	29 in. 0.72m	300 lb 140 kg	60° to 95°F 15° to 35°C	40° to 110°F 5° to 45°C	20% to 80%
GP10	115V 60 Hz 230V 50 Hz Single-phase	2A Surge: 5A	300W 1000 Btu/hr	69 in. 1.75m	22 in. 0.56m	29 in. 0.72m	300 lb 140 kg	60° to 95°F 15° to 35°C	40° to 110°F 5° to 45°C	20% to 80%