

INTELLEC[®] SERIES II INSTALLATION MANUAL

Manual Order Number 9800559-03

Additional copies of this manual or other Intel literature may be obtained from:

Literature Department
Intel Corporation
3065 Bowers Avenue
Santa Clara, CA 95051

The information in this document is subject to change without notice.

Intel Corporation makes no warranty of any kind with regard to this material, including, but not limited to, the implied warranties of merchantability and fitness for a particular purpose. Intel Corporation assumes no responsibility for any errors that may appear in this document. Intel Corporation makes no commitment to update nor to keep current the information contained in this document.

Intel Corporation assumes no responsibility for the use of any circuitry other than circuitry embodied in an Intel product. No other circuit patent licenses are implied.

Intel software products are copyrighted by and shall remain the property of Intel Corporation. Use, duplication or disclosure is subject to restrictions stated in Intel's software license, or as defined in ASPR 7-104.9(a)(9).

No part of this document may be copied or reproduced in any form or by any means without the prior written consent of Intel Corporation.

The following are trademarks of Intel Corporation and may be used only to describe Intel products:

i	iSBC	Multimodule
ICE	Library Manager	PROMPT
iCS	MCS	Promware
Insite	Megachassis	RMX
Intel	Micromap	UPI
Intelevison	Multibus	μScope
Inteltec		

and the combination of ICE, iCS, iSBC, MCS, or RMX and a numerical suffix.

This manual is intended for the design engineer, programmer, or technician who must install and maintain the Intellec Series II microcomputer development system. It describes, briefly, the Intellec Series II models 220 and 230. It contains the procedures to install the systems, from unpacking to checkout. It also contains troubleshooting and service information and procedures to upgrade the system with Intel products and external peripheral devices.

This manual is divided into the following chapters and appendixes:

- “Introduction,” which briefly describes the models and their features.
- “Installation,” which contains the procedures to unpack, inspect, assemble, and checkout the systems.
- “Troubleshooting” which describes diagnostic features and troubleshooting procedures.
- “Upgrade and Enhancement Procedures,” which contains the procedures to add Intel products and external peripheral devices to increase the system capabilities.
- “Appendix A. Configuring the Serial Interfaces,” which describes the facilities available to customize the serial channel interfaces to specific devices.
- “Appendix B. Power Supply Usage,” which lists the power supply usage by the basic systems and power available for options.
- “Appendix C. Modifying the Baud Rate,” which describes how to change the baud rates for Serial Channel 1 and Serial Channel 2.
- “Appendix D. Teletypewriter Modifications,” which describes how to attach a teletypewriter terminal to the system.
- “Appendix E. Chassis-Signal Ground” which describes how to isolate chassis ground from signal ground.

This manual is part of the Intellec Series II library. The other manuals in the library are:

- *A Guide to Microcomputer Development Systems*, 9800558, which introduces microcomputer development systems in general and the Intellec in particular. It presents an overview of the purposes and uses of development systems.
- *ISIS II User's Guide*, 9800306, which describes the operation of the models 220 and 230.
- *Intellec Series II Schematic Drawings*, 9800554, which contains the system schematic diagrams.



CONTENTS

	PAGE		PAGE
PREFACE		CHAPTER 4	
CHAPTER 1		UPGRADE AND ENHANCEMENT	
INTRODUCTION		PROCEDURES	
The Systems	1-1	Adding RAM To The Model 220	4-1
Model 220 General Description	1-1	Adding the SBC-032 RAM Board	4-1
Model 230 General Description	1-1	Checkout of the SBC-032 RAM Board	4-2
Safety	1-1	Adding the SBC-016 16K RAM Module	4-2
Disk Care	1-4	Checkout of the SBC-016 16K RAM Module	4-3
CHAPTER 2		Adding Diskette Controllers And Drives	4-3
INSTALLATION		Installing a Double Density Disk Controller In	
How To Use This Chapter	2-1	A Model 220	4-4
Initial Inspection And Unpacking	2-1	Checkout of the Disk Drive and Controller	4-7
Inventory	2-1	Installing An Additional Double Density Disk	
Installation Inspection	2-1	Unit in the Model 220 or 230	4-8
Checkout	2-6	Installing the MDS 701/702 Floppy Disk Upgrade	
CHAPTER 3		Kit In The Model 230 Chassis	4-9
TROUBLESHOOTING AND SERVICE		Checkout of Integral Disk Unit	4-17
How To Use This Chapter	3-1	Installing An Expansion Chassis	4-17
Troubleshooting Procedure	3-1	Checkout of the Expansion Chassis	4-19
System Will Not Power Up	3-1	Adding Peripherals	4-19
Malfunctions on Systems That Will Power Up	3-2	Adding In-Circuit Emulators	4-20
Diagnostics	3-3	Adding Multibus Modules	4-20
IPB Diagnostics	3-3	APPENDIX A	
IPB Error Messages	3-4	CONFIGURING THE SERIAL	
IOC Diagnostics	3-5	INTERFACES	
Disk Test	3-7	APPENDIX B	
General Test	3-7	POWER SUPPLY USAGE	
Keyboard/CRT Test	3-8	APPENDIX C	
Confidence Test	3-8	MODIFYING THE BAUD RATE	
Confidence Test Execution	3-8	APPENDIX D	
IPB Test	3-9	TELETYPEWRITER MODIFICATIONS	
Memory Test	3-9	Introduction D-1	
CRT and Keyboard Test	3-10	Internal Modifications D-1	
TTY Test	3-10	External Connections D-1	
Disk Test	3-11	APPENDIX E	
Line Printer Test	3-12	CHASSIS-SIGNAL GROUND	
High Speed Punch Test	3-13		
High Speed Reader Test	3-13		
End of Test	3-14		

1-2	Model 220 Chassis.....	1-2	4-12	CRT Connector and Mounting Screws.....	4-10
1-3	Model 230 Chassis.....	1-3	4-13	MDS-230 Blank Panel Removal	4-11
2-1	Top Cover Chassis Removal	2-2	4-14	Disk Drive Mounting Bracket Mounting	
2-2	MDS-230 Edge Connectors and Socketed			Screws.....	4-12
	Integrated Circuits	2-2	4-15	Disk Drive Mounting Bracket Installation..	4-12
2-3	MDS-220 Edge Connectors and Socketed		4-16	Disk Drive Installation	4-13
	Integrated Circuits	2-3	4-17	Disk Drive Side Mounting Bracket	4-14
2-4	Metal CRT Cover	2-4	4-18	Disk Drive Power Cable Installation.....	4-14
2-5	CRT Connections	2-4	4-19	Disk Drive Power Cable Installation.....	4-15
2-6	Keyboard Cable Connections	2-5	4-20	Disk Drive Interface Cable and Ground Strap	
2-7	Rear Chassis Panel Connections	2-5		Installation.....	4-16
2-8	Intellec Series II Front Chassis Panel	2-5	4-21	MDS-220 Edge Connectors and Socket-	
2-9	Intellec Series II Cardcage	2-6		Mounted Integrated Circuits	4-16
2-10	Integrated Processor Board	2-6	4-22	Cardcage Cable Connections.....	4-17
2-11	Flexible Disk Controller Boards	2-7	4-23	Expansion Chassis Cable Port.....	4-18
2-12	Flexible Disk Drive Installation.....	2-8	4-24	Main Chassis Cable Port	4-18
2-13	Power Cord and Fuse Holder	2-8	4-25	Expansion Chassis Ground Strap	
4-1	SBC-032 Jumper Locations	4-2		Installation.....	4-19
4-2	SBC-016 16K RAM Module Jumper		A-1	Serial 1 Lines and Jumpers	A-1
	Locations	4-3	A-2	Serial 2 Lines and Jumpers	A-1
4-3	MDS-230 Rear Chassis Panel Connections ..	4-4	B-1	Model 220 Power Supply Usage	B-1
4-4	Address Selection Switches on the Channel		B-2	Model 230 Power Supply Usage	B-1
	Board	4-5	B-3	Expansion Chassis Power Availability.....	B-1
4-5	Address Selection Switch Positions		D-1	Teletype Component Layout	D-2
	for 78H.....	4-5	D-2	Current Source Resistor	D-2
4-6	Interrupt Selection Switch on the Interface		D-3	Terminal Block.....	D-2
	Board	4-6	D-4	Teletypewriter Modifications	D-3
4-7	MDS-220 Rear Chassis Panel Disk Drive		D-5	Relay Circuit.....	D-4
	Connector Locations	4-7	D-6	Mode Switch.....	D-5
4-8	Disk Drive Control Cable Routing	4-7	D-7	Distributor Trip Magnet	D-6
4-9	Installing a Second Double Disk Drive	4-8	E-1	Ground Connection on Model	
4-10	Top Chassis Cover Removal	4-9		220 and 230	E-1
4-11	Metal CRT Cover Removal	4-10			



This manual covers three important aspects of using your Intellec Series II Microcomputer Development System:

- Installation
- Troubleshooting
- System upgrade and enhancement

“Installation” gives you step-by-step procedures to follow, from unpacking the shipping cartons through checking out the assembled system.

“Troubleshooting” describes how to narrow problems down to a single part of the system. It tells you how to execute the ROM-based diagnostics and the disk- or paper tape-based confidence tests.

“System upgrade and enhancement” describes how to install and check out the most common additions made to the system.

The Systems

There are two Intellec Series II Microcomputer Development System models:

- Model 220
- Model 230

This manual covers installation and service of both models. Operating instructions for the models 220 and 230 are in the *ISIS-II User's Guide*.

Model 220 General Description

The model 220 is a packaged microcomputer development system that contains a CRT display, keyboard, 32K bytes of RAM, ROM-based monitor and diagnostics, one single-density flexible disk drive, and interfaces for standard development peripherals. The model 220 has five spare card slots in the card cage for additional components. Figure 1-2 shows a model 220.

Model 230 General Description

The model 230 is a packaged microcomputer development system that contains a CRT display, keyboard, 64K bytes of RAM, ROM-based monitor and diagnostics, two double-density flexible disk drives in a separate chassis, and interfaces for standard development peripherals. The model 230 has two spare card slots in the card cage for additional components. Figure 1-3 shows a model 230.

Safety

Most of the procedures in this manual involve working inside the Intellec Series II covers. Hazardous voltages exist inside the system. Do not work inside the covers with the power on unless it is necessary. Power is, of course, necessary during many troubleshooting procedures. Exercise extreme care and do not wear jewelry while working inside the box.

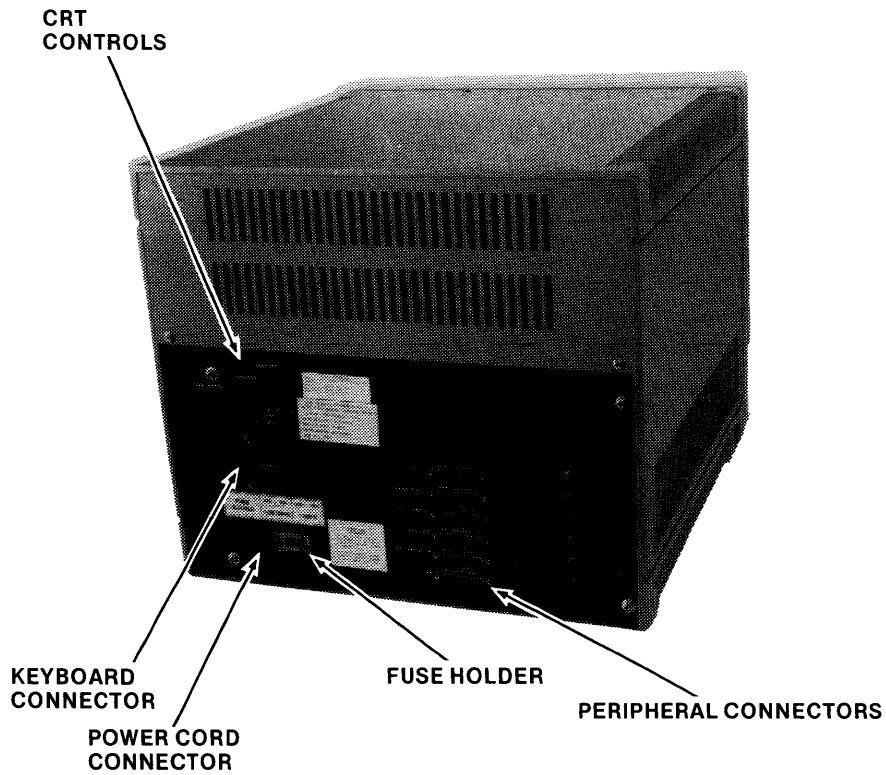
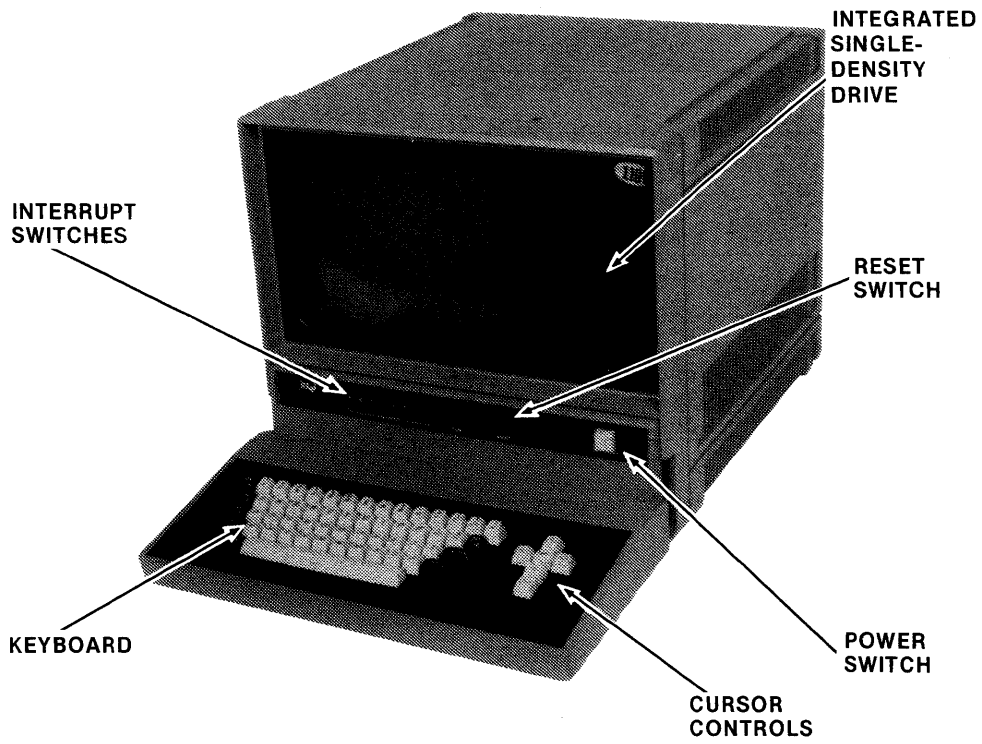

Figure 1-1. MDS-220

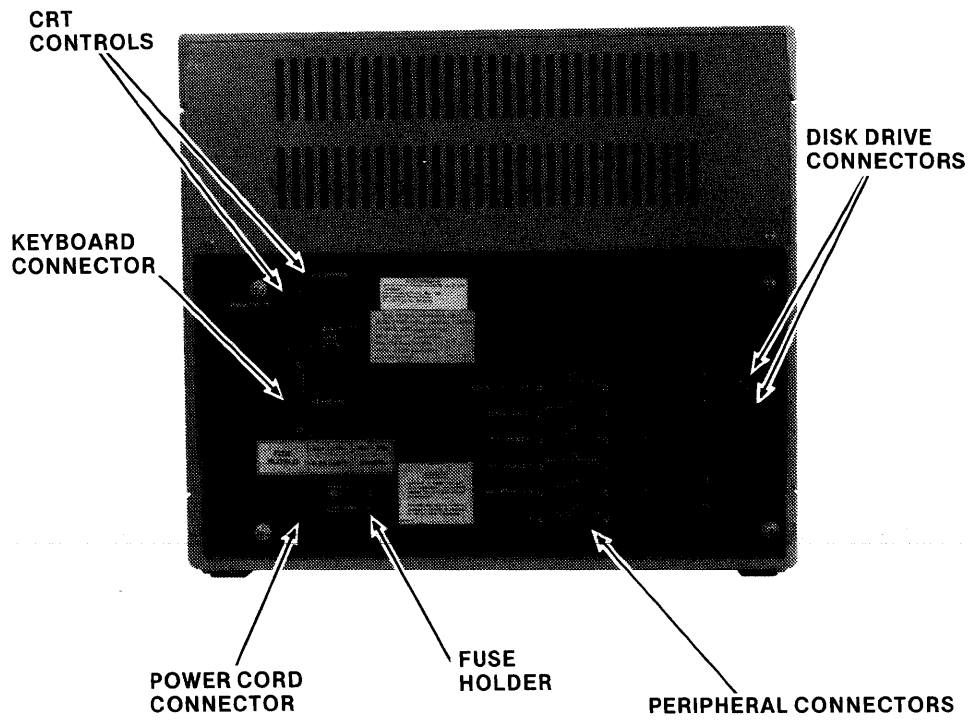
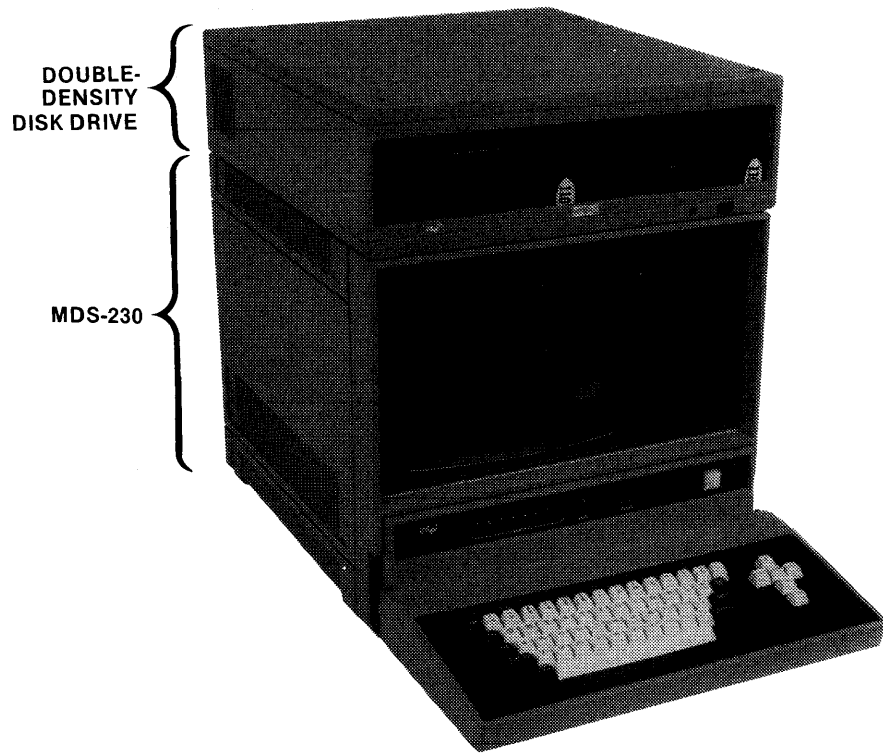

Figure 1-2. MDS-230 With Dual Disk Drive

559-45

Disk Care

The Intellec Series II system uses flexible disks for bulk direct-access storage of data and programs. Flexible disks are reliable and durable if used and handled correctly and sensibly. The following precautions ensure long, trouble-free performance from flexible disks:

- Never touch the recording surface that shows through the holes in the container.
- Never leave flexible disks partially inserted into drive. Store them in their envelopes when not in use.
- Never press the Reset switch on the system front panel while a disk drive light is on. The light indicates that the drive is performing a disk I/O operation. Pressing the Reset switch at this time may destroy some of the data on the disk.
- Never turn off the system or the disk drive power without first removing the disks from all drives on the system. Turning off the power may cause write current to be applied to the recording heads which will destroy some of the data on the disk.



This chapter contains procedures to unpack, inspect, assemble, and check out your Intellec Series II Microcomputer Development System.

If you follow the procedures step by step, you will have your system running in the least amount of time, with little trouble.

You will do some disassembly during these procedures. This is to provide a controlled, limited environment during the checkout procedure. In this way malfunctions, if any, can be pinpointed to a component.

How To Use This Chapter

This chapter covers the installation of both Intellec Series II models. Start with the next section “Initial Inspection and Unpacking” and proceed, section by section, until you are directed to a specific section. When the installation of your model is complete, you will be directed to operating manuals for your system.

If you are told to go to Chapter 3 because of a malfunction, return to the following step after the malfunction is fixed.

Initial Inspection And Unpacking

Unpack the system and look for obvious damage to the exterior. If you find damage, contact your Intel sales representative immediately.

Inventory

The documentation package in which you found this manual contains a checklist of all the parts that should be in the box. Make sure you have everything you should have. If anything is missing, contact your Intel representative.

Installation Inspection

1. If the power cord has been connected to the chassis of your Intellec Series II Model 220 or 230, disconnect it now. Place the system on a surface that allows you access to both the front and back of the chassis. Check that the switch on the rear chassis panel is set to the LINE position.
2. Refer to Figure 2-1. Remove the top cover of the chassis by unscrewing the two screws near the front of the cover and the two screws on the rear of the cover. Lift the top cover off.
3. Refer to Figure 2-2. On the Model 230, there are three edge connectors (J16, J15, and J14, from left to right) at the top of the printed circuit board at the rear of the chassis. The Model 220 has two more connectors, J17 and J18, to the left of J16, shown in Figure 2-3. Carefully remove each, then push it back on firmly to ensure proper seating.
4. There are integrated circuits (two on the Model 230; three on the Model 220) mounted in sockets below the three connectors described in Step 3, and shown in Figure 2-3. Push these firmly into their sockets to ensure proper seating.

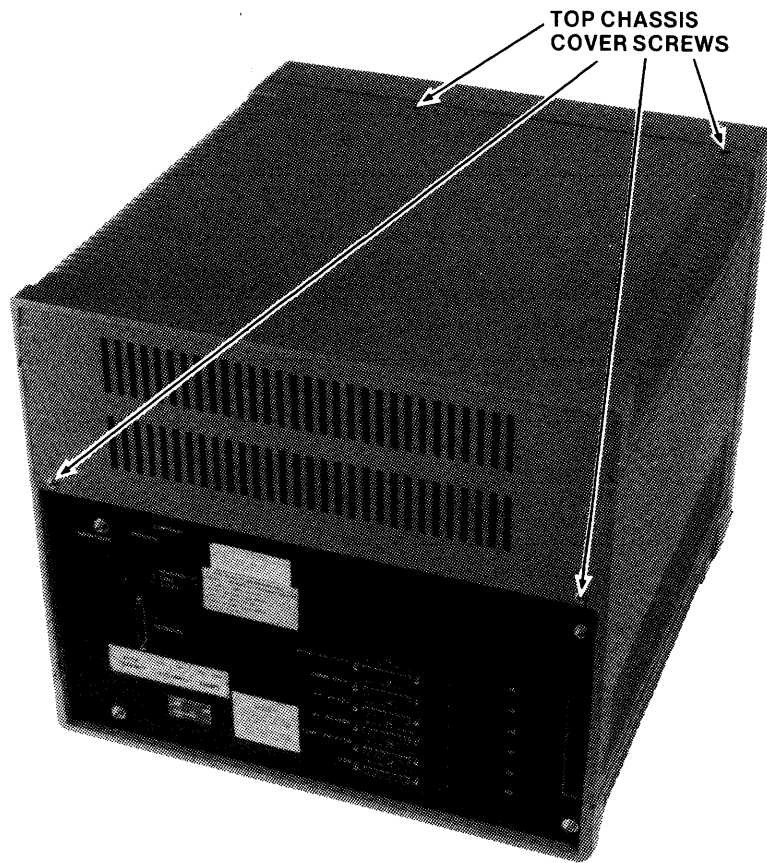

Figure 2-1. Top Chassis Cover Removal

559-46

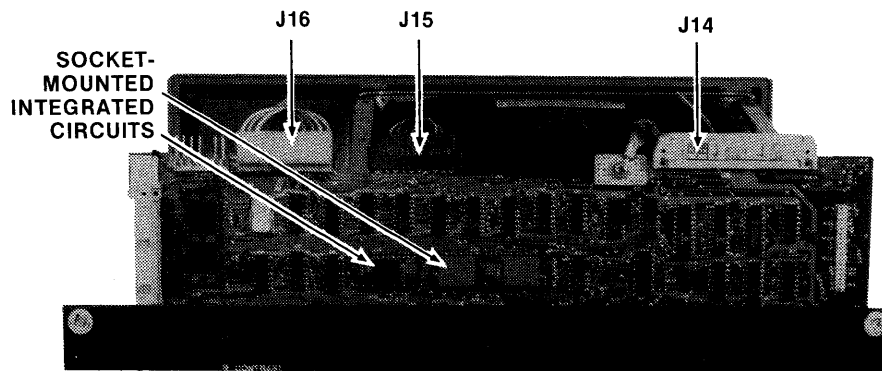

Figure 2-2. MDS-230 Edge Connectors and Socketed Integrated Circuits

559-47

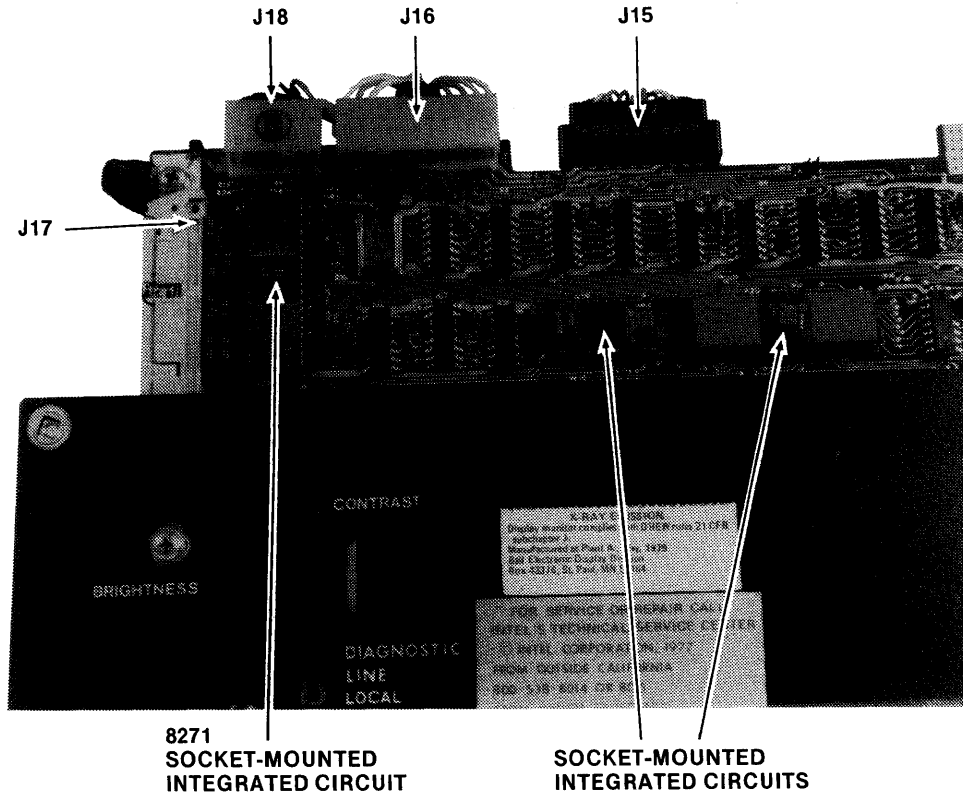

Figure 2-3. MDS-220 Edge Connectors and Socket-Mounted Integrated Circuits

559-48

5. Refer to Figure 2-4. Remove the six retaining screws (three to a side) on the metal shelf covering the cathode ray tube. This exposes the CRT and a small circuit board mounted beneath it on the chassis. Refer to Figure 2-5. Carefully remove the 20-pin connector attached to the rear of the board, then push it on firmly to ensure proper seating.
6. Check the plastic cable protector on the CRT metal shield to make sure it is firmly seated and replace the CRT metal shield and top chassis cover.
7. Refer to Figure 2-6. Disconnect the keyboard cable at the point of connection to the keyboard, then replace it firmly to ensure proper seating. Be certain that the ground wire is attached to the mounting screw next to the keyboard cable plug. Do not route the keyboard cable under the chassis.
8. Insert the chassis connector of the keyboard cable into connector J1 on the rear chassis panel, marked KEYBOARD, shown in Figure 2-7. Be certain to fasten the keyboard cable ground wire to the screw next to the J1 connector. If the ground wire is loose, turn the keyboard over and remove the two screws hold the cover in place. Lift the keyboard top out and fasten the ground wire.
9. Face the front of the system, as shown in Figure 2-8. Remove the front chassis panel by rotating the two mounting screws counter-clockwise and pulling the panel off. Remove the foam packing material. Refer to Figure 2-9, which shows the boards in their slots in the cardcage. Remove the printed circuit board

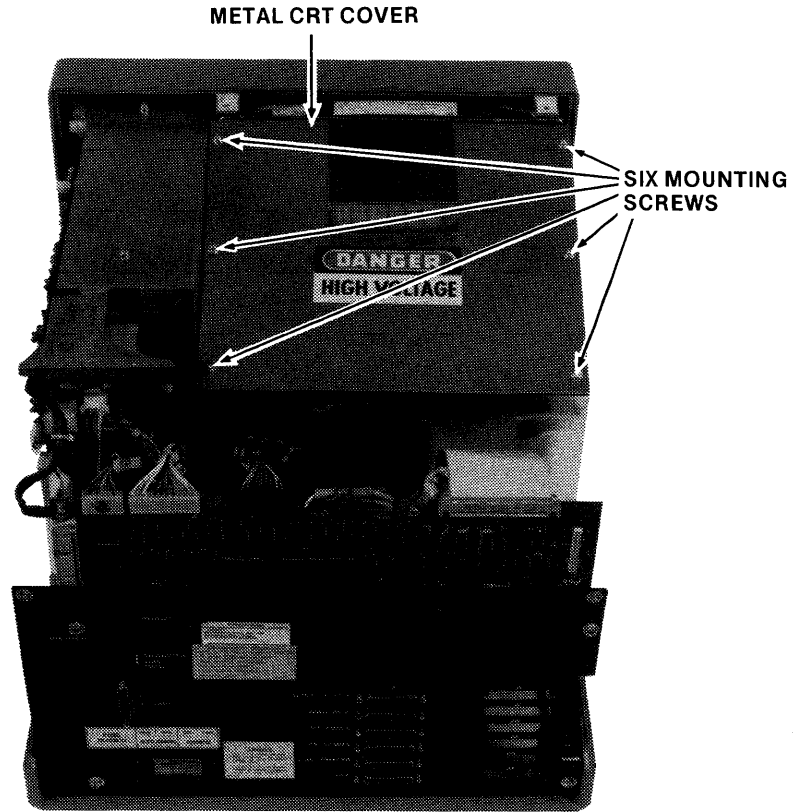

Figure 2-4. Metal CRT Cover

559-50

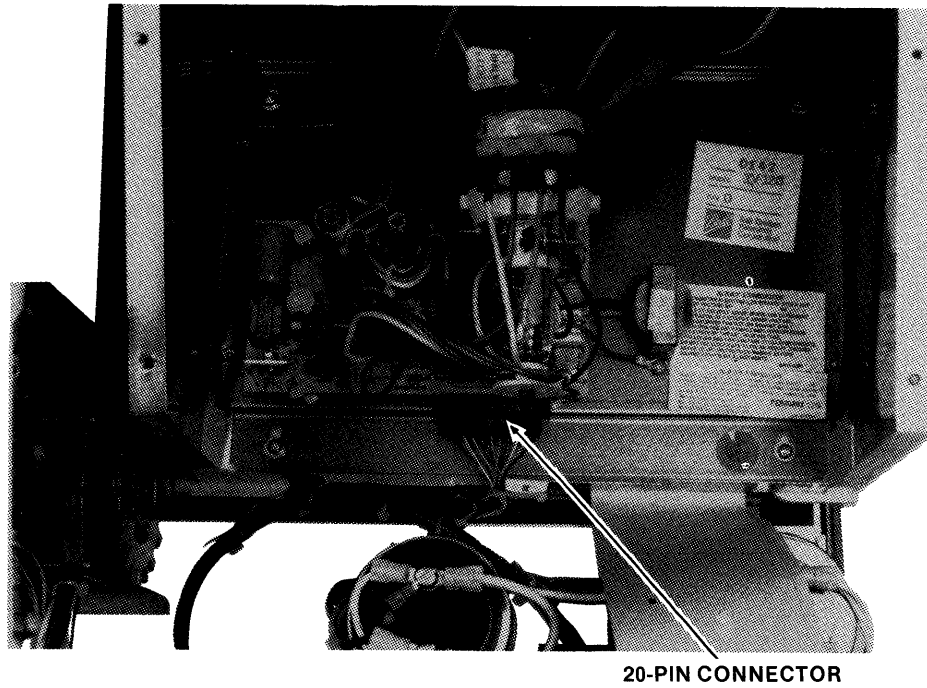

Figure 2-5. CRT Connections

559-51

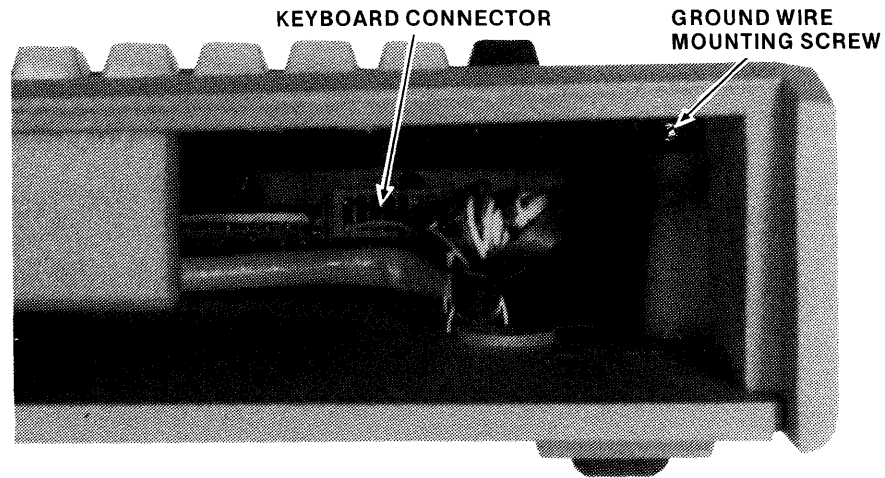

Figure 2-6. Keyboard Cable Connection

559-52

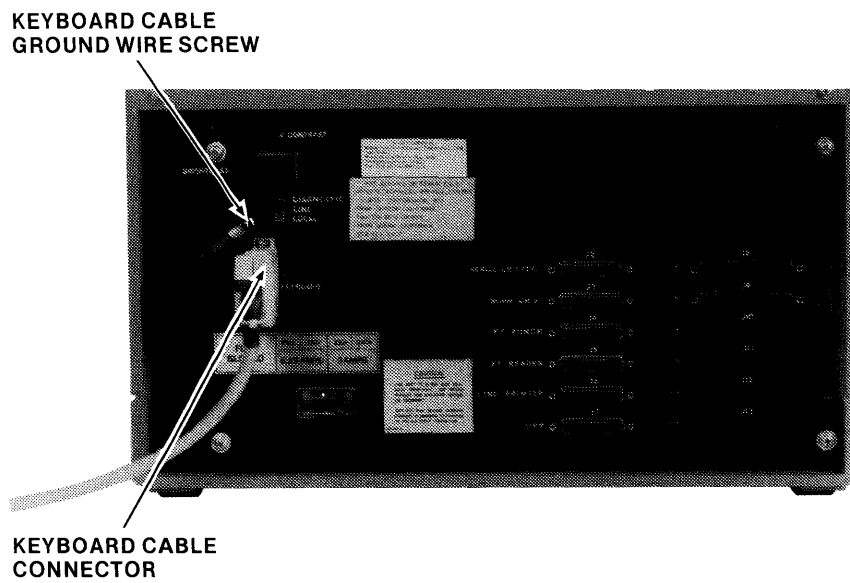

Figure 2-7. Rear Chassis Panel Keyboard Connection

559-53

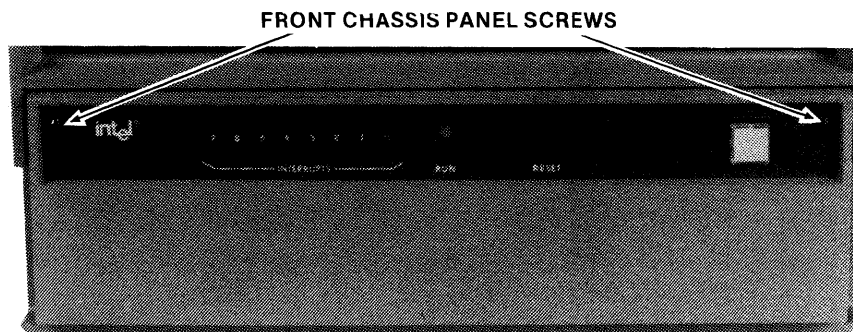

Figure 2-8. Intellec Series II Front Chassis Panel

559-54

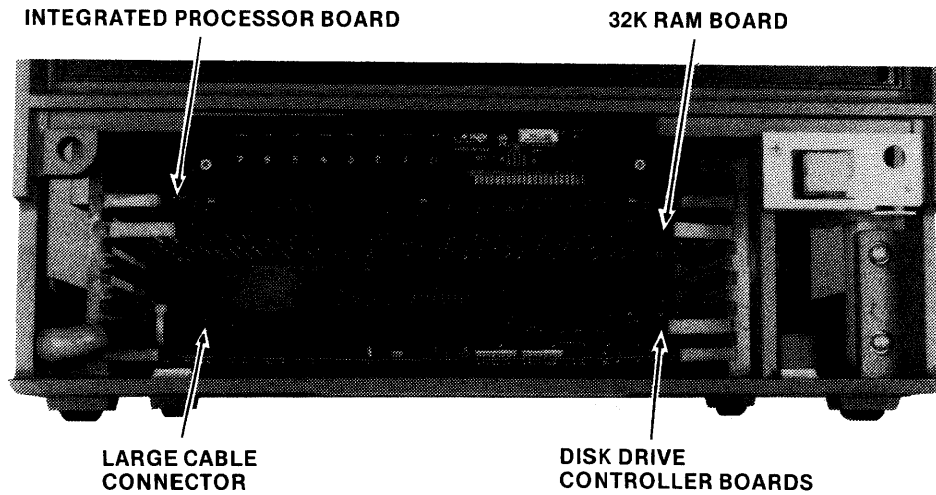

Figure 2-9. Intellec Series II Cardcage

559-55

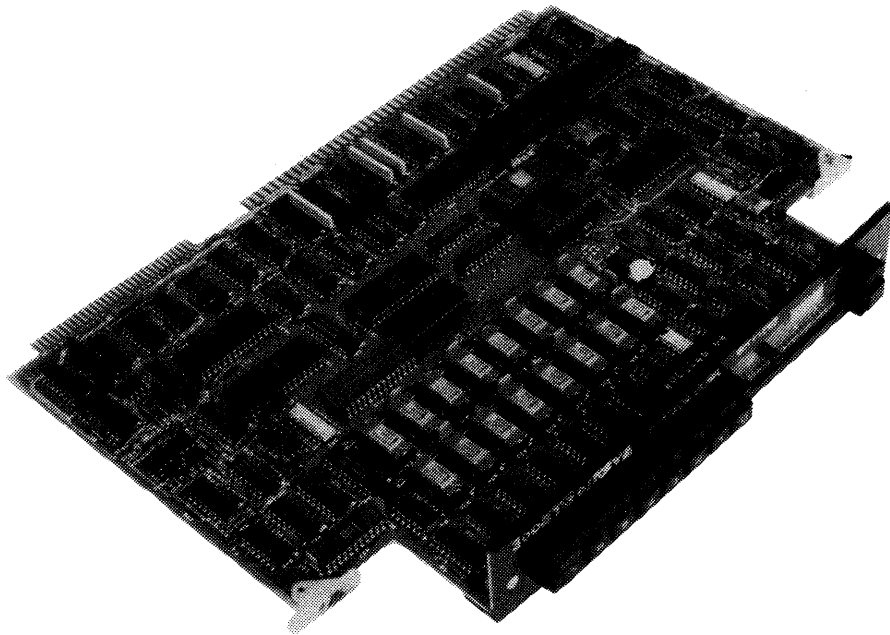

Figure 2-10. Integrated Processor Board

559-56

(Integrated Processor Board, shown in Figure 2-10) mounted in the top slot by pulling out on the board ejectors at each side of the board. Once the board has been removed, push firmly on the integrated circuits mounted in sockets to ensure proper seating. Replace the IPB board in the top slot; push it in firmly until you feel it seat.

10. If you have a Model 220 (which contains a single integrated disk drive) replace the front chassis panel and refer to Step 17 for further information. If you have a Model 230 continue to the next step.

11. Remove the second board down (32K RAM board). Examine the set of gold-colored jumper posts marked ADR SEL. Make sure there are jumpers connecting posts E1 and 10, and posts E4 and E15. Replace the 32K RAM board; push it in firmly until you feel it seat.
 12. Examine the two printed circuit boards (disk controller boards, as shown in Figure 2-11) in the two bottom slots. Remove the large cable connector from the interface board, and then remove both boards at once. You will see a dual auxiliary connector mounted on the left rear, connecting the interface and controller boards. Remove this connector.
-

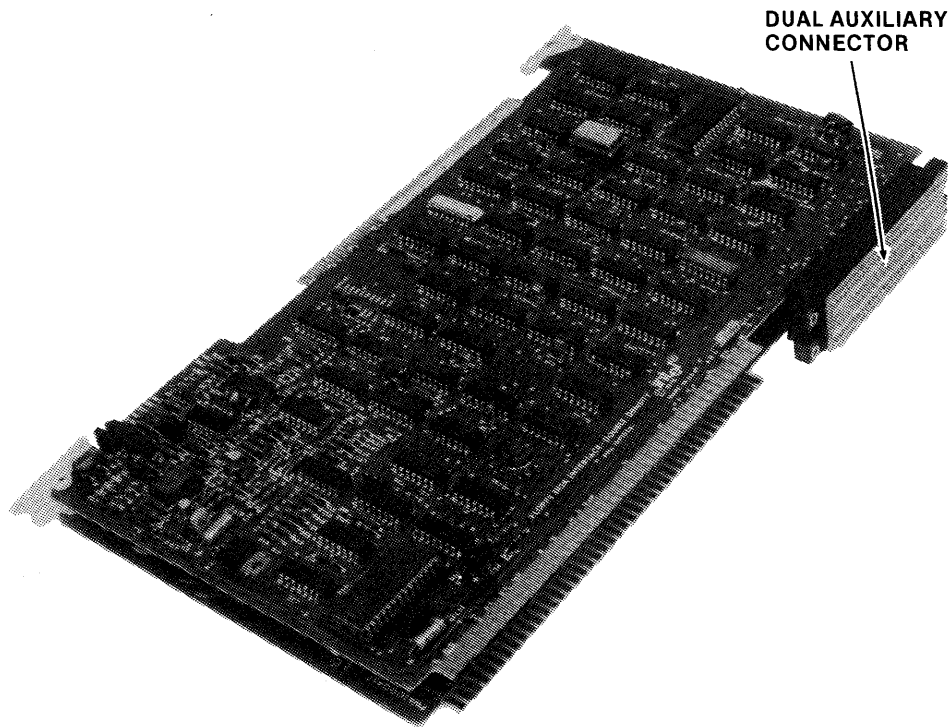

Figure 2-11. Flexible Disk Controller Boards

559-57

13. Examine the controller board. Refer to S1, a light blue rectangular switch package with eight white switches. Switches 1, 2, 3, and 8 should be set to ON; 4, 5, 6, and 7 should be set to OFF. Push firmly on all integrated circuits mounted in sockets to ensure proper seating.
14. Reinstall the dual auxiliary connector, keeping the top and bottom boards in their original positions. Be certain that the connector is properly aligned with the traces brought out to the edge of the board. When you have verified this, replace the two boards in the two bottom slots. Press firmly to ensure proper seating. These boards will seat somewhat less positively than the other two boards, because of the auxiliary connector.
15. Replace the large cable connector on the interface board.
16. Refer to Figure 2-12. Unpack the disk drives and place on top of the Model 230 chassis. Fasten the disk drive cable to the connector on the rear panel of the disk drive chassis and connect the ground wire to the adjacent screw. Fasten the other end of the disk drive cable to connector J8 on the Model 230. Connect the ground wire to the screw adjacent to J8, and attach the two static ground strips to the rear chassis panel as shown in Figure 2-12.

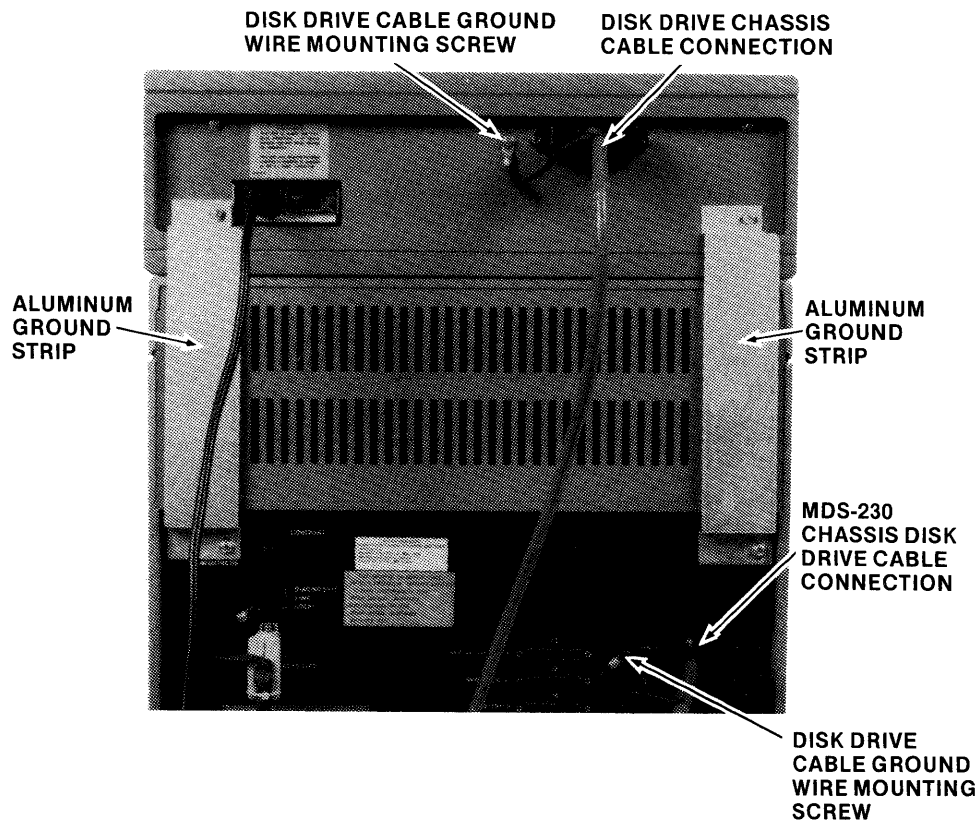

Figure 2-12. Flexible Disk Drive Installation

559-58

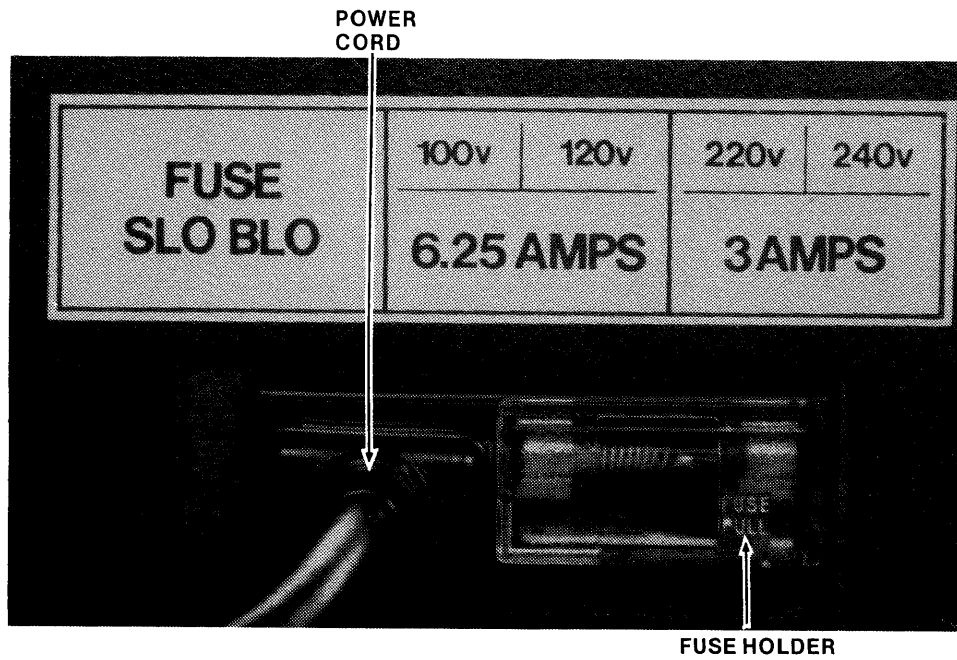

Figure 2-13. Power Cord and Fuse Holder

559-59

17. Refer to Figure 2-13. Slide the plastic shield on the main power socket to the left, remove the voltage switching card, and make sure it is inserted correctly for your line voltage. Since the card accomodates four primary voltages, insert it so that you can read your voltage with the card installed. Check the voltage stickers on the disk drive(s). If this rating differs from the factory voltage switching card setting, contact your Intel representative. Check the rating on the installed fuse. Be certain it matches the ratings listed on the sticker directly above the fuse holder. After you have checked the voltage switching card and the fuse, slide the plastic cover back and reconnect the AC power cord.
18. This completes the installation inspection of your Series II MDS 220/230. Read the checkout section to test your system's operation.

Checkout

There are three tests to perform on a model 220 or 230:

- The Monitor-based diagnostic test. This test checks the functions of the IOC board, parallel I/O, RAM, and evaluates checksums.
- The IOC diagnostics. This test checks the keyboard and disk drive(s) and performs a general system check.
- The disk-based Confidence Test. This test verifies the functioning of the following hardware facilities and peripherals:
 1. Integrated Processor Board (IPB)
 2. Random Access Memory (a minimum of 32K, addressed at locations 0-32K, plus any additional memory, contiguous or not)
 3. CRT and keyboard
 4. Flexible disk drives (if installed)
 5. Teletypewriter (if installed)
 6. Line Printer (if installed)
 7. High-speed paper tape reader (if installed)
 8. High-speed paper tape punch (if installed)

After completing the installation inspection, the system is ready to test. These three tests verify its operation and let you proceed to program development with minimum delay.

The instructions for running these tests, along with descriptions of test results, are in "Chapter 3: Troubleshooting."



The Intellec Series II Microcomputer Development System is designed for easy troubleshooting and repair. Its modular design makes it possible to quickly isolate a problem to a module or peripheral device.

The Integrated Processor Board (IPB) has ROM-based diagnostics that are always available. The Input/Output Controller (IOC) in the models 220 and 230 has ROM-based diagnostics. The diagnostic routines that do not modify memory or require operator intervention are executed each time the system is turned on and each time the Reset button is pressed. A copy of the Intellec Series II Confidence Test is shipped with each system.

Be sure to read and keep the "Service Support" brochure shipped with the system. This letter contains a description of Intel's service facilities and brochure Hot Line telephone numbers for immediate assistance and the fastest possible replacement of malfunctioning parts.

How To Use This Chapter

When you have a problem with your Intellec Series II, always follow the appropriate troubleshooting procedure from the beginning. The procedure is designed to narrow the problem down to a single failing system assembly or peripheral device. The procedure does not attempt to isolate the problem to a chip or module on a board, only to the board itself. The procedure does not attempt to isolate a problem within a peripheral device, only to the whole device. When a problem is isolated to a peripheral device, go to the troubleshooting information in the device documentation manual. When the procedure calls for the execution of a diagnostic, see the Diagnostic subsection of this chapter for operating directions. When a diagnostic encounters a failure, an error message appears on the console.

Troubleshooting Procedure

This section contains two troubleshooting procedures, one for a unit that will not power up and one for a unit that will power up but otherwise will not function properly.

System Will Not Power Up

This procedure covers the situation when the system does nothing; that is, the fans don't run, no lights light, and nothing appears on the screen. Before opening the chassis, make sure:

- The system is plugged in.
- There is power at the wall socket.
- The main power fuse is not blown.

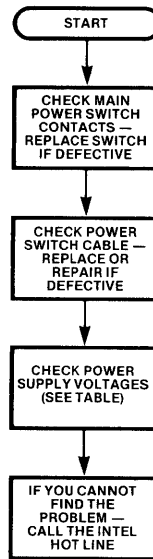

Models 220 & 230 Power Supply Test Points

Check at connector “A” at input to IOC board.

Pin	Voltage
1	+24V
2	+24V return
3	+5V
4	Key
5	sig gnd
6	sig gnd
7	+12V
8	-10V
9	-12V
10	frame grrd
11	+15V
12	+15V return

Malfunctions on System That Will Power Up

To isolate a malfunction, follow the procedure in this section. Before beginning this procedure disconnect all peripheral devices attached to the back panel. Then remove all cards from the card cage except the IPB. You will replace the devices and cards one by one to isolate the problem.

After you have isolated and repaired the problem, run the Confidence Test (described later in this chapter).

If you cannot reproduce the original problem with the diagnostics, try the Confidence Test.

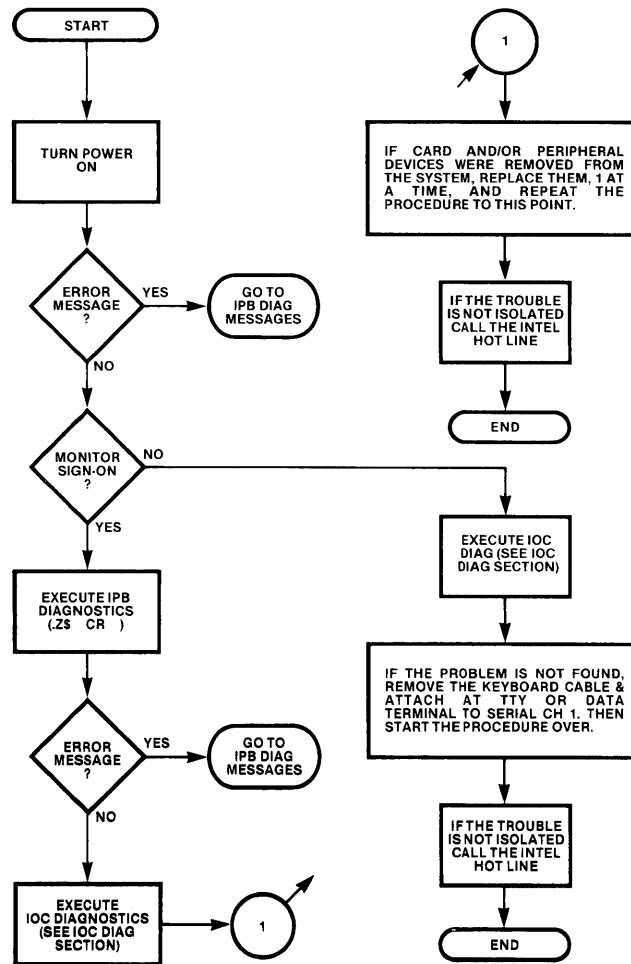

Diagnostics

The Intellec Series II has two sets of diagnostic routines:

- IPB diagnostics, which test the major features of the IPB and invoke the non-interactive diagnostics of the IOC (in the models 220 and 230).
- IOC diagnostics, which test the major features of the IOC in the models 220 and 230. The IOC diagnostics that require user intervention are not executed when invoked by the IPB diagnostics.

IPB Diagnostics

The IPB diagnostics are invoked in any of three ways: by a Monitor command, when the system is turned on, and when the Reset button is pressed. When invoked by the Monitor command, the entire set of diagnostics is executed.

To execute the diagnostics with the Monitor command, you must first put the Monitor in control of the system by pressing the interrupt 0 button or turning on the system without a system disk loaded. Enter the Diagnostic command:

.Z\$ CR

\$ represents the dollar sign key on the keyboard, not the ESC or ALT MODE character.

As each test starts, the message:

TESTING function

is displayed on the screen. function is CHECKSUMS, IOC, PIO, or RAM.

When the test completes without error, the message expands:

TESTING function — PASSED

If errors are detected, error messages are displayed:

TESTING function

FAILURE - error message

The Diagnostic Messages section of this chapter lists and explains the diagnostic error messages.

NOTE

On a system with less than 64K of memory you get one or two error messages indicating a failure in RAM blocks 32K through 48K and 48K through 64K. A 32K system gets both messages and a 48K system gets just one message. This is normal for systems with less than 64K of RAM.

When you press RESET or when you turn the system on, all tests but the RAM functional test are performed. The RAM test destroys the contents of memory from 10H to the highest address available to the user. The test writes known data patterns into memory and then reads them. It does not destroy the Monitor work areas.

The initiation and successful completion messages do not display when the diagnostics are invoked by the Reset button or when turned on. However, if errors are detected, error messages are displayed.

IPB Error Messages

The following messages are issued by the IPB diagnostics.

FAILURE -- BOOT CHECKSUM

The expected checksum was not obtained from the BOOT ROM.
Replace the IPB.

FAILURE -- IOC CHECKSUM

The expected checksum was not obtained from the IOC ROM.
Replace the IOC board.

FAILURE -- IOC INTERRUPTS

An expected interrupt from the IOC did not occur. The problem could be in the IOC board or in the interrupt circuitry in the IPB. The IPB is more likely to be at fault.

FAILURE -- IOC NOT RESPONDING

The IPB diagnostics attempted to execute the IOC diagnostics but got no response from the IOC. This may be a loose cable or card. Check all connections and make sure all cards are seated in their sockets. If that does not eliminate the error, replace the IOC. Other IOC errors may follow this one. Ignore any other error messages until this problem is fixed.

FAILURE -- IOC RAM

The diagnostic routine did not read the same data written into the IOC RAM. Replace the IOC board.

FAILURE -- MONITOR CHECKSUM

The expected checksum was not obtained from the Monitor ROM. Replace the IPB.

FAILURE -- PIO CHECKSUM

The expected checksum was not obtained. Replace the IOC board.

FAILURE -- PIO INTERRUPTS

An expected interrupt from the PIO did not occur. The problem could be in the PIO circuitry or in the interrupt circuitry in the IPB. The IPB is more likely to be at fault.

FAILURE -- PIO NOT RESPONDING

The IPB diagnostics attempted to execute the IOC diagnostics but got no response from the PIO portion. This may be a loose cable or card. Check all connections and make sure all cards are seated in their sockets. If that does not eliminate the error, replace the IOC board. Other PIO errors may follow this one. Ignore any other error messages until this problem is fixed.

FAILURE -- PIO RAM

The diagnostic routine did not read the same data written into the PIO RAM. Replace the IOC board.

FAILURE -- RAM BANK mmK-nnK

A RAM failure was encountered in the area of RAM specified in the message. The possible values for mmK-nnK are 0K - 32K, 32K - 48K, and 48K - 62K. One of these error messages is issued for each bank of RAM that is not installed in the system. For example, a 32K system issues this message twice, once for the 32K - 48K bank and once for the 48K - 62K bank.

IOC Diagnostics

There are two phases of IOC diagnostics. The first phase executes automatically when the IOC diagnostics are initiated. The first phase tests those parts of the IOC that are needed to execute the second phase.

To execute the IOC diagnostics, set the Diagnostic/Line/Local switch on the rear chassis panel to Diagnostic. Then press the AC power switch, if power is off, or press the RESET switch if power is on.

When the IOC Diagnostics begin, five tests take place, in the order described below. As each test successfully completes, a beep sounds. If any test fails, fewer than five beeps sound, and the failing test can be pinpointed by the number of beeps heard. For example, if you only hear two beeps, the third test failed.

The first beep signifies that the following devices have passed inspection, in this order:

- a. 8080A
- b. 8224
- c. 8228
- d. 8253
- e. IOC Address Bus
- f. IOC Data Bus
- g. ROM Checksum

The second beep signifies that the following functions are operating properly:

- a. DMA Function
- b. RAM Refresh

The third beep verifies RAM operation.

The fourth beep signifies that the following functions are operating properly:

- a. CRT DMA
- b. CRT Timing

The fifth beep does not presently signify test completion. It is reserved for future diagnostic routines.

After the fifth beep, the following message appears:

SERIES II IOC DIAGNOSTIC, Vx.y

If the message does not appear, there is a problem in the CRT or its drive circuitry.

Next you are requested to type four characters from the keyboard. This tests the keyboard, keyboard cable, and keyboard interface. The request is in the form of the following message:

TYPE CNTL-@, RUBOUT, "U", and "%"

As each character is received, the expected character and its binary representation and the received character and its binary representation are displayed. If the two differ, an error message also appears:

REQUESTED		RECEIVED		
CRTL-@	00000000	CRTL-@	00000000	
RO	01111111	RO	01110111	ERROR 00001000
U	01010101	U	01010101	
%	00100010	%	00101010	ERROR 00010000

The first phase completes by displaying a menu of the tests available in the second phase. These tests are:

- The disk test, which only tests the integral disk drive on the model 220.
- The general test, which checksums the firmware in the IOC.
- The keyboard/CRT test, which echoes a full screen of whatever character is pressed on the keyboard.

When the IOC Diagnostics are completed, remove the disk from the drive and reset the Diagnostic/Line/Local switch to Line. Press Reset once and the Monitor signs or again.

Disk Test

The Disk Test is started by pressing the D key on the keyboard. The IOC Disk Test only evaluates the integral drive in a model 220. It does not test the double density drives on a model 230 or any single or double density drives and controllers added to a model 220 or model 230.

If the system does not have an integral drive installed, the following message is displayed on the display screen:

NO INTEGRAL DISK

If there is a drive installed, the following message is displayed:

INSERT SCRATCH DISK AND TYPE “#”

Be sure to use a scratch disk (a disk that doesn't have any data you want to save). Any data on the disk is destroyed during the test. After you press the # key, the disk is formatted and a random pattern written and then read back. If the test completes successfully, the following message is displayed:

TEST PASSED

If there is an error, one of the following messages is displayed:

READ ERROR

which indicates that the data read from the disk differs from what was written.

ERROR nnnnnnnn

which indicates that the disk driver returned a nonzero status byte. The bits in the byte have the following meanings:

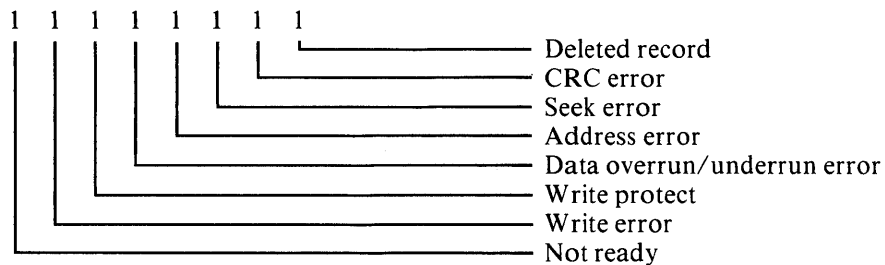

General Test

The General Test is started by pressing the G key on the keyboard. This test checksums the IOC firmware. If the test executes successfully, the following message is displayed:

TEST PASSED

If the checksums are incorrect, the following message is displayed:

TEST FAILED

Keyboard/CRT Test

The Keyboard/CRT test is started by pressing the K key on the keyboard. This test first fills the screen with a test pattern of 95 printing ASCII characters. The test then fills the screen with any character that is typed on the keyboard. (Control characters are displayed as uparrow-character (↑x) and Rubout is displayed as RO.)

End the test by pressing the ESC key or the space bar.

When the IOC Diagnostics are completed, remove the disk from the drive and reset the Diagnostic/Line/Local switch to Line. Press RESET and the Monitor signs on again.

Confidence Test

The Intellec Series II Confidence Test is a diskette- or paper tape-based verification test that exercises standard Intellec Series II modules and input/output devices. With certain exceptions, the test returns a pass or fail indication. The exceptions are the CRT, TTY, and line printer tests that require you to examine what is displayed or printed.

The test verifies the functioning of:

- IPB
- RAM (minimum of 32K located at 0-32K, plus any additional contiguous and non-contiguous blocks of memory).
- CRT and keyboard (if installed)
- Single- and double-density diskette drives (if installed)
- Teletypewriter (if installed)
- Line printer (if installed)
- High Speed Paper Tape Reader (if installed)
- High Speed Paper Tape Punch (if installed)

The Confidence Test is partially interactive. Several of the tests require some response from the operator. If the response is not received within a predetermined period of time, the particular test is not executed and the program proceeds to the next test.

The Confidence Test is not a replacement for the ROM-based diagnostics but an expansion to the system diagnostic capability. The confidence test checks input/output devices that the ROM-based diagnostics do not check.

Confidence Test Execution

To start the Confidence Test in a diskette system, load the diskette in drive 0 and press the Reset button on the front panel. The test programs are loaded and execution begins.

To start the Confidence Test in a paper tape system, load the paper tape in the reader and issue the Monitor read command (R0). The test programs are loaded into memory and you can start execution by entering a Monitor Execute (G) command.

When the test begins execution, the following message is displayed:

```
INTELLEC SERIES II CONFIDENCE TEST, Vx.y
```

where x.y is the version and release number of the test.

Tests can be aborted during execution by entering Control-C (press the C key while the CTRL key is depressed). This results in the following message:

TEST ABORTED

The next test is then started. If any other key is pressed during execution, the following message is displayed:

TEST RUNNING, STRIKE CONTROL-C TO ABORT

The test continues to execute after this message is displayed.

You can abort all the tests except the IPB Test. The IPB Test executes too quickly to allow abort capability.

IPB Test

The IPB Test executes 8080 instructions and verifies the result of each.

The test begins with the message:

PROCESSOR TEST

At the successful completion of the test, the program displays:

PROCESSOR TEST PASSED

If an error occurs, the test terminates with the address of the failure:

PROCESSOR TEST nnnn

where nnnn is the address where the failure occurred. (This address is displayed as a normal function of the Monitor and cannot be used to determine the exact failure.) If a failure is encountered in the IPB Test, control is passed to the Monitor. The remaining tests are not executed because results are meaningless if the IPB is malfunctioning.

Memory Test

If the IPB Test completed without error, execution proceeds to the Memory Test. All the installed RAM except the areas used by the Monitor and by the confidence test itself is tested. The test consists of writing known patterns into RAM and then reading from RAM and comparing the data.

The Memory Test starts with the following message:

MEMORY TEST (1 MIN)

1 MIN specifies that the test takes approximately one minute.

For each contiguous block of memory the following message is displayed:

TESTING RAM xxxx-yyyy

where xxxx is the beginning address of the block and yyyy is the ending address. If no errors occur in the memory block, the following message is displayed:

TESTING RAM xxxx-yyyy PASSED

If an error occurs, the following is displayed:

TESTING RAM xxxx-yyyy #FAILED#

If there is more RAM installed, it is tested. When all installed RAM is tested, the test proceeds to the next test.

You can abort the test by entering Control/C.

CRT and Keyboard Test

The CRT and Keyboard Test displays the full character set on the CRT and then echos all input from the keyboard to the CRT.

The CRT and Keyboard Test starts with the message:

CRT TEST

If a CRT is not installed, the following message is displayed:

CRT TEST #CRT NOT READY#

If the CRT is installed, the test displays two lines of the ASCII character set on the CRT. It then prompts for keyboard input:

ECHO CHARACTERS FROM CRT KEYBOARD UNTIL ESC KEY ENTERED

The test will echo on the CRT everything you type on the CRT keyboard. To make sure the ESC key functions correctly, press it to exit the Keyboard Test. If no input from the keyboard is received within 10 seconds of the last input, the test ends with the message:

TIME OUT, NO KEYBOARD INPUT FOR 10 SECONDS

The detection of errors in the CRT and Keyboard Test is up to the operator. You should observe all displays to make sure the correct characters are being read from the keyboard and displayed on the CRT.

TTY Test

The TTY test checks the TTY keyboard, printer, punch, and reader. If the punch and reader are not turned on when the program requests, they are not tested. The test begins with the message:

TTY TEST

If a TTY is attached to the system, two lines of the ASCII character set are printed. Then the following message is displayed:

ECHO CHARACTERS FROM TTY KEYBOARD UNTIL ESC KEY ENTERED

The program echoes back to the TTY all keys that are pressed on the TTY keyboard. Strike any TTY key to continue. This phase of the test is ended by pressing the ESC key or by not pressing any key for 10 seconds. If there is no TTY attached, or if you let the program time out, the following message is displayed:

TIME OUT, NO KEYBOARD INPUT FOR 10 SECONDS

The program then prompts to have the reader/punch turned on:

TURN ON TTY PUNCH
STRIKE CONSOLE ESC KEY (1 MIN)

If the punch/reader is not turned on and the ESC key is not pressed within one minute, the program times out with the message:

TIME OUT, NO KEYBOARD INPUT FOR 1 MINUTE

If you press the ESC key the test punches a null leader, two lines of the ASCII character set, and a null trailer. It then displays the messages:

TURN OFF TTY PUNCH
LOAD PUNCHED TAPE IN TTY READER
STRIKE CONSOLE ESC KEY

Press the ESC key on the keyboard after you load the paper tape that was punched in the punch test. If the ESC key is not pressed within one minute, the program times out with the message:

TIME OUT, NO KEYBOARD INPUT FOR 1 MINUTE

If errors are encountered while reading the tape, that is, if the program does not read what it punched, the following message is displayed:

#TTY DATA ERRORS#

The test cannot determine if the error occurred during the punch or read operation. You should check the code on the tape to determine if it was punched correctly, or read the paper tape on a system known to be reliable.

Disk Test

The Disk Test checks all drives on the system regardless of the density. The test requires scratch disks in each drive to be tested. The program prompts when it is ready for the scratch disks.

WARNING

Be sure to replace the disk containing the Confidence Test with a scratch disk. If the disk is not write-protected, the test destroys the disk contents.

The test begins with the message:

DISKETTE TEST

If there are no disk controllers in the system, the following message is displayed:

#NO DISKETTE CONTROLLER PRESENT#

If there are disk controllers, the program continues with the following warning and prompt:

WARNING: DISKETTE FILES ON DRIVES TESTED WILL BE DESTROYED

LOAD WRITE ENABLED SCRATCH DISKETTE INTO ANY DRIVE TO BE TESTED

STRIKE CONSOLE ESC KEY (1 MIN)

If there is no input for one minute, the following message is displayed:

TIME OUT, NO KEYBOARD INPUT FOR 1 MINUTE
DISKETTE DRIVES NOT TESTED

The test starts with drive 0 and proceeds through all the possible drives, 0 through 5. As the test of each drive begins, the following message is displayed:

TESTING DRIVE #n

where n is the drive number. After this message is displayed, the test waits three seconds before starting the test. **This is your last chance to abort the test if you did not load a *scratch* disk.** To abort, press Control-C or open the drive door.

Any one of the following error messages may be displayed for each drive:

#NO DISKETTE CONTROLLER PRESENT#
#UNEXPECTED I/O COMPLETE#
#DRIVE STATUS CHANGE#
#TIME OUT#
#DRIVE NOT READY#
#WRITE ERROR#
#WRITE PROTECTED#
#DATA OVERRUN#
#DATA/ADDRESS MARK ERROR#
#ADDRESS MARK ERROR#
#ID CRC ERROR#
#SYNC ERROR#
#ADDRESS ERROR#
#SEEK ERROR#
#DATA CRC ERROR#
#DELETED RECORD ERROR#

If no errors are encountered the passed message is displayed:

PASSED

Line Printer Test

The Line Printer Test checks high and low speed printers. The test prints the full character set on the printer. You must check the printed material to make sure it is correct and lined up. The Line Printer Test checks for a line printer in the system.

The test begins with the message:

LINE PRINTER TEST

If no printer is present or it is powered off, the following message is displayed and the program waits 10 seconds for the printer to be turned on:

#LINE PRINTER NOT READY#

TEST WAITING 10 SECONDS FOR DEVICE "READY"

You have 10 seconds to make the printer ready. If it becomes ready during the 10 seconds, the following message is displayed:

NOW PRINTING ASCII CHARACTER SET

The program prints 20 lines of the ASCII character set on the printer. You must examine the printout to determine the success or failure of the test.

If the printer is not present or made ready within 10 seconds, the time out message is displayed, and the next test is started.

High Speed Punch Test

The High Speed Punch Test checks for a high-speed punch in the system. The test begins with the message:

HIGH SPEED PUNCH TEST

If no punch is present or is powered off, the following message is displayed and the program waits 10 seconds for you to turn the punch on:

#HIGH SPEED PUNCH NOT READY#

TEST WAITING 10 SECONDS FOR DEVICE "READY"

You have 10 seconds to make the punch ready. If it becomes ready during the 10 seconds, the following message is displayed:

NOW PUNCHING ASCII CHARACTER SET

The program punches a null header, two lines of the ASCII character set, and a null trailer. You may examine the paper tape to determine the success or failure of the test, or you can use the tape as input for the high speed reader test.

High Speed Reader Test

The High Speed Reader Test checks for a high speed reader in the system. The test begins with the message:

HIGH SPEED READER TEST

If no reader is present or is powered off, the following message is displayed and the program waits 10 seconds for you to turn the reader on:

#HIGH SPEED READER NOT READY#

TEST WAITING 10 SECONDS FOR DEVICE "READY"

You have 10 seconds to make the reader ready. If it becomes ready during the 10 seconds, the following message is displayed:

LOAD HIGH SPEED READER WITH TAPE FROM TTY OR HIGH SPEED PUNCH TEST

STRIKE ANY CONSOLE KEY (1 MIN)

The test reads the tape and displays the following message if it encounters any unexpected data:

#HIGH SPEED READER DATA ERROR#

The program cannot determine if the error occurred during punching or reading. You must determine where the error is by examining the punched tape.

End of Test

At the completion of all the tests, the program displays the end message:

END OF CONFIDENCE TEST

Control of the system is returned to Monitor. You can rerun the tests by entering the Monitor Execute (G) command. No starting address is required; the Confidence Test starting address is still in the program counter (P register).



CHAPTER 4 UPGRADE AND ENHANCEMENT PROCEDURES

This chapter contains the procedures to upgrade your Intellec Series II to increase functional capability. The procedures covered are:

- Adding memory to the Model 220
- Adding disk drives
- Adding an expansion chassis
- Adding peripherals:
 - CRT Terminal
 - TTY
 - MDS-PRN Printer
 - MDS-770/771 Printer
 - High Speed Tape Reader and Punch
 - Universal Prom Programmer
- Adding in-circuit emulators
- Adding Multibus modules

NOTE

Before adding components to be powered from the Series II power supply, make sure that the power supply has the capacity to handle the extra current. Appendix B contains tables of current supply ratings for each of the power supplies for each model.

Adding RAM To The Model 220

The Intellec Series II model 220 comes with 32K of RAM. You can upgrade the RAM with the addition of an SBC-032 32K RAM board, or 1 or 2 SBC-016 16K RAM Modules. When an SBC-032 is added, it supplies RAM addresses 32K through 64K. The SBC-016 16K RAM Module can be used to supply address spaces 32K through 48K or 48K through 64K.

Adding the SBC-032 RAM Board

You can insert the SBC-032 RAM board into any available socket in the card cage. Before installing the board, make sure the following jumpers are in place for operation in the system as memory locations 32K through 64K. The correct jumper positions are shown in the following table. Figure 4-1 shows the location of these jumpers.

ADDRESS SELECTION JUMPERS		TIMING SELECTION JUMPERS	
Location	Jumper	Location	Jumper
W1	E1-E10	W8	E29-E31
W2	E4-E15	W12	T50-L1
W5	E5-E21		
W6	E7-E17		
W7	E8-E18		

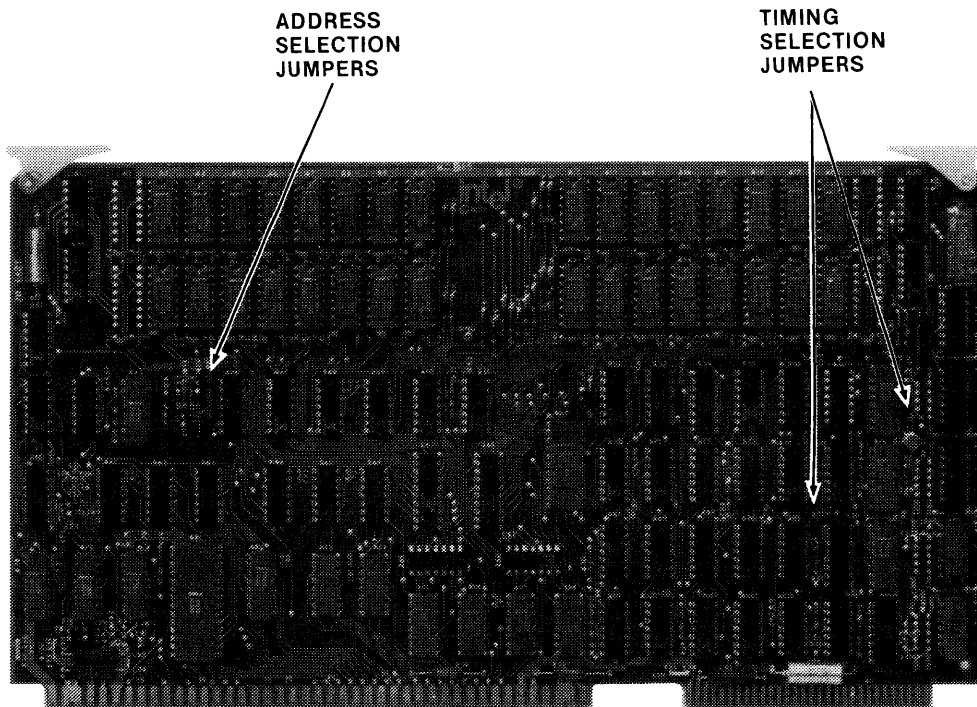

Figure 4-1. SBC-032 Jumper Location

559-9

After checking the jumpers, do the following:

1. Turn the system power off.
2. Remove the front panel by turning the screws at either end a quarter turn counter-clockwise and pulling the cover off.
3. Insert the SBC-032 in any available slot in the card cage. Make sure the board is seated in the socket.
4. Replace the front panel and tighten the screws.

Checkout of the SBC-032 RAM Board

Check out the SBC-032 in the system with the following procedure:

1. Press the main power button. Do not load a disk in the disk drive.
2. Execute the IPB diagnostics by entering:
`.Z$CR`

If errors messages are displayed, see the "Diagnostic Messages" section in Chapter 3.

Adding the SBC-016 16K RAM Module

You can insert the SBC-016 16K RAM Module into any available socket in the card cage. Before installing the board, make sure the jumpers are in place for operation in the model 220 or 230. The correct jumper positions are listed in the following table. Figure 4-2 shows the locations of the jumpers.

ACKNOWLEDGE SELECT JUMPER	MODULE SELECT JUMPER	
	Memory Space	Jumper
1-2	32K-48K	7-6
	48K-64K	7-5

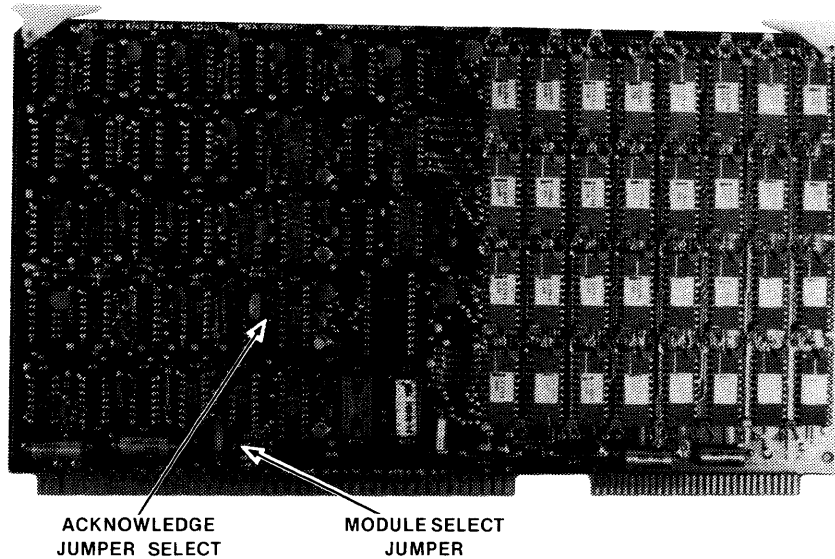

Figure 4-2. SBC-016 16K RAM Module Jumper Locations

559-26

After checking (and adjusting if necessary) the jumpers, do the following:

1. Turn the system power off.
2. Remove the front panel by turning the screws at either end a quarter-turn counterclockwise and pulling the cover off.
3. Insert the board(s) in any available slot in the card cage. Make sure the board is seated in the socket.
4. Replace the front panel and tighten the screws.

Checkout of the SBC-016 16K RAM Module

Check out the SBC-016 16K RAM Module in the system with the following procedure:

1. Press the main power button. Do not load a disk in the disk drive.
2. Execute the IPB diagnostics by entering:
.Z\$ CR

If errors messages are displayed, see the “Diagnostic Messages” section of Chapter 3.

Adding Disk Controllers And Drives

You can add a single- or double-density controller to the models 220 or 230. You must have two adjacent card cage slots available for the controller. The controllers for both the single or double-density drives consists of an interface board, a channel board, and a dual auxiliary connector.

The single-density controller handles two single-density drives. The double-density controller handles four double density drives.

The Model 230 has a double-density disk controller installed in the card cage. This model comes with two double-density disk drives. The Model 230 has two disk interface connectors on the back panel, as shown in Figure 4-3. The top connector interfaces with drives 0 and 1. The bottom connector interfaces with drives 2 and 3 (if installed).

NOTE

If you move 2-card components from an Intellec Microcomputer Development System to an Intellec Series II, you cannot use the auxiliary connector from the old system. The spacing between the Series II card cage slots is smaller. Use one of the spare auxiliary connectors shipped with the Series II system.

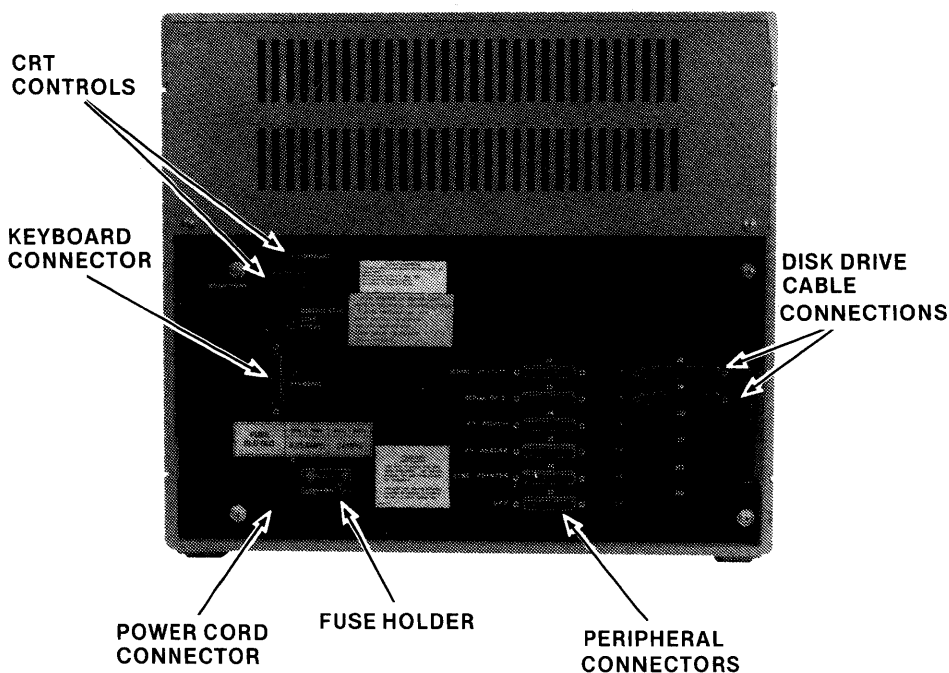

Figure 4-3. MDS-230 Rear Chassis Panel Connections

559-60

The model 220 has a single-density disk controller on the IOC board. This model comes with one drive mounted in the main chassis. If no other drives are installed, this drive is designated drive 0.

Installing A Double-Density Disk Controller In A Model 220

The double-density disk controller consists of two boards, an interface board and a channel board. Together these boards are referred to in this manual as the controller.

The two controller boards communicate with each other through a 60-pin auxiliary connector supplied with the boards. The controller interface board communicates with the drives through the Flexible Disk Controller cable which is plugged into the 100-pin connector on the upper edge of the interface board. The channel board also

has a 100-pin connector on the upper edge, but this connector is only used for tests during problem analysis. The other end of the controller cable has two connectors that are mounted on the Intellec Series II back panel in spaces marked J8 and J9.

Before installing the controller you must assign a base address to the channel board and set the interrupt level on the interface board. ISIS-II requires a base address of 78H. Set the base address switches, shown in Figure 4-4 to the positions shown in Figure 4-5.

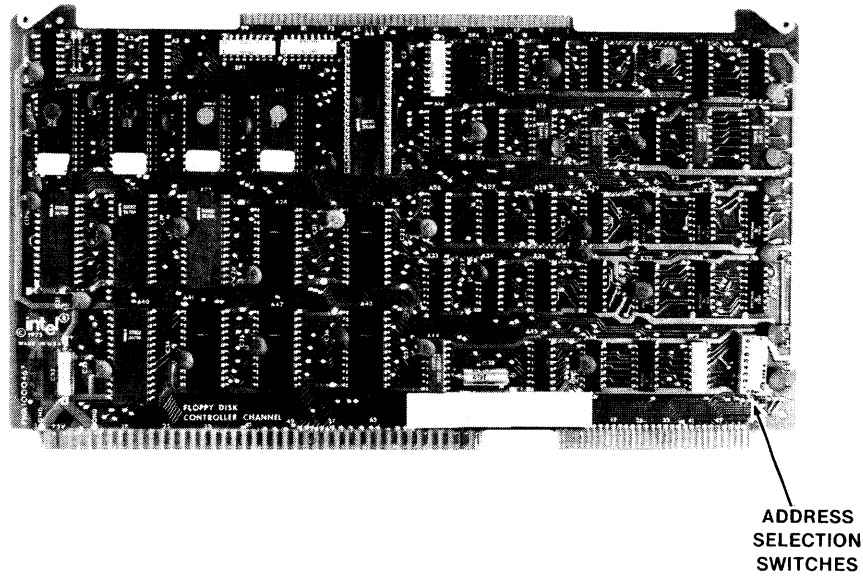

Figure 4-4. Address Selection Switches on the Channel Board

559-28

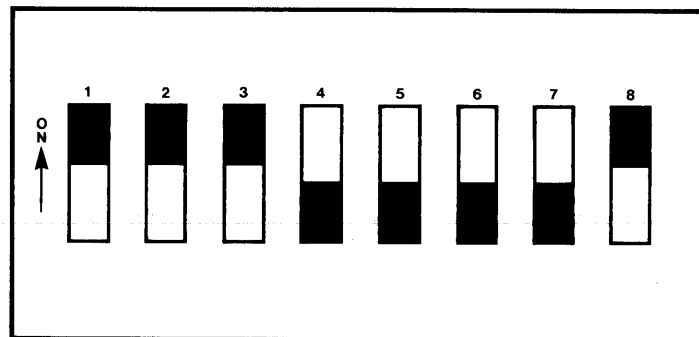

Figure 4-5. Address Selection Switch Pointers for 78H

559-30

ISIS-II requires an interrupt level of 2. Set the interrupt selector switch, shown in Figure 4-6, to position 3 (interrupt level 2).

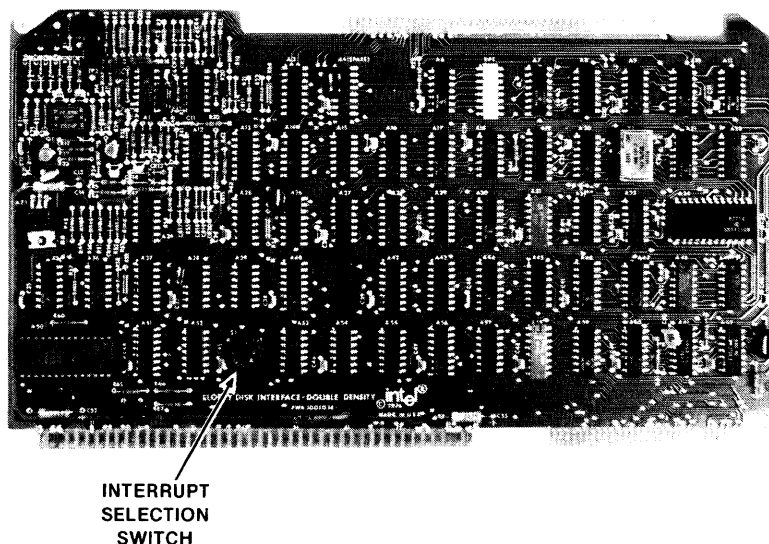

Figure 4-6. Interrupt Selection Switch on the Interface Board

559-29

Now install the disk controller according to the following procedure:

1. Turn off the system.
2. Refer to Figure 2-1. Remove the top cover of the main chassis. The cover is held in place with two screws on the top front and two screws on the back panel. Remove the screws and lift the cover off.
3. Remove the front panel.
4. Choose two adjacent slots in the card cage for the disk controller cards.
5. Insert the two cards into the 60-pin auxiliary connector. This connector will not be physically attached to the mother board.
6. Insert the cards (in the auxiliary connector) into the card cage slots, shown in Figure 2-9. Press them firmly into the bus sockets.
7. Install the two connectors on the disk control cable in the holes marked J8 and J9 on the back panel as shown in Figure 4-7. Put the connector for drives 0 and 1 in the top hole and drives 2 and 3 in the bottom hole. Attach the connectors with hardware supplied with the controller.
8. Dress the cable along the side of the main chassis as shown in Figure 4-8.
9. Plug the 100-pin plug into the edge connector on the upper edge of the interface card.
10. Replace the main chassis top cover.
11. Place the disk drive on top of the main chassis and install the rear panel static straps as shown in Figure 2-12.
12. Plug the disk interface cable into the top connector on the back panel of the main chassis. Plug the other end of the cable into the connector on the disk unit. Be sure to connect the ground wire lug to the screw adjacent to both connectors. Refer to Figure 2-12.

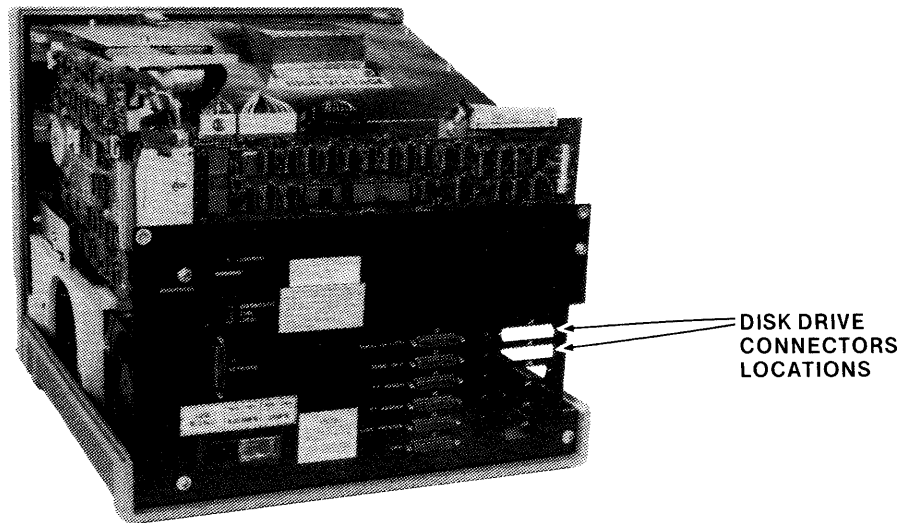

Figure 4-7. MDS-220 Rear Chassis Panel Disk Drive Connector Locations 559-61

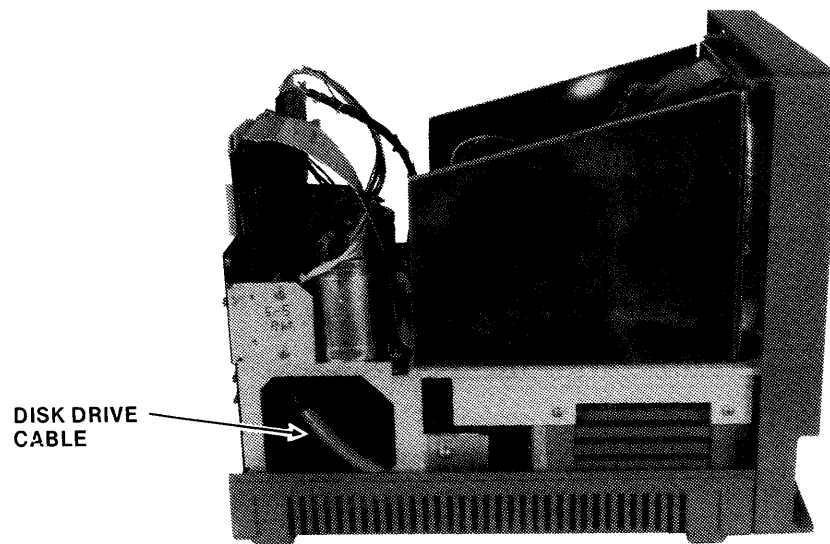

Figure 4-8. Disk Drive Control Cable Routing 559-62

Checkout of the Disk Drive and Controller

Check out the disk drives and controller in the system with the following procedure:

1. Turn the disk unit power on but do not load a disk.
2. Press the main power button on the main chassis.
3. Execute the IOC diagnostics (see "Diagnostics" in Chapter 3). If any error messages were displayed, see the "Diagnostic Messages" section of Chapter 3.
4. Put a Diagnostic Confidence Test disk in drive 0. Drive 0 is now the right-hand drive in the new disk drive unit. The chassis-mounted drive is now drive 4 (Model 220).
5. Press RESET and make sure the test loads and displays the sign on message.
6. Execute the diagnostic disk tests described in Chapter 3.

Installing an Additional Double Density Disk Unit in the Model 220 or 230

This procedure covers the addition of a two-disk-drive unit to a model 230 or to a model 220 that has a double-density disk controller installed.

You can install the two drive units by simply plugging it into the additional disk interface connection on the back panel, below the current disk interface cable. Be sure to attach the ground wires to the screws next to the drive connector and next to the chassis connector, and install the static ground straps, as shown in Figure 4-9.

These drives will have addresses F2 and F3.

Check out the new drives with the Confidence Test, described in Chapter 3.

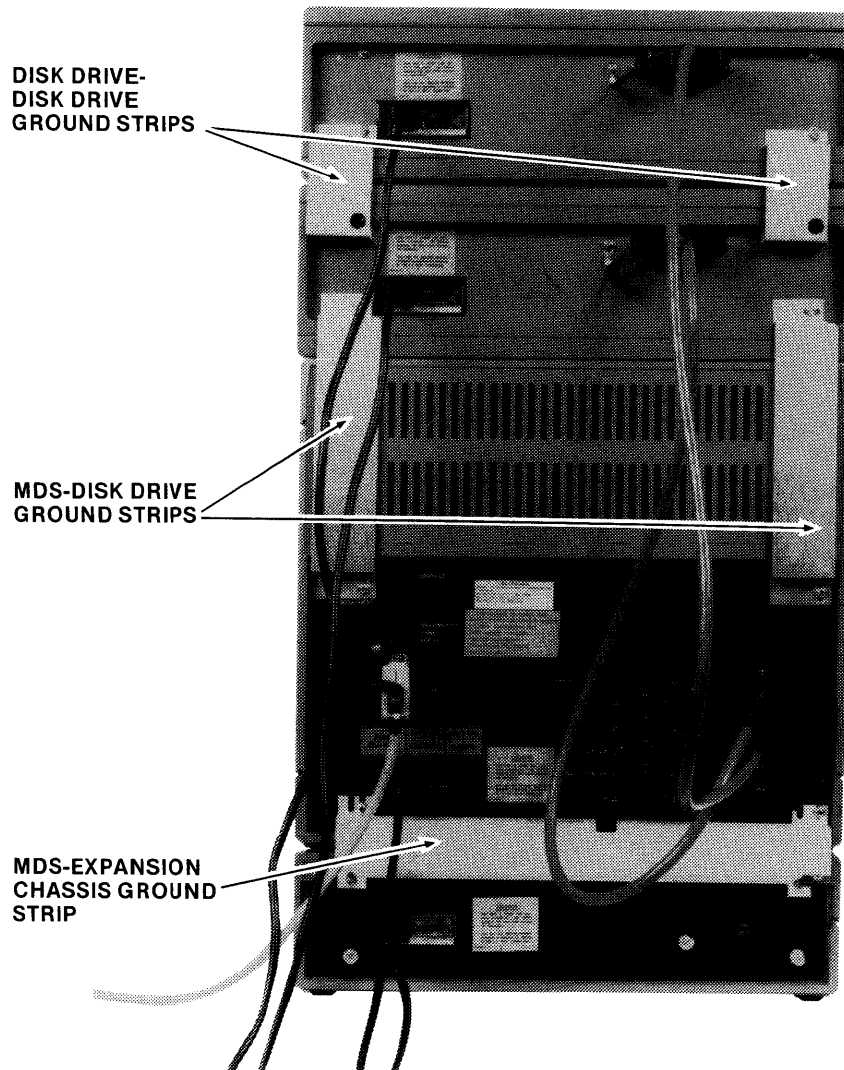

Figure 4-9. Installing a Second Double Disk Drive

559-63

Installing The MDS 701/702 Floppy Disk Upgrade Kit In The Model 230 Chassis

The MDS 701/702 Floppy Disk Upgrade Kit contains a single-density flexible disk drive that installs within the Model 230 chassis. Follow these steps to install and check out the installed disk drive:

1. Compare the materials in the kit and the list of parts to see if any are missing. Be sure that the disk drive supplied has the same voltage rating as your Model 230.
2. Unplug the power cord from the rear of the chassis.
3. Remove the top chassis cover screws, as shown in Figure 4-10.
4. Remove the metal CRT cover by unfastening the six screws shown in Figure 4-11.
5. Unscrew the CRT from the chassis. Figure 4-12 shows the four screws that fasten the CRT to the chassis. Slide the CRT to the side; it is not necessary to remove it completely.

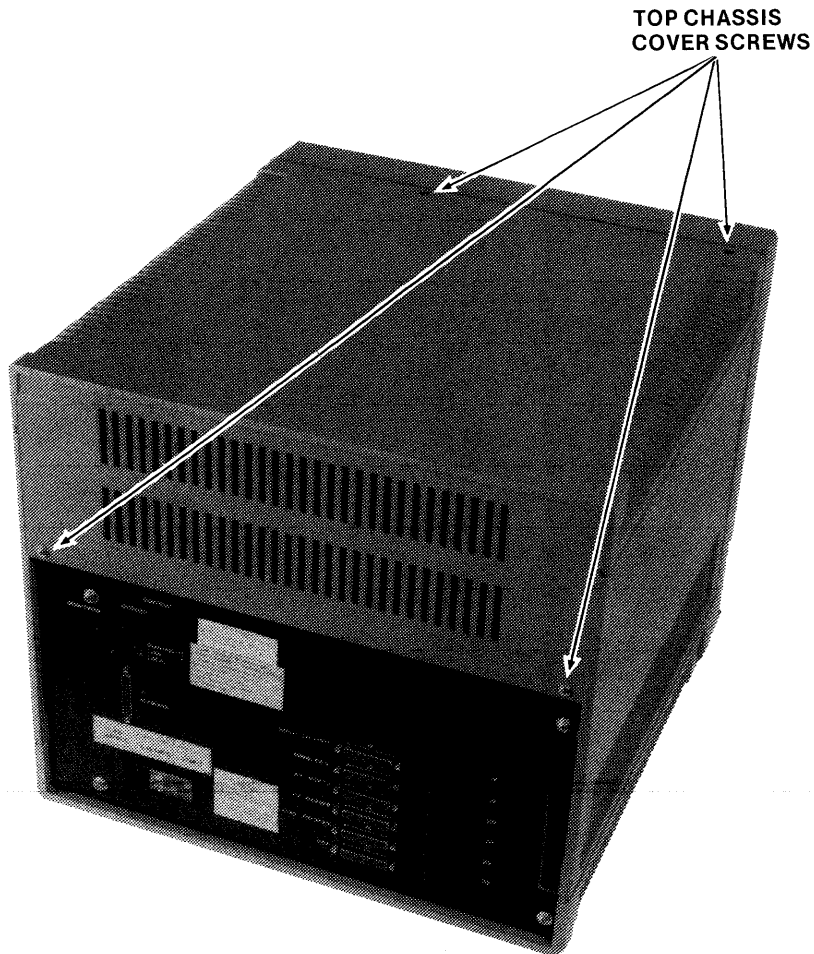

Figure 4-10. Top Chassis Cover Panel

559-46

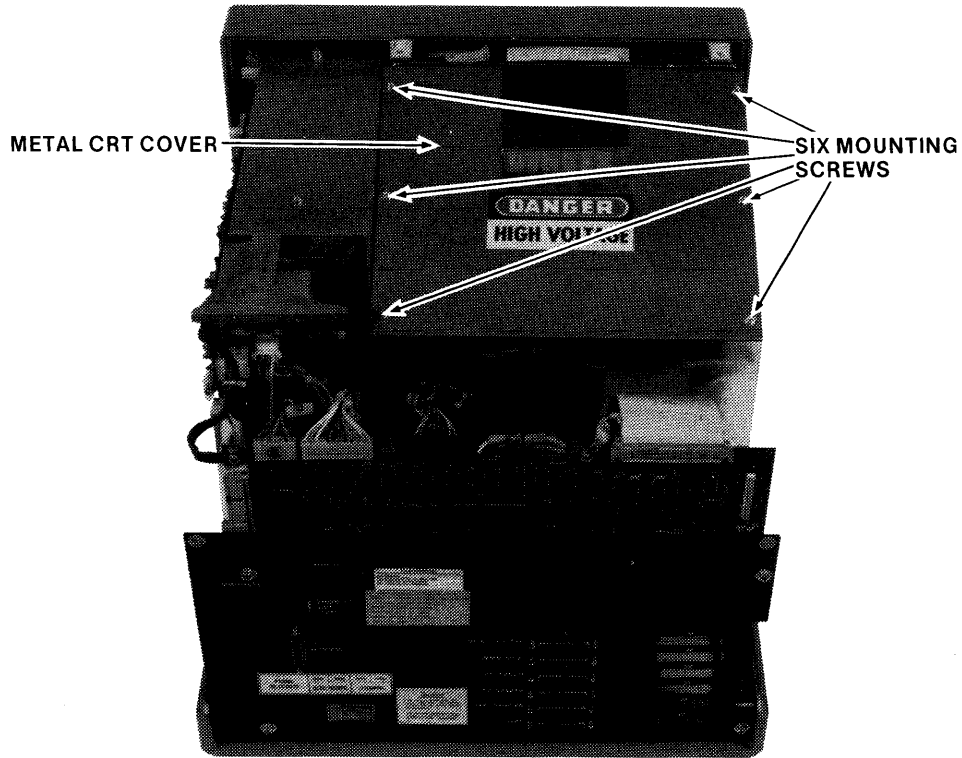

Figure 4-11. Metal CRT Cover Removal

559-50



Figure 4-12. CRT Connector and Mounting Screws

559-51

6. Remove the blank panel on the front of the chassis. Figure 4-13 shows the three screws attached from the rear.
 7. Install the disk drive mounting bracket with the open side facing outward. Use two 6-32 x 1/4 screws with #6 locking and #6 flat washers to fasten the bracket to the inboard holes next to the CRT, as shown in Figure 4-14. Use three 10-32 x 3/8 screws with #10 locking and #10 flat washers to fasten the bottom of the bracket to the CRT platform, as shown in Figure 4-15.
 8. Move the CRT back into mounting position and replace the four screws holding it in place. Make sure the CRT cable leading to the IOC board is firmly attached at each end.
 9. Replace the six metal CRT cover screws.
-

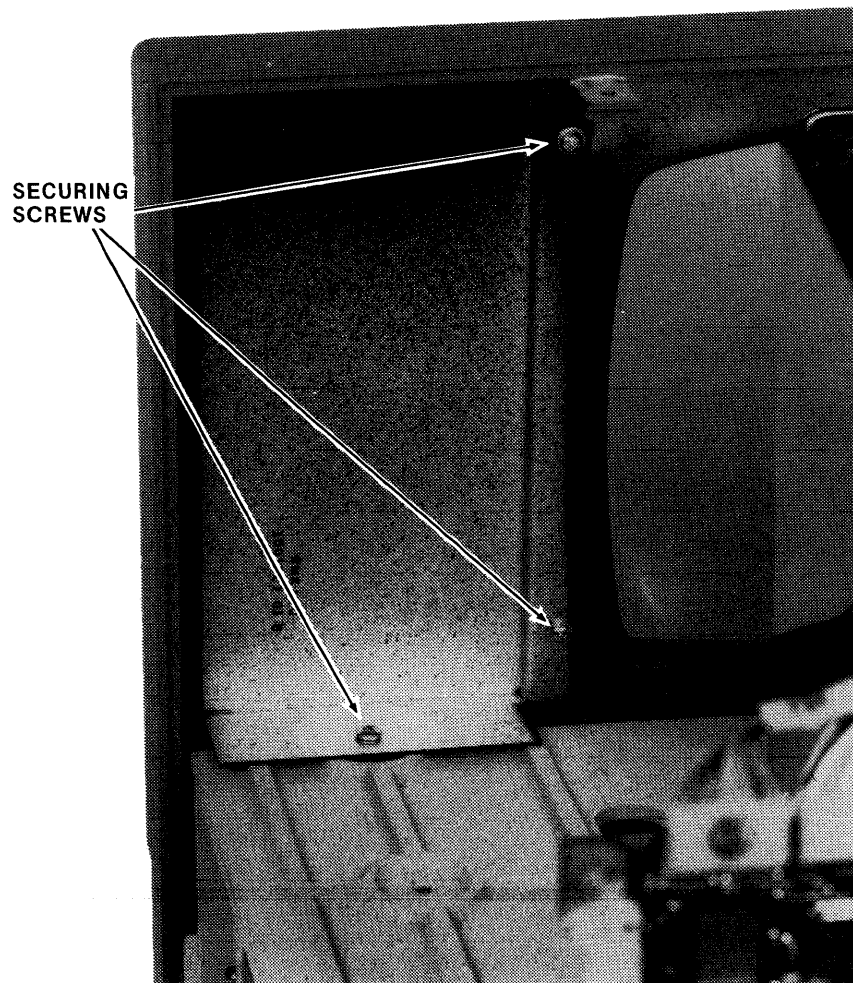

Figure 4-13. MDS-230 Blank Panel Removal

559-64

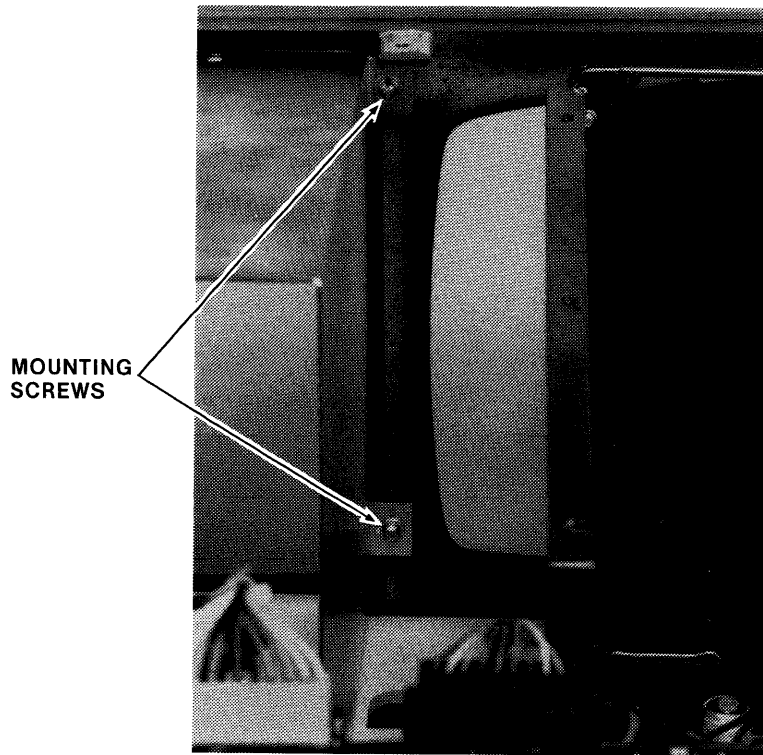

Figure 4-14. Disk Drive Mounting Bracket Mounting Screws

559-65

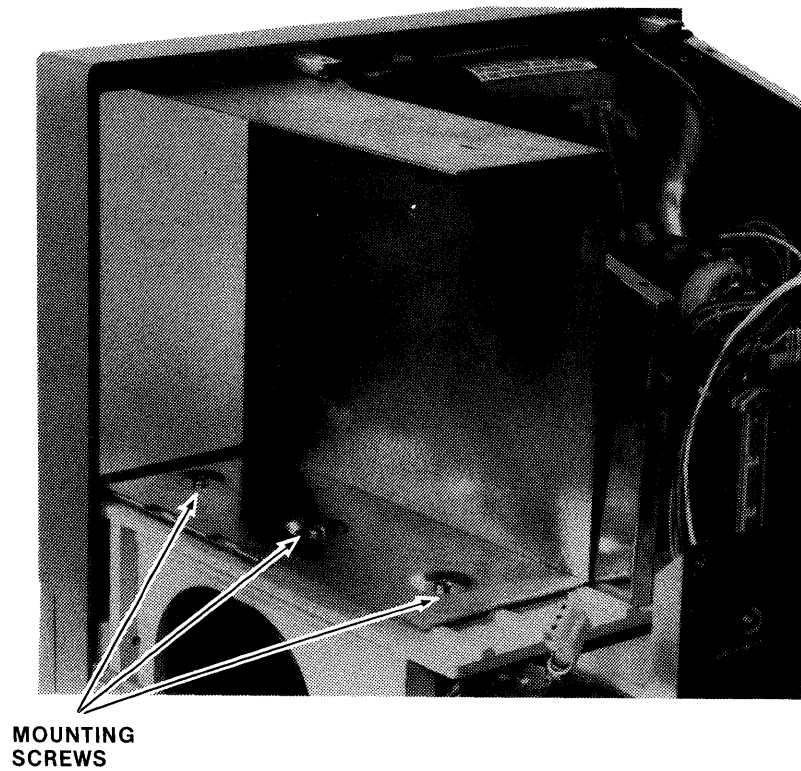

Figure 4-15. Disk Drive Mounting Bracket Installation

559-66

10. Refer to Figure 4-16. Slide the disk drive into place carefully, with the printed circuit side of the drive facing outward, and fasten it to the top of the disk drive mounting bracket using two 8-32 x 3/8 screws with #8 locking and #8 flat washers. Be careful not to damage the IOC or power supply boards.
 11. Refer to Figure 4-17. Attach the disk drive to the side bracket, using two 8-32 x 3/8 screws with two #8 locking and #8 flat washers.
 12. The disk drive AC power cable is attached to the side of the power supply immediately above the fan. Remove the cable from the tie wrap, and remove the dummy plug in its end. Connect this cable to the disk drive as shown in Figure 4-18.
 13. Refer to Figures 4-16, 4-18, and 4-19 and connect the DC power cable (4001522) to the disk drive. Attach the other end to the DC connector on the IOC board, shown in Figures 4-16 and 4-18.
-

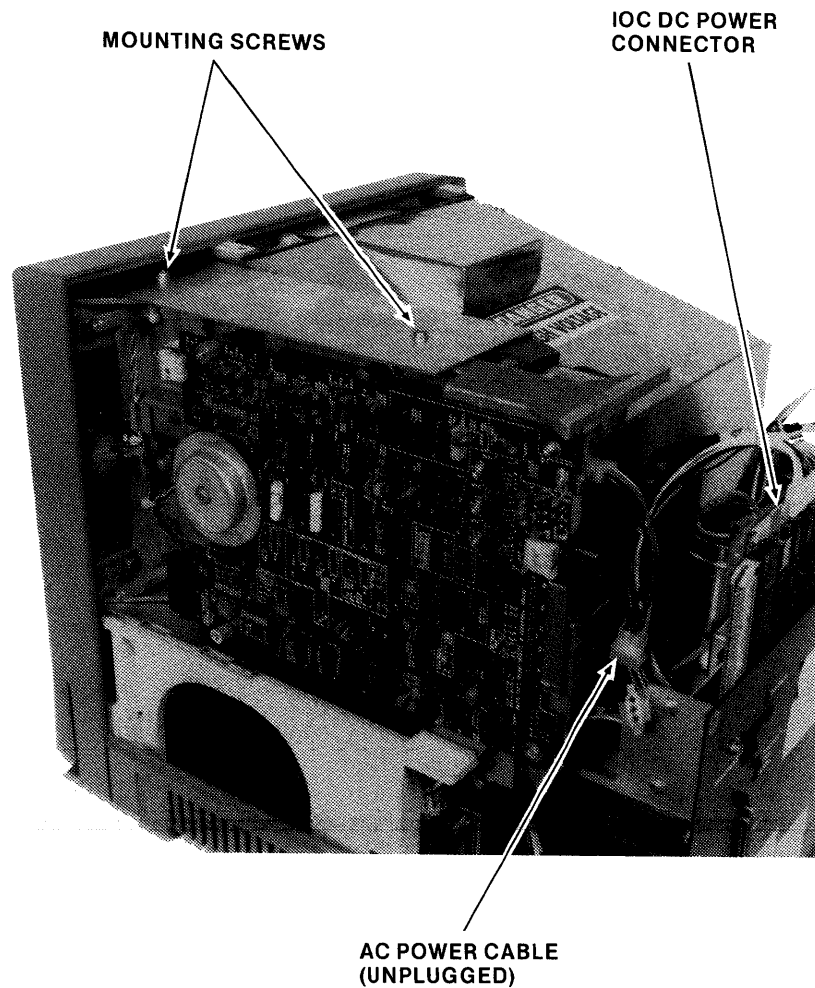

Figure 4-16. Disk Drive Installation

559-67

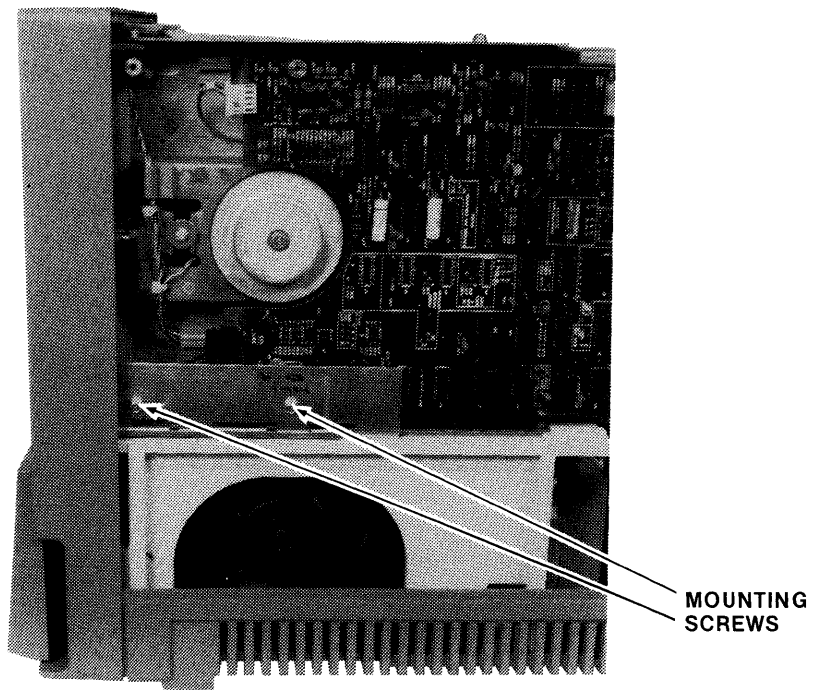

Figure 4-17. Disk Drive Side Mounting Bracket

559-68

DC POWER CABLE
DRIVE CONNECTIONS

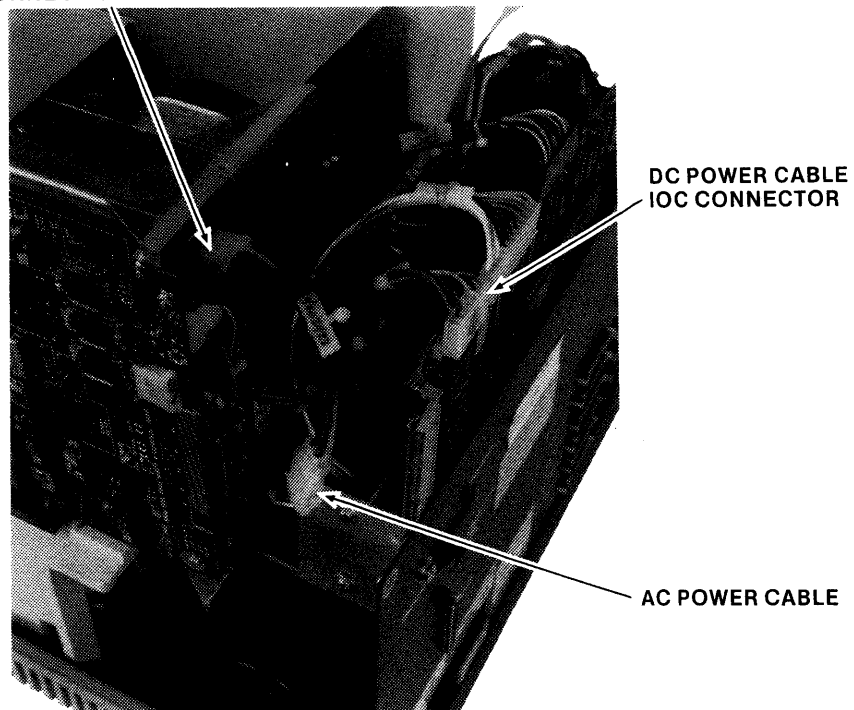

Figure 4-18. Disk Drive Power Cable Installation

559-69

14. Refer to Figure 4-20. Remove the screw in the upper right-hand corner of the drive, and attach the braided ground strap (4002423) with a #6 lock washer and a 6-32 x 3/8 screw. Fasten the other end of the braided ground strap to the IOC ground tab adjacent to the IOC disk interface cable connector, using an 8-32 x 3/8 screw, a #8 flat washer, and a #8 keeper nut.
 15. Connect the interface cable from the disk drive to the IOC board as shown in Figure 4-20.
 16. Install the 8271 IC (Flexible Disk Controller Chip) in socket location A1 on the IOC board, as shown in Figure 4-21. Check the chip's orientation to make sure that pin 1 is in the upper left-hand corner.
 17. Replace the top chassis cover and reconnect the AC power cable.
 18. Run the IOC Disk Test described in the "Diagnostics" section of Chapter 3.
-

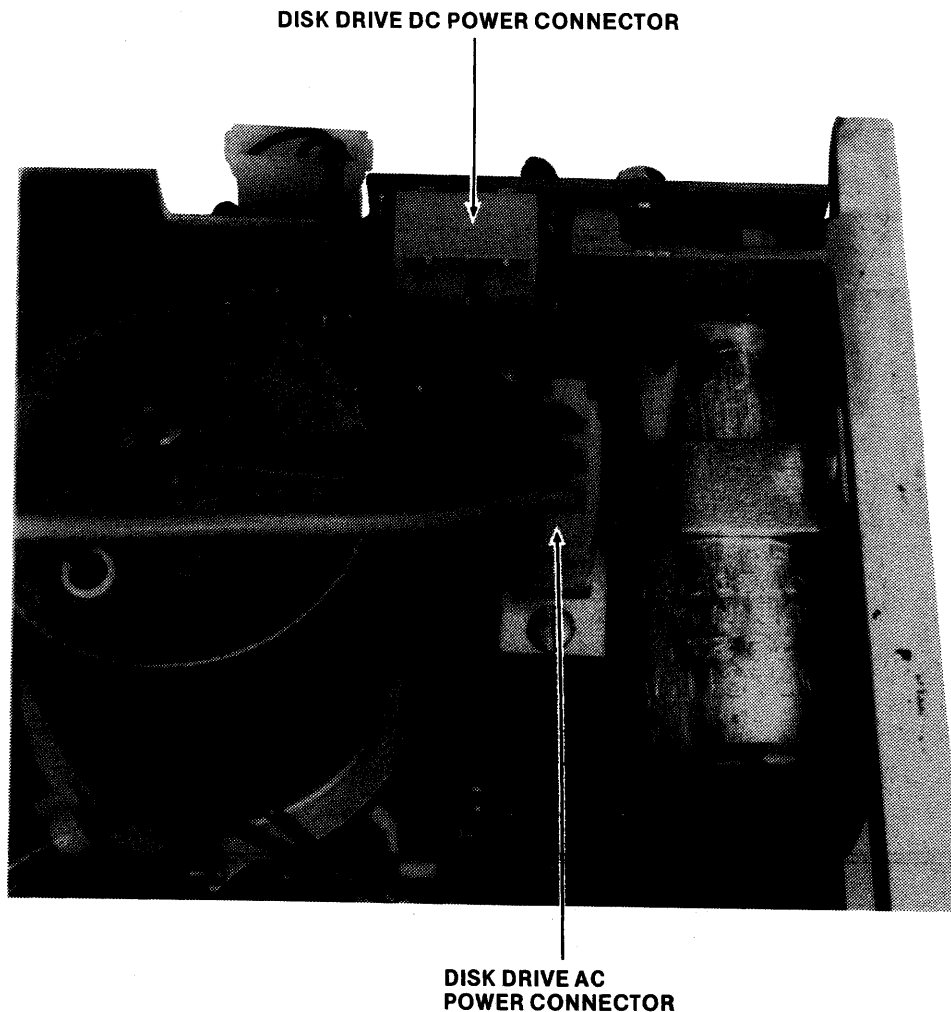

Figure 4-19. Disk Drive Power Cable Connections

559-70

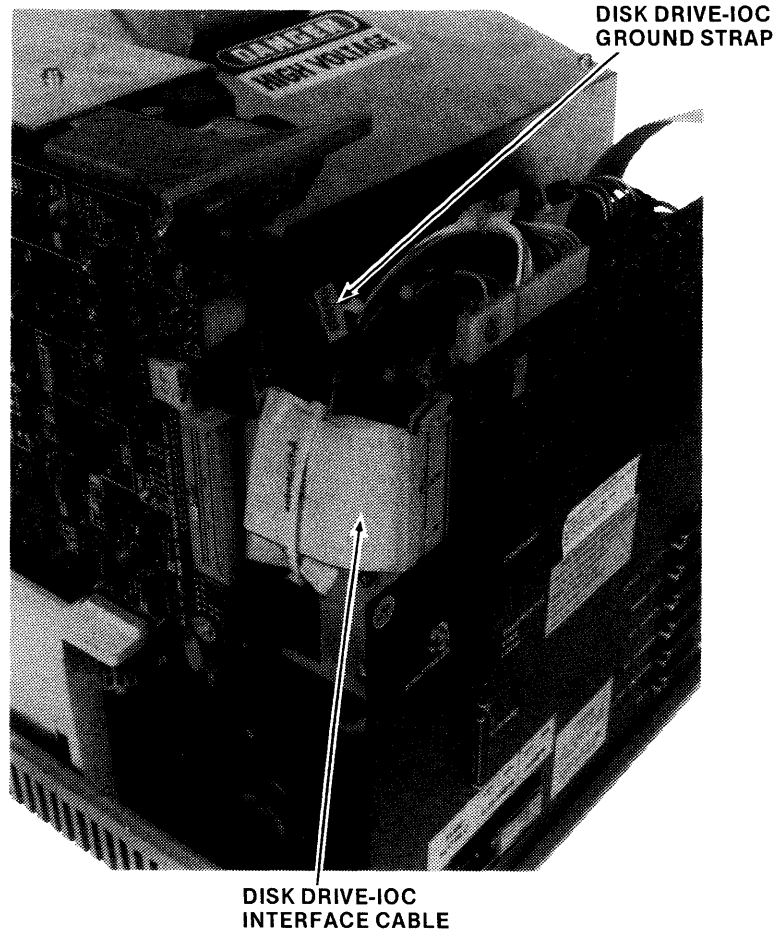

Figure 4-20. Disk Drive Interface Cable and Ground Strap Installation

559-71

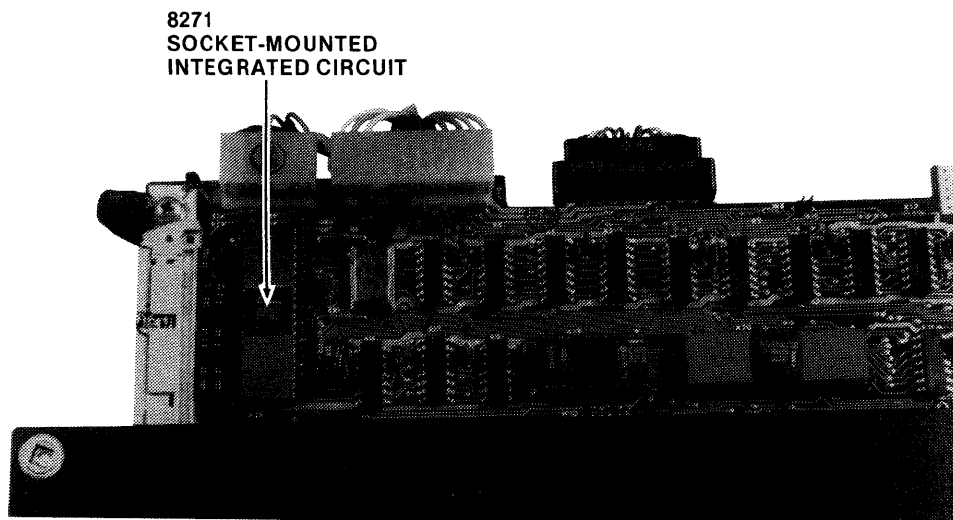

Figure 4-21. MDS-220 Edge Connectors and Socket-Mounted Integrated Circuits

559-72

The new drive is a single-density unit, it has an address of F4. If all other drives are removed from the system for some reason, it has an address of F0.

Checkout of Integral Disk Unit

To checkout the new integral disk drive, execute the IOC diagnostics. See IOC diagnostic section in Chapter 3.

Load the Diagnostic Confidence Test disk in drive 0 and execute the applicable tests, especially the disk test. The operating instructions for the test are in Chapter 3

Installing An Expansion Chassis

Installing an expansion chassis adds four card slots to your Series II development system. Since the expansion chassis contains its own power supply, it does not make power demands on the main chassis, and the only connection between the main chassis and the expansion chassis is through two bus cables.

Figure 4-22 shows the two bus cables attached to the main card cage (for visibility, the IPB and other cards have been removed), and Figure 4-23 shows the expansion chassis cable port, with the two bus cables and the ground straps extended.

Follow these steps to install your expansion chassis:

1. Turn off power to the system and remove all boards from the main card cage.
2. Turn the chassis on its side so the cable port is accessible.
3. Remove the cable port covers from the main chassis and expansion chassis.
4. Refer to Figure 4-24. Remove the B and C clock termination jumpers from the main chassis.
5. Plug the two bus cables into place in the expansion chassis cable port, as shown in Figure 4-23. The ground straps are factory-installed.

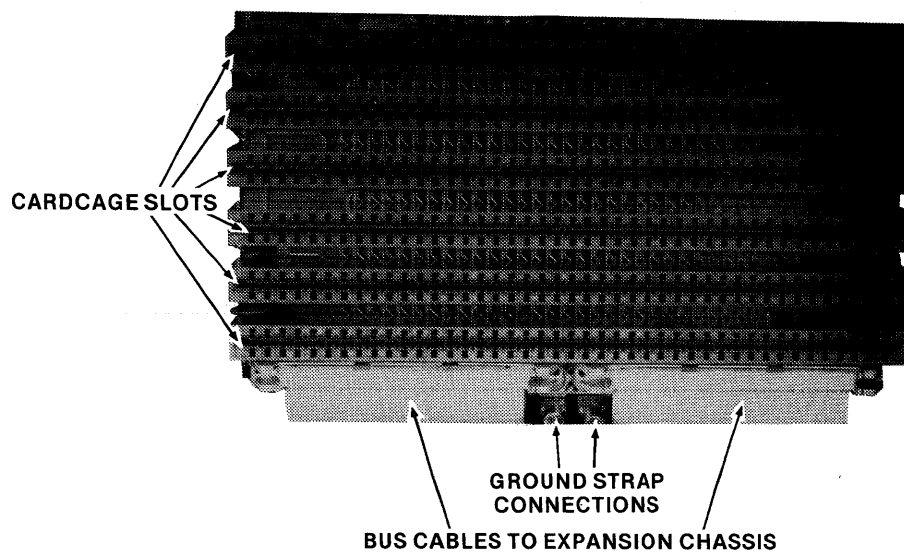

Figure 4-22. Cardcage Cable Connections

559-73

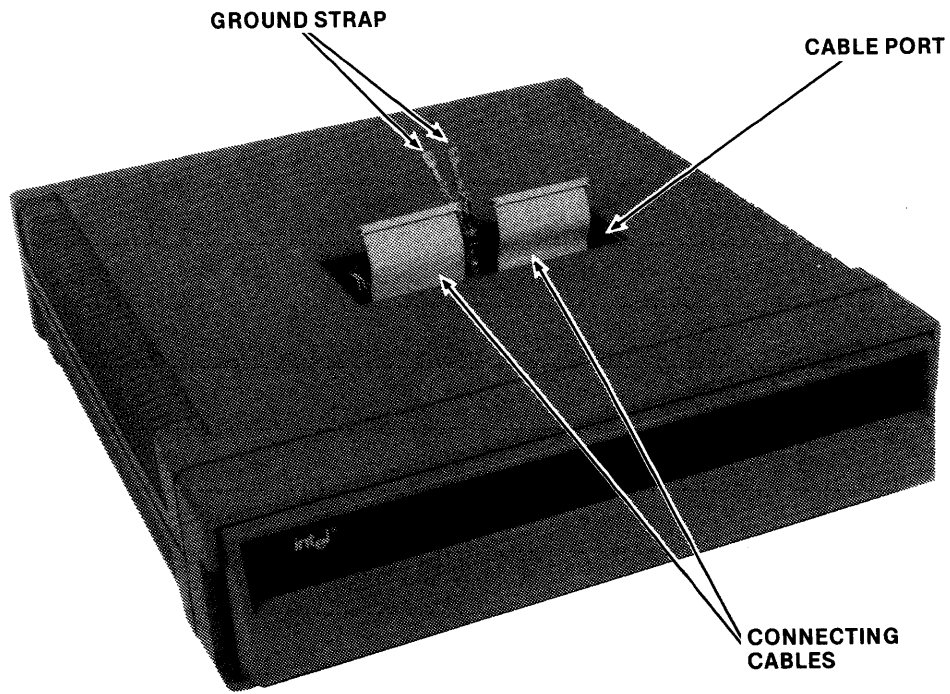

Figure 4-23. Expression Chassis Cable Port

559-74

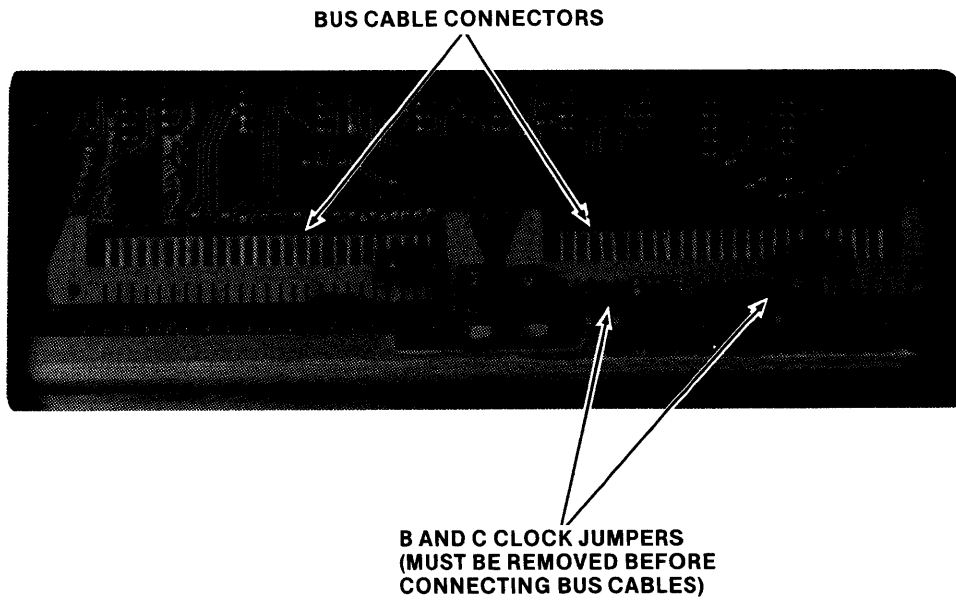

Figure 4-24. Main Chassis Cable Port

559-75

6. Place the main chassis on top of the expansion chassis, tilting it to reach the cable port beneath. Refer to Figure 4-22. Connect the two bus cables to the connectors within the main chassis cable port, and connect the ground straps as shown.
7. Replace all boards in the main chassis card cage.
8. Refer to Figure 4-25. Attach the static grounding strip as shown.

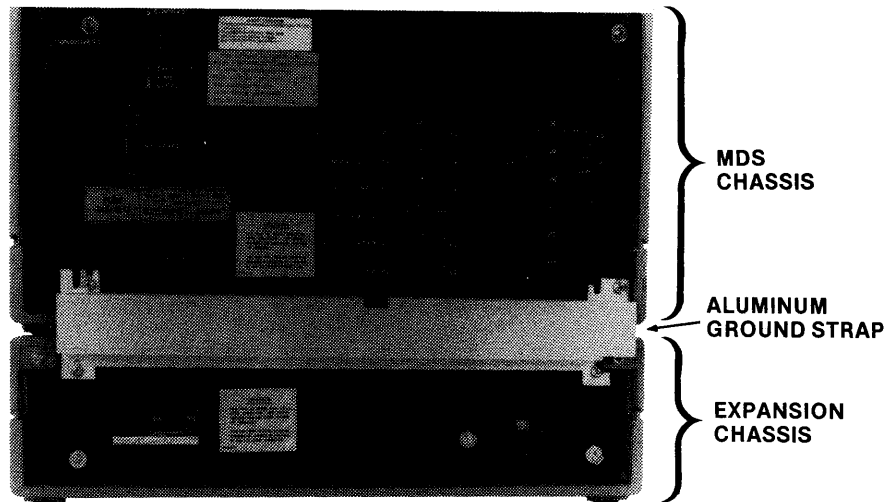

Figure 4-25. Expansion Chassis Ground Strap Installation

559-76

Checkout Of The Expansion Chassis

To check out the expansion chassis, you need a board known to work in an Intellec Series II card cage, such as a RAM board or disk controller.

Once you have installed the two bus cables between the main chassis and expansion chassis cable ports, apply power to both chassis. Verify that the cooling fans on the expansion chassis are operating, then remove power and install your chosen checkout board. Reapply power and perform the Diagnostic tests used with your board, described in Chapter 3.

Adding Peripherals

The Intellec Series II has connectors installed for the following devices:

- Line printer
- Paper tape reader
- Paper tape punch
- Universal PROM Programmer
- TTY (Serial channel 1 - see Appendix A for information on configuring this interface)
- Modem (Serial channel 2 - see Appendix A for information on configuring this interface)
- Data terminal (Serial channel 2 - see Appendix A for information on configuring this interface)

Figure 4-24 shows the interface connectors on the back panel of the models 220, and 230.

Adding In-Circuit Emulators

You can install any of the in-circuit emulators in an Intellec Series II. The procedures to install the in-circuit emulators in the Series II are in the in-circuit emulator documentation packages.

NOTE

If you move 2-card components from an Intellec Microcomputer development system to an Intellec Series II, you cannot use the auxiliary connector from the old system. The spacing between the Series II card cage slots is smaller. Use one of the spare auxiliary connectors shipped with the Series II system.

Adding Multibus Modules

You can add any Multibus-compatible module to the Intellec Series II. The installation of the modules is covered in the module documentation. The only concern when installing new modules in the Intellec Series II is whether there is enough power available for the module. Check Appendix B and subtract the power con



APPENDIX A CONFIGURING THE SERIAL INTERFACES

The problems that sometimes occur when connecting devices from different manufacturers through an interface designated RS232C are usually due to different interpretations of the RS232C specification.

The Intellec Series II serial interfaces, Serial 1 and Serial 2, are designed to be adaptable to any interpretation of the specification. The serial interfaces are implemented with extensive line jumpering capability.

As shipped, Serial 1 is jumpered for a standard TTY terminal configuration. Serial 2 is jumpered for modem or CRT terminal.

The jumpers are located at the top right corner of the IOC board and are accessible by removing the main chassis top cover. Figure A-1 shows the lines and jumpers available in Serial 1, with the jumpers shown as shipped. Figure A-2 shows the lines and jumpers available in Serial 2, with the jumpers shown as shipped.

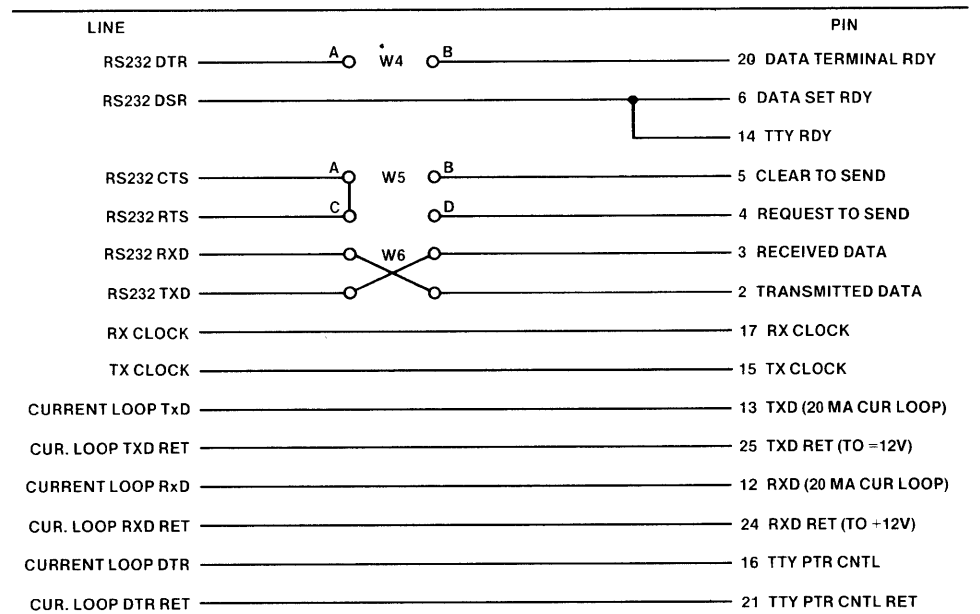

Fig. A-1 Serial 1 Lines and Jumpers

559-10

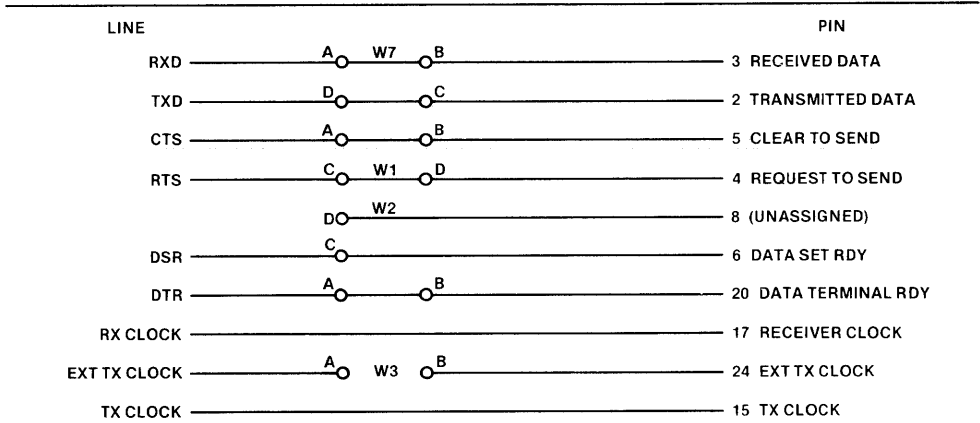

Fig. A-2 Serial 2 Lines and Jumpers

559-11



APPENDIX B POWER SUPPLY USAGE

The following tables list the power supply (capacity required) by the basic system components, and the power available for options.

	+5v	+12v	-12v	-10v	+15v	+24v
Capacity	30.0A	2.5A	0.3a	1.0A	1.5A	1.7A
IPB	4.0A	0.3A	0.1A	0.01A	0	0
IOC	2.8A	0.1A	0	0.01A	0	0
CRT	0	0	0	0	1.5A	0
Keyboard	0.4A	0	0	0	0	0
Drive	1.0A	0	0	0	0	1.7A
Total	8.2A	0.4A	0.1A	0.02A	1.5A	1.7A
Available for options	21.8A	2.1A	0.2A	0.98A	0	0

Figure B-1. Model 220 Power Supply Usage

	+5v	+12v	-12v	-10v	+15v	+24v
Capacity	30.0A	2.5A	0.3A	1.0A	1.5A	1.7A
IPB	4.0A	0.3A	0.1A	0.01A	0	0
IOC	2.8A	0.1A	0	0.01A	0	0
CRT	0	0	0	0	1.5A	0
Keyboard	0.4A	0	0	0	0	0
SBC-032	2.0A	0.4A	0	0.05A	0	0
Disk controller	5.25A	0	0	0.1A	0	0
Total	14.45A	0.8A	0.1A	0.17A	1.5A	0
Available for options	15.55A	1.7A	0.2A	0.83A	0	1.7A

Figure B-2. Model 230 Power Supply Usage

	+5v	+12v	-12v	-10v
Available for options	20.0A	2.0A	0.3A	0.8A

Figure B-3. Expansion Chassis Power Availability

The model 220 can support most combinations of options except two In Circuit Emulators or multiple communication controllers.

The model 230 can support most one- and two-board options.



APPENDIX C MODIFYING THE BAUD RATE

```
;
; THIS PROGRAM MODIFIES THE BAUD RATES FOR THE SERIES-II
; SERIAL CHANNELS. SPECIFICALLY, AS IT IS WRITTEN, SERIAL
; CHANNEL 2 BAUD RATE WOULD BE MODIFIED. TO CHANGE THE
; BAUD RATE FOR SERIAL CHANNEL 1 (TTY), CHANGE THE THREE
; OCCURRENCES OF "OUT 0F7H" TO "OUT 0F5H", THE TWO
; OCCURRENCES OF "OUT 0F1H" TO "OUT 0F0H", THE ONE
; OCCURRENCE OF "MVI A, 076H" TO "MVI A, 036H", AND REASSEMBLE.
;
;
; BE SURE TO SUBSTITUTE THE PROPER BAUD CODE AND MULTIPLIER
; INTO THE ASSEMBLY LANGUAGE CODE PRIOR TO ASSEMBLING!
;
;
;
; CSEG
START: MVI    A,040H      ; RESET THE 8251 USART
        OUT    0F7H
        MVI    A,076H      ; PROGRAM THE 8253 COUNTER FOR
        OUT    0F3H      ; MODE 3 and LSB FOLLOWED BY MSB
;
;
;          BAUD RATE CODES
;
; RATE      CODE      MULTIPLIER
; 110      2BAH      0CEH
; 150      080H      0CFH
; 300      040H      0CFH
; 600      020H      0CFH
; 1200     010H      0CFH
; 2400     020H      0CEH
; 4800     010H      0CEH
; 9600     008H      0CEH
; 19200    004H      0CEH
;
; LXI      H, BAUD CODE ; LOAD 8253 WITH LSB OF BAUD
; MOV      A,L          ; CODE FIRST, FOLLOWED BY
; OUT      0F1H        ; MSB OF BAUD CODE
; MOV      A,H
; OUT      0F1H
;
;
; OBTAIN PROPER MULTIPLIER FROM BAUD RATE CODE TABLE ABOVE
;
; MVI      A, MULTIPLIER ; LOAD MULTIPLIER
; OUT      0F7H
; MVI      A,025H      ; ENABLE TRANSMITTER, RECEIVER AND RTS
; OUT      0F7H
; RST      01H
; END      START
```

INTRODUCTION

This appendix provides information required to modify a Model ASR-33 Teletypewriter for use with the Intellec Series II.

INTERNAL MODIFICATIONS

WARNING

Hazardous voltages are exposed when the top cover of the teletypewriter is removed. To prevent accidental shock, disconnect the teletypewriter power cord before processing beyond this point.

Remove the top cover and modify the teletypewriter as follows:

1. Remove blue lead from 750-ohm tap on current source register; reconnect this lead to 1450-ohm tap. (Refer to figures D-1 and D-2.)
2. On terminal block, change two wires as follows to create an internal full-duplex loop (refer to figures D-1 and D-3):
 - a. Remove brown/yellow lead from terminal 3; reconnect to terminal 5.
 - b. Remove white/blue lead from terminal 4; reconnect this lead to terminal 5.
3. On terminal block, remove violet lead from terminal 8; reconnect this lead to terminal 9. This changes the receiver current level from 60 mA to 20 mA.

A relay circuit card must be fabricated and connected to the paper tape reader driver circuit. The relay circuit card to be fabricated requires a relay, a diode, a thyrector, a small vector board for mounting the components, and suitable hardware for mounting the assembled relay card.

A circuit diagram of the relay circuit card is included in Figure D-4; this diagram also includes the part numbers of the relay, diode, and thyrector. (Note that a 470-ohm resistor and a 0.1 μ F capacitor may be substituted for the thyrector.) After the relay circuit card has been assembled, mount it in position as shown in Figure D-5. Secure the card to the base plate using two self-tapping screws. Connect the relay circuit to the distributor trip magnet and mode switch as follows:

1. Refer to Figure D-4 and connect a wire (Wire A) from relay circuit card to terminal L2 on mode switch (See Figure D-6).
2. Disconnect brown wire shown in Figure D-7 from plastic connector. Connect this brown wire to terminal 12 on mode switch. (Brown wire will have to be extended.)
3. Refer to Figure D-4 and connect a wire (Wire B) from relay circuit board to terminal L1 on mode switch.

EXTERNAL CONNECTIONS

Connect a two-wire receive loop, a two-wire send loop, and a two-wire tape reader control loop to the external device as shown in Figure D-4. The external connector pin numbers shown in Figure D-4 are for serial channel 1 on the Intellec Series II.

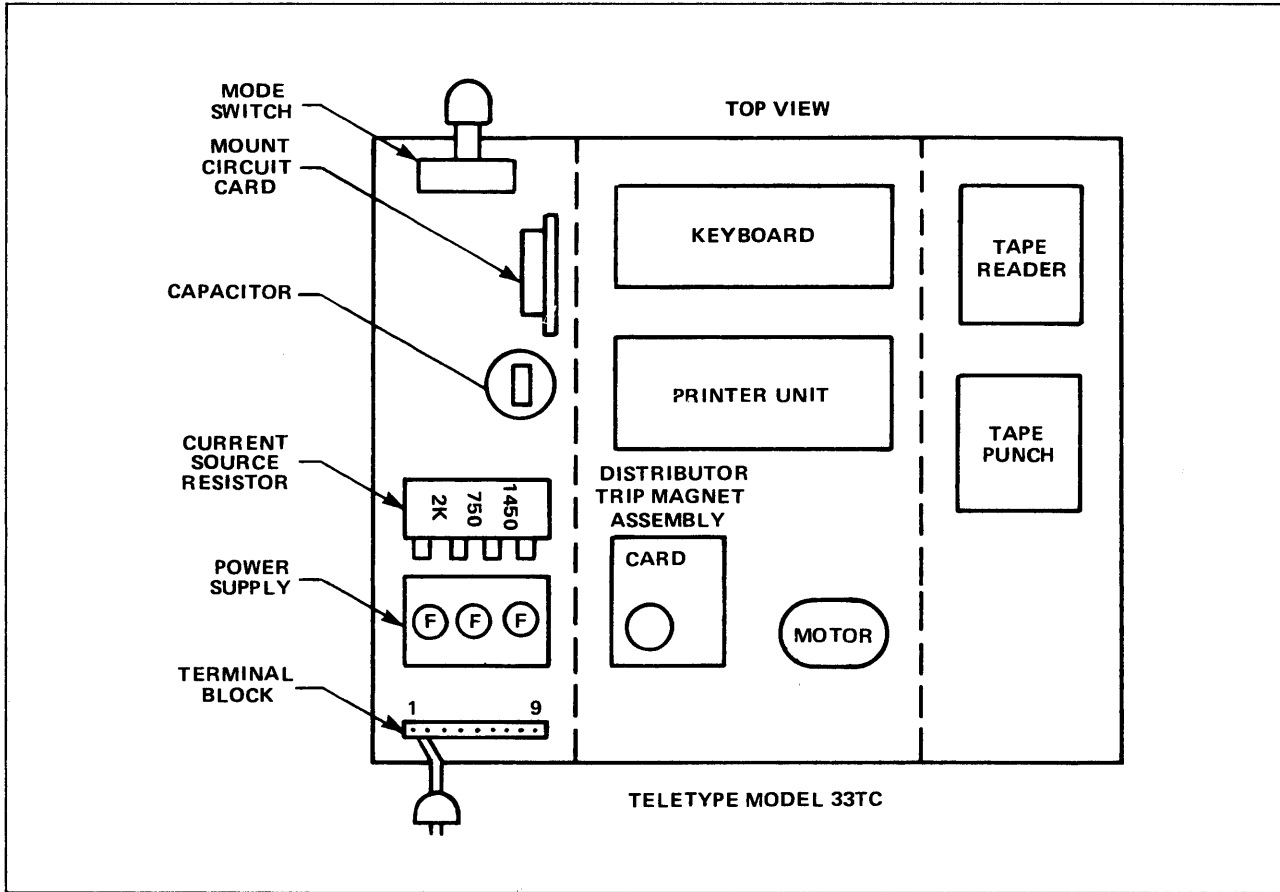

Figure D-1. Teletype Component Layout

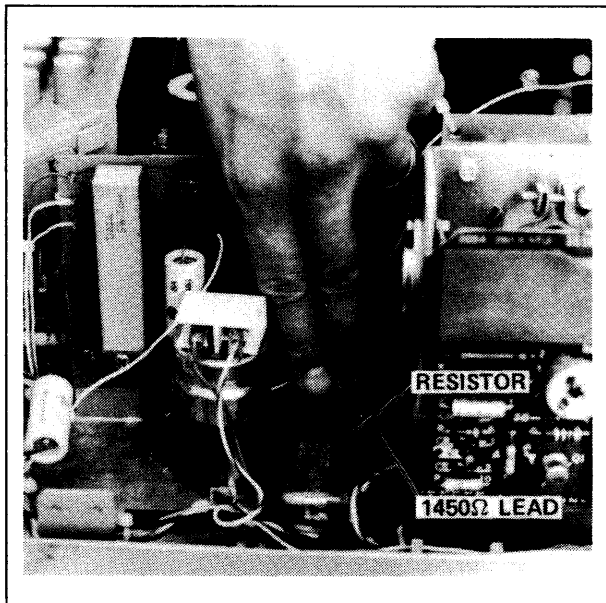

Figure D-2. Current Source Resistor

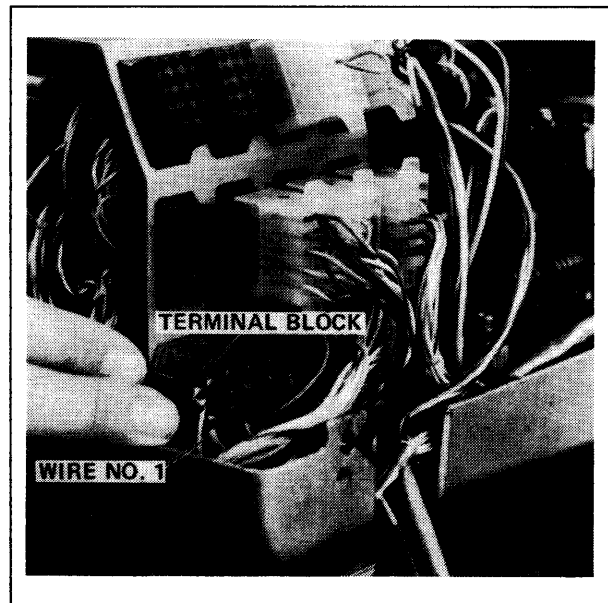

Figure D-3. Terminal Block

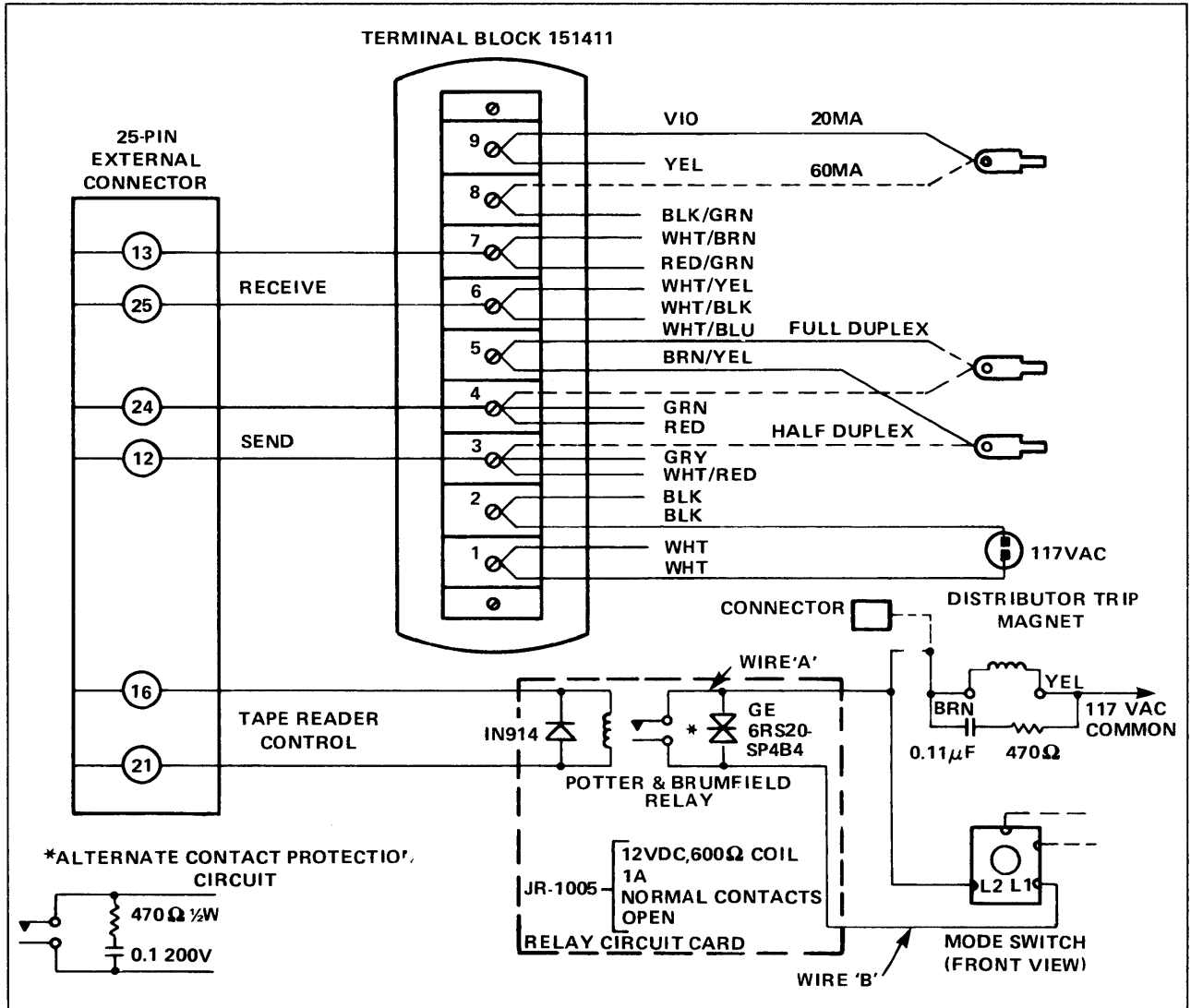

Figure D-4. Teletypewriter Modifications

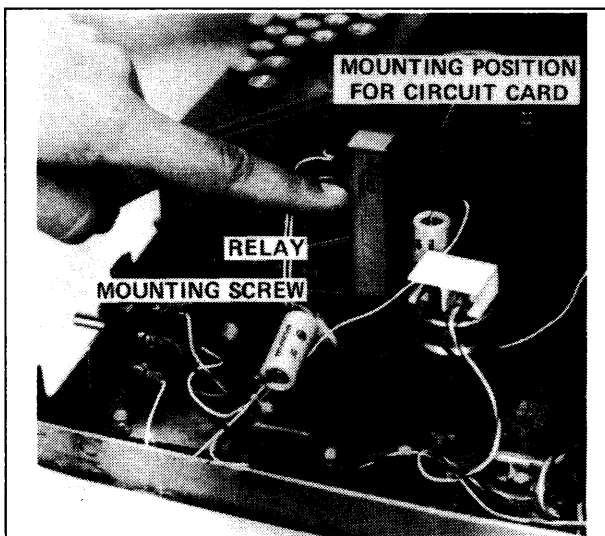

Figure D-5. Relay Circuit

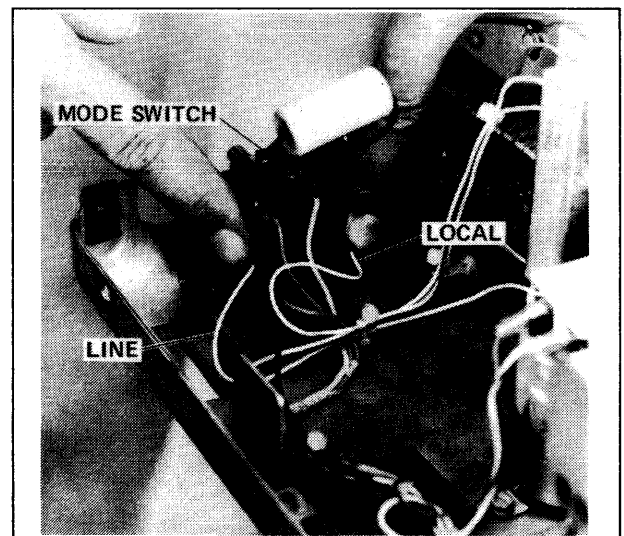

Figure D-6. Mode Switch

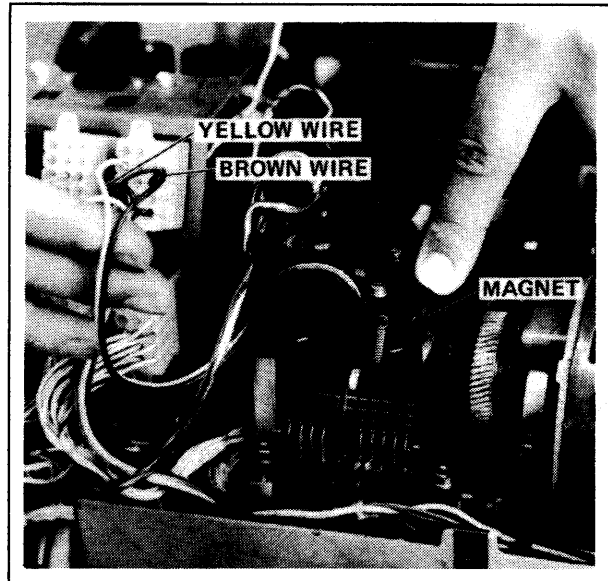

Figure D-7. Distributor Trip Magnet



APPENDIX E CHASSIS-SIGNAL GROUND

In development work it is sometimes necessary to isolate chassis ground from signal ground. You can isolate these grounds in the Intellec Series II by removing a single wire from the power supply.

To isolate the grounds you must remove the top cover of the system. The ground connection is a yellow and green wire connected to the power supply. Figure E-1 shows the ground wire location in a model 220 or 230.

The wire is connected to the power supply with a spade connector. Pull the wire off the power supply. Before replacing the cover, put electrical tape around the connector to prevent an accidental short.

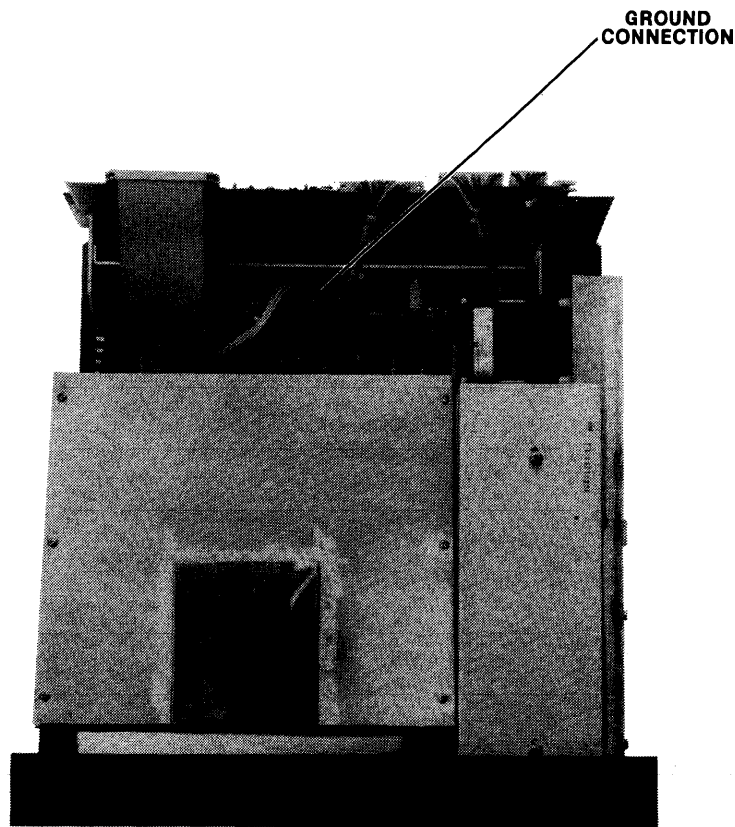

Figure E-1. Ground Connection on Model 220 and 230

- aborting a test 3-9
- acknowledge select jumper 4-3
- adding
 - disk controllers 4-3
 - In-Circuit Emulators 4-20
 - Multibus modules 4-20
 - peripheral devices 4-19
 - RAM, 16K 4-2
 - RAM, 32K 4-1
- address selection, memory board 4-1, 4-3
- assembly
 - model 220 2-1
 - model 230 2-1
- available power
 - expansion chassis B-1
 - model 220 B-1
 - model 230 B-1
- cable port 4-17
- care of disks 1-4
- checkout
 - disk drives 4-7, 4-17
 - expansion chassis 4-19
 - memory 4-2, 4-3
 - model 220 2-6
 - model 230 2-6
 - RAM 4-2, 4-3
- commands
 - diagnostic 3-3, 3-5, 3-8
- confidence test
 - description 3-8 thru 3-13
 - messages 3-8 thru 3-13
- consumption, power B-1
- cord, power 2-1
- CRT
 - test, confidence test 3-10
 - test, IOC diagnostics 3-8
- damage procedure 2-1
- description
 - model 220 1-1
 - model 230 1-1
- diagnostic
 - command 3-3
 - initiation
 - confidence test 3-8
 - IOC test 3-5
 - IPB test 3-3
- diagnostics
 - IOC 3-5
 - IPB 3-3
- disk care 1-4
- disk controller, installation 4-3
- disk test, IOC diagnostics 3-7
- disk test aborting 3-9
- disk test, confidence test 3-11
- disk-based diagnostics 3-8
- error messages, IPB diagnostics 3-4
- execution of IOC diagnostics 3-5
- execution of IPB diagnostics 3-4
- execution of confidence test 3-8
- expansion chassis 4-17
- fuse rating
 - model 220 2-8
 - model 230 2-8
- general description
 - model 220 1-1
 - model 230 1-1
- general test, IOC diagnostics 3-7
- high speed punch test 3-13
- high speed reader test 3-13
- In-Circuit Emulators 4-20
- inspection 2-1
- installation
 - model 220 2-1
 - model 230 2-1
- installing
 - model 220 2-1
 - model 230 2-1
- installing an expansion chassis 4-17
- Introduction 1-1
- inventory 2-1
- inventory checklist 2-1
- I/O configuration, serial A-1
- IOC diagnostics 3-5
- IPB diagnostics 3-3
- IPB error messages 3-4
- keyboard
 - cable connections 2-3
 - installation 2-3
 - test, confidence test 3-10
- keyboard/CRT test, IOC diagnostics 3-8
- line printer test, confidence test 3-12
- SBC-016 4-2
- memory board jumpers
 - SBC-016 4-2
 - SBC-032 4-3
- memory capacity
 - model 220 1-1
 - model 230 1-1
- memory test 3-3, 3-9
- memory test, confidence test 3-9
- model 220 1-1
- model 230 1-1
- monitor 3-3
- Multibus modules 4-20
- no power 3-1
- paper tape punch, installing 4-19
- paper tape reader, installing 4-19
- peripheral devices, installing 4-19

- port, cable 4-17
- power available
 - expansion chassis B-1
 - model 220 B-1
 - model 230 B-1
- power consumption
 - expansion chassis B-1
 - model 220 B-1
 - model 230 B-1
- power supply usage
 - model 220 B-1
 - model 230 B-1
- procedure, checkout 2-6
- processor test, confidence test 3-9
- PROM programmer, installing 4-19
- punch test, confidence test 3-13
- punch, installing 4-19

- RAM test 3-7, 3-9
- reader test, confidence test 3-13
- reader, installing 4-19
- ROM-based diagnostics 3-3
- ROM-based monitor 3-3

- SBC-032 4-1
- safety 1-1
- serial I/O configuration A-1
- service 3-1
- service policy and procedure 3-1

- tape punch, installing 4-19
- tape reader, installing 4-19

- teletypewriter test, confidence test 3-10
- teletypewriter, installing 4-19
- test initiation 3-3, 3-8
- test, aborting 3-9
- testing
 - memory 3-3, 3-9
 - the line printer 3-12
 - the CRT 3-8, 3-10
 - the IOC 3-5
 - the IPB 3-4, 3-9
 - the PIO 3-7
 - the TTY 3-10
 - the external disk drives 3-11
 - the integral disk drive 3-7
 - the keyboard 3-8, 3-10
 - the punch 3-13
 - RAM 3-3, 3-9
 - the reader 3-13
- troubleshooting 3-1
- TTY test, confidence test 3-10
- TTY, installing 4-19

- universal PROM programmer, installing 4-19
- unpacking 2-1
- upgrade and enhancement 4-1
- upgrading 4-1
- UPP, installing 4-19

- voltage adjustments
 - model 220 3-2
 - model 230 3-2



REQUEST FOR READER'S COMMENTS

The Microcomputer Division Technical Publications Department attempts to provide documents that meet the needs of all Intel product users. This form lets you participate directly in the documentation process.

Please restrict your comments to the usability, accuracy, readability, organization, and completeness of this document.

1. Please specify by page any errors you found in this manual.

2. Does the document cover the information you expected or required? Please make suggestions for improvement.

3. Is this the right type of document for your needs? Is it at the right level? What other types of documents are needed?

4. Did you have any difficulty understanding descriptions or wording? Where?

5. Please rate this document on a scale of 1 to 10 with 10 being the best rating. _____

NAME _____ DATE _____

TITLE _____

COMPANY NAME/DEPARTMENT _____

ADDRESS _____

CITY _____ STATE _____ ZIP CODE _____

Please check here if you require a written reply.

WE'D LIKE YOUR COMMENTS ...

This document is one of a series describing Intel products. Your comments on the back of this form will help us produce better manuals. Each reply will be carefully reviewed by the responsible person. All comments and suggestions become the property of Intel Corporation.



**NO POSTAGE
NECESSARY
IF MAILED
IN U.S.A.**

BUSINESS REPLY MAIL
FIRST CLASS PERMIT NO. 1040 SANTA CLARA, CA

POSTAGE WILL BE PAID BY ADDRESSEE

**Intel Corporation
Attn: Technical Publications M/S 6-2000
3065 Bowers Avenue
Santa Clara, CA 95051**





INTEL CORPORATION, 3065 Bowers Avenue, Santa Clara, CA 95051 (408) 987-8080

Printed in U.S.A.