

**UNIVERSAL
PROM PROGRAMMER
USER'S MANUAL**

Order Number: 9800819-03

REV.	REVISION HISTORY	DATE
-01	First Issue.	11/78
-03	Incorporates all change packages issued against original manual. Includes information on use of following additional personality modules and adapters: UPP-833, UPP-820, UPP-564, UPP-551, UPP-549 and UP2. Adds information on reading 8086 object files. Adds description of FILL command.	6/81

Additional copies of this manual or other Intel literature may be obtained from:

Literature Department
Intel Corporation
3065 Bowers Avenue
Santa Clara, CA 95051

The information in this document is subject to change without notice.

Intel Corporation makes no warranty of any kind with regard to this material, including, but not limited to, the implied warranties of merchantability and fitness for a particular purpose. Intel Corporation assumes no responsibility for any errors that may appear in this document. Intel Corporation makes no commitment to update nor to keep current the information contained in this document.

Intel Corporation assumes no responsibility for the use of any circuitry other than circuitry embodied in an Intel product. No other circuit patent licenses are implied.

Intel software products are copyrighted by and shall remain the property of Intel Corporation. Use, duplication or disclosure is subject to restrictions stated in Intel's software license, or as defined in ASPR 7-104.9(a)(9).

No part of this document may be copied or reproduced in any form or by any means without the prior written consent of Intel Corporation.

The following are trademarks of Intel Corporation and its affiliates and may be used only to identify Intel products:

BXP	Intel	Library Manager	Plug-A-Bubble
CREDIT	int ₁	MCS	PROMPT
i	Intelevison	Megachassis	Promware
ICE	Intellec	Micromainframe	RMX/80
iCS	iRMX	Micromap	System 2000
im	iSBC	Multibus	UPI
Insite	iSBX	Multimodule	µScope

and the combination of ICE, iCS, iRMX, iSBC, iSBX, MCS, or RMX and a numerical suffix.

This manual describes the use of Intel's Universal PROM Programmer (UPP) with an Intel Intellec Microprocessor Development System to create programmed read-only memories (PROMs) from data files. It is intended for use by engineers and designers whose assignments call for the development of PROM-based systems.

While this manual is a self-contained document describing use of the UPP, several other Intel documents may prove useful to the design engineer who uses this system to develop microprocessor-based systems. Some of the key publications which may be of interest are as follows:

- *Universal PROM Programmer Reference Manual*, Order Number 9800133
- *ISIS-II Operating System User's Manual*, Order Number 9800306
- *Intel Data Catalog* (current edition), Order Manual 10400

Notational Conventions

UPPERCASE	Characters shown in uppercase must be entered in the order shown. You can enter the characters in uppercase or lowercase.
<i>italics</i>	Italics indicate variable information, such as <i>filename</i> or <i>address</i> .
[]	Brackets indicate optional arguments or parameters.
{ }	Braces indicate that one and only one of the enclosed entries must be selected. If they are also surrounded by brackets, the enclosed items are optional.
{ }...	Braces followed by ellipses indicate that at least one of the enclosed items must be selected. If the field is also surrounded by brackets, the enclosed items are optional. The items may be used in any order unless otherwise noted.
...	Ellipses indicate that the preceding argument or parameter may be repeated.
input lines	Examples of user input lines and responses are printed in white on black to differentiate user entry from system output.
<cr>	The characters "cr" enclosed in angle brackets in examples indicate that you should press the RETURN key. Do not enter the angle brackets or the characters "cr."



		PAGE	
CHAPTER 1			
GENERAL INFORMATION		PAGE	
Overview of UPP	1-1	Commands and Formats	4-2
General Description	1-1	Program Command	4-3
System Applications	1-2	Optional Keywords and Values	4-3
Role in Development	1-2	Examples	4-4
Software Types	1-2	Program" Command	4-6
System Configurations	1-3	Transfer Command	4-6
UPM Configurations	1-3	Optional Keywords and Values	4-6
PPROM Configurations	1-3	Examples	4-7
Monitor Configurations	1-3	Compare Command	4-8
General System Usage	1-3	Optional Keywords and Values	4-8
Personality Module Selection	1-4	Examples	4-9
Socket Board Replacement	1-5	Compare" Command	4-10
Personality Module Installation	1-6	Read Command	4-10
System Preparation and Initialization	1-8	Examples	4-12
Connecting UPP to Control Computer	1-8	Exit Command	4-13
Socket Adapter Selection and Installation	1-9	Other Commands	4-13
Software Initiation	1-10		
Turning UPP Power On	1-10		
Inserting the PROM	1-10		
Source Data Files	1-10		
CHAPTER 2			
PROGRAMMING WITH PPRM			
General	2-1	CHAPTER 5	
Program Loading	2-1	PERSONALITY MODULE USAGE	
Data Input	2-1	General	5-1
Programming	2-2	UPP-361	5-1
Commands and Formats	2-2	Applicable PROMs	5-1
Program Command	2-2	Programming	5-2
Transfer Command	2-4	UPP-816	5-2
Compare Command	2-4	Applicable PROMs	5-2
Monitor Call Command	2-5	Adapter Requirements	5-3
		Switch Setting	5-3
		Programming	5-4
		UPP-832	5-4
		Applicable PROMs	5-4
		Programming	5-4
		UPP-848	5-5
		Applicable PROMs	5-5
		Adapter Requirement	5-5
		Programming	5-6
		UPP-855 and UPP-955	5-6
		Applicable PROMs	5-6
		Adapter Requirement	5-7
		Programming	5-7
		UPP-865	5-8
		Applicable PROMs	5-8
		Adapter Requirements	5-8
		Switch Settings	5-8
		Programming	5-9
		UPP-872	5-9
		Applicable PROMs	5-9
		Programming	5-10
		UPP-878	5-10
		Applicable PROMs	5-10
		Switch Settings	5-11
		Programming	5-11
CHAPTER 3			
PROGRAMMING WITH MONITOR SOFTWARE			
General	3-1		
Start-Up Procedure	3-1		
Data Input	3-1		
Commands and Formats	3-2		
Program Command	3-2		
Transfer Command	3-3		
Compare Command	3-3		
P2708 Program	3-5		
CHAPTER 4			
PROGRAMMING WITH UPM SOFTWARE			
General	4-1		
UPM Software	4-1		



CONTENTS (Cont'd.)

	PAGE
UPP-820	5-11
Applicable PROMs	5-11
Adapter Requirements	5-12
Programming	5-12
UPP-833	5-14
Applicable PROMs	5-14
Adapter Requirements	5-14
Switch Settings	5-14
Programming	5-15

APPENDIX A ERROR CODES AND CONDITIONS

APPENDIX B UPM MEMORY ADDRESSING TECHNIQUE

APPENDIX C UPM COMMAND SUMMARY



TABLES

TABLE	TITLE	PAGE	TABLE	TITLE	PAGE
1-1	PROM-Personality Module Identification	1-4	4-1	PROM Names Recognized by UPM	4-2
1-2	Socket Adapter Selection	1-9	5-1	UPP-848 Switch Settings	5-6
2-1	PPROM Parameters	2-2	5-2	UPP-865 Device Selection	5-8
3-1	Monitor Parameters	3-2	5-3	UPP-865 Switch Settings	5-9
			5-4	UPP-833 Switch Settings	5-14



ILLUSTRATIONS

FIGURE	TITLE	PAGE	FIGURE	TITLE	PAGE
1-1	Universal PROM Programmer Front Panel	1-1	1-3	UPP Cabling Connections	1-8
1-2	Universal PROM Programmer Interior (Top) View	1-7	B-1.	Sets of Data Stored in Intellec Memory	B-1

This chapter contains information of general interest to all users of the Intel Universal PROM Programmer (UPP) regardless of application, the system to which the UPP is interfaced, or the type of PROM being programmed. It begins with an overview of the UPP and continues with a description of the three main types of software available with the UPP. General rules for using the system are then presented. Chapters 2, 3, and 4 present more specific information about the use of the UPP with each of the three main software systems with which it interfaces.

1-1. Overview of UPP

The UPP (figure 1-1) is a peripheral device used in the programming of Intel's family of electrically Programmable Read-Only Memories (PROMs). It must be used in conjunction with a system that will be referred to herein as the *control computer*; this generally will be one of Intel's Intellec microcomputer development systems, but it may be a timeshared system or a standalone processor with proper storage configurations to interface the UPP correctly. (Refer to the *Universal PROM Programmer Reference Manual* for details.)

1-2. General Description

On the front panel of the UPP are two zero-insertion-force sockets which accept the PROM's to be programmed. A POWER ON switch and indicator, a RESET switch, and a PROGRAMMING indicator make up the rest of the front panel. The RESET switch is used when the control computer is unable to communicate with the UPP and should not be used when reading or programming a PROM. The PROGRAMMING indicator lights when a PROM is being programmed.

Each of the two sockets on the front panel is controlled by a printed circuit board (PCB) that contains all the circuits necessary to program a particular class of PROMs. A variety of these PCBs, referred to as personality modules, is available; each of these modules is designed for use in programming specific PROMs. Two personality modules may be inserted into the UPP at one time, each controlling one of the front panel sockets.

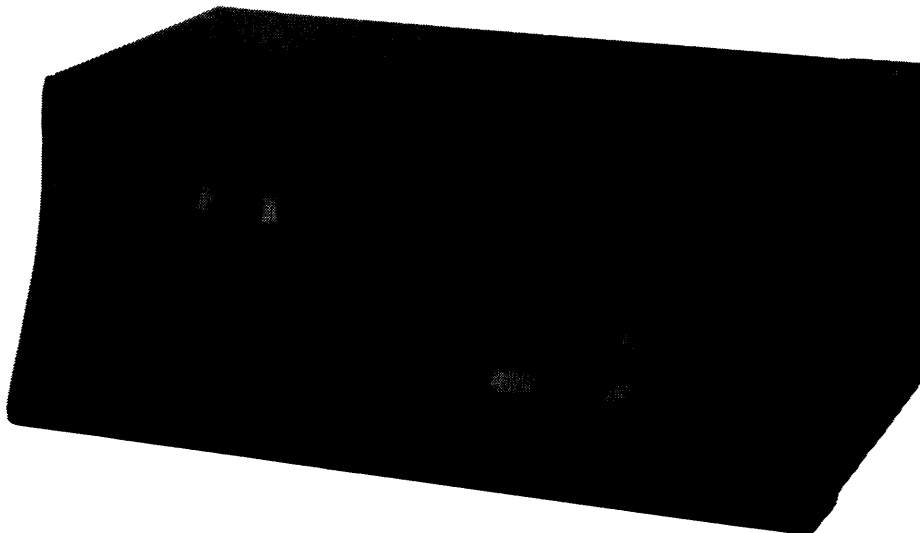

Figure 1-1. Universal PROM Programmer Front Panel

819-1

The UPP is housed in a 16- by 6- by 7-inch cabinet into which the personality module PCBs are inserted. A control board, which supervises the operation of the UPP, also resides in the cabinet together with the power supply.

More information about the hardware comprising the UPP is given in the *Universal PROM Programmer Reference Manual*.

1-3. System Applications

The UPP is useful in several aspects of microcomputer system development. It may be used to create a programmed PROM from a source data file stored in the Intellec. Data to be programmed can be entered into the Intellec from paper tape or diskette, or directly from the keyboard of an Intellec system using that particular system's Monitor software.

The UPP also may be used to duplicate and verify the accuracy of the programmed PROM, making it useful during the debugging of microprocessor-based systems under development. With the Universal PROM Mapper (UPM) software described in Chapter 4, the UPP offers additional flexibility in the formatting and manipulating of data.

It is in the development cycle that the UPP most often is used. In the manufacturing and field service aspects of system development and support, other equipment specifically designed for such uses will provide better results.

The UPP can be connected directly to the following development systems:

- a. Intellec Series III
- b. Intellec Series II
- c. Intellec 800

1-4. Role In Development

When a microprocessor-based system is in the development and design stage, the design engineer normally uses the Intellec system to create the programs that eventually will reside in PROM, using either the microprocessor's assembly language or a high-level language such as PL/M. Once that software has been tested, debugged, and finalized, a PROM is created and inserted into the prototype system so that the software can be verified in its ultimate operating environment.

It is at this stage of the development of the microprocessor-based system that the UPP finds its main use. It can be used to program the prototype PROM and to locate software errors or programming faults, as well as to create additional copies of the prototype PROM. These copies might be kept as a historical record or used for multiple system testing.

1-5. Software Types

Three types of software may be used to direct the operation of the UPP in conjunction with the control computer—UPM, PPRM, or Monitor.

UPM is available on diskette and is part of the Intel ISIS-II diskette operating system. This software system, which is described in more detail in Chapter 4, is the most powerful of the three available software types. In addition to the pro-

gramming, data transfer, and data comparison instructions common to all three types of software, the UPM offers a variety of other commands that allow the user flexibility in manipulating input data being written into the PROM. These instructions are summarized in Appendix C.

PPROM is a paper tape-based software package usable with all paper tape systems, including the Intellec 800 and the Intellec Series II systems. PPR0M, which may be used to program all Intel PROMs, is described in detail in Chapter 2.

Monitor is a software package resident in the Intellec 800. It can be used for programming all Intel PROMs except the 2704, 2708, 8704, and 8708. The programming of these PROMs (using Monitor software) requires the use of a paper tape program known as P2708. The P2708 package may be used *only* to program those PROMs that cannot be used with the standard Monitor software. The P2708 package, supplied with the UPP-878 Personality Module (Section 5-29), has been superseded by the PPR0M software.

1-6. System Configurations

This section describes the system configurations used to interface the UPP with each of the three available software systems described previously. All configurations, regardless of the software being used, require a UPP device, an Intellec system which acts as the control computer, and a control console/input keyboard. Additional requirements for each configuration are described in the following paragraphs.

1-7. UPM Configurations

UPM requires a minimum of 32k bytes of memory, which is adequate if the PROMs being programmed contain no more than 2k bytes; however, the memory should be expanded to 48k bytes to accommodate PROMs containing more than 2k bytes. Since these systems are equipped with diskette drive capability, no additional equipment is required. Where the ISIS-II diskette-based UPM system is to be used with other control computers (e.g., Intellec 800 or Series II Model 210), a diskette drive must be added to the basic configuration.

1-8. PPR0M Configurations

All PPR0M configurations require a paper tape reader in addition to the basic equipment mentioned above. With the Intellec 800 system, 16k bytes of memory are required. With Series II systems, the minimum memory requirement is 32k bytes.

1-9. Monitor Configurations

This software is usable only with the Intellec 800 system. It requires no additional equipment and requires at least 16k bytes of memory.

If the P2708 software is to be used with the Monitor on an Intellec 800 system, a paper tape reader must be added to the basic configuration. The minimum memory requirement remains at 16k bytes.

1-10. General System Usage

This section describes those aspects of UPP usage that are applicable to all system configurations, without regard to which personality modules are being used.

1-11. Personality Module Selection

Each Intel PROM that may be programmed with the UPP requires a specific personality module. These modules consist of a PCB containing all circuitry required to program a specific PROM or group of PROMs. Some of these modules require special adapters, and several of these modules have on-board switches that must be properly set. Detailed instructions on the use of each personality module are contained in Chapter 5.

Table 1-1 provides a summary of the currently available personality modules and the PROMs with which they are associated. This table serves as a guide in selecting the personality module appropriate to the specific PROM to be programmed by the UPP.

Table 1-1. PROM-Personality Module Identification

PROM Type	No. Pins	Organization	Personality Module	Description Section
1602A	24	256x8	UPP-872	5-26
1702A	24	256x8	UPP-872	5-26
1702A-2	24	256x8	UPP-872	5-26
1702A-6	24	256x8	UPP-872	5-26
1702AL	24	256x8	UPP-872	5-26
1702AL-2	24	256x8	UPP-872	5-26
2704	24	512x8	UPP-878	5-29
2708	24	1024x8	UPP-878	5-29
2716	24	2048x8	UPP-816	5-5
2732	24	4096x8	UPP-832/833	5-10/5-39
2732A	24	4096x8	UPP-833	5-39
2758	24	1024x8	UPP-816	5-5
2758 S-1865	24	1024x8	UPP-816	5-5
2764	28	8192x8	UPP-833	5-39
2920	28	1152x4	UPP-820	5-33
3601	16	256x4	UPP-361	5-2
3602	16	512x4	UPP-865	5-21
3602A	16	512x4	UPP-865	5-21
3604	24	515x8	UPP-865	5-21
3604A	24	512x8	UPP-865	5-21
3604L-6	24	512x8	UPP-865	5-21
3604AL	24	512x8	UPP-865	5-21
3605	18	1024x4	UPP-865	5-21
3605A	18	1024x4	UPP-865	5-21
3608	24	1024x8	UPP-865	5-21
3621	16	256x4	UPP-865	5-21
3622	16	512x4	UPP-865	5-21
3622A	16	512x4	UPP-865	5-21
3624	24	512x8	UPP-865	5-21
3624A	24	512x8	UPP-865	5-21
3625	18	1024x4	UPP-865	5-21
3625A	18	1024x4	UPP-865	5-21
3628	24	1024x8	UPP-865	5-21
3636	24	2048x8	UPP-865	5-21
4702	24	256x8	UPP-872	5-26
4702A	24	256x8	UPP-872	5-26
8702A	24	256x8	UPP-872	5-26
8702A-4	24	256x8	UPP-872	5-26
8704	24	512x8	UPP-878	5-29
8708	24	1024x8	UPP-878	5-29
8741	40	1024x8	UPP-848*	5-13
8742	40	2048x8	UPP-848	5-13
8748	40	1024x8	UPP-848*	5-13
8749	40	2048x8	UPP-848	5-13
8751	40	4096x8	UPP-833	5-39

Table 1-1. PROM-Personality Module Identification (Cont'd.)

PROM Type	No. Pins	Organization	Personality Module	Description Section
8755	40	2048x8	UPP-855 or 955** with UP1	5-17
8755A	40	2048x8	UPP-855 or 955** with UP2	5-17

* Adapter included.

** UPP-955 replaced UPP-855. With the use of adapter UP2, the UPP-855 can be converted to a UPP-955.

***8051 is read-only; no programming is possible.

1-12. Socket Board Replacement

Two socket boards are available with the UPP. The UPP-501 socket board (PWA 1000419) includes a 16-pin zero-insertion-force socket in the SOCKET 1 position and a 24-pin zero-insertion-force socket in the SOCKET 2 position. The UPP-502 socket board (PWA 1000424) includes a 24-pin zero-insertion-force socket in both socket positions.

To change socket boards, procede as follows:

WARNING

Before removing the UPP's top cover panel, set the front panel ON/OFF switch to the OFF position and *remove the ac power cord* from the power source. Wait at least 60 seconds to allow the UPP's power supply to discharge. This will prevent possible electrical shock and protect the UPP components.

- a. Remove the UPP's top cover panel by twisting each of the four screw fasteners approximately 1/4 turn counterclockwise and then lifting the cover off.
- b. Remove the personality module PCB's (if installed) by lifting the two plastic locking tabs on each PCB (to unseat the PCB from the mother board connector) and raising the PCB straight up and out of the chassis.
- c. Carefully remove the UPP's front bezel by removing the hex standoffs at the inside top corners of the UPP. (Refer to figure 1-2.) With the standoffs removed, pull the bezel forward from the bottom to release the two quick-disconnect fasteners which hold the bottom of the bezel to the chassis. Lay the bezel in front of the UPP. Note that the cables between the socket board and mother board restrict bezel travel to approximately four inches.
- d. Disconnect the four cable assemblies at the socket board connector pin headers.
- e. Remove the five screws that secure the socket board to the back of the bezel. Make sure that the socket locking arms are in their up positions and then remove the socket board.
- f. Make sure that the protective cover on the front of the replacement socket board is in place. (The protective cover provides electrical isolation between the bezel and the socket board.)
- g. With the socket locking arms in their up position, align the replacement socket board on the bezel with the connector pin headers toward the bottom of the bezel. Replace the five screws that secure the socket board to the bezel.
- h. Connect the four cable assemblies to the socket board as shown in figure 1-2.

- i. Position the bezel on the chassis and push the bezel in place to seat the quick-disconnect fasteners. Replace the hex standoffs that secure the top of the bezel to the chassis.
- j. Carefully replace the personality module PCBs into their appropriate card slots and with the component side of each PCB facing the front of the UPP.
- k. Press down on the two plastic locking tabs to seat each PCB into its corresponding mother board connector.
- l. Replace the top cover panel and secure it in place by twisting the four screw fasteners 1/4 turn clockwise.

1-13. Personality Module Installation

Since some applications require the ability to program several types of PROMs, the UPP has been designed so that the personality modules to accommodate various PROM's may be exchanged easily.

Figure 1-2 shows the interior of the UPP as viewed from the rear. Three card slots for PCB's are provided. The card slot nearest the rear of the UPP holds the control board, which normally is not removed except for maintenance. The card slot nearest the front of the UPP holds the personality module that is associated with SOCKET 1 on the front panel (the 16-pin socket on the UPP-501 socket board). The center card slot holds the personality module that is associated with SOCKET 2.

The step-by-step procedure for exchanging personality modules is as follows:

- a. Set personality module on-board switch(es) if required. (Refer to appropriate section of Chapter 5.)

WARNING

Before removing the UPP's top cover panel, set the front panel ON/OFF switch to OFF and *remove the ac power cord* from the power source. Wait at least 60 seconds to allow the UPP's power supply to discharge. This will prevent possible electrical shock and protect the UPP components.

- b. Remove the UPP's top cover panel by twisting the four screw fasteners approximately 1/4 turn counterclockwise and then lifting the cover off.
- c. Remove the existing personality module PCB, if installed, by lifting up its two plastic locking tabs (to unseat the PCB from its mother board connector) and raising the PCB straight up and out of the chassis.
- d. Carefully place personality module PCB to be installed into proper card slot with the component side of the PCB facing toward the front of the UPP.
- e. Press down on the two plastic locking tabs to seat the PCB into its corresponding mother board connector.
- f. Using a pencil, record PCB designation (e.g., UPP-872, -878, etc.) on identification panel under appropriate socket.

CAUTION

Use of mismatched personality module and PROM may damage either or both components.

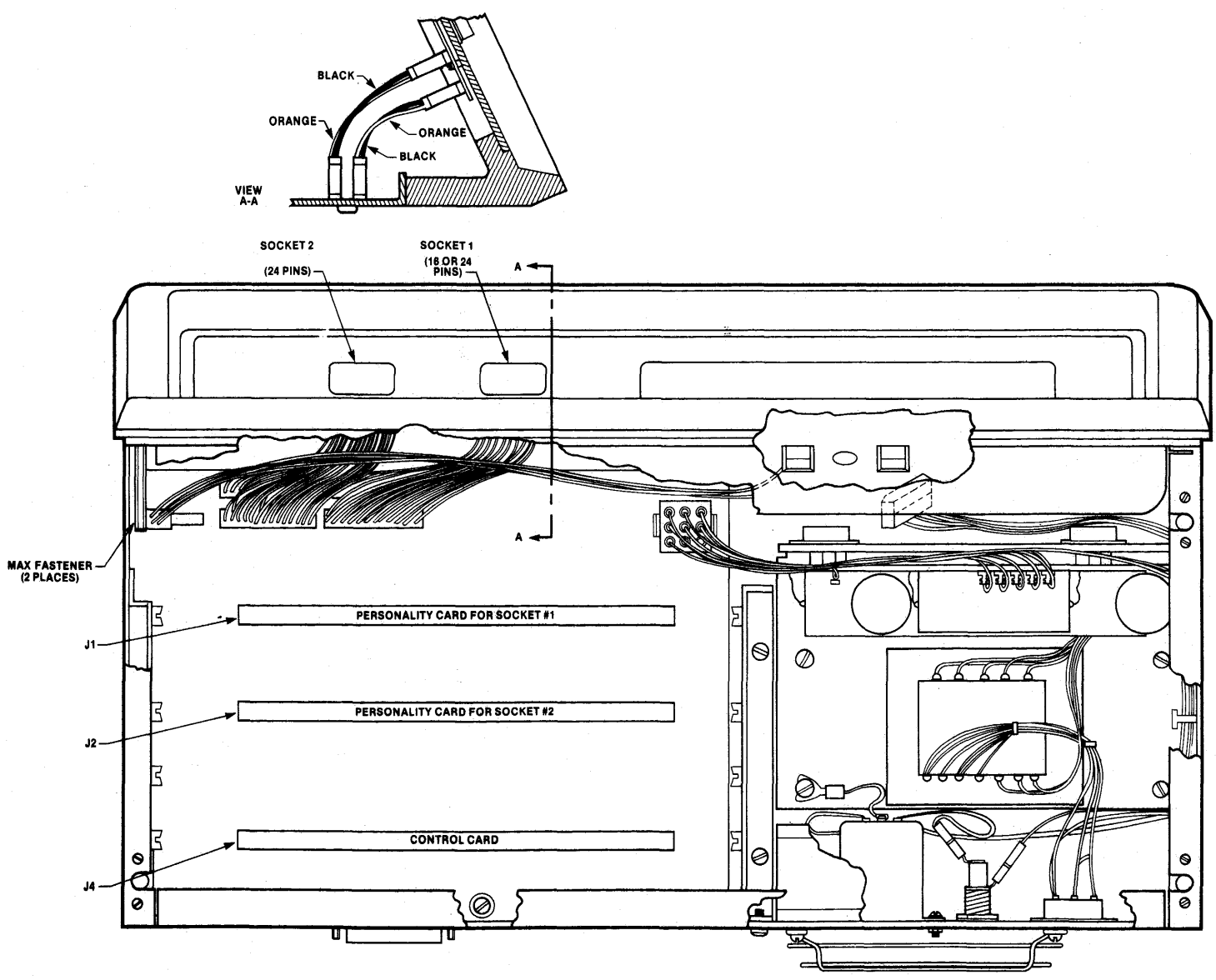

Figure 1-2. Universal PROM Programmer Interior (Top) View

- g. Place the top cover panel on the UPP and fasten by twisting the four screw fasteners 1/4 turn clockwise.



To ensure proper circulation of ventilating air, the UPP never should be operated with the top cover panel removed.

1-14. System Preparation and Initialization

With the proper personality module(s) installed in the UPP, the following additional steps must be taken before programming a PROM:

- Connect UPP to control computer.
- Determine if a socket adapter is required and install if necessary.
- Set UPP power to ON.
- Load and call appropriate control computer software system.
- Install PROM(s) to be programmed.

Each of these steps is described in detail in the following subsections.

1-15. Connecting UPP to Control Computer

The UPP interfaces to the Intellec 800 and all models of the Intellec Series II with a single cable. Figure 1-3 shows the cable connections.

Connecting the UPP to the appropriate Intellec system requires the connection of the proper cable between the UPP rear panel receptacle and the designated receptacle on the Intellec system enclosure rear panel.

If any system other than an Intellec is used, configuration and connection must conform to the UPP requirements outlined in the *Universal PROM Programmer Reference Manual*.

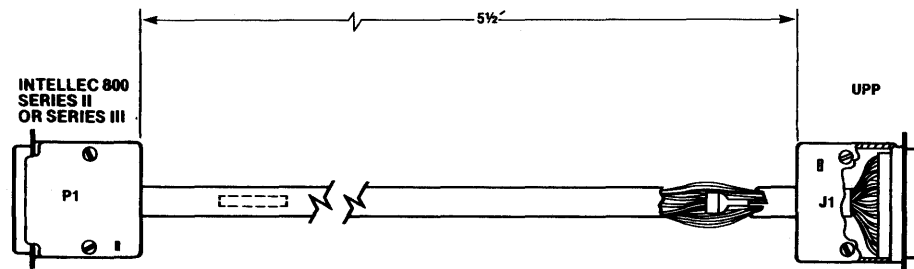

Figure 1-3. UPP Cabling Connections

819-3

1-16. Socket Adapter Selection and Installation

Some PROMs—notably those with fewer or more than the number of pins for which the sockets on the UPP front panel are designed—require the use of a socket adapter. The type of adapter depends on the type of PROM being programmed as summarized in table 1-2. All adapters are inserted into a 24-pin socket.

The installation procedure for any type socket adapter is as follows:

- a. Select appropriate adapter for PROM to be programmed. (Refer to table 1-2.)
- b. Ensure that the correct personality module PCB is installed and that it is associated with a to 24-pin socket on the UPP's front panel.
- c. Raise the locking arm of the associated socket and, if a PROM is installed in the socket, remove the PROM.
- d. Insert the socket adapter with pin 1 of the adapter aligned with the upper left corner of the socket.
- e. Secure adapter by moving socket locking arm upward until it is against the UPP's front panel.

NOTE

Adapter must be oriented properly (with respect to pin 1) for successful programming. If adapter is installed incorrectly, an error message may be displayed on operator console.



The UPP-555 Adapter shorting jumper and shorting jumper block must be installed for some PROM types. For a 2758 PROM, a two-pin shorting plug must be installed into the contacts labelled "S" (to the left of the 2758 label on the adapter). For a 2758 S-1865 PROM, this two-pin plug must be removed. All others are "don't care" situations.

Table 1-2. Socket Adapter Selection

PROM	Adapter Required	Adapter Identification Label
2758, 2758 S-1865	UPP-555	UPP-555, PWA 4601633
2764	UPP-564	UPP-564, PWA 162293
2920	UPP-820	2920, PWA 1002305
3602, 3602A	UPP-562	3602/3622, PWA 1000555
3604L-6, 3604AL	UPP-555	UPP-555, PWA 4601633
3605, 3605A	UPP-566*	3605/3625, PWA 1000745
3608	UPP-555	UPP-555, PWA 4601633
3621	UPP-562	3602/3622, PWA 1000555
3622, 3622A	UPP-562	3602/3622, PWA 1000555
3625, 3625A	UPP-566*	3605/3625, PWA 1000745
3628, 3636	UPP-555	UPP-555, PWA 4601633
8051, 8751	UPP-551	UPP-551, PWA 162394
8742, 8749	UPP-549	UPP-549, PWA 162621
8755	UP1	
8755A	UP2	

*UPP-566 replaces UPP-565 and programs both the A version and the non-A test version.

1-17. Software Initiation

Software initiation involves loading and calling the appropriate software program to undertake the programming of the PROM. Instructions vary slightly with the software system being used.

PPROM instructions are contained in Sections 2-1 through 2-4, Monitor instructions in Section 3-1 through 3-3, and UPM instructions in Section 4-2.

1-18. Turning UPP Power On

The front panel POWER switch is used to apply power to the UPP.



To prevent possible damage to the PROM or accidental programming at one or more memory locations, the UPP POWER switch must be ON before the PROM is inserted into the socket or socket adapter.

1-19. Inserting the PROM

The procedure for inserting the PROM to be programmed into the front panel socket is as follows:

- a. Set UPP POWER switch to ON.
- b. Ensure that the proper personality module is installed and corresponds to the socket to be used.
- c. Confirm that UPP is properly connected to control computer.
- d. At the selected socket, raise the locking arm up (away from the UPP panel).
- e. If a PROM is installed in the socket, remove the PROM.
- f. Insert PROM to be programmed into the socket with pin 1 of the PROM aligned with the upper left corner of the socket.



The semicircular notch on one end of the PROM must be toward the top of the socket. Attempting to program a PROM which has been inserted incorrectly may damage the PROM.

- g. Secure PROM in socket by moving the locking arm upward until it is against the UPP front panel.

The PROM is now ready for programming.

1-20. Source Data Files

The data to be written into the PROM must be contained in a source data file in the format in which the UPP expects to receive such information. (Refer to Section 4-4 and Appendix C for ways in which UPM software can be used to overcome format problems.) These files are constructed using the Intellec system in accordance with instructions given in the documentation accompanying those devices. The source data file must be an object code file; its method of production is immaterial to the UPP device.

The UPM Read command is the most common means of reading data from a file into the Intellec memory. (Refer to paragraph 4-14.)

2-1. General

PPROM is a paper tape software package (supplied with the Intellec Series II Model 210) that also can be used with other Series II and Series III systems and the Intellec 800. It can be used to program all Intel PROMs.

Before PPRM can be used to program a PROM with the UPP, the Intellec system must be properly set up. (Refer to paragraph 1-14.)

NOTE

The POWER switch on the UPP must be set to ON prior to inserting the PROM to be programmed. Failure to observe this precaution may cause one or more PROM locations to be programmed accidentally.

Three steps make up the programming sequence with the UPP: (1) program loading, (2) data input, and (3) PROM programming. The following paragraphs describe each of these steps in detail.

2-2. Program Loading

When the Intellec system is set up and ready for use, the Intellec Monitor prints a period (.) prompt. The following procedure loads the PPRM program into the Intellec system for execution:

- a. Place PPRM program tape into paper tape reader using instructions for the reader.
- b. Type "R0" on operator console to store PPRM into Intellec memory locations 0100H-0FFFH.
- c. When program has been loaded and monitor displays prompt ".", type "G" to call PPRM program.

NOTE

If operations with software other than PPRM are undertaken at any point and it is necessary to return to the PPRM program, the "G" command must carry the PPRM entry point address of 100. In these cases, type "G100" when prompted.

- d. When PPRM is ready, an asterisk (*) prompt is displayed on the operator console.

The system is ready to program a PROM with the PPRM software.

2-3. Data Input

Data to be programmed into the PROM must be stored in Intellec memory. It may be placed there by any of three methods: (1) transfer from another PROM via UPP, (2) reading from paper tape, or (3) reading from diskette file. Since only the first method requires the use of the UPP, it is the only method described in this manual (paragraph 2-7); the other methods are described appropriately in the *Intellec Operator's Manual* and *ISIS-II User's Guide*.

2-4. Programming

When the PPROM program has been loaded and called and the data to be programmed into the PROM has been stored in the Intellec memory, programming the PROM requires the following steps:

- a. Turn UPP power ON.
- b. Insert PROM to be programmed into proper socket.
- c. Use Program command (paragraph 4-4) to program PROM.

2-5. Commands and Formats

Four commands are valid with PPROM software—Program (P), Transfer (T), Compare (C), and Monitor Call (M). The first three commands (P, T, and C) are used only with the UPP for PROM programming; the last command (M) is used to return system control to the Intellec Monitor.

All four commands are entered at the control console using the initial letter of the desired operation (P, C, T, or M).

Each of the three PROM programming commands is followed by a string of parameters as defined in table 2-1. This table is referenced throughout this section as each of the PROM programming commands is described.

2-6. Program Command

The Program (P) command places data stored in specified Intellec memory locations into a PROM on a designated front-panel UPP socket. (See table 2-1 for an explanation of the parameters.) The general form of this command is:

P data_sense socket_no. format [algorithm] , lo_address , hi_address , [PROM_address]

After the programming operation is complete, the PPROM software automatically performs a Compare operation. Differences found between data stored in the specified Intellec address locations and data programmed into the PROM are output to the operator console. (See following examples and refer to paragraph 2-8.)

Table 2-1. PPROM Parameters

Parameter	Value(s)/Options(s)	Description
<i>data_sense</i>	F	<i>data_sense</i> is false; bits read from memory or PROM are complemented (i.e., 0's become 1's and 1's become 0's) before being written into PROM or memory.
	T	<i>data_sense</i> is true; bits read from memory or PROM are unchanged (i.e., 0's remain 0's and 1's remain 1's) when written into PROM or memory.
<i>socket_no.</i>	1 or 2	Number of UPP PROM socket where PROM to be programmed or read is inserted.
<i>format</i>	B	Full byte at a time.
	U	Upper 4-bit nibble of byte stored in Intellec memory. Lower nibble is ignored and unchanged in Program or Compare. In Transfer, lower nibble bits are written as 0's.

Table 2-1. PPROM Parameters (Cont'd.)

Parameter	Value(s)/Options(s)	Description
	L	Lower 4-bit nibble of byte stored in Intellec memory. Upper nibble is ignored and unchanged in Program or Compare. In Transfer, upper nibble bits are written as 0's.
<i>algorithm</i>	W or omitted	W is used when programming 2704, 2708, 8704, or 8708 PROM. Omit W for all others.
<i>lo_address</i> <i>hi_address</i>	Hex values	Specifies Intellec memory locations (inclusive) from which data to be programmed into PROM is to be read (Program) or to which data in PROM is to be moved (Transfer). <i>lo_address</i> must be greater than 1000H and <i>hi_address</i> must be greater than <i>lo_address</i> . (See notes 1 and 2.)
<i>PROM_address</i>	Hex or omitted	Starting PROM address where data is to be written to or read from. If omitted, zero is assumed. (See note 3.)

Notes

1. When programming with "W" algorithm, *hi_address* minus *lo_address* plus 1 must be an even multiple of 16.
2. If memory area between *lo_address* and *hi_address* exceeds PROM capacity in Transfer, data in unused Intellec memory is unaffected. Similarly, if PROM contents exceed specified memory area, excess data in PROM is ignored.
3. When programming with "W" algorithm, *PROM_address* must be an even multiple of 16.

Example 1

SOCKET 1 contains a 16-pin PROM to be programmed with the upper nibble of each of the specified bytes in Intellec memory. Each bit is to be complemented prior to programming. Data for programming is located in Intellec memory locations 1000H-11FFH, inclusive. Since the PROM address is to be 0, this parameter is omitted. Enter the following at the operator's console:

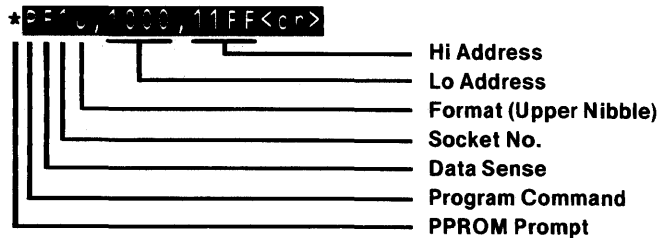

Example 2

SOCKET 2 contains a 24-pin PROM to be programmed beginning at location 0FFH with the contents of Intellec memory locations 1000H through 10FFH, inclusive. Data is stored in its unaltered form (i.e., requires no complementing). Full-byte programming is to be used. Enter the following at the operator's console:

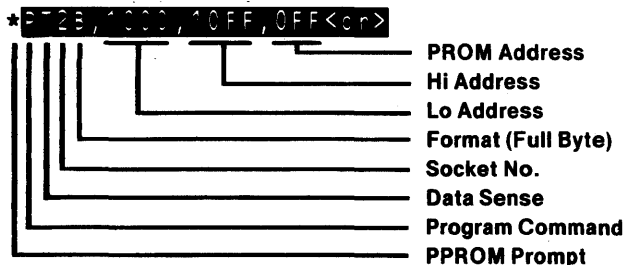

If, during the Compare operation following completion of the above programming operation, the PPROM software detects a byte in error, the following message is output to the operator's console:

```

COMPARE ERROR ADDR:      166      PROM=D1      RAM=D9
                        └───┬───┘ └───┬───┘ └───┬───┘
                        PROM  PROM  RAM
                        Location Contents Contents
    
```

All COMPARE ERROR messages are identical in format.

2-7. Transfer Command

The Transfer (T) command transfers data from a PROM in the designated UPP front panel socket into the specified Inteltec memory locations. (See table 2-1 for an explanation of the parameters.) The general form of this command is:

T data_sense socket_no. format, lo_address, hi_address, [PROM_address]

Example

SOCKET 2 contains a 24-pin PROM with data programmed in byte format. Data need not be complemented during transfer to Inteltec memory locations 1000H-11FFH, inclusive. Enter the following command at the operator's console:

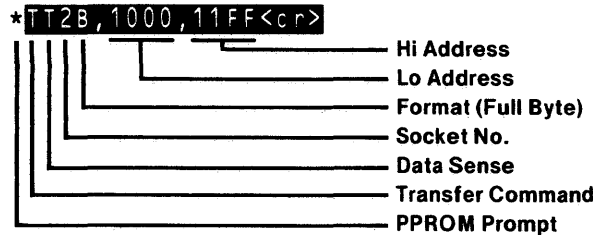

2-8. Compare Command

The Compare (C) command reads data from a PROM inserted in one of the two front panel sockets on the UPP and compares it to data read from the specified Inteltec memory locations. Differences are listed at the operator's console. (See table 2-1 for an explanation of the parameters.) The general form of this command is:

C data_sense socket_no. format, lo_address, hi_address, [PROM_address]

Example

SOCKET 2 contains a 24-pin PROM with data programmed in byte format. Its contents are to be compared with the contents of Inteltec memory locations 4000H-43FFH, inclusive. Data is not complemented in the PROM. Since the starting PROM address is 0, this parameter is omitted. Enter the following command at the operator's console:

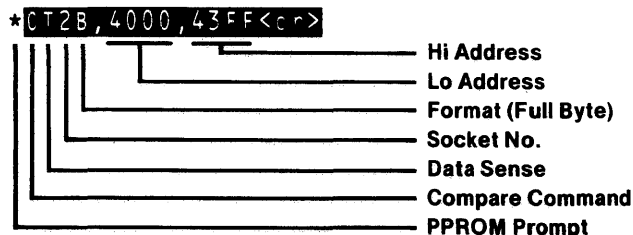

Assuming the contents of Intellec memory location 4300H do not match the contents of the corresponding PROM location, the following message will be output to the operator's console:

COMPARE ERROR ADDR:	<u>300</u>	<u>PROM=D9</u>	<u>RAM=FF</u>
	PROM	PROM	RAM
	Location	Contents	Contents

2-9. Monitor Call Command

The Monitor Call (M) command returns control of the Intellec system to the Monitor. Typically, this command is used when PROM programming is complete, but it also may be used to return control to the Monitor to permit more data to be read into the Intellec memory or for any other reason in which Monitor control is desired.



3-1. General

The Monitor software package, which is resident in the Intellec 800, includes PROM programming capability that can be used to program all Intel PROMs except the 2704, 2708, 8704, and 8708 devices. These four PROMs require use of the PPRM, UPM, or the P2708 Monitor supplement described in paragraph 3-8.

Since the Monitor is system-resident, it requires no loading or calling procedure such as those used to implement PPRM and UPM software. Before a PROM can be programmed, the Intellec 800 system must be properly set up and the PROM must be inserted in a connected UPP device.

NOTE

The POWER switch on the UPP must be set to ON before inserting the PROM to be programmed. Failure to observe this precaution may cause one or more PROM locations to be programmed accidentally.

The start-up procedure for the Intellec 800 system is described in Section 3-2, data input methods are discussed in Section 3-3, and general programming techniques and parameters are outlined in Section 3-4.

3-2. Start-Up Procedure

If the Intellec 800 system has been powered off or is being installed as a new device, a "cold start" or "bootstrap" must be performed before the Monitor software can be used. The procedure for this start-up is as follows:

- a. Turn on Intellec 800 system power by inserting key in power switch and turning key clockwise.
- b. Press top of BOOT rocker switch.
- c. Press top of RESET rocker switch.
- d. Enter a space on operator console.
- e. System responds with the following (or similar) message indicating Monitor is ready to run:

```
MDS MONITOR, Vx.y
```

- f. Press bottom of BOOT switch.
- g. System displays Monitor prompt (.).

The Intellec 800 system now is ready to accept the first command.

3-3. Data Input

Data to be programmed into the PROM must be stored in Intellec memory. It may be placed there by any of three methods: (1) transfer from another PROM via UPP, (2) reading from paper tape, or (3) reading from an ISIS-II (diskette) file.

Since only the first method requires the use of the UPP, it is the only method described in this manual (paragraph 3-6). The others are described appropriately in the *Intellec System Operator's Manual* and the *ISIS-II User's Guide*.

3-4. Commands and Formats

Three Monitor commands are used exclusively with the UPP device—Program (P), Transfer (T), and Compare (C). Each of these commands has an associated string of parameters including some or all of those shown in table 3-1. The table should be referred to throughout the discussion of these three commands in paragraphs 3-5 through 3-7.

Each Monitor command is entered by keying the first character of the command name (i.e., P for *Program*, T for *Transfer*, or C for *Compare*) followed by the string of appropriate parameters.

Table 3-1. Monitor Parameters

Parameter	Value(s)/Options(s)	Description
<i>data_sense</i>	F	<i>data_sense</i> is false; bits read from memory or PROM are complemented (i.e., 0's become 1's and 1's become 0's) before being written into PROM or memory.
	T	<i>data_sense</i> is true; bits read from memory or PROM are unchanged (i.e., 0's remain 0's and 1's remain 1's) when written into PROM or memory.
<i>socket_option</i>	X	SOCKET 2 (24 pins).
	Y	SOCKET 1. If SOCKET 1 has 24 pins, this option is used interchangeably with Z in Program (P) and Transfer (T). To Compare (C) from 24-pin SOCKET 1, both Y and Z must be used in separate operations. If SOCKET 1 has 16 pins, Y selects <i>upper</i> nibble of byte (bits 4-7).
	Z	SOCKET 1. Same as Y, except if SOCKET 1 has 16 pins, Z selects <i>lower</i> nibble of byte (bits 0-3).
<i>lo_address</i> <i>hi_address</i>	Hex Values	Specify Intellec memory locations (inclusive) from which data to be programmed into PROM is to be read (Program) or to which data in PROM is to be moved (Transfer). <i>lo_address</i> must be greater than 100H and <i>hi_address</i> must be greater than <i>lo_address</i> . (See Note 1.)
<i>PROM_address</i>	Hex Value	Location in PROM where specified operation is to begin.

Note:

1. If memory area between *lo_address* and *hi_address* exceeds PROM capability in Transfer, data in unused Intellec memory is unaffected. Similarly, if PROM contents exceed specified memory area, excess data in PROM is ignored.

3-5. Program Command

The Program (P) command places the data contained in Intellec memory locations defined by Hi Address and Lo Address, inclusive, into a PROM inserted in the designated UPP front panel socket. The general form of this command is:

P *data_sense socket_option lo_address, hi_address, PROM_address*

As each byte is programmed into the PROM, the Intellec system reads the byte and compares it with the same byte in the Intellec memory. If an error occurs because one or more bits do not program correctly, the Monitor stops the Program operation and outputs an error message to the operator's console followed by the Monitor "error prompt", an asterisk (*).

Example 1

SOCKET 1 contains a 16-pin PROM to be programmed in 4-bit nibbles. Each byte is complemented prior to programming. Data to be programmed is contained in the upper nibble in Intellec memory locations 100H-1FFH; it is to be written into the PROM starting at address 0. Enter the following command at the operator console:

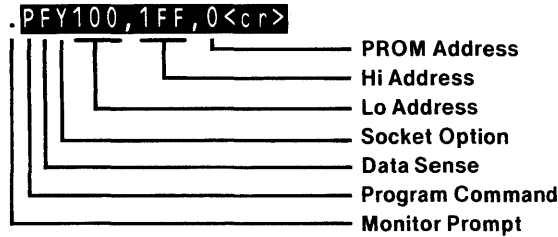

Example 2

If a programming error occurs at PROM address 1F0H, the error message will be:

1F0 *

3-6. Transfer Command

The Transfer (T) command reads data from the PROM inserted in the designated UPP front panel socket into the specified Intellec memory locations. The general form of this command is:

T data_sense socket_option lo_address , hi_address

Example

SOCKET 2 contains a 24-pin PROM with data in 8-bit bytes. This data, in its uncomplemented form, is to be transferred to Intellec memory locations 100H-1FFH, inclusive. Enter the following command at the operator console:

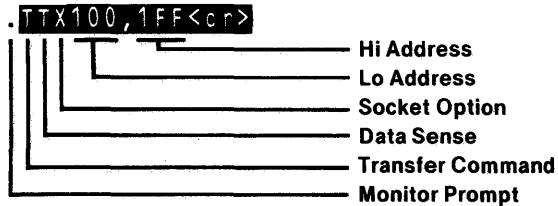

3-7. Compare Command

The Compare (C) command reads data from the PROM inserted in the designated UPP front panel socket and compares it, byte-for-byte, with the data stored in the specified Intellec memory locations. The general form of this command is:

C data_sense socket_option lo_address , hi_address

Differences between the two sets of data are displayed on the operator console in the following format:

Intellec_memory_location Intellec_contents PROM_contents

The following examples demonstrate the use of the Compare command and show how a difference between the PROM contents and the Intellec memory contents is reported.

Example 1

SOCKET 2 contains a PROM whose contents are to be compared with the contents of Intellec memory locations 4000H-43FFH, inclusive; the data is complemented. Enter the following command at the operator's console:

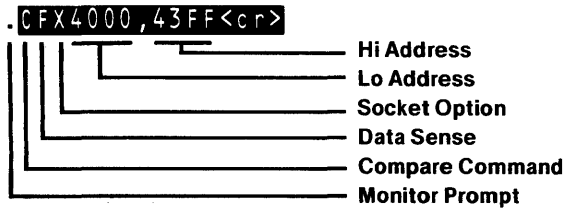

During the Compare operation, a difference between the contents of Intellec memory location 4300 and the corresponding PROM location is detected. The system displays the following message:

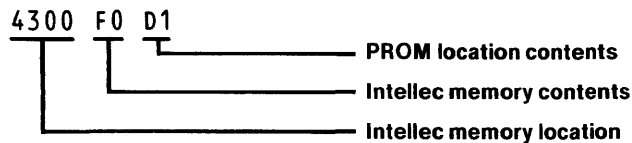

Example 2

The contents of a PROM in SOCKET 1 are to be compared with the contents of Intellec memory locations 4000H-43FFH, inclusive; data is uncomplemented. Since SOCKET 1 Compare operations always take place in 4-bit nibbles, the first of *two* commands must be entered at the operator console as follows:

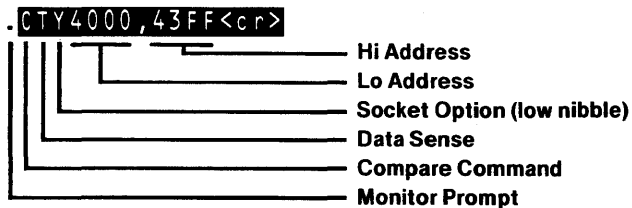

The above command will accomplish the comparison of the low-order bits (bits 0-3) of each PROM location with the corresponding low-order bits in Intellec memory. On completion of that Compare operation, the second command must be entered at the operator console to complete the comparison:

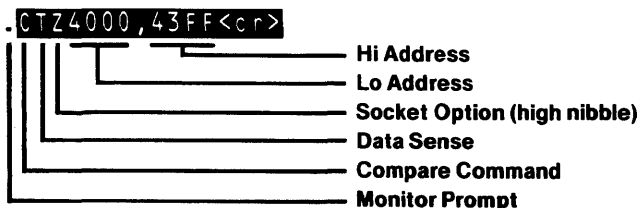

3-8. P2708 Program

The P2708 program is a supplementary software package used with Monitor to program the Intel 2704, 2708, 8704, and 8708 Erasable PROMs (EPROMs). The P2708 package is not a recommended software package, since all functions of the P2708 software are performed by the UPM and PPRM software. For this reason, data in this section is supplied for reference only.

Operationally, there are two differences between P2708 and Monitor PROM programming techniques. First, the P2708 is not system-resident and therefore must be loaded from paper tape before it can be used. The procedure for loading and executing P2708 is described below. Second, the four PROMs that may be programmed with the P2708 package require the programming to begin at PROM address 0. As a result, no PROM address need be specified in using P2708.

There is one other difference that is not a function of P2708, but rather of the PROMs with which it is used. All four of the PROMs that can be programmed with this package are 24-pin devices with 8-bit bytes. This means that SOCKET 1 cannot be used with P2708 if it is a 16-pin socket and also that the Y and Z socket options have identical meanings rather than different uses depending on the size of the socket installed as is the case with Monitor software.

In every other respect, P2708 is identical to Monitor software. Examples and descriptions of command formats provided in paragraph 3-7 apply to P2708 in every respect except those described above.

The procedure for loading the P2708 software from paper tape into the Intellec system is as follows:

- a. Ensure Monitor system is operational and prompt character (.) appears on operator console.
- b. Place P2708 program tape into paper tape reader, following instructions for reader.
- c. Enter Intellec Monitor READ command as follows:
`.R0<:r>`
- d. This initiates reading the P2708 software into memory. When reading is complete, use Monitor G command to call P2708 as follows (P2708 reads into Intellec memory beginning at location 20H.)
`.G20<:r>`
- e. When the P2708 software is loaded, the P2708 prompt character (:) appears on operator console. PROM programming may begin.

All three Monitor PROM programming commands (Program, Transfer, and Compare) described in paragraphs 3-5 through 3-7 are used with P2708 software exactly as with Monitor software with the exception of the different prompt character and the omission of PROM Address. Socket options Y and Z, as indicated, have identical meanings with P2708.

4-1. General

The Universal PROM Mapper (UPM) software system is used with an Intel development system to program all Intel PROMs. The UPM command set consists of 16 instructions, as opposed to the three-command structure of the other two software systems described in this manual. Aside from the Program, Transfer, and Compare commands available with all three types of PROM programming software, UPM offers a range of instructions which may be used to alter and reformat data during programming and data transfer or compare operations.

Discussion of the UPM software is contained in two places in this manual. In this section, the main commands used in most applications are described. In Appendix C, the other 10 commands, which are used less frequently, are provided in summary form. Most PROM programming applications rarely use these 10 commands (if at all), and the UPM user need not be concerned with a detailed understanding of their use. A review of Appendix C (and reference to it when a specific command is needed to meet a requirement) will provide the user with sufficient information to allow proper use of the UPM's flexibility.

All addresses used in the commands in this chapter are referred to as "logical word positions." The relationship between this logical address space and the actual Intel memory address is explained in Appendix B.

In this section, the available UPM software is described and procedures for loading it are outlined. Then, the general format for UPM commands is described before the Program, Program'', Transfer, Compare, Read, and Exit commands are discussed individually. Finally, an introduction to the remaining 10 instructions is provided in paragraph 4-16.

4-2. UPM Software

UPM is available in a diskette-based system that operates under control of the ISIS-II operating system. The diskette-based version of UPM operates under control of the ISIS-II Diskette Operating System. The procedure for loading this version of UPM is as follows:

- a. Ensure Intel development system is properly configured and operational. ISIS prompt character (-) will be displayed at operator console.
- b. Instruct ISIS-II to load and execute UPM by entering command as follows:
`-UPM<cr>`
- c. UPM will respond by displaying following message:
ISIS-II PROM MAPPER Vx.y
TYPE*

The type (number) of the PROM to be programmed now must be entered. Refer to table 4-1 for valid names.

Table 4-1. PROM Names Recognized by UPM

Name Type =	Note
1702A 2704 2708 2716 2732 2732A 2758 2764	Use also for 1702 and 1602A Use also for 8704
3601 3602 3602A 3604 3604A 3604L	Use also for 2758S-1865 Use also for 3604AL
3605 3608 3621 3621A 3622 3622A 3624 3624A	Use also for 3605A Use also for 3625A
3625 3628 3636 4702A 8702A 8708	Use also for 4702 Use also for 4702
8741 8748 8755	Use also for 8742 Use also for 8051, 8751, and 8749 Use also for 8755A

For any PROM with a dash number (different speed or power), do not enter '-xx'. For any Mxxxx (Mil-spec parts), do not enter the M.

4-3. Commands and Formats

UPM commands entered at the operator console are made up of a command name with additional values, words, parameters, and keywords depending on the command being used. Some of the parameters used with UPM commands may be entered as separate command lines rather than as part of the command string itself.

The command name must be entered using enough letters to make the name unique (e.g., PRO for PROGRAM, COM for COMPARE, etc.). If desired, the entire command name may be spelled out; if this is done, it must be spelled correctly.

Keywords and values that specify parameters to be used with a command may be entered in any order. They are separated from one another by a space, an equal sign, or a comma, as appropriate. The specific delimiter is defined during the discussion of the commands in this section and in Appendix C.

All UPM commands end with a carriage return (not shown in the examples and descriptions in this manual). If it is necessary to continue a command to a second line, type an ampersand (&) at the end of the line to be continued, then enter a carriage return. The system will display two asterisks as the continuation prompt and the command may be continued at that point.

Line continuation is sometimes necessary because of the system's 128-character limitation on display lines. (If this limit is exceeded, the error message LINE TOO LONG is displayed and the line being entered is discarded. It then must be completely reentered.) No command may exceed 256 characters. The ampersand

character, if used, must be the last non-blank character on the line or it will not have the desired result. The carriage return following the “&” will not serve as a separator; a space or a comma must be used at the the start of the next line. A space or blank must precede “&”; if the command permits a “,”, this character may precede the “&”.

Numbers to be entered as parameters with UPM software may be entered in decimal, hexadecimal, octal, or binary. All numbers must be positive integers in the range 0-0FFFF (hexadecimal). This means the largest number that may be used is 65,535 decimal. Larger numbers, if entered, will be evaluated modulo 10000H. The suffix used with a number determines the number system to be used in evaluating it. Decimal numbers may use a D suffix or the suffix may be omitted, in which case decimal is assumed. Hexadecimal numbers use the suffix H and must begin with a digit. Octal numbers must use the suffix letters O or Q. Binary numbers are indicated with the suffix B. Leading zeros entered with any number are ignored, although a leading zero may be required in hexadecimal entries (e.g., FFH is not allowed as a number, but OFFH is a valid number).

The remainder of this section is devoted to a description of the Program, Program”, Transfer, Compare, Read and Exit commands.

4-4. Program Command

The Program (PRO) command requires three keywords: FROM, TO, and START. The general form of the command is as follows:

```
PROGRAM FROM lo address TO hi address START PROM address
```

The *lo address* specifies the starting logical word position where the data is stored. The *hi address* is the last logical word position containing this data. The *PROM address* is the starting location in the PROM where the data is to be placed. (See Appendix B for the effect of the use of an OFFSET address on this command.)

The keywords FROM, TO, and START must be used as indicated. These keywords function as a signal to UPM that the next number provides the starting, ending, or PROM addresses, respectively.

To save keystrokes—or to prevent a command line from exceeding either the 128-character display line limit or the 256-character command line limit—it is possible to enter the command using unique abbreviations of each command and keyword, providing the following alternate form for the Program command:

```
PRO FRO lo address TO hi address STA PROM address
```

4-5. Optional Keywords and Values

Besides the three required keywords associated with the Program command, any of four others may be included within the command line. These optional keywords are described briefly in this section; they are more fully explained in Appendix C.

The socket number may be specified using the general form:

```
SOCKET number
```

This is not necessary if the socket number previously has been specified by a separate SOCKET keyword on another command line preceding the Program command and need not be changed.

Similarly, the data sense of the memory-to-PROM transfer may be specified using the DATA keyword with the following general form:

DATA *sense*

Here, sense is a T if data is uncomplemented, and F if it is complemented.

An address offset may be specified using the OFFSET keyword with the following general form:

OFFSET *address*

If a previously specified offset is correct, the OFFSET keyword is not required. If, however, this offset must be altered for this Program command, it must be provided in the Program command line or in a preceding line of its own. Appendix B contains a detailed explanation of the OFFSET keyword and its usage.

Some of the flexibility of the UPM software lies in its ability to enable extensive data manipulation during programming operations. These functions are specified using Format commands during the programming process. If a format has been defined, the FORMAT keyword may be included in the Program command line to instruct UPM to use the format previously specified. In the Program command, this keyword stands alone, requiring no value associated with it. The Format command and concept are explained in Appendix C.

4-6. Examples

A minimum Program command requires the presence of starting and ending addresses in Inteltec memory where the data to be programmed into the PROM is stored and the starting PROM address where it is to be programmed.

Example 1

A PROM plugged into SOCKET 1 is to be programmed with 256 (decimal) bytes from logical word positions 0-255. Data is to be placed in the first 256 locations of the PROM. Enter the following command at the operator console:

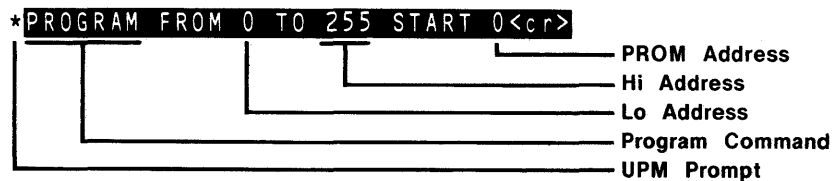

Example 2

Assuming the data in Example 1 is stored in Inteltec memory locations 7700H-77FFH, two methods could be used to cause the programming to occur. In the first instance, the exact Inteltec memory addresses could be used as follows (assuming OFFSET=0):

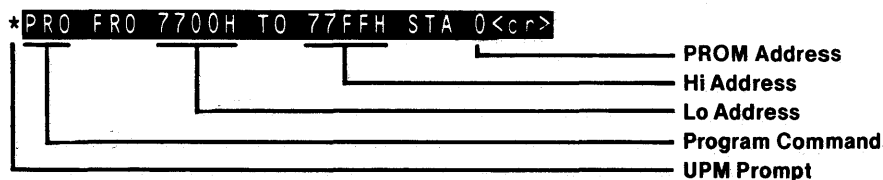

Alternatively, an offset of 7700H could be specified and the numbers 0 and 255 (decimal) used as the starting and ending Intellec memory addresses as follows:

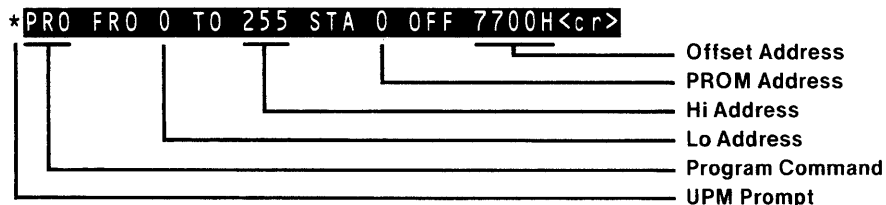

The OFFSET keyword may be specified on a separate line *before* the Program command as follows:

```
*OFFSET = 7700H<cr>
*PROGRAM FROM 0 to 255 START 0<cr>
```

This sequence would have the same effect as the second alternative shown above.

Example 3

If it is desired to place the data stored in logical word positions 0-255 into two PROM's installed in the two UPP front-panel sockets with no alteration of data, this may be accomplished by specifying the SOCKET option in the second of two Program commands as follows:

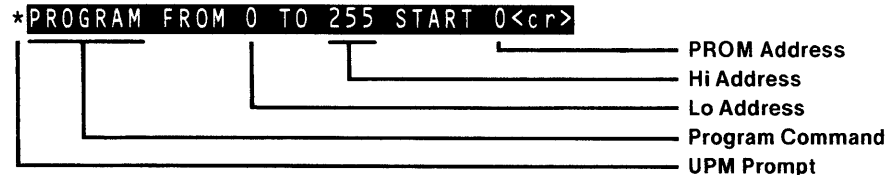

This command programs the first PROM (in the socket specified earlier by a SOCKET keyword on a separate line or the system default SOCKET 1). In this case, assume SOCKET 1 has been specified earlier. To place the same data in the PROM in SOCKET 2, enter the following command at the operator console:

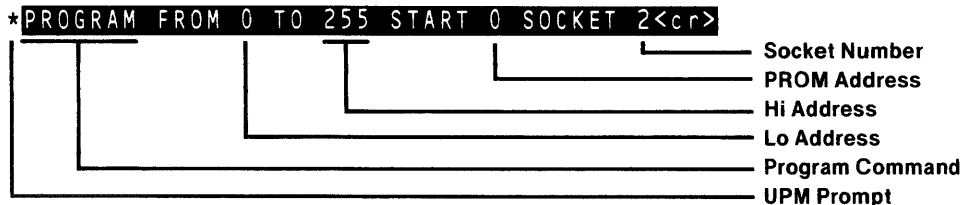

As with the OFFSET keyword in Example 2, it is possible to change the socket number by using a SOCKET keyword on a separate line *before* the Program command as follows:

```
*SOCKET=2<cr>
*PROGRAM FROM 0 to 255 START 0<cr>
```

4-7. Program " Command

This command is a variation of the Program command and enables the user to program a series of PROMs with the same data, format, offset address, and other parameters as the preceding Program command. Thus, to program several PROMs enter the full Program command with all keywords and values discussed above, program the first PROM, unplug the programmed PROM, substitute the unprogrammed PROM, then enter the Program " command.

NOTE

This command will not be accepted by UPM if any of the keywords or parameters have been changed since the last Program command was entered. The data contents of Intellec memory may, however, be altered between the first Program command and the Program " command by means of the Change command. (Refer to Appendix C.)

Example

Three PROMs are to be programmed with the contents of logical word positions 0-255 (decimal). Programming is to begin at PROM address 0. Enter the following commands at the operator console:

```
*PROGRAM FROM 0 TO 255 START 0<cr>
```

```
*PROGRAM "<cr>
```

```
*PROGRAM "<cr>
```

Removal of the programmed PROM and the insertion of the unprogrammed PROM must be accomplished between the above instructions.

4-8. Transfer Command

The Transfer command requires two keywords to specify the starting and ending logical word positions where data is to be stored (read) from the PROM. The minimum command has the following general form:

```
TRANSFER FROM lo address TO hi address
```

The command reads data from the PROM previously selected by a SOCKET keyword into the specified logical word positions. Reading begins at PROM address 0.

4-9. Optional Keywords and Values

Besides the two required keywords associated with the Transfer command, any of four other keywords may be included within the command line. These optional keywords are described briefly in this section; they are explained more fully in Appendix C.

The address of the first location in the selected PROM containing the data to be transferred can be specified using the general form:

```
START PROM address
```

The Transfer command fills the memory locations starting at *lo address* through *hi address*, inclusive, with PROM data starting at the location in the PROM specified by *PROM address*.

The socket number may be specified using the general form:

SOCKET *number*

This is not necessary if the socket number previously has been specified by a separate **SOCKET** keyword on another command line preceding the Transfer command and need not be changed.

Similarly, the data sense of the PROM-to-memory transfer may be specified using the **DATA** keyword with the following general form:

DATA *sense*

Here, sense is a T if data is uncomplemented, and F if it is complemented.

An address offset may be specified using the **OFFSET** keyword with the following general form:

OFFSET *address*

If a previously specified offset is correct, the **OFFSET** keyword is not required. If, however, this offset must be altered for this Transfer command, it must be provided in the Transfer command line or in a preceding line of its own.

Some of the flexibility of the UPM software lies in its ability to allow extensive data manipulation during transfer operations. These functions are specified using Format commands. If a format has been defined, the **FORMAT** keyword may be included in the Transfer command line to instruct UPM to use the format previously specified. In the Transfer command, this keyword stands alone and requires no associated value. The Format command and concept are explained in Appendix C.

4-10. Examples

Two examples of the use of the Transfer command are provided and described in this section.

Example 1

Data from a PROM that has been inserted into a previously defined UPP front panel socket is to be moved to logical word positions 0-255. Enter the following command at the operator console:

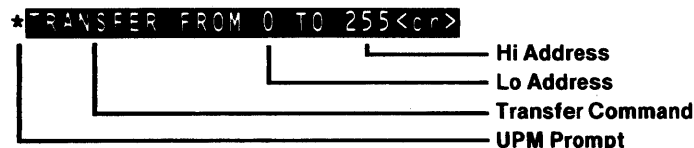

Example 2

In this example, the contents of two separate PROMs will be read into contiguous memory locations in the Intellec memory. This is often a requirement where the contents of two PROMs are to be moved into a single, larger PROM. Enter the following commands at the operator console:

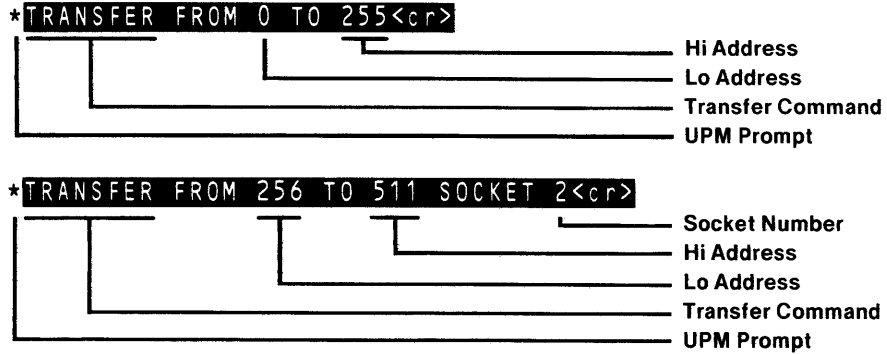

At the conclusion of the second transfer operation, the contents of the two PROMs will be stored in logical word positions 0-511 (decimal).

4-11. Compare Command

The Compare command requires two keywords to specify the starting and ending Intellec memory addresses where data to be compared with the PROM contents is stored. The general form of the command is as follows:

`COMPARE FROM lo address TO hi address`

This command reads data from the PROM, beginning at address 0, one byte at a time, and compares each byte with the contents of the corresponding logical word position. Comparison discrepancies are displayed on the operator console in the following format:

`# PROM address M= memory contents PROM= PROM contents`

4-12. Optional Keywords and Values

Besides the two required keywords associated with the Compare command, any of three others may be included within the command line. These optional keywords are described briefly in this section; they are explained more fully in Appendix C.

The socket number may be specified using the general form:

`SOCKET number`

This is not necessary if the correct socket number has been previously specified by a separate SOCKET keyword on another command line preceding the Compare command.

Similarly, the data sense of the compare operation may be specified using the DATA keyword with the following general form:

`DATA sense`

Here, sense is a T if data is uncomplemented, and F if it is complemented.

An address offset may be specified using the OFFSET keyword with the following general form:

OFFSET *address*

If a previously specified offset is correct, the OFFSET keyword is not required. If, however, this offset must be altered for this Compare command, it must be provided in the Compare command line or in a preceding line of its own.

The FORMAT keyword may be used after the *hi address* to cause the Compare command to be executed under the current Format as explained in section C-4.

Data read from the PROM may begin at a location other than address 0. The starting address for the PROM may be specified using the general form:

START *PROM address*

4-13. Examples

Two examples of the use of the Compare command in UPM are provided in this section.

Example 1

A PROM previously specified as being in SOCKET 1 contains programmed data which is to be compared with the contents of logical word positions 700H-8FFH. Enter the following command at the operator console:

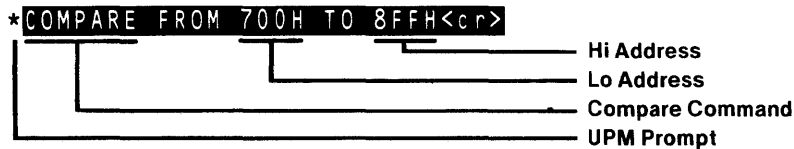

Example 2

Two types of PROM's have been used to store the same data (perhaps as a test of the reliability or usefulness of the two types in comparison with one another). To compare the contents of the PROM in SOCKET 1, assuming this socket has been previously specified, enter the following command at the operator console:

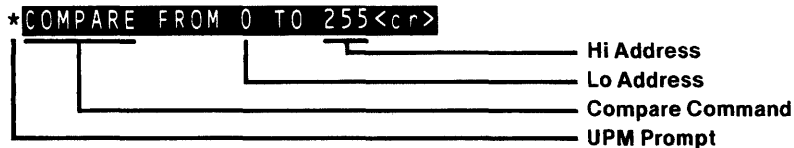

Assume the data in the second PROM—inserted in SOCKET 2—is complemented. To carry out a comparison of the same data as used in the above case with the contents of the second PROM, enter the following command at the operator console:

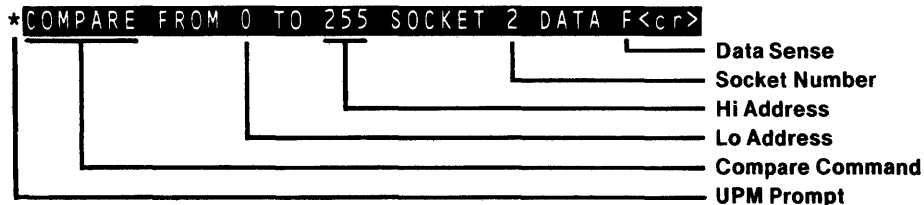

Example 3

A PROM previously specified as being in SOCKET 1 contains programmed data in locations 100H-1FFH which is to be compared with the contents of logical positions 600H-6FFH. Format control is also to be specified. Enter the following command at the operator console:

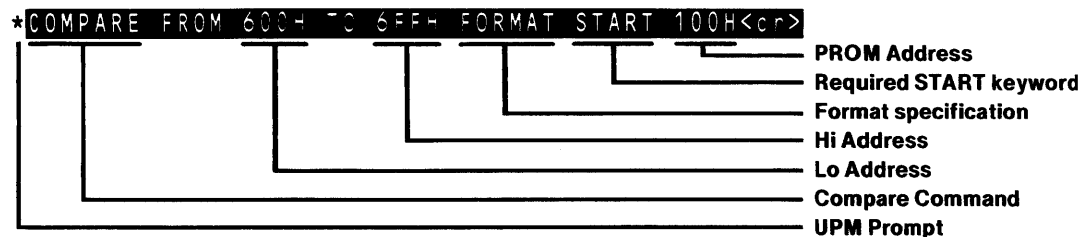
**4-14. COMPARE '' Command**

This command is a variation of the Compare command and enables the user to compare a series of PROMs with the same data, format, offset address, and other parameters as the preceding Compare command. To compare several PROMs, enter the full Compare command with all the appropriate keywords and values described in the Compare command. Compare the first PROM, unplug the compared PROM, plug in the next PROM to be compared, then enter the Compare '' command.

NOTE

This form of the Compare command cannot be used if the format or any of the parameters have been changed since the last Compare command. A new specification of the parameters for the Compare command is required.

Example

Three PROMs are to be compared with the contents of logical word positions 0-255 (decimal). Comparing is to begin at PROM address 200 (decimal). Enter the following commands at the operator console:

```
*COMPARE SOCKET 1 FROM 0 TO 255 START 200<cr>
```

```
*COMPARE<cr>
```

```
*COMPARE<cr>
```

Removal of the compared PROM and the insertion of the uncompiled PROM must be accomplished between the above commands.

4-15. Read Command

This command is used to read data from a diskette file into Intellec memory. The Read command has two forms. The general format for the first form is as follows:

```
READ file type FILE file name [INTO bias] [UNTIL stop address]
```

file name is an ISIS file name and can be :HR: for the high-speed tape reader. *file type* is a keyword specifying the format of the data in that file. Its value is HEX for HEX-ASCII format (default if keyword is omitted), 86HEX for 8086 HEX-ASCII format, BNPF for that format, or OBJECT for 8080 or 8086 object file format.

'INTO *bias*' is optional, as denoted by the enclosing brackets ([]).

Data is loaded into memory as specified by the load address information contained in the file. For BNPF format, which has no load address information, loading begins at 0. *bias* is a constant value which is simply added to each load address to form a new address where data is to be loaded. Of course, all addresses are modified by the value of the OFFSET keyword as described in Appendix B.

'UNTIL *stop address*' is only used with BNPF format (ignored otherwise). When the file load address equals the stop address, that logical word is the last one transferred.

When reading 8086 HEX-ASCII format, there are 20-bit load addresses in the file. This form of the command will cause reading from that file to halt when a load address value greater than 0FFFFH is read.

Besides the required keywords associated with the Read command, any of four others may be included within the command line. These optional keywords are described briefly in this section; they are explained more fully in Appendix C.

The data sense of the PROM-to-memory transfer may be specified using the DATA keyword with the following general form:

DATA *sense*

Here, *sense* is T if data is uncomplemented, and F if it is complemented.

An address offset may be specified using the OFFSET keyword with the following general form:

OFFSET *address*

If a previously specified offset is correct, the OFFSET keyword is not required. If, however, this offset must be altered for this command, it must be provided in the Read command line or in a preceding line of its own.

Some of the flexibility of the UPM software lies in its ability to allow extensive data manipulation during transfer operations. These functions are specified using Format commands. If a format has been defined, the FORMAT keyword may be included in the Read Command line to instruct UPM to use the format previously specified. In the Read command, this keyword stands alone and requires no associated value. The Format command and concept are explained in Appendix C.

The logical word length may be specified using the LOGICAL keyword with the following form:

LOGICAL *word length*

The logical command and concept are explained in Appendix C.

The general format of the second form of the Read command is as follows:

**READ *file type* FILE *file name* FROM *lo address* TO *hi address*
[START *load address*]**

In 86HEX and 8086 Object formats, there are 20-bit load addresses in the file. The above form of the Read command must be used to handle these 20-bit addresses correctly.

Data from the file is loaded into memory by taking each load address from the file minus the *load address*, then adding the *lo address*. This gives the logical word position of the data. This address value must be in the range of *lo address* to *hi address* inclusive or else the data is not loaded. The appropriate **OFFSET** specification is then added to this quantity to form an absolute system memory address. In effect, this reads (*hi address - lo address*) bytes from the file starting at *load address* and extending to *load address + (hi address - lo address)*, and loads these bytes into memory locations *offset address + lo address* through *offset address + hi address* inclusive.

Typically, a file may contain unused odd bytes distributed throughout the file. Therefore, the actual number of bytes contained in the range specified by **FROM lo address TO hi address** may be greater than the number of bytes read by the command. In this event, the following message will be displayed:

```
nnnnn BYTES READ FROM FILE
```

where:

nnnnn is a decimal value denoting the actual number of bytes contained in the specified range.

The data sense of the PROM-to-memory transfer may be specified using the **DATA** keyword with the following form:

```
DATA sense
```

Here, sense is a T if data is uncomplemented, and F if it is complemented.

An address offset may be specified using the **OFFSET** keyword with the following general form:

```
OFFSET offset address
```

If a previously specified offset is correct, the **OFFSET** keyword is not required. If, however, this offset must be altered for this command, it must be provided in the Read command line or in a preceding line of its own.

The logical word length may be specified using the **LOGICAL** keyword with the following form:

```
LOGICAL word length
```

The logical command and concept are explained in Appendix C.

4-16. Examples

Four examples of the use of the Read command in UPM are provided in this section.

Example 1

```
*READ HEX FILE FOO.HEX OFFSET 1000H INTO 0 LOGICAL 8<cr>
```

This command will read a file in hex format. Data will be placed in memory beginning at logical word 0, relative to an offset of 1000H. Data will be read from the file in groups of 8 bits, each group representing one logical word.

```
*READ BNPF FILE FOO.BIN OFFSET 1000H INTO 0 UNTIL FFH LOGICAL 4<cr>
```

This command will read 100H words of a file in BNPF format. Groups of 8 bits will be input and the lower 4 bits will be stored as a logical word.

```
*READ HEX FILE FOO.HEX FORMAT INTO 0<cr>
```

This command will read a file in hex format. The file will be read under format control, with the first logical words being stored in location 0 relative to their respective offsets.

```
*READ 86HEX FILE FOO.HEX FROM 0 TO 1000H START 1FFFFH<cr>
```

This command will read a file in 86 HEX format bytes corresponding to load addresses 1FFFFH through 20FFFH inclusive. These bytes will be read into logical word positions 0 through 1000H inclusive.

4-17. Exit Command

This command requires no parameters or keywords. It stands alone on a command line and returns control of the system from the UPM software to the ISIS-II operating system.

```
EXIT
```

4-18. Other Commands

The 18 valid UPM commands may be divided into five general categories: keyword/parameter commands, data input commands, data display/change commands, data output commands, and the Exit command.

Included within the keyword/parameter commands are Type, Data, Socket, Logical, Offset, and Format. Two types of data input commands are available—Read and Transfer. Data display/change commands consist of Display, Change, Compare, and Compare''. Data output commands include Program, Program'' and Write.

Those commands listed above which are not described in detail in this section are discussed in Appendix C.



This chapter describes the use of each of nine Intel Personality Modules (PMs) in conjunction with the UPP. The PROMs with which a PM is used are listed, the requirements for and use of special adapters are described, requirements for setting any of the switches that are part of the PM are provided, and a step-by-step procedure for using the PM is included.

5-1. General

The use of any PM with the UPP to program a specific PROM involves procedures that may be divided into three general categories: (1) selection of the PM, (2) preparation of the PM for use in the UPP, and (3) the programming process itself. The programming process is to some degree software-dependent, and Chapters 2 through 4 describe each of the three software systems available for programming PROMs.

Table 1-1 lists all Intel PROMs, identifies the PM that is used to program each type of PROM, and provides a cross-reference to the section within this chapter that describes that PM in more detail.

Preparation of the PM for use in the UPP varies with the type of PM being used. Part of this procedure, however, is installation of the PM in the UPP chassis; this procedure is largely standardized.

Each of the two sockets on the UPP front panel is wired directly to a PM card slot in the UPP chassis. Care must be taken to ensure that the PM is installed in the proper card slot so that it corresponds to the socket on the front panel where the PROM to be programmed will be inserted.



Failure to observe the above precaution may result in damage to the PROM, the PM, or both.

When the appropriate PM card is selected and all switch and adapter requirements pertinent to it have been accomplished, insert the PM into the chassis with the component side of the PCB facing the *front* of the UPP. Procedures for the proper installation of the PM are contained in paragraph 1-12.

5-2. UPP-361

The UPP-361 PM contains all logic required to program and read the contents of a 3601-type PROM. It requires no adapter and has no switch setting requirements.

5-3. Applicable PROMs

Three types of PROMs, which differ from one another only in access times, are programmed using the UPP-361. The 3601 and the 3601-1 are high-speed PROMs organized as 256, 4-bit words. The M3601 is the military version of the 3601 PROM family. Only these three 16-pin PROMs may be programmed with the UPP-361.

5-4. Programming

Following is the step-by-step procedure for programming a 3601-type PROM using the UPP-361 PM with the UPP system:

- a. Ensure UPP and Intellec system (or other controller) are properly configured and interconnected.

NOTE

Since 3601 PROMs are 16-pin devices, they must be installed in a 16-pin socket (SOCKET 1 of the UPP-501 socket adapter), and the UPP-361 is installed in card slot 1 of the UPP's chassis.

- b. Install UPP-361 in card slot corresponding to 16-pin socket (card slot 1).
- c. Apply power to Intellec and UPP.
- d. Load and call appropriate PROM programming software. (All three software systems have capability to program 3601-type PROMs.)
- e. Install 3601, 3601-1, or M3601 PROM in SOCKET 1.
- f. Execute appropriate software command to Program, Transfer, or Compare data.

NOTE

If Intellec Monitor software is used, socket option Y or Z must be used, depending on how data is stored in Intellec memory. All programming is in byte format.

5-5. UPP-816

The UPP-816 PM contains all logic required to program and read the contents of a 2716-type PROM. It contains one switch which must be properly set and requires the use of an adapter under some circumstances as described below.

5-6. Applicable PROMs

The 2716, 2758, and the 2758 S-1865 Intel PROMs may be programmed using the UPP-816 PM. The 2716 is an erasable PROM which features a memory organized into 2048, 8-bit bytes. The 2758 and the 2758 S-1865 PROMs are similar, except their memories are organized into 1024, 8-bit bytes. All three of these PROMs may be erased using ultraviolet (UV) light irradiation, and all three are supplied in 24-pin packages.

Erasement of the contents of any of these three types of PROMs may be accomplished using a UV source producing a wavelength of 2537 Angstroms. (Ultra-Violet Products, Inc., of San Gabriel, CA, manufactures a Model UV5 and a Model S-52 lamp which are examples of the types of UV sources which may be used.)

WARNING

High-intensity UV light can cause serious burns. UV radiation also may generate potentially hazardous amounts of ozone. Observe the following precautions when using UV light to erase a PROM:

- a. Never expose skin or eyes directly to source.
- b. Do not stare at PROM under UV illumination; light source is injurious to eye tissue.
- c. Use only in well-ventilated area.

Any UV lamp should be used without shortwave filters. An exposure of 15 to 20 minutes at a distance of one inch will completely erase the EPROM.



Avoid unnecessary or prolonged exposures of EPROM devices to UV light. Such exposure is potentially damaging to the EPROM.

5-7. Adapter Requirements

If the 2758 S-1865 PROM is being programmed, the UPP-555 adapter must be installed. This adapter also may be used (optionally) with the 2758 PROM.

The UPP-555 consists of two components joined on a single adapter card—a 24-pin socket used to program the PROMs and a 16-pin jumper block used to connect signals from the PM to the 24-pin socket.

The procedure for installing and using the UPP-555 adapter is as follows:

- a. Insert 16-pin jumper block into UPP-555 adapter program socket marked for type of PROM to be programmed.
- b. If 2758 is being programmed, install two-pin shorting plug into contacts labeled "S" on left of 2758 label on UPP-555.
- c. If 2758 S-1865 PROM is being programmed, remove two-pin shorting plug from contacts labeled "S" to left of 2758 label on UPP-555.

NOTE

For all other PROMs using UPP-555, the two-pin shorting plug installation is immaterial.

5-8. Switch Setting

On-board switch S1 is used to reset address boundaries for the UPP-816 PM. Normally, the upper address boundary is set at 2047, the highest address in the 2716 PROM. When programming the 2758 or the 2758 S-1865, all addresses must be between 0 and 1023 (decimal), inclusive. Resetting the upper address boundary involves selecting proper settings for the four switch positions on S1 as follows:



If the upper boundary is not changed to 1023 when a 2758 or 2758 S-1865 PROM is being programmed, no boundary error will be issued by the PROM programming software and certain addresses in the PROM may be overwritten with erroneous data.

- a. Set switch position S1-1 to ON (to right position).
- b. Set switch positions S1-2 through S1-4 to OFF (to left position).

For an upper address boundary of 2047, all four switch positions of S1 are set to OFF (to left position).

5-9. Programming

The step-by-step procedure for programming a 2716-type PROM with the UPP-816 PM and UPP is as follows:

- a. Ensure UPP and Intellec system are properly configured and interconnected.
- b. Ensure switch S1 is properly set for upper address boundary (paragraph 5-8).
- c. Install UPP-816 PM in UPP chassis. Ensure that UPP card slot chosen is connected to 24-pin socket.
- d. If 2758 S-1865 is being programmed, install UPP-555 adapter and ensure two-pin shorting plug is *removed* (paragraph 5-7).
- e. If 2758 is being programmed and UPP-555 is installed, ensure two-pin shorting plug is *installed* (paragraph 5-7).

NOTE

Use of the UPP-555 Adapter with 2758 PROMs is optional, but if used, it must include the two-pin shorting plug described above.

- f. Turn on Intellec and UPP power.
- g. Load and call appropriate PROM programming software. (All three software systems have capability to program 2716-type PROMs.)
- h. Install 2758, 2758 S-1865, or 2716 PROM in 24-pin socket connected to UPP-816 PM.
- i. Execute appropriate software command to Program, Transfer, or Compare data.

5-10. UPP-832

The UPP-832 contains all logic required to program Intel 2732 PROM's and to read the contents of these devices. It has no on-board switches and requires no adapter. The UPP-832 has been replaced by the UPP-833; the following paragraphs are given for information only.

5-11. Applicable PROMs

Only the Intel 2732 PROM may be programmed using UPP-832.

5-12. Programming

The step-by-step procedure for programming a 2732 PROM using the UPP-832 PM with the UPP is as follows:

- a. Ensure UPP and Intellec systems are properly configured and interconnected.
- b. Install UPP-832 PM in UPP chassis card slot 2. Note that UPP-832 can be installed in card slot 1 (assuming that SOCKET 1 has a 24-pin socket) as follows:
 1. On UPP-832 PM, remove jumper between pads 3 and 4 (located directly above pins 15 and 17 on edge connector).
 2. On UPP-832 PM, install a jumper between pads 4 and 5.

NOTE

This procedure must be reversed if PM later must be installed in slot 2.

- c. Turn on Intellec and UPP power.
- d. Load and call appropriate PROM programming software. (All three software systems have capability to program 2732 PROM.)
- e. Install 2732 PROM in 24-pin socket corresponding to UPP-832 PM card slot installation.
- f. Execute appropriate software command to Program, Transfer, or Compare data.

5-13. UPP-848

The UPP-848 PM contains all logic required to program or read the contents of the Erasable PROM located in an 8748 or 8749 Microprocessor or in an 8741A or 8742 Universal Peripheral Interface. See below for adapters required.

5-14. Applicable PROMs

Both the 1024, 8-bit words of Erasable PROM (EPROM) memory in the 8748 Microprocessor or 8741A Universal Peripheral Interface and the 2048 8-bit words of EPROM memory in the 8749 microprocessor or 8742 Universal Peripheral Interface may be programmed using the UPP-848.

Erasure of the contents of the EPROM contained in the 8748/8741A/8749/8742 may be accomplished using a UV source producing a wavelength of 2537 Angstroms.

WARNING

High-intensity UV light can cause serious burns. UV radiation also may generate potentially hazardous amounts of ozone. Observe the following precautions when using UV light to erase a PROM:

- a. Never expose skin or eyes directly to source.
- b. Do not stare at device under UV illumination; light source is injurious to eye tissue.
- c. Use only in well-ventilated area.

Any UV lamp should be used without shortwave filters. An exposure of 15 to 20 minutes at a distance of one inch will completely erase the EPROM.

CAUTION

Avoid unnecessary or prolonged exposures of EPROM devices to UV light. Such exposure is potentially damaging to the EPROM.

5-15. Adapter Requirement

Since the 8748/8741A/8749/8742 are 40-pin devices, an adapter must be used to enable the UPP front-panel socket(s) to accommodate the chip during programming of its 1k or 2k of EPROM. This adapter is installed in a 24-pin socket. The 8748/8741A requires the adapter supplied with the PM; the 8749/8742 requires the UPP-549 adapter.

5-16. Programming

The step-by-step procedure for programming the EPROM locations in the 8748/8741A/8749/8742 using the UPP-848 PM and the UPP is as follows:

- a. Ensure UPP and Intellec systems are properly configured and interconnected.
- b. Install UPP-848 PM in UPP chassis. Ensure the UPP card slot chosen is connected to 24-pin socket. Set the onboard switches (S1-1 through S1-4) as shown in table 5-1.
- c. Install 40-pin adapter in 24-pin socket corresponding to installation location of UPP-848. Refer to table 1-2 for the correct adapter.
- d. Turn on Intellec and UPP power.
- e. Load and call appropriate PROM programming software. (All three software systems can program EPROM in 8748/8741A/8749/8742.)
- f. Install 8748/8741A/8749/8742 in 40-pin socket corresponding to UPP-848 installation location.
- g. Execute appropriate software command to Program, Transfer, or Compare data.

Table 5-1. UPP-848 Switch Settings

Switch/ Designator	Memory Words (Type)	
	(8748/8741A) 1k	(8749/8742) 2k
S1-1	X	X
S1-2	X	X
S1-3	ON	OFF
S1-4	ON	ON

Note: X = Don't Care, ON = switch closed, OFF = switch open.

5-17. UPP-855 and UPP-955

The UPP-855 PM contains all logic required for programming and reading the contents of the EPROM memory in the Intel 8755 microprocessor. It is equipped with a socket adapter to enable the UPP to accommodate its 40-pin package. The UPP-955 PM is identical to the UPP-855 except that it includes a slightly different adapter which enables the user to program and read the contents of the EPROM memory in the Intel 8755A microprocessor. Since these two devices are identical in operation, they are discussed together in this manual.

NOTE

Users who have been programming the 8755's EPROM memory with the UPP-855 and who wish to upgrade to the UPP-955 need only the special adapter for the 8755A. Contact Intel for ordering information.

5-18. Applicable PROMs

The UPP-855 may be used only to program the 16k of EPROM memory contained in the Intel 8755 chip. Similarly, the UPP-955 may be used only to program the 16k of EPROM memory contained in the Intel 8755A chip.

Erasure of the contents of the EPROM contained in either of these chips may be accomplished using a UV source producing a wavelength of 2537 Angstroms.

WARNING

High-intensity UV light can cause serious burns. UV radiation also may generate potentially hazardous amounts of ozone. Observe the following precautions when using UV light to erase a PROM:

- a. Never expose skin or eyes directly to source.
- b. Do not stare at device under UV illumination; light source is injurious to eye tissue.
- c. Use only in well-ventilated area.

Any UV lamp should be used without shortwave filters. An exposure of 15 to 20 minutes at a distance of one inch will completely erase the EPROM.

CAUTION

Avoid unnecessary or prolonged exposures of EPROM devices to UV light. Such exposure is potentially damaging to the EPROM.

5-19. Adapter Requirement

Both the UPP-855 and the UPP-955 PMs require the use of a socket adapter which expands the standard 24-pin UPP socket to 40 pins to accommodate the chip.

NOTE

The UPP-UP1 adapter is used with the 8755 and the UPP-UP2 adapter is used with the 8755A. Each adapter is marked with the appropriate chip number for identification of the chip with which it is to be used.

5-20. Programming

The step-by-step procedure for using the UPP-855 or the UPP-955 to program the EPROM memory in the Intel 8755 or 8755A is as follows:

- a. Ensure UPP and Intellec systems are properly configured and interconnected.
- b. Install UPP-855 or UPP-955 PM in UPP chassis. Ensure that UPP card slot chosen is connected to 24-pin socket.
- c. Install 40-pin adapter appropriate to PM and microprocessor in 24-pin socket corresponding to location of PM board.
- d. Turn on Intellec and UPP power.
- e. Load and call appropriate PROM programming software. (All three software systems can program EPROM in 8755 or 8755A.)
- f. Install 8755 or 8755A in 40-pin socket corresponding to UPP-855 or UPP-955 installation location.
- g. Execute appropriate software command to Program, Transfer, or Compare data.

5-21. UPP-865

The UPP-865 PM contains all logic required for programming and reading data from most bipolar PROMs manufactured by Intel Corporation. Depending on the PROM being used, it may require one of several adapters. It contains one on-board switch which is used to set the PROM address boundary. The UPP-865 is a direct replacement for the UPP-864, which is no longer in use.

5-22. Applicable PROMs

Table 5-2 summarizes the PROMs which may be programmed using the UPP-865 PM. All Intel bipolar PROMs, with the exception of the 3601, may be used with the UPP-865.

5-23. Adapter Requirements

All but two of the PROMs which may be used with the UPP-865 require an adapter with the UPP. Table 5-2 describes which adapter is used for each PROM. In general, 16-pin PROMs require a UPP-562 adapter, 18-pin PROMs require a UPP-562, and 24-pin PROMs require a UPP-555. The UPP-555 already has been described in detail (paragraph 5-7).

The other adapters are single-socket devices which enable the UPP to accept a PROM with 16 or 18 pins. They are not described in this manual.

5-24. Switch Settings

Switch S1 on the UPP-865 PM must be set for the proper PROM address boundary for the type of PROM being used. Four different PROM word capacities are used with the PROMs for which the UPP-865 is valid. These capacities and their respective switch settings are summarized in table 5-3. In all cases, ON means the switch is placed in its right-most position and OFF means it is placed in its left-most position.

Table 5-2. UPP-865 Device Selection

PROM	Pins	No. of Bits	Organization	Maximum Access Time (ns)	Adapter
3602, 3602A	16	2048	512x4	70	UPP-562
3604, 3604A	24	4096	512x8	70	Not Required
3604L-6, 3604AL	24	4096	512x8	90	UPP-555
3605	18	4096	1024x8	70	UPP-565
3608	24	8192	1024x8	80	UPP-555
3621	16	1024	256x4	70	UPP-562
3622, 3622A	16	2048	512x4	70	UPP-562
3624, 3624A	24	4096	512x8	70	Not Required
3625	18	4096	1024x4	70	UPP-565
3628	24	8192	1024x8	80	UPP-555
3636	24	16,384	2048x8	80	UPP-555

Table 5-3. UPP-865 Switch Settings

Switch Position	PROM Word			
	256	512	1024	2048
1	ON	ON	ON	ON
2	ON	ON	ON	ON
3	OFF	ON	ON	ON
4	ON	OFF	OFF	OFF
5	OFF	OFF	ON	ON
6	ON	ON	OFF	OFF
7	OFF	OFF	OFF	ON
8	ON	ON	ON	OFF

5-25. Programming

The step-by-step procedure for programming Intel bipolar PROMs with the UPP-865 PM and the UPP is as follows:

- a. Ensure UPP and Intellec systems are properly configured and interconnected.
- b. Determine word capacity of PROM being used from table 5-2. From table 5-3, determine proper switch S1 settings and ensure switch S1 is properly configured for PROM in use.
- c. Install UPP-865 in UPP chassis. Ensure that UPP card slot chosen is connected to 24-pin socket.
- d. Determine from table 5-2 if adapter is required with PROM in use. If adapter is required, insert appropriate adapter device into socket corresponding to UPP-865 installation location.
- e. Turn on Intellec and UPP power.
- f. Load and call appropriate PROM programming software. (All three software systems can program PROMs which use UPP-865 PM.)
- g. Install PROM in appropriate socket or adapter which is connected to UPP-865.
- h. Execute appropriate software command to Program, Transfer, or Compare data.

5-26. UPP-872

The UPP-872 PM contains all logic required to program and read the contents of a 1702A-type PROM. Since all PROMs which may be used with UPP-872 are 24-pin devices organized as 256, 8-bit words, no adapters or switch settings are involved in the use of the personality module.

5-27. Applicable PROMs

All 1702A-type erasable PROMs may be used with the UPP-872. These include: 1602A, 1702A, 1702A-2, 1702A-6, 1702AL, 1702AL-2, 4702A, 8702A-4, and 8702A. The only difference between these PROMs is access time.

Erasure of the contents of any of the above PROMs may be accomplished using a UV source producing a wave length of 2537 Angstroms.

WARNING

High-intensity UV light can cause serious burns. UV radiation also may generate potentially hazardous amounts of ozone. Observe the following precautions when using UV light to erase a PROM:

- a. Never expose skin or eyes directly to source.
- b. Do not stare at device under UV illumination; light source is injurious to eye tissues.
- c. Use only in well-ventilated area.

Any UV lamp should be used without shortwave filters. An exposure of 15 to 20 minutes at a distance of one inch will completely erase the EPROM.

CAUTION

Avoid unnecessary or prolonged exposures of EPROM devices to UV light. Such exposure is potentially damaging to the EPROM.

5-28. Programming

The step-by-step procedure for programming a 1702A-type PROM with the UPP-872 PM and UPP is as follows:

- a. Ensure UPP and Intellec systems are properly configured and interconnected.
- b. Install UPP-872 in UPP chassis. Ensure that UPP card slot chosen is connected to 24-pin socket.
- c. Turn on Intellec and UPP power.
- d. Load and call appropriate PROM programming software. (All three software systems can program 1702A-type PROMs.)
- e. Insert PROM to be programmed into socket corresponding to UPP-872 installation location.
- f. Execute appropriate software command to Program, Transfer, or Compare data.

5-29. UPP-878

The UPP-878 contains all logic required to program or read data from an Intel 2708 or 2704 erasable PROMs. Because of the difference in word capacities between these two PROM types, an on-board switch must be set for boundary definition and control. No socket adapters are required.

5-30. Applicable PROMs

Both the 2708 and 2704 type PROMs may be programmed using the UPP-878. These types include the 2704, 2704-5, 2708, 8704, 8704-4, 8708, 8708-4, and 8708-5. All are erasable PROMs (EPROMs) and are functionally identical. The key difference between the 04 and 08 types is that the 08-types contain 1024 8-bit words and the 04-types contain 512 8-bit words. They also differ in access times.

Erasure of the contents of either of these PROMs may be accomplished using a UV source producing a wave length of 2537 Angstroms.

WARNING

High-intensity UV light can cause serious burns. UV radiation also may generate potentially hazardous amounts of ozone. Observe the following precautions when using UV light to erase a PROM:

- a. Never expose skin or eyes directly to source.
- b. Do not stare at PROM under UV illumination; light source is injurious to eye tissue.
- c. Use only in well-ventilated area.

Any UV lamp should be used without shortwave filters. An exposure to 15 to 20 minutes at a distance of one inch will completely erase the EPROM.

CAUTION

Avoid unnecessary or prolonged exposures of EPROM devices to UV light. Such exposure is potentially damaging to the EPROM.

5-31. Switch Settings

Switch S1 sets the address boundary for the upper address of the PROM being programmed. For the 2708, all three switch positions on S1 should be in the OFF (left-most) position. For the 2704, switch position 1 is placed ON (right-most position) and switch positions 2 and 3 are placed OFF. Switch positions 2 and 3 are used only for testing purposes; the user need be concerned only with switch position 1.

5-32. Programming

The step-by-step procedure for programming an Intel 2704 or 2708 EPROM using UPP-878 and the UPP is as follows:

- a. Ensure UPP and Intellec systems are properly configured and interconnected.
- b. Ensure switch position S1 is set for PROM being programmed (paragraph 5-31).
- c. Install UPP-878 in UPP chassis. Ensure that UPP card slot chosen is connected to 24-pin socket.
- d. Turn on Intellec and UPP power.
- e. Load and call appropriate PROM programming software. (All three software systems can program 2708 and 2704 EPROMs.)
- f. Insert PROM in socket corresponding to UPP-878 PM installation location.
- g. Execute appropriate software command to Program, Transfer, or Compare data.

5-33. UPP-820

The UPP-820 contains all logic required to program or read data from the EPROM portion of an Intel 2920 Signal Processor. The UPP-820 includes an adapter which allows the UPP to accommodate the 2920's 28-pin package. There are no on-board switches on the UPP-820 Personality Module.

5-34. Applicable PROMs

Only the EPROM portion of a 2920 Signal Processor may be programmed with the UPP-820 Personality Module. The EPROM portion is normally organized as 192 x 4-bit memory.

Erasure of the contents of the 2920 EPROM may be accomplished by using a UV source producing a wavelength of 2537 Angstroms.

WARNING

High-intensity UV light can cause serious burns. UV radiation also may generate potentially hazardous amounts of ozone. Observe the following precautions when using UV light to erase a PROM:

- a. Never expose skin or eyes directly to source.
- b. Do not stare at device under UV illumination; light source is injurious to eye tissues.
- c. Use only in well-ventilated area.

Any UV lamp should be used without shortwave filters. An exposure of 15 to 20 minutes at a distance of one inch will completely erase the EPROM.

CAUTION

Avoid unnecessary or prolonged exposures of EPROM devices to UV light. Such exposure is potentially damaging to the EPROM.

5-35. Adapter Requirements

The 2920 Signal Processor is a 28-pin device that requires the use of a 24-pin to 28-pin adapter (provided with the UPP-820 Personality Module). This adapter plugs into the front panel 24-pin socket of the UPP.

5-36. Programming

The 2920 Signal Processor has an internal program counter that is incremented on instruction cycle for every four master clock cycles and continues to increment until it reaches a count of 191 or is reset to location zero by an EOP or RST input signal. Instructions are executed sequentially and no program jumps are provided (except EOT). Therefore, the 2920 must always be reset initially and will always start at location zero during a read or write operation.

The COMPARE or TRANSFER commands of programming software (UPM, PPROM, or Monitor) will execute normally when programming the EPROM portion of the 2920 Signal Processor. However, the PROGRAM command will only program properly if programming is started at location zero. If programming is to start at any other location, additional steps must be taken as described in paragraph 5-37. Also, the Monitor COMPARE command is only partially functioning properly. This is because the Monitor will perform a second compare if the EPROM content does not compare with Intellec memory. Since the 2920 does not have direct address lines and requires a clock to increment internal memory addresses, the second compare from the Monitor will cause the UPP-820 firmware to generate another clock pulse. This will increment to the next (undesired) location and compare that locations contents rather than the previous one. When this occurs, the address of the Intellec memory is offset from the EPROM memory. Therefore caution should be used when comparing in that comparing will only indicate if PROM data is equal to or not equal to Intellec memory. If the data is not equal, the information normally printed by the monitor (i.e., MDS Mem Loc, MDS Mem Cont, PROM Content) is not valid.

The following steps describe programming the 2920 starting at location zero:

- a. Ensure that UPP and Intellec system are properly configured and interconnected.
- b. Install UPP-820 Personality Module in UPP chassis. Ensure that UPP card slot chosen is connected to front panel 24-pin socket.
- c. Insert adapter supplied with UPP-820 into corresponding 24-pin socket on front panel of UPP.
- d. Apply power to Intellec system and UPP.
- e. Load and call appropriate PROM programming software. (All three software systems can program the 2920.)

NOTE

When using UPM to program, read, or compare a 2920, the UPM (depending on the program revision level) may not recognize a typed entry of "2920". If this occurs (the UPM will repeat the "TYPE" message), enter "2716" or "1702A" as the PROM type.

- f. Install 2920 Signal Processor in the 28-pin adapter.
- g. Execute appropriate software command to Program, Transfer, or Compare data.

5-37. Programming At Location Other Than Zero. The following steps describe programming a "blank" 2920 EPROM starting at a location other than zero (for example, 10H):

NOTE

A "blank" 2920 EPROM contains all one's.

- a. Perform steps a through f of paragraph 5-36.
- b. Using TRANSFER command, transfer contents of the "blank" 2920 EPROM into Intellec memory. (Be sure that "blank" 2920 is inserted into UPP front panel socket. Otherwise all zero's will be transferred.)
- c. Load desired program into Intellec memory starting at logical word position 10H. (Refer to Appendix B.)
- d. Execute software PROGRAM command with a starting location of zero.

This procedure will start the programming at location zero, but the first 10H locations will not be programmed the Intellec memory will have these locations as all one's.

5-38. Programming Partially Programmed 2920. The following steps describe programming a partially programmed 2920. For example, assume that a 2920 is programmed at locations 00H through 20H and 100H through 200H and additional programming is required at locations 40H through 90H:

- a. Perform steps a through f of paragraph 5-36.
- b. Transfer contents of partially programmed 2920 into Intellec memory.
- c. Load desired program into Intellec memory at logical word positions 40H through 90H. (Refer to Appendix B.)
- d. Execute PROGRAM command with a starting location of zero.

This procedure will start the program at location zero; however, only locations 40H through 90H will be programmed. The other locations will only be compared during the program sequence.

5-39. UPP-833

The UPP-833 PM, which replaces the UPP-832, programs and reads the contents of Intel 2732, 2732A, and 2764 EPROMs. It also programs and reads the contents of the EPROM of an 8751, and reads the contents of an 8051 (ROM version). It has one on-board switch and requires no adapter for the 2732/32A. The 2764 requires the UPP-564 adapter and the 8051/8751 requires the UPP-551 adapter.

5-40. Applicable PROMs

Intel 2732, 2732A and 2764 EPROMs are programmed using the UPP-833, as is the EPROM of the 8751. Erasure of the contents of the EPROM may be accomplished by using a UV source producing a wavelength of 2537 Angstroms; erased 2732, 2732A, 2764 and 8751 EPROMs contain all one's.

WARNING

High-intensity UV light can cause serious burns. UV radiation also may generate potentially hazardous amounts of ozone. Observe the following precautions when using UV light to erase a PROM:

- a. Never expose skin or eyes directly to source.
- b. Do not stare at device under UV illumination; light source is injurious to eye tissues.
- c. Use only in well-ventilated area.

Any UV lamp should be used without shortwave filters. An exposure of 15 to 20 minutes at a distance of one inch will completely erase the EPROM.

CAUTION

Avoid unnecessary or prolonged exposures of EPROM devices to UV light. Such exposure is potentially damaging to the EPROM.

5-41. Adapter Requirements

The 2732 and 2732A EPROMs require no adapter. The 2764 requires the UPP-564 adapter. The 8051/8751 requires the UPP-551 adapter.

5-42. Switch Settings

Switch S1 on the UPP-833 PM selects the type of PROM to be programmed. The switch configurations are shown in table 5-4 (X's denote don't care):

Table 5-4. UPP-833 Switch Settings

Switch S1 Pins	EPROMs			
	2732	2732A	2764	8051/8751
1-8	Open	Open	Closed	Closed
2-7	Open	Closed	Open	Open
3-6	X	X	X	X
4-5	X	X	X	X

5-43. Programming

The step-by-step procedure for programming a PROM using the UPP-833 PM with the UPP is as follows:

- a. Ensure that UPP and Intellec system are properly configured and interconnected.
- b. Set switch S1 on UPP-833 for type of PROM being programmed (paragraph 5-42).

CAUTION

Incorrect setting of switch S1 may damage a PROM when programmed.

- c. The UPP-833 PM must be installed in a UPP chassis card slot that has a corresponding 24-pin socket. Before installing the UPP-833, connect the shorting plug on the card as follows:
 1. If card slot 1 is to be used, install shorting plug between E2 and E3. (E1, E2, and E3 are located at the top of the board on the left.)
 2. If card slot 2 is to be used, install shorting plug between E1 and E2.
- d. Install UPP-833 PM in UPP chassis as described in paragraph 1-13.
- e. Turn on Intellec system and UPP power.
- f. Load and call appropriate PROM programming software. (All three software systems have capability to program 2732/2732A/8751 EPROM. Only UPM can program a 2764 EPROM.)
- g. Install adapter into 24-pin socket, if applicable. Install PROM in 24-pin socket corresponding to UPP-833 PM card slot installation.
- h. Execute appropriate software command to Program, Transfer, or Compare data.

CAUTION

Do not attempt to program the code memory of an 8051 (ROM version). This can damage the part.



APPENDIX A ERROR CODES AND CONDITIONS

This appendix contains information on error codes and conditions that may arise during the use of UPP. Most of the error messages listed in this appendix occur when UPP is being used with UPM software, since it is this software system that incorporates the most self-explanatory error messages. When using Monitor software, the presence of an error is indicated by an asterisk (*). Some information regarding interpretation of this error condition is provided below, but the user must analyze the context in which the error occurred to diagnose the problem completely. Similarly, with PPRM, an error condition is indicated with a number sign (#) and requires the user to interpret the error within the context of the command being executed.

ERROR MESSAGE/CODE	MEANING/CAUSE	SUGGESTED RECOVERY
BAD BNPf DATA	Error has occurred in reading BNPf-coded file or paper tape. Byte containing error is discarded; input stops.	Data in error. Correct file and restart.
BAD HEX DATA	Same as BAD BNPf DATA, with Hex file or paper tape.	Data in error. Correct file and restart.
BAD OBJECT DATA	Same as BAD BNPf DATA, with 8080 absolute file.	Data in error. Correct file and restart.
BAD LOGICAL WORD SIZE	Logical word size supplied is less than one or greater than eight.	Check current Logical and Format conditions. Correct and restart.
BAD COMPOUND WORD SIZE	Sum of all logical word lengths in Format exceeds eight.	Display current format and correct as necessary.
CANNOT REDO PROGRAM	Follows Program " command which cannot be carried out, probably because parameter has been changed since last Program command.	Enter complete Program command line.
COMPARE ERROR (symbol varies with software)	During Program or Compare operation, UPP detects discrepancy between data in PROM and data in Intellect memory. In UPM, number sign (#) indicates presence of error. (See paragraphs 2-8, 3-7, and 4-11.)	Correct data as appropriate
DATA EXCEEDS MEMORY	File will not fit in available memory.	

ERROR MESSAGE/CODE	MEANING/CAUSE	SUGGESTED RECOVERY
INVALID PROGRAMMING LIMITS	Address constraints for 2704-related PROM have been violated.	Correct address limits and restart.
KEYWORD ERROR	Keyword has been spelled incorrectly or used in command where it is not valid.	Reenter keyword or command line.
LINE TOO LONG	Display line exceeds 128 characters or command line exceeds 256 characters.	Reenter line, using three-letter abbreviations to shorten length or continuation character (&) if display line length is exceeded.
LOGICAL WORD TOO LONG	Logical word length greater than physical word length (8 bits).	Correct logical word length.
MEMORY LIMITS WRONG	Logical word parameter for 2708-type PROM is not divisible by 512 or 1024 as required.	Correct and restart.
MISSING PARAMETER	Required parameter missing from command.	Reenter command line with parameter.
NO FORMAT	FORMAT keyword included in command but FORMAT has not been defined.	Create FORMAT before command line or delete FORMAT reference in command line. Reenter command.
NO PROM PROGRAMMER	UPP is not connected or turned on.	Reconnect UPP and ensure it is on. If error occurs after Program command, Program " may be entered rather than reentering command line.
START NOT 0	PROM address of other than zero has been specified for 2708-type PROM.	Reenter line with PROM start address = 0.
STORE FAILS	Change, Transfer, or Read command has failed to store data into logical word. If error occurs during Change command, UPM indicates where error arose. Execution halts.	Use Display to determine where failure occurred. Correct and restart.
SYNTAX ERROR	Incorrect character has been detected in command line.	Reenter command line and restart.

ERROR MESSAGE/CODE	MEANING/CAUSE	SUGGESTED RECOVERY
TOO MANY FIELDS	Format command has been entered with more than eight fields.	No action. UPM executes using first eight fields.
UPP BOARD SENSE ERROR	Indicates that a personality card was not present when the Control Board tried to access it.	Inspect hardware for missing personality card.
UPP NOT RESPONDING	Hardware failure or UPP not connected.	Recheck configuration.
UPP ERROR—STATUS 01	UPP busy.	Remove PROM, press UPP RESET, and try again.
UPP ERROR—STATUS 02	This message should never be issued.	None.
UPP ERROR—STATUS 04 or UPP ERROR—STATUS 08 or UPP PROGRAMMING ERROR	Program operation failed; PROM did not program.	Insure all cables are securely connected and then retry. If error occurs again, PROM is bad or not properly erased.
UPP ERROR—STATUS 10 or UPP ADDRESS ERROR	PROM Address is out of bounds.	User either is attempting to access non-existent PROM address or address-limit option switches on PM are incorrectly set.
UPP ERROR—STATUS 20 or UPP HARDWARE ERROR	UPP has detected a hardware failure.	Insure all cables are securely connected. Insure PM is properly installed.
UPP ERROR—STATUS 40	PM not present.	Insure that PM is installed in proper slot. User may be attempting to use wrong socket; check SOCKET command.
UPP ERROR—STATUS 80 or PROM UPSIDE DOWN	PROM or socket installed upside down.	Verify correct orientation.
WRONG LOGICAL LENGTH	Logical word length in Program command not same as PROM word length. Command not executed.	Correct logical word and restart.
RESERVED MEMORY VIOALTION	Attempting to modify ISIS, UPM code itself, or Monitor.	User may not alter these areas of memory.

ERROR MESSAGE/CODE	MEANING/CAUSE	SUGGESTED RECOVERY
nn UNSATISFIED EXTERNAL REFERENCES	Object file just read has nn missing addresses in it.	If the user knows that the code containing the missing addresses will not be executed, there will be no problem. Otherwise, the missing information must be LINKED in.

NOTE:

All non-fatal errors returned by ISIS are decoded, and sometimes an information message is issued. These errors can occur only in response to a READ or WRITE command.



APPENDIX B UPM MEMORY ADDRESSING TECHNIQUE

In using the UPM, it is important to understand the terms *physical word*, *offset*, and *logical word position*. In all descriptions of UPM commands, the term “Intellec memory address” is used. This is not strictly correct because these addresses are actually logical word positions as described in paragraph B-3.

B-1. Physical Word

A *physical word* is an 8-bit word on paper tape or in an ISIS file. During input from paper tape or an ISIS file, the UPM breaks up the incoming stream of bits into 8-bit words. During output, the UPM constructs 8-bit physical words from logical words—padding them with zeros in the high-order bit positions if the logical words are shorter than eight bits.

B-2. Offset

When a set of data is placed in Intellec memory (by reading from a paper tape or an ISIS file or transferring from a PROM), the UPM needs to know what *offset* to use. The offset is an absolute Intellec memory address, and it is the location of the beginning of the memory area where data is to be stored.

In some cases, two or more different sets of data may be placed in memory at different offsets as shown in figure B-1.

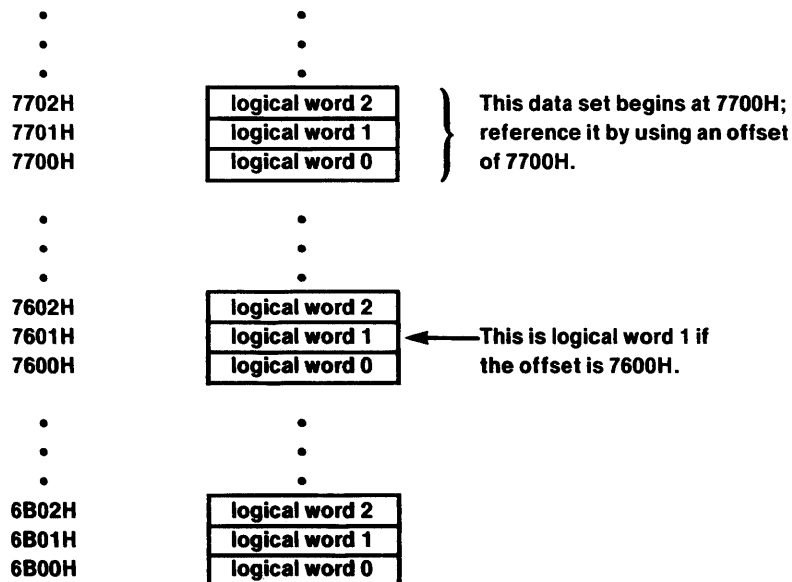

Figure B-1. Sets of Data Stored in Intellec Memory

After a set of data has been placed in memory at a certain offset, the offset is used as the only way of referring to that particular set of data. For example, figure B-1 shows three different areas with offsets of 6B00H, 7600H, and 7700H. If the offset parameter is set to 7600H, and format control is not used, all logical address references to data refer to data in the area starting at 7600H.

Note that memory space is not reserved by setting an offset. If enough data is stored with offset 7600H, it may overlap into the area starting at 7700H. It is up to the operator to select offsets far enough apart to avoid overlapping of data areas.

B-3. Logical Word Positions

When data is stored in Intellec memory, each logical word is placed in one Intellec memory byte. However, to refer to any particular logical word in memory, we do not use an Intellec memory address for it. Instead, we use a *logical word position*.

This is, in effect, an Intellec memory address *relative to the current offset*. The first logical word in an area is logical word 0; its actual address is 0 plus the offset. The next logical word is logical word 1, and its actual address is 1 plus the offset—and so forth.

Although each logical word occupies an 8-bit byte, the logical word length may be less than eight bits. In this case, the logical word is placed in the low-order bits of the byte; the high-order bits of the byte contain zeros and are ignored by the UPM commands.

This appendix contains explanations of the UPM commands not described in section 4-3 of this manual. Table C-1 summarizes these commands, which are arranged alphabetically, and gives the general command formats. Where appropriate, examples are supplied and described.

In most cases, these commands and keywords may be used within a command line or as separate command lines. The Compare, Exit, Program, Program ", Read, and Transfer commands are described in section 4-3 and are not repeated here.

C-1. Change

The general form of this command is as follows:

CHANGE *lo address* =value 1, value 2, value 3...value n

lo address specifies the starting logical word position where data changes are to take place. The list of values following the equal sign is the data that is to be used to replace that which is presently in successive Intellec memory locations beginning

Table C-1. Command Summary

Command	Default at Start	Used as Keyword	Structure of Command
CHANGE	None	No	*CHANGE <i>lo address</i> = value 1,value 2...value n
COMPARE	None	No	*COMPARE FROM <i>lo address</i> TO <i>hi address</i>
COMPARE "	None	No	*COMPARE "
DATA	T	Yes	*DATA= <i>sense</i>
DISPLAY	None	No	*DISPLAY FROM <i>lo address</i> TO <i>hi address</i>
EXIT	None	No	*EXIT
FILL	None	No	*FILL FROM <i>lo address</i> TO <i>hi address</i> WITH <i>value</i> { OFFSET <i>base</i> FORMAT }
FORMAT	None in Effect	Yes	*FORMAT <i>spec 1, spec 2, spec 3...spec 8</i>
LOGICAL	PROM Word Size	Yes	*LOGICAL = <i>word length</i>
OFFSET	6F70H	Yes	*OFFSET = <i>address</i>
PROGRAM	None	No	*PROGRAM FROM <i>lo address</i> TO <i>hi address</i> START PROM <i>address</i>
PROGRAM "	None	No	*PROGRAM "
READ	None	No	*READ <i>file type</i> FILE <i>file name</i> [INTO <i>bias</i>] [UNTIL <i>stop address</i>] *READ <i>file type</i> FILE <i>file name</i> FROM <i>lo address</i> TO <i>hi address</i> [START <i>load address</i>]
SOCKET	1	Yes	*SOCKET= <i>number</i>
STRIP	None	No	*STRIP <i>high/low</i> FROM <i>lo address</i> TO <i>hi address</i> INTO <i>new buffer address</i>
TRANSFER	None	No	*TRANSFER FROM <i>lo address</i> TO <i>hi address</i>
TYPE	None	No	*TYPE= <i>program algorithm</i>
WRITE	None	No	*WRITE FROM <i>lo address</i> TO <i>hi address</i> FILE <i>file name</i>

with *lo address*. Replacement of successive memory locations takes place until the string of values is exhausted.

The OFFSET keyword may be used optionally if the current offset must be changed for this Change command. If it is used, it must be entered after *lo address* and before the equal sign.

The FORMAT keyword may be used after *lo address* and before the equal sign to cause the Change command to be executed under control of the current Format as explained in section C-4.

Example

Logical words of 8-bits are stored in an area starting at 7600H. The value of logical word number 7 is to be changed to 3AH. The following command should be entered at the operator console:

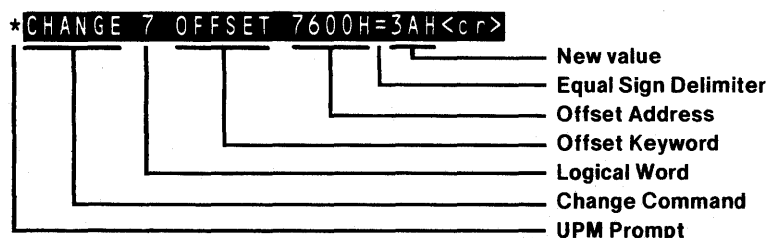

If the Change command is successful, UPM returns a prompt character (*). If it is unsuccessful, the system displays the Change line to the point where the command failed and displays a "STORE FAILS" error followed by a prompt character. (Refer to Appendix A.)

C-2. Data

This keyword has the following general formats:

`DATA[=sense]`

The purpose of the DATA keyword is to set the data true/false parameter to determine whether data is to be complemented or uncomplemented during input or output, depending on the command. Sense must be either a T (uncomplemented data) or an F (complemented data).

On system initialization, data sense is set to T and thereafter can be changed only by the DATA command/keyword.

NOTE

If the DATA keyword is used as part of a command line, the data sense is altered for that command only; the system parameter remains unchanged and the next command executed without a DATA keyword uses the value set by the previous Data command or the system default of T, whichever is in effect.

If the `=sense` argument is omitted, this command causes the current value of the data sense to be displayed.

C-3. Display

The general form of this command is as follows:

DISPLAY FROM *lo address* TO *hi address*

Execution of this command causes UPM to display the contents of the logical word positions encompassed by *lo address* and *hi address*. The command is used to check the contents of Intellec memory for error diagnostic purposes or to ensure that a file has been properly read. *lo address* specifies the beginning logical word position to be displayed. *hi address* specifies the logical word position of the last word in memory to be displayed.

The OFFSET keyword optionally may be used to cause the address supplied with the offset to be used rather than the current offset parameter. The FORMAT keyword optionally may be used to execute the Display command under control of the currently defined format. (See section C-4.)

Data may be displayed in hexadecimal or binary representation by means of the HEX or BINARY keywords. If neither of these keywords is used, hexadecimal display is assumed.

Example

A set of 4-bit logical words is stored in Intellec memory beginning at logical word position 0; the first 16H words are to be displayed. The following command should be entered at the operator console (assuming Logical parameter has been previously set):

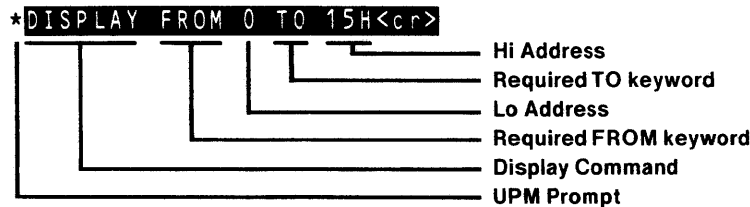

The system display appears as follows (including the command line):

```
*DISPLAY FROM 0 to 15H<cr>
0000 0H 2H 6H AH DH 8H BH 0H DH 2H 1H AH CH CH DH EH
0010 0H 0H 0H 2H 2H 3H
*
```

To display the same memory location contents in binary, the following command should be entered at the operator console:

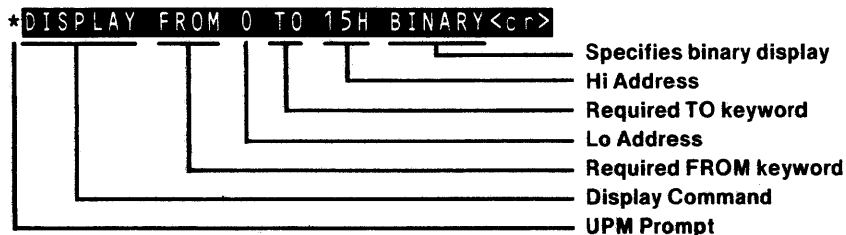

In this case, the display appears as follows:

```
*DISPLAY FROM 0 TO 15H BINARY<cr>
0000B 0000B 0010B 0110B 1010B
0004B 1101B 1000B 1011B 0000B
0008B 1101B 0010B 0001B 1010B
000CB 1100B 1100B 1101B 1110B
0010B 0000B 0000B 0000B 0010B
0014B 0010B 0011B
*
```

NOTE

In both hexadecimal and binary displays, the first number appearing on a line is the address of the first data item displayed on that line.

C-4. Format

The general form of this command is as follows:

```
FORMAT spec 1, spec 2, spec 3,...spec 8
```

Its purpose is to set up a format, which is a “rule” for breaking an input word or compound word into logical words or “fields” and storing the logical words separately. Alternatively, it may build an output word or compound word from logical words taken from various locations. Usage depends on the command in which the FORMAT is used.

C-5. Specifications

The field specifications shown in the general format above as “Spec 1, Spec 2,” etc., may take one of two forms. The first specifies an absolute Intellec memory address using the following form:

```
OFFSET address LOGICAL word length
```

The second form supplies a means of “counting off” and discarding unwanted bits in an input word by means of the NULL keyword as follows:

```
NULL LOGICAL word length
```

Up to eight specifications may be used in a single Format command and only one Format command (that most recently defined) is in effect at any time during a terminal session. The word length, which must follow the LOGICAL keyword, must be a number between one and eight (inclusive).

NOTE

The *sum* of all logical word lengths in any Format command may not exceed eight. If this is violated, the error BAD COMPOUND WORD LENGTH is displayed (see Appendix A) and execution is terminated.

The string of field specifications must be delimited with commas.

C-6. Examples

Three examples of increasing complexity are provided below and discussed. The Format command allows the user great flexibility in reformatting data during Change, Compare, Display, Program, Read, Transfer, or Write command execution.

Example 1

Consider the following FORMAT command:

```
*FORMAT OFFSET 6600H LOGICAL 4, OFFSET 6700H LOGICAL 4<cr>
```

Assume that a sequence of 8-bit words is being input under control of this format. When the first physical word is input, it is broken into two 4-bit logical words—one containing the high-order bits and one containing the low-order bits. The four high-order bits are placed in logical word position 0 of the memory area starting at 6600H; the four low-order bits are placed in logical word position 0 of the memory area starting at 6700H. When the second physical word is input, the four high-order bits are placed in logical word position 1 of the area starting at 6600H and the four low-order bits in logical word position 1 of the area starting at 6700H. Each new physical word is broken into four high-order and four low-order bits; the high- and low-order bits are stored separately in the two different areas of memory.

At the end of the input process, the memory area starting at 6600H contains the high-order bits (i.e., the first field) of each physical word, and the area starting at 6700H contains the low-order bits (the second field) of each physical word.

If an output command is performed under control of this same format, the output stream is made up of compound words formed by taking logical words from the two areas alternately—thus recreating the original input stream. If two PROM's are to be programmed with high-order bits in one and low-order bits in the other, use two Program commands *without* format control: one to program the first PROM from the area starting at 6600H, and another to program the second PROM from the area starting at 6700H (after unplugging the first PROM and replacing it with the second).

Example 2

This example shows the use of NULL fields. Assume data is stored in 8-bit physical words and is to be read into memory using 4-bit logical words. The high-order three bits of each physical word are irrelevant and are to be replaced with zeros. The following commands should be entered at the operator console:

```
*FORMAT NULL LOGICAL 3, OFFSET 6600H LOGICAL 1, OFFSET 6700H &<cr>
```

```
**LOGICAL 4<cr>
```

```
*FORMAT<cr>
```

```
@NULL,03H;@6600H,01H;@6700H,04H
```

```
*READ BAPF FILE :HR: INTO 0 FORMAT<cr>
```

During input of the physical words under format control, the three high-order bits are not stored at all—this is the meaning of the null field. The next bit is stored in a memory area starting at 6600H. The remaining four bits are stored in a memory area starting at 6700H.

To program the first PROM with 4-bit words, each word made up of three zero bits followed by the single bit that was originally the fourth bit of the physical word, requires a new format:

```
*FORMAT NULL LOGICAL 3, OFFSET 6600H LOGICAL 1<cr>
```

```
*TYPE=3601<cr>
```

```
*PROGRAM FROM 0 TO 255 START 0 FORMAT<cr>
```

*

This FORMAT command is the first part of the original one. The UPM builds up each 4-bit word by starting with three zeros to correspond to the null field in the format, then appending a bit from the memory area starting at 6600H.

To program the second PROM with 4-bit words, each of which was originally the four low-order bits of a physical word, use no format control, and specify an offset of 6700H. The logical word length parameter has been set to four automatically by the TYPE command, and this parameter affects the Program command since format control is not used.

```
*PROGRAM FROM 0 TO 255 START 0 OFFSET 6700H<cr>
```

*

The UPM takes each 4-bit logical word from the memory area starting at 6700H.

Example 3

The final example shows a more complex use of format control. Assume a 4-bit PROM is to be programmed with 4-bit data from a paper tape. As in Example 1, the low-order four bits of the 8-bit physical word will be used to create a 4-bit logical word; but after input, each 4-bit word is in reverse bit order—the high-order end is where the low-order end should be, and vice versa. The bit order must be reversed before programming the PROM.

To do this, construct a format that will put each of the four low-order bits from each physical word into a separate logical word:

```
*FORMAT OFFSET 6600H LOGICAL 1, OFFSET 6700H LOGICAL 1, &<cr>
```

```
**OFFSET 6800H LOGICAL 1, OFFSET 6900H LOGICAL 1<cr>
```

```
*FORMAT<cr>
```

```
@6600H,01H;@6700H,01;@6800H,01H;@6900H,01H
```

*

This established four fields (one for each bit in a 4-bit word) and four separate storage areas. When the first physical word is read from the tape under format control, its first four bits are thrown away (since the total number of bits specified in the format is four, and the Read command discards high-order bits if the logical or compound word length is less than eight). The fifth bit goes into location 6600H, the sixth into 6700H, the seventh into 6800H, and the eighth into 6900H. The next physical word is broken up in the same way, its four low-order bits going into locations 6601H, 6701H, 6801H, and 6901H, respectively.

To output all of these bits in reverse order, establish a new format:

```
*FORMAT OFFSET 6900H LOGICAL 1, OFFSET 6800H LOGICAL 1, &<cr>
```

```
**OFFSET 6700 LOGICAL 1, OFFSET 6600H LOGICAL 1<cr>
```

*

This format has exactly the same fields as the previous one, but they are specified in reverse order. When the Program command is given, each 4-bit output word is built up by taking the first bit from the area starting at 6900H; this bit was originally the last bit of the input word. The next bit is taken from the area starting at 6800H, and this bit was originally the third bit of the input word. The third bit is taken from the area starting at 6700H and the fourth bit from the area starting at 6600H to complete a 4-bit output word whose bit order is the reverse of the low-order four bits of the original physical word.

C-7. Logical

The general form of this command is as follows:

```
LOGICAL[=word length]
```

The purpose of the command or keyword is to set or display the logical word length parameter. The word length is the length in bits of the PROM logical word (i.e., the word length of the PROM in use). Data words read into memory from a paper tape or a diskette are adjusted to this length, if necessary, before being stored.

At system initialization, UPM sets Logical to the word length of the PROM specified by the user's response to the Type request or specified in a subsequent Type command. Use of either the Logical or Type command will modify the current system value of the Logical parameter.

NOTE

If the LOGICAL keyword is used in a command line, it is effective only during execution of that command. The current value of the logical word length is unchanged and will be in effect following completion of the present command.

By omitting the equal sign and the word length, the operator can display the current value of the logical word length.

C-8. Offset

The general form of this command is as follows:

```
OFFSET[=address]
```

This command sets or displays the offset address parameter. The address is the absolute Intellec memory address where storage for data being input or output begins.

At system initialization, the offset is set to the first available address for data storage. It may be modified only by use of the OFFSET command in the form described above.

NOTE

If the **OFFSET** keyword is used in a command line, it is effective only during execution of that command. The current value of the offset is unchanged and will be in effect following completion of the present command.

By omitting the equal sign and the address, the operator can display the current value of the offset address.

C-9. Socket

The general form of this keyword/command is as follows:

SOCKET[=*number*]

This command specifies which of the UPP front-panel PROM sockets is to be used. The number is either 1 or 2.

At system initialization, the socket *number* defaults to 1. It may be modified only by use of the **SOCKET** command or keyword.

NOTE

If the **SOCKET** keyword is used in a command line, it is effective only during execution of that command. The current value of the socket is unchanged and will be in effect following completion of the present command.

By omitting the equal sign and the number, the operator may display the current value of the socket number.

C-10. Type

The general form of this command is as follows:

TYPE[=*PROM type*]

This keyword parameter must be supplied as part of the system initialization procedure (see section 4-2). From that point, the *PROM type* may be changed only by use of the **TYPE** command. **TYPE** is not a valid optional keyword in any command line but must stand alone as a command.

A detailed explanation of the optional **PROM Type** arguments available with UPM appears in table 4-1.

C-11. Write

The general form of this command is as follows:

WRITE FROM *lo address* **TO** *hi address* **FILE** *file name* *file type*

This command punches data from Intellec memory to a paper tape or writes it to an ISIS diskette file. Data stored in logical word positions beginning at *lo address* through *hi address* (inclusive) is written to the appropriate output medium. The data is stored with the *file name* provided as a parameter to the **FILE** keyword. The file name can be **:HP:** for a high-speed paper tape punch.

File type is a keyword specifying the format of the data in that file. Its value is HEX for HEX-ASCII format (default if keyword is omitted), 86HEX for 8086 HEX-ASCII format, BNPF for that format, or OBJECT for 8080 object file format. The load address information in the generated file is the logical word address range *lo address to hi address*.

Either the OFFSET or FORMAT keyword also may be used optionally with the Write command, but both may not be specified in one Write instruction.

The LOGICAL keyword also is used optionally with the Write command to override the present logical word length in effect.

NOTE

If LOGICAL and FORMAT are used in the same Write command and the word length in the LOGICAL keyword differs from that contained in the FORMAT, the FORMAT word length will override that specified in the LOGICAL keyword argument.

The *sense* of data being written to the file also may be specified by use of the optional DATA keyword (see section C-2). If *sense* is omitted, the current value of the *sense* is used.

C-12. Strip

The 8086 code often must be placed into two 8-bit wide PROMs to get 16-bit parallel words. In this case, one PROM is understood to contain all high-order bytes and one PROM is understood to contain all low-order bytes. Since the 8086 is byte-addressable, it is equivalent to say one PROM contains all even-address bytes (low-order) and one PROM contains all odd-address bytes (high-order).

Since UPM programs only one PROM at a time with sequential bytes from memory, a method is required to collect all high- or low-order bytes from 8086 code into a contiguous section of memory. The Strip command does this; its syntax is

```
STRIP { HIGH | LOW } FROM first TO last INTO newbuffer
[ { OFFSET base | FORMAT } ]
```

This command will proceed sequentially from logical address *first* to logical address *last*, inclusive, and copy each high- or low-order byte encountered into sequential bytes beginning at logical address *newbuffer*.

{ HIGH | LOW } means one and only one of the keywords HIGH or LOW must be specified to indicate whether high- or low-order bytes are to be striped out.

[{ OFFSET *base* | FORMAT }] means nothing need be specified, or OFFSET *base* may be specified, or FORMAT may be specified (but not both). If neither OFFSET nor FORMAT is specified, then the logical addresses *first*, *last*, and *newbuffer* are modified by the current global offset parameter (as usual in UPM commands). If OFFSET *base* is specified, then the value *base* is used in place of the global offset parameter value for the duration of this command. If FORMAT is specified, then the source buffer *first* to *last* is under format control; however, the destination buffer beginning at *newbuffer* is *not* under format control and is treated as though FORMAT were not specified.

Note that it is acceptable for the destination buffer to start at the same absolute system memory location as the source buffer, since the strip function operates on successive bytes.

A byte in the source buffer is considered high if its logical address is odd. A byte in the source buffer is considered low if its logical address is even.

Example:

```
*READ 86HEX FILE F00.86H INTO 0<cr>
*STRIP LOW FROM 0 TO 07FFH INTO 1000H<cr>
*STRIP HIGH FROM 0 TO 07FFH INTO 2000H<cr>
*PROGRAM FROM 1000H TO 13FFH START 0<cr>
*PROGRAM FROM 2000H TO 23FFH START 0<cr>
```

A 2k-byte program is read in and split into two parts, all low-order bytes at 1000H and all high-order bytes at 2000H. Then, two 1k by 8-bit PROM's are programmed, one with all low-order bytes and one with all high-order bytes.

C-13. Fill Memory

The general form of the Fill Memory command is as follows:

```
FILL FROM lo address TO hi address WITH value{{ OFFSET base | FORMAT }}
```

This command causes the contents of the Intellec memory locations starting at *lo address* through *hi address* to be filled with the data value specified by *value*.

{ *OFFSET base | FORMAT }* means nothing need be specified, or *OFFSET base* may be specified, or *FORMAT* may be specified (but not both). If neither *OFFSET* nor *FORMAT* is specified, then the logical addresses first, last, and newbuffer are modified by the current global offset parameter (as usual in UPM commands). If *OFFSET base* is specified, then the value *base* is used in place of the global offset parameter value for the duration of this command. If *FORMAT* is specified, then the source buffer first to last is under format control; however, the destination buffer beginning at newbuffer is *not* under format control and is treated as though *FORMAT* were not specified.

C-14. Abort

The form of this command is:

esc

esc signifies that the escape key is to be depressed. As soon as *esc* character is recognized, all open files are closed and the current command is aborted.



REQUEST FOR READER'S COMMENTS

Intel's Technical Publications Departments attempt to provide documents that meet the needs of all Intel product users. This form lets you participate directly in the documentation process. Your comments will help us correct and improve our manuals. Please take a few minutes to respond.

Please restrict your comments to the usability, accuracy, readability, organization, and completeness of this document. If you have any comments on the equipment software itself, please contact your Intel representative. If you wish to order manuals contact the Intel Literature Department (see page ii of this manual).

1. Please describe any errors you found in this manual (include page number).

2. Does the document cover the information you expected or required? Please make suggestions for improvement.

3. Is this the right type of document for your needs? Is it at the right level? What other types of documents are needed?

4. Did you have any difficulty understanding descriptions or wording? Where?

5. Please rate this publication on a scale of 1 to 5 (5 being the best rating). _____

NAME _____ DATE _____

TITLE _____

COMPANY NAME/DEPARTMENT _____

ADDRESS _____

CITY _____ STATE _____ ZIP CODE _____
(COUNTRY)

Please check here if you require a written reply.

WE'D LIKE YOUR COMMENTS ...

This document is one of a series describing Intel products. Your comments on the back of this form will help us produce better manuals. Each reply will be carefully reviewed by the responsible person. All comments and suggestions become the property of Intel Corporation.



**NO POSTAGE
NECESSARY
IF MAILED
IN U.S.A.**



BUSINESS REPLY MAIL
FIRST CLASS PERMIT NO. 1040 SANTA CLARA, CA

POSTAGE WILL BE PAID BY ADDRESSEE

**Intel Corporation
Attn: Technical Publications M/S 6-2000
3065 Bowers Avenue
Santa Clara, CA 95051**



INTEL CORPORATION, 3065 Bowers Avenue, Santa Clara, California 95051 (408) **987-8080**

Printed in U.S.A.