

# Microsoft Windows<sup>®</sup>™

*Graphical Environment*

## User's Guide

**Microsoft<sup>®</sup>**

***Microsoft® Windows™  
User's Guide***

---

***for the Windows Graphical Environment***

---

***VERSION 3.0***

***for the MS-DOS® or PC-DOS Operating System***

***Microsoft Corporation***

Information in this document is subject to change without notice and does not represent a commitment on the part of Microsoft Corporation. The software described in this document is furnished under a license agreement or nondisclosure agreement. The software may be used or copied only in accordance with the terms of the agreement. It is against the law to copy the software on any medium except as specifically allowed in the license or nondisclosure agreement. No part of this manual may be reproduced or transmitted in any form or by any means, electronic or mechanical, including photocopying and recording, for any purpose without the express written permission of Microsoft.

#### U.S. Government Restricted Rights

The SOFTWARE and documentation are provided with RESTRICTED RIGHTS. Use, duplication, or disclosure by the Government is subject to restrictions as set forth in subparagraph (c) (1) (ii) of the Rights in Technical Data and Computer Software clause at DFARS 252.227-7013 or subparagraphs (c) (1) and (2) of the Commercial Computer Software — Restricted Rights at 48 CFR 52.227-19, as applicable. Contractor/manufacturer is Microsoft Corporation/One Microsoft Way/Redmond, WA 98052-6399.

© Copyright Microsoft Corporation, 1985-1990. All rights reserved.  
Simultaneously published in the U.S. and Canada.  
Printed and bound in the United States of America.

Microsoft, MS, MS-DOS, CodeView, and the Microsoft logo are registered trademarks, and Windows and Windows/386 are trademarks of Microsoft Corporation.

386 is a trademark of Intel Corporation.

386-Max is a trademark of Qualitas, Inc.

Acer is a registered trademark of Acer Technologies Corporation.

Apple and LaserWriter are registered trademarks of Apple Computer, Inc.

Ashton-Tate, dBASE III and Framework II are registered trademarks of Ashton-Tate Corporation.

AST and RAMpage! are registered trademarks of AST Research, Inc.

AT&T is a registered trademark of American Telephone and Telegraph Company.

Bitstream is a registered trademark, and Fontware is a trademark of Bitstream, Inc.

Borland and SideKick are registered trademarks of Borland International, Inc.

Centronics is a registered trademark of Centronics Data Computer Corp.

COMPAQ DESKPRO is a registered trademark of Compaq Computer Corporation.

CompuServe is a registered trademark of CompuServe, Inc.

Dow Jones News/Retrieval is a registered trademark of Dow Jones And Company, Inc.

Epson is a registered trademark of Epson America, Inc.

Hayes is a registered trademark of Hayes Microcomputer Products, Inc.

Hercules is a registered trademark of Hercules Computer Technology.

HP, LaserJet and PCL are registered trademarks of Hewlett-Packard Company.

IBM, PS/2, and TopView are registered trademarks of International Business Machines Corporation.

Intel is a registered trademark, and Above is a trademark of Intel Corporation.

ITC Zapf Dingbats is a registered trademark of International Typeface Corporation.

Linotronic is a trademark of Linotype AG and its subsidiaries.

Lotus and 1-2-3 are registered trademarks of Lotus Development Corporation.

MultiMate Advantage II is a trademark of MultiMate International Corporation, an Ashton-Tate company.

NEC is a registered trademark of NEC Corporation.

Olivetti is a registered trademark of Ing. C. Olivetti.

PFS: and First Choice are registered trademarks of Software Publishing Corporation.

PageMaker is a registered trademark of Aldus Corporation.

Paintbrush is a trademark of Zsoft Corporation.

PostScript is a registered trademark of Adobe Systems, Inc.

Recorder was developed for Microsoft by Softbridge Ltd.

Terminal was developed for Microsoft by Future Soft Engineering, Inc.

The Symbol fonts provided with Windows 3.0 are based on the CG Times font, a product of AGFA Compugraphic Division of Agfa Corporation.

TI is a registered trademark of Texas Instruments, Inc.

Type Director is a trademark of Agfa Corporation, AGFA Compugraphic Division.

VT 100 is a trademark of Digital Equipment Corporation.

WordPerfect is a registered trademark of WordPerfect Corporation

Document No. SY06851-0290

OEMW770-3Z

---



---

# Contents

<b>Microsoft Windows 3.0</b> .....	<b>ix</b>
If You Have a Previous Version of Windows .....	ix
What You Need to Run Windows .....	ix
Registering Windows .....	xi
What Is Microsoft Windows? .....	xi
New Features in Windows 3.0 .....	xvii
About Your Windows Documentation .....	xix

---

## **PART 1 Windows Fundamentals**

<b>Chapter 1 Getting Started</b> .....	<b>5</b>
Installing Windows with Setup .....	7
Starting Windows .....	8
Quitting Windows .....	10
Working with System Messages .....	13
<b>Chapter 2 Basic Skills</b> .....	<b>15</b>
The Basic Elements of Windows .....	17
Working with Menus .....	25
Working with Dialog Boxes .....	33
Working with a Window .....	41
Working with Applications .....	49
Working with Documents .....	64
Using Windows Help .....	70
Practicing Basic Skills .....	75
<b>Chapter 3 Program Manager</b> .....	<b>77</b>
What Is Program Manager? .....	79
Working with Groups .....	80
Starting Applications from Program Manager .....	96
Quitting Program Manager .....	98

**Chapter 4 File Manager ..... 99**

What Is File Manager? ..... 101  
Starting File Manager ..... 101  
Working with the Directory Tree ..... 102  
Working with Directory Windows ..... 111  
Working with Files and Directories ..... 121  
Starting Applications from File Manager ..... 137  
Maintaining Disks and Diskettes ..... 138  
Quitting File Manager ..... 142

**Chapter 5 Control Panel ..... 143**

Starting Control Panel ..... 145  
Customizing the Desktop Colors ..... 147  
Choosing Desktop Options ..... 152  
Installing a Printer ..... 158  
Configuring a Printer ..... 164  
Connecting to a Network Printer ..... 172  
Removing an Installed Printer ..... 173  
Printing Without Print Manager ..... 174  
Configuring Communications Ports ..... 175  
Setting Network Options ..... 177  
Adding and Removing Fonts ..... 177  
Setting International Options ..... 180  
Customizing Use of the Mouse ..... 187  
Setting the System Date and Time ..... 188  
Adjusting Keyboard Speed ..... 189  
Controlling Sound ..... 190  
Setting Options for Running in 386 Enhanced Mode ..... 190

**Chapter 6 Print Manager ..... 195**

Printing with Windows Applications ..... 197  
Printing with Non-Windows Applications ..... 197  
Printing with Print Manager ..... 198  
Printing on a Network ..... 206  
Printing to a File ..... 210  
If Things Go Wrong ..... 211

---

**PART 2 Windows Accessories**

---

<b>Chapter 7 Write</b> .....	<b>221</b>
Creating a Document .....	223
Editing a Document .....	224
Formatting Your Document .....	237
Managing Write Files .....	253
Printing a Document .....	255
<b>Chapter 8 Paintbrush</b> .....	<b>259</b>
Drawing with a Mouse or the Keyboard .....	263
The Paintbrush Window .....	263
Creating a Simple Drawing .....	269
Entering Text .....	273
Working with the Paintbrush Tools .....	278
Editing Your Drawing .....	296
Advanced Paintbrush Features .....	301
Working with Paintbrush Files .....	307
Printing a Drawing .....	309
<b>Chapter 9 Terminal</b> .....	<b>315</b>
Before Starting .....	317
A First Session .....	318
Starting Terminal .....	319
Preparing to Connect .....	320
Assigning Function Keys .....	330
Connecting to the Remote Computer .....	334
Transferring Files .....	334
Working with Text in the Terminal Window .....	346
Printing .....	348
Ending Your Communications Session .....	350
If Things Go Wrong .....	351

<b>Chapter 10</b>	<b>Additional Accessories</b>	<b>355</b>
	Calculator	357
	Calendar	370
	Cardfile	386
	Clock	398
	Notepad	399
	Recorder	405
	PIF Editor	420

---

## ***PART 3***   ***Advanced Topics***

---

<b>Chapter 11</b>	<b>Options for Starting Windows</b>	<b>425</b>
	The Windows Command Line	427
	Starting Windows in a Specific Mode	428
	Controlling How Windows Uses Expanded Memory in Real Mode	429
	Specifying a Run Command	431
	Some Sample Windows Command Lines	431
<b>Chapter 12</b>	<b>More About Applications</b>	<b>433</b>
	Working with Different Types of Applications	437
	Working with PIFs and PIF Editor	444
	Specifying PIF Options for Standard Mode or Real Mode	450
	Specifying Basic PIF Options for 386 Enhanced Mode	457
	Specifying Advanced PIF Options for 386 Enhanced Mode	462
	Changing Settings for a Running Application	476
	Freeing Up Memory	478
	If Things Go Wrong	482
<b>Chapter 13</b>	<b>Optimizing Windows</b>	<b>491</b>
	What Is Optimizing?	493
	What Are System Resources?	494
	Configuring Your System's Memory	499
	Optimizing Your System	503

---

<b>Chapter 14</b>	<b>Networks and Windows</b>	<b>543</b>
	Getting Windows from a Network	545
	Using Networks with Windows	546
	Putting Windows on a Network	553

## ***Appendixes***

---

<b>A</b>	<b>Using Setup to Maintain Windows</b>	<b>559</b>
	Running Setup from Windows	559
	Running Setup from MS-DOS	563
<b>B</b>	<b>Special Characters</b>	<b>567</b>
	Using ANSI Characters with Windows	567
	Using Other Character Sets with Windows	569
	Using Special Characters in a Non-Windows Application	571
	Using Special Characters in a Non-Windows Document	571
<b>C</b>	<b>Terminal Emulation Tables</b>	<b>573</b>
	VT 52 Terminal - Keyboard	573
	VT 52 Terminal - Functions	575
	VT 100 Terminal - Keyboard	576
	VT 100 Terminal - Functions	578
<b>D</b>	<b>Command Lines in the CONFIG.SYS File</b>	<b>583</b>
	Using the HIMEM.SYS Command Line	583
	Using the SMARTDrive Command Line	587
	Using the RAMDrive Command Line	590
	Using the EMM386.SYS Command Line	594

<b><i>Glossary</i></b>	<b>601</b>
------------------------	------------

<b><i>Index</i></b>	<b>611</b>
---------------------	------------



# Welcome to Windows



---

---

# ***Microsoft Windows 3.0***

Welcome to Microsoft® Windows™, the software that transforms the way you use your personal computer. Windows' ability to run more than one application at a time and transfer information between applications, the superior way it uses the full power of your computer, and its rich graphical interface provide a more intuitive, more efficient work environment than ever before available on a PC.

This introductory section of the *Windows User's Guide* tells you about the computer equipment and software you need to run Windows, and what you'll receive when you register your copy of Windows. It also offers a preview of the Windows graphical environment and highlights its new features and enhancements. Perhaps most importantly, this section prepares you to make the most of the *User's Guide* by defining typographical conventions and important terminology.

## ***If You Have a Previous Version of Windows***

Updates are already available for some of the Windows applications that you ran with previous versions of Windows. The updated versions take full advantage of the new features and power of Windows 3.0.

If you have not received information about Windows 3.0 updates for your favorite Windows applications, check with the manufacturers.

Until you receive an update, you can run Windows 2.x applications that you already own by starting Windows in real mode, the operating mode used by previous versions of Windows. See Chapter 11, "Options for Starting Windows," for information about starting in real mode. To learn more about running applications that were developed for previous versions of Windows, see "Older Windows Applications" in Chapter 12.

## ***What You Need to Run Windows***

Windows 3.0 can run in three modes: real mode, standard mode, or 386™ enhanced mode. The mode that you use depends on the equipment you have and the software applications you want to run in the Windows environment.

*Real mode* is the operating mode that provides maximum compatibility with previous versions of Windows applications (2.x versions). Real mode is also the only

mode available for computers with less than 1 megabyte (MB) of memory (640 kilobytes (K) of conventional memory and 256K of extended memory).

*Standard mode* is the normal operating mode for running Windows. This mode provides access to extended memory and also lets you switch among non-Windows applications.

*386 enhanced mode* provides access to the virtual memory capabilities of the Intel® 80386 processor. Virtual memory capabilities let Windows applications use more memory than is physically available. Enhanced mode also allows for multi-tasking of non-Windows applications.

Windows 3.0 works with most personal computers on the market today. In the Windows package, you received a Hardware Compatibility List of equipment that passed Windows compatibility testing. Any hardware that is 100 percent compatible with hardware on the list should work fine with Windows. If you intend to use equipment that is not on this list, ask the equipment manufacturer about any special software you might need before you can use it with Windows 3.0.

The minimum software and hardware requirements your computer system needs to run Windows successfully are:

- MS-DOS® or PC-DOS, version 3.1 or later.
- For *386 enhanced mode*, a personal computer with the Intel 80386 processor (or higher) and 2 megabytes (MB) or more of memory (640K of conventional memory and 1024K of extended memory).

For *standard mode*, a personal computer with the Intel 80286 processor (or higher) and 1 megabyte or more of memory (640K conventional memory and 256K of extended memory).

For *real mode*, a personal computer with the Intel 8086 or 8088 processor (or higher) and 640K of conventional memory.

- A hard disk with 6 to 8 megabytes of free disk space, and at least one floppy disk drive.
- A monitor that is supported by Windows.
- A printer that is supported by Windows if you want to print with Windows.
- A Hayes®-compatible modem that is supported by Windows if you want to use Terminal, the Windows communications software.
- A mouse that is supported by Windows. Though it is not required, a mouse is highly recommended so that you can take full advantage of Windows' easy-to-use graphical interface.

Windows determines which operating mode your system uses when you start up using the standard procedure outlined in Chapter 1, "Getting Started." For information about starting Windows in an alternate mode, see Chapter 11, "Options for Starting Windows." For information about memory, see Chapter 13, "Optimizing Windows."

**NOTE** If your computer has more than 640K of memory, you should configure it as extended memory to get the best performance from Windows. Memory considerations are discussed in Chapter 13, "Optimizing Windows."

With less than 1MB of memory, Windows will run only in *real* mode. See Chapter 12, "More About Applications," for an explanation of running Windows in real mode.

## Registering Windows

Please take a moment to fill out and mail the Registration Card you received with Windows. Registering Windows entitles you to the following additional benefits:

- Microsoft's technical support if you have any difficulty using Windows. Your questions will be answered by dedicated support specialists experienced in assisting Windows customers.
- Automatic notification of upgrades or revisions to Windows. By receiving timely notices directly from Microsoft, you'll be among the first to know about upgrades.
- Automatic notification when new products related to Windows are released. You'll receive up-to-date information about exciting new Windows applications as soon as they become available. In some cases, you'll be offered special introductory pricing.

## What Is Microsoft Windows?

Windows is a graphical environment that introduces new, more streamlined ways for you to work with your personal computer. Windows not only gives you more control over the way you work, it unleashes your computer so it can operate at its full power, unhampered by previous memory restrictions.

With Windows, you'll find it easy to start up and work with your software applications, run more than one application at a time, transfer information between them, and organize and manage the files you create with them.

In Windows, your computer screen is referred to as a *desktop*. The desktop displays all your work in rectangular areas called *windows*. You work with your applications and documents in these windows.

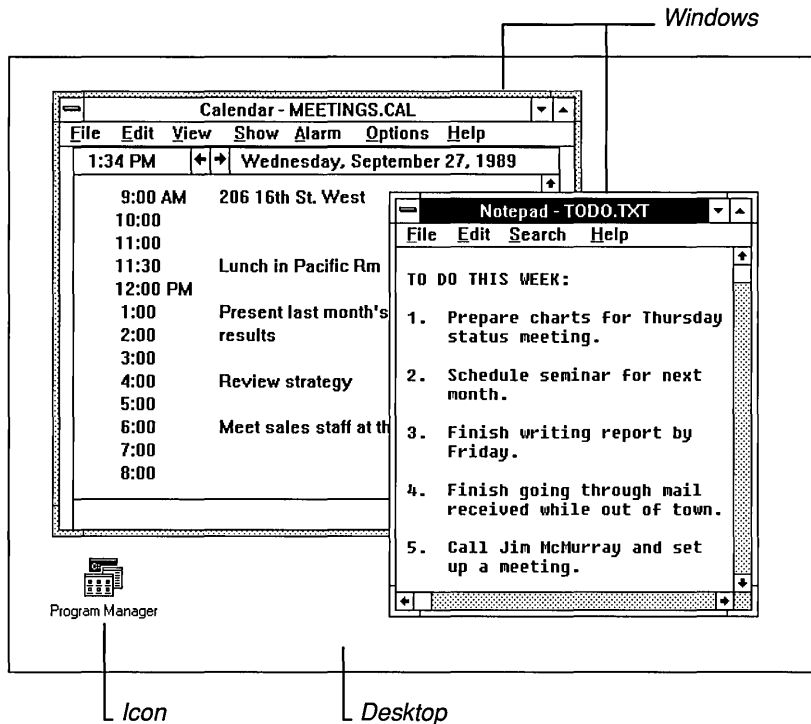

You arrange windows on the desktop just as you move work items around on your actual desk. For example, to review a spreadsheet and a report from two separate applications, you change the size of their windows so that they can fit side by side on the desktop.

If you want to leave an application for a while, you shrink its window to an *application icon* and the application keeps running. When you shrink an application, Windows places its application icon at the lower edge of the desktop until you restore it to window size again.

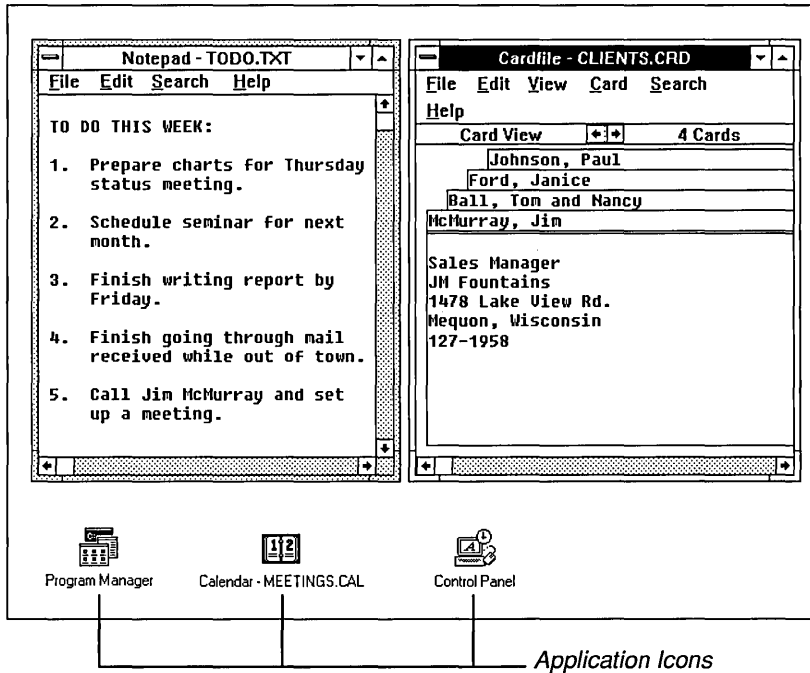

With Windows, you can run several powerful applications at once and switch quickly among them. For example, you could switch from a database application to a spreadsheet, and then to your word processor—with a few simple moves and without waiting while you quit one application and restart another.

When you work with two or more applications, whether they were designed specifically for Windows or not, you can transfer information from one to another. You select the information you want from one application, *cut* or *copy* it to the Clipboard, and then *paste* it into another application. By moving information in this way, you can combine the work you've done in a number of different applications into a single, compound document.

For example, you could start by writing the text for an invitation to the company picnic with your word processor.

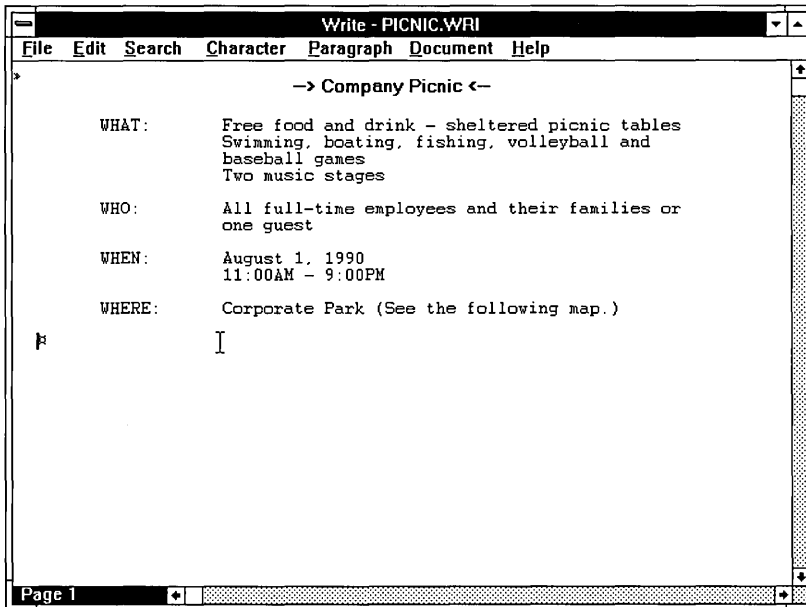

Then you could draw a map to the picnic grounds with a graphics application.

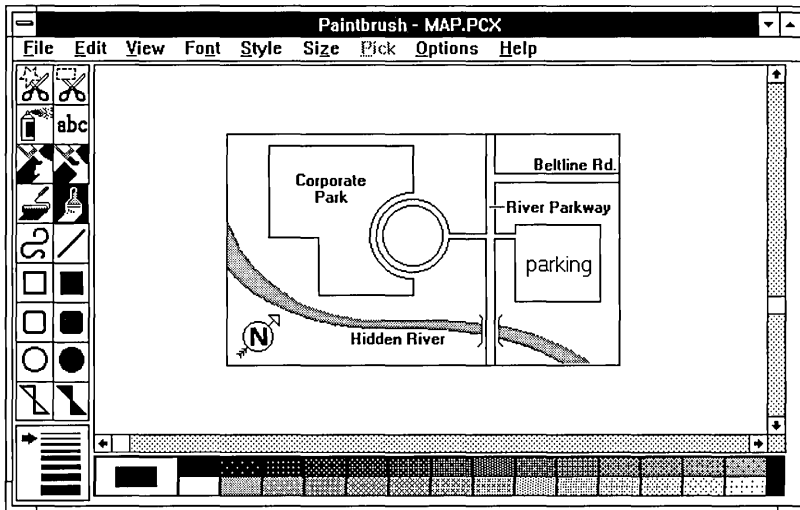

Finally, you could add the map to the invitation by cutting it from the graphics application and pasting it into the text you created with your word processor.

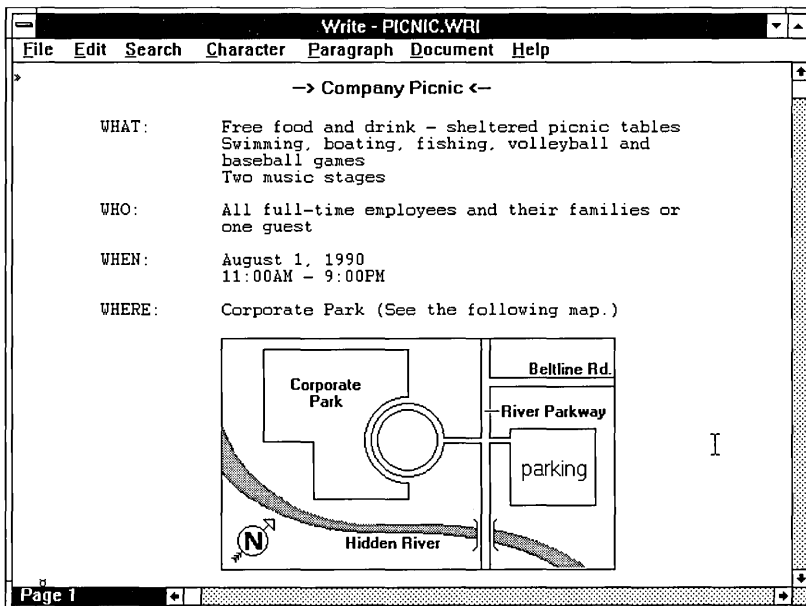



As you work with an application, you can pause at any time to take care of other tasks. For example, you might need to make some additions to your card files, schedule yet another meeting on your calendar, or pull together some quick totals with Windows' electronic calculator.

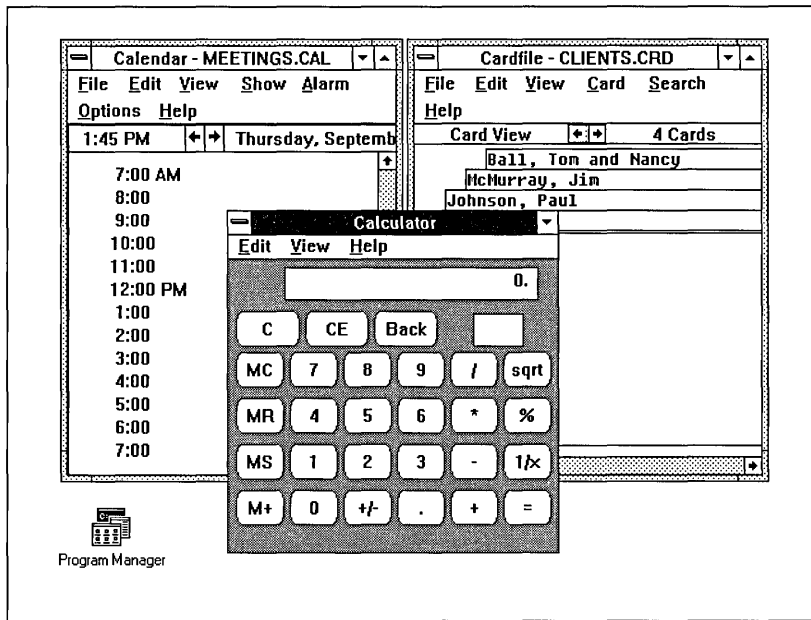

Windows comes with a collection of useful accessory programs to help you manage the various parts of your daily work. These accessories include a clock, an appointment calendar, a calculator, a notepad, a card file, and a macro recorder.

And to get you started working with applications, Windows includes three full-featured applications: Write, Paintbrush™, and Terminal. Use these applications to prepare and edit documents, create colorful illustrations, and connect to other computers and information services with your modem.

For those idle moments, or just to put some play in your day, Windows provides two games: Solitaire and Reversi. You can also use the games to practice some of the basic skills you need to operate Windows efficiently. See Chapter 2, "Basic Skills," to learn about operating Windows.

## New Features in Windows 3.0

If you are already familiar with earlier versions of Microsoft Windows, you'll notice right away that Windows 3.0 brings you many significant additions. The most visible improvement is the desktop's appearance. There you'll find a new standard color scheme, proportionally spaced type in the menus and dialog boxes, and a three-dimensional look to many icons and buttons.

Three new applications—Program Manager, File Manager, and Task List— provide more powerful, more intuitive ways to start programs, manage files and directories, and switch between running applications.

You'll also find an on-line Help system that gives you quick, easy-to-use information about Windows' features.

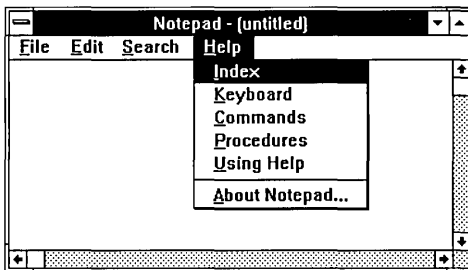

**Help menu in Notepad window**

One of the most dramatic improvements is the way Windows 3.0 can use memory. Windows looks beyond the previous limitation of 640K and addresses extended memory, the additional memory that is available in today's more powerful personal computers. Now you can run several applications at once and work with much larger document files without running out of memory.

Other new features and improvements include the following:

- A new Setup program makes it easier to install Windows and later view or change your setup options.
- A redesigned Control Panel lets you connect to network printers, set up additional ports, set multitasking options for 386 enhanced mode, and customize the appearance of your desktop.

- Print Manager provides more information about files that are printing—allowing you to view network print queues, for example.
- Program Manager lets you organize your applications into distinct groups and then start the applications and their related documents quickly and easily.
- File Manager allows a full range of mouse maneuvers so you can copy and move files and directories by dragging and dropping their icons with your mouse.
- File Manager also lets you connect to and disconnect from network servers while using Windows.
- Recorder lets you save a series of keyboard and mouse sequences and play them back whenever you want to repeat the sequence. This procedure creates what is known as a *macro*.
- Paintbrush, a more powerful and sophisticated painting program, lets you create full-color illustrations.
- Terminal supports new terminal emulations, communications protocols, file-transfer capabilities, and the assignment of multiple keystroke sequences to single keys.
- Printing support has been improved for HP ®/PCL ® and PostScript ® printers.
- New commands let you rearrange the windows on the desktop, making them easier to find and view.
- A new, expanded symbol font is included.
- Running Windows in 386 enhanced mode provides increased control over non-Windows applications.
- System messages now include clear explanations and recommended remedies.
- A new game, Solitaire, lets you practice the basic skills you use to operate Windows.

# About Your Windows Documentation

The Windows 3.0 documentation set consists of this *User's Guide*, an on-line Help system, and several read-me text files that are copied onto your hard disk when you install Windows. The pages that follow outline the contents of the *User's Guide* and define terminology that is important to your understanding of Windows.

The way you like to learn and how much you already know about Windows and about computers will determine how you use the different pieces of the documentation.

- The *Windows User's Guide* provides a comprehensive description of Windows and the ways you can work with it. It includes explanations and procedures for first-time users, as well as advanced topics for those already familiar with the Windows environment.
- On-line Help is a new feature of Windows. It provides a quick reference for procedures, keystroke sequences, and commands you will need when operating Windows. You can find information in Help without leaving your computer.
- Several text files are copied onto your hard disk when you install Windows. These .TXT files include information that was received too late to be printed in the *User's Guide* as well as information that is reserved for advanced users. You can read (and print) the files by opening them with any text processor (such as Notepad). These files include:

README.TXT	Information received after the <i>User's Guide</i> was printed.
PRINTERS.TXT	Information about particular printers and fonts that helps you configure them to run in the Windows environment.
NETWORKS.TXT	Information about operating Windows with specific network configurations.
SYSINI.TXT	Procedures for modifying SYSTEM.INI settings (for advanced users only).
WININI.TXT	Procedures for modifying WIN.INI settings (for advanced users only).

## ***What's Included in Your Windows User's Guide?***

You'll probably find yourself using some Windows features, such as the new Program Manager, more often than others, such as PIF Editor. The *User's Guide* is organized with this in mind. Those features you are likely to use most often are described in the early chapters; those you'll use less frequently appear later.

The *User's Guide* is divided into the following parts:

*Part 1, Windows Fundamentals.* Chapters in this part explain the basic structure of Windows and the skills you need to work with Windows. They also show you how to use the important system-management applications you received with Windows. These applications are:

- Task List, which lets you quickly switch applications on your desktop anytime.
- Clipboard, which lets you move and copy information from one window to another across applications.
- Program Manager, which helps you organize your applications for easy access.
- File Manager, which helps you organize and manage all the files and directories on your disks.
- Control Panel, which lets you change colors and fonts, set up printers and modems, or change the appearance of your desktop without leaving Windows.
- Print Manager, which schedules and fills all print requests you send from Windows and non-Windows applications.

*Part 2, Windows Accessories.* Chapters in this part describe the accessory applications that are included with the Windows package. You received three full-featured applications:

- Windows Write, an executive word processor
- Paintbrush, a color painting program
- Terminal, a communications program

You also received several programs that add convenient capabilities to your Windows desktop, including Calculator, Calendar, Cardfile, Clock, Notepad, Recorder, and PIF Editor.

*Part 3, Advanced Topics.* This part contains four chapters of information for advanced users. It explains how to set options for running certain applications and how to modify Windows to run most efficiently with your computer and the

applications you want to use. And it offers instructions for using Windows on a network.

*Appendixes.* The appendixes provide reference material on the following topics:

- How to reconfigure your Windows environment using Setup
- How to enter special characters, such as special symbols or letters used in languages other than American English
- How to change the specifications for terminal emulations
- How to enter specialized CONFIG.SYS command lines

This *User's Guide* also includes a glossary and a comprehensive index.

For your convenience, each chapter in the *User's Guide* begins with a table of contents listing the topics you'll find in that chapter.

## ***Assumptions***

The *User's Guide* assumes the following:

- *Windows* refers to Microsoft Windows version 3.0 or later.
- *MS-DOS* refers to versions 3.1 or later of MS-DOS or PC-DOS.
- You are using a mouse with Windows. However, you'll also find the equivalent keyboard techniques with each description, in the step-by-step procedures, and in on-line Help.

## ***Conventions***

To help you locate and interpret information easily, the *User's Guide* employs consistent visual cues, a few standard text formats, and some special terminology. These conventions are explained as follows.

## Visual Cues

You will find the following typographic conventions throughout the *User's Guide*.

<u>Type style</u>	<u>Used for</u>
<i>italic</i>	Anything that you must type exactly as it appears. For example, if you are asked to type <code>dir \windows</code> , you would type all the italicized characters exactly as they are printed in the guide.  Italic type also signals a new term. An explanation immediately follows the italicized term.
<b>bold</b>	Placeholders for information you must provide. For instance, if you are asked to type <b>filename</b> , you would type the actual name for a file instead of the word shown in bold print.
ALL CAPITALS	Directory names, filenames, and acronyms.
SMALL CAPITALS	The names of keys on your keyboard. For example, CTRL, ESC, or HOME.
Initial Capitals	Menu items, command names, and dialog-box names and options. For example, File menu, Save command, or Line Wrap option.
<u>Symbol</u>	<u>Used For</u>
▷	Signals the beginning of a procedure.
□	Signals a procedure that has only one step.
<i>Mouse</i>	Instructions for mouse users.
<i>Keyboard</i>	Instructions for keyboard users.
	Signals a section that is specific to operating Windows in 386 enhanced mode.

**NOTE** Windows starts in one of three operating modes depending on your hardware configuration. For a definition of the various modes, see the “Terminology” section that follows and Chapter 1, “Getting Started.” For information about starting Windows in a different mode, see Chapter 11, “Options for Starting Windows.”

## Keyboard Formats

Key combinations and key sequences appear in the following format:

<u>Format</u>	<u>Meaning</u>
KEY1 + KEY2	A plus sign (+) between key names means to hold down the first key while you press the second key. For example, Press ALT + ESC means to hold down the ALT key and press the ESC key. Then release both keys.
KEY1, KEY2	A comma (,) between key names means to press and release the keys one after the other. For example, press ALT, F means to press and release the ALT key. Then press and release the F key.

## Terminology

The following terms take on special meanings in the context of Windows. Your familiarity with them will make the concepts and procedures presented in this guide and in on-line Help easier to understand.

<u>Term</u>	<u>Meaning</u>
386 enhanced mode	A special operating mode that provides access to the virtual memory capabilities of the Intel 80386 processor. Virtual memory capabilities let Windows applications use more memory than is physically available. Enhanced mode also allows for the multitasking of non-Windows applications. To run Windows in 386 enhanced mode, you must be using a personal computer that has the Intel 80386 processor or higher and at least 2MB of memory.
Application	A computer program used for a particular kind of work, such as word processing. (See also <i>Windows applications</i> and <i>non-Windows applications</i> .)
Application icon	A graphical representation of a running application that has been minimized. Application icons appear on the desktop.
Choose	To use a mouse or key combination to pick an item that begins an action in Windows. (Contrast with <i>select</i> ).
Click	To quickly press and release the mouse button.



<u>Term</u>	<u>Meaning</u>
Desktop	The screen background for Windows. The Windows desktop is similar to the surface of the desk you use at work or at home. You can perform the same kinds of tasks electronically on the Windows desktop that you would do manually on your work desk.
DIRECTION keys	The four arrow keys on your computer keyboard. Each arrow key is named for the direction the key points: UP ARROW, DOWN ARROW, RIGHT ARROW, and LEFT ARROW.
Directory	A collection of computer files (programs and data) that are stored at the same location on a disk. The name of the directory identifies its location.
Document icon	A graphical representation for a document window that is minimized. Document icons appear only in applications that allow two or more documents to be opened in the application workspace at one time. Program Manager and File Manager are examples of such applications.
Double-click	To click the mouse button twice in rapid succession.
Drag	To hold down the mouse button while you slide the mouse.
Group	A collection of applications in the Program Manager window.
Icon	A graphic representation for various elements in Windows. Icons are used to represent running applications, groups, and program items in Program Manager. For example, a graphic of a clock represents the Clock application.
Menu	A list of items. Most menu items are Windows commands.
Non-Windows applications	Computer programs that were not designed to run within the Windows environment. Non-Windows applications do not necessarily conform to Windows user interface standards.

---

<u>Term</u>	<u>Meaning</u>
Pathname	A designation for the location of files or directories on your disk. For example, <i>c:\windows\user1</i> is the pathname to the \USER1 subdirectory of the \WINDOWS directory on drive C.
Point	To slide the mouse until the tip of the pointer rests on the item of choice.
Program item icon	A graphical representation for program items you can use to start up applications. Program item icons appear in group windows in Program Manager.
Real mode	The operating mode that provides maximum compatibility with previous versions of Windows applications. Real mode is also the only mode available for computers with less than 1MB of extended memory. When operating in real mode, Windows uses only the standard 640K of memory and does not directly access extended memory.
Select	To mark an item by highlighting it with key combinations or by clicking it with a mouse. Selecting does not initiate an action. After selecting an item you choose the action you want to affect the item. For example, you might select a filename and then choose the Delete command to remove the file from a directory. (Contrast with <i>choose</i> .)
Standard mode	The normal operating mode for running Windows. Standard mode provides access to extended memory and also lets you switch among non-Windows applications. To run Windows in standard mode, you must be using a personal computer that has the Intel 80286 processor or higher and at least 1MB of memory.
Window	A rectangular area that contains a software application, or a document file. Windows can be opened and closed, resized and moved. You can open several of them on the desktop at the same time and you can shrink windows to icons or enlarge them to fill the entire desktop.
Windows applications	Applications that were designed for the Windows environment and that will not run without Windows. Windows applications conform to the same conventions for the arrangement and style of menus, the style of dialog boxes, the use of the keyboard and mouse, and so on.



**Part**

**1**

# ***Windows Fundamentals***



# ***Windows Fundamentals***

## **CHAPTERS**

<b>1</b>	<b><i>Getting Started</i></b> .....	<b>5</b>
<b>2</b>	<b><i>Basic Skills</i></b> .....	<b>15</b>
<b>3</b>	<b><i>Program Manager</i></b> .....	<b>77</b>
<b>4</b>	<b><i>File Manager</i></b> .....	<b>99</b>
<b>5</b>	<b><i>Control Panel</i></b> .....	<b>143</b>
<b>6</b>	<b><i>Print Manager</i></b> .....	<b>195</b>

---

---

**Chapter**  
**1**

**Getting Started**

**Installing Windows with Setup** .....7  
    Running Setup ..... 7

**Starting Windows** .....8  
    Windows Operating Modes ..... 9

**Quitting Windows** .....10

**Working with System Messages** .....13

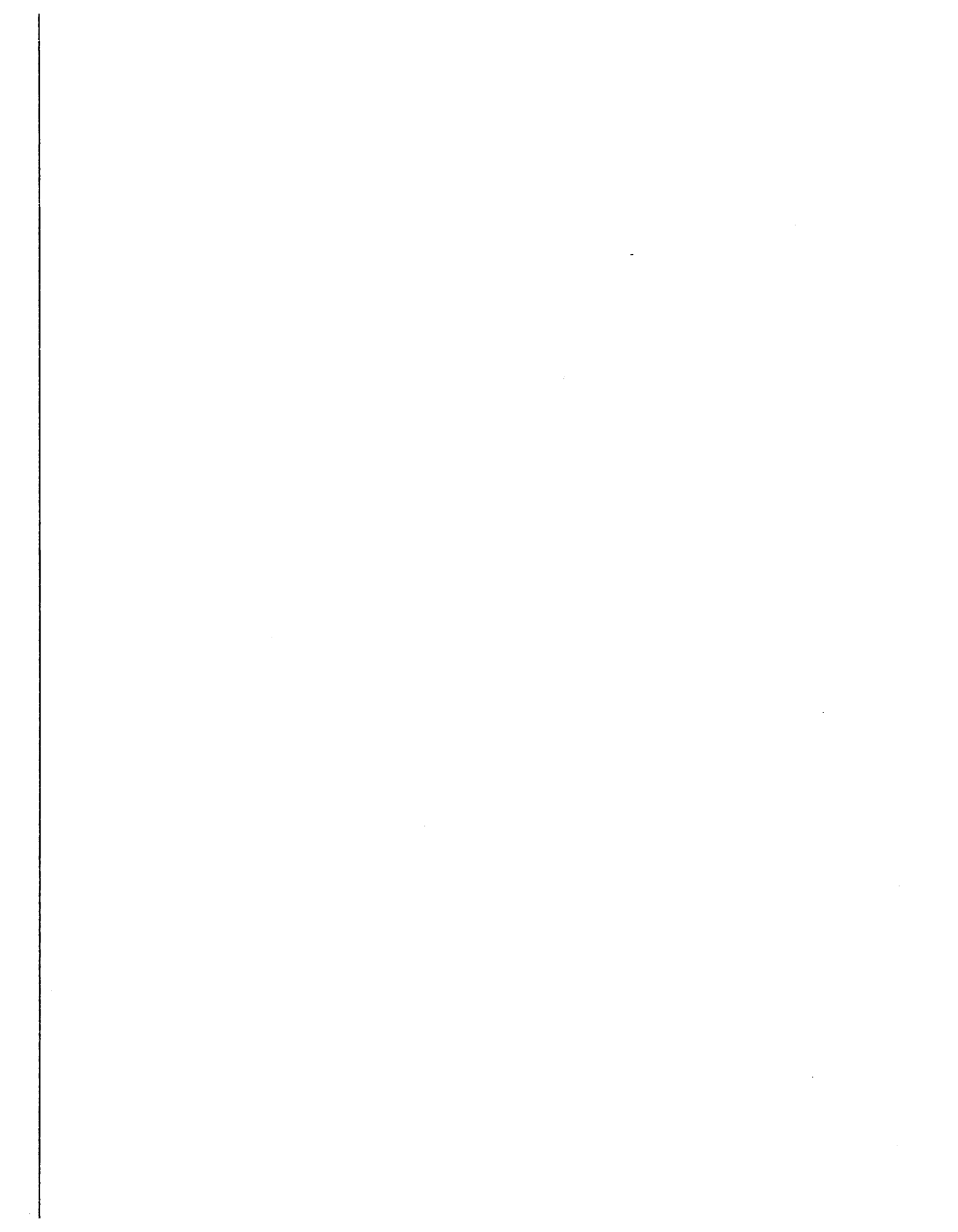

## ***Installing Windows with Setup***

The Setup program on Disk 1 of the Microsoft Windows disk set makes installing the software easy and straightforward. After you type *setup* at the DOS prompt, Setup guides you through the installation. First it evaluates your computer system to determine what kind of equipment you have. Then it copies essential Windows files onto your hard disk, asking you to verify critical information and make changes if necessary.

After this preliminary installation, Setup continues by starting Windows for you, installing the remaining files, and offering you some options—such as choosing and configuring a printer, installing software programs (called *applications* in this *User's Guide*), and viewing on-line documents.

After installation, Setup works just like the other Windows applications. You can run it again anytime to review or change some of the options you originally installed and to add a new piece of equipment or a new application to your system. See Appendix A, “Using Setup to Maintain Windows,” for information about making additions or changes.

## ***Running Setup***

During the Setup procedure, you'll be asked to verify and provide information about the following:

- The directory where you want to store Windows
- The type of computer you are using
- Your monitor
- Your mouse, if any
- Your keyboard and keyboard layout
- Your language
- The kind of network you are on, if any
- The printer and printer port you use, if any
- Applications on your hard disk that you want to run with Windows



### ▷ To install Windows:

1. Put the Windows Disk 1 in the drive you want to use for the installation and close the drive door.  
Windows Setup lets you use any active disk drive.
2. To make the installation drive active, type the drive letter followed by a colon (:), and press ENTER.
3. Type *setup* and press ENTER.
4. Follow the instructions on the screen.

The Setup program's instructions should be self-explanatory. But, if you do have questions about any of the procedures or options, you can request on-line Help by pressing the F1 key.

**NOTE** Do not try to install Windows by copying files directly from the Setup disks. The files are converted into usable files during the Setup process. If you do want to transfer a file directly from a particular Setup disk onto your hard disk, see Chapter 14, "Networks and Windows," for information about the proper procedure.

## Starting Windows

### ▷ To start Windows:

- At the DOS prompt, type *win* and press ENTER.

The very first time you start Windows, the Program Manager window is open with the Main Group window open inside it and the other Windows groups represented as group icons at the lower edge of the Program Manager window as shown in the following illustration.

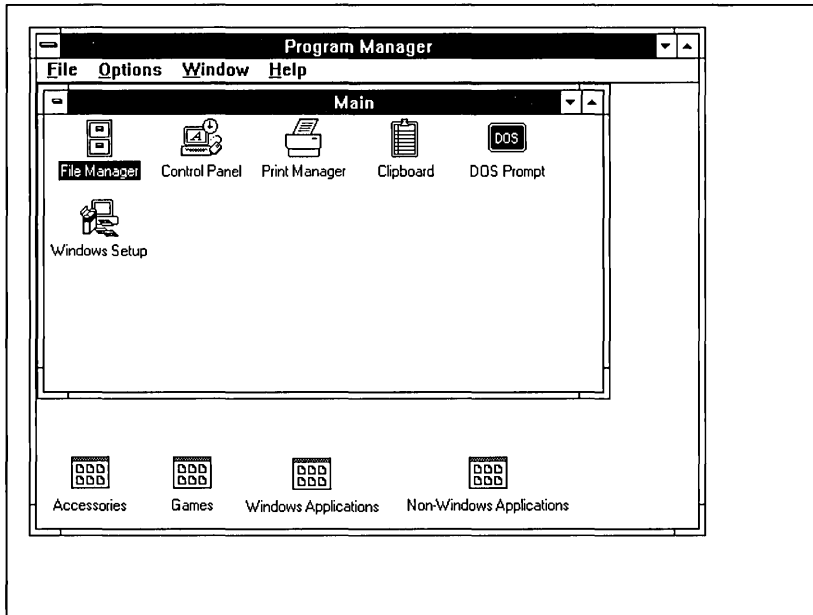

Depending on which applications you installed to run with Windows when you used Setup, the Windows Applications group icon or the Non-Windows Applications group icon might not be shown on your screen.

## Windows Operating Modes

When you type *win*, Windows automatically starts in one of three operating modes. The type of computer system you are using and how much memory it has determines which mode Windows uses. See “What You Need to Run Windows” in the introduction of this *User’s Guide* for the system requirements for each mode.

**NOTE** To discover which mode Windows is using, open the Help menu from the Program Manager menu bar and select About Program Manager. See Chapter 2, “Basic Skills,” to learn about opening menus and selecting items.

You can type an alternate start-up command at the DOS prompt if you want to start Windows in a different mode. For example, if you want to use Windows applications that have not been updated to run with Windows 3.0, you must start

Windows in real mode. See Chapter 11, “Options for Starting Windows,” for instructions. The three modes are defined as follows.

- *Real mode* is the operating mode that provides maximum compatibility with previous versions of Windows applications (2.x versions). If you want to run applications from earlier versions of Windows, unless they are upgraded versions that run with Windows 3.0, you should start Windows in real mode. Real mode is also the only mode available for computers with less than 1 megabyte of memory (640K conventional, 256K extended).
- *Standard mode* is the normal operating mode for running Windows. This mode provides access to extended memory and also lets you switch among non-Windows applications. With access to extended memory, more Windows applications can run at the same time. In addition, applications run faster on systems that have more memory.
- *386 enhanced mode* provides access to the virtual memory capabilities of the Intel 80386 processor. Virtual memory capabilities let Windows applications use more memory than is physically available. 386 enhanced mode also allows for the multitasking of non-Windows applications.

Enhanced mode also gives you greater control over non-Windows applications. For example, instead of running non-Windows applications full-screen, you can run most of them in windows, taking full advantage of the graphical environment.

See Chapter 13, “Optimizing Windows,” for details about memory configurations and Windows operating modes.

## Quitting Windows

You always quit Windows from Program Manager after first quitting the applications you are running.

You can quit Windows from the File menu or from the Control menu. No matter which method you use, Program Manager always asks you to confirm your request to quit and gives you the opportunity to save the current layout of the Program Manager window. If you save the current layout, the next time you start Windows, the same group windows will be open in Program Manager and all group windows, group icons, and program item icons will be in the same positions as they were the last time you used Windows.

▷ **To quit Windows from Program Manager's File menu:**

- Mouse*
1. Quit any applications that are currently running.
  2. Click Program Manager's File menu to open it.

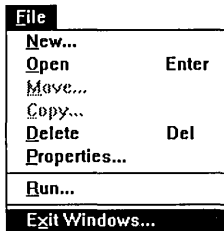

3. Click Exit Windows.  
The Exit Windows confirmation dialog box appears.

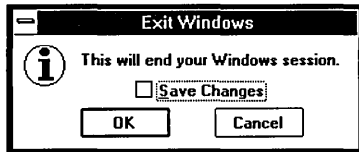

4. If the Save Changes box is empty, click it to enter an X and save the layout of Program Manager as it currently appears. If you do not want to save the current appearance of Program Manager, click the box to clear the X.
5. Click OK to exit Windows.

- Keyboard*
1. Quit any applications that are currently running.  
Press ALT, F to open Program Manager's File menu.
  2. Press X (the underlined letter in Exit).  
Or press DOWN ARROW to move the highlight to Exit Windows and then press ENTER.
  3. The Exit Windows confirmation dialog box appears.  
If the Save Changes box is empty, press TAB to move the selection cursor (a dotted rectangle) to it. Press the SPACEBAR to place an X in the box and save the current layout of Program Manager and its group windows.

## 12 Quitting Windows

---

Press the SPACEBAR again if you want to clear the X and exit Windows without saving the current layout of Program Manager.

4. Press ENTER to choose OK and exit Windows.

You can also exit Windows from Program Manager's Control menu by opening the Control-menu box and selecting Close. The Control-menu box is a small box in the upper-left corner of the Program Manager window.

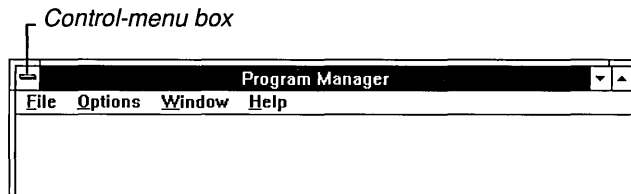

### ▶ To quit Windows from Program Manager's Control menu:

---

- Mouse*
1. Quit any applications that are currently running.
  2. Click the Control-menu box to open the Control menu.

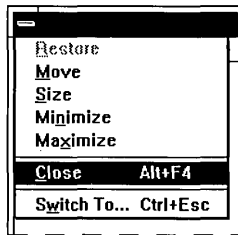

3. Click Close.
4. The Exit Windows dialog box appears. Continue as described in the previous procedure.

**HINT** Double-click the Control-menu box to bypass selecting Close. The Exit Windows dialog box appears immediately.

- Keyboard**
1. Quit any applications that are currently running.
  2. Press ALT, SPACEBAR to open the Control menu. (Pressing ALT closes it again.)
  3. Press the letter C to select Close.  
Or press DOWN ARROW to move the highlight to Close and press ENTER.
  4. The Exit Windows dialog box appears. Continue as described in the previous procedure.

**HINT** Press ALT + F4 to bypass opening the Control menu and selecting Close. The Exit Windows dialog box opens immediately.

**NOTE** As you run Windows, some applications may create temporary files. These filenames generally begin with a tilde character (~) and end with the .TMP extension. Do not delete these files while Windows is running because an application may be using them. If you quit Windows as described in the preceding procedure, any temporary files are automatically deleted. But if you quit Windows in some other way (for example, by turning off your computer while Windows is running), some temporary files may remain. You can safely delete these files as soon as you restart your computer.

## Working with System Messages

Windows displays a message box if it cannot complete a command or if you should know about the possible consequences of a choice you made. As a new feature of Windows 3.0, the message box contains an explanation of what went wrong and, where appropriate, tells you what you can do to fix the problem.

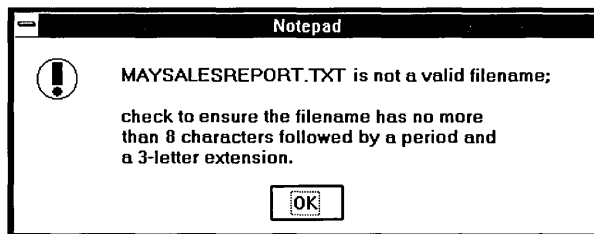

Whenever you are asked to make a choice before you can proceed, the message box contains an OK button and a Cancel button. You can choose OK by pressing ENTER or choose Cancel by pressing ESC.

## **14 Working with System Messages**

---

Some message dialog boxes also include a Retry button. If you use a mouse, click Retry to try the command again. If you use a keyboard, press ALT + R or press TAB to select the Retry command button and then press ENTER.

---

---

**Chapter**  
**2**

**Basic Skills**

**The Basic Elements of Windows** .....17

- Two Kinds of Windows ..... 19
- Parts of a Window ..... 21
- Three Kinds of Icons ..... 23

**Working with Menus** .....25

- Selecting and Canceling Menus ..... 26
- Choosing Menu Commands ..... 27
- Using the Control Menus ..... 28

**Working with Dialog Boxes** .....33

- Moving Dialog Boxes ..... 34
- Moving Within Dialog Boxes ..... 34
- Choosing Options ..... 34
- Canceling Dialog Boxes ..... 41

**Working with a Window** .....41

- Moving Windows, Icons, and Dialog Boxes ..... 41
- Changing the Size of a Window ..... 42
- Using Scroll Bars ..... 47
- Closing a Window ..... 48



<b>Working with Applications</b> .....	<b>49</b>
Running Two or More Applications .....	50
Starting Applications .....	50
Switching Among Application Windows .....	54
Arranging Application Windows and Icons .....	55
Transferring Information Between Applications with Clipboard ..	56
Receiving Messages from Inactive Applications .....	63
Quitting Applications .....	63
<b>Working with Documents</b> .....	<b>64</b>
Opening Documents and Files .....	64
Saving Documents and Files .....	64
Switching Among Document Windows .....	65
Arranging Document Windows .....	65
Working with Text .....	66
<b>Using Windows Help</b> .....	<b>70</b>
Starting Help .....	70
Using the Help Menu .....	71
Finding Information in Help .....	72
<b>Practicing Basic Skills</b> .....	<b>75</b>

# The Basic Elements of Windows

If you are new to Microsoft Windows, this chapter is probably the most important one in the *User's Guide* since it explains the basic concepts and skills you need to work with Windows successfully. You can use this chapter initially to learn how to operate within the Windows environment, and you can return to it later as a reference.

Windows includes all the programs you need to manage your software applications and files easily and efficiently. The following illustration shows the basic structure of Windows' rich graphical environment.

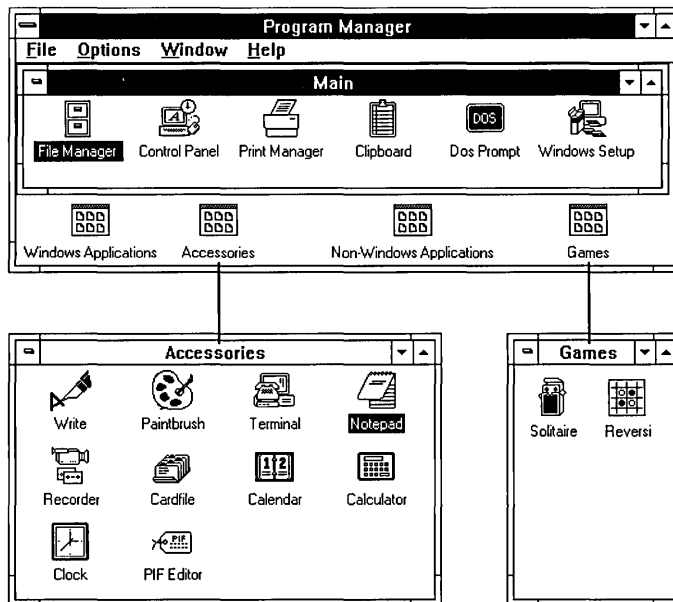

**NOTE** The appearance and contents of the Windows Applications and Non-Windows Applications groups depend on your choices during Setup.

All Windows operations take place within the framework of the *desktop*, the screen space Windows occupies. You can think of this area as you would the surface of an actual desk. You can move work items around on the desk, bring new ones onto it, and remove items you won't need for a while.

The Program Manager application is open on your desktop the first time you start up Windows. Program Manager is central to the operation of Windows. You can organize your applications into groups and start them by using Program Manager.

After you start up an application, it runs in an *application window* on the desktop. If you are running several applications at a time, you can shrink as many application windows as you'd like to *application icons*. By shrinking these windows to icons, you can clear some space on your desktop without exiting the running applications.

The following illustration shows applications that are running in windows and applications that are running as icons on the desktop. A complete discussion of starting, running, and exiting applications follows later in this chapter.

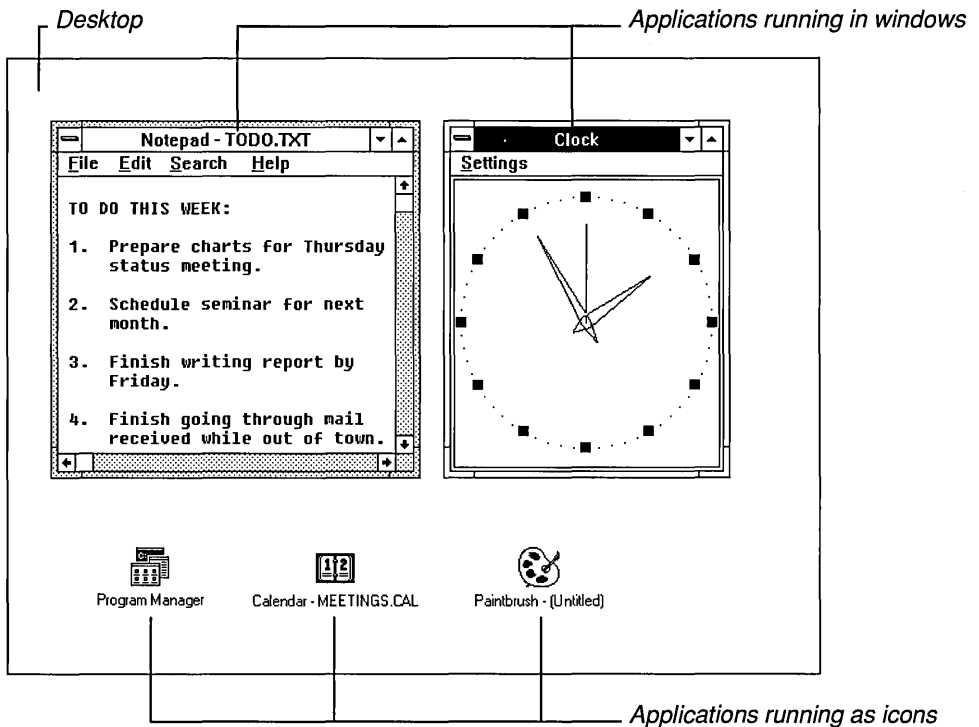

## Two Kinds of Windows

As you work with applications, two different kinds of windows appear on your desktop: application windows and document windows.

- *Application windows* contain running applications. The name of the application, the associated document, and the application's menu bar appear at the top of the application window. Application windows can be positioned anywhere within the desktop borders.

In 386 enhanced mode, most non-Windows applications can run in application windows, while others require the entire screen. In standard mode and in real mode, all non-Windows applications occupy the entire desktop instead of running inside application windows.

The following is an example of an application window.

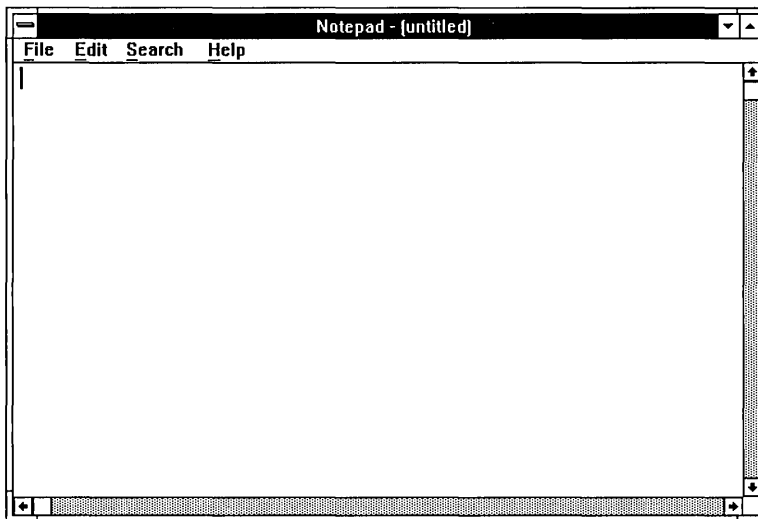

- *Document windows* appear only with applications that can open two or more documents at a time inside the same workspace. For example, with Windows File Manager you can open a number of directories at the same time. Each directory appears in a separate document window (called a *directory window*) in the File Manager workspace.

Being able to open more than one document at a time inside an application's workspace makes working with a number of documents easy.

Document windows share the application window's menu bar. Commands that affect the application affect the document as well.

Document windows have their own title bars unless they are maximized. When maximized, they fill the application workspace and share the application window's title bar. The document name follows the name of the application on a shared title bar.

Program Manager is another example of an application that lets you open several document windows (called *group windows*) in its application workspace.

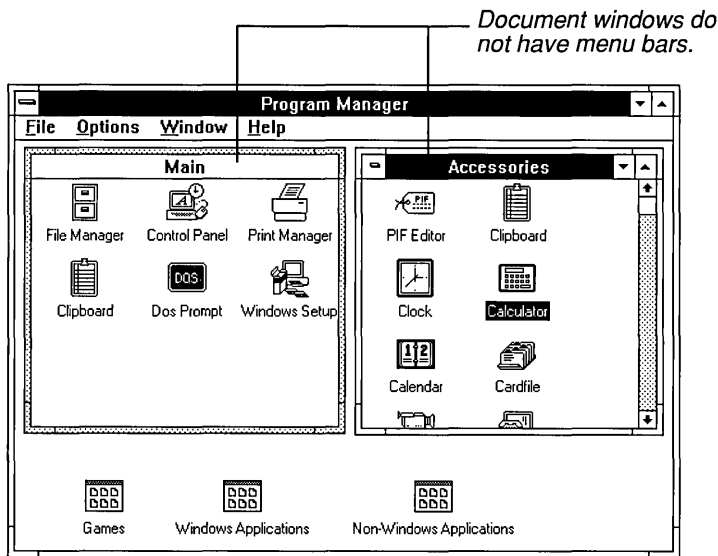

If you are working with a mouse, there is no difference in the procedures you use to manipulate application and document windows. If you prefer to use the keyboard, however, the keystrokes required to use the Control menu and to switch between document windows are different for each type of window.

The instructions in this guide note procedural differences where they exist. In addition, on-line Help provides summaries of the appropriate keystrokes whenever you see the Keyboard category on a Help menu.

## Parts of a Window

Each application and some documents you choose to work with open as separate *windows*. Every window has some common elements; however, not all windows use all the elements.

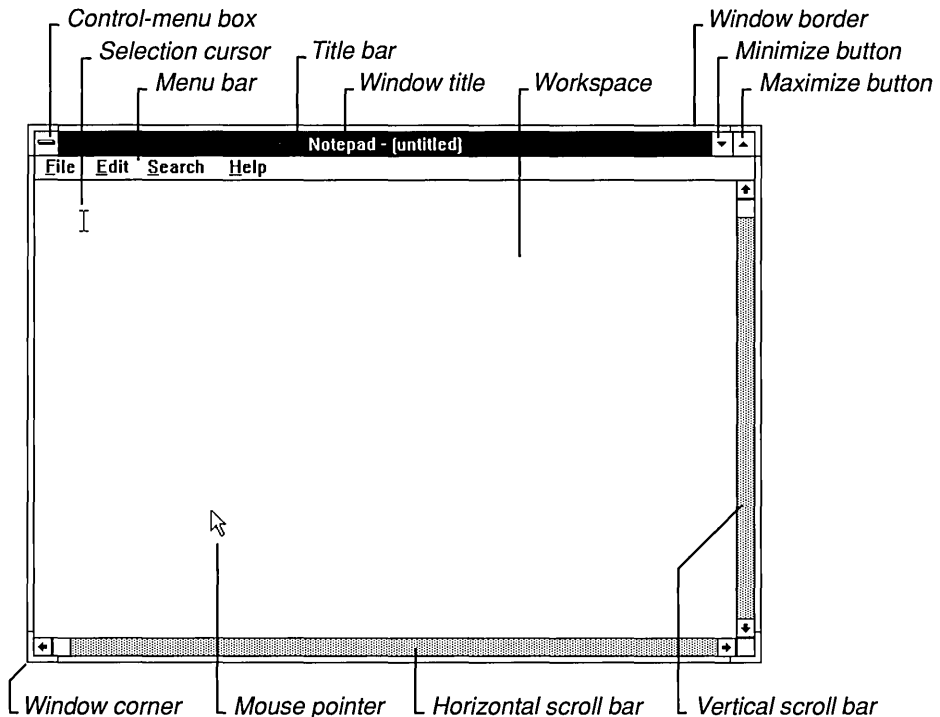

The elements in the preceding illustration are your tools for working with the window and the application or document within the window. You'll learn more about how to use the elements throughout this chapter.

- The *Control-menu box* is located in the upper-left corner of each window. The Control menu (also called the *System menu*) is most useful if you prefer to use your keyboard when you work with Windows. With Control-menu commands, you can resize, move, maximize, minimize, and close windows, and switch to Task List. (If you use a mouse, you can move, resize, minimize, maximize, and close windows simply by clicking and dragging.)

- The *title bar* shows the name of the application or document. If more than one window is open, the title bar for the *active* window (the one in which you are working) is a different color or intensity than other title bars.
- The *window title*, depending on the type of window it appears in, can be the name of an application and the name of a document, or the name of a group, a directory, or other data file. For documents, until the document is saved, a placeholder such as (*untitled*) usually appears.
- The *menu bar* lists the available menus. Most applications have a File menu, an Edit menu, and a Help menu as well as menus unique to the application.
- *Scroll bars* let you move parts of a document into view when the entire document won't fit in the window. They also let you view unseen portions of lists and other information that is too long to fit in the allotted space.
- The *Maximize* and *Minimize buttons* (chosen with the mouse) enlarge the active application window to fill the entire desktop or shrink the window to an icon. Document windows enlarge to fill the application workspace only, not the entire desktop. After you enlarge a window, the Maximize button changes to a Restore button. You can use the Restore button to return the window to its previous size.
- The *window border* is the outside edge of a window. You can lengthen or shorten each side of a border.
- The *window corner* can be used to shorten or lengthen two sides of a border at the same time.
- The *workspace* is where you do most of your work with an application. For example, if you start a word processor, the contents of your document appear in the workspace. Some applications allow you to open more than one document window within this workspace.
- The *selection cursor* shows where you are in an individual document. It marks the place text or graphics appears when you begin typing or drawing.
- The arrow-shaped *mouse pointer* appears if you have a mouse installed. You use it to indicate items you want to select or choose with the mouse.

**NOTE** Some applications might use different types of cursors and pointers than the ones shown in the previous illustration.

## Three Kinds of Icons

Icons are used in the Windows graphical environment to represent applications that are running minimized, document windows that are minimized, and applications you can start.

- *Application icons* appear only after you start up an application and choose the Minimize command for that application. The application shrinks from window size to an application icon and continues to run minimized at the bottom edge of your desktop. Application icons are the only icons that appear on the desktop outside the window borders.

You can move application icons anywhere on the desktop, but not into an open window. Even though Windows will let you physically place an application icon in an open window, the icon is actually still occupying space on the desktop. If you move the window, the application icon does not move with it, and if you close the window, the application icon remains on the desktop.

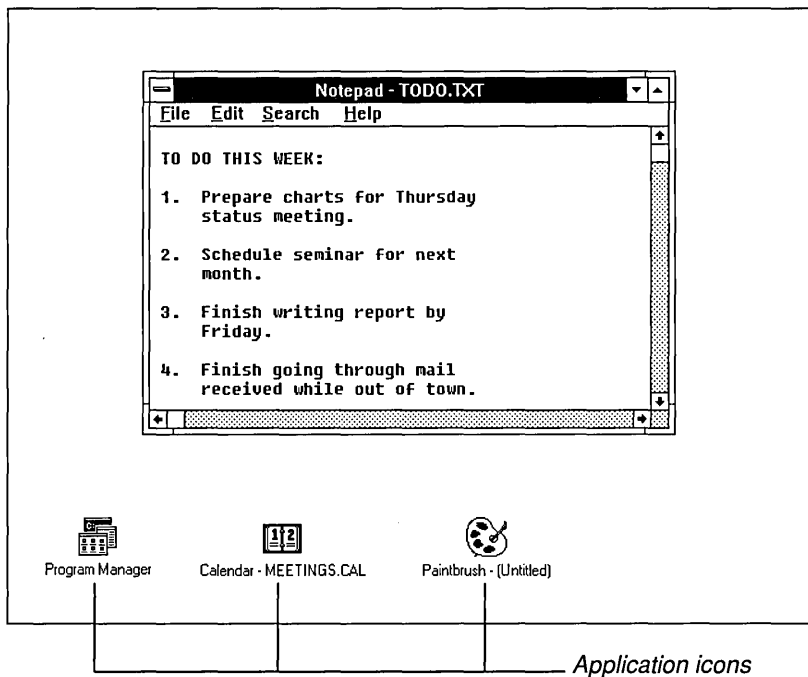

Most application icons resemble the program item icons that start their applications.



- *Document icons* represent document windows that are minimized. Document icons appear at the bottom of the application window and can be moved anywhere within the application's workspace, but not outside its borders.

Notice in the following illustration that the document icons for Program Manager groups look the same. Only the labels that identify them are different.

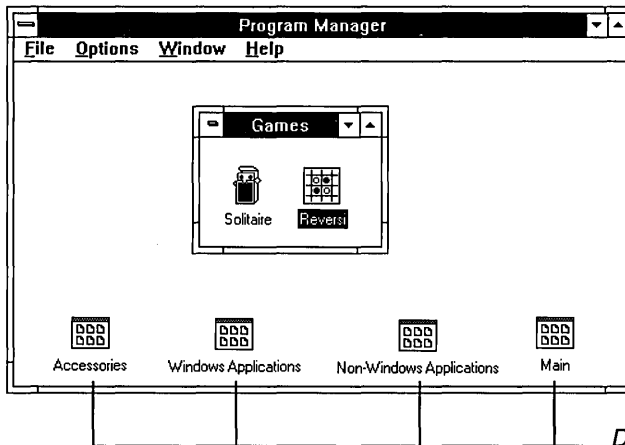

When you choose a document icon, it opens into a document window. For Program Manager, it contains program item icons. For File Manager, document windows contain directories. The contents of a document window depend on its application.

- *Program item icons* are exclusive to the Program Manager application. They represent the applications and their associated documents you can start up from Program Manager. They are contained in document windows called group windows. These icons can be moved between group windows and from group windows to group icons, but not out of the Program Manager window.

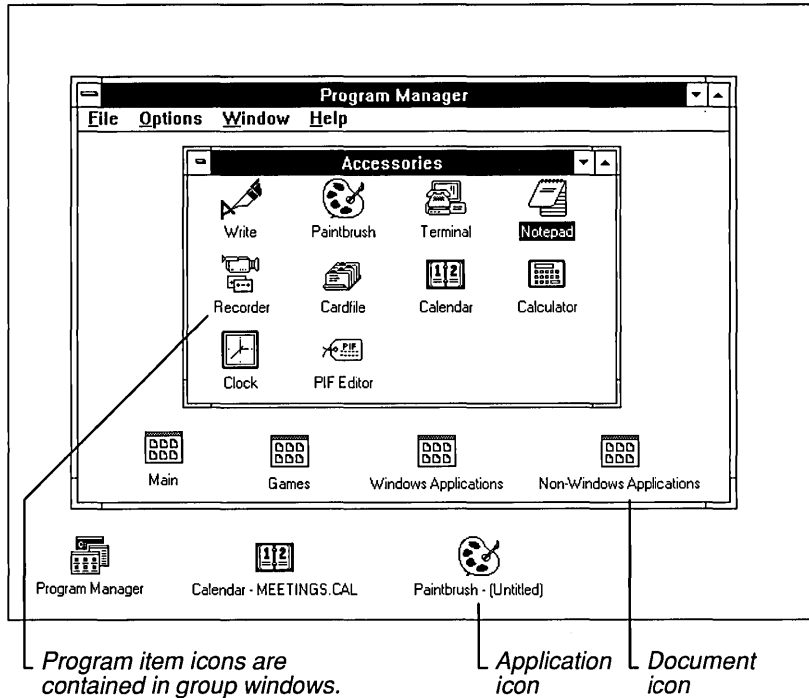

Most program item icons are easy to distinguish from one another at a glance since most of them are unique graphics. However, icons for many non-Windows applications are identical. Also, when you include a document to start with an application, the new program item icon you create is identical to the existing program item icon for the application. So, a group window could contain several identical program item icons distinguished only by their labels.

**NOTE** Individual applications, such as File Manager and Control Panel, also use a variety of icons that are related to their unique activities. Each icon is described in the appropriate chapters.

## Working with Menus

Windows commands are listed on *menus*. Each application has its own menus, with a Control menu common to all applications. The Control menu, also called the System menu, opens from the small box in the upper-left corner of each window. Other menus are represented by names in the menu bar at the top of each application window.

In Windows, you select a menu, and then choose a command from that menu. Choosing the command carries out the action.

## Selecting and Canceling Menus

### ▷ To select a menu:

**Mouse** □ Point to the name of the menu on the menu bar and click the name to open the menu. (You can drag the selection cursor down the menu if you want to move to a menu item immediately.)

- Keyboard**
1. Press ALT (or F10) to select the menu bar.
  2. Press LEFT ARROW or RIGHT ARROW to select the menu you want. (Using the DIRECTION keys also selects the Control-menu box for the application and the active document window.)
  3. Press ENTER to open the selected menu.

**HINT** If the menu names have underlined letters, you can move to the menu bar, select a menu, and open it with one step. Press ALT, and then press the underlined letter. For example, to open Program Manager's File Menu, press ALT, F.

If more than one menu name has the same underlined letter, Windows selects the first name listed. Press ALT, then the letter again to select the next menu.

### ▷ To cancel a menu:

- Click the menu name or anywhere outside the menu.
  - Or press ALT (or F10) to cancel the menu and move back to the application workspace.
  - Or press ESC to cancel the menu but remain on the menu bar so that you can select another menu.

## Choosing Menu Commands

Let's take a look at some typical Windows menus:

File	
<u>N</u> ew...	
<u>O</u> pen	Enter
<u>M</u> ove...	
<u>C</u> opy...	
<u>D</u> elete	Del
<u>P</u> roperties...	
Run...	
Exit Windows...	

Edit	
<u>U</u> ndo	Alt+BkSp
<u>C</u> ut	Shift+Del
<u>C</u> opy	Ctrl+Ins
<u>P</u> aste	Shift+Ins
<u>D</u> elete	Del
Select All	
<u>T</u> ime/ <u>D</u> ate	F5
<u>W</u> ord Wrap	

View	
<u>Z</u> oom <u>I</u> n	Ctrl+Z
<u>Z</u> oom <u>O</u> ut	Ctrl+O
<u>V</u> iew <u>P</u> icture	Ctrl+C
<input checked="" type="checkbox"/> <u>T</u> ools and <u>L</u> inesize	
<input checked="" type="checkbox"/> <u>P</u> alette	
<u>M</u> ouse Position	

The items listed on menus are most often commands that represent actions you can tell the application to carry out. But they can also be characteristics you assign to graphics or text (such as bold or centered), a list of open windows or files, or the names of *cascading* menus, which are menus that list more commands. No matter which items you want to choose, you use the same procedure.

### ▷ To choose an item from a selected menu:

- Click the item name.

Or type the underlined letter in the item name. You can also use the UP and DOWN ARROW keys to select the item you want; then press ENTER.

If you look again at the menus in the preceding illustration, you'll notice that some items appear dimmed, two have checkmarks next to them, several have ellipses (...) after their names, and others have key combinations listed across from them.

Windows applications all follow certain conventions when listing items on a menu. These conventions signal that extra information about the menu commands follows.

<u>Menu convention</u>	<u>What it means</u>
Dimmed command name	The command is not available at this time. You might have to select something before you can use the command, or it might be that the command cannot be used with your application.
An ellipsis (...) after the name	A dialog box will appear when the command is chosen, asking for information the application needs to carry out the command.
A checkmark ( ✓ ) next to the name	The command is active. This convention is used for commands that <i>toggle</i> between one state and another.
A key combination after the name	The key combination shown is a <i>shortcut</i> for this command. Use this key combination to choose the menu command without first opening the menu.
A triangle ( ▶ ) at the right side of a menu command	The command leads to a <i>cascading menu</i> , which lists additional commands that are available.

## ***Using the Control Menus***

Application windows, application icons, document windows, group icons, and some dialog boxes have Control menus (also called System menus).

You open the Control menu for application windows, document windows, and dialog boxes by choosing the Control-menu box from the upper-left corner of the window or dialog box. Control menus for icons open directly above the selected icon.

The Control menus for application windows, document windows, and dialog boxes are somewhat different, as are the Control menus for non-Windows applications. The following section describes how you work with Control menus in all these environments.

### ***Opening the Control Menu***

The procedure you use to open the Control menu depends on whether you are working in an application window, a document window, a dialog box, or with an icon.

▶ **To open the Control menu for an application or an application icon:**

**Mouse** □ Click the Control-menu box in the upper-left corner of the window or click the icon.

Be careful not to double-click, or you will close the window or restore the icon to a window.

- Keyboard**
1. Press ALT + ESC repeatedly to cycle through the open application windows and icons until you reach the one you want.
  2. Press ALT, SPACEBAR to open the Control menu. (Press ALT if you want to close the menu without choosing a menu item.)

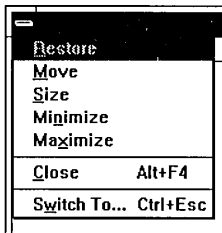

▶ **To open the Control menu for a document window or document icon:**

**Mouse** □ Click the Control-menu box in the document window or click the document icon.

- Keyboard**
1. Press CTRL + F6 (or CTRL + TAB) repeatedly to cycle through the open document windows and document icons until you reach the one you want.
  2. Press ALT, HYPHEN (-) to open the Control menu. (Press ALT if you want to close the menu without choosing a menu item.)

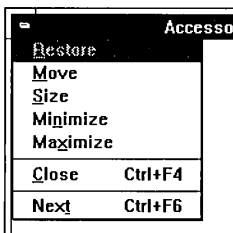

▷ To open the Control menu for a dialog box:

---

- Click the Control-menu box in the dialog box.  
Or press ALT, SPACEBAR. (Press ALT to close the menu without choosing a menu item.)

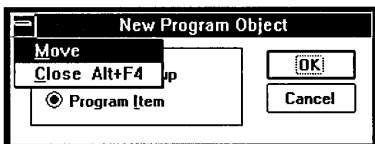

Non-Windows applications running in standard mode or in real mode do not run in application windows, but occupy the entire screen. You can open their Control menus only by switching back to Windows, thereby shrinking the non-Windows application to an icon. The Control menu is available from the application icon.

**HINT** To find out which mode Windows is running in, open Program Manager and choose the About Program Manager command from the Help menu.

▷ To open Control menus for standard or real mode, non-Windows applications:

---

1. Press ALT + ESC to switch from the running application back to Windows. The non-Windows application appears as an application icon at the lower edge of the Windows desktop.
2. Click the icon with the mouse to open the Control menu.  
Or press ALT + ESC to select the icon you want, and then press ALT, SPACEBAR to open the Control menu.

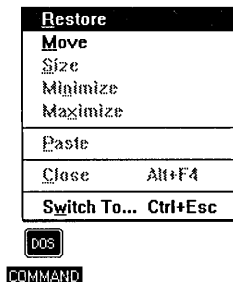

**386**

Control menus for non-Windows applications that are running in 386 enhanced mode are available from application windows (for applications that can run in Windows) and from application icons (for applications that must run full-screen).

▷ **To open the Control menu for a 386 enhanced mode non-Windows application:**

- Mouse** □ Click the Control-menu box in the upper-left corner of the window or click the icon.

Be careful not to double-click, or you will close the window or restore the icon to a window.

- Keyboard**
1. Press ALT + ESC repeatedly to cycle through the open application windows and icons until you reach the one you want.
  2. Press ALT, SPACEBAR to open the Control menu. (Press ALT if you want to close the menu again without choosing a menu item.)

**NOTE** The Control menu for a non-Windows application that you are running in 386 enhanced mode includes a cascading menu for the Edit command. With the mouse, you open the cascading menu by clicking Edit. With a keyboard, you open the cascading menu by pressing RIGHT ARROW (or ENTER).

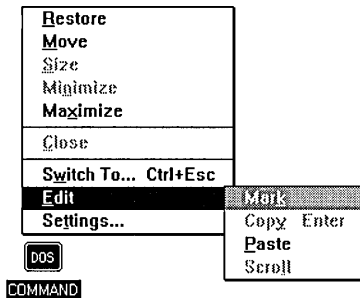



## ***Control-Menu Commands***

The following table defines the Control-menu commands. Not all applications use all of these commands.

<u>Command</u>	<u>Action</u>
Restore	Restores the window to its former size after it has been enlarged (by using the Maximize command) or shrunk to an icon (by using the Minimize command).
Move	Allows you to use the keyboard to move the window to another position on the desktop.
Size	Allows you to use the keyboard to change the size of the window.
Minimize	Shrinks the window to an icon.
Maximize	Enlarges the window to its maximum size.
Close	Closes the window.
Switch To...	Starts Task List, which lets you switch among running applications and rearrange their windows and icons on your desktop.
Next	Switches among open document windows and icons. (Available for document windows only.)
Paste	Copies text from the Clipboard to the active document window, inserting the text at the Windows cursor position. (Available in real and standard modes only.)
<b>386</b> Edit	Displays a cascading menu with four additional commands. (Available for non-Windows applications running in 386 enhanced mode only.)

<u>Command</u>	<u>Action</u>
Mark	Allows you to use a keyboard to select text to move onto the Clipboard, a temporary storage location in memory.
Copy	Copies the selected text onto the Clipboard.
Paste	Copies text from the Clipboard to the active window, inserting it at the Windows cursor.
Scroll	Allows you to view information not currently visible in the window.

Command	Action
386 Settings	Displays a dialog box that requests information about multi-tasking options such as foreground or background operation, or about allocation of system resources when running the application. See Chapter 12, “More About Applications,” for information about these options. (Available for non-Windows applications running in 386 enhanced mode only.)

## Working with Dialog Boxes

Windows uses *dialog boxes* to request information from you and provide information to you. For example, when Windows needs additional information to carry out a command you have chosen, a dialog box requests that information. You complete the dialog by providing the missing information.

Whenever you see an ellipsis (...) after a menu command, a dialog box follows. For example, when you choose Open... from the Notepad File menu, Notepad displays the File Open dialog box asking for the filename of the file you want to open.

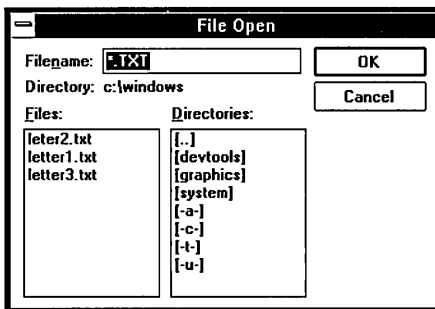

Windows also uses dialog boxes to display additional information and warnings, or to explain why a requested task could not be accomplished.

Most dialog boxes contain options, each one asking for a different kind of information. After you supply all the requested information, you choose a command button to carry out the command.

## Moving Dialog Boxes

Dialog boxes that have title bars can be moved around on your desktop like windows. See “Working with a Window” later in this chapter to learn how to move a dialog box.

## Moving Within Dialog Boxes

Often you need to move around within a dialog box to make several selections. The current option is marked by a highlight or dotted rectangle (or both) around the name of the option or button.

### ▷ To move within a dialog box:

- Mouse*    □ Click the option or group you want to move to.
- Keyboard*    1. Press TAB to move forward (generally from left to right and top to bottom) or SHIFT + TAB to move in the opposite direction.  
Or, while you hold down ALT, you can type the underlined letter in the option name or group name.
2. Within a group of options, use the DIRECTION keys to move from one option to another.

## Choosing Options

The next few sections describe each kind of dialog box option and how to move to and select options.

### **Command Buttons**

*Command buttons* initiate an immediate action. One command button in each dialog box carries out the command you choose, using the information supplied in the dialog box. Other command buttons let you cancel the command or choose from additional options.

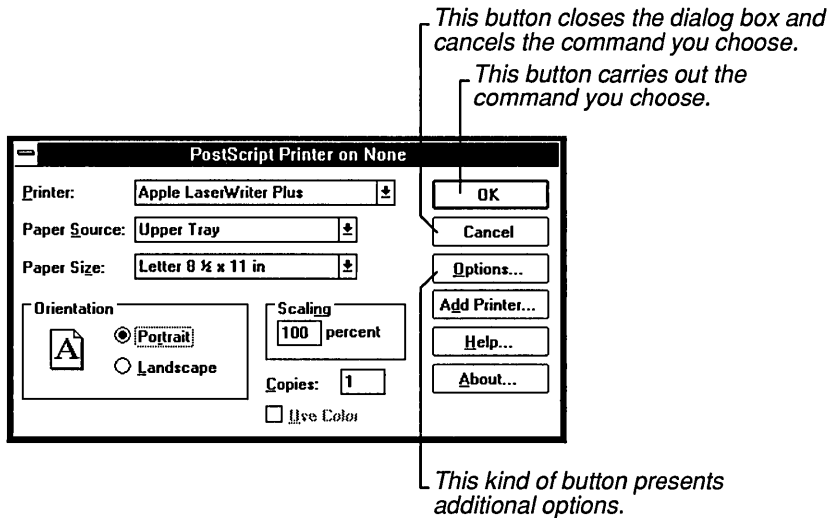

Command buttons marked with an ellipsis (...) open another dialog box so you can provide more information. Command buttons marked with a pair of greater-than symbols (>>) expand the current dialog box. For example, the Color dialog box in Control Panel has a button labeled *Color Palette>>* that expands the Color dialog box to show you new options for changing the colors of many of the elements on your desktop.

Buttons that are unavailable are dimmed. The currently selected, or default, button has a darker border than the other buttons. You can choose the selected button by pressing ENTER.

You can close the dialog box without completing a command by choosing Cancel.

### ► To choose a command button:

**Mouse** □ Click the command button.

- Keyboard**
1. Press TAB to move to the command button you want.  
A dotted rectangle around the button text marks the selected button.
  2. Press the SPACEBAR (or ENTER) to choose the button and complete the command.

**HINT** If the button has an underlined letter in its name, you can choose the command button in one step. Hold down ALT and press the underlined letter.

## Text Boxes

A *text box* is a rectangle into which you type information.

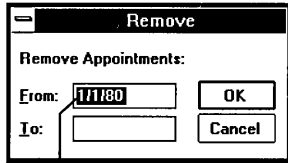

You type information into text boxes.

When you move to an empty text box, an *insertion point* (flashing vertical bar) appears at the far left side of the box. The text you type starts at the insertion point.

If the box already contains text when you move to it, all the text in the box is automatically selected and any text you type replaces it. Or, you can erase the existing text by pressing DELETE or BACKSPACE. See “Working with Text” later in this chapter for text editing procedures.

### ▷ To select text in a text box:

- Mouse** □ Drag the pointer across the text you want to select. Or you can double-click to select one word at a time.
- Keyboard**
1. Use the DIRECTION keys to move to the first character you want to select in the box.
  2. Hold down SHIFT and press a DIRECTION key to extend the selection. (Press SHIFT + HOME to extend the selection to the first character in the box. Press SHIFT + END to extend the selection to the last character in the box.)
- See “Selecting Text” in “Working with Documents” later in this chapter for other keyboard selection options and the editing options available for selected text.

## List Boxes

A *list box* shows a column of available choices. If there are more choices than can fit in the list box, scroll bars are provided so that you can use your mouse to move up and down quickly through the list. See “Using Scroll Bars” later in this chapter if you need detailed instructions about scrolling.

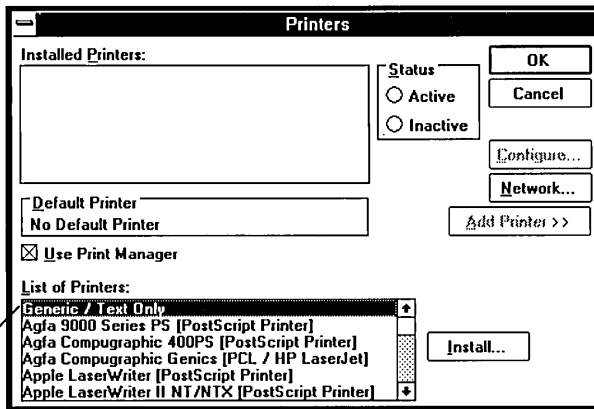

List boxes present available choices.

Usually, you can select only one item from the list, but some list boxes (such as the box that lists applications you can install with Windows Setup) let you select multiple items if appropriate.

### ▷ To select a single item from a list box:

#### *Mouse*

1. Click the scroll arrows until your choice appears in the list box.
2. Click the item you want to select and then choose the command button you want. Or double-click the item to choose it and complete the command.

#### *Keyboard*

1. Use the DIRECTION keys to scroll to the item you want.  
Or type the first letter of the item you want. Windows moves the highlight to the first item that starts with that letter.
2. Press ENTER to choose the item and complete the selected command.

**NOTE** To change your selection, simply select a different item before choosing the command button.

If an application lets you select more than one item in a list box, the selection process works like a toggle switch, turning the selection on or off. You can select as many items as you want and also cancel any selections.

▷ To select more than one item in a list box:

**Mouse** □ Click each item you want to select.  
To cancel a selection, click the item again.

**Keyboard** 1. Use the DIRECTION keys to move the highlight to the first item you want.  
2. Press the SPACEBAR to select the item. To cancel the selection, press the SPACEBAR again.  
Repeat steps 1 and 2 until all the items you want are selected.

**NOTE** With some applications you can use other key combinations to extend a selection to items that follow sequentially in a list box. See the application’s reference manual for instructions.

### Drop-Down List Boxes

A *drop-down list box* appears initially as a rectangular box with the current choice (default) highlighted in the box. The arrow in a square box at the right opens into a list of available choices when you select it. If there are more choices than can fit in the drop-down list box, scroll bars are provided.

Drop-down list boxes are typically used in dialog boxes that are too small or too crowded to contain open list boxes.

*Drop-down list boxes open to show available choices.*

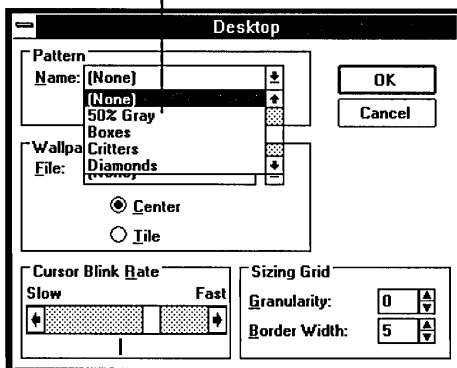

▶ To open a drop-down list box and select an item:

- Mouse**
1. Click the arrow at the right of the box to open the drop-down list box.
  2. Click the Up or Down scroll arrow or drag the scroll box to move to the item you want.
  3. Click the item.

- Keyboard**
1. Press ALT + DOWN ARROW to open the drop-down list box.
  2. Use the UP or DOWN ARROW key to reach the item you want, and press ALT + UP ARROW or ALT + DOWN ARROW to select the item.

## Option Buttons

*Option buttons* appear in dialog boxes as a list of mutually exclusive items. You can select only one option from the list at a time. You can change a selection by selecting a different button.

The selected option button contains a black dot. Unavailable options are dimmed.

*Options buttons present mutually exclusive options.*

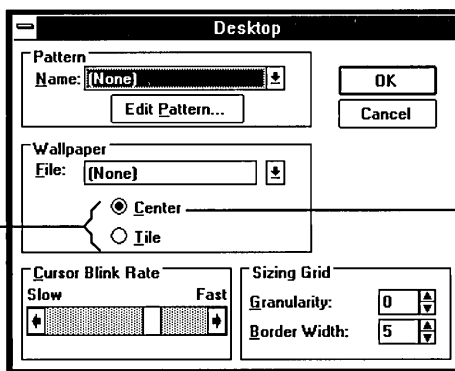

*This option is selected.*



▷ To select an option button:

**Mouse** □ Click the option button.

- Keyboard**
1. Press TAB to move into the option group you want.
  2. Use the DIRECTION keys to select the option button you want.

**HINT** If the option name contains an underlined letter, you can hold down ALT and press the underlined letter from anywhere in the dialog box to select an option button.

### Check Boxes

Check boxes offer a list of options you can switch on and off. You can select as many or as few check box options as are appropriate. When an option in a check box is selected, it contains an X. Otherwise, the box is empty. Names of options that are temporarily unavailable are dimmed.

*Check boxes present nonexclusive options.*

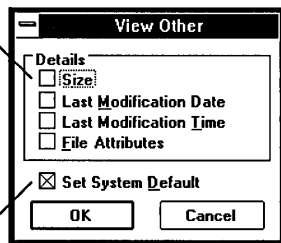

*This option is selected.*

▷ To select or clear check box options:

**Mouse** □ Click each empty check box you want to select.  
Click a selected box again to clear the selection.

- Keyboard**
1. Press TAB to move to the empty check box you want to select.
  2. Press the SPACEBAR to enter an X. Press the SPACEBAR again if you want to clear the selection.

**HINT** If the check-box name has an underlined letter, hold down ALT and press the underlined letter for each check box you want to select or clear.

## Canceling Dialog Boxes

When you choose a command button, the dialog box closes and the command takes effect.

### ▷ To close a dialog box without completing the command:

- Choose Cancel.

Or double-click the Control-menu box.

Or press ESC.

For dialog boxes that do not have Cancel buttons, choose the Close command (press ALT + F4) from the Control menu. For dialog boxes that do not have Cancel buttons or Control menus, choose the appropriate button.

## Working with a Window

Whenever you work with applications and documents, you'll probably have a number of different windows open on your desktop. This section explains how to move windows, dialog boxes, and icons; how to resize windows; how to scroll through their contents; and how to arrange them on the desktop.

## Moving Windows, Icons, and Dialog Boxes

You can move application windows, document windows, and icons to different places on your desktop. You can also move any dialog box that has a title bar.

### ▷ To move a window, icon, or dialog box:

- Mouse*
1. Drag the window's title bar, the icon, or the dialog box title bar to the new location.

As you move the mouse pointer, an outline of the window or dialog box moves with it. For an icon, the mouse pointer changes to a black and white outline of the icon that moves as you slide the mouse.

2. When the window, icon, or dialog box is positioned where you want it, release the mouse button.

You can press ESC anytime before you release the mouse button to cancel the move.

- Keyboard**
1. Select the window, icon, or dialog box you want to move.

Press ALT + ESC to cycle through the application windows and icons until you reach the one you want.

Press CTRL + F6 (or CTRL + TAB) to cycle through document windows and icons.

2. Open the Control menu.

Press ALT, SPACEBAR for an application window, icon, or dialog box.

Press ALT, HYPHEN (-) for a document window or icon.

3. Choose the Move command.

The pointer changes to a four-headed arrow.

4. Press the DIRECTION keys to move the window, icon, or dialog box.

An outline of the window or dialog box moves as you press the DIRECTION keys.

5. When the window, icon, or dialog box is where you want it, press ENTER.

You can press ESC anytime before you press ENTER to cancel the move.

## Changing the Size of a Window

Sometimes you might want to change the size and shape of the windows open on your desktop. For example, to compare the contents of two documents, you could reduce the size of each window so that they fit side by side.

You can change the size and shape of most windows on your desktop. If you are using a mouse, you can drag each side of the window border or its corners to adjust its size. If you are using the keyboard, the commands on the Control menu let you modify the window's size and shape.

**NOTE** The minimum size for all windows is about 2 inches by 1 inch. In addition, some application windows are limited in the ways their size can be changed. For example, Control Panel has a fixed size.

▷ **To change the size of a window:**

- Mouse**
1. Select the window you want to resize.
  2. Point to a border or corner that you want to move.  
The pointer changes to a two-headed arrow.
  3. Drag the corner or border until the window is the size you want.  
If you drag a border, the window size changes on only one side, the side of the border you drag. If you drag a corner, the two adjoining sides that form the corner change size at the same time.  
An outline shows the size and shape you selected.
  4. Release the mouse button.

- Keyboard**
1. Select the window you want to resize.  
Press ALT + ESC to cycle through the application windows and icons until you reach the one you want.  
Press CTRL + F6 (or CTRL + TAB) to cycle through document windows and icons.
  2. Open the Control menu.  
For an application window, press ALT, SPACEBAR.  
For a document window, press ALT, HYPHEN (-).
  3. Choose the Size command.  
The pointer changes to a four-headed arrow.
  4. Press one of the DIRECTION keys to move the pointer to the border you want to move.
  5. Press a DIRECTION key to move the border.  
An outline shows the size and shape as you change it.
  6. Press ENTER when the window is the size you want.

If you want to change the size both horizontally and vertically, after choosing the Size command, press two DIRECTION keys simultaneously to select a corner of the window. (UP ARROW + RIGHT ARROW, for example, selects the top-right corner of the window. Then press RIGHT ARROW to stretch the window to the right and UP ARROW to stretch the window toward the top of the desktop until the window is the size you want. Press ENTER to complete the resizing. )

**HINT** You can cancel the resizing. With a mouse, press ESC before you release the mouse button. With the keyboard, press ESC before you press ENTER.

## Shrinking a Window to an Icon

You can shrink a window to an icon when you finish working with an application or document window, but want it available for later use. When you shrink an application window to an icon, the application is still running in memory, but its window is not taking up space on your desktop.

You can select and move icons on your desktop in the same way you select and move windows. When you want to work with your application or document in a window again, you can double-click the icon to restore the window (or use the Maximize or Restore command on the Control menu).

### ▷ To shrink a window to an icon:

- Mouse**
1. Select the window you want to shrink.
  2. Click the Minimize button in the upper-right corner of the window.

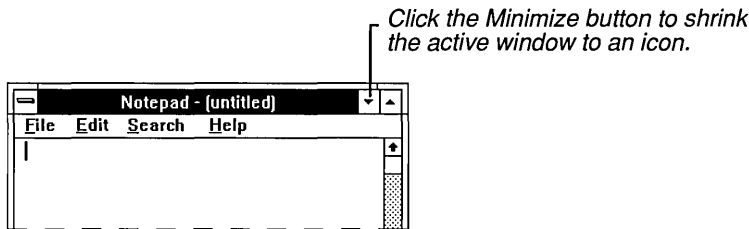

- Keyboard**
1. Select the window you want to shrink.  
Press ALT + ESC to cycle through the application windows and icons until you reach the window you want.  
Press CTRL + F6 (or CTRL + TAB) to cycle through document windows and icons.
  2. Open the Control menu.  
For an application window, press ALT, SPACEBAR.  
For a document window, press ALT, HYPHEN (-).
  3. Choose Minimize.

**NOTE** Before you use the Minimize button to shrink a document window that is enlarged, you must restore it to its previous size. When you enlarge a document window it fills the application window, covering other document windows and icons. The document's name

appears after the application's name on the title bar. The Maximize and Minimize buttons affect the application window and all its contents. Only the Restore button affects the document window alone. You can, however, shrink an enlarged document window to an icon by choosing Minimize from the document's Control menu.

## ***Enlarging a Window***

You can enlarge the windows of most applications to fill a larger portion of the desktop or even the entire desktop.

A document window can be enlarged to fill all of an application window except the menu bar space. You cannot enlarge a document window beyond the boundaries of its application window.

### **► To enlarge a window to its maximum size:**

- Mouse**
1. Select the window you want to enlarge.
  2. Click the Maximize button in the upper-right corner of the window.

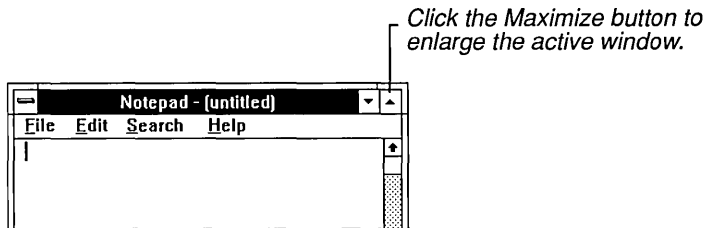

- Keyboard**
1. Select the window you want to enlarge.  
Press ALT + ESC to cycle through the application windows and icons until you reach the one you want.  
Press CTRL + F6 (or CTRL + TAB) to cycle through document windows and icons.
  2. Open the Control menu.  
For an application window, press ALT, SPACEBAR.  
For a document window, press ALT, HYPHEN (-).
  3. Choose Maximize.

The window enlarges to its maximum size and the Maximize button is replaced by the Restore button. The title bar of a maximized document window is incorporated into its application's title bar. The Minimize and Maximize buttons belong to the application. Only the Restore button affects the document window alone.

**HINT** When you have two or more document windows open in an application window and you enlarge one of the document windows, all the others are covered up by the enlarged window. To uncover them, choose the Restore button to return the enlarged window to its previous size or choose Minimize from the document's Control menu to shrink it to an icon.

### ***Restoring an Icon or a Window to Its Previous Size***

You can restore an icon or a window. The Restore command returns a window or an icon to the size and position it occupied before you enlarged it or shrank it to an icon.

#### **▷ To restore an icon to a window:**

**Mouse** □ Double-click the icon.

- Keyboard**
1. Press ALT + ESC as needed to select the application icon. For a document, press CTRL + F6 (or CTRL + TAB) to select the icon.
  2. Open the Control menu.  
For an application icon, press ALT, SPACEBAR.  
For a document icon, press ALT, HYPHEN (-).
  3. Choose Restore.

#### **▷ To restore an enlarged window to its previous size:**

**Mouse** □ Click the Restore button in the upper-right corner of the window.

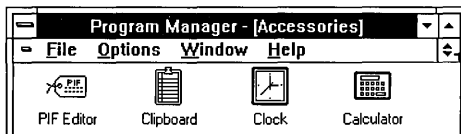

Click the Restore button to return the window to its previous size.

- Keyboard**
1. Open the Control menu.  
For an application window, press ALT, SPACEBAR.  
For a document window, press ALT, HYPHEN (-).
  2. Choose Restore.

## Using Scroll Bars

Some windows and dialog boxes have scroll bars you can use to view text that requires more than the available space.

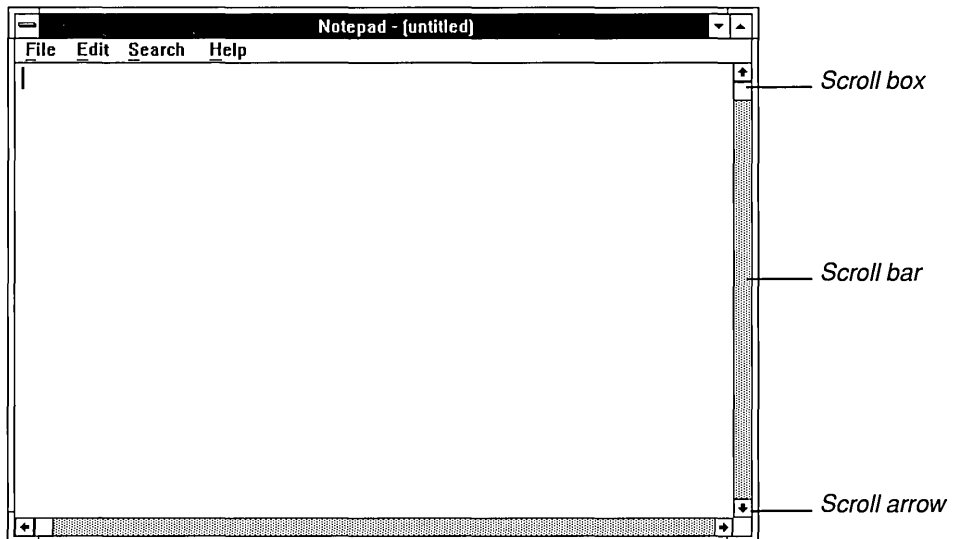

### ▶ To scroll information displayed in a window or dialog box:

- Mouse**
- Drag the scroll box to a position in the scroll bar corresponding to the general location where you want to work (beginning, middle, or end of the file or list).



All the scrolling options are listed in the following table.

<u>To scroll</u>	<u>Do this</u>
One line	Click one of the scroll arrows.
One window	Click the scroll bar above or below the scroll box on vertical scroll bars, and to the left or right of the scroll box on horizontal scroll bars.
Continuously	Point to one of the scroll arrows and hold down the mouse button until the information you want comes into view.
To any position	Drag the scroll box up or down the scroll bar to the position of choice. The section of the document or list that moves into view depends on the placement of the scroll box. For example, if you position the scroll box halfway down the scroll bar, the text halfway through the document or list appears.

- Keyboard** □ Press the DIRECTION key that points in the direction you want to scroll. Other scrolling options are listed in the following table.

<u>To scroll</u>	<u>Press these keys</u>
One window up or down	PAGE UP or PAGE DOWN
One window left or right	CTRL + PAGE UP or CTRL + PAGE DOWN
To the beginning of a line	HOME
To the end of a line	END
To the beginning of the document	CTRL + HOME
To the end of the document	CTRL + END

## ***Closing a Window***

When you are working with an application window, one way to exit from the application is to close the window. Similarly, when you are working with a document window, you can exit from that document by closing the window. If you made changes to your document since last saving it, you are asked if you want to save the document before closing the window.

▷ To close a window:

- Choose Exit from the File menu.  
Or choose Close from the Control menu.  
As a shortcut, you can double-click the Control-menu box.

## ***Working with Applications***

One of the major advantages of Windows is its ability to run two or more applications at the same time. This means that while a spreadsheet is calculating complex year-end formulas, you can be working on the text for the annual report in your word processor, and your computer can be receiving the latest information about industry sales trends for you to use in the introduction.

Windows not only gives you the power to work with more than one application at a time, you can also move important information between running applications like your spreadsheet, terminal, and word processor. This feature can mean tremendous gains in productivity and a virtual end to duplicated efforts.

Many types of applications take full advantage of the graphical interface and other powerful features in Windows 3.0. They use drop-down menus and dialog boxes, provide certain standard menu items, follow the same keyboard and mouse conventions as those used by Windows, and so on. These applications, as well as all of the applications you received with your Windows package, are called *Windows applications*.

**NOTE** If you also own a previous version of Windows, some of the applications you ran with that version might not yet be updated to run with version 3.0. An application that has not been updated displays a message telling you to start Windows in real mode. See Chapter 11, "Options for Starting Windows," for information about starting Windows in real mode.

Other applications, many of them written before Windows was available, were developed to run under MS-DOS. These applications, called *non-Windows applications*, were not designed to take advantage of Windows graphical interface. They do not necessarily use drop-down menus or dialog boxes or make use of the mouse. They may work differently in other ways as well; however, most non-Windows applications can operate within the Windows graphical environment.

In standard mode or real mode, all non-Windows applications run *full-screen*. This means that the application takes over the entire desktop and looks exactly as it looks when running under MS-DOS without Windows.

386

In 386 enhanced mode, you can multitask several non-Windows applications and most can run in a window.

This section explains the basics about running Windows and non-Windows applications. If you want to learn more about the various ways applications can run with Windows, see Chapter 12, “More About Applications.”

## ***Running Two or More Applications***

One of Windows’ most powerful features is its ability to run two or more applications at the same time. For example, your communications program can accept information sent over a modem while you continue to work with your word processing application.

When applications run together, they share your computer’s resources. The way they share the resources depends on the type of computer you have, the type and amount of memory that is available, whether they are Windows or non-Windows applications, and which Windows mode you are running. Chapters 12 and 13 in Part 3, “Advanced Topics,” discuss more fully the various ways you can run applications with Windows.

**NOTE** Because of the advanced way 386 enhanced mode can use memory, it can run more Windows applications at the same time than standard mode or real mode, given the same amount of physical memory.

To find out which mode Windows is running in, open the Program Manager window and choose About Program Manager from the Help menu.

## ***Starting Applications***

To make starting applications easy, Windows offers three methods:

- Choose a program item from a group window in Program Manager.
- Choose a program file (or a PIF) from the appropriate directory window in File Manager. (Starting applications with PIFs is discussed in Chapter 12, “More About Applications.”)
- Choose the Run command from the File menu in Program Manager or File Manager.

**NOTE** Some applications, called memory-resident or “pop-up” programs (such as Borland © SideKick ©), ordinarily suspend the application you are using while you work with them, and then, when you are finished, return you to the suspended application. You can

use memory-resident programs with Windows just like you would any other applications. Make sure you start Windows before you start the pop-up program. See Chapter 12, “More About Applications,” for additional discussion.

## ***Starting Applications from Program Manager***

As long as an application belongs to a group, the easiest way to start it is to choose it from the group window. If a document is included with the application, it will be loaded into the application workspace. See Chapter 3, “Program Manger,” to learn about organizing applications in groups and how to include a document so that it starts up with an application.

### **▷ To start an application from a group:**

- Mouse**
1. Open the Program Manager window, if not already open, and open the group window that contains the application you want to start.
  2. Double-click the icon for the application.
- Keyboard**
1. Open the Program Manager window, if not already open, and open the group window that contains the application you want to start.
  2. Use the DIRECTION keys to move the highlight to the icon for the application.
  3. Choose Open from the File menu or press ENTER.

**HINT** You can choose the Minimize on Use command from the Options menu if you want to shrink Program Manager to an icon whenever you start an application.

## ***Starting Applications from File Manager***

You can start an application from File Manager by opening the program file from a directory window. Program files have .COM, .EXE, .PIF, or .BAT filename extensions. If the application can run in a window, the window will appear in front of any File Manager windows that are open. If the application is a full-screen application, the application screen will replace the File Manager window.

**NOTE** If you plan to use an application frequently, you might find it more convenient to add it to a group in Program Manager rather than to start it from File Manager. To learn how to add an application to a group, see Chapter 3, “Program Manager.”

▷ To start an application from File Manager:

- Mouse**
1. Start File Manager and open the directory window that contains the program file.
  2. Double-click the filename.

- Keyboard**
1. Start File Manager and open the directory window that contains the program file.
  2. Press the DIRECTION keys to select the filename.
  3. Choose Open from the File menu or press ENTER.

You can use the Minimize on Use command on the Options menu to automatically shrink File Manager to an icon whenever you start an application. See Chapter 4, “File Manager,” for procedures on using File Manager commands.

### ***Starting Applications with the Run Command***

The Run command is a handy way to start applications that you want to run only occasionally or have not yet added to a group. You can open a document at the same time you start the application. Unless the program file is in your current path, you need to know the exact directory location and name of the program file (and document) before you can start the application.

▷ To start an application with the Run command:

1. Choose Run from the File menu in Program Manager or File Manager.  
The Run dialog box appears.

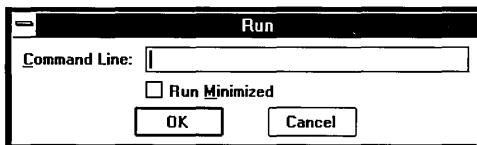

2. Type the pathname and the exact name of the program file, including the extension if there is one.  
For example, if Aldus PageMaker® is stored in the directory C:\PAGEMKR, you would type *c:\pagemkr\pm.exe* in the text box.

You can open a document at the same time you start most applications by typing a space and the document filename (including the pathname) after the program name.

For example, to open a document called NEWSLTR in the AUGUST subdirectory of C:\PAGEMKR, you would type the following in the text box:

```
c:\pagemkr\pm.exe august\newltr.pm3
```

3. If you want the application to shrink to an icon as soon as it starts, make sure the Run Minimized check box contains an X.
4. Choose OK or press ENTER.

### ***Using the DOS Command Prompt***

You might occasionally want to run a non-Windows application, such as an MS-DOS utility program, from Windows. You can run it in the same way you run Windows applications by using Program Manager or File Manager. You can also run it by starting a copy of the MS-DOS command interpreter. That way, you can type in MS-DOS commands just as you would if you were not running Windows.

The DOS prompt appears as a program item in the Program Manager Main Group, so you can get to MS-DOS without leaving Windows.

#### **▷ To start the DOS Prompt:**

1. Open the Main Group window in Program Manager.
2. Double-click the DOS Prompt icon.

Or use the DIRECTION keys to move the highlight to the icon; then press ENTER.

When the DOS prompt appears, you can type the MS-DOS commands and start any non-Windows applications.

#### **▷ To exit the DOS Prompt:**

- Type *exit* and press ENTER.

You can also leave MS-DOS running and switch back to Windows to work with Windows applications. See the next section of this chapter for information about switching among applications.

**CAUTION** CHKDSK /F and other MS-DOS commands that might modify file allocation tables do not run properly from inside Windows. (CHKDSK without the /F switch runs fine.) Other commands that you should avoid running from inside Windows include file undelete utilities and disk compaction or optimization utilities such as Norton's SD.EXE. If you need to run such commands, exit from Windows first.

---

## Switching Among Application Windows

Many times you'll have more than one application window open on your desktop. The window you are currently working in is called the *active window*. When you want to work with another application, you must select its application window to make it the active window. So that the active window can easily be distinguished from inactive windows, its title bar is a different color or intensity.

The active window always appears in the foreground, which means it might overlap non-active windows, partially or completely obscuring them. You can move part of the active application window beyond the borders of the desktop, thereby forcing some of the window's contents outside your view, but the active window cannot be covered by any other window.

When the application window you want to switch to is visible, the easiest selection method is to click it with the mouse or use key combinations to cycle through open applications until you reach it.

When you run a number of applications, some of their windows may not be visible. Even when the windows are not visible, Task List lets you switch easily from one application to another.

### ▷ To switch application windows:

- Click anywhere in the inactive window.  
Or press ALT + ESC repeatedly until the window you want is active.

### ▷ To use Task List to switch application windows:

- Mouse**
1. Double-click anywhere on the desktop to display Task List.  
Or choose Switch To from any Control menu.
  2. Double-click the application name you want from the list box in Task List.  
Or select the name of the application you want from the list box and then choose Switch To.

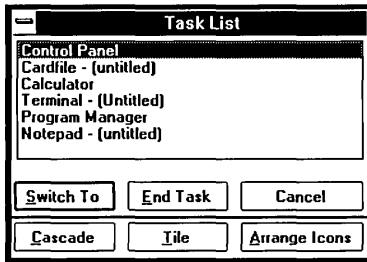

- Keyboard**
1. Press CTRL + ESC to display Task List.  
Or choose Switch To from any Control Menu.
  2. Press UP or DOWN ARROW to select the application you want in the list box.  
Press ENTER.

When an application window appears as an icon, you can switch to the application and open the application window in one step if you are using a mouse.

▷ To switch to and open an application icon:

**Mouse** □ Double-click the icon.

- Keyboard**
1. Press ALT + ESC repeatedly until the icon you want is selected.
  2. Press ALT, SPACEBAR to open the Control menu for the application icon.
  3. Press ENTER to choose the Restore command from the Control menu.

## Arranging Application Windows and Icons

You can use the Cascade and Tile commands from Task List to rearrange application windows so that all the active applications are visible on your desktop. The Cascade command causes the windows to overlap so that each title bar is visible. The Tile command arranges the open windows in smaller sizes to fit on the desktop.

▷ To arrange application windows on your desktop:

1. Double-click on the desktop to open Task List.  
Or press CTRL + ESC.
2. Choose Cascade or Tile.



**HINT** You can also open Task List by choosing Switch To from the application's Control menu.

If you have a number of applications running as icons and they are scattered across your desktop, you can rearrange them evenly across the bottom with the Arrange Icons command button.

▷ **To rearrange application icons:**

1. Double-click on the desktop to open Task List.

Or press CTRL + ESC.

2. Choose Arrange Icons.

The icons line up in an orderly arrangement across the bottom of the desktop.

**HINT** You can also open Task List by choosing Switch To from the application's Control menu.

## ***Transferring Information Between Applications with Clipboard***

The Windows Clipboard is a temporary storage location that is always available when you want to transfer information during a Windows session. You can cut or copy information from an application onto the Clipboard and then transfer that information from the Clipboard into other applications.

Information you cut or copy onto the Clipboard remains there until you clear the Clipboard, cut or copy another piece of information onto it, or exit from Windows. Since the Clipboard retains its contents until you change them, you can paste the information into the destination whenever you want, and you can paste the same information repeatedly.

### ***Cutting or Copying Information onto the Clipboard***

The method you use to transfer information onto the Clipboard depends on whether the application is a Windows or a non-Windows application and whether it is running in a window or uses the full screen.

With Windows applications, you can *cut* or *copy* selected information onto the Clipboard. You can also copy an image of the entire desktop or a single window for any application that is running in a window.

With non-Windows applications that are running in a window on the desktop, you can *copy* selected information, the entire desktop, or a single window onto the Clipboard. For a non-Windows application that is running full-screen, you copy the entire screen onto the Clipboard.

▷ **To cut or copy selected information from a Windows application:**

1. Select the information you want to cut or copy. (See “Selecting Text” in “Working with Documents” later in this chapter for Windows text selection procedures. For text selection procedures for other applications, see the manual specific to each application.)

You can cut or copy text, graphics, or a combination of text and graphics.

2. Choose Cut or Copy from the application’s Edit menu.

The Cut command removes the information from the application and places it on the Clipboard.

The Copy command places a copy of the information on the Clipboard, leaving the original information unchanged.

**386**

To use the following procedure, you must be running Windows in 386 enhanced mode and the application you want to copy information from must be running in a window.

▷ **To copy selected information from a windowed, non-Windows application:**

- Mouse*
1. Drag the mouse pointer across the information you want to copy.
  2. Click the Control menu and open the Edit cascading menu.
  3. Choose Copy.

- Keyboard*
1. Press ALT, SPACEBAR to open the Control menu for the application.
  2. Select the Edit cascading menu and choose Mark.  
A rectangular cursor appears at the upper-left corner of the window.
  3. Move the cursor to the first character you want to select.
  4. Press SHIFT + DIRECTION keys to mark the information you want to copy.
  5. Select Edit from the Control menu again and choose Copy to transfer the selected information to the Clipboard.

## ***Copying an Entire Screen***

You can copy the contents of an entire Windows or non-Windows application screen onto the Clipboard no matter which mode Windows is using. If you are running Windows in standard mode or in real mode, this is the only method you can use to copy information from a non-Windows application.

This procedure does not work for non-Windows applications that are running in graphics mode.

**HINT** If you aren't sure which mode Windows is running in, open the Program Manager window and choose About Program Manager from the Help menu.

### **▷ To copy the contents of an entire screen onto the Clipboard:**

1. Make sure the information you want to copy is on the screen.
2. Press PRINT SCREEN.

This takes a “snapshot” of the screen contents and places it onto the Clipboard.

PRINT SCREEN creates a bitmap of the entire screen. Not all applications can read bitmaps (.BMP files). Make sure the application you want to paste information into can understand the bitmap format.

**HINT** If the preceding procedure does not copy the screen onto the Clipboard, your keyboard is probably an older, unenhanced model. Try the following key combinations to copy the screen: ALT + PRINT SCREEN OR SHIFT + PRINT SCREEN.

## ***Copying an Entire Window***

386

To use the following procedure, you must be running Windows in 386 enhanced mode and the Windows or non-Windows application you want to copy information from must be running in a window.

### **▷ To copy the contents of the active window onto the Clipboard:**

1. Make sure the information you want to copy is in the active window.
2. Press ALT + PRINT SCREEN.

This takes a “snapshot” of the active window and places it on the Clipboard.

ALT + PRINT SCREEN creates a bitmap of the entire screen. Not all applications can read bitmaps (.BMP files). Make sure the application you want to paste information into can understand the bitmap format.

**HINT** If ALT + PRINT SCREEN does not work, try SHIFT + PRINT SCREEN. Older keyboards might not recognize ALT + PRINT SCREEN.

## ***Pasting Information from the Clipboard***

You can paste information from the Clipboard into a destination application at any time. Anything you cut or copy onto the Clipboard remains there until you change it, clear it, or exit Windows.

Some Windows applications recognize text files, and others graphics, while several recognize both text and graphics. Non-Windows applications recognize text only. The method you use to paste information depends on whether you are pasting into a Windows or a non-Windows application.

### ***Pasting Information into Windows Applications***

To paste information from the Clipboard into a Windows application, you use the Paste command from the destination application's Edit menu.

#### **▷ To paste information into a Windows application:**

1. Make sure the information you want to paste is on the Clipboard. (See "Working with the Clipboard's Contents" later in this section.)
2. Start the destination application and place the insertion point where you want the information from the Clipboard to appear.
3. Choose Paste from the application's Edit menu.  
Windows copies the information to the location marked by the insertion point.

### ***Pasting Information into Non-Windows Applications***

To paste information from the Clipboard into any non-Windows application, you use the Paste command from the destination application's Control menu. You can paste only unformatted text into non-Windows applications. If you paste formatted text, the formatting will be lost.

The method you use to paste from the Clipboard depends on whether non-Windows applications are running full-screen or in windows.

▷ **To paste information into a full-screen, non-Windows application:**

1. Make sure the information you want to transfer is on the Clipboard. (See “Working with the Clipboard’s Contents” later in this section.)
2. Start the destination application and place the insertion point where you want the information from the Clipboard to appear.
3. Press ALT + ESC to switch back to Windows without quitting the application. The application appears as an application icon at the lower edge of the Windows desktop.
4. Click the application icon to open the Control menu for the destination application.  
Or press ALT + ESC until you select the application icon you want. Then press ALT, SPACEBAR to open the Control menu.
5. Choose Paste.  
If you are running Windows in 386 enhanced mode, select the Edit cascading menu from the application icon’s Control menu and then choose Paste.  
The information is pasted into the destination one character at a time, as if you were typing it.

**386**

To use the following procedure, you must be running Windows in 386 enhanced mode and the application you want to transfer information into must be running in a window.

▷ **To paste information into a windowed, non-Windows application:**

1. Make sure the information you want to transfer is on the Clipboard. (See “Working with the Clipboard’s Contents” later in this section.)
2. Start or select the destination application and place the insertion point where you want the information from the Clipboard to appear.
3. Open the application’s Control menu.
4. Select the Edit cascading menu and choose Paste.  
The information is pasted into the destination one character at a time, as if you were typing it.

**HINT** You can switch back and forth between running an application full-screen and running it in a window. Press ALT + ENTER (386 enhanced mode only).

## ***Working with the Clipboard's Contents***

You can open the Clipboard, look at its contents, save its contents to a file, retrieve Clipboard files, and remove the current contents of the Clipboard.

### **▷ To view the Clipboard's contents:**

1. Switch to Program Manager, if it isn't the active application, and open the Main Group window.
2. Choose the Clipboard icon from the Main Group window.  
The Clipboard window appears, with the contents visible in the window's workspace.

**NOTE** Clipboard sometimes has to change the line length of the information you copy or cut so that all of it is included in the View Clipboard window. When you paste from the Clipboard into the destination application, the information you copied or cut will be intact.

The Clipboard accepts a number of different text and graphics formats. When you transfer information from one application to another, the original application puts the information on the Clipboard in the formats it understands.

The application you paste the information into determines which format to use. Typically, if there are several choices, the application chooses the format that provides the most information.

You can view the information on the Clipboard in any of the formats that were supplied by the original application.

### **▷ To view another format:**

- Choose the alternate format from the Display menu.

### **▷ To return to the first format that was displayed:**

- Choose Auto from the Display menu.

You can save the contents of the Clipboard to a file and then retrieve the file to view or paste later. The file you save can be read only by the Clipboard.

▷ To save the Clipboard's contents:

1. Choose Save As from the File menu.  
The File Save As dialog box appears.
2. Type a filename for the Clipboard contents and choose OK. The default extension for a Clipboard file is .CLP.  
You can also type a pathname to store the Clipboard file in a different directory.

You can open a Clipboard file and then paste it into any application. Only files with a .CLP extension can be opened in the Clipboard.

▷ To retrieve a Clipboard file:

1. Choose Open from the File menu.  
The File Open dialog box appears.
2. Select the file you want to retrieve from the Files list box and choose OK.  
Or you can type the pathname for the file you want to retrieve in the text box.

**NOTE** If the Clipboard is not empty, you'll be asked if you want to clear it. If you choose OK, the contents of the current Clipboard will be replaced with the contents of the file you specified.

If you need more memory to run an application, you can clear the Clipboard's contents. Since the Clipboard stores information in multiple formats, clearing the Clipboard might free up some memory.

▷ To clear the Clipboard's contents:

1. Choose Delete from the Edit menu or press DELETE.
2. Choose OK.

## Receiving Messages from Inactive Applications

When an inactive application has a status or error message for you, a beep sounds and the application flashes its title bar or icon.

### ▷ To receive a status or error message:

- Select the application window or icon.

The message appears as soon as you select the window or icon.

## Quitting Applications

There are three ways to quit a Windows application that is running.

### ▷ To quit a Windows application:

- Choose Exit from the application's File menu.  
Or choose Close from the Control menu.  
Or double-click the Control-menu box.

If you have changed the document since you last saved it, the application will prompt you to save the file.

### ▷ To quit a non-Windows application:

1. Choose the application's Exit command.  
If you are using DOS Prompt, type *exit*.
2. The application closes and returns you to Windows.

**NOTE** When you exit a non-Windows application that is running full-screen, Windows usually returns you to the Windows desktop, just as you left it. However, you can change a setting in the program information file (PIF) to return to what's called an *inactive window*.

The inactive window captures information from the application that was displayed as you exited. Sometimes that type of information stays on the screen too briefly to be read, making the inactive window a handy feature. See Chapter 12, "More About Applications," to learn about establishing and modifying program information files.



# Working with Documents

This section explains tasks that are common to many different Windows applications: opening and saving documents, and doing basic text editing. See Chapter 3, “Program Manager,” and Chapter 4, “File Manager,” for information about organizing your applications and documents within the Windows environment.

**NOTE** The descriptions in this section apply to the applications you received with the Windows package. Other applications you use might work differently.

## Opening Documents and Files

▷ To open a document:

1. Choose Open from the application’s File menu.
2. Move to the Directories list box.
3. Double-click the directory that contains the file you want to open.  
Or press UP or DOWN ARROW to select the directory and press ENTER.  
Windows displays the names of all files in that directory in the Files list box.
4. Move to the Files list box and select the file you want.  
Some applications provide a check box to specify that the file be *read-only* (which means that changes cannot be made to the file). If you want the file to be read-only, select this check box.
5. Double-click the filename or choose OK.

## Saving Documents and Files

With many applications, the File menu contains two different commands for saving files: Save and Save As.

You use the Save command to save changes to an existing file.

You use the Save As command to name and save a new file or to save an existing file under a new name. For example, you might want to make changes to an existing document without modifying the original. With Save As, you can save another copy of the original file by giving it another name.

▷ To save an existing file:

- Choose Save from the File menu.

▷ To save a new file or an existing file under an additional name:

1. Choose Save As from the File menu.
2. Move to the Directories list box and select the directory in which you want to save the file.
3. Move to the Filename text box and type the name you want to assign to the file, including a filename extension if you want to specify one. (If you prefer, you can include the complete pathname in this text box instead of selecting the directory as described in the previous step.)

If you don't specify an extension, many applications automatically append an extension that is unique to the application. For example, Notepad automatically adds the extension .TXT to its files. If you specify an extension, it overrides any automatic extension.

4. Choose OK.

## ***Switching Among Document Windows***

With some applications, you can open more than one document at a time, each in its own window.

▷ To switch among document windows in the application workspace:

- Click anywhere in the window of the document you want to switch to.  
Or open the application's Window menu and choose the document you want.

**HINT** Press CTRL + F6 (or CTRL + TAB) repeatedly until the document you want is selected. This is a shortcut to the Control menu's Next command.

## ***Arranging Document Windows***

You can use the Cascade and Tile commands from the application's Window menu to rearrange document windows so that all of them are visible within the application workspace.

The Cascade command causes the windows to overlap so that each title bar is visible. The Tile command arranges the open windows in smaller sizes to fit within the application workspace.

▷ To arrange document windows:

- Open the application's Window menu and choose Cascade or Tile.

## ***Working with Text***

Most applications require that you enter text from time to time. In a word processor or text editor, of course, entering and editing text is your main task. But even in a spreadsheet or database, text entry is important.

All Windows applications share the same procedures for typing text, correcting errors, and simple text editing. This section describes those procedures.

### ***Entering Text***

When you begin to enter text, an insertion point (flashing vertical bar) marks the place where the text you type will begin.

▷ To enter text in a new document:

- Just start typing.  
Press ENTER or the SPACEBAR to move the insertion point to a different place on the page. Pressing ENTER moves the insertion point to the next line. Pressing the SPACEBAR moves the insertion point across the line to the right.

▷ To enter text in an existing document:

- Click where you want text to appear, and start typing.  
Or use the DIRECTION keys to move the insertion point where you want text to appear.

**NOTE** You can move the insertion point only to a place in the document where it's been before. For example, to type a report title 10 lines from the top of a new page and 20 spaces in from the left margin, you press ENTER 10 times and then press the SPACEBAR 20 times before you type the title. Anytime you have trouble moving the insertion point with the DIRECTION keys, try using the ENTER key or the SPACEBAR.

## ***Moving Within Text***

After you enter text, you can easily move the insertion point wherever you want within the text.

<b><u>To move to</u></b>	<b><u>Press these keys</u></b>
The next line	DOWN ARROW
The previous line	UP ARROW
The end of the line	END
The beginning of the line	HOME
The next window	PAGE DOWN
The previous window	PAGE UP
The next word	CTRL + RIGHT ARROW
The previous word	CTRL + LEFT ARROW
The end of the document	CTRL + END
The beginning of the document	CTRL + HOME

## ***Correcting Typing Mistakes***

If you make a mistake while entering text, you can correct it by using one of the methods in the following table. Or if you need to change more than a few characters, you can select the text and edit it as explained later in this section.

<b><u>To do this</u></b>	<b><u>Do this</u></b>
Erase the character (or selected text) to the left of the insertion point.	Press BACKSPACE.
Erase the character (or selected text) to the right of the insertion point.	Press DELETE.
Insert characters at the insertion point.	Type the characters.

## ***Selecting Text***

You can make changes to blocks of text by selecting the text you want to change and then choosing one of the commands from the application's Edit menu.

**▷ To select text:**

- Mouse**
1. Point to the first character you want to select.
  2. Drag the insertion point to the last character you want to select.
  3. Release the mouse button.

If you want to cancel the selection, click again anywhere in the document.

**HINT** With some applications, you can select a single word by double-clicking the word.

- Keyboard**
1. Use the DIRECTION keys to move the insertion point to the first character you want to select.
  2. Hold down SHIFT and use the DIRECTION keys to move the insertion point to the last character you want to select.
  3. Release the keys.

If you want to cancel the selection, press a DIRECTION key.

**HINT** With some applications, you can select all the text in your file. Choose Select All from the Edit Menu.

Other keyboard selection options are shown in the following table. A specific application might use only some of these options. In general, you can select an area of text by holding down SHIFT while you use the standard movement keystrokes. Check your application's manual for a list of valid key combinations.

**To do this**

**Press these keys**

Extend the selection to the next line.  
Or, if the next line is already selected,  
cancel the selection.

SHIFT + DOWN ARROW

Extend the selection to the previous  
line. Or, if the previous line is already  
selected, cancel the selection.

SHIFT + UP ARROW

Extend the selection to the end of the  
line.

SHIFT + END

Extend the selection to the beginning  
of the line.

SHIFT + HOME

**To do this**

Extend the selection down one window. Or, if the next window is already selected, cancel the selection.

Extend the selection up one window. Or, if the previous window is already selected, cancel the selection.

Extend the selection to the next word. Or, if the next word is already selected, cancel the selection.

Extend the selection to the previous word. Or, if the previous word is already selected, cancel the selection.

Extend the selection to the end of the document.

Extend the selection to the beginning of the document.

**Press these keys**

SHIFT + PAGE DOWN

SHIFT + PAGE UP

CTRL + SHIFT + RIGHT ARROW

CTRL + SHIFT + LEFT ARROW

CTRL + SHIFT + END

CTRL + SHIFT + HOME

***Editing Selected Text***

You can edit the text you have selected in any of the ways listed in the following table. You can find a full explanation of how to transfer information between applications and documents using the Clipboard earlier in this chapter.

**To do this**

Delete the selected text and place it on the Clipboard, a temporary storage area in memory.

Make a copy of the selected text and place it on the Clipboard.

Replace the text with new text.

Delete the text. (It is not placed on the Clipboard.)

Reverse the previous editing operation.

**Do this**

Choose Cut (SHIFT + DELETE) from the Edit menu.

Choose Copy (CTRL + INSERT) from the Edit menu.

Type the new text.

Press DELETE or BACKSPACE.

Choose Undo (ALT + BACKSPACE) from the Edit menu.

**To do this**

Paste text from the Clipboard to the active window.

**Do this**

Place the insertion point where you want the Clipboard text to begin and choose Paste (SHIFT + INSERT) from the Edit menu.

**NOTE** The Undo command reverses the previous editing operation in many text and graphics applications you might use with Windows. For applications that are not part of the Windows package, check the reference manual you received with the product. For applications that came with the Windows package, see the appropriate section of the *User's Guide* for information about using Undo.

## Using Windows Help

Windows Help is a convenient, quick way to use your mouse or keyboard to look up information on-line, such as information about the basic skills you need to operate Windows, a procedure you're trying to follow, a keyboard equivalent, a feature you'd like to know more about, or a command you want to use.

Help for Windows and the applications you received with the Windows package is available whenever you see a Help command button or *Help* on a menu bar.

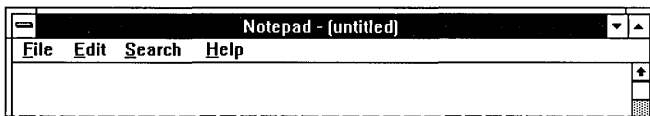

The applications and accessories (except Clock) you received with the Windows package include on-line Help as described in this section. Other Windows applications and non-Windows applications might also provide help, but you'll need to refer to each application's manual for instructions.

## Starting Help

You can request Windows Help in several ways. Because Help might be displayed differently depending on which application you are using and what kind of information you need, Help gives you the following options.

### ▷ To request Help:

- Choose a Help category from the Help menu. Some categories take you directly to the information (like Keyboard). With others, you select the topic you want from a list of topics about the category you chose.

Or press F1. Then choose an item from the main Help Index for the application you are using. You can also search for a topic using the Search command.

Or choose the Help command button you'll find in some dialog boxes. This method gives you quick access to different kinds of Help topics.

Or highlight a dialog box option or select a command and then press F1 to move directly to an explanation of the option (PIF Editor). Or press F1 for information about a message (Setup). This context-sensitive method is available in PIF Editor and in Setup when you first use it to install Windows.

## Using the Help Menu

Each Help menu appears last on the menu bar, as shown in the preceding illustration. When you select Help from the menu bar, a list of Help categories drops down.

### ▷ To get Help from a menu:

- Mouse* 1. Click Help on the menu bar.

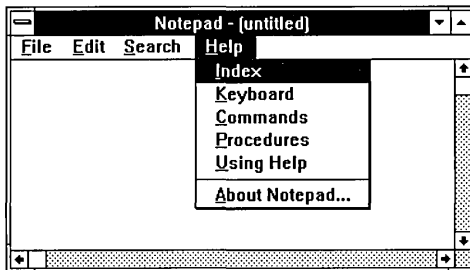

2. Click the Help category you want.

You will see either information about the category or a list of topics for the category.



- Keyboard**
1. Press ALT, H.
  2. Press the underlined letter for the Help category you want.  
Or press DOWN or UP ARROW to reach the Help category you want and then press ENTER.  
You will see information about the category or a list of topics for the category.

**NOTE** If this is the first time you've used on-line Help, choose Using Help from the Help menu to learn about the type of assistance that is available. Using Help includes a brief tutorial on Help called Help Basics.

### ***Help Menu Options***

The following table outlines the standard items on most Windows Help menus.

<u>Menu item</u>	<u>What you'll find</u>
Index	An alphabetical list of all Help topics that are available for the active application.
Keyboard	Tables of key combinations for using your keyboard with the active application.
Commands	An explanation of all the commands used in the active application.
Procedures	Step-by-step procedures for using the active application's features.
Using Help	Short tutorial and other information about using Windows Help.
About (Application)	Important information about the active application, which includes copyright, version, and application name.

### ***Finding Information in Help***

If you request Help by pressing F1, the main Index appears for the application you are using.

If you request Help by selecting a category from the Help menu, one of three things happens. The information you requested appears, the main Index for the application appears, or a list of topics about the category appears.

You can select from the Index or the list of topics or you can use the Help Search feature to locate the information you want.

## ***Finding Information with Search***

The Search feature is the most efficient way to find the information you need. When you already know a keyword or phrase that you want Help on, you can type it in the Search dialog box and let Windows Help find the information for you.

### **▷ To search for a Windows Help topic:**

1. Open Help and choose the Search button. The Search dialog box appears.
2. Type a word or short phrase in the Search For text box that describes the information you want. Or you can scroll through the keyword entries in the list box beneath the Search For text box and select the appropriate keyword.

As you type, the top entry in the list box beneath the Search For text box changes to match what you type as closely as possible.

3. Choose Search. A list of topics that match or relate to the keyword or phrase appears in the Topics Found list box.
4. Choose the topic you want.

**NOTE** Search does not require you to type an entire word. Help matches the characters you type as closely as possible with the available keywords below the text box. Help automatically selects the keyword that most closely resembles what you type. When you choose the Search button, Help lists all the topics it finds that relate to the selected keyword or phrase. Then you choose the topic you want from that list.

The next time you open the Search dialog box, you'll see the name of the topic you searched for previously.

## ***Finding Information with Help Index and Table of Contents***

When you request Help by pressing F1, you'll see a Help Index, alphabetized by category, of all the topics that are available for the application you are using.

When you request Help by choosing a category from the Help menu, you'll either go directly to the information about the category or to a list that resembles a table of contents. This list refers strictly to the application you are currently using.

You scroll through the list and choose a topic. The mouse pointer (or highlight if you use a keyboard) turns into a hand pointer when it touches an underlined topic.

The hand pointer indicates that information is available for the topic. When you choose an active topic, a window containing the information appears.

### ▷ To choose a topic from an Index or Table of Contents:

1. Press F1 or choose a Help category you want from the Help menu.
2. Scroll to the topic you want information about.
3. When the mouse pointer turns to a hand, click the topic you want.  
Or press TAB to highlight the topic you want and then press ENTER.

Sometimes, at the end of the Help text, there is a list of related topics you can choose from, as explained in the preceding steps.

### ***Additional Methods***

When you finish reading about a topic, you have several choices. If a list of related topics follows the information, you can choose from the list. Or you can choose one of the buttons described as follows.

#### Use this button

#### To do this



View the Help Index for the application.



View previous information. Pressing Back retraces your path through the Help topics you've already seen until you reach the Index.



View the previous topic in a series of related topics. When you reach the first topic in the series, the button is dimmed.



View the next topic in a series of related topics. When you reach the last topic in the series, the button is dimmed.



Locate information about a topic (keyword or phrase) you select from a list or that you type in the Search For text box.

**HINT** You can keep Help handy by resizing it and arranging it on your desktop to fit beside the running application.

## ***Practicing Basic Skills***

If you are a new user of Windows, or just want to explore the features of Windows 3.0, Solitaire and Reversi give you the perfect opportunity to practice many of the skills covered in this chapter. These two games were copied onto your hard disk when you installed Windows.

Both games provide a rich graphical environment that includes many of Windows' most powerful features. Play while you learn to use on-line Help, open menus and select items, move and resize application windows, work with dialog boxes, and switch between applications.

You start the games like you start any other application. See "Starting Applications" earlier in this chapter.



---

---

**Chapter**  
**3**

**Program Manager**

**What Is Program Manager? .....79**

**Working with Groups .....80**

    Opening Group Windows and Shrinking Them to Icons ..... 82

    Resizing Group Windows ..... 83

    Rearranging Group Windows ..... 84

    Arranging Icons ..... 86

    Creating and Deleting Groups ..... 87

    Changing the Contents of Groups ..... 88

**Starting Applications from Program Manager .....96**

    Starting Applications from Groups ..... 96

    Returning to Program Manager from Applications ..... 97

**Quitting Program Manager .....98**

Vertical line on the left side of the page.

# What Is Program Manager?

Program Manager is central to the operation of Microsoft Windows. It starts automatically whenever you start Windows and continues to run as long as you are using Windows.

Starting applications from Program Manager is easy; you simply choose the program item icon for the application you want to use and Program Manager does the rest. When you do run other applications, Program Manager runs in the background or on your desktop as an application icon.

The very first time you start up Windows, Program Manager opens on your desktop with the Main Group window open inside it.

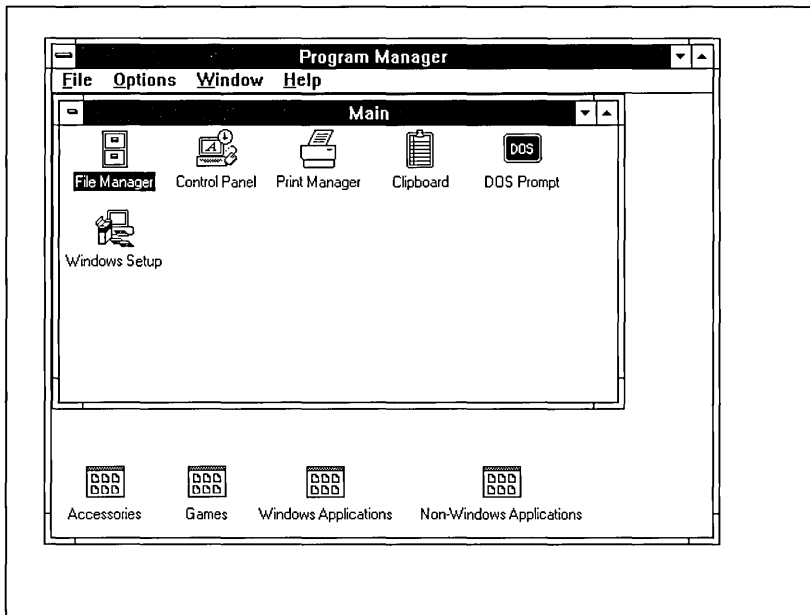

The Accessories Group, the Games Group, and, depending on which other applications you told Windows to install from your hard disk, the Windows Applications Group and the Non-Windows Applications Group are represented as identical group icons at the bottom of the Program Manager window. These groups contain the program item icons for all the applications you installed and the applications you will use to manage the operation of Windows.



Program Manager is also an organizational tool. You can use it to organize your applications into groupings that make sense to you. You can also control how those groups and their contents are arranged on your desktop with Program Manager.

You must return to Program Manager when you want to end your Windows session. You cannot quit Program Manager without also quitting Windows. See the end of this chapter for instructions on quitting Program Manager.

## ***Working with Groups***

Each group contains a collection of program item icons, each representing an application you can run. Depending on the information you specify when you add a program item to a group, choosing a program item icon from a group can start an application or start the application and, at the same time, open a related document.

Windows comes with several predefined groups, each containing several program item icons.

- The *Main Group*, which contains the Windows system applications: File Manager, Control Panel, Print Manager, Clipboard, DOS Prompt, and Windows Setup.
- The *Accessories Group*, which includes Windows applications for word processing, drawing, and communications, as well as several less complex applications that you will probably find very convenient: a clock, a calculator, a macro recorder, a calendar, a notepad, a card file, and an editor for program information files (PIF Editor).
- The *Games Group*, which offers two games that you can use to practice the basic skills you learn as you operate Windows or to give yourself a relaxing break from work.
- The *Windows Applications Group*, which contains any Windows-based applications found on your hard disk during the Setup procedure.
- The *Non-Windows Applications Group*, which contains non-Windows applications that Setup was able to install during the Setup procedure.

You start up the applications in these groups by opening a *group window* and choosing the program item icon for the application you want to run.

When you exit Windows and save the changes you made during your Windows session, Windows will start your next session with the Program Manager's group windows, group icons, and program item icons arranged as they were at the end of the previous session.

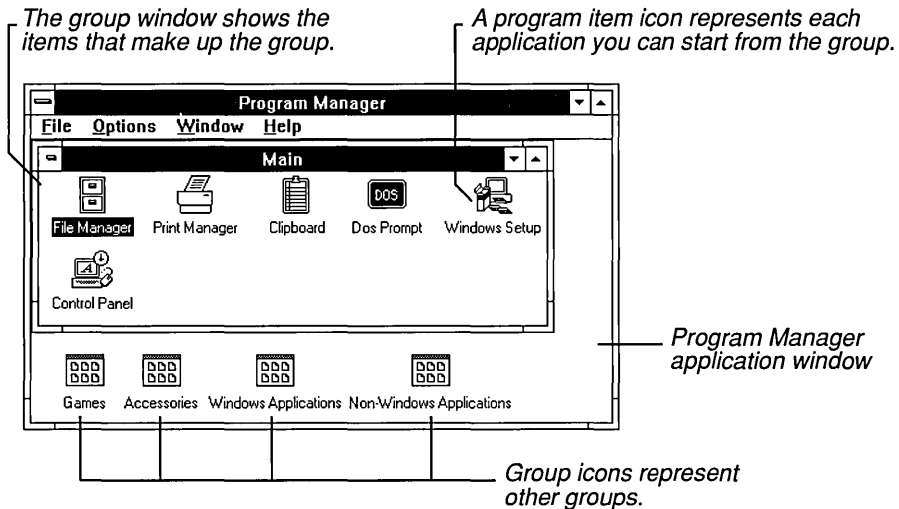

The following list describes the unique elements of the Program Manager window.

- *Group windows* are document windows that occupy the Program Manager's application workspace. They contain icons that start up applications. Each group window has its own Control menu, but no menu bar. Group windows are affected by commands from Program Manager's menu bar. Group windows cannot be moved outside the Program Manager workspace.
- *Group icons* are minimized group windows. Group icons are located at the lower edge of the Program Manager window and are distinguished only by the labels beneath each icon, since all group icons look alike. Like group windows, they cannot be moved outside the Program Manager workspace.
- *Program item icons* are inside of group windows and represent the applications and documents you can start from Program Manager. Choosing a program item icon starts the application the icon represents. You can move program item icons from one group window to another, but not into the Program Manager application window or outside Program Manager.

Most program item icons have a unique appearance, making them easy to locate at a glance. However, some non-Windows applications use identical program item icons. Also, if you create separate program items for the same application, the resulting icons look the same.

For example, suppose you want a group to include several documents that will be loaded when you start an application, and they all use the same application. You must add a separate program item for each document. Each program item includes pathnames and filenames for the application and one document. The resulting group contains several program item icons that all look just like the original icon for the application. Only their labels distinguish them. (See “Adding Program Items and Documents to a Group” later in this chapter.)

## ***Opening Group Windows and Shrinking Them to Icons***

To open an application (and its related document) from a group, you must first open the window for the group that contains the program item icon for that application. You can then shrink the group back to its icon size to make room on your desktop.

### **▷ To open a group window:**

- Double-click the group icon.  
Or press CTRL + F6 (or CTRL + TAB) until the group icon you want is highlighted; then press ENTER. (You can also select the group name from the list at the bottom of the Window menu.)

### **▷ To shrink a group window to an icon:**

- Click the Minimize button.  
Or press ALT, HYPHEN (-) to open the group’s Control menu, and choose Minimize.

Group windows do not close like other windows. If you double-click the group’s Control-menu box or choose Close from the Control menu, Program Manager shrinks the group to a program item icon.

**NOTE** When you shrink Program Manager to an icon, all the program group windows, group icons, and program item icons are included.

## Resizing Group Windows

The procedure for changing the size of a group window is the same as resizing any other window. See “Changing the Size of a Window” in Chapter 2 for instructions.

However, since group windows usually contain a number of program item icons, some or all of the icons might not be visible after you change a window’s size, especially if you make it smaller.

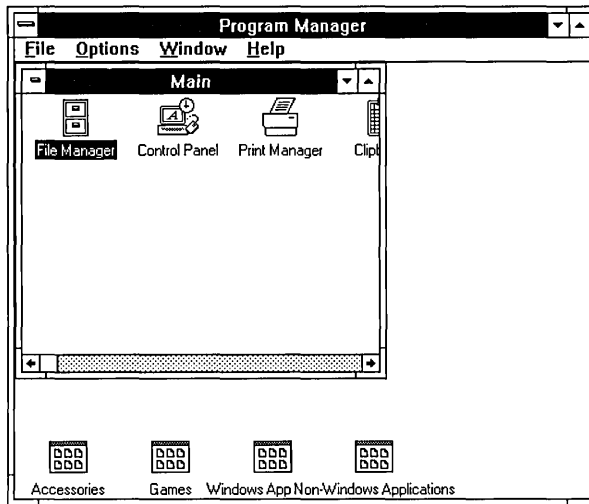

You can adjust the arrangement of the program icons in two ways. Choose the Arrange Icons command on Program Manager’s Window menu each time you finish resizing a group window. Or select the Auto Arrange command on Program Manager’s Options menu before you resize a group window (a checkmark beside Auto Arrange means it is active).

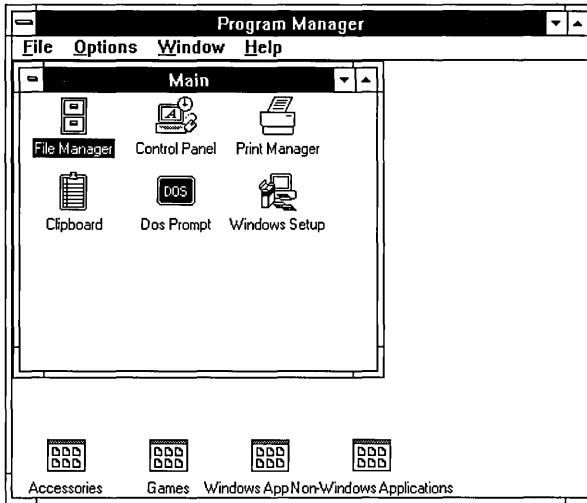

With either command, Program Manager rearranges the program item icons to fit into the new group window size. If all the icons can't fit, a scroll bar is provided. When selected, the Auto Arrange command rearranges program item icons automatically every time the size of their group window changes. To use the Arrange Icons command, you must choose it each time.

## ***Rearranging Group Windows***

When you open several group windows at a time, they begin to overlap in such a way that some of the windows are hidden beneath other windows. You can use the Cascade and Tile commands found on the Window menu to rearrange all the group windows so that some part of each window is visible.

The Cascade command resizes and layers the open group windows within the Program Manager workspace so that each title bar is visible as shown in the following illustration.

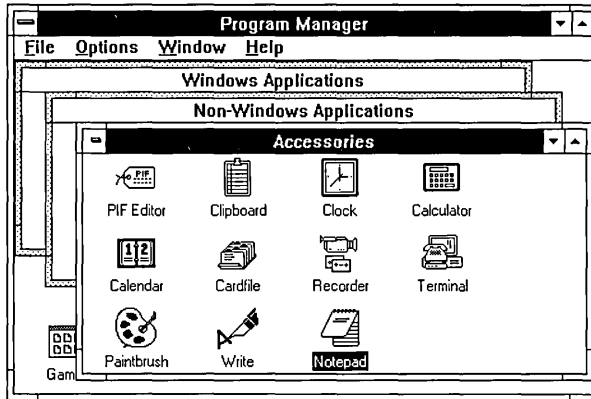

### Cascading windows

The Tile command divides the available space in the Program Manager workspace into smaller windows of similar sizes for each group window that you have open. As many program item icons as can fit in the allotted space for each group will show. The following illustrates tiling:

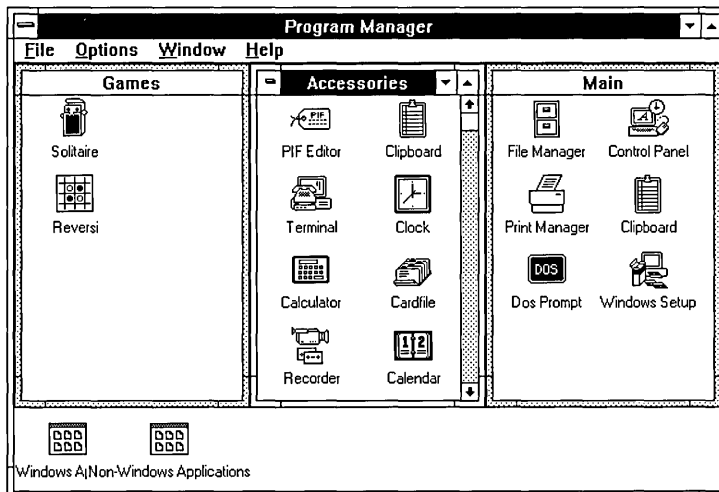

### Tiled windows

If you open another group window after cascading or tiling, it will overlap the rearranged windows. To include it among the rearranged windows, you must choose the command again.

▷ **To rearrange all the open group windows:**

- Choose Cascade or Tile from the Window menu.

## ***Arranging Icons***

You can move any group icon within the Program Manager workspace by dragging it with the mouse or by using the Move command from the group's Control menu.

You can also move program item icons between group windows or into group icons. (See the sections on copying and moving program items later in this chapter.)

▷ **To rearrange group icons:**

1. Select any group icon.
2. Choose Arrange Icons from the Window menu to distribute the group icons evenly at the bottom of the Program Manager window.

Or you can drag individual icons with the mouse to a new location. With the keyboard, you press ALT, HYPHEN (-) to open the group icon's Control menu. Then choose the Move command and press DIRECTION keys until the icon is in the location you want.

▷ **To rearrange program item icons:**

1. Select the group window in which you want to rearrange program item icons.
2. Choose Arrange Icons from the Window menu to distribute the program item icons evenly within the selected group window.

Or you can drag the individual icons with the mouse to a new location within the group window.

## Creating and Deleting Groups

You can add any number of groups to Program Manager at any time to help organize your applications and documents in a way that makes sense to you. And if you find that you no longer need a group, you can delete it and free up some space on your desktop.

### ▷ To create a new group:

1. Choose New from the File menu.  
Program Manager displays the New Program Object dialog box.
2. Select the Program Group option and choose OK.  
Program Manager displays the Program Group Properties dialog box.

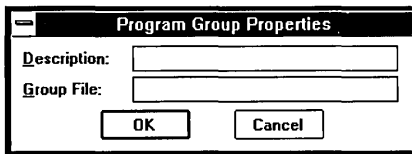

3. Type a description for the group you want to create. This description appears in the title bar of the group window and just below the group icon.

**HINT** Keep the description short to conserve space on your desktop.

4. Choose OK.  
Program Manager automatically creates a .GRP file for the new group, so you can leave the Group File text box blank.

After creating the group, you can add the program item icons that you want included in the group. See “Adding Program Items and Documents to a Group” later in this chapter.



▷ **To delete a group:**

1. Click the icon for the group you want to delete.  
Or press CTRL + F6 (or CTRL + TAB) repeatedly until you select the group icon.
2. Choose Delete from the File menu.  
Program Manager displays a dialog box, asking you to confirm that you want to delete the group. Program Manager will delete the group you selected and any program item icons in it, so be sure before you continue. This does not, however, remove any program or document files from your disk.
3. Choose Yes to remove the group from Windows.

### ***Changing the Properties of a Group***

You can change the description for any group. The description labels the group icon and appears in the title bar of the group window.

▷ **To change the description of a group:**

1. Select the group icon for which you want to change the description.
2. Choose Properties from the File menu. The Program Group Properties dialog box appears.
3. Type a new description and choose OK.

### ***Changing the Contents of Groups***

You can change the contents of any group by adding new program items, copying or moving program items from one group to another, or deleting program items.

#### ***Adding Program Items and Documents to a Group***

One of the ways to change the contents of a group is to add a new program item. You can add new program items from your hard disk to existing groups in the following ways:

- By using the New command in Program Manager
- By dragging program files and document files from File Manager (mouse only)
- By using Windows Setup

**NOTE** Including more than 40 program items per group is not recommended.

You can also place a document in a Program Manager group by including it with the application as a program item. When you do that, the document is automatically loaded into the application workspace whenever you start up the application from Program Manager.

Only one document can be included per program item. It shares the application's program item icon and the label for that icon. Each time you want to include another document with that application, you create another program item and an identical program item icon is added to the group. Their labels distinguish the items from one another.

**NOTE** Each separate program item starts another application. If you have a number of program items for the same application, each time you choose one, the application is loaded into memory again.

Including documents with program item icons lets you organize all the pieces of a single project into one group. For example, to prepare a monthly newsletter you might have a group that looks something like this:

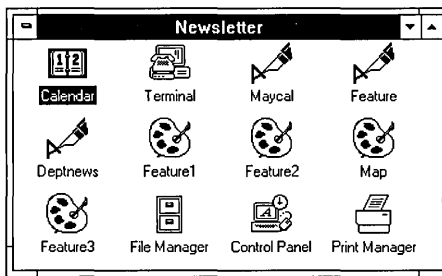

### ► To add a program item and a document to a group with Program Manager:

1. Open the group window for the group you want to add to.
2. Choose New from the File menu.  
The New Program Object dialog box appears.
3. Select Program Item and choose OK.

The Program Item Properties dialog box appears.

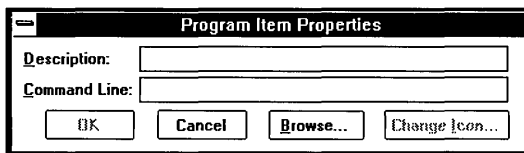

4. Type a description for the program item in the Description text box.

The description is a label for the program item icon that represents the program file (and its associated document) in the group window.

**NOTE** The description is optional. If you leave this text box blank, Program Manager labels the icon for you with a suitable description. However, a description of your own can be very useful, especially if you intend to include several documents that start with the same application within the same group.

5. Type the name of the program file, including the extension (if there is one), in the Command Line text box. Include the complete pathname required to locate the file, if necessary.

For example, to add Microsoft Excel, stored in a directory on a hard disk named C:\EXCEL, type *c:\excel\excel.exe* in the text box.

If you don't know the name for the program file, choose the Browse button to display a list of files and directories. Select the appropriate filename (and directory if necessary) from the list. Then choose OK to insert that filename in the Command Line text box.

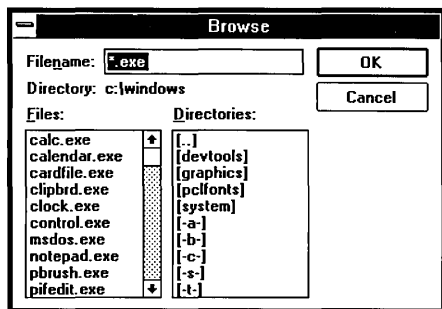

**HINT** You don't need to type the entire pathname if the location of the application's program file is included in the Path command in your AUTOEXEC.BAT file or if the program file is in the current directory. In fact, if the program file is included in your AUTOEXEC.BAT Path command, you can specify a current directory other than the one that contains the application. For example, you might want to start Microsoft Excel and make the \BUDGETS directory current. To do so, make sure the directory containing Excel is included in your AUTOEXEC.BAT path. Then, type *c:\budgets\excel.exe* in the Command Line text box.

6. If you want to include a document with the program item, press the SPACEBAR after the program's filename and type the filename of the document. Include the complete pathname required to locate the document.

For example, to add a spreadsheet named 91BUDGET.XLS stored in C:\ADMIN\FY91 and relate it to Microsoft Excel, type *c:\excel\excel.exe c:\admin\fy91\91budget.xls* in the text box.

**NOTE** If the document is located in the same directory as the application, you do not have to repeat the pathname when you type the filename for the document. For example, to include a spreadsheet located in the C:\EXCEL path, you would type *c:\excel\excel.exe expense.xls*.

7. Choose OK.

**NOTE** Program Manager selects an icon for each program item in the group window. If more than one icon is available for a program item, you can use a different one by choosing Change Icon in the Program Item Properties dialog box. You cycle through the other available icons by choosing View Next.

You can also use File Manager to create program item icons in Program Manager groups. You can move applications and associated documents from File Manager directories to Program Manager group windows or to group icons.

The following procedure requires a mouse.

### ▷ To add a program item to a group using File Manager:

1. Position the group icon or resize the group window that will receive the new program item so that it occupies one side of your desktop, leaving room for the File Manager window.

If you are not concerned with the placement of the new program item icon in the group, you do not need to open and position a group window. You can

simply drop the program file or document file icon from File Manager onto the group icon in Program Manager.

- Open File Manager and position and resize it so that you can see both File Manager and Program Manager.

**HINT** If you have no other application windows open, you can use the Tile command to arrange the windows for File Manager and Program Manager.

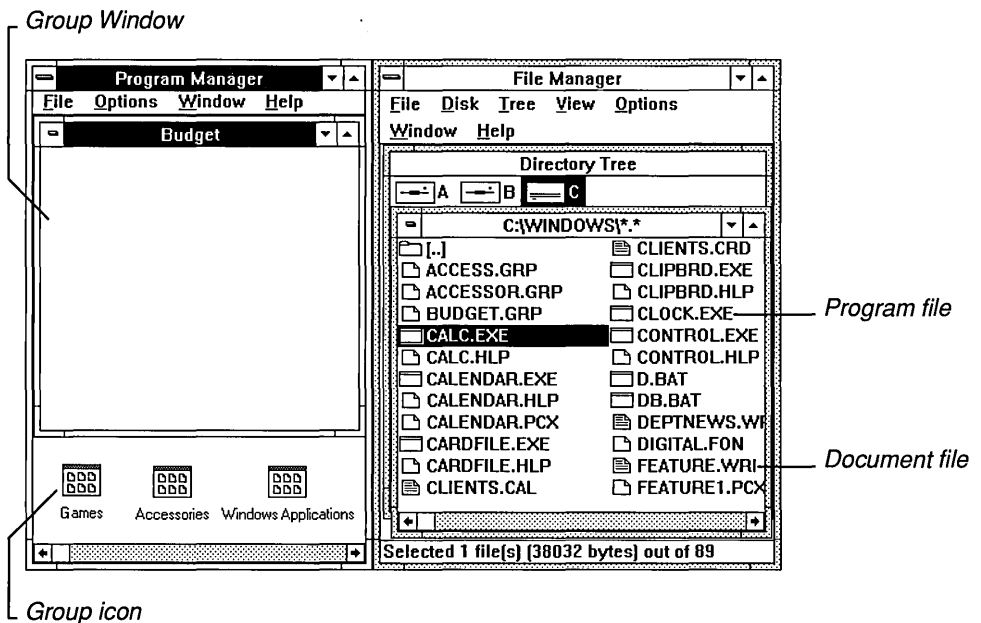

- Locate and select the program file or the document file in File Manager for the item you want to add.  
Generally *program files* use .EXE and .COM extensions, but you can also move files with .BAT and .PIF extensions to Program Manager groups. (See Chapter 4, “File Manager,” if you need help locating the appropriate files.)
- Drag the program or document file from File Manager to Program Manager and drop it in the group window or on the group icon. As you drag the file, the mouse pointer turns into a black and white replica of the file’s icon.

The preceding procedure has no keyboard equivalent.

▷ **To add a program item to a group using Windows Setup:**

1. Start Setup from the Main Group. The Windows Setup dialog box appears.
2. Select Options from the menu bar and choose Set Up Applications. You'll see the Set Up Applications dialog box.
3. If you do not want Setup to search your entire hard disk for applications, open the drop-down list box and select the option you want Setup to search. Choose OK.

Setup searches for available applications as you specified and lists the ones Windows recognizes in the list box for Applications found on hard disk(s).

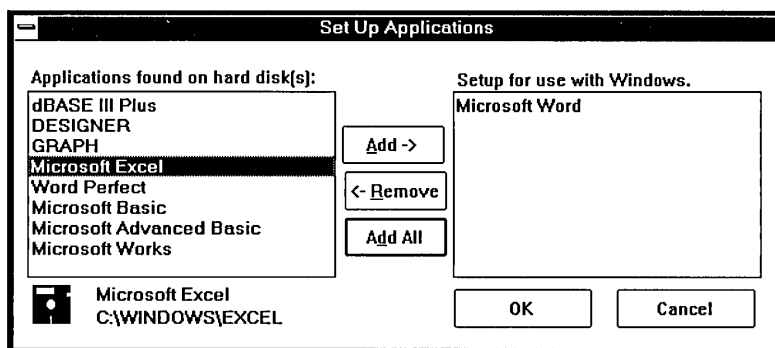

4. Select as many applications as you want to add from the list box on the left. If you are using a mouse, click to select each one. (You can click a selected application again to clear the highlight.)  
With the keyboard, use the DIRECTION keys to move to the next application you want and press the SPACEBAR to select it. (You can press the SPACEBAR again to clear the selection.)
5. After you select all the applications you want, choose Add to move the selected application(s) from the list box on the left to the list box on the right. If you change your mind about setting up an application after you add it, select it again and choose Remove to move it back to the list box on the left.
6. Choose OK.

Setup adds a program item icon for each application you selected to either the Windows Applications Group or the Non-Windows Applications Group, as appropriate.

## ***Deleting a Program Item from a Group***

You can delete a program item from a group easily. Deleting it does not remove the application from your disk; it only removes the program item icon from the group window.

### ***▷ To delete a program item from a group:***

---

1. Open the group window that contains the item you want to delete.
2. Select the program item icon for the item.
3. Choose Delete from the File menu.  
Program Manager displays a confirmation message.
4. Choose Yes.

## ***Copying Program Items from One Group to Another***

The easiest way to copy a program item from one group to another is to drag the program item icon with the mouse and drop it on the other group icon or in the other group window. If you don't have a mouse, you can use the Copy command on the File menu.

### ***▷ To copy a program item to another group:***

---

- Mouse*
1. If you don't care about the placement of the new program item icon in the group window, open the group window that contains the program item icon you want to copy and leave the destination group an icon.  
If you do want to place the new program item icon in a particular location in a group window, open the group windows for both the source and the destination.
  2. Hold down CTRL and drag the program item icon from its current location to the destination group's icon or window.  
The mouse pointer changes into a black and white copy of the program item icon you are copying.
  3. When the copied icon is on top of the destination group's icon or inside the destination group's window, release the mouse button and the CTRL key.

- Keyboard**
1. Open the group window that contains the program item you want to copy.
  2. Use the DIRECTION keys to select the program item icon.
  3. Choose Copy from the File menu.
  4. Select the name of the group you want to copy the program item to.
  5. Choose OK.

**HINT** You can create a duplicate program item within a group. Hold down CTRL while you drag the icon and drop it in the source group window. Or with the keyboard, you can select the source group name from the To Group list in the Copy Program Item dialog box.

### ***Moving Program Items to Another Group***

Like copying a program item, moving one is easiest if you have a mouse, since you can simply drag the program item icon to the other group icon or group window. If you don't have a mouse, you can use the Move command on the File menu.

#### **▷ To move a program item to another group:**

---

- Mouse**
1. Open the group window that contains the program item you want to move.
  2. Drag the program item icon to the destination group's icon or window.  
The mouse pointer changes to a black and white image of the program item icon you are moving.
  3. When the program item icon is on top of the destination group's icon or inside the destination group's window, release the mouse button.

- Keyboard**
1. Open the group window that contains the program item you want to move.
  2. Use the DIRECTION keys to select the program item icon.
  3. Choose Move from the File menu.
  4. Select the name of the group you want to move the program item to.
  5. Choose OK.



## ***Changing the Properties of Program Items***

At any time, you can change the description, program filename, related document filename, or icon for an item in a group. These elements are called the *properties* of the item.

### **▷ To change the properties for a program item:**

1. Select the program item icon.
2. Choose Properties from the File menu.
3. Make any desired changes.
4. Choose OK.

## ***Starting Applications from Program Manager***

Grouping applications with Program Manager makes finding and starting an application easy. You can also start applications from File Manager. See “Starting Applications from File Manager” in Chapter 4 for instructions.

## ***Starting Applications from Groups***

Whenever an application is represented by a program item icon in a group, the easiest way to start the application is to choose the program item icon from the group window. If you included a document with the program item, it appears in the application workspace. See “Adding Program Items and Documents to a Group” earlier in this chapter.

### **▷ To start an application from a group:**

1. Open the group window that contains the program item icon for the application.
2. Double-click the icon.  
Or use the DIRECTION keys to select the icon; then press ENTER.

When you start an application, Program Manager changes the current directory to the directory that contains the application, as you specified when you added the program item to the group. You can change this directory by specifying a different directory in the Command Line text box as explained earlier in this chapter. Non-Windows applications can override this directory change if you specify an initial

directory in their program information files (PIFs). See Chapter 12, “More About Applications,” for more information.

You can set Program Manager to shrink to an application icon whenever you start an application. This is useful because the icon remains visible at the bottom edge of the desktop when most applications are running, making it easy to find when you want to switch back to Program Manager.

▷ **To shrink Program Manager to an icon whenever you run an application:**

---

- Choose Minimize on Use from the Options menu.

A checkmark (✓) appears beside the text for this command when it is active. To cancel the command, choose it again.

## ***Returning to Program Manager from Applications***

When you are working with an application or document and want to start a different application, you can do so by either returning to Program Manager or using File Manager. See “Starting Applications from File Manager” in Chapter 4 for instructions about using File Manager.

▷ **To return to Program Manager from an application:**

---

*Mouse* □ Click the Program Manager window or double-click the Program Manager icon. If the Program Manager window is not visible, press ALT + ESC repeatedly until you reach it.

*Keyboard* □ Press ALT + ESC repeatedly to cycle through open application windows and application icons until you reach Program Manager. If Program Manager appears as an icon, press ALT, SPACEBAR to open its Control menu. Then press ENTER to restore it to a window. You can also use Task List to return to Program Manager. Press CTRL + ESC to display Task List and choose Program Manager from the list of running applications. See Chapter 2, “Basic Skills,” for more information about using Task List to switch among applications.

## ***Quitting Program Manager***

Even when you run applications, Program Manager remains running in the background. You quit Program Manager only when you are ready to quit Windows.

▷ **To quit Program Manager (and Windows):**

1. Quit all applications that are running, if any.
2. Choose Exit Windows from the File menu.

Windows displays a confirmation dialog box, asking if you're sure you want to end this Windows session.

3. If you want to save the arrangement of Program Manager's group windows and icons, make sure the Save Changes check box contains an X.

If you select the Save Changes box, then the next time you start Windows, the Program Manager workspace will look just as it did when you last used it. Everything you added, deleted, or changed during that last session will be permanent until you make more changes to the Program Manager workspace and save your changes again.

4. Choose OK.

---

---

**Chapter**  
**4**

**File Manager**

**What Is File Manager? .....101**

**Starting File Manager .....101**

**Working with the Directory Tree .....102**

    Changing Disk Drives ..... 104

    Using Network Disk Drives ..... 104

    Changing Directories ..... 108

    Expanding Directory Levels ..... 109

    Collapsing Directory Levels ..... 110

**Working with Directory Windows ..... 111**

    Opening Directory Windows ..... 112

    Selecting Open Directory Windows ..... 113

    Replacing the Contents of the Active Directory Window ..... 114

    Changing the Information Displayed in Directory Windows ..... 114

    Arranging Directory Windows ..... 120

    Updating Directory Windows ..... 121

    Closing Directory Windows ..... 121

**Working with Files and Directories .....121**

    Naming Files and Directories ..... 122

    Creating Directories ..... 122

    Searching for Files and Directories ..... 123

Selecting Files and Directories .....	125
Extending a Selection .....	125
Canceling a Selection .....	128
Moving and Copying Files and Directories .....	128
Deleting Files and Directories .....	131
Suppressing Confirmation Messages .....	132
Renaming Files and Directories .....	133
Printing Files .....	134
Setting File Attributes .....	134
Associating Documents with an Application .....	135
<b>Starting Applications from File Manager .....</b>	<b>137</b>
<b>Maintaining Disks and Diskettes .....</b>	<b>138</b>
Formatting Diskettes .....	138
Making a System Diskette .....	139
Copying Diskettes .....	140
Labeling Disks .....	141
<b>Quitting File Manager .....</b>	<b>142</b>

## What Is File Manager?

Microsoft Windows File Manager, like Program Manager, is new to Windows 3.0. It replaces the MS-DOS Executive found in previous versions of Windows.

File Manager is a powerful tool that can help organize your files and directories. A *directory* is a collection of files stored under the same name. You can use File Manager to view all your files and directories and then build a structure of those files and directories that makes the most sense to you. You can also start applications from File Manager.

If you work with many applications and store a large number of files, as most Windows users do, you will find it easier to keep track of these files if you maintain a logical and orderly directory structure.

By storing related files in their own directories, you can develop a filing system that works for you. For example, you might store all memos and letters in one directory, and budget spreadsheets in another. Or, if your business is project related, you might keep files for each project in individual directories.

As you work with File Manager to organize and manipulate your files and directories, you will work with two kinds of windows:

- The *Directory Tree window*, which contains the *Directory Tree*. The Directory Tree shows you the overall organization of directories and subdirectories on any disk drive. Directories are shown as branches off the top-level directory, which is known as the *root directory*.
- Any number of *directory windows*. Each directory window shows the contents of a selected directory. From directory windows you can move, copy, delete, and rename files and directories. You can also start applications from directory windows.

## Starting File Manager

The first time you start Windows, the program item icon for File Manager appears in the first position in the Main Group window of Program Manager. You start File Manager the same way you start other applications.

▷ To start File Manager:

- Double-click the File Manager program item icon.

Or press the LEFT or RIGHT ARROW key to move the highlight to the File Manager program item icon. Then press ENTER or choose Open from the File menu.

File Manager displays the Directory Tree window for your current disk drive.

**NOTE** If you find that you run applications from File Manager most of the time, you can change your Windows initialization (.INI files) settings so that File Manager, instead of Program Manager, appears whenever you start Windows. For instructions about changing the Shell= line, start Notepad (or any other text editor) and open SYSINI.TXT.

## ***Working with the Directory Tree***

The Directory Tree window shows the structure of your directories and subdirectories on any disk drive. The directory structure resembles a tree. The tree begins with the *root directory*, the first directory on a disk drive. The root directory is created when you format a disk. It is represented by a backslash (\). In other words, C:\ is the root directory for drive C. The root directory and each directory that you create from the root can contain more directories.

From the Directory Tree window, you can open directory windows to list files and subdirectories for your individual directories. You can also select different disk drives to view their directory structures. You can open as many directory windows as you like. However, only one Directory Tree window can be open at a time.

The Directory Tree window and its elements are shown in the following illustration.

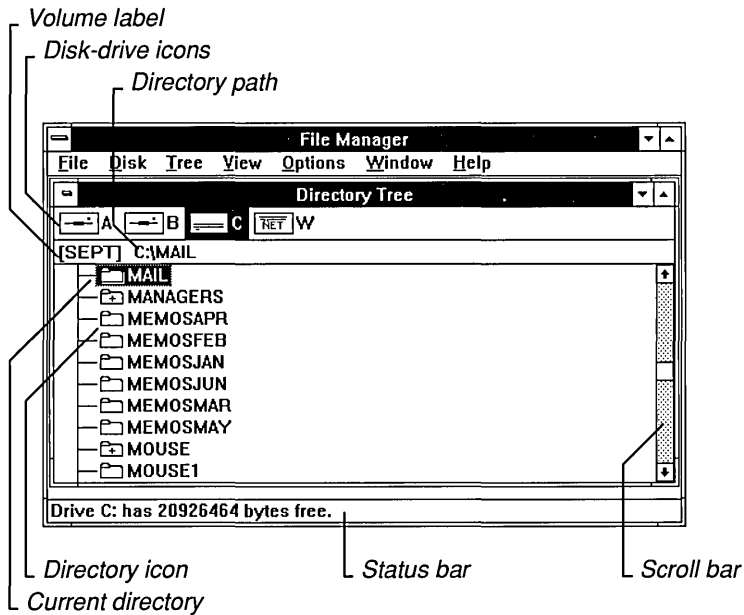

The Directory Tree window contains the following parts:

- The *disk-drive icons* represent the disk drives on your computer. A drive letter follows each icon. The highlighted icon and letter represent the current disk drive. Different icons are used to represent the hard disk drives and floppy diskette drives on your computer, network disk drives you are connected to, RAM drives you may have set up in your computer's memory, and CD-ROM drives.
- The *volume label* is the name that identifies your disk; it appears in square brackets ([ ]) in the status line below the drive icons. You see this information only if you have assigned a label to your disk.
- The *directory path* for the Directory Tree window appears in the status line below the drive icons. The directory path for a directory window appears in the title bar for each directory window.
- The *current directory* is the directory that is highlighted in the Directory Tree window. File Manager commands affect this directory.



- The *directory icons* represent each directory on your computer. Directories are listed in alphabetical order beneath the root directory (\). Directory icons are joined to the root directory by a vertical line. If a directory contains subdirectories, a plus sign (+) appears inside the directory icon. When listed, subdirectory icons are shown beneath directories and are connected to the appropriate directory by a vertical line.
- A *scroll bar* appears if there are more directories and subdirectories than will fit in the Directory Tree window.

The Directory Tree window is a document window. You can resize and move this window in the File Manager workspace. You can enlarge it to fill the entire File Manager workspace or you can shrink it to an icon.

## Changing Disk Drives

When you start File Manager, the Directory Tree shows the directory structure on the current disk drive. You can tell which disk drive is current because its icon and letter are highlighted.

Select another disk drive icon to display the directories on that disk.

### ▷ To select another disk drive and display its Directory Tree:

---

**Mouse** □ Click the disk-drive icon for the drive you want.

- Keyboard**
1. Press TAB to move to the disk-drive icon area.  
If you want to move back to the Directory Tree window without changing drives, press TAB again.
  2. Press the DIRECTION keys to select the icon you want and then press ENTER.

**HINT** If you are using a keyboard, you can hold down CTRL and press the letter for the disk drive you want to select.

## Using Network Disk Drives

If you are connected to a network, you can use any disk drive on the network if you know its location and password. Some networks will even allow you to browse through all the available disk drives.

When you start Windows, it recognizes network connections you already made and shows the network drives as distinct icons, different from other drive icons.

**NOTE** When you select the disk drive icon for the network, the path appears in the status bar at the bottom of the File Manager application window.

## ***Connecting to and Disconnecting from Network Drives***

You can use File Manager to connect to additional network disk drives or to disconnect from disk drives to which you are currently connected. You must connect to the network before you start Windows or the network options will be dimmed.

### **▷ To connect to a network disk drive:**

1. Choose Connect Net Drive from the Disk menu.

The Connect Network Drive dialog box appears. File Manager assumes you want to assign the next available letter and enters that letter in the Drive Letter drop-down list box.

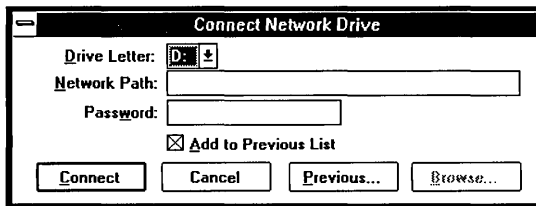

2. If you want to assign a different drive, open the Drive Letter drop-down list box and choose the letter you want.  
Or you can type the drive letter in the Drive Letter text box.
3. Type the network pathname required to locate the drive, and type the password (if a password is required).  
File Manager will maintain a list of previous connections if you want. Then you can select a connection from the Previous list rather than typing the network path. To select from the Previous list, choose Previous. The Previous Network Connections dialog box appears. Select the path you want from the list.
4. If this is a new connection and you want to add it to the Previous list, make sure the Add to Previous List check box contains an X.
5. Choose Connect.

**NOTE** Some non-Windows applications let you connect to network drives while running the application. If you make such a connection, you should disconnect from the network drive before quitting the application.

▷ **To disconnect from a network drive:**

---

1. If your current drive is also the network drive, choose a different drive. You cannot disconnect the current drive.
2. Choose Disconnect Net Drive from the Disk menu.  
The Disconnect Drive dialog box appears.
3. Select the network drive you want to disconnect.  
A message appears, asking you to confirm the drive that you want to disconnect.
4. Choose OK.

**NOTE** If you are running Windows in 386 enhanced mode, you might not be able to disconnect from network drives that were active before you started your Windows session.

### ***Browsing Through Network Disk Drives***

Some networks allow you to browse through the drives on the network until you find the one you want. If your network does not provide this capability, the Browse button in the Connect Network Drive dialog box will be dimmed.

▷ **To view the available network drives:**

---

1. Choose Connect Net Drive from the Disk menu.
2. Choose Browse.  
File Manager displays a dialog box that lists the available drives. This dialog box will look different for different networks.

For example, if you are using the Microsoft LAN Manager version 2.0, the dialog box will look like the following illustration.

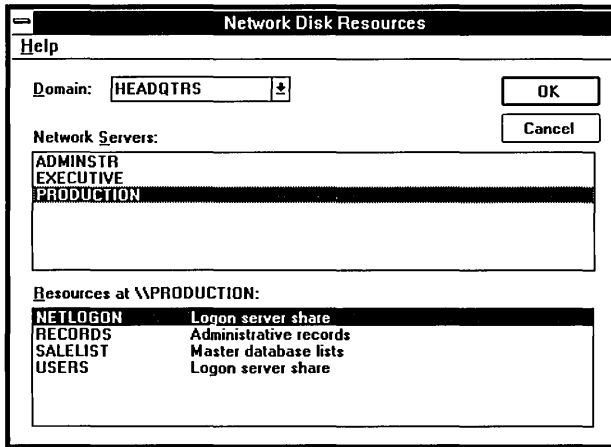

- To view the shares on another network server, click the network server name from the Network Servers list box.  
Or use the DIRECTION keys to move the highlight to the network server name.
- To specify a connection to one of the listed shares, select the share from the Resources list box.
- Choose OK.  
The Connect Network Drive dialog box appears.
- Choose Connect.

## Changing Directories

The selection cursor, a dotted rectangle around the highlighted icon and text, marks the current directory in the Directory Tree window.

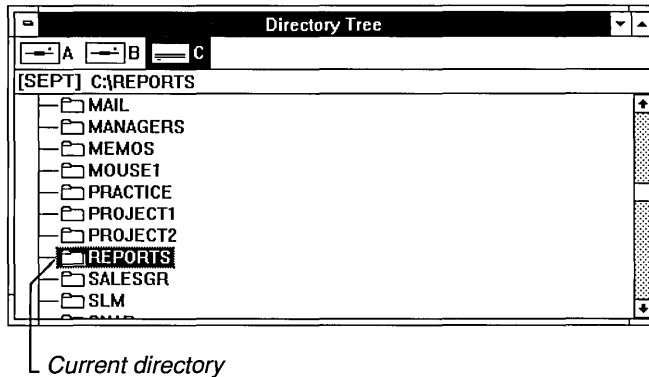

You can select only one directory at a time in this window. To change to a different directory, you move the selection cursor.

### ▶ To select another directory:

**Mouse** □ Click the directory name that you want to select.

**Keyboard** □ Use the following keys to select a directory.

#### To move to

#### Press

A directory above or below the current directory

UP or DOWN ARROW

The root directory

HOME

The last directory in the list

END

The first subdirectory of the current directory, if one exists

RIGHT ARROW

The next directory level up from the current directory, if one exists

LEFT ARROW

The directory one window up from the current directory

PAGE UP

**To move to**

The directory one window down  
from the current directory

The previous directory at the same  
level, if one exists

The next directory at the same level,  
if one exists

A specific directory name

**Press**

PAGE DOWN

CTRL + UP ARROW

CTRL + DOWN ARROW

The first letter of the directory name

## Expanding Directory Levels

You can control the level of directory information shown in the Directory Tree window. When you first start File Manager, the Directory Tree shows the first level of directories on the current disk drive. You use the commands on the Tree menu to expand and reduce the directory information shown.

In the following Directory Tree illustration, you will see that one directory icon contains a plus sign (+). A plus sign indicates that one or more subdirectories exist for that directory.

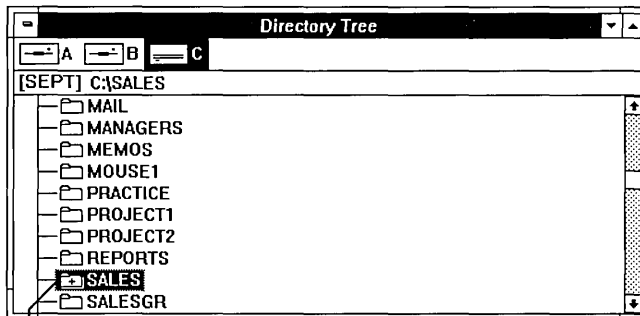

↳ Expandable directory

If you select a directory icon that contains a plus sign, File Manager lists the subdirectories. This is called *expanding* the directory. You can expand an entire branch, a single level of the branch, or all branches. The directory icon for an expanded directory contains a minus sign (-).

▷ To expand one level of a directory:

**Mouse**    □ Click the plus sign (+) in the directory icon next to the name of the directory you want to expand.

**Keyboard**    1. Use the DIRECTION keys to select the directory you want to expand.  
2. Choose Expand One Level from the Tree menu.  
    Or press the PLUS (+) key.

You use the Expand Branch command to show all directory levels beneath a selected directory.

▷ To expand an entire branch:

1. Select the directory you want to expand.  
2. Choose Expand Branch from the Tree menu.  
    Or press the ASTERISK (\*) key.

You use the Expand All command to display all directory levels in the Directory Tree at once.

▷ To expand all branches in the Directory Tree:

□ Choose Expand All from the Tree menu.  
    Or press CTRL + ASTERISK (\*).

## ***Collapsing Directory Levels***

You can collapse a directory to retract any listed subdirectories. The minus sign (-) changes to a plus sign (+) next to the directory name. All directories are collapsed when you start File Manager.

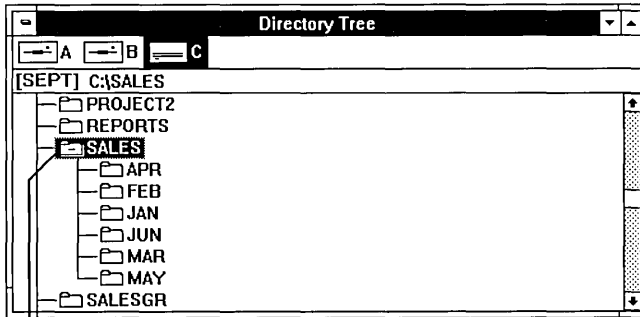

↳ Collapsible directory

### ▷ To collapse a directory:

**Mouse** □ Click the minus sign (-) in the directory icon next to the name of the directory you want to collapse.

**Keyboard**

1. Use the DIRECTION keys to select the name of the directory you want to collapse.
2. Choose Collapse Branch from the Tree menu.  
Or press the HYPHEN (-) key.

Only the directory names are displayed, no subdirectories. The minus sign (-) changes to a plus sign (+) to indicate that the additional levels are available.

## Working with Directory Windows

The Directory Tree window shows you the overall structure of your directories. From the Directory Tree window you can open *directory windows*.

A directory window is a document window. You can resize and move this window in the File Manager workspace. You can enlarge it to fill the entire File Manager workspace or you can shrink it to an icon.

From a directory window, you can list the contents of other directories, change the information you see, and reorder the files that are listed.



## Opening Directory Windows

To view the contents of a directory, you must open its directory window. More than one directory window can be open at a time. The number of directory windows you can have open depends on available memory.

Directory windows open in front of the Directory Tree. Subdirectories and all the files in a selected directory are listed in its window.

The disk drive and pathname appear at the top of the window in the title bar. The pathname shows the location of the directory in relation to the root directory. Directories in the pathname are separated by backslashes (\).

From a directory window, you can open windows for any of the directories displayed and work with the various files and directories included.



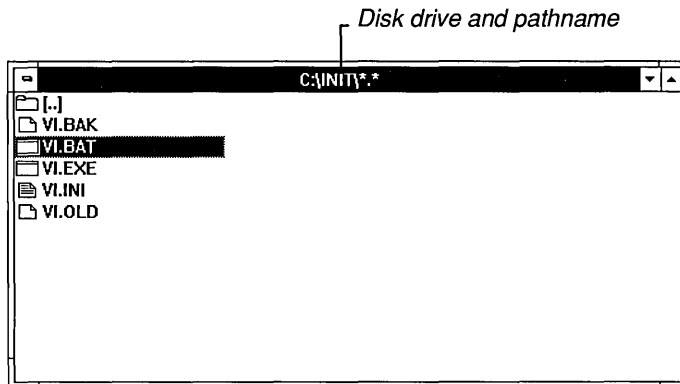

### ▷ To open a directory window:

- In the Directory Tree window or a directory window, double-click the directory name.

Or press UP ARROW or DOWN ARROW to select the directory you want to open. Then press ENTER or choose Open from the File menu.



The icon to the left of the filename indicates whether the file is a directory, a program file, a document file, or another type of file. The table that follows describes the various icons you'll see in directory windows.

<u>Icon</u>	<u>Kind of file</u>
	Directories. These are listed first, in alphabetical order.
	Program files and batch files. The default filename extensions are .EXE, .COM, .PIF, and .BAT. These files can start up applications.
	Document files. These files are associated with an application. When you choose these files, they start up the application and load the associated document into the application workspace.
	All other files.

**NOTE** You can change the default for an icon by modifying the WIN.INI file, a special initialization file that contains the default settings Windows uses throughout its operation. To learn about changing Windows initialization settings, start Notepad (or any other text editor) and open the WININI.TXT file.

## Selecting Open Directory Windows

Although many directory windows can be open on your desktop at a time, only one of those windows can be *active*. A directory window must be active before you can work in that directory. To make an inactive window active, you select it.

### ▶ To select an open directory window:

**Mouse** □ Click anywhere in the window.

Or choose a window from the list at the bottom of the Window menu.

**Keyboard** 1. Press ALT, HYPHEN (-) to open the Control menu.

2. Press T to choose Next.

3. Repeat steps 1 and 2 until you select the window you want.

Or you can select the window you want from the list at the bottom of the Window menu. Then press ENTER to open the window.

**HINT** To cycle quickly through the open directory windows, press CTRL + F6 (or CTRL + TAB) until the window you want appears.

When the window is selected, the title bar changes color or intensity and the window moves in front of the other open windows.

**HINT** If the window you want to select is hidden by another window, you can use the Cascade or Tile command (on the Window menu) to rearrange the open File Manager windows so that all of them are visible. You can also move or resize any windows that are covering the window you want.

## ***Replacing the Contents of the Active Directory Window***

As you open directory windows, each appears in front of other directory windows that are already open. If you want, you can tell Windows to *replace* the contents of the active directory window whenever you want new directory information. That way, fewer directory windows are open at a time.

### **▷ To replace the contents of the active directory window:**

- Choose Replace on Open from the View menu. (A checkmark appears next to the command when it is active.)

You can cancel the command at any time by choosing it again.

Only the contents of the active directory window are replaced. Other open directory windows remain open. Their contents are not altered.

## ***Changing the Information Displayed in Directory Windows***

When you first use File Manager to display a directory window, filenames are listed in alphabetical order. You can change the order of the files and list details about them by using commands from the View and Options menus.

If the Directory Tree window is active when you choose a command on the View menu, the directory windows you open afterward will be affected. Directory windows that are already open will not change.

If a directory window is active, most View commands will affect only that window. However, three commands on the View menu—Other, Sort By, and Include—provide an option called Set System Default. When you select Set System Default, File Manager uses your choices in the dialog box as the new settings for all directory windows you open subsequently.

**NOTE** To save the new settings, make sure the Save Settings check box in the Exit File Manager dialog box contains an X when you exit File Manager.

## Changing the Information Displayed for Each File

You can use the first three commands on the View menu to tell File Manager what kind of information to display in the directory window. File Manager can display all file information, the names of the files and directories only, or selected information.

When you first start File Manager, the Name command is checked. This means that only file and directory names appear in a directory window.

### ► To change the information displayed for each file:

1. Select the directory window whose file information you want to change.
2. Choose Name, File Details, or Other from the View menu.

If you choose Name or File Details, the change takes place immediately. If you choose Other, the View Other dialog box appears.

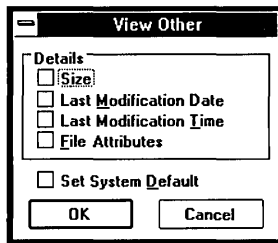

3. Select the options for the information you want to display. The table that follows describes each option. If you want these same options to apply to all other directory windows you open, make sure the Set System Default check box contains an X.
4. Choose OK.

You can select the following options from the View Other dialog box:

<u>Use this option</u>	<u>To do this</u>
Size	Show the size of each file in bytes.
Last Modification Date	List the date the file was last modified.

<u>Use this option</u>	<u>To do this</u>
Last Modification Time	List the time of day the file was last modified. (The time and date are taken from the system clock.)
File Attributes	Indicate whether files are hidden, read-only, archive, or system files. (See “Setting File Attributes” later in this chapter.)
Set System Default	Make the options selected in this dialog box apply to all directory windows you open. Otherwise, the change will apply only to the active directory window. To save these settings, make sure you select the Save Settings check box when you exit File Manager.

If the Directory Tree window is active when you choose the Other command, the settings you specify become the new system settings.

If a directory window is active, then the settings affect only the active window unless the Set System Default check box contains an X. If you select this option, the new settings affect the active window and any subsequent windows you open. Directory windows that are already open remain unchanged.

### ***Choosing the Order in Which Files Are Displayed***

When you first open directories, File Manager displays the contents of each directory with subdirectories listed first and then all the files, sorted alphabetically by filename. You can change this by telling File Manager to sort by file type, size, or last modification date.

If the Directory Tree window is active when you choose a sort command, the settings you create with the command become the new system settings. If a directory window is active, then the settings affect only the active window unless you select the Set System Default check box. If you select this option, the new settings affect the active window and any subsequent directory windows you open.

You can sort files according to file type. This means that files are sorted alphabetically according to their extension—the last three characters of the filename. For example, files ending with .COM would appear before files ending with .EXE. You can also sort files based on other file information such as the date each file was created.

▷ To change the order of sorting in a directory window:

1. Select the directory window whose order of sorting you want to change.
2. Choose By Name, By Type, or Sort By from the View menu.

If you choose By Name or By Type, the change occurs immediately. If you choose Sort By, the Sort By dialog box appears.

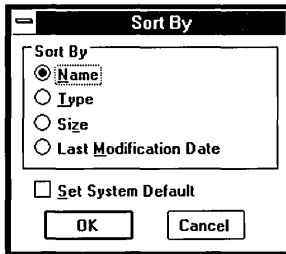

3. Select one of the options. If you want these sort options to apply to all subsequent directory windows that you open, also make sure the Set System Default check box contains an X. The table that follows describes each option.
4. Choose OK.

You can select the following options in the Sort By dialog box:

<u>Use this option</u>	<u>To do this</u>
Name	Sort by filename, in alphabetical order.
Type	Sort by extension, then by filename prefix, in alphabetical order.
Size	Sort by file size, from largest to smallest.
Last Modification Date	Sort by the date when the file was last modified, with the most recently modified file listed first.
Set System Default	Make the options selected in this dialog box apply to all directory windows you open. Otherwise, the change applies only to the active directory window. To save these settings, make sure you select the Save Settings check box when you exit File Manager.

## Choosing the Type of File to Display

When you first use File Manager, it displays all the files and directories in each directory window. You can tell File Manager to display certain types of files, or groups of files with similar filenames and/or extensions.

▷ **To change the type of files displayed in the directory window:**

---

1. Select the directory window whose list you want to change.
2. Choose Include from the View menu.

The Include dialog box appears.

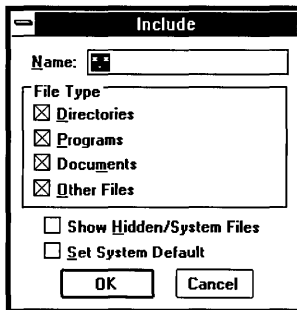

3. Select the options that specify which files you want to display. If you want these options to apply to all subsequent directory windows, also select Set System Default. The table following this procedure describes each option.
4. Choose OK.

You can select the following options in the Include dialog box:

<u>Use this option</u>	<u>To do this</u>
Name	Display files with similar names. Use MS-DOS wildcard characters to specify a group of files. You could, for example, display only those files with the filename extension .TXT by typing *.TXT in this box. The default is *.* , meaning all files in the directory. (For more information on using wildcard characters, see your MS-DOS manual.)
File Type	Choose the types of files you want to display. The Directories option displays all the subdirectories this directory contains. The Programs option displays all files that have .EXE, .COM, .PIF, or .BAT extensions. The Documents option displays text and graphics files that are associated with an application. The Other Files option displays everything else.
Show Hidden/System Files	Display all files for which the system or hidden file attribute is set. See “Setting File Attributes” later in this chapter.
Set System Default	Make the options selected in this dialog box apply to all directory windows you open. Otherwise, the change will apply only to the active directory window. To save these settings, make sure you select the Save Settings check box when you exit File Manager.



## Choosing Other Display Options

File Manager lets you make a few other, more minor changes to the way your File Manager windows appear on the desktop.

### ▷ To change the display options:

- Choose any of the following commands from the Options menu.

#### Use this command

#### To do this

Lower Case

Change the information in the directory window between uppercase letters and lowercase letters.

Status Bar

Turn the status bar (at the bottom of the directory window) on and off. In a directory window, the status bar displays the number of files selected, the disk space occupied by them, and the total number of items listed in the window. In the Directory Tree, the status bar shows the number of bytes available on the disk drive. When the active drive is a network drive, the status bar also shows the network pathname for the drive.

Minimize on Use

Shrink File Manager to an icon whenever you run an application from a directory window.

## Arranging Directory Windows

The Window menu includes two commands, Cascade and Tile, to help you organize the way File Manager windows appear on your screen. These commands affect the Directory Tree window and any open directory windows.

### ▷ To arrange the open File Manager windows:

- Choose Cascade or Tile from the Window menu.

If you choose Cascade, File Manager arranges the windows so that they overlap, starting in the upper-left corner of the File Manager workspace. Each window's title remains visible, making it easy for you to select any window.

If you choose Tile, File Manager resizes and arranges the windows to fit in the File Manager workspace so that each window's contents are visible and no windows overlap.

## ***Updating Directory Windows***

File Manager updates open directory windows automatically, in most cases. For example, if you save a file using Notepad, the file will show up immediately in the proper directory window. Sometimes, however, especially if you are using network directories, File Manager cannot complete an automatic update. In that case, you can use the Refresh command to update the active directory window.

### **▷ To update a File Manager window:**

- ❑ Choose Refresh from the Window menu.

## ***Closing Directory Windows***

### **▷ To close the active directory window:**

- ❑ Double-click the Control-menu box.  
Or press ALT, HYPHEN (-) and choose Close from the Control menu.

### **▷ To close all the open directory windows:**

- ❑ Choose Close All Directories from the Window menu.

## ***Working with Files and Directories***

This section explains how to use File Manager commands to work with your files and directories. With a few exceptions, all the tasks described in this section apply to both files and directories. The exceptions are creating a directory, printing a file, and viewing file information. These topics are discussed separately.

You can also work with files and directories individually or in groups. When the instructions tell you to select a file or directory, you can select as many files and directories as you want. See “Extending a Selection” later in this section.

## Naming Files and Directories

Many File Manager tasks involve naming or renaming files and directories. Windows follows the rules of MS-DOS for naming files:

- The name of a file or directory can have two parts: a name and an optional extension. The two parts are separated by a period (.). For example, MYFILE.NEW is a valid filename, where MYFILE is the name of the file and .NEW is the filename extension.
- The name can be up to eight characters and the extension up to three characters.
- Names must start with either a letter or a number and can contain any uppercase or lowercase characters except the following:

.	(period)	"	(quotation mark)
/	(slash)	\	(backslash)
[ ]	(brackets)	:	(colon)
;	(semicolon)		(vertical bar)
=	(equal sign)	,	(comma)

- The following cannot be used as names: CON, AUX, COM1, COM2, COM3, COM4, LPT1, LPT2, LPT3, PRN, and NUL.

Examples of valid filenames are:

LETTER.DOC  
MEMO.TXT  
BUDGET.89  
2NDTRY.RPT

## Creating Directories

You can create a new directory by using the Create Directory command. File Manager creates a subdirectory in the current directory. If the Directory Tree window is active, the current directory is the one that is selected.

After you create a directory, you can copy files and directories into it from other locations by using the Move and Copy commands. See “Moving and Copying Files and Directories” later in this chapter.

▷ To create a new directory:

1. Select the directory in which you want the new directory.
2. Choose Create Directory from the File menu.

The Create Directory dialog box appears.

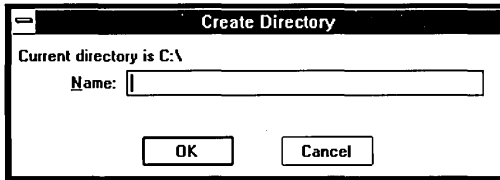

3. Type the name for the new directory and choose OK.

Directory names follow the same conventions as filenames. They can have up to eight characters followed by a period and an extension of one to three characters.

## ***Searching for Files and Directories***

When you want to find a file or directory but can't remember where it is located, you can use the Search command. By using MS-DOS wildcard characters, you can search for a group of files or directories that have related filenames or extensions.

For example, if you name all your correspondence with an .LTR extension, you can tell File Manager to search for \*.LTR. File Manager will list every letter (.LTR) file on the current disk.

If files are found that match the information you specified, the filenames are listed in the Search Results window. You can select items in this window and use most File Manager commands, just as you would in any directory window. However, you cannot copy or move other files *into* the Search Results window.

▷ To search for a file or directory:

1. Select the disk drive and the directory you want to search.
2. Choose Search from the File menu.

File Manager displays the Search dialog box.

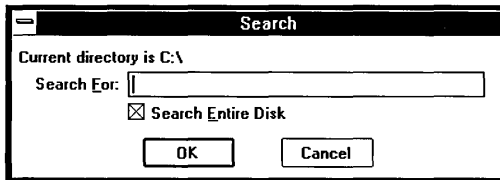

3. Type the name of the file or directory, using wildcard characters if you want to search for a group of files or directories with similar names or extensions.

Examples:

<u>Type this</u>	<u>To find these files</u>
<i>filename.ext</i>	The file with the name you typed
*.abc	All files with the extension .ABC

4. File Manager will search the entire disk drive. To search the current directory and its subdirectories, make sure the Search Entire Disk check box is empty.
5. Choose OK.

File Manager begins searching at the root directory (or, if you canceled Search Entire Disk, at the current directory) and searches through all branches of the Directory Tree for the current disk drive. It displays a window called Search Results that lists all the files and directories it found.

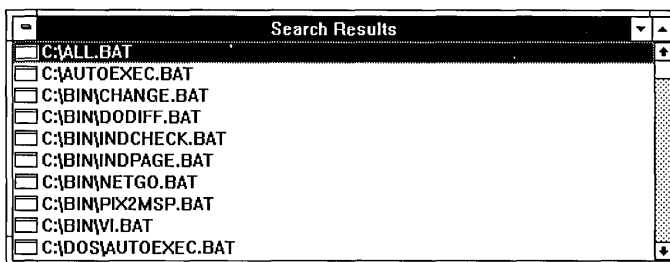

The Search Results window looks like a directory window except that the full pathname for each file and directory is always included. You cannot change the way this information is displayed. Nor can you move or copy files into the Search Results window.

However, you can select files and directories in the window and use File menu commands to print, copy, and move window contents. You can also shrink the Search Results window to an icon. The Search Results window is listed in the Window menu, along with the other open windows.

The Search Results window remains open until you close it or shrink it to an icon. The contents of the Search Results window are replaced when you use the Search command again.

## Selecting Files and Directories

Before you can work with a file or a directory, you must select one.

### ▷ To select a file or directory:

**Mouse** □ Click the filename or directory name.

**Keyboard** □ Use the following keys to select files and directories:

<u>To select</u>	<u>Press</u>
A file or directory above or below the current selection	UP or DOWN ARROW
The last file or directory in the list	END
The first file or directory in the list	HOME
The file or directory at the top of the previous window	PAGE UP
The file or directory at the bottom of the next window	PAGE DOWN
A specific file or directory in the list	The first letter of the name until you reach the file or directory you want

## Extending a Selection

In directory windows, you can select more than one file or directory at a time. Selecting more than one item in a directory window is called *extending* a selection. For example, you can select several files and move them to another directory. You can select a group of files or directories that appear in consecutive order or that are scattered throughout the list.

▷ **To select two or more items in sequence:**

- Mouse**
1. Click the first filename or directory name you want to select.
  2. Hold down SHIFT while you click the last item in the group.

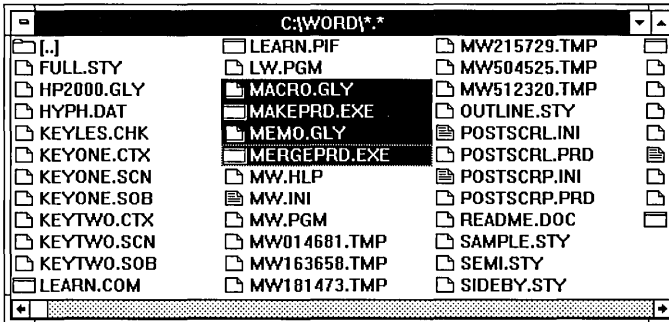

- Keyboard**
1. Press the DIRECTION keys to move to the first item you want to select.
  2. Hold down SHIFT while you press the DIRECTION keys to select the remaining items in the group.

You can also extend the selection to items that are not in consecutive order.

▷ **To select two or more items out of sequence:**

- Mouse** □ Hold down CTRL while you click each item.

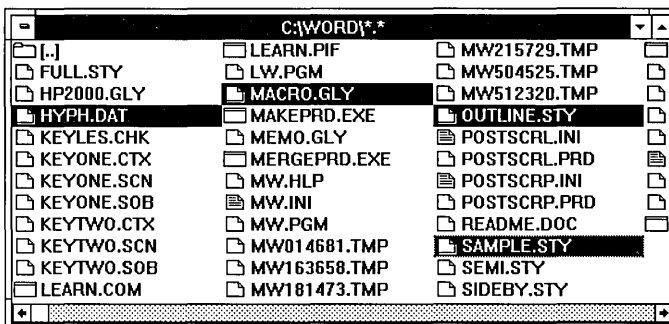

- Keyboard**
1. Press and release SHIFT + F8.  
The selection cursor begins to blink.
  2. Press the DIRECTION keys to move to each item.
  3. Press the SPACEBAR to select each item.
  4. Press SHIFT + F8 again when you are finished extending the selection.

You can also select more than one group of items by combining selection techniques.

▷ **To select more than one group of items:**

- Mouse**
1. To select the first group of items, click the first item and then hold down SHIFT while you click the last item in the group.
  2. To select the next group of items, hold down CTRL while you click the first item in the next group. Then hold down CTRL + SHIFT while you click the last item in the group.

- Keyboard**
1. To select the first group of items, hold down SHIFT while you press the DIRECTION keys to move from the first to the last item in the group.
  2. Press and release SHIFT + F8.  
The selection cursor begins to blink.
  3. Press DIRECTION keys to move to the first item in the next group of items.
  4. Press the SPACEBAR to select the first item.
  5. Press SHIFT + DIRECTION keys to select the remaining items in the group.
  6. Press SHIFT + F8 again when you are finished extending the selection.

▷ **To select all the files in a directory window:**

- Choose Select All from the File menu.  
Or press CTRL + SLASH (/).



## Canceling a Selection

### ▷ To cancel a selection:

**Mouse** □ Hold down CTRL while you click the item.

- Keyboard**
1. If you have not already done so, press SHIFT + F8.  
The selection cursor begins to blink.
  2. Press DIRECTION keys to move to the item.
  3. Press the SPACEBAR.
  4. Press SHIFT + F8 to cancel selection mode.

### ▷ To cancel all selections:

- Choose Deselect All from the File menu.  
Or press CTRL + BACKSLASH (\).

**HINT** If you want to select a group of files that have related filenames, first choose the command you want and then type MS-DOS wildcard characters in the dialog box to select the files you want. For example, to move all files with the extension .TXT to a new directory, choose Move from the File menu. When the dialog box appears, type \*.TXT in the From text box and type the name of the new directory in the To text box. To learn more about MS-DOS wildcards, see your MS-DOS manual.

## Moving and Copying Files and Directories

You can move and copy files and directories from one File Manager location (called the *source*) to another (called the *destination*) by dragging the source file or directory with the mouse or by using the Copy or Move command. You can copy and move items between directories, to and from the Directory Tree, and between disk drives. The destination can be a window or an icon.

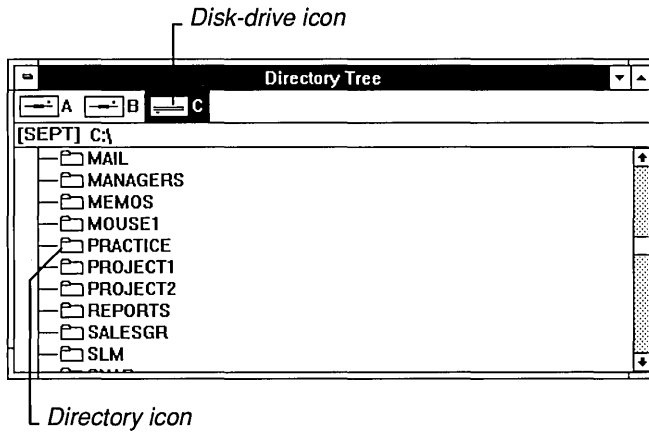

If you use a mouse, the items you move and the destination (the window or icon) must both be visible. You can use the Tile command on the Window menu to arrange the windows. You can also copy program files and document files from File Manager to Program Manager groups if you use a mouse.

In the Directory Tree window, you can select only one directory at a time. From a directory window, you can move or copy more than one file or directory at a time by extending your selection. See “Extending a Selection” earlier in this chapter for information about extending a selection in a directory window.

### ▷ To move files or directories:

- Mouse**
1. Make sure the source and destination directories (or disk-drive icon) are visible.
  2. Hold down ALT while you drag the source file or directory to the destination window, icon, or disk drive.

The mouse pointer changes to the icon for the file or directory and it moves out of the directory window as you slide the mouse.

3. Release the mouse button, and then release ALT.

A confirmation message appears. (You can suppress this confirmation message by selecting Confirmation from the Options menu as explained later in this chapter.)

4. To complete the move, click Yes.

**HINT** If you are moving files or directories to a destination on the same disk drive, you can simply drag with the mouse. You do not have to use the ALT key.

- Keyboard**
1. Select the file or directory you want to move.
  2. Choose Move from the File menu.

The Move dialog box appears with the name of the source file or directory in the From text box.

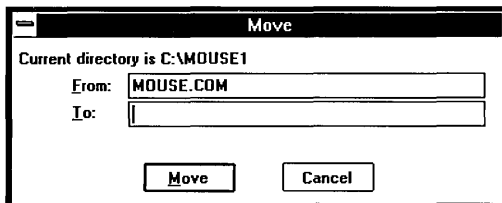

3. Type the pathname for the destination in the To text box.
4. Choose Move.  
A confirmation message appears.
5. To complete the move, choose Yes.

If the destination contains a file with the same name as the file you are moving, File Manager asks if you want to overwrite it. If you want to replace the existing file, choose OK.

The file or directory disappears from its original location and appears in the destination. If you move a directory, all the files and directories contained in it move with the directory.

▷ **To copy files or directories:**

- Mouse**
1. Make sure the source and destination directories (or disk-drive icon) are visible.
  2. Hold down CTRL while you drag the source file or directory to the destination window, icon, or disk drive.  
The mouse pointer changes to a copy of the icon for the file or directory.
  3. Release the mouse button, and then release CTRL.  
A confirmation message appears. (You can suppress this confirmation message by selecting Confirmation from the Options menu as explained later in this chapter.)
  4. To complete the copy, click Yes.

**HINT** If you are copying files or directories to a different disk drive, you can simply drag with the mouse. You do not have to use the CTRL key.

- Keyboard**
1. Select the file or directory you want to copy.
  2. Choose Copy from the File menu.  
The Copy dialog box appears.

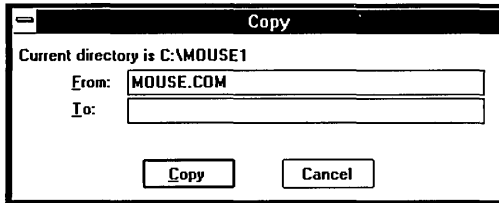

3. Type the pathname of the destination in the To text box.
4. Choose Copy.

If the destination contains a file with the same name as the file you are copying, File Manager displays a warning message. Make sure you want to replace the existing file; then choose OK.

The file or directory is copied to the destination and remains in the directory window for the source directory as well. If you copy a directory, all the files and directories contained in it are copied too.

**NOTE** You can copy document files and program files from a directory window in File Manager to a group window or group icon in Program Manager by dragging with a mouse. See “Changing the Contents of a Group” in Chapter 3 for the complete procedure.

## Deleting Files and Directories

You can delete files and directories from any disk drive. File Manager is much more powerful for deleting directories than MS-DOS. When you delete a directory with File Manager, all files and all subdirectories within the directory are also removed.

---

**CAUTION** Be very careful about deleting files and directories. The Delete command removes them from your disk. They are not recoverable after you delete them.

---

▷ To delete a file or directory:

1. Select the file or directory you want to delete.
2. Choose Delete from the File menu.  
The Delete dialog box appears.
3. Choose Delete to remove the selected file or directory, or type another name if you decide you want to remove a different item.  
File Manager asks you to confirm the deletion. (You can suppress the confirmation message if you want to omit this extra step.)
4. Choose Yes.

**NOTE** You can extend the selection of files or directories to more than one. If you choose more than one file or directory to delete, you are asked to confirm each one.

## Suppressing Confirmation Messages

If you do not want to see a confirmation dialog box each time you want to delete or replace files, directories, and subtrees, you can change the confirmation settings. You can also cancel the setting that requires you to confirm mouse operations like moving and copying.

If you turn off the confirmation dialogs, Windows will carry out delete, replace, and mouse operations as soon as the command is issued.

**NOTE** When File Manager deletes a directory, all files and subdirectories in that directory are also removed from your disk.

▷ To suppress confirmation messages:

1. Choose Confirmation from the Options menu.  
The Confirmation dialog box appears.

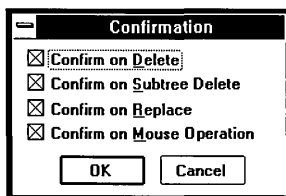

2. Clear the check box for each confirmation option you want to cancel. Choose OK.

The confirmation options are described as follows.

<u>Use this option</u>	<u>To do this</u>
Confirm on Delete	Display a warning message before deleting files.
Confirm on Subtree Delete	Display a warning message before deleting directories.
Confirm on Replace	Display a warning message before writing over an existing file.
Confirm on Mouse Operation	Display a warning message before completing a direct manipulation with a mouse, such as dragging, moving, or copying.

## ***Renaming Files and Directories***

You can rename any file or directory by choosing the Rename command from the File menu.

---

**CAUTION** Do not rename any of the files you received with Windows.

---

### **▷ To rename a file or directory:**

1. Select the file or directory you want to rename.  
You can select directories from either the Directory Tree or a directory window. You can select files from a directory window only.
2. Choose Rename from the File menu.  
The Rename dialog box appears.
3. Type the new name in the To text box and choose Rename.  
If a file with the new name already exists, File Manager asks if you want to write over the existing file. Choose OK to write over it or Cancel if you want to start over with a different name.

## Printing Files

Most applications have a Print command you can use to print files created with the application. You should use that command, rather than the File Manager Print command, whenever possible. The application usually provides formatting capabilities and other options that enhance the appearance of the printed material.

Only text files will print reliably when you use the File Manager Print command. Files created by Notepad, for example, are text files. Text files contain no special characters or formatting and are usually named with the .TXT extension. If you try to print non-text files using the Print command, some unexpected “garbage” characters might appear in the printout or nothing at all will print.

When you do print from File Manager, the file is printed on the active printer. Before you use the Print command, you should set up your printer. If you did not set up a printer when you installed Windows, you can do so at any time by using Control Panel. See “Installing a Printer” in Chapter 5 for more information.

### ▷ To print a file:

1. Open the directory window that contains the file you want to print.
2. Select the file you want to print.
3. Choose Print from the File menu.

## Setting File Attributes

File attributes are part of the directory information MS-DOS maintains for each file. This information helps identify a file to MS-DOS and controls the kinds of operations you can perform on the file. The four file attributes are defined in the following table. Their abbreviations appear in the attribute information column in their directory windows.

<u>Abbreviation</u>	<u>Means</u>
<i>R</i>	<i>Read Only</i> . Prevents a file from being changed.
<i>A</i>	<i>Archive</i> . Identifies a file that has been modified. Using some MS-DOS utilities, such as BACKUP and XCOPY, turns off the archive attribute.

<u>Abbreviation</u>	<u>Means</u>
H	<i>Hidden.</i> Prevents a file from appearing in an MS-DOS directory listing, though it is still visible in the directory window. Files with the hidden attribute appear only if you selected Show Hidden/System in the Include dialog box on the View menu.
S	<i>System.</i> Identifies the file as an MS-DOS system file. Files with the system attribute appear only if you selected Show Hidden/System in the Include dialog box on the View menu.

You can see the file attributes in a directory window by choosing the File Details command from the View menu. This command displays all the file information, including the attribute information, in the directory window.

▷ To select and cancel attribute settings:

1. Select the file for which you want to set or cancel attributes.
2. Choose Change Attributes from the File menu.

The Change Attributes dialog box appears.

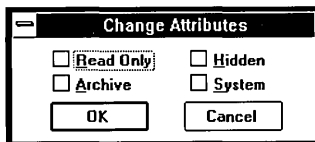

3. Select or clear the check boxes for the attribute settings you want. Attributes are set for each check box that contains an X.
4. Choose OK.

## ***Associating Documents with an Application***

The Associate command lets you associate documents that have the same filename extension with an application. Then, when you choose the document file, the application starts and loads the associated document into the application's workspace. The document file icon represents documents that are associated.



For example, if you associate .DOC filenames with the Microsoft Word program file, then whenever you open any .DOC file, File Manager automatically starts Word and loads the chosen document into the Word workspace.

**NOTE** Windows makes this association for you automatically for most Windows applications. For these applications, any new document you create is automatically associated as well.

▷ **To associate documents with an application program:**

---

1. Open a directory window containing a text or graphics file that you want to associate with an application.
2. Select the filename.
3. Choose Associate from the File menu.

The Associate dialog box appears.

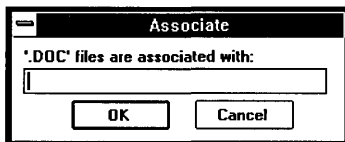

4. Type the program filename or pathname, if necessary, in the text box and choose OK. (Type the complete name of the program file, including any extension. For example, to associate the selected document extension with Microsoft Word, you would type *WORD.EXE* in the text box.)

The icons for all the files with the associated extension will change to document file icons in the active directory window.

If you later decide you no longer want the documents associated with the application (for example, if you remove the application from your disk), you can remove the association.

▷ **To delete the association between a document and an application:**

---

1. Open the directory window containing the document whose association you want to delete.
2. Select the document.

3. Choose Associate from the File menu.  
The application's filename is displayed in a dialog box.
4. Press BACKSPACE to delete the filename.
5. Choose OK.

## ***Starting Applications from File Manager***

You can start an application by opening a program file or a document file from a directory window. Program files typically use .COM, .EXE, .PIF, or .BAT filename extensions. Document files can have any filename extensions that are typically used for text or graphics files. Document files are associated with applications so that they can open the application and load the document when you choose them.

If the application can run in a window, the window will appear in front of any File Manager windows that are open. If the application is a full-screen application, the application screen will replace the File Manager window.

**HINT** If you plan to use an application frequently, you might find it more convenient to add it to a Program Manager group rather than to start it from File Manager. You can copy program and document files from File Manager to Program Manager by dragging with a mouse. To learn how to add items to a Program Manager group, see Chapter 3, "Program Manager."

### **▷ To start an application from a program file or document file:**

- Mouse**
1. Open the directory window that contains the correct file.
  2. Double-click the filename.

- Keyboard**
1. Open the directory window that contains the correct file.
  2. Select the filename.
  3. Choose Open from the File menu, or press ENTER.

To shrink File Manager to an icon as soon as you start an application, choose Minimize on Use from the Options menu.

▷ To start an application and a data file:

- Mouse**
1. Open the directory window that contains the data file. If the program file is not listed in the same directory, also open the directory window that contains the program file.
  2. Drag the icon for the data file onto the program file. (The program must recognize the data file format or the application will not start.)

- Keyboard**
1. Choose Run from the File menu.  
The Run dialog box appears.

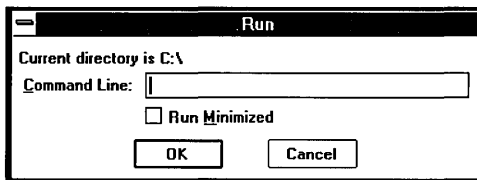

2. Type the pathname for the program file; then press the SPACEBAR and type the pathname (if different from the program file's pathname) for the file you want to open.
3. Choose OK.

**NOTE** As with MS-DOS command lines, you do not need to include the pathname if the files are in the current directory, or the pathname is included in your AUTOEXEC.BAT file.

## ***Maintaining Disks and Diskettes***

The Disk menu includes commands that prepare floppy diskettes for storing information, copy the contents of one diskette to another, and label a disk.

### ***Formatting Diskettes***

Formatting prepares the floppy diskette so that MS-DOS can use it for storing and retrieving information. When you choose the Format Diskette command, File Manager removes all the information from the diskette, writes directory information on it, and checks for unusable portions.

---

**CAUTION** Do not try to format more than one diskette at a time. Windows might let you try if you are using two different applications, but the results are unpredictable.

---

▷ **To format a diskette:**

1. Insert the diskette you want to format into the proper drive.
2. Choose Format Diskette from the Disk menu.
3. If your computer has a dual-diskette drive, select the letter for the drive you want to use for the formatting and choose OK.

If your computer has a single-diskette drive, you will not see the dialog asking you to designate the destination drive.

A Format Diskette dialog box appears asking you to verify that you want to format the diskette. After a diskette is formatted, there is no way to recover any information that was previously stored on it. So make sure that the diskette in the drive you selected is the one you want to format.

4. Choose Format.

A Format Diskette dialog box appears asking you to choose options.

5. If you are formatting a high capacity diskette, make sure the High Capacity option box is selected.

If you want to include system files on the diskette you are formatting, make sure the Make System Disk option box is selected.

6. Choose OK.

A status message appears to keep you informed of the progress as your diskette is being formatted.

## ***Making a System Diskette***

You can use File Manager to copy operating system files onto a diskette. A diskette that includes system files can be used to start up computers with the MS-DOS operating system.

▷ **To copy system files onto a diskette:**

1. Select the drive icon for the disk drive that contains the MS-DOS system files.
2. Insert the destination diskette into the proper drive.
3. Choose Make System Diskette from the Disk menu.

4. If your computer has a dual-diskette drive, select the letter for the drive that contains the diskette and choose OK.

If your computer has a single-diskette drive, you will not see the dialog asking you to designate the destination drive.

A dialog box appears asking you to verify that you want to add system files to the diskette.

5. Choose Yes.

A status message appears to keep you informed of the progress as your system diskette is being formatted.

**NOTE** Not all diskettes can accept system files. A system message will notify you if this is the case.

## ***Copying Diskettes***

You can copy the entire contents of one diskette to another diskette by using the Copy Diskette command from the Disk menu. Typically, this is done to make a backup copy.

You can use the Disk menu Copy Diskette command to copy diskettes only if the diskettes have the same disk capacities. For example, if the *source* diskette (the diskette you want to copy from) holds 720K, the *destination* diskette (the diskette you want to copy to) must also.

To copy between diskettes that have different capacities, you can use the Copy command from the File menu. To copy an entire diskette, use the MS-DOS wild-card \*.\* on your Copy command line.

### **▷ To copy an entire diskette:**

1. Insert the source diskette in the drive you want to copy from and, if you have a dual-diskette drive computer, insert the destination diskette in the drive you want to copy to.
2. Select the disk-drive icon for the source diskette.
3. Choose Copy Diskette from the Disk menu.

4. If your computer has a dual-diskette drive, select the letter for the destination drive and choose OK.

If your computer has a single-diskette drive, you will not need to specify a destination drive.

A dialog box appears, asking you to verify that you want to copy the diskette. When you copy an entire diskette, there is no way to recover information previously stored on the destination diskette. So make sure that the diskette in the destination drive is the one you want to copy to.

5. Choose Copy.

A status message appears to keep you informed of the progress as your diskette is being copied. If your source and destination drives are the same, follow the instructions to switch source and destination diskettes as needed.

## ***Labeling Disks***

You can create a label for a disk that does not already have one, or you can change an existing label by selecting the Label Disk command from the Disk menu.

### **▷ To assign (or change) a volume label:**

1. Click the disk-drive icon for the disk you want to label.  
Or press TAB to move the highlight to the disk-drive icon area and use the DIRECTION keys to select the icon for the disk you want to label.
2. Choose Label Disk from the Disk menu.  
The Label Disk dialog box appears.
3. Type the label name for the disk in the Label text box.  
The name can be up to 11 characters long.
4. Choose OK.

## ***Quitting File Manager***

You can quit File Manager by using the Exit command on the File menu. File Manager asks if you want to save your settings. If the Save Settings check box contains an X, settings created with the following commands are saved:

- All settings on the View menu
- All settings on the Options menu

### **▷ To quit File Manager:**

1. Choose Exit from the File menu.
2. When the Exit File Manager dialog box appears, make sure an X appears in the Save Settings check box if you want to preserve your settings for your next File Manager session. If you do not want File Manager to save your settings, clear the Save Settings check box.
3. Choose OK.

---

---

**Chapter**  
**5**

**Control Panel**

**Starting Control Panel .....145**

**Customizing the Desktop Colors .....147**

- Choosing an Existing Color Scheme ..... 147
- Changing an Existing Color Scheme ..... 148
- Defining Custom Colors ..... 150

**Choosing Desktop Options .....152**

- Displaying Desktop Patterns ..... 152
- Displaying Custom Wallpaper ..... 155
- Changing the Spacing Between Icons ..... 156
- Changing the Sizing Grid ..... 157
- Changing Border Width ..... 157
- Setting the Cursor Blink Rate ..... 158

**Installing a Printer .....158**

- Installing a Printer-Driver File ..... 159
- Selecting a Printer Port ..... 163

**Configuring a Printer .....164**

- Choosing a Printer ..... 165
- Setting the Print Options ..... 166
- Choosing an Active Printer ..... 169
- Choosing the Default Printer ..... 170
- Choosing Timeout Options ..... 171



<b>Connecting to a Network Printer</b> .....	172
<b>Removing an Installed Printer</b> .....	173
<b>Printing Without Print Manager</b> .....	174
<b>Configuring Communications Ports</b> .....	175
<b>Setting Network Options</b> .....	177
<b>Adding and Removing Fonts</b> .....	177
What Are Fonts? .....	178
Viewing Fonts on the Screen .....	178
Adding a Font .....	178
Removing a Font .....	180
<b>Setting International Options</b> .....	180
Basic Settings .....	180
Date Format .....	182
Time Format .....	183
Currency Format .....	185
Number Format .....	186
<b>Customizing Use of the Mouse</b> .....	187
<b>Setting the System Date and Time</b> .....	188
<b>Adjusting Keyboard Speed</b> .....	189
<b>Controlling Sound</b> .....	190
<b>Setting Options for Running in 386 Enhanced Mode</b> .....	190
Handling Device Contention .....	190
Setting Multitasking Options .....	192

# Starting Control Panel

This chapter describes how to use Control Panel, a program that lets you change the way your system is configured while you're using Microsoft Windows. Using Control Panel, you can adjust various hardware and software options.

You start Control Panel by choosing it from Program Manager's Main Group. If Program Manager isn't the active window, use Task List (press CTRL + ESC) to switch to it.

## ▷ To start Control Panel:

1. Open the Main Group window.
2. Double-click the Control Panel icon.

Or use the DIRECTION keys to move the highlight to the icon; then press ENTER.

Windows displays the Control Panel window.

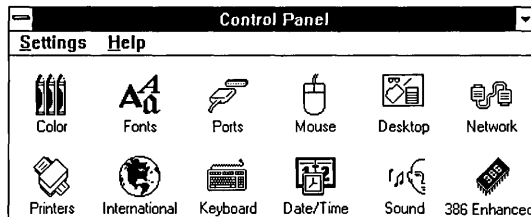

The icons in this window represent the groups of options you can set with Control Panel. For each icon, there is a corresponding command on the Settings menu. The following list summarizes the options you can set.

Choose this icon

To do this



Color

Set the color of the desktop and many elements on it.



Fonts

Add or remove fonts for your printers and display.



Ports

Set the communications parameters for your serial communications ports.



Mouse

Customize the way you use the mouse, including adjusting how fast the pointer moves across the display and setting the speed of double-clicking, as well as swapping the functions of the left and right mouse buttons.



Desktop

Choose patterns or images to decorate the desktop, specify a “magnetic” desktop grid to help you align objects on the desktop, and set the cursor blink rate.



Network

Control your connection to the network. The exact options depend on your network, but might allow you to do such tasks as signing onto and off the network or changing your user identification or password. (This icon is available only if you have a network installed and started.)



Printers

Install and configure printers, which can include assigning output ports, choosing paper sizes and orientation, specifying graphics resolution, connecting to network printers, choosing the default printer, and using the Windows Print Manager program.



International

Set international options such as country and language, number and currency formats, and date and time formats.



Keyboard

Adjust the keyboard repeat rate.



Date/Time

Change the system date and time.

**Choose this icon**

Sound

**386**

386 Enhanced

**To do this**

Turn on or suppress the warning beep that indicates an error condition.

Specify how applications running concurrently in 386 enhanced mode compete for use of peripheral devices and how much of the computer's resources are allocated to Windows applications running in the foreground and background. (This option is available only in 386 enhanced mode.)

▷ **To choose an icon:**

- Double-click the icon.

Or use the DIRECTION keys to move the highlight to the icon you want; then press ENTER to choose it.

Or you can choose the corresponding menu command from the Settings menu.

## ***Customizing the Desktop Colors***

Windows is shipped with several color schemes. You can choose one of these schemes or change the colors to create new schemes, defining custom colors in the process if you want.

### ***Choosing an Existing Color Scheme***

▷ **To choose an existing color scheme:**

1. Choose the Color icon from the Control Panel window.

The Color dialog box appears. The name of the current color scheme is shown in the Color Schemes drop-down list box, and the sample screen shows the colors for the current scheme. (The visible portion of the list box will be empty if you made changes to the current scheme without saving them as a scheme. See the following section for information on saving schemes.)

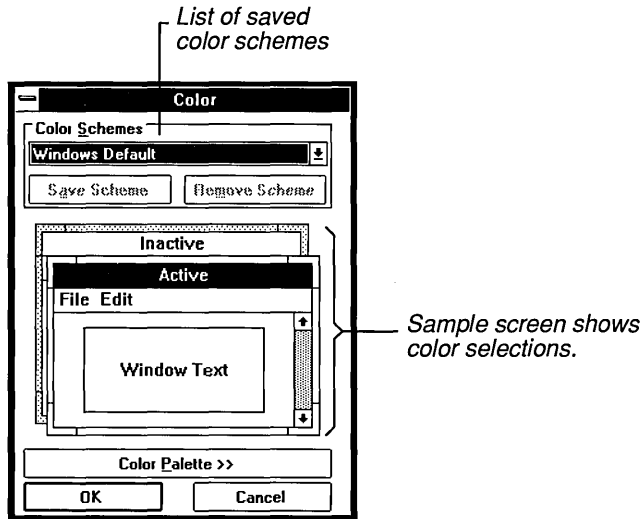

2. Click the Down arrow at the right of the Color Schemes list box to open the drop-down list box.  
Or press ALT + DOWN ARROW.
3. Select the color scheme that you want.  
You can view any scheme by selecting it and looking at the colors shown in the sample screen. Or, as a shortcut, just press UP ARROW or DOWN ARROW to cycle to the next scheme without opening the list box.
4. Choose OK to change to the new scheme.

## ***Changing an Existing Color Scheme***

You can change the color assigned to any Windows screen element. You can make the color change effective until you change it again, or you can save it for future sessions.

### **▷ To change the color selections for a color scheme:**

1. Select the color scheme you want to change from the Color Schemes drop-down list box.
2. Choose the Color Palette button.

Control Panel expands the Color dialog box to include a list of screen elements, a palette of basic colors available on your display, and—until you define additional colors—an empty palette titled Custom Colors.

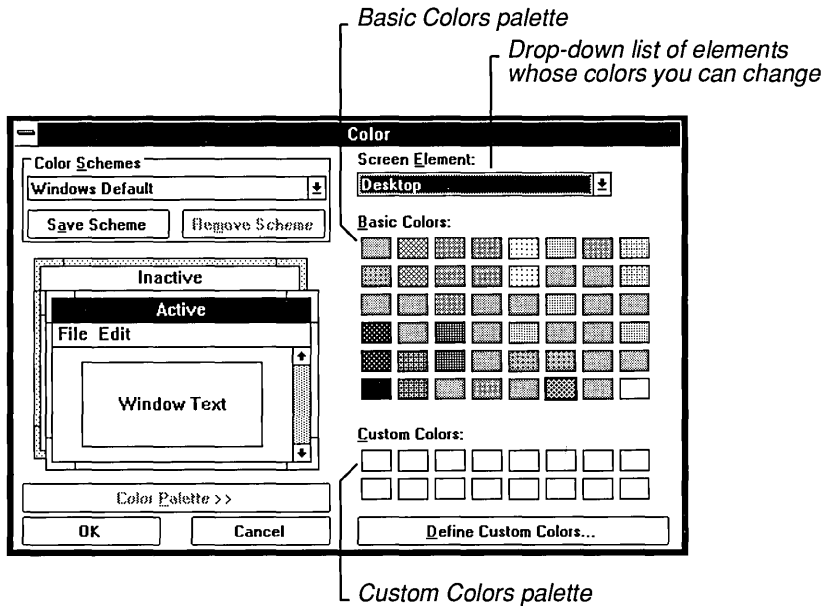

3. In the sample screen, click the element whose color you want to change.  
Or press ALT + DOWN ARROW to open the Screen Element list box. Then select the element from the list.
4. Select a color by clicking the color in the Basic Colors palette.  
Or press TAB to move to the palette and use the DIRECTION keys to move the dotted rectangle to the color you want. Press the SPACEBAR to select the color.  
You'll see the color displayed in the sample screen.
5. Change the color of any other screen elements, until you are satisfied with the color scheme. However, notice that Control Panel will only use the solid color closest to the selected non-solid color for the following screen elements: the Window Frame, Window Text, Window Background, Menu Bar, Menu Text, and Title Bar Text.
6. If you want to save the new color selections, choose the Save Scheme button and type a name for the scheme.

If you don't save the scheme, Windows will use the new color selections until you change them again, even if you quit Windows and restart it. But when you make another change or choose an existing scheme, the color selections will be lost.

7. Choose OK to change the colors.

If you find that you use only one or two color schemes, you can shorten the list of selections by removing schemes you no longer want to have available. The only color scheme that cannot be deleted is Windows Default, the standard scheme that you see the first time you start Windows.

### ▷ To remove an existing color scheme:

1. Select the color scheme from the Color Schemes drop-down list box.
2. Choose the Remove Scheme button.

## Defining Custom Colors

You can specify up to 16 additional colors and use them in your color schemes. Control Panel offers two different methods of defining custom colors:

- By selecting from a *color refiner box* that shows the full range of possible colors.
- By specifying numbers for either hue, saturation, and luminosity or relative amounts of red, green, and blue.

Hue is the position of the color along the color spectrum. Saturation is the purity of the hue, moving from gray to the pure color. Luminosity is the brightness of the color on a scale from black to white. Luminosity takes precedence over saturation, and saturation over hue.

### ▷ To define a custom color:

1. Choose the Color Palette button from the Color dialog box.  
Control Panel expands the Color dialog box to include an empty palette titled Custom Colors.
2. Choose Define Custom Colors from the expanded Color dialog box.  
Windows displays the Custom Color Selector dialog box.

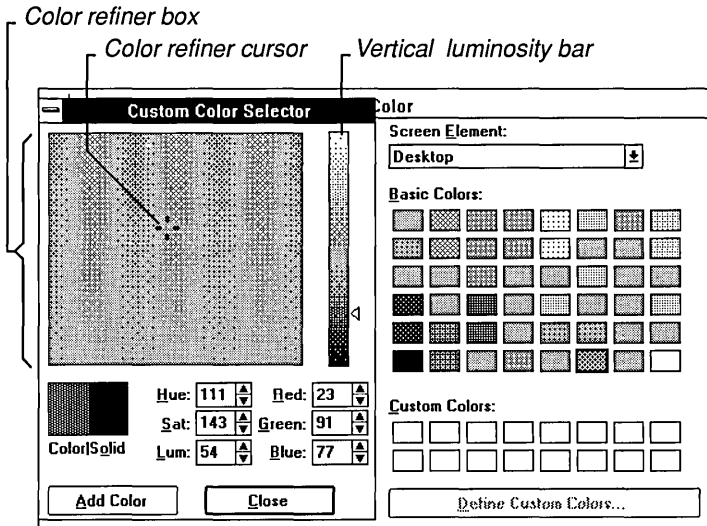

3. Drag the color refiner cursor to the area of the color refiner box that shows the color you want. Then drag the arrow up or down in the vertical luminosity bar to adjust the luminosity of the color.

Or enter values in the Red/Green/Blue or the Hue/Sat/Lum text boxes. You can type values into the boxes or click the scroll arrows to the right of the appropriate text box to increase or decrease the number.

As you change the color, the new color is displayed on the left side of the Color/Solid box. The right side of the box displays the solid color closest to your choice. A solid color is a color directly supported by your display. Non-solid colors are produced by a pattern of colored dots that simulate the desired color. If you want to select the solid color, double-click the right side of the box (or press ALT + O).

4. When you are satisfied with the color, select a box in the Custom Colors palette for the new color. You can select an empty box or one that contains a color you want to change. The new color will replace the current one.

If you do not select a box for the new color, Control Panel places it in the upper-left position in the Custom Colors palette. Subsequent custom colors fill boxes in sequence from upper left to lower right unless you choose a specific box for the new color.

5. Choose the Add Color button to add the new color to the Custom Colors palette.



6. Define any other custom colors you want to add to the palette.
7. To close the Custom Color Selector dialog box and return to the Color dialog box, choose the Close button.

To return to the Color dialog box without closing the Custom Color Selector dialog box, move the Custom Color Selector dialog box to the side.

You can now choose the custom colors the same way you would choose a color from the Basic Colors palette.

## ***Choosing Desktop Options***

You can further customize the appearance of your desktop by displaying a pattern or image as the desktop surface. You can also set a “magnetic” grid to make it easier to align windows and icons on the desktop, and you can adjust the cursor blink rate.

### ***Displaying Desktop Patterns***

When you install Windows, the desktop is a solid color. You can replace the solid color with a pattern by using the Desktop Pattern option. You can choose a pre-designed desktop pattern or create one of your own.

The background color for the pattern will be the same as the Desktop color. The foreground color (the lines that make up the design) will be the same as the color of the Window Text screen element. See “Customizing the Desktop Colors” earlier in this chapter.

#### **▷ To choose a pattern:**

1. Choose the Desktop icon from the Control Panel window.  
Control Panel displays the Desktop dialog box.

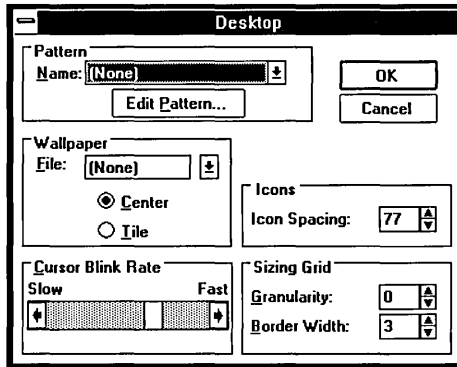

2. Click the Down arrow in the Pattern Name list box to open the drop-down list box.  
Or press ALT + DOWN ARROW.
3. Select a pattern from the list of names.  
You can view any pattern by selecting it and choosing OK. Or, as a shortcut, just press UP ARROW or DOWN ARROW to cycle to the next pattern without opening the list box.
4. Choose OK.

If you are using a mouse, you can change an existing desktop pattern or create a new one and save it with a new name.

#### ▷ To change an existing pattern:

1. Choose the Edit Pattern button in the Desktop dialog box.  
You'll see a dialog box in which you can choose a pattern to change.
2. Click the Down scroll arrow to open the Pattern Name drop-down list box.  
Or press ALT + DOWN ARROW.
3. Choose a pattern from the list.  
You'll see a sample of the pattern in the Sample box and a cell in which you can make changes to the pattern. (The cell shows an enlarged version of the pattern.)

4. In the cell, click locations where you want to reverse the colors in the pattern.  
You cannot change a pattern with the keyboard.
5. When the Sample box shows the pattern you want, choose the Change button and then choose OK.

▷ **To create a new pattern:**

1. Choose the Edit Pattern button in the Desktop dialog box.  
The Edit Pattern dialog box appears, showing a sample of the selected pattern in the Sample box.
2. Type a name for the new pattern.
3. Click locations where you want to reverse the colors in the pattern.
4. When the cell shows the pattern you want, choose the Add button and then choose OK.  
The pattern is now available for use from the Pattern Name drop-down list box in the Desktop dialog box.

The pattern you define is repeated as many times as necessary to completely fill the background. If you design an asymmetrical pattern, the individual cells may combine to form an overall pattern that you didn't expect. If you experiment with the patterns, you'll soon understand the effects you can create. Remember, the colors of the pattern are determined by the desktop and window text colors you choose.

If you find that you use only one or two patterns, you can shorten the list of selections by removing patterns you no longer use.

▷ **To remove a pattern:**

1. Choose the Edit Pattern button in the Desktop dialog box.
2. Select the pattern you want to remove.
3. Choose the Remove button.
4. Choose Yes to confirm the deletion.
5. Choose OK.

## Displaying Custom Wallpaper

You can alter the appearance of your desktop dramatically by displaying a bitmap as *wallpaper* in place of the desktop color or pattern. You can display any bitmap (any file with the .BMP extension), even an elaborate one such as a scanned color photograph.

You can use Paintbrush or another painting program that produces .BMP files to create a bitmap to use as wallpaper. After you create the bitmap, copy the .BMP file into the directory where Windows is located. If the file is not in the same directory, Control Panel won't be able to locate the bitmap unless you type in a full pathname.

Not all bitmaps will cover the entire desktop when the wallpaper is displayed. You can repeat small bitmaps by selecting the Tile options.

**NOTE** If Windows is running in real mode and using expanded memory, after you change the wallpaper, you must restart Windows to display your new wallpaper selection.

### ▷ To choose a bitmap to display as wallpaper:

1. Choose the Desktop icon from the Control Panel window.
2. Click the Down scroll arrow in the Wallpaper File box to open the list.  
Or press TAB to reach the list and then press ALT + DOWN ARROW.
3. Select a bitmap from the Wallpaper File drop-down list box.  
Or type in a full pathname for the bitmap.

4. Select Center or Tile.

The Center option positions the bitmap in the center of the desktop. The Tile option repeats the bitmap as many times as is necessary to cover the entire desktop, placing the first copy in the upper-left corner of the desktop.

If you select both a pattern and custom wallpaper in the Desktop dialog box, the wallpaper overlays the pattern. If you select the Center option for the wallpaper and the bitmap doesn't cover the entire desktop, you'll see the pattern around the edges of the bitmap. If the original bitmap is too large to fit or takes up too much memory, Windows will not display it at all.

5. Choose OK.

If you want to remove a wallpaper from the list, delete the bitmap file from the directory that contains Windows.

**NOTE** When Windows displays wallpaper, it uses more memory than when it displays a solid color or a desktop pattern. If you run out of memory when running applications, changing to a color or pattern will free up some memory for use by applications.

## ***Changing the Spacing Between Icons***

Windows calculates the standard spacing for application, document, and program item icons based on the size of the widest icon. Usually this spacing is adequate. However, sometimes the description for an icon exceeds the icon's width, causing it to overlap adjacent icons.

You can increase the space between icons by typing a higher number in the Icon Spacing text box. The number represents pixels, the smallest unit of measurement on the screen. Increments of 10 pixels result in noticeable increases in spacing between icons.

### **▷ To increase icon spacing:**

1. Choose the Desktop icon from the Control Panel window.
2. Move to the Icon Spacing text box in the Icons area.
3. Click the Up or Down scroll arrow to the right of the text box to increase or decrease the spacing between icons. Or type the number you want.
4. Choose OK.

The spacing change occurs when you choose Arrange Icons from Task List for application icons or from the Windows menu for document and program item icons.

## ***Changing the Sizing Grid***

Until you set the granularity of the invisible sizing grid to a number greater than 0, the grid is off. And Windows leaves icons and windows wherever you place them on the desktop. With the sizing grid set to a number greater than 0, all items on your desktop align in an orderly fashion and conform to the spacing of the invisible grid whenever you move any of them. They “snap” to the nearest invisible grid line. The grid affects both the position and size of windows you manipulate.

### **▷ To set the grid spacing:**

1. Choose the Desktop icon from the Control Panel window.
2. Move to the Granularity text box in the lower-right portion of the dialog box.
3. Click the Up or Down scroll arrow to the right of the text box to increase or decrease the size of the grid. Or type the number you want.

The allowed range is 0 through 49. The grid changes in multiples of eight pixels. A value of 1 creates a grid with magnetic spots every eight pixels, 2 places magnetic spots every 16 pixels, and so forth. For each increment of 1, the distance between grid lines increases by eight pixels. A value of 0 cancels the grid.

4. Choose OK.

## ***Changing Border Width***

You can change the width of the borders around all the windows on your desktop except those (such as Control Panel) with a fixed size.

### **▷ To change the border width:**

1. Choose the Desktop icon from the Control Panel window.
2. Move to the Border Width text box at the bottom right of the dialog box.
3. Click the Up or Down scroll arrow to the right of the text box to increase or decrease the width. Or type the number you want.

The allowed range is 1 through 49, with 1 being the narrowest border.

4. Choose OK.

## ***Setting the Cursor Blink Rate***

If the cursor blinks too fast or too slow for your optimal use, you can change the rate.

### **▷ To change the cursor blink rate:**

1. Choose the Desktop icon from the Control Panel window.
2. Move to the Cursor Blink Rate scroll bar.  
Or press ALT + R.
3. Slide the scroll box toward Fast or Slow to move quickly to a new blink rate.  
Or click the Right or Left scroll arrow to speed up or slow down the rate, respectively.  
Or press RIGHT ARROW or LEFT ARROW to move the scroll box.
4. Choose OK.

## ***Installing a Printer***

When you use the Setup program to install Windows, Setup runs Control Panel for the first time so you can install one or more printers. If you did not install a printer when you installed Windows or simply want to add another one, use the procedures described in this section. See Appendix A, “Using Setup to Maintain Windows,” for more information about installing Windows.

Microsoft Windows Help and the PRINTERS.TXT document provide some specific information about many of the printers supported by Windows. It is also a good idea to read your printer manual.

To use a printer with Windows applications, you need to do the following:

- Install the printer-driver file for that printer on your hard disk.
- Select the port to which you want to assign the printer.
- Choose the printer and printer settings you’ll use with the installed printer-driver file.
- Choose the active printer for each port.
- Choose the default printer.

## ***Installing a Printer-Driver File***

Windows comes with printer-driver files for most of the commonly used printers. A printer-driver file gives Windows important information about your printer, including details about printer features and the printing interface, descriptions of fonts (such as sizes and styles), character translations, and control sequences the printer uses to achieve various formats.

When you choose to install a printer, Control Panel displays a list of printers from which to select. If you do not find your printer in this list, it means that Windows does not have a printer-driver file specifically for your printer. Your printer might be supported, however, through a printer-driver file for another printer, or a driver might have been developed since Windows was shipped. For more information about what to do in this situation, see “If Your Printer Is Not Listed in the Printers Dialog Box” later in this chapter.

### **▷ To install a printer-driver file by using Control Panel:**

1. Choose Control Panel from the Main Group window in Program Manager.  
The Control Panel window appears.
2. Choose the Printers icon.  
The Printers dialog box appears.
3. Choose the Add Printer button.

The dialog box expands to display a list of printers for the printer-driver files available on the Setup disks. These drivers are part of the Windows package, and the ones you select are copied onto your system.

If you did not install a printer during Setup, Control Panel will automatically choose the Add Printer button for you.



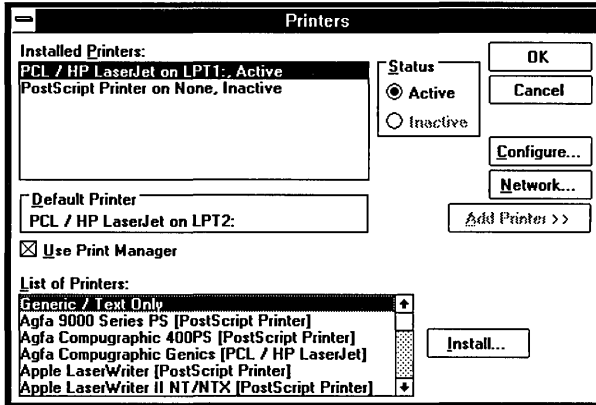

4. In the List of Printers box, select the printer you want to install.
5. Choose Install.

A dialog box appears, instructing you to insert the disk that contains the printer-driver file for the selected printer. If a driver for that printer is already on your system, you'll see a dialog box asking if you want to use the existing driver or install a new one. For more information, see the following section.

6. Insert the disk that contains the printer-driver file and choose OK.

Control Panel installs the printer-driver file for the printer you selected. It does not configure your particular printer to operate with the installed printer driver. Most printer drivers are common to a number of different printer models. To customize the printer-driver file so that your printer works with Windows, you must follow all the printer configuration procedures later in this chapter.

For the first printer driver you install, the name of the printer driver appears highlighted in the Installed Printers box along with *LPT1* to indicate the port assignment and *Active* to indicate the current status. Subsequent printer drivers you install will appear with *None* for the port assignment and *Inactive* for the current status.

If appropriate, a dialog box also appears, prompting you for the disk that contains the font files or other files associated with the printer.

7. If Control Panel prompts you for another file, insert the appropriate disk and choose OK.

Windows copies the file to your hard disk.

**NOTE** Before you can actually print something using the printer driver you installed, you must complete the following procedures for assigning a printer port (if necessary), making

the printer active (if necessary), and configuring the printer to operate the way you want with Windows. All printer drivers come with standard settings for features such as printer model, paper source, paper size, and orientation. You can change these settings when you configure your printer.

### ***If a Printer-Driver File Is Already Installed***

Because printer-driver files can be used by more than one printer, there may be times when you choose to install a new printer and find that the printer-driver file it uses has already been installed. You might also have a printer-driver that you installed in a previous version of Windows.

If a printer-driver file already exists on your hard disk, a dialog box appears when you choose Install in the Printers dialog box.

You can choose either to use the currently installed version of the printer-driver file or to install a new version. If you want to install a newer printer-driver file, choose New. Otherwise, choose Current.

#### **▷ To use the currently installed printer-driver file:**

---

- Choose Current in the dialog box reporting the existing printer-driver file.  
Control Panel installs the new printer using the currently installed printer driver.

#### **▷ To install a newer version of the existing printer-driver file:**

---

1. Choose New in the dialog box reporting the existing file.  
Another dialog box appears, instructing you to insert the disk that contains the printer-driver file.
2. Insert the disk and choose OK.  
The new printer-driver file replaces the existing one, and all the printers using that printer-driver file will now use the new one.  
If appropriate, a dialog box appears, prompting you for the disk that contains other files associated with the printer.
3. Insert the disk that contains the files and choose OK.  
Windows copies the font files to your hard disk.

## ***If Your Printer Is Not Listed in the Printers Dialog Box***

If your printer does not appear in the Printers dialog box, you can still make your printer work with Windows.

The first thing you should do is check the Hardware Compatibility List provided in the Windows package. If your printer is not on the Hardware Compatibility List, you should check the printer manual. It might indicate whether your printer is 100 percent compatible or has an emulation mode that is compatible with one of the printers in the List of Printers box. Look for a section on *dip switch settings* or *modes* in the index of the manual.

For example, many dot-matrix printers can be made compatible with an Epson® printer by changing dip switch settings on the back of the printer. Also, many laser printers can be made compatible with an HP® LaserJet® by changing dip switch settings or by selecting the proper choice from a menu panel on the printer. When you use your printer in emulation mode, however, be aware that you might not be able to use all the features unique to the printer.

If your printer is not 100 percent compatible and does not have an emulation mode that is compatible with one of the printers in the List of Printers box, you have two options.

- Contact your printer manufacturer for a new printer driver that works with Windows.
- Request the Driver Library Disk from Microsoft. Microsoft adds drivers as they become available. See the Hardware Compatibility List for contact information.

See the next section, “Installing a Printer Driver Not Supplied by Windows,” for instructions on installing such a printer-driver file.

If none of these suggestions works for you, choose Generic/Text Only from the List of Printers box. The Generic/Text Only printer-driver works with most printers and should be chosen for daisy-wheel printers. It prints text, but no graphics.

## ***Installing a Printer Driver Not Supplied by Windows***

If you receive a new driver from a printer manufacturer, you should follow any special instructions the manufacturer provides for the installation.

If there are no special instructions, use the procedure outlined earlier in this chapter for installing a printer-driver file. When asked to select the name of your printer, select Unlisted Printer at the end of the List of Printers box.

There might be files other than the printer driver you will need to copy before you can operate your printer. So, before you configure printer settings, make sure you copy all other associated files into the \SYSTEM subdirectory of the directory that contains Windows. You can use File Manager to complete this procedure. See Chapter 4, "File Manager," for instructions for copying files.

Complete the remaining procedures to configure your printer properly.

## Selecting a Printer Port

After you install the printer-driver file on your hard disk, you must assign the printer to a port.

### ▷ To select the printer port:

1. Choose the Printers icon from the Control Panel window.
2. From the Installed Printers box, select the printer for which you want to choose a port.
3. Choose Configure in the Printers dialog box.

You'll see the Configure dialog box in which the ports are listed. LPT ports are parallel ports. COM ports are serial ports. EPT is a port used for certain printers, such as the IBM® Personal Pageprinter. You can use the EPT port only if you have installed a special card in your computer. FILE is used for printing to a file.

The Ports box

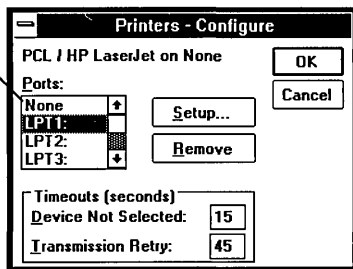

4. Select the port you want to assign the printer to.

If you are connecting a serial printer to a serial port, you might need to use the Control Panel's Ports feature to change the port's communications settings (that is, provide the correct port, baud rate, parity, data bits, flow control, and stop bits). Windows automatically sets the most commonly used communications settings for serial printers, and these settings should work with most printers. See also "Configuring Communications Ports" later in this chapter.

If you want the option of printing to a file first rather than immediately to a printer, select the FILE option from the list of ports. See Chapter 6, "Print Manager," for more information on printing to a file.

While you have the Configure dialog box open, you must change the default configurations to match your printer. For a description of configuration options, see the following section, "Configuring a Printer."

5. Choose OK when you are ready to return to the Printers dialog box.

The selected port appears next to the highlighted printer in the Installed Printers box.

**386**

### ***Setting Access Priorities for 386 Enhanced Mode***

If you are using non-Windows applications in 386 enhanced mode, you can determine what happens when several applications compete for access to a printer port. For more information, see "Setting Options for Running in 386 Enhanced Mode" later in this chapter.

## ***Configuring a Printer***

After connecting your printer to your computer, installing the printer-driver file, and selecting a port, you need to follow some or all of the listed procedures before printing.

- Choose the correct printer for the printer-driver file you installed.
- Change printer settings, such as the paper you want to print on from standard letter size to another size.
- Change the printer that is active on a particular port.
- Choose a default printer when you install more than one printer.
- Choose the time you want Windows to wait before sending you messages about printer problems.

## Choosing a Printer

Because different kinds of printers can use the same printer-driver file, you must use the Configure command to tell Windows what printer you will use with the printer-driver file you installed.

### ▷ To choose a printer:

1. Choose the Printers icon from the Control Panel window.
2. Choose Configure from the Printers dialog box.
3. Choose Setup from the Configure dialog box.

A Setup Printer dialog box appears, displaying the current print options for the printer-driver file you are configuring. The following is an example of a Setup Printer dialog box for the HP LaserJet Series II. (This dialog box will show the options specific to the printer-driver you install.)

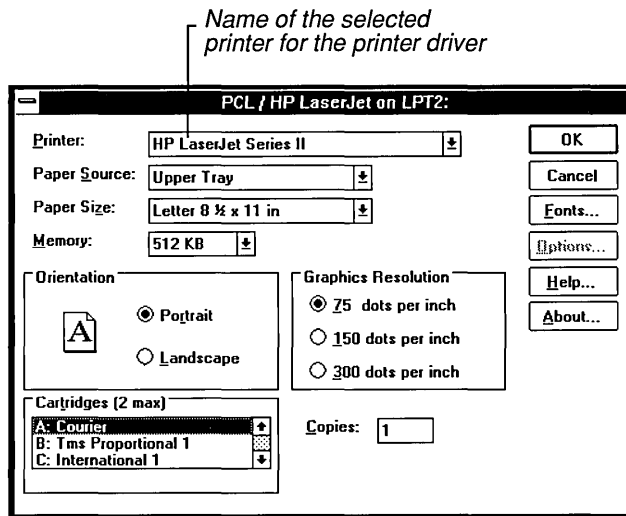

4. Select the name of your printer from the list in the Printer drop-down list box. While you have the Setup Printer dialog box open, you can change optional configurations of your printer. For a description of other print options you can set, see the following topic.
5. Choose OK to return to the Configure dialog box.

## Setting the Print Options

Print options are printer-specific settings such as the page orientation—portrait or landscape—or the manner in which paper feeds through the printer. These options vary from printer to printer.

When you install a new printer, you must set the Printer option in the Setup Printer dialog box to indicate the printer you want to use with a printer-driver file. See the preceding section, “Choosing a Printer,” for a description of how to set the Printer option.

Additionally, Windows sets other print options that should work for your printer in most situations. You can change these settings to do such things as use a different paper size or change the way paper feeds through the printer.

▷ **To change the standard print options:**

---

1. Choose the Printers icon from the Control Panel window.  
The Printers dialog box appears.
2. From the Installed Printers box, select the printer for which you want to change the standard print options.
3. Choose Configure.  
The Configure dialog box appears.

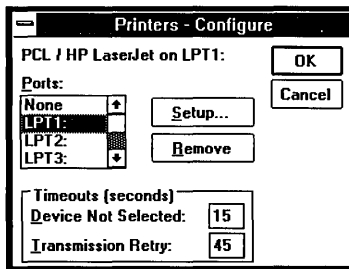

4. Choose Setup.  
A Setup Printer dialog box appears, displaying the current print options for the selected printer. The following is an example of a Setup Printer dialog box. (This dialog box will show the options specific to the printer-driver you install.)

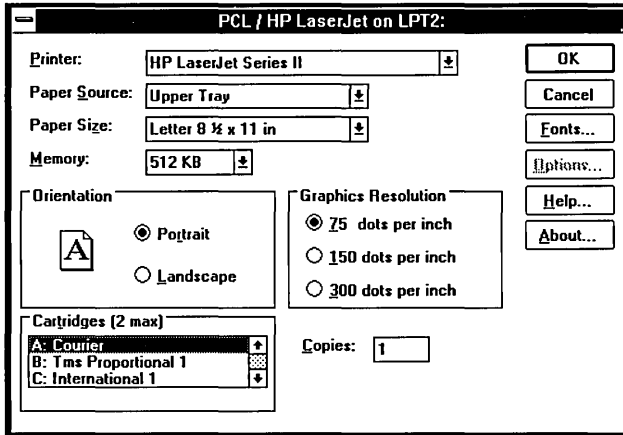

5. Make any necessary changes to the options and choose OK.

The following list explains some of the common print options that you will find in a Setup Printer dialog box. However, since each printer's Setup Printer dialog box is different, the terms used may be different or not exist for every printer.

#### Use this option

#### To do this

Printer

Specify the printer you are using with a printer-driver file. *You need to set this option when you install a printer.* See "Choosing a Printer" earlier in this chapter for a description of how to set the Printer option.

Paper Source (or Feed)

Specify the tray or bin feeder option if your printer uses single sheets of paper. A Tractor setting assumes your printer prints on paper that feeds continuously into the printer on tractor wheels. On some printers, you can choose to feed paper manually.

Paper Size (or Format)

Use a nonstandard paper size. For most printers, Windows assumes that you want to print on standard letter-size paper (8 1/2 by 11 inches). If you are using a different size paper, you must change this setting to accommodate the new size.



<u>Use this option</u>	<u>To do this</u>
Memory	Specify the amount of printer memory. See your printer's manual or contact the manufacturer to find out how much you have. If you can't find the information, simply use the default setting.
Orientation	Specify <i>portrait</i> or <i>landscape</i> orientation. Portrait means the page is taller than it is wide when you view the printed text upright. Landscape means the page is wider than it is tall when you view the printed text upright.
Graphics Resolution	Select Graphics Resolution if your printer supports printing graphics at different resolutions. Graphics resolution options can appear in the Setup Printer dialog box as High, Medium, or Low, or as dots per inch (such as 300 DPI or 120 x 144). The more dots per inch, the higher the resolution. Higher resolutions print more slowly but produce a higher quality picture. Lower resolutions print faster and can give you a quick, but lower quality, copy of your picture.
Cartridges	Select up to the maximum number of cartridges that can be physically plugged in to your printer from the list of those available for that printer.
Fonts	Set up additional fonts on your printer. Fonts can be either font cartridges or downloadable soft-font files. Notice that these are fonts supplied by a printer or font vendor, not the fonts supplied with Windows.
Options	Select from the unique options available for that printer. See Windows Help or the on-line documents for more information on these additional options.
Help	Obtain specific information about how to set up the options in the printer-driver file and any special printer settings you may need to use when printing with this printer driver from Windows.

You might also be able to change the print options while using some Windows applications. See the documentation for your Windows application to find out if this feature is supported.

**NOTE** If you change the port a printer is connected to, be sure to check the print options to make sure they are correct. Print options settings do not follow a printer from one port to another.

## Choosing an Active Printer

When you install more than one printer on a port, you must choose which printer will be the active one. The active printer is the printer currently connected to the port. Although you can assign more than one printer to a port, only one printer can be active on that port at a time.

You can change the active status of a printer at any time.

### ▷ To choose the active printer for a port:

1. Choose the Printers icon from the Control Panel window.  
The Printers dialog box appears.

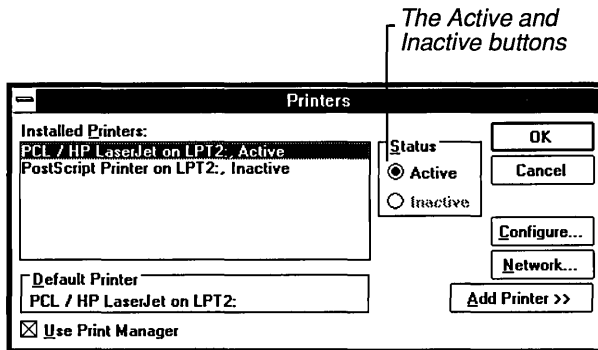

2. In the Installed Printers box, select the printer you want to designate as active.
3. Select Active.  
The word *Inactive* changes to *Active* next to the printer's name in the Installed Printers box.
4. Choose OK to return to Control Panel.

## Choosing the Default Printer

The default printer is the printer that many Windows applications automatically use when you choose the Print command. You can have only one default printer and it must also be the *Active* printer.

### ▶ To choose a default printer:

1. Choose the Printers icon from the Control Panel window.  
The Printers dialog box appears.

*The name of the default printer appears here.*

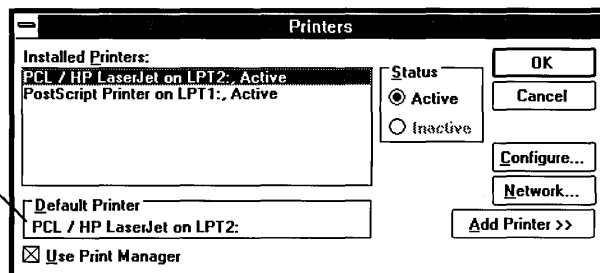

2. In the Installed Printers box, double-click the printer you want to use as the default printer (or select the printer and press ALT + D).  
The printer's name appears in the Default Printer box.
3. If necessary, choose Configure and then Setup to set print options for the default printer.  
See "Setting the Print Options" earlier in this chapter for more information about print options.
4. Choose OK when you are ready to return to the Control Panel window.

If you have several printers installed, you can use Control Panel anytime you want to change the default printer.

Other Windows applications sometimes use the Printer Setup command so that you can choose a default printer for only that application. See the documentation for the application to see if this feature is supported.

## Choosing Timeout Options

You can use the Timeout options in the Printers dialog box to adjust the amount of time Windows waits before sending you messages about printer problems. The Device Not Selected setting controls the amount of time Windows waits before notifying you that a printer is off-line. The standard setting is 15 seconds. The Transmission Retry setting controls the amount of time Windows waits for output characters to be received by a printer before notifying you that it cannot print to the device. The standard setting is 45 seconds.

The standard settings for the Timeout options work with all printers, and you should use these settings unless you are having a specific problem. For example, you might need to change the Transmission Retry setting to greater than 45 seconds if you are printing to a serial port or printing complicated graphics. It sometimes takes longer to transmit information to serial printers than to parallel printers and for printers to print complex graphic pictures. If you print to a network printer and network traffic is heavy, there may be enough of a delay to require you to change to higher timeout settings. Printing to a PostScript printer might also require higher settings.

### ▷ To change either of the Timeout options:

1. Choose the Printers icon from the Control Panel window.  
The Printers dialog box appears.
2. From the Installed Printers box, select the printer you want to change a Timeout setting for.
3. Choose Configure.  
The Configure dialog box appears.

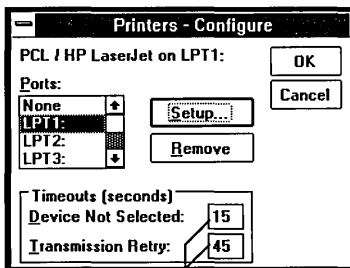

Type new Timeout options here.

4. In the Device Not Selected box, type the number of seconds you want Windows to wait before sending you a message that the printer is off-line.
5. In the Transmission Retry box, type the number of seconds you want Windows to wait before sending you a message that it cannot print to your printer.
6. Choose OK when you are ready to return to the Printers dialog box.
7. Choose OK to return to Control Panel.

## ***Connecting to a Network Printer***

Instead of connecting a printer to your computer with a printer cable, you might use a network printer. If you did not connect to the network printer before starting Windows, you'll have to make the connection before printing. This section is applicable only if you installed Windows for use with a network and have a network running currently.

### **▷ To connect to a network printer:**

1. Choose the Printers icon from the Control Panel window.  
The Printers dialog box appears.
2. Choose Network.  
The Network Connections dialog box appears. This dialog box lists any network printer connections that have already been made. (Contents of this dialog box vary depending on the type of network you are using.)

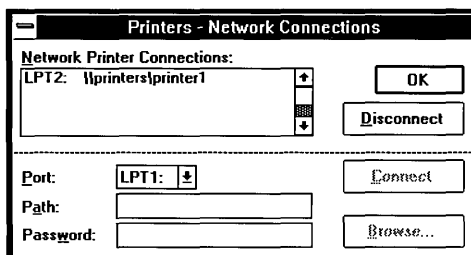

3. Click the Down arrow to open the Port drop-down list box.  
Or press ALT + DOWN ARROW.
4. Choose the port you want to use.

5. Type the network name for the printer in the Path text box. Check your network documentation for the information required in the Path or Password fields.
6. If a password is required, type it in the Password text box.  
An asterisk (\*) appears for each character you type.
7. Choose the Connect button.  
Control Panel adds the printer connection to the list in the dialog box. Notice that if another network printer is already connected to the port you chose, Control Panel prompts you to disconnect the other printer.
8. Choose OK to return to the Printers dialog box.

**NOTE** If your network supports it, you'll be able to choose the Browse button to look at the list of available network printers. See Chapter 4, "File Manager," for an explanation of the Browse dialog for networks.

▷ **To disconnect from a network printer:**

1. Choose the Network button from the Printers dialog box.
2. Select the network printer you want to disconnect from.
3. Choose the Disconnect button.

## ***Removing an Installed Printer***

If you are no longer using an installed printer, you can remove the printer from the Installed Printers box in Control Panel.

▷ **To remove an installed printer:**

1. Choose the Printers icon from the Control Panel window.  
The Printers dialog box appears.
2. In the Installed Printers box, select the printer you want to remove.
3. Choose Configure.  
The Configure dialog box appears.

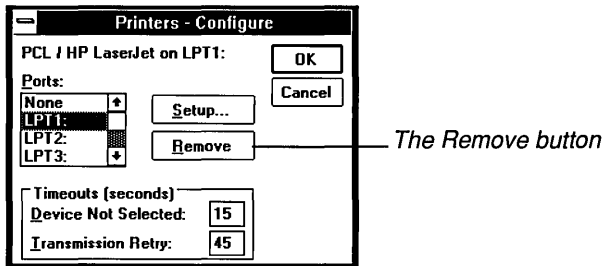

4. Choose Remove.  
A dialog box asks you to confirm the removal.  
The printer disappears from the Installed Printers box.
5. Choose OK to return to the Printers dialog box.

Removing a printer from the Installed Printers box removes the printer-driver file from the Windows directory only if no other printer is using that printer-driver file. Removing the printer-driver file does not remove any associated fonts. Another printer-driver file might be using the fonts. If you want to remove these fonts, see “Removing a Font” later in this chapter for more information.

## ***Printing Without Print Manager***

When Windows Print Manager is turned on, it controls printing in the background while you continue to work with your applications in the foreground. Usually, you will want to use Print Manager because it will free your computer to run other applications while your printer is printing.

However, if you want, you can print from a Windows application without using Print Manager. Your application then prints directly to your local printer or to the network. If you print without Print Manager, you cannot work with your computer until your file is completely delivered to the network print manager or until it finishes printing on your local printer.

### ▷ To print without using Print Manager:

1. Choose the Printers icon from the Control Panel window.  
The Printers dialog box appears.

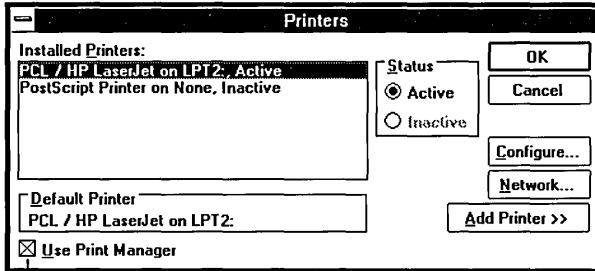

Clear this check box to bypass Print Manager.

2. Clear the Use Print Manager check box.
3. Choose OK.

Print Manager also lets you view information about jobs currently printing, including network print jobs. See Chapter 6, “Print Manager,” to learn how to use Print Manager’s features.

**NOTE** If you use a network printer, turning Print Manager off may or may not speed up printing time. See Chapter 6, “Print Manager,” for a discussion.

## Configuring Communications Ports

Control Panel provides options for specifying the communications settings for each serial port (the ports named COM1, COM2, and so on) used by your system. Serial ports are typically used for connecting modems, mice, or certain printers. The communications settings specify how information is transferred from your computer to the device.



▷ **To configure a communications port:**

1. Choose the Ports icon from the Control Panel window.

Control Panel displays the Ports dialog box showing icons for the four possible serial ports.

2. Double-click the icon for the port whose communications settings you want to specify.

Or use the DIRECTION keys to select the icon for the port you want and then choose the Settings button.

To select more than one port, hold down SHIFT while you select ports and then choose the Settings button.

Control Panel displays the Settings dialog box.

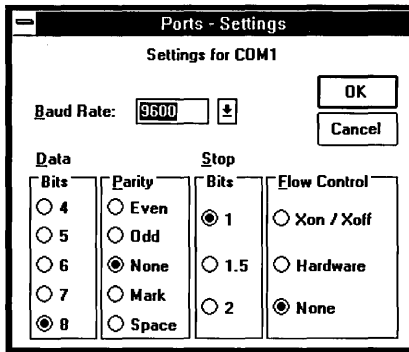

3. Set the options in this dialog box to match the device that is connected to the port.

Refer to the manual you received with the device to find the correct settings.

4. Choose OK.

For information on the communications options, see Chapter 9, "Terminal."

## Setting Network Options

If you installed a network when setting up Windows, the Control Panel window will include a Network icon. You use the options represented by this icon to view information about your network or to set special options that might be available for your network.

When you choose the Network icon, you'll see a dialog box that is specific to your network. The following are some of the options you might be able to set in this dialog box:

- Signing on and off the network
- Changing user ID and password
- Sending messages to other network users

For information about any options available with your network, see the operating guide for your network software and the Help feature (if available) in the dialog box.

## Adding and Removing Fonts

The options represented by the Fonts icon allow you to add and delete *font sets*, which determine what characters will look like on the screen and when they are printed. A font set is a collection of sizes for one typeface, customized for a particular display and printer. Windows supplies raster (or screen) fonts and vector (or stroke) fonts. Printer or font manufacturers provide built-in printer fonts, cartridge fonts, and soft fonts, and Windows supports these fonts through the Windows printer-driver files.

When you send a file to the printer, Windows checks the appropriate printer-driver file to see if it contains the font selected for printing. If the printer-driver file doesn't supply the font, for some printers Windows will generate a raster font from the font files provided in the Windows package, format the characters itself, and send the document to the printer.

## ***What Are Fonts?***

A *font* is a graphic design applied to all numerals, symbols, and characters in the alphabet. A variety of different fonts are available for printing with Microsoft Windows. Choosing the right font can help you create whatever look you want for a document—professional, casual, and so on. Fonts can also make a document easier or harder to read.

Different fonts are usually provided for emphasizing (that is, bolding, italicizing, and underlining) text. Font sizes are measured in points—a point equals 1/72 of an inch. Points describe the height of a character. How much text will fit on one page of a document depends on both the font and the size used. You might want to experiment with the different fonts and sizes supported by your printer to learn how best to use them to get the results you want.

## ***Viewing Fonts on the Screen***

The Windows package includes a basic selection of raster (or screen) fonts for displaying fonts that you choose for printing. (These fonts are also used by some printers, such as dot-matrix or ink-jet type printers.) If Windows does not have a screen font for a font you have chosen to print with, it substitutes a font that resembles the selected printer font as closely as possible. Though it may not look exactly like the font that you see in the printed document, the substitute font creates the same line lengths and page breaks on the screen as you will see in the printed document.

If you purchase extra fonts from a printer or font manufacturer, the font package may or may not include screen fonts. If it does not, you might want to check with the manufacturer to see if they can also supply screen fonts.

## ***Adding a Font***

When you install a printer, any raster (or screen) fonts that can be used by your printer are automatically installed. If your printer-driver file does not supply the corresponding screen fonts for the printer fonts supported, you may be able to obtain some from your printer manufacturer or a font manufacturer. If you are able to obtain additional raster (or screen) fonts, use any installation program provided with the fonts to install them. If no installation program is provided, you can use Control Panel to install the screen fonts.

If the printer-driver file for your printer supports cartridge or soft fonts, you can add these types of fonts by using the printer-driver file's own font installer program. Or, for more information on installing printer fonts, you can start Notepad (or any text editor) and read PRINTERS.TXT.

▷ **To add a font:**

1. Choose the Fonts icon from the Control Panel window.

Control Panel displays the Fonts dialog box. All previously installed fonts are listed in the dialog box, and a sample of the selected font is shown in all the available sizes unless the font is a *vector font*. Vector fonts can be scaled to any height, so the only size that is displayed is the size that was used to design the font.

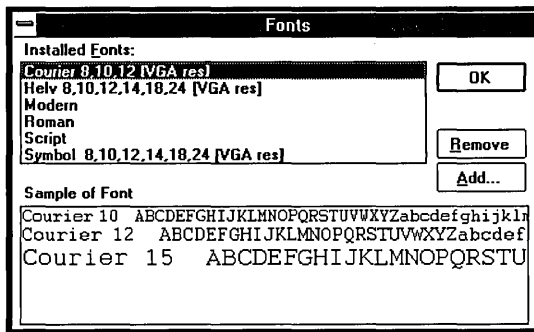

2. Choose the Add button.

Control Panel asks for the filename for the font set you want to install.

3. Enter the font filename in the text box or select a directory and file from the list boxes.

If you want to install more than one font set at a time, extend the selection to all the font sets you want to install from the current directory. (See “List Boxes” in Chapter 2 to learn how to extend the selection.)

4. Choose OK to add the font.

## ***Removing a Font***

Every installed font set takes up memory. If you are not using one or more of the installed font sets, you can remove them to free up memory for use by your applications.

---

**CAUTION** The Helv font set is used for most Windows dialog boxes. Do not remove this set, or the text in the dialog boxes will be difficult to read.

---

### **▷ To remove a font:**

1. Choose the Fonts icon from the Control Panel window.  
Control Panel displays the Fonts dialog box.
2. Select the font you want to remove.
3. Choose Remove.  
A dialog box asks you to confirm the removal.
4. Choose OK to return to Control Panel.

## ***Setting International Options***

With the international options you can specify settings for Windows and all the Windows applications that use the items you specify. If you are using Windows in English within the United States, you do not need to make any changes to the international settings.

### ***Basic Settings***

Control Panel lets you set basic international options such as country, language, keyboard layout, system of measurement, and list separator. Usually, you should just select the country in which you are working—Control Panel then automatically adjusts all the other settings. But you can adjust any of the other settings to customize them for your particular situation.

▷ **To select international settings:**

- Choose the International icon from the Control Panel window.  
Control Panel displays the International dialog box.

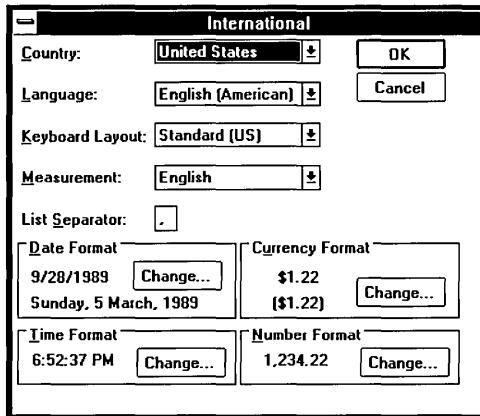

The first four options in the dialog box are drop-down list boxes that present the choices for country, language, keyboard layout, and system of measurement. The next option is a text box where you can fill in the list separator. If you want to accept the standard choices for your country, select the country and then choose OK. To personalize the settings, select from the following options:

**Use this option**

**To do this**

Country

Specify the country whose standard settings you want to use. When you choose a country, the other option groups change to show the standard settings for that country.

Language

Specify the language you want to work in. Windows applications that provide language-specific tasks, such as sorting or case conversion, use this setting.

Keyboard  
Layout

Specify the keyboard layout of your computer. The keyboard layout varies from country to country to accommodate the special characters and symbols that are part of the language for that country. This setting tells Windows how to interpret the keys that you press.

**Use this option**

**To do this**

Measurement

Select the metric or English system of measurement.

List Separator

Enter the symbol you want to use to separate elements in a list. In English, the list separator is typically a comma and is used to separate words or numbers in a sentence when they appear in a series.

## ***Date Format***

You can change the format used to display the date within applications that have a date function. For example, you can vary the order of month-day-year or change the punctuation used to separate those parts of the date.

▷ **To change the date format:**

1. Move to the Date Format box and choose the Change button.  
Control Panel displays the Date Format dialog box.

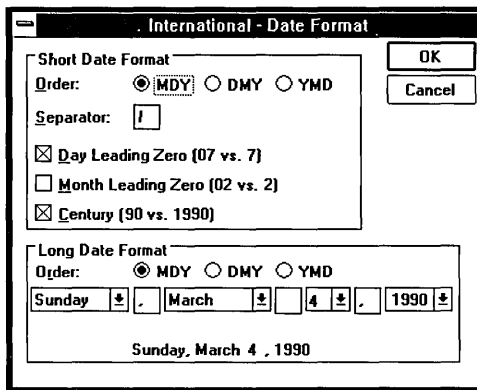

2. Set the options you want for both the Short and Long Date Format; then choose OK.

The Short Date Format displays the date as three numbers, representing the month, day, and year. You specify the order and number of digits for each part of the date. The Long Date Format displays the date as a combination of words and numbers—for example, *Monday, October 15, 1989*, or a variation you specify. The options for both formats are described in the following table:

<u>Use this option</u>	<u>To do this</u>
Order	Specify the order of the month (M), day (D), and year (Y). <i>This option works the same for Short and Long Formats.</i>
Separator	Enter the symbol you want to use to separate the month, day, and year. You can specify any character as the separator, though the most common are the slash (/) and the hyphen (-).
Day/Month Leading Zero	Specify that the day or month always be displayed as two digits. For example, February 7 would be displayed as 02-07.
Century	Specify that the year be displayed as four digits. For example, December 10, 1989, would display as 12-10-1989.
Long Date Format options	Specify alternative choices for the Long Date Format, including abbreviations for the words and different separators.

## ***Time Format***

You can choose either the 12-hour or 24-hour format, specifying the separator between the parts and displaying numbers representing the hours before 10 with a leading zero if you want. You can also add suffixes to the date (for example, English suffixes such as AM to indicate morning or PST for Pacific Standard Time).



▷ To change the time format:

1. Move to the Time Format box and choose the Change button.  
Control Panel displays the Time Format dialog box for the selected country.

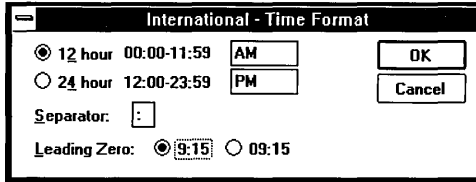

2. Select the options you want and then choose OK. The following table describes each option.

<u>Use this option</u>	<u>To do this</u>
12-hour/24-hour	Display time in numbers representing the hours between 1 and 12 or between 0 and 23.
AM/PM	<p>If you use the 12-hour format, specify your country's notation for <i>before</i> noon in the top text box next to 00:00-11:59.</p> <p>If you use the 12-hour format, specify your country's notation for <i>after</i> noon in the lower text box next to 12:00-23:59.</p> <p>If you use the 24-hour format, you can only use the lower text box to specify any special suffix, such as PST.</p>
Separator	Choose the character you want Windows to use to separate the hours, minutes, and seconds. Any character is allowed, but the most common is the colon (:).
Leading Zero	Display the hours before 10 as a two-digit number, with the first digit being a 0. For example, 9 o'clock would be displayed as 09:00.

## Currency Format

### ▷ To change the currency format:

1. Move to the Currency Format box and choose the Change button.  
Control Panel displays the Currency Format dialog box.

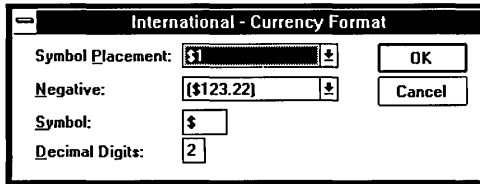

2. Set the options you want and choose OK. The following table describes each option.

#### Use this option

#### To do this

Symbol Placement

Specify the placement and spacing of the currency symbol relative to the amount.

Negative

Select the way you want negative numbers to be displayed.

Symbol

Select the currency symbol for your country.

Decimal Digits

Specify the number of digits you want Windows to display after the decimal separator.

## Number Format

You can control the way numbers are displayed in Windows and many Windows applications.

▷ To change the number format:

1. Move to the Number Format box and choose the Change button.  
Control Panel displays the Number Format dialog box.

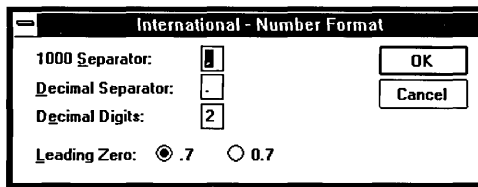

2. Set the options you want and choose OK. The following table describes each option.

Use this option

To do this

1000 Separator

Change the punctuation used to separate thousands.

Decimal  
Separator

Change the punctuation used to separate the fractional part of a decimal number from the whole number part.

Decimal Digits

Specify the number of digits to display after the decimal separator.

Leading Zero

Choose whether or not numbers less than 1 are preceded by a zero.

## Customizing Use of the Mouse

You can make several adjustments to the way Windows works with your mouse, including switching the functions of the left and right buttons, changing the speed of the double-click, or changing the speed at which moving the mouse moves the pointer.

▷ **To customize use of the mouse:**

1. Choose the Mouse icon from the Control Panel window.  
Control Panel displays the Mouse dialog box.

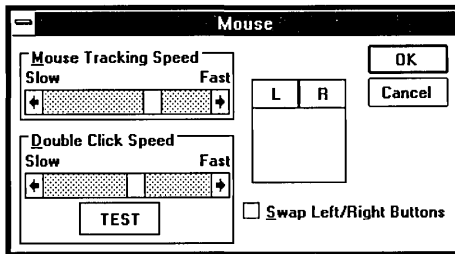

2. If you want to change the speed at which the pointer travels across the screen, use the Mouse Tracking Speed scroll bar. To change the speed, drag the scroll box toward Fast or Slow or click the appropriate scroll arrow.  
Or press TAB to move to the Mouse Tracking Speed box, and then press RIGHT ARROW or LEFT ARROW to move the scroll box.
3. If you want to change the speed at which Windows will register a double-click when you press your mouse button, use the Double Click Speed scroll bar. Drag the scroll box toward Fast or Slow, or click the appropriate scroll arrow.  
Or press TAB to move to the Double Click Speed box, and then press RIGHT ARROW or LEFT ARROW to move the scroll box.  
If you increase the speed, double-click the Test button to make sure you're clicking fast enough for the new setting. The Test box will invert to show that your double-click is fast enough.

4. If you want to switch the functions of the left and right buttons, select the Swap Left/Right Buttons check box.

Many applications use the left button as the primary tool for selecting text and choosing items. If you are left-handed, you might find it more convenient to switch the two buttons. Notice that the mouse diagram in the dialog box reflects your choice, and be aware that this change takes effect *immediately*, before you close the dialog box. Thus, if you switch the buttons, you need to click the right button to choose OK or Cancel, or to switch the buttons again.

5. Choose OK.

## ***Setting the System Date and Time***

You can change the system date and time by using the Date/Time option. The system date and time are reflected in Clock and Calendar (two of the Windows accessories), as well as in the information kept by File Manager for each file you save on your disk. The format of the date and time depends on the international settings you chose (see “Setting International Options” earlier in this chapter).

### **▷ To change the date:**

1. Choose the Date/Time icon from the Control Panel window.  
Control Panel displays the Date & Time dialog box.

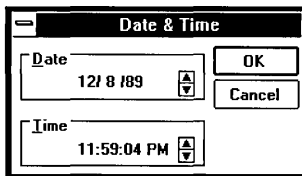

2. Select the part of the date (day, month, or year) that you want to change.
3. Type the new value for the selected part.  
Or click the arrows at the right of the Date text box to change one date element (day, month, or year) at a time. (Or press UP ARROW or DOWN ARROW.)
4. Choose OK.

▷ To change the time:

1. Select the part of the time (hour, minute, second, suffix) you want to change.
2. Type the new value for the selected part.  
Or click the arrows at the right of the Time text box to change the selected part one unit at a time. (Or press UP ARROW or DOWN ARROW.)
3. Choose OK.

## *Adjusting Keyboard Speed*

The Keyboard option allows you to specify how fast a key repeats when you hold it down.

▷ To change the keyboard repeat rate:

1. Choose the Keyboard icon from the Control Panel window.  
Control Panel displays the Keyboard dialog box.

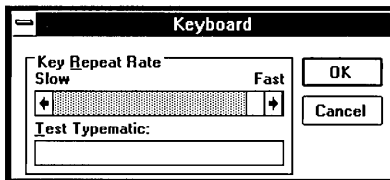

2. Drag the scroll box toward Fast or Slow or click the appropriate scroll arrow.  
Or press RIGHT ARROW or LEFT ARROW to increase or decrease the rate.
3. If you want to test the speed, move to the Test Typematic box and hold down any key on the keyboard. Readjust the scroll box position until you reach a speed with which you are comfortable.
4. Choose OK.

## Controlling Sound

Windows uses a warning beep to signal you when you attempt to do something that is not allowed, but you can turn this sound off at any time.

▷ **To turn the warning beep on or off:**

1. Choose the Sound icon from the Control Panel window.  
Control Panel displays the Sound dialog box.
2. Click the Warning Beep check box.  
Or press the SPACEBAR to turn the option on or off.
3. Choose OK.

## Setting Options for Running in 386 Enhanced Mode

**386**

If you are running in 386 enhanced mode, the Control Panel window will include a 386 Enhanced icon. The options represented by this icon allow you to specify how the various applications compete for peripheral devices and how much of the computer's resources are allocated to Windows and non-Windows applications.

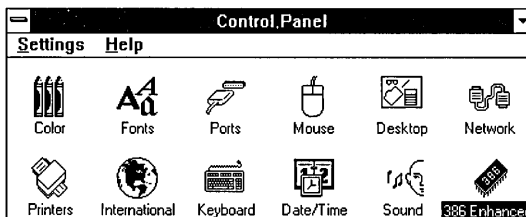

## Handling Device Contention

When more than one application is running at the same time in 386 enhanced mode, they sometimes request the use of a device such as a printer or modem at the same time. The device contention options determine how Windows arbitrates these requests.

The device contention options apply only when a non-Windows application is one of the applications requesting access to the device. When more than one Windows application requests access to a device, Windows handles their use of the device without these options.

► **To specify how to handle contention for a device:**

1. Choose the 386 Enhanced icon from the Control Panel window.  
Control Panel displays the 386 Enhanced dialog box.

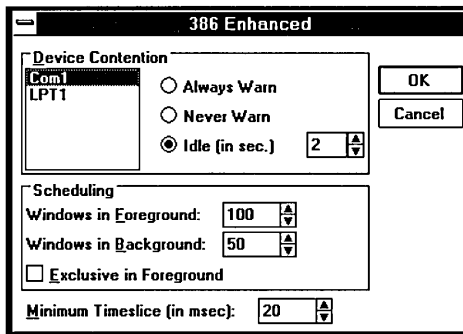

2. Select the port that is connected to the device you want to control.
3. Set the options you want and choose OK.

The device contention options are described in the following table. Generally, it is a good idea to accept the standard settings. Situations that might warrant changing the settings are included in the option descriptions.

<u>Use this option</u>	<u>To do this</u>
Always Warn	Specify that a warning message be displayed every time an application tries to use the device when the device is already in use. The warning message asks you which application should be given control of the port. In most situations, you will want to select this option.



<u>Use this option</u>	<u>To do this</u>
Never Warn	<p>Specify that any application can use the device at any time, without a warning message. However, this means that two applications could conceivably try to use the same device at the same time, with undesirable results such as a garbled printed document.</p> <p>For example, it would make sense to select this option when you are absolutely sure that no more than one printing or communicating application will try to use the device at the same time.</p>
Idle	<p>Specify the number of seconds after an application stops using a device before another application can use the same device without causing the warning message to be displayed. The range is from 1 to 999 seconds.</p> <p>For example, it would make sense to specify idle time when the device is capable of switching back and forth between two applications. For example, you might use Cardfile to automatically dial an on-line service and then switch to another application to communicate with the service. In this example, you would specify a short delay, such as 2 seconds.</p>

## ***Setting Multitasking Options***

The other 386 enhanced mode options are used to determine how Windows behaves when multitasking. These options are summarized in the following list and explained more completely in Chapter 12, "More About Applications."

<u>Use this option</u>	<u>To do this</u>
Minimum Timeslice	<p>Specify the number of milliseconds an application is allowed to run before Windows gives processor control to another application. Notice that all Windows applications share one timeslice, and each non-Windows application gets its own timeslice.</p>

<u>Use this option</u>	<u>To do this</u>
	<p>The smaller the timeslice, the more frequently Windows switches between applications. Frequent switching makes running more than one application at a time seem smoother. However, overall system performance declines. Specifying a larger timeslice increases performance, but makes the switching operation more apparent.</p>
Windows in Foreground	<p>Specify the amount of processing time (the proportion of total timeslices) normally shared by all Windows applications. When a non-Windows application is the active application (foreground), Windows uses the value for Windows in Background. The number specified is relative to the time allocated to all non-Windows applications running in the background. The range of numbers that can be entered is from 1 through 10,000, but the important value is the ratio between this setting and the sum of this setting and the settings for the running non-Windows applications (background set in the PIF). See Chapter 12, "More About Applications," for information on PIF editor.</p>
Windows in Background	<p>Specify the amount of processing time (the proportion of total timeslices) normally shared by all Windows applications when a non-Windows application is running in the foreground. The range of numbers that can be entered is from 1 through 10,000, but the important value is the ratio between this setting and the sum of this setting and the settings for the foreground application and all other non-Windows applications running in the background.</p>
Exclusive in Foreground	<p>Specify that Windows <i>always</i> gets 100 percent of the computer's processing time whenever a Windows application is the active application. In other words, if a Windows application is in the foreground, all Windows applications run and no non-Windows applications run.</p>

**NOTE** When running Windows in 386 enhanced mode, even non-Windows applications can appear in Windows. However, that does not mean they are Windows applications.

See Chapter 12, "More About Applications," for more information about adjusting the priorities for individual non-Windows applications and about multitasking Windows and non-Windows applications.



---

---

**Chapter**  
**6**

**Print Manager**

**Printing with Windows Applications .....197**

**Printing with Non-Windows Applications .....197**

**Printing with Print Manager .....198**

- Looking at the Print Queue ..... 198
- Changing the Order of the Queue ..... 200
- Pausing and Resuming Printing ..... 201
- Deleting a File from a Print Queue ..... 202
- Changing the Printing Speed ..... 202
- Displaying Print Manager Messages ..... 204
- Displaying the Time/Date and File Size ..... 205
- Exiting from Print Manager ..... 205

**Printing on a Network .....206**

- Viewing the Entire Network Queue ..... 206
- Viewing Other Network Queues ..... 207
- Manual Updating of the Network Queue Status ..... 208
- Automatic Updating of the Network Queue Status ..... 208
- Bypassing Print Manager ..... 209

**Printing to a File .....210**

---

<b>If Things Go Wrong</b> .....	<b>211</b>
If Your Printer Does Not Print at All .....	212
If the Printer Advances the Paper but Does Not Print .....	212
If the Page Prints but Is Formatted Incorrectly .....	213
If Printer Output Is Garbled .....	213
If Printer Output from Two Files Gets Mixed .....	214
If Your Laser Printer Does Not Print Your Cartridge or Soft Fonts .....	214
If the Printer Loses Text .....	215
If Only Part of a Page Prints .....	216
If Lines Are Missing from a Paintbrush Drawing .....	216

## ***Printing with Windows Applications***

After you connect your printer to your computer and install it using Control Panel, you can print information from Microsoft Windows applications. If you have not yet installed your printer and need assistance, see Chapter 5, “Control Panel.”

You might find slight differences in the way you print with different Windows applications. To make sure you understand any differences that exist, it is a good idea to read the documentation on printing that comes with an application.

When you print from a Windows application, the application creates a print file and sends it to the Windows Print Manager. From this point on, Print Manager manages the printing of the file. Working with Print Manager is the same in each application.

The appearance of your printed copy depends on whether or not your application allows you to assign fonts, the fonts and formats you assign, and the fonts and formats your printer can print. Printers differ in their abilities to use fonts, graphics, spacing, alignment, and character formats. The appearance of printed copy can vary greatly from printer to printer. Although some applications attempt to display files on the screen in the same format that you will see on the printed page, you might need to experiment with your printer to get the results you want.

## ***Printing with Non-Windows Applications***

When you print from a Windows application, the application uses the Windows printer drivers and Print Manager. When you print from a non-Windows application that you have started from Windows, the non-Windows application prints just as it would if you had started it from MS-DOS. It does not use Print Manager or any Windows printer drivers. If you want it to do so, you must transfer the information you want to print into a Windows application. See Chapter 2, “Basic Skills,” and Chapter 12, “More About Applications,” for more information on using non-Windows applications.

## ***Printing with Print Manager***

When you print from a Windows application, the application sends the print file to the Windows Print Manager. Print Manager works in the background, sending your files to the printer while you continue working. As you send files to Print Manager, Print Manager forms a *print queue*—a list indicating the file currently printing and those files waiting to be printed. You can check on the status of a file in the print queue at any time and change the status of the file up until the time that it starts printing.

### ***Looking at the Print Queue***

There are two types of print queues: local and network. The *local queue* defines a list of files printed from a Windows application to a printer connected locally to your computer (that is, the computer and the printer are directly connected by a cable).

The *network queue* refers to the print queue on the network server. This queue is generally managed by a network print manager, which is completely separate from the Windows Print Manager. To properly print over a network queue, you should have a Windows network driver installed (see Chapter 5, “Control Panel,” for more information on networks). When running with a network printer, Print Manager tracks the progress of your print files on the network print manager. The standard method is for print files to be passed directly through to the network queue, where they are spooled to the printer.

When Print Manager starts printing to a local queue, its icon appears at the bottom of your screen. If you enlarge the icon to a window, you see the print queue for any active printer connected to your computer. You can use the Print Manager window to check the status of the files in the print queue or to interrupt or cancel the printing of the print queue.

When Print Manager prints to a network queue, the file is sent directly to the network printer. To view the status of your print job, you must start Print Manager from the Program Manager group. There is no Print Manager icon at the bottom of your screen when you print to a network queue.

▷ **To look at the print queue:**

- Choose the Print Manager icon from the Main Group window.

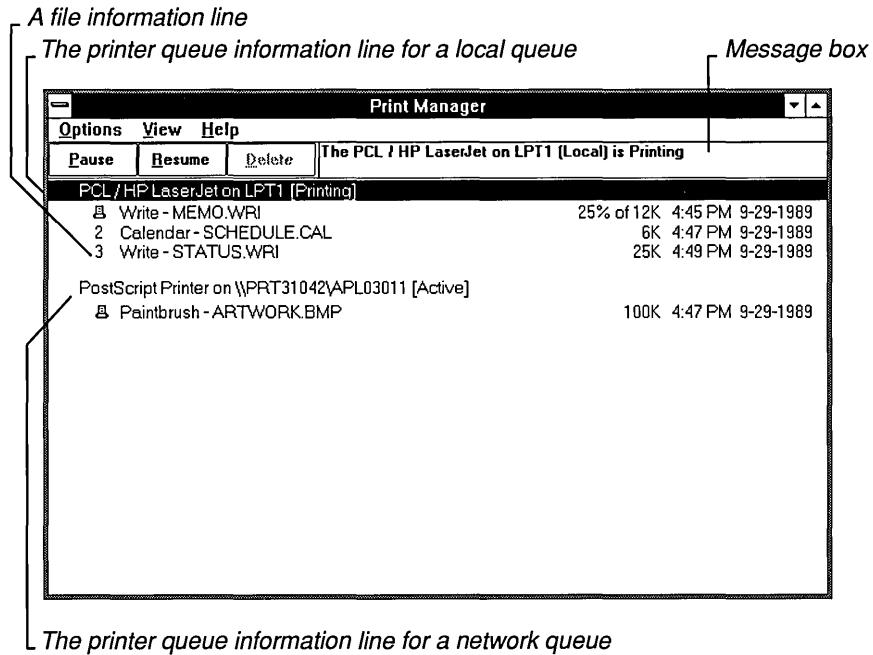

The printer queue information line in the print queue tells you the following:

- The name of the printer
- Where the printer connects to your computer
- The current status of the printer



The file information line gives you information specific to the file, such as:

- The title of the print job assigned by the application (if your network software supports this)
- The file's position in the queue or a printer icon if the file is printing
- The size of the file in kilobytes (if the Print File Size command is turned on)
- The time and date you sent the file to Print Manager (if the Time/Date Sent command is turned on)

If a file is currently printing, its information line also tells you the amount (as a percentage) of the file printed so far.

If you have more than one printer connected to your machine, you see multiple printer queue information lines and you might see a print queue for each printer. If you are connected to a network printer, the printer queue information line shows the network server connection. Any detailed information the network can provide appears in the message box at the upper-right corner of the Print Manager window. Networks can provide varying degrees of detailed information.

Print Manager only reports the status of the files that *you* send to the network in your Print Manager window. If you want to see *all* the files in a network queue, see "Viewing the Entire Network Queue" later in this chapter.

## ***Changing the Order of the Queue***

You can change the position of a file in a *local* print queue, as long as that file has not yet begun to print. However, you cannot change the position of files in a network queue.

### **▷ To change the order of the queue:**

- Select the file whose position you want to change, drag it to its new position in the print queue, and then release the mouse button.

Or select the file, hold down CTRL, and press UP ARROW or DOWN ARROW to move the file to its new position. Then release CTRL and the ARROW key.

The numbers and file information in the print queue change to reflect the new positions of the files.

## Pausing and Resuming Printing

Using buttons in the Print Manager window, you can interrupt the printing of a print queue. Some networks allow you to pause an individual print file. However, your ability to interrupt a network queue depends on the specific features the network supports.



*Use these buttons to interrupt, resume, and cancel printing.*

### ▷ To temporarily interrupt printing:

1. Select the information line for the printer queue (local) or the print file (network).
2. Choose the Pause button.  
Or press ALT + P.

The information line for the printer now indicates that printing has paused.

### ▷ To continue printing after interrupting it:

1. Select the information line for the printer queue (local) or the print file (network).
2. Choose the Resume button.  
Or press ALT + R.

The selected information line changes to indicate that printing has resumed.

## ***Deleting a File from a Print Queue***

You can use the Delete button in the Print Manager window to delete a file from a print queue at any time.

### **▷ To delete a file from a print queue:**

1. Select the information line for the file from the print queue.
2. Choose the Delete button.  
Or press ALT + D.  
A dialog box appears, asking you to confirm the deletion.
3. Choose OK.

### **▷ To delete all files from all print queues:**

1. Choose Exit from the Options menu.  
A dialog box appears, asking you to confirm the deletion.
2. Choose OK.  
If you do not choose OK, Print Manager will continue to operate, and the files will continue to print.

---

**CAUTION** If you delete a file currently printing in graphics mode, you might need to reset your printer to ensure that the printer's buffer is clear. (Turn it off and back on again or select the Reset option, if available. It is most important to do this with Laser-type printers.)

---

## ***Changing the Printing Speed***

You can specify the rate at which information is transferred from Print Manager to the printer ports by using the Low Priority, Medium Priority, and High Priority commands on the Options menu.

A checkmark next to a command indicates the current setting.

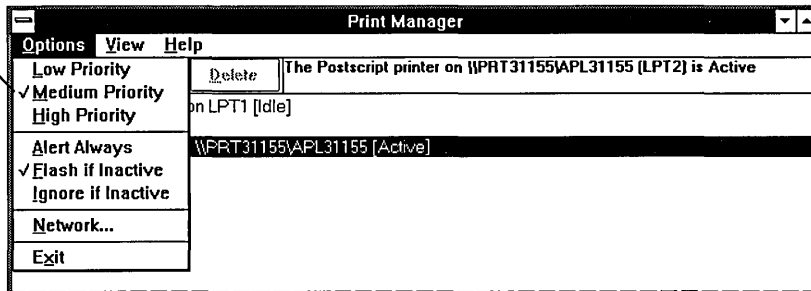

▷ **To increase printing speed and slow down applications:**

- Choose High Priority from the Options menu.

This setting uses more of your computer's processor time for Print Manager, causing other applications to run more slowly.

▷ **To print and run applications equally:**

- Choose Medium Priority from the Options menu.

This setting shares your computer's processor time as equally as possible between Print Manager and other applications that are running. This is the standard setting.

▷ **To decrease printing speed and run applications faster:**

- Choose Low Priority from the Options menu.

This setting uses more of the computer's processor time to run applications, causing Print Manager to slow down.

The setting you choose remains in effect until you use the Options menu to change it.

## Displaying Print Manager Messages

Occasionally, Print Manager needs to display a message. For example, if your printer is set up for manual paper feed, Print Manager will request that you feed in a new sheet of paper. The Options menu provides three commands for controlling the way Print Manager handles this type of message.

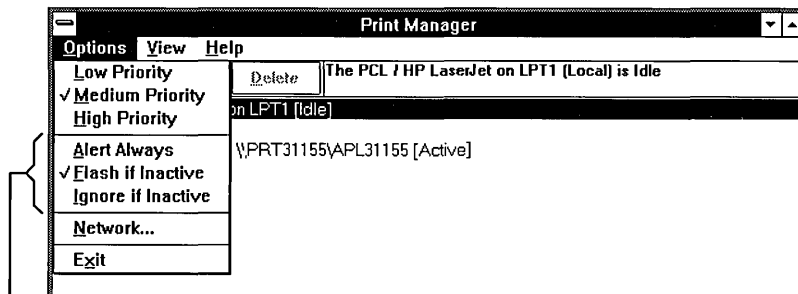

*These commands determine how  
Print Manager displays messages.*

The following table describes these commands:

<u>Menu command</u>	<u>Function</u>
Alert Always	Immediately displays a message box when a condition occurs that requires user interaction.
Flash if Inactive	Beeps once and flashes the Print Manager icon or the title bar of the inactive Print Manager window until you enlarge the icon or make the window active. Then Print Manager displays its message. This is the standard setting.
Ignore if Inactive	Ignores the condition requiring user interaction when Print Manager is an icon or the Print Manager window is inactive.

The command you choose remains in effect until you use the Options menu to change it.

**NOTE** These commands do not control the display of system messages, such as a notification that your printer is off-line.

## Displaying the Time/Date and File Size

When you first enlarge the Print Manager icon, a print queue automatically displays the time and date you sent a file to Print Manager and the size of the file. If you do not want to see the time and date or the file size, you can turn off either option by choosing the appropriate command from the View menu.

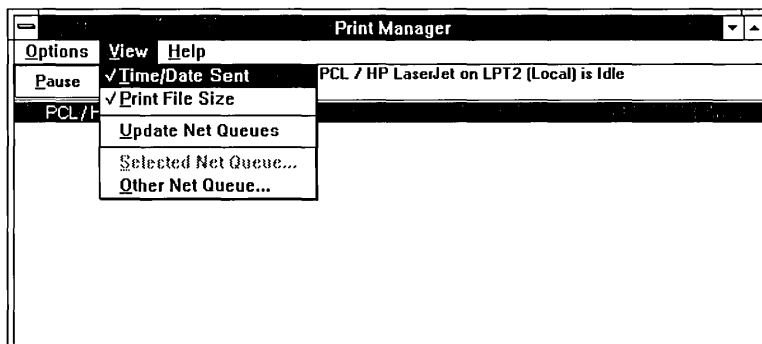

### ▷ To turn off the time and date or file size display:

- Choose Time/Date Sent or choose Print File Size from the View menu.

The checkmark next to the command on the View menu disappears, and the information disappears from the Print Manager window. If you want to display the time and date or file size again, choose the appropriate command again from the View menu.

## Exiting from Print Manager

If running as an icon, Print Manager terminates automatically (and frees the memory it was using) when it finishes printing. If the Print Manager window is open, it does not terminate automatically.

▷ **To exit from the Print Manager window:**

---

- Choose Exit from the Options menu.

If filenames remain in the print queue, a dialog box appears, asking if you want to cancel the printing of these files. If you choose OK, Print Manager does not print the remaining files.

## ***Printing on a Network***

If you are set up to print on a network, Print Manager offers a number of options to assist you. For example, you can:

- View all the files in a network printer's queue, instead of just the files you send to the printer.
- View a network queue that you are not currently connected to.
- Bypass Print Manager and print directly to the network.

You can also tell Print Manager to ignore the status of a network print queue to cut down on network traffic during periods of heavy network use.

For information about setting up to print on a network, see Chapter 5, "Control Panel."

**NOTE** The level of support for the following options depends on the capabilities of your network software and the support provided in your Windows network driver.

## ***Viewing the Entire Network Queue***

When you print a file on a network printer, Print Manager displays a print queue that shows only the files *you* have sent to that printer. The Selected Net Queue command lets you see *all* the files sent to that printer.

▷ **To view the entire queue for a network printer that you are connected to:**

---

1. Select the information line for the printer queue in the Print Manager window.
2. Choose Selected Net Queue from the View menu.  
Print Manager displays the entire queue for the selected printer.

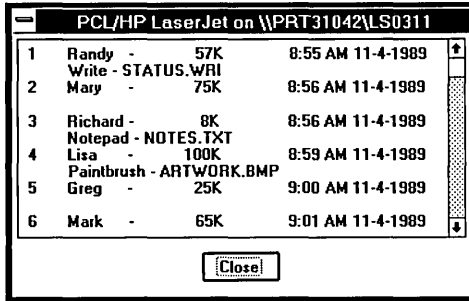

3. Choose Close to close the dialog box.

You can choose Selected Net Queue from the View menu at any time to display an updated queue for a network printer that you are connected to.

## Viewing Other Network Queues

In addition to viewing queues for network printers that you are connected to, you can view queues for network printers that you are *not* connected to. This allows you to look at how many files are in the queues for different network printers before deciding which one you want to print to. However, you must use Control Panel to connect to a network printer before you can print to it. See Chapter 5, “Control Panel,” for more information.

### ▶ To view the queue for a network printer you are not connected to:

1. Choose Other Net Queue from the View menu.  
The Other Net Queue dialog box appears, asking for the location and name of the network queue you want to view.
2. Type the network pathname to the network print queue in the Network Queue box and choose View.  
Print Manager displays the status information for the queue in the box above the Network Queue box. See your network software documentation for information on how to enter the network pathname.



Status information for the specified queue appears here.

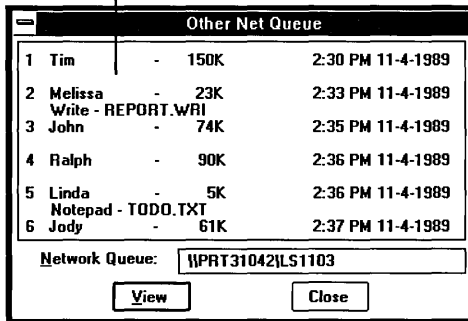

3. Type the name of another queue that you want to view, or choose Close when you want to close the Other Net Queue dialog box.

**NOTE** Remember, viewing a queue for a network printer that you are not connected to does not connect you to that network printer for printing. You must use Control Panel to connect to the network printer before you can print.

## ***Manual Updating of the Network Queue Status***

The network queue status is updated automatically on a periodic basis or when a change on the network has occurred. This depends on your network software. In some cases, you may want to update the network queue status manually.

### **▷ To update the network queue status manually:**

- Choose Update Net Queues from the View menu.  
Print Manager will update the network queue information.

## ***Automatic Updating of the Network Queue Status***

When running as an icon, Print Manager does not update the status of the file in the network print queue. If you enlarge the Print Manager icon, Print Manager automatically updates the status of the network queue, and it continues to do so periodically. However, if you are concerned about network traffic, or you do not need to view the network status, you can tell Print Manager to ignore the status of a network queue, even when you enlarge the Print Manager icon.

▷ **To have Print Manager ignore the status of a network queue:**

1. Choose Network from the Options menu.  
The Network Options dialog box appears.

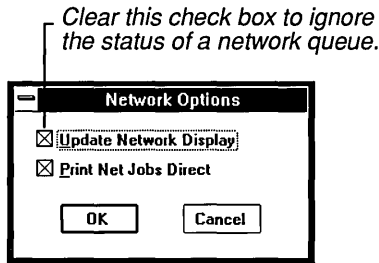

2. Clear the Update Network Display box.
3. Choose OK.

All the print jobs will now be tracked on your computer as if they were on a local queue. You will not see the status of the network queue with this option turned off. And the print job status will not be updated until you turn on this option again.

## ***Bypassing Print Manager***

When you want to print on a network printer, you can save time by bypassing Print Manager. Routing the file through Print Manager adds an extra step that can delay printing over a network. Therefore, by default, Windows prints files directly to the network, bypassing Print Manager. However, sometimes you might prefer to use Print Manager. This will depend on your network. Therefore, you may need to experiment with both options to determine which is best for you. In most cases, it is faster to bypass Print Manager and print directly to the network printer.

▷ To print directly to the network:

1. Choose Network from the Options menu.  
The Network Options dialog box appears.

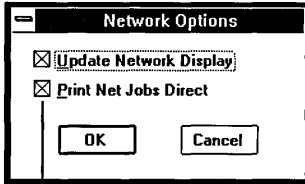

Select this box to bypass Print Manager.

2. Select the Print Net Jobs Direct box.
3. Choose OK.

This option remains turned on until you select it again.

You can also bypass Print Manager by clearing the Use Print Manager check box in the Printers dialog box in Control Panel. Using the Print Net Jobs Direct option in the Network Options dialog box, however, allows you to bypass Print Manager but still have Print Manager report on the status of the network print queue.

## ***Printing to a File***

There may be times when you want to format a spreadsheet, report, or other document and print it to a file rather than to a printer. You might do so to accomplish the following:

- Merging into another document
- Printing at a later time or at a different location
- Printing several times by copying repeatedly to a printer

▷ **To print to a file:**

1. Choose Control Panel from the Main Group window or enlarge the Control Panel icon.
2. Choose the Printers icon.  
The Printers dialog box appears.
3. In the Installed Printers box, select the name of the printer you eventually want to print the file to.
4. Choose Configure.  
The Configure dialog box appears.
5. In the Ports box, select FILE as your port.
6. Choose Setup and make sure your print options are set properly.
7. Choose OK three times to return to the Control Panel window.
8. Return to your application and follow the instructions to finish printing your document to a file.

While you are connected to a file, Print Manager prompts you for the filename each time you print from an application. In addition to the filename, you may also specify a drive and directory in which you want to store the file.

## ***If Things Go Wrong***

Occasionally you might have trouble printing with Windows. The following sections describe how to recognize and fix the most common printing problems.

Most of the sections describe a printer problem and offer suggestions for correcting the problem. In most cases, as you follow the steps suggested to find and solve a problem, you should print each time you try a step. If Windows prints correctly, then you've solved the problem. If not, you should go on to the next step. You might have to do some experimenting with your printer to discover why a document doesn't print or why it prints incorrectly.

## ***If Your Printer Does Not Print at All***

When a printer won't print, the cause is often a simple mechanical problem such as the printer being off-line, turned off, or disconnected. Use the following checklist to see if you can find the problem:

- Do you have the correct cable for your printer and is it properly connected?
- Is the printer plugged in and turned on?
- Is the correct printer selected as the default printer? (See "Choosing the Default Printer" in Chapter 5.)
- Are the print options settings correct? (See "Setting the Print Options" in Chapter 5.)
- Have you chosen the correct port for the selected printer? (See "Selecting a Printer Port" in Chapter 5.)
- If you have a serial printer, are the settings in the Ports-Settings dialog box correct? (See "Selecting a Printer Port" in Chapter 5.)
- Do you need to change the ribbon, mount a print wheel or cartridge, or add paper?

If you complete the checklist and still can't print, you should quit the application you are working with and try to print a text file from the Windows File Manager. See Chapter 4, "File Manager," for instructions.

If you still can't print, you have a problem with the printer or a problem with the cable. Try connecting the printer again. If this doesn't help, contact your printer manufacturer or dealer.

## ***If the Printer Advances the Paper but Does Not Print***

When your printer advances the paper but doesn't print, you might have missed one of the following requirements:

- Select the correct paper source when you set up print options.
- Select the correct printer name when you set up print options.
- Configure the correct printer-driver file for your printer.

See "Installing a Printer" and "Configuring a Printer" in Chapter 5 for the appropriate procedures.

## ***If the Page Prints but Is Formatted Incorrectly***

If the pages of a document are formatted incorrectly, the margins are incorrect, the document contains extra lines, or the document is paginated incorrectly, use this checklist:

- Are the formats you chose in your application accurate, especially font and point size selections?
- Is the correct printer selected as the default printer? (See “Choosing the Default Printer” in Chapter 5.)
- When you installed your printer, did you select the correct printer name when you set up printer options? (See “Choosing a Printer” in Chapter 5.)
- When you set up your printer, did you select the correct paper source? (See “Setting the Print Options” in Chapter 5.)
- Does your printer have hardware switches that set page length or line length? (Check your printer manual.)
- Does your printer have a hardware switch that does an automatic linefeed at each carriage return? (Check your printer manual.)

The switch that controls the automatic linefeed at a carriage return should be set to do carriage returns only.

## ***If Printer Output Is Garbled***

If you can print your document, but it is garbled, unreadable, or contains extra characters in front of the text, use this checklist:

- Is the correct printer selected as the default printer? (See “Choosing the Default Printer” in Chapter 5.)
- When you installed your printer, did you select the correct printer name when you set up printer options? (See “Choosing a Printer” in Chapter 5.)

If the wrong printer or the wrong font cartridge is selected, the printer may insert stray characters at the beginning of lines or behave in other unpredictable ways.

- If you have a serial printer, are the settings correct in the Ports-Settings dialog box? (See “Selecting a Printer Port” in Chapter 5.)

Lowering the baud rate might cause the printer to print correctly.

- Does Windows have another printer-driver file that might be compatible with your printer? If so, try using it.  
For example, if your printer is an Epson ® or IBM-compatible printer, one of the printer-driver files for another Epson or IBM printer might work with your printer.
- Has your printer's buffer retained garbled information? Try turning the printer off and back on again.
- Is your printer cable working properly? Verify that you have the correct cable and that it is functioning.

As a last resort, you might try installing the Windows Generic/Text Only printer-driver file to see how it works with your printer.

You may also want to contact your dealer or printer manufacturer to determine if there is a problem with your printer.

## ***If Printer Output from Two Files Gets Mixed***

If the printer output from two files comes out mixed together, use this checklist:

- Did you have a Windows application and a non-Windows application assigned to the same port, switch between them, and then try to print from both of them at the same time?
- Did you have two non-Windows applications assigned to the same port, switch between them, and then try to print from both of them at the same time?

Print Manager cannot help you in either of these two cases. When running Windows in real or standard mode, there is no way for the system to warn you about device-contention problems. When running Windows in 386 enhanced mode, you would see a message advising you to resolve this device-contention situation before the printer would print.

## ***If Your Laser Printer Does Not Print Your Cartridge or Soft Fonts***

If you install a font cartridge or soft fonts for your laser printer, but the printer doesn't use the fonts, use this checklist:

- Are the print options settings for your printer correct? (See "Setting the Print Options" in Chapter 5.)

- If you are using a font cartridge, is it all the way in the slot? (Turn off the printer before checking this.)  
You may need to press firmly on the cartridge until it pops into the slot.
- If you are using any soft fonts, are they properly installed? (Refer to the installation kit provided with your soft fonts.)
- If your soft fonts are installed as permanent, perhaps the printer was turned off or reset. Try downloading the soft fonts to the printer again.
- If you are using too many soft fonts, your printer might have run out of memory. Try installing fewer fonts or installing them as temporary fonts, if appropriate.

## ***If the Printer Loses Text***

If you have a serial printer and it prints the document but loses blocks of text, you might have a handshake or flow control problem with your communications port.

To check for a handshake or flow control problem, use this checklist:

- Are the settings in the Ports-Settings dialog box correct? (See “Selecting a Printer Port” in Chapter 5.)  
Lowering the baud rate might cause the printer to print correctly.
- If you are still losing text, can you change to a lower baud rate than the one you are using now?
- If you have a parallel interface, is the cable faulty? Try using a new cable of the same type.

To check for other problems, use this checklist:

- Are all the manual switches on your printer set as described in the printer’s documentation?
- Are you using the correct printer-driver file?  
Try printing with the Generic/Text Only printer driver.



## ***If Only Part of a Page Prints***

If your printer prints only part of your document, use the following checklist:

- Does the paper size you chose when setting up the printer match the paper loaded in the printer?
- Are you printing with a PCL/HP LaserJet ® printer? If so, your printer might not be able to print every available graphics resolution as a full page. There might be too much information on a page for your printer's memory to handle.

When this happens, you might get a message on your printer indicating the problem. Try printing at a lower graphics resolution. (For more information, see "Setting the Print Options" in Chapter 5. Also see your printer manual for more information on printing graphics with a PCL printer.)

## ***If Lines Are Missing from a Paintbrush Drawing***

If lines seem to be missing from the printed copy of a Paintbrush drawing, you have probably set a width and/or height in Paintbrush's Page Setup dialog box that is too small for the width and/or height setting in the Image Attributes dialog box. When this happens, line information for the drawing can be lost when Paintbrush shrinks the picture for printing.

You can usually solve this problem by proportionally increasing the dimensions of the printed drawing in the Page Setup dialog box. The best way to avoid the problem is to print using the standard margin settings in the Page Setup dialog box or use the Shrink + Grow command on Paintbrush's Pick menu to shrink the drawing to a smaller size before printing.



**Part** *Windows Accessories*  
**2**

---

---

# ***Windows Accessories***

## **CHAPTERS**

<b>7</b>	<b><i>Write</i></b> .....	<b>221</b>
<b>8</b>	<b><i>Paintbrush</i></b> .....	<b>259</b>
<b>9</b>	<b><i>Terminal</i></b> .....	<b>315</b>
<b>10</b>	<b><i>Additional Accessories</i></b> .....	<b>355</b>

---

---

**Chapter**  
**7**

**Write**

<b>Creating a Document</b> .....	<b>223</b>
Typing Text .....	224
<b>Editing a Document</b> .....	<b>224</b>
Moving Around in a Document .....	224
Selecting Text .....	226
Finding and Changing Text .....	227
Inserting Optional Hyphens .....	231
Editing Pictures in Write .....	232
Breaking a Document into Pages .....	234
<b>Formatting Your Document</b> .....	<b>237</b>
Formatting Characters .....	237
Changing Fonts and Font Sizes .....	239
Formatting Paragraphs .....	240
Formatting a Whole Document .....	246
<b>Managing Write Files</b> .....	<b>253</b>
Opening a Microsoft Word Document .....	253
Opening a Windows Text File .....	253
Opening a Non-Windows Text File .....	254
Saving a Document .....	254
Making a Backup Copy .....	255

---

<b>Printing a Document .....</b>	<b>255</b>
<b>Changing Printers and Print Option Settings .....</b>	<b>257</b>

# Creating a Document

Microsoft Windows Write is a word processing application that you can use to create and print documents for day-to-day business and personal use. To create Write documents, you need to know how to type, edit, and format text in the Write window; save the text to a file; and print your documents on your printer. The following sections explain each of these tasks.

## ▶ To start Write:

1. Open the Accessories window.
2. Double-click the Write icon.  
Or select Write and choose Open from the File menu.  
The following blank, untitled, Write window appears.

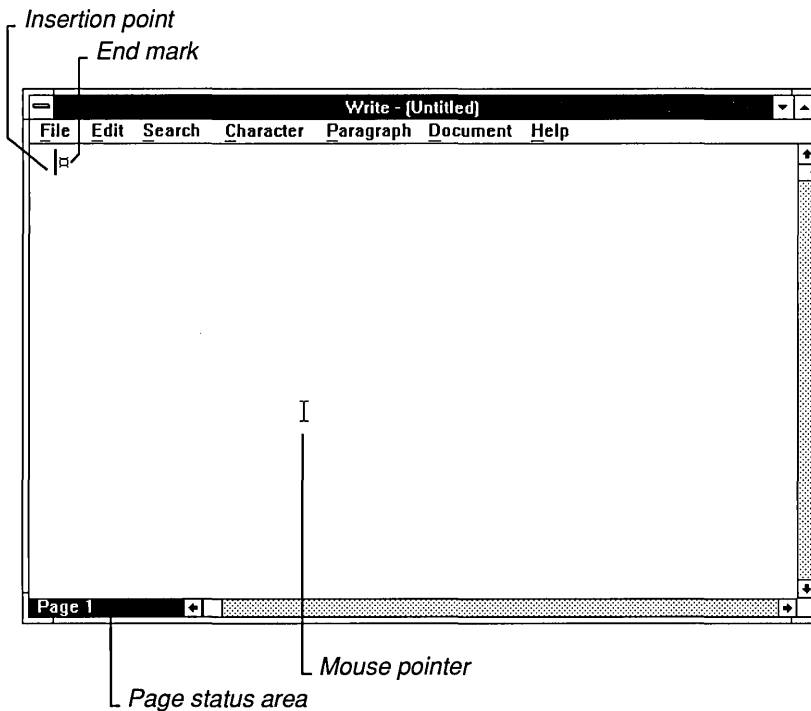

In the Write window, you see the following items:

- The *insertion point* indicates where text appears when you start typing. When you start Write or open an existing document, the insertion point appears in the upper-left corner of the Write window.
- The *end mark* indicates the end of a document. When there is no text in a Write window, the end mark is directly to the right of the insertion point.
- The *page status area* indicates which page of your text is currently on the screen. Until you break a document into pages, you will see only “Page 1” in the page status area.
- The *mouse pointer* appears only if you have a mouse connected to your computer. It indicates where the mouse is pointing inside the window and where the insertion point will move to if you click the mouse button.

## ***Typing Text***

When you are ready, just start typing. The text that you type starts filling the Write window at the insertion point. When you reach the end of the line, Write automatically *wraps* your text to the beginning of the next line. To start a new paragraph, press ENTER. If you want to leave a blank line between paragraphs, press ENTER twice.

If you make a mistake while typing, press BACKSPACE to back up the insertion point and erase the mistake. Chapter 2, “Basic Skills,” explains other basic editing techniques, and the following section explains editing techniques specific to Write.

## ***Editing a Document***

Editing is much the same in Write as in any other Windows application (see Chapter 2, “Basic Skills,” for more information). However, in addition to providing the same editing features used throughout Windows, Write offers various special editing techniques. The following sections explain each of these techniques.

## ***Moving Around in a Document***

You can use the scroll bars, as explained in Chapter 2, “Basic Skills,” to move around in your Write document. To move the insertion point, point to a location in the document and click the mouse button.

Since a word processing application relies heavily on using the keyboard, Write includes a number of special keys for moving quickly around a Write document. These are in addition to the DIRECTION keys, the SPACEBAR, and ENTER, which are described in Chapter 2. The GOTO key referred to in the following list is 5 on the numeric keypad.

<u>Press this</u>	<u>To move to the</u>
CTRL + RIGHT	Next word
CTRL + LEFT	Previous word
GOTO + RIGHT	Next sentence
GOTO + LEFT	Previous sentence
HOME	Beginning of a line
END	End of a line
GOTO + DOWN	Next paragraph
GOTO + UP	Previous paragraph
CTRL + PAGE DOWN	Bottom of the window
CTRL + PAGE UP	Top of the window
GOTO + PAGE DOWN	Next page
GOTO + PAGE UP	Previous page
CTRL + HOME	Beginning of the document
CTRL + END	End of the document

**NOTE** You can move the insertion point continuously by holding down any of these key combinations.

You can use GOTO + PAGE DOWN and GOTO + PAGE UP to move to the next or previous page only after you either print your document or use the Repaginate command to divide your document into pages. Write stores page breaks with a document and remembers them each time you use the document. See “Breaking a Document into Pages” later in this chapter for more information.

If you have divided a document into pages, you can move to a specific page by choosing the Go To Page command from the Search menu.



▷ **To move to a specific page:**

1. Choose Go To Page from the Search menu.  
Or use the shortcut key, F4.  
The Go To dialog box appears.

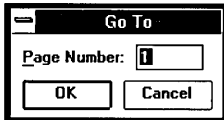

2. Type the number of the page you want to move to in the Page Number box.
3. Choose OK.  
The dialog box disappears, and the insertion point moves to the beginning of the selected page.

## Selecting Text

In Write, many of the editing commands require that you first *select* the text you want to edit. The easiest way to select text is to press the mouse button and drag the mouse pointer. See Chapter 2, “Basic Skills,” for the general selecting techniques used throughout Windows.

In addition to these general techniques, Write also features a technique for selecting with the *selection area* and a mouse. The selection area is at the far left edge of the Write window, as shown in the following illustration:

*The mouse pointer in the selection area*

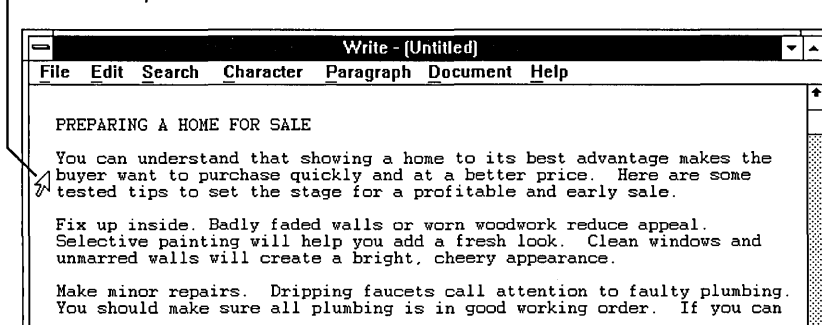

In the selection area, the mouse pointer changes to an arrow that slants to the right. The following list shows how you can use the selection area to select text:

<u>To select</u>	<u>Do this</u>
By the line	Move to the selection area and point next to a line. Click the mouse button once to select the line. To select more than one line, press the mouse button and drag the pointer.
By the paragraph	Move to the selection area and point next to any line in the paragraph. Double-click to select the paragraph. To extend the selection one paragraph at a time, hold the mouse button down after the second click and drag the pointer.
Between points	Move to the selection area and select a line or paragraph. Move along the selection area to another line or paragraph, hold down SHIFT, and click the mouse button. Write selects all lines or paragraphs between the two points.
The entire document	Move to the selection area, hold down CTRL, and click the mouse button.

▷ To cancel a selection:

- Move the mouse pointer back inside the document and click the mouse button.

## ***Finding and Changing Text***

You can easily search for and edit text in your Write documents by using the Find and Change commands on the Search menu. These commands allow you to:

- Search for text up to 255 characters in length.
- Change all occurrences of the text in the document.
- Change only certain occurrences of text.

The following sections explain how to use the Find and Change commands.

## ***Finding Text***

Using the Find command on the Search menu, you can look for a character, word, or group of characters or words in a Write document.

When you choose the Find command, Write starts a search at the insertion point or at the end of any text that is currently selected. When it reaches the end of the document, Write automatically continues searching from the beginning of the document to its original starting point.

### **▷ To find text:**

1. Position the insertion point where you want to start your search.
2. Choose Find from the Search menu.

The Find dialog box appears.

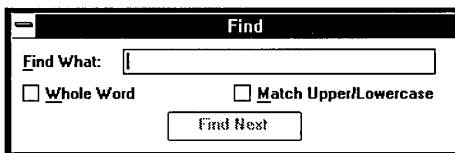

3. In the Find What box, type the text you want to find.
4. Select the Whole Word check box if you want to find only separate occurrences of the search text.  
Otherwise Write finds, for example, *main* in *remainder*.
5. Select the Match Upper/Lowercase check box if you want to match capitalization exactly.  
Otherwise Write finds, for example, both *Main* and *main*.
6. Choose Find Next (or press ENTER) to start the search.  
Write searches for the text and selects the first occurrence. If you want to edit the text, point to it and click the mouse button to switch from the dialog box to the document. (If you are using the keyboard, press ALT + F6 to switch from the dialog box to the document and back again.)  
If there are no occurrences of the text in the document, Write displays a message telling you that it could not find the search text.
7. Choose Find Next (or press ENTER) again to find the next occurrence of the search text.

When Write finds the last occurrence of the search text, it displays a dialog box telling you that the search is complete.

8. Choose Close from the Control menu (or press ESC) to close the Find dialog box.

To search for text that includes wildcard characters, spaces, tabs, paragraph marks, and page breaks, type the following characters (where ^ means the caret symbol) in the Find What box:

<u>Type</u>	<u>To represent</u>
?	Any character in a file (called a <i>wildcard</i> character). For example, if the search text is <i>hea?</i> , Write finds every word with <i>hea</i> , such as <i>headstrong</i> , <i>figurehead</i> , <i>heal</i> , <i>heap</i> , or <i>heat</i> .
^w	A space anywhere in your document—between words, between paragraphs, and so on.
^t	A tab character.
^p	A paragraph mark.
^d	A manual page break. For more information, see “Breaking Pages Manually” later in this chapter.

## ***Changing Text***

The Change command on the Search menu allows you to find text and replace it with new text. You can find and change all occurrences of the search text automatically, or you can decide whether to change each occurrence as Write finds it.

When you choose the Change command, Write searches forward from the insertion point. When it reaches the end of the document, Write automatically continues searching from the beginning of the document to the insertion point. If you select a section of your document before choosing Change, however, the command searches only within that selection.

### **▷ To find and change text:**

1. Position the insertion point where you want to start your search.  
If you want to make changes to only part of your document, select that part.
2. Choose Change from the Search menu.  
The Change dialog box appears.

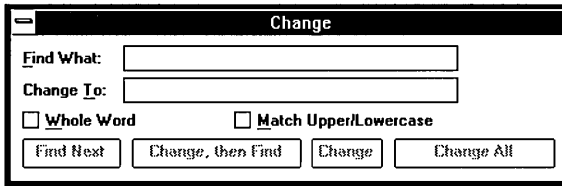

3. In the Find What box, type the text you want to find, and in the Change To box, type the text you want to replace it with.  
For information on how to search for text that includes wildcard characters, spaces, tabs, paragraph marks, and page breaks, see the previous section, “Finding Text.”
4. Select the Whole Word check box if you want to find only separate occurrences of the search text.
5. Select the Match Upper/Lowcase check box if you want to match capitalization exactly.
6. Choose one of the following options to start the search: Find Next; Change, then Find; or Change All. If you selected a section of your document to make changes in, choose Change Selection. For an explanation of these options, see the list that follows.  
Write displays a dialog box telling you when a search is complete. If there are no occurrences of the text in the document, Write displays a message telling you that it could not find the search text.
7. Choose Close from the Control menu (or press ESC) to close the Change dialog box.

The following list describes the options available when you choose the Change command:

<u>Use this option</u>	<u>To do this</u>
Find Next	Find the next occurrence of the search text. If you want to manually edit the text, click the text (or press ALT + F6) to switch to the document.
Change, then Find	Change the currently selected search text and then find the next occurrence. If no text is selected, choosing this option finds the first occurrence of the search text.

---

<u>Use this option</u>	<u>To do this</u>
Change	Change the currently selected search text. Write then waits for instructions.
Change All	Automatically change all occurrences of the search text in the document.
Change Selection	Automatically change all occurrences of the search text in the selected section of the document. The Change All button changes to Change Selection when you select a section of text in your document.

### ***Using the Repeat Last Find Command***

You do not have to keep the Find or Change dialog box on the screen throughout the entire search. You can use the Repeat Last Find command on the Search menu to continue a search after finding the first occurrence of search text. You cannot, however, make automatic changes to text if you use Repeat Last Find to find text.

#### **▷ To repeat the last find:**

1. Use Find or Change to find the first occurrence of the search text.
2. Close the Find or Change dialog box.
3. Change the search text, if necessary.
4. Choose Repeat Last Find from the Search menu to find the next occurrence of the search text.

Or press F3 to quickly choose Repeat Last Find.

### ***Inserting Optional Hyphens***

As you look over the text in your document, you may occasionally see a large gap at the end of a line where a long word has been wrapped to the beginning of the next line. You can eliminate such gaps at the end of a line by inserting optional hyphens in long words to specify correct hyphenation points. Write then uses one of these hyphenation points to break these words at the end of a line. Optional hyphens are invisible unless they appear at the end of a line.

▷ To insert optional hyphens in a word:

- Press CTRL + SHIFT + HYPHEN (-) at each desired hyphenation point.

If you type a normal hyphen at the end of a line of text, Write will always break the line at that hyphen.

## ***Editing Pictures in Write***

You can cut and copy text and graphics from other Windows applications and paste them into your Write documents using the Clipboard. See Chapter 2, “Basic Skills,” for more information about transferring information between Windows applications using the Clipboard.

When you paste a picture or graph into Write, it always appears at the left margin. If you paste a picture that was created using colors, the colors are converted to black and white. You can select the picture and move it horizontally or change its size. You can also select the picture and cut, copy, or paste it just as you would the text in the document.

Write displays pictures in a screen resolution that is appropriate for the printer you have selected. Because of differences in screen and printer resolutions, pictures may seem slightly distorted on the screen. However, when you print a picture in a Write document, the resolution will be correct.

### ***Moving a Picture***

You can move a picture horizontally in a document by using the Move Picture command on the Edit menu.

▷ To move a picture:

1. Click the picture to select it.  
Or use UP ARROW and DOWN ARROW to move the insertion point to the picture.
2. Choose Move Picture from the Edit menu.  
A square cursor appears in the center of the picture and a dotted frame surrounds the picture.
3. Without pressing the mouse button, move the cursor right or left to move the dotted frame.  
Or press RIGHT ARROW or LEFT ARROW to move the dotted frame.

You can press ESC if you want to cancel the move.

4. When the frame is where you want it, click the mouse button.

Or press ENTER.

If you are not satisfied with the position of your picture after clicking the mouse button or pressing ENTER, you can choose Undo from the Edit menu to return the picture to its original position.

**HINT** You can also use the formatting commands (Left, Centered, Right) from the Paragraph menu to move a picture.

### ***Changing the Size of a Picture***

You can enlarge or reduce a picture in Write with the Size Picture command on the Edit menu.

#### **▷ To change the size of a picture:**

1. Click the picture to select it.  
Or use UP ARROW and DOWN ARROW to move the insertion point to the picture.
2. Choose Size Picture from the Edit menu.  
A square cursor appears in the center of the picture and a dotted frame surrounds the picture.
3. Without pressing the mouse button, move the cursor until it rests halfway across the left side, right side, or bottom of the frame.  
Or press LEFT ARROW, RIGHT ARROW, or DOWN ARROW to move the cursor.  
To change the length and width of the picture at the same time, move the cursor halfway across a lower corner of the dotted frame.
4. Move the cursor in the direction you want to enlarge or reduce the picture.  
Press a DIRECTION key to move the cursor using the keyboard.  
If you are not satisfied with the size of your picture, press ESC to return the picture to its original size.
5. When the frame is the size you want, click the mouse button.  
Or press ENTER.

If you are not satisfied with the size of your picture after clicking the mouse button or pressing ENTER, you can choose Undo from the Edit menu to return the picture to its original size.



**HINT** The lower-left corner of the Write window displays sizing information in the form of *x* and *y* location values. It is best to keep the *x* and *y* values the same and to position the frame at whole rather than fractional numbers (for example, 5 rather than 5.5). This will prevent distortion of the picture.

## ***Breaking a Document into Pages***

When you finish editing your document, you might want to see where Write proposes to break the document into pages for printing. You can have Write break a document into pages at any time.

### ***Breaking Pages Automatically***

When Write automatically breaks your document into pages, it prevents a single line in a paragraph from being printed by itself at the top or bottom of a page. By breaking a document into pages before printing, you can see where automatic page breaks will occur and decide where you might want to put *manual page breaks*, which tell Write to start a new page at a place that you designate.

By breaking a document into pages before printing, you can also make sure that manual page breaks are still in the right place after you edit a document. You can choose to confirm or change each page break as Write creates it.

#### **▷ To break a document into pages automatically:**

---

1. Choose Repaginate from the File menu.

The Repaginate Document dialog box appears.

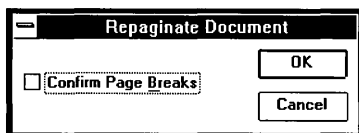

2. If you want to approve each page break as Write creates it, select the Confirm Page Breaks box. See “Confirming Page Breaks” later in this chapter for more information.

3. Choose OK.

As Write breaks the document into pages, the page numbers appear in the page status area at the lower-left corner of the window.

The page breaks that Write automatically assigns to the document look like the arrows in the following illustration:

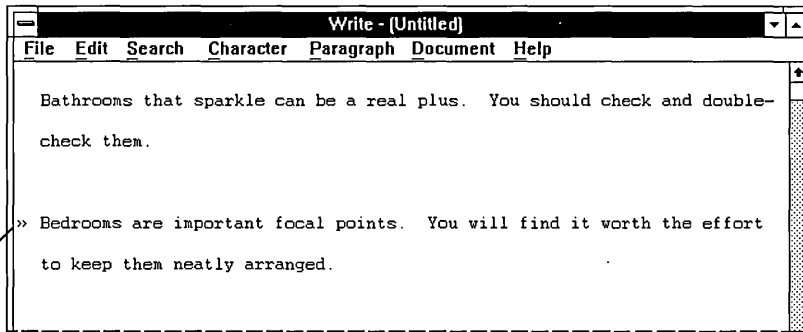

These arrows indicate the first new line of each page.

## Breaking Pages Manually

If you know you want a page to end or begin at a certain place, you can insert a manual page break at any time.

### ▷ To insert a manual page break:

1. Position the insertion point where you want the page break to occur.
2. Press CTRL + ENTER.

A dotted line appears in the document to show where you inserted the page break.

#### Manual page break

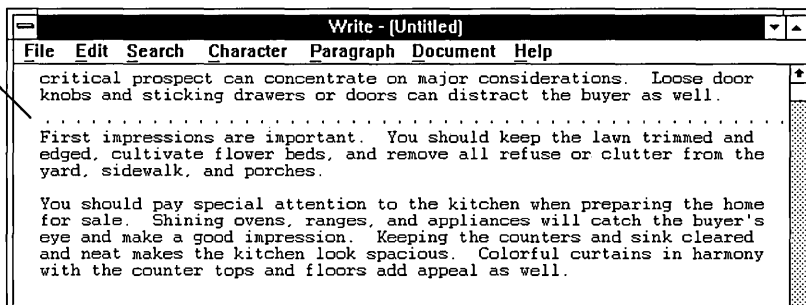

Manual page breaks can be selected, deleted, or copied just like any other character in a document.

## ***Confirming Page Breaks***

If you select the Confirm Page Breaks box in the Repaginate Document dialog box, Write stops at each page break that it proposes to insert and any page breaks that you inserted manually. The following dialog box appears every time Write stops at a page break that it proposes to insert:

*Write proposes to break the page here.*

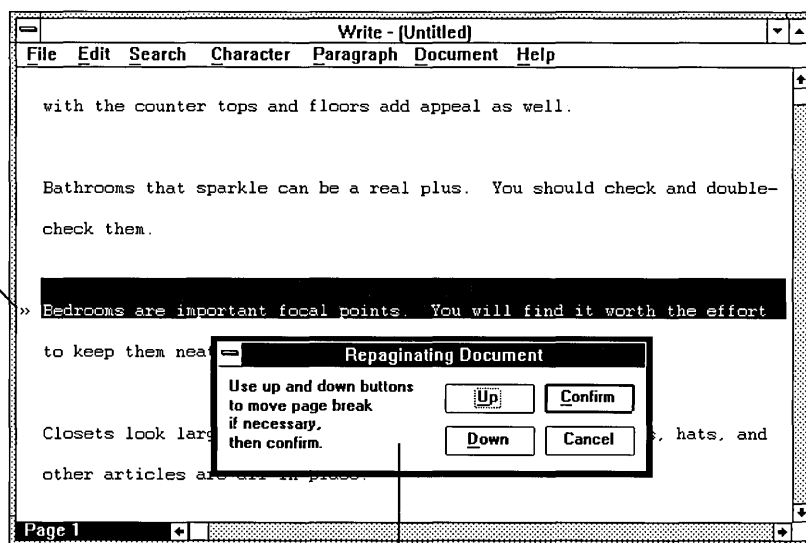

*You can confirm the page break or move it.*

You can move an automatic page break up from where Write proposes to put it, but you cannot move it down. The Down button in the dialog box allows you to move the page break down only if you previously moved it up.

Each time Write stops at a manual page break, it displays a dialog box so that you can confirm or remove the manual break.

# Formatting Your Document

When you format your Write document, you determine how you want the document to look. You can determine the appearance of characters throughout the document, the spacing and alignment of lines in each paragraph, and the page layout for the entire document. Most of the formats you choose look the same on your screen as in the printed document.

## Formatting Characters

The commands on the Character menu control how you format the characters in your document. You can format characters by:

- Using different character styles, such as bold, italic, and underline.
- Creating superscripts and subscripts.
- Using different fonts and font sizes.

Choosing one of the Character-menu commands affects text that is currently selected or text that you are about to type. A new paragraph will have the same character formatting as the previous paragraph.

Write usually displays the same character formats that you will see when you print your document. If your printer cannot print a certain font, point size, or character style, Write attempts to match the selected character format as closely as possible.

Write saves character formats when you save your document. Write also transfers character formats when you move or copy formatted text to other parts of the same document or to another Write document.

## Applying Character Styles

Character styles add emphasis to text by making it bold, italic, or underlined. You can apply more than one style to the same characters. For example, you can bold, italicize, and underline the same text.

### ▷ To format existing text in bold, italic, or underline:

1. Select the text you want to format.
2. Choose the style you want to use from the Character menu.  
The selected text changes to the format that you chose.

▷ To format text that you are about to type in bold, italic, or underline:

1. Choose the style you want to use from the Character menu.
2. Type your text.  
The text appears in the format that you chose.

▷ To cancel a character style:

1. Select the text for which you want to cancel the character style.
2. Choose the style from the Character menu again.  
The checkmark next to the style on the menu disappears.

If you want to cancel all styles used in a selected portion of text, choose Normal from the Character menu.

### ***Creating Superscripts and Subscripts***

Superscript and subscript characters appear slightly above or below other text. They are also scaled to a smaller size.

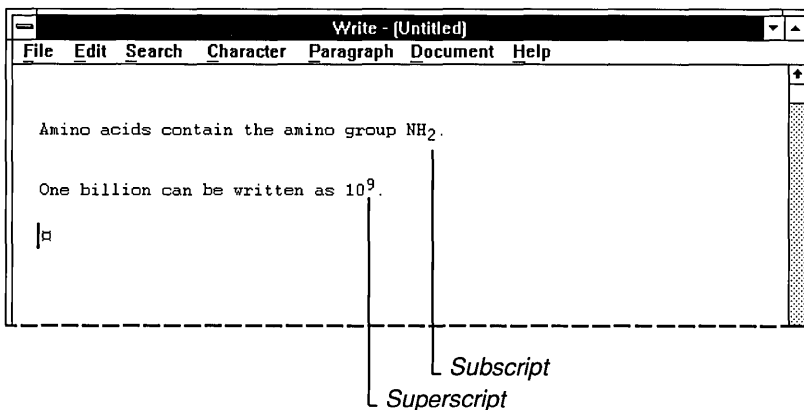

▷ To format text as superscript or subscript:

1. Select the text you want to format as superscript or subscript.
2. Choose Superscript or Subscript from the Character menu.  
Write repositions the text you selected.

## ***Using Fonts***

A font is a graphic design applied to all text, numerals, and other characters. If possible, Write displays the same fonts and sizes that you will see when you print your document. If Write cannot exactly match the selected font on the screen, it substitutes a font that resembles the selected font as closely as possible. Whenever Write uses a substitute font in your document, it still uses the correct line and page breaks.

The Character menu contains the names of up to three fonts as well as commands to reduce or enlarge fonts. If more than three fonts are available for use, you can see the additional font names by choosing the Fonts command to display the Fonts dialog box. If you use the fonts in the Fonts dialog box more than those on the Character menu, the font names on the Character menu automatically change to the font names you use most often.

The currently selected printer determines the fonts that are available. If you plan to print the document on a printer other than the currently selected printer, you must set up the other printer using either Control Panel or Write's Printer Setup command. Then you can use its fonts for text in your document. For more information about fonts and the default printer, see Chapter 5, "Control Panel."

## ***Changing Fonts and Font Sizes***

When you start typing text in a new document, Write uses the standard font for the default printer. If you want to use a different font, you can choose one of the font names displayed on the Character menu or in the Fonts dialog box.

### **▷ To change to a font displayed on the Character menu:**

- Choose the font name from the Character menu.

### **▷ To change the font size by using the Character menu:**

- Choose the Reduce Font command or the Enlarge Font command from the Character menu.

When you choose Reduce Font or Enlarge Font, Write changes the font size to the next smaller or larger size. The sizes are determined by Write, independent of the default printer. If you choose Reduce Font or Enlarge Font and the default printer does not support the next smaller or larger size, the text you type does not change size on the screen.

If you want to change the font or font size for text that is already typed, you must select the text before you choose the new font or size. The Character menu displays a checkmark, the font size, and the font name if the entire selected region contains only one font and font size. Items that differ in the selected region are not displayed.

▷ **To change a font or font size with the Fonts command:**

1. Choose the Fonts command from the Character menu.  
The Fonts dialog box appears.

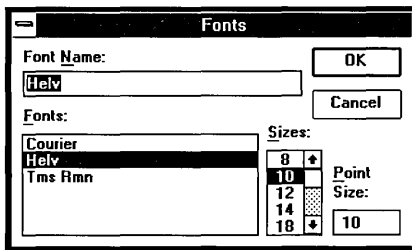

2. In the Fonts box, select the name of the font you want to use.  
Or type the name of the font in the Font Name box.
3. In the Sizes box, select a size for the font.  
Or type the new size in the Point Size box.
4. Choose OK.  
If you enter a font size that cannot be printed on the default printer, Write does not change the size of text on the screen.

## ***Formatting Paragraphs***

The format of a paragraph includes the alignment, spacing, and indentation of the lines in the paragraph. A new paragraph starts out with the same format as the previous paragraph. For example, if you are typing a paragraph that is double-spaced and press ENTER to start a new paragraph, the text you type in the new paragraph will also be double-spaced.

You can use either the Ruler or the commands on the Paragraph menu to change the format in each paragraph of a document. Before choosing a command from the

Paragraph menu, position the insertion point inside the paragraph you want to format. If you want to format more than one paragraph at the same time, select all the paragraphs you want to format.

## ***Displaying the Ruler***

If you have a mouse, you can change paragraph formats using the Ruler.

### **▷ To display the Ruler:**

- Choose Ruler On from the Document menu.

The Ruler appears at the top of the Write window.

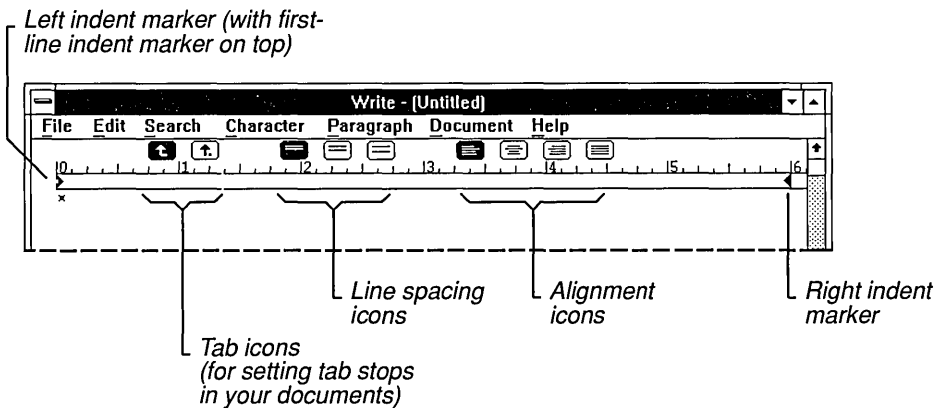

### **▷ To hide the Ruler:**

- Choose Ruler Off from the Document menu.

The following sections explain the different ways in which you can format your paragraphs. They also explain how to use the Ruler to create each format.

## ***Adding and Removing Paragraph Marks***

A paragraph mark is not a visible character in a document, but it invisibly marks the end of a paragraph or a blank line.



▷ **To add a paragraph mark:**

1. Press ENTER after typing the last character in a paragraph.
2. If you want a blank line between paragraphs, press ENTER again.

Although there is no visible character for the paragraph mark, you can select, delete, copy, and move a paragraph mark just as you do other characters.

You can select individual paragraph marks, as shown in the following illustration.

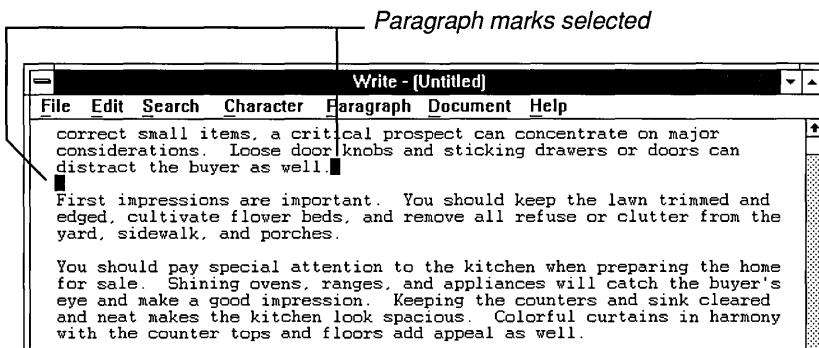

Or you can make a selection that includes both text and paragraph marks.

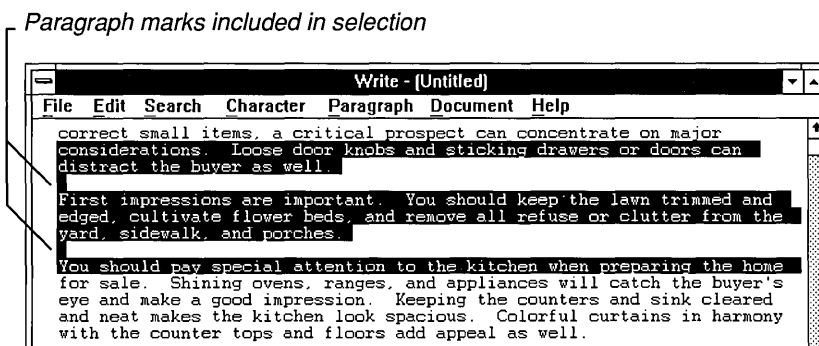

When you copy or move a paragraph, include the paragraph mark in the selection to keep the paragraph formats with the paragraph.

▷ To remove a paragraph mark:

1. Place the insertion point at the beginning of the paragraph following the mark you want to remove.
2. Press BACKSPACE.  
If your paragraphs have a blank line between them, press BACKSPACE twice.

## ***Changing Paragraph Alignment***

You can align a paragraph in any of the following ways:

- At the left margin
- At the right margin
- Justified between both margins
- Centered between both margins

▷ To change the alignment of a paragraph:

1. Place the insertion point inside the paragraph you want to change.
2. Choose the alignment command you want to use from the Paragraph menu.  
Write realigns the paragraph according to the command you chose.

▷ To change paragraph alignment by using the Ruler:

1. Place the insertion point inside the paragraph you want to change.
2. Click the appropriate paragraph-alignment icon above the Ruler.

## ***Changing Paragraph Line Spacing***

You can change the line spacing in a paragraph to single-spacing, one and one-half line spacing, or double-spacing.

▷ To change line spacing:

1. Place the insertion point inside the paragraph you want to change.
2. Choose a line spacing command from the Paragraph menu.  
The line spacing in the selected paragraph changes to reflect your menu choice.

▷ To change line spacing with the Ruler:

1. Place the insertion point inside the paragraph you want to change.
2. Click the appropriate linespacing icon above the Ruler.

***Changing the Indentation of a Paragraph***

When you first type a paragraph into Write, the text fills the area between the left and right margins. You can indent an entire paragraph from the left or right margin, or you can indent just the first line of a paragraph from the left margin.

Indenting the lines of a paragraph differs from changing the left or right margins for a paragraph. Write indents paragraph lines *from* the current margin setting. You should set the margins that you want to use for your paper size first (or use the standard settings provided by Write) and then indent the paragraphs of your document. For more information about margins, see “Changing the Page Layout” later in this chapter.

▷ To change the indentation of a paragraph:

1. Place the insertion point inside the paragraph you want to change.
2. Choose the Indents command from the Paragraph menu.

The Indents dialog box appears.

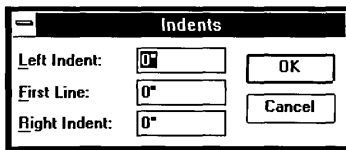

3. Type a measurement for any indentation you want to change.  
The measurement can be in inches or centimeters, depending on the Measurements setting in the Page Layout dialog box. See “Changing the Page Layout” later in this chapter for more information.
4. Choose OK.

▷ To change the indentation of a paragraph by using the Ruler:

1. Place the insertion point inside the paragraph you want to change.

2. Drag the appropriate indent marker to a new position on the Ruler.

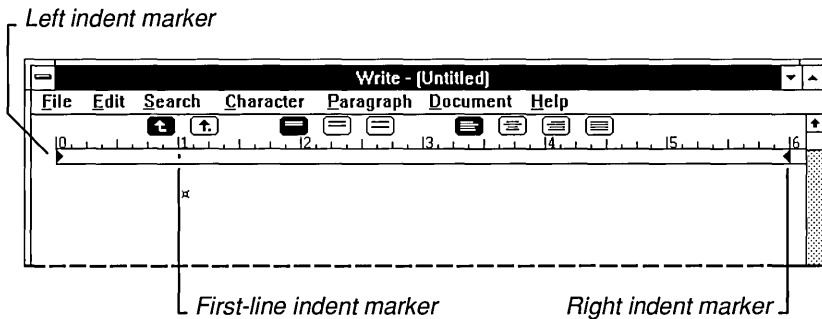

The indents you create with the Ruler are reflected in the Indents dialog box.

### Creating a Hanging Indent

You can also use the Indents command to create a *hanging indent*. In a paragraph with a hanging indent, the first line extends farther to the left than the rest of the paragraph as would happen in a numbered or bulleted list.

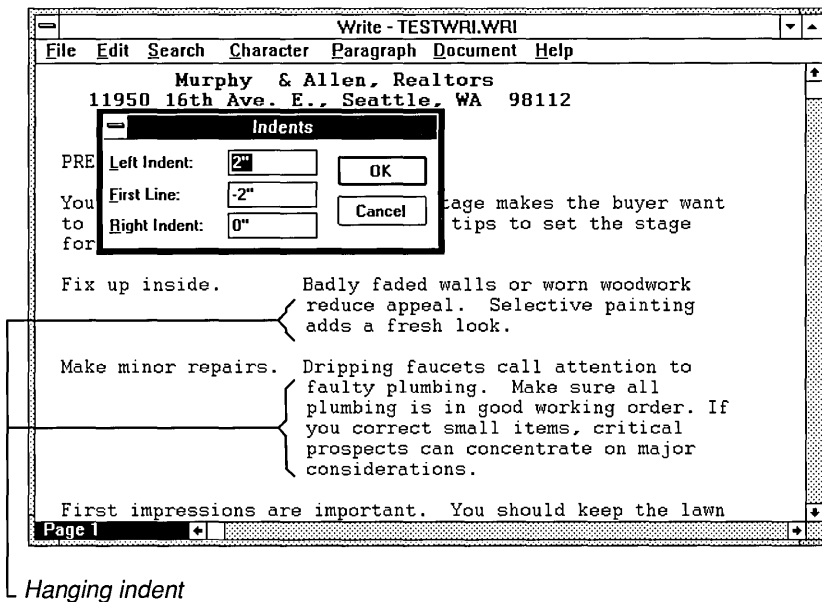

▷ **To create a hanging indent:**

1. Place the insertion point inside the paragraph in which you want to create the hanging indent.
2. Choose the Indents command from the Paragraph menu.
3. Enter a positive number in the Left Indent box to set the indentation for the entire paragraph.
4. Enter a negative number in the First Line box to set the indentation for the first line.

Both measurements can be in inches or centimeters, depending on the Measurements setting in the Page Layout dialog box. See “Changing the Page Layout” later in this chapter for more information on these settings.

5. Choose OK.

The selected paragraph is reformatted according to the measurements you entered.

## ***Formatting a Whole Document***

The commands on the Document menu affect the document as a whole. When you start a new document, it is automatically formatted to look like the document in the following illustration:

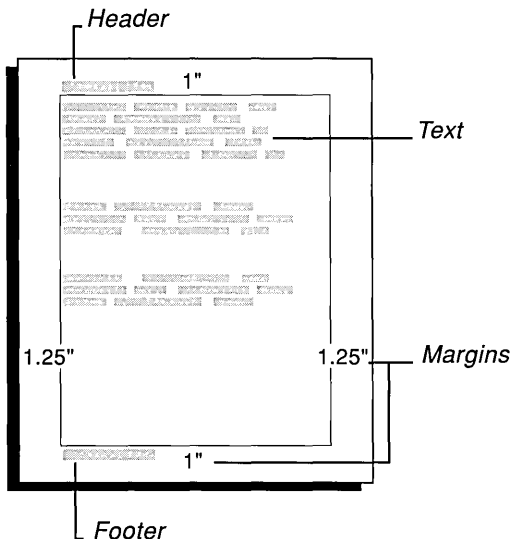

Commands on the Document menu affect the following parts of a document:

- A *header* is text that appears at the top of every page. The standard position of the header is .75 inch from the top of the page at the left margin.
- A *footer* is text that appears at the bottom of every page. The standard position of the footer is .75 inch from the bottom of the page at the left margin.
- *Text* is single-spaced and aligned at the left margin without any indentations.
- The *standard margins* allow 1 inch of space at the top and bottom of the document and 1.25 inches at the left and right edges.

### ***Using Headers and Footers***

You can have one header and one footer in each Write document. Using the Header or Footer commands, you can:

- Enter the text you want to use as a header or footer.
- Include page numbers in the printed document.
- Start the header or footer on the first or second page of the document.
- Change the distance between the header or footer and the top or bottom of the page.

#### **▷ To add a header or footer:**

---

1. Choose Header or Footer from the Document menu.

A blank Header or Footer document window and the Page Header or Page Footer dialog box appear.

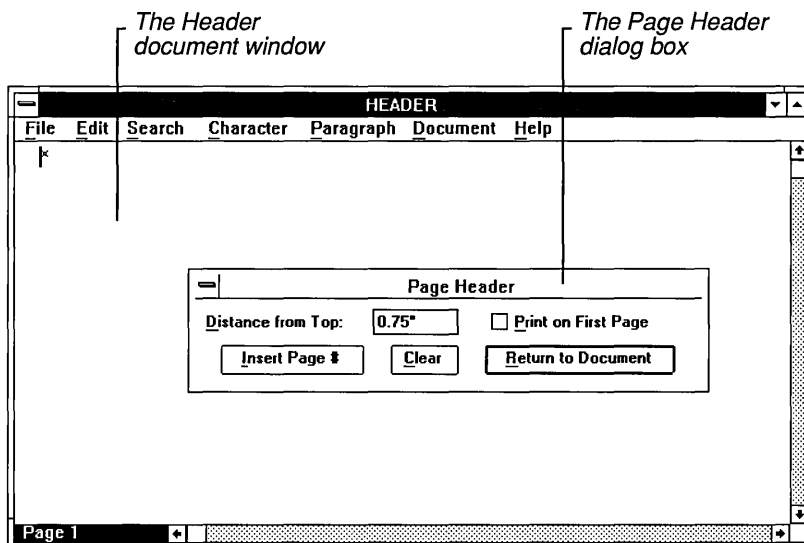

2. Type the text for the header or footer in the blank document window.  
You can format the text as you would any other text. For example, if you want to center the text, choose Centered from the Paragraph menu before or after you type the text.  
If you make a mistake, you can use BACKSPACE to correct the last few characters typed, or you can choose the Clear button in the Page Header or Page Footer dialog box to erase all the text in the document window and start over.
3. Click the Page Header or Page Footer dialog box.  
Or press ALT + F6 to select the dialog box.
4. Type a measurement in the Distance from Top or Distance from Bottom box if you want to change the distance between the header or footer and the edge of the page.  
The measurement can be in inches or centimeters, depending on the Measurements setting in the Page Layout dialog box. See "Changing the Page Layout" later in this chapter for more information on these settings.
5. Select the Print on First Page check box if you want the header or footer to appear on the first page of the printed document.  
Otherwise, the header or footer starts on the second page.
6. Choose the Insert Page # button to print page numbers in the document. See the following section for more information about using page numbers.

7. When you finish setting up your header or footer, choose Return to Document.  
Or press ESC to return to your document.

When you print your document, you will see the headers and footers. They do not appear on the screen.

▷ **To use page numbers in headers or footers:**

1. Depending on where you want your page numbers to appear, choose Header or Footer from the Document menu.
2. Type any text that you want included with the page number in the Header or Footer window.
3. Move the insertion point to where you want the page number to appear on the line. (Choose Centered or Right from the Paragraph menu to quickly center or right justify the header or footer.)
4. Click the Page Header or Page Footer dialog box.  
Or press ALT + F6 to select the dialog box.
5. Choose Insert Page #.  
Choosing this button inserts (*page*) in the document window at the location of the insertion point.
6. Select the Print on First Page check box if you want a page number to appear on the first page of the printed document.  
If you want your first page to be a cover page without a number, do not select the Print on First Page check box.
7. Choose Return to Document.

When you print your document, consecutive page numbers appear on the printed pages.

## **Setting Tabs**

Write has tabs preset at every half inch. You can use these preset tabs to create a column of items aligned to the left. Preset tabs do not appear in the Tabs dialog box or on the Ruler.

You can easily set your own tabs for lists or tables by using the Tabs command on the Document menu or by using the Ruler. Tabs that you set override the preset tabs. You can set up to 12 tabs—either left-aligned tabs or *decimal* tabs. Decimal tabs let you create a column of numbers that line up on their decimal points.



▷ **To set tabs:**

1. Choose Tabs from the Document menu.  
The Tabs dialog box appears.

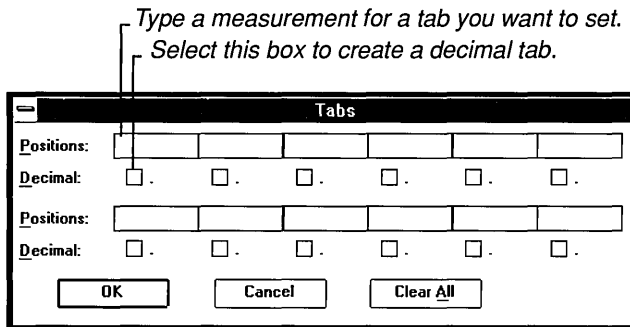

2. Select a position box.  
Press TAB to move to a position box using the keyboard.
3. Type a measurement.  
This will be the location of the tab stop from the left margin. The number can be in inches or centimeters, depending on the Measurements setting in the Page Layout dialog box. See “Changing the Page Layout” later in this chapter for more information on these settings.
4. If you want a decimal tab, select the Decimal box below the measurement you type.
5. Choose OK.

The tabs you set in the Tabs dialog box also appear on the Ruler.

**HINT** When you type text at a decimal tab stop, the characters you type are inserted to the left of the tab stop until you type a decimal point. The decimal point is inserted at the tab stop, and any additional characters you type are inserted to the right of the decimal point. You can use a decimal tab to line up text to the right, as long as you don’t use more than one period in the text.

### ▷ To delete a tab:

1. Choose Tabs from the Document menu.  
The Tabs dialog box appears.
2. Select the position box for the tab you want to delete and remove the measurement there.  
To delete all tabs at once, choose the Clear All button.

### ▷ To set tabs with the Ruler:

1. Click the appropriate tab icon above the Ruler.

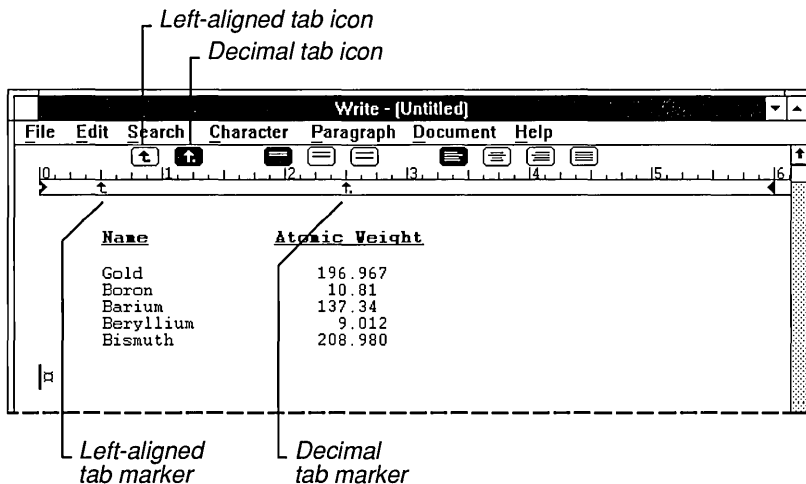

2. Click the Ruler where you want to set the tab.  
You can also drag an existing tab marker to a new position.

The tabs you set with the Ruler appear in the Tabs dialog box.

### ▷ To delete a tab using the Ruler:

- Drag the tab marker you want to remove down and off the Ruler.

## ***Changing the Page Layout***

When printing a document, Write automatically:

- Uses inches in measurements.
- Uses 1-inch top and bottom margins.
- Uses 1.25-inch side margins.
- Numbers the first page as page 1.

You can use the Page Layout command on the Document menu to change these settings.

### **▷ To change the page layout settings for a document:**

1. Choose Page Layout from the Document menu.  
The Page Layout dialog box appears.

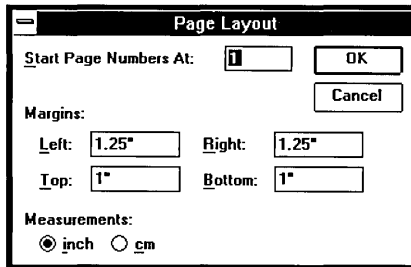

2. If you want to start numbering your document with a number other than page 1, type the number with which you want to start in the Start Page Numbers At box. This number appears on the first page of your document if you have a page number in your header or footer. See “Using Headers and Footers” earlier in this chapter.
3. In the Margins boxes, type the margins you want to use.
4. Select the cm option if you want to use metric measurements.
5. Choose OK.

If you enter a starting page number, Write adjusts the page numbers displayed in the lower-left corner of the window. Write also uses the adjusted page numbers for the Go to Page command on the Search menu.

## Managing Write Files

Working with Write files is much the same as working with any other Windows file. If you have not already done so, read Chapter 2, “Basic Skills,” for information about opening and saving Windows files, and Chapter 4, “File Manager,” for information about managing Windows files.

The maximum size of a Write file is limited only by the amount of memory in your computer. Windows automatically assigns the extension .WRI to a document you create using Write and saves the document as a Write file. If you prefer, you can choose to save your document in one of several other formats. You can also open and work with files that were not created using Write. The following sections discuss these topics.

### Opening a Microsoft Word Document

If you want to use Write to work with a Microsoft Word document, you must first convert the Word document to the Write format.

When you start to open the Word document file from Write, the Write dialog box appears asking whether or not you want to convert the text to the Microsoft Write format.

▷ **To convert a Word document to the Write format:**

- Choose the Convert option in the Write dialog box.

### Opening a Windows Text File

Most text files created with Windows applications are in ANSI format, which is the same format used for Write document files. When you start to open a Windows text file from Write, the Write dialog box appears, but you do not need to convert Windows text files.

▷ **To avoid converting a Windows text file:**

- Choose the No Conversion option in the Write dialog box.

**HINT** If you make a mistake in selecting Convert or No Conversion, simply quit Write without saving the file. Your file will be restored to its original status.

## Opening a Non-Windows Text File

Most text files created outside Windows are not in ANSI format. You must convert these files to the Write format.

When you start to open a non-Windows text file from Write, the Write dialog box appears.

▷ **To convert a non-Windows text file to the Write format:**

---

- Choose the Convert option in the Write dialog box.

---

**CAUTION** Be sure you back up a file before you convert it to the Write format. Also, do not convert any files that are not purely text files. In binary files, ASCII characters above 127 might be related to the program that created the file and, therefore, cannot be converted. Other files may contain control characters that should not be converted.

---

## Saving a Document

When you are working with a Write document—especially a large document—you should save your document often. Doing so helps Write perform faster and minimizes lost work if there is a power failure.

You have four formatting choices when you save a Write document:

**Use this format**

**To save your document as**

The standard proposed by Write (.WRI)

A Write-formatted document. When you first save the file, Write adds the extension .WRI to the filename.

Text Only

A Windows ANSI text file. You might want to use this option if your document is a program or will be telecommunicated. See Chapter 9, “Terminal,” for more information.

Microsoft Word Format

A Microsoft Word document. Do not use this format if you have any pictures in your document because they will disappear.

Text Only and Microsoft Word Format

An unformatted Microsoft Word text file.

## ***Making a Backup Copy***

You can automatically make a backup copy of a Write file when you save the file.

### **▷ To make a backup copy:**

- Select the Make Backup check box in the File Save As dialog box.

Thereafter, Write makes a backup copy each time you save an edited document.

If you save your document as a Write file, Write assigns the backup copy the extension .BKP. If you save your document as a Microsoft Word file, Write assigns the backup copy the extension .BAK.

If, before making a backup, you delete the extension from the filename of a Write document and save it in Microsoft Word format, the document and its backup are given the extensions .DOC for the document now in Word format and .WRI for the backup copy. This is the original version of the document in Write format.

Similarly, if you delete the extension of the filename from an existing Word document and save it in Write format, the document and its backup are given the extensions .WRI for the document now in Write format and .DOC for the backup copy. This is the original version of the document in Word format.

## ***Printing a Document***

If you have connected and installed a printer, you can print your Write documents. Chapter 5, “Control Panel,” describes how to install a printer.

### **▷ To print a document:**

1. Make sure the document is displayed in the Write window.
2. Choose Print from the File menu.  
The Print dialog box appears.

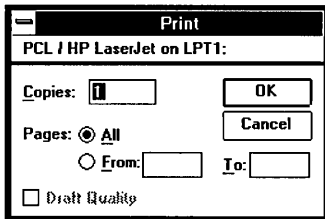

3. Select the options you want to use. (See the following list for more information about these options.)

4. Choose OK.

A dialog box appears telling you that Write is printing your document.

The following list describes how to use the options in the Print dialog box:

<u>Use this option</u>	<u>To do this</u>
Copies	Tell Write the number of copies you want to print. The standard setting is 1.
All Pages	Print all the pages in your document. This is the standard setting.
From/To Pages	Print a range of pages. After you select this option, type page numbers in the From and To boxes.
Draft Quality	Quickly print an unformatted copy of the text in your document. Pictures print as empty boxes when you select Draft Quality.

When printing, Write uses the margin settings in the Page Layout dialog box. If you want to position your document differently on the page, you can use the Page Layout command on the Document menu to change these settings. See “Changing the Page Layout” earlier in this chapter for more information.

## ***Changing Printers and Print Option Settings***

Write prints your documents on the default printer. If you have other printers installed and assigned as active printers, you can make any of these active printers the default printer using the Printer Setup command on the File menu. If you want to print to an installed inactive printer, you must use Control Panel to make the printer active. For more information, see Chapter 5, “Control Panel.”

### **▷ To change printers:**

1. Choose Printer Setup from the File menu.

The Printer Setup dialog box appears with a list of all the active printers.

2. Select from the Printer box the name of the printer to which you want to change.

If you want to change the print options for the selected printer, choose Setup. See Chapter 5, “Control Panel,” for information on print options.

3. Choose OK.

Write now automatically prints to the newly selected printer.

When you change printers, the appearance of your document may change on the screen. This is because Write applies the fonts and character formats available with the default printer. These changes may affect the line breaks and page breaks in the document. Use the Repaginate command to see the new page breaks. See “Breaking a Document into Pages” earlier in this chapter for more information.





---

---

**Chapter**  
**8**

**Paintbrush**

**Drawing with a Mouse or the Keyboard .....263**

**The Paintbrush Window .....263**

- Determining the Size of Your Drawing Area ..... 265
- Enlarging the Drawing Area ..... 266
- Moving Around in a Large Drawing ..... 267
- Viewing Your Drawing ..... 268

**Creating a Simple Drawing .....269**

- Selecting Background and Foreground Colors ..... 269
- Selecting a Drawing Width ..... 270
- Selecting and Using a Drawing Tool ..... 271
- Basic Graphics Editing ..... 272

**Entering Text .....273**

- Selecting the Text Tool ..... 274
- Choosing a Font and Font Size ..... 275
- Setting the Style Options ..... 276
- Entering and Positioning Text ..... 277
- Basic Text Editing ..... 277

**Working with the Paintbrush Tools .....278**

- The Cutout Tools ..... 279
- The Airbrush ..... 281
- The Text Tool ..... 282

The Color Eraser .....	282
The Eraser .....	284
The Paint Roller .....	285
The Brush .....	286
The Curve .....	288
The Line .....	290
The Box and the Filled Box .....	291
The Rounded Box and the Filled Rounded Box .....	292
The Circle/Ellipse and the Filled Circle/Ellipse .....	293
The Polygon and the Filled Polygon .....	294
<b>Editing Your Drawing .....</b>	<b>296</b>
Using the Erasers .....	296
Cutting and Pasting Cutouts .....	296
Moving a Cutout .....	296
Sweeping a Cutout .....	297
Copying a Cutout .....	298
Moving, Sweeping, and Copying a Cutout in Zoom-Out Mode ..	299
Transparent and Opaque Pasting and Sweeping .....	299
Saving a Cutout .....	300
Retrieving a Cutout from Disk .....	300
<b>Advanced Paintbrush Features .....</b>	<b>301</b>
Shrinking and Enlarging a Cutout .....	301
Flipping a Cutout .....	302
Inverting Colors in a Cutout .....	302
Tilting a Cutout .....	303
Working with Detail .....	304
Editing with Zoom In .....	305
Creating Custom Colors .....	306
<b>Working with Paintbrush Files .....</b>	<b>307</b>
Converting Microsoft Paint Files .....	308

<b>Printing a Drawing</b> .....	<b>309</b>
Printing Part of a Drawing .....	310
Setting Margins .....	311
Printing Headers and Footers .....	311
Changing the Printer .....	311



## ***Drawing with a Mouse or the Keyboard***

With Microsoft Windows Paintbrush™, you can create simple or elaborate color drawings. Unlike the other Windows accessories, Paintbrush makes use of both mouse buttons. When you need to use the right mouse button, the instructions in this chapter specify that button. If no button is specified, you should use the left mouse button—the one most commonly used. If you used Control Panel to reverse your mouse buttons, you should use the left mouse button when the instructions specify the right.

In Paintbrush, you will probably find that it is much easier to create your drawings using a mouse. For this reason, the instructions in this chapter are directed toward mouse users. If you do not have a mouse or prefer using the keyboard, use the following keys when the instructions tell you to click, double-click, or press a mouse button:

<u>For this mouse action</u>	<u>Press this key or key combination</u>
Click or press the left mouse button	INSERT
Click or press the right mouse button	DELETE
Double-click the left mouse button	F9 + INSERT
Double-click the right mouse button	F9 + DELETE

See “Moving Around in a Large Drawing” later in this chapter for more information about using the keyboard.

## ***The Paintbrush Window***

### **▷ To start Paintbrush:**

1. Choose the Accessories Group from the Program Manager window.
2. Double-click the Paintbrush icon.  
Or select the Paintbrush icon and choose Open from the File menu.  
The following Paintbrush window appears.

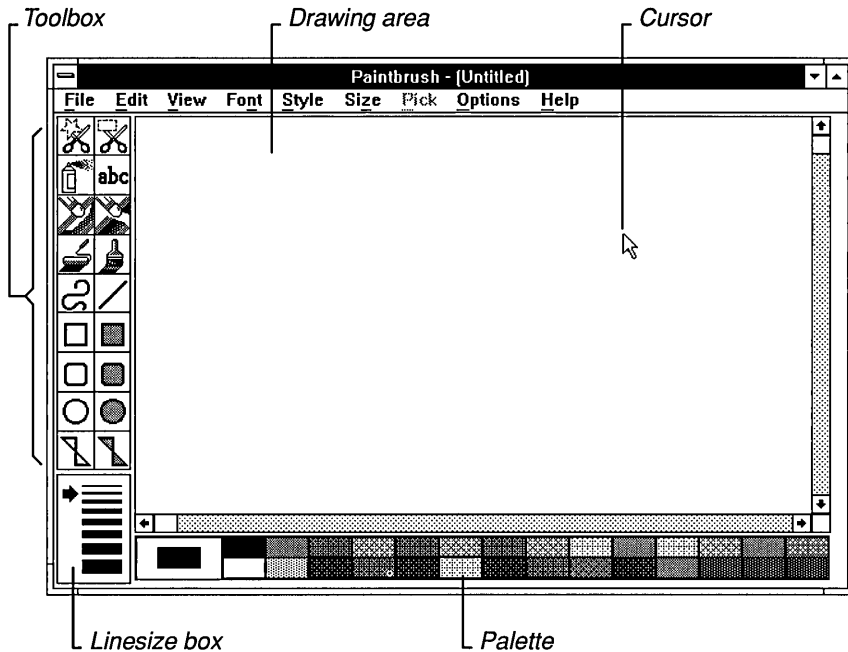

In the Paintbrush window, you see the following items:

- The *drawing area* is where you create your Paintbrush drawings. The size of the drawing area varies, depending on your video display. If you do not have enough memory available to create a drawing equal to the size of your drawing area, you will see a small drawing area in the upper-left corner of the Paintbrush window. You need to free some of your computer's memory before Paintbrush can create the larger drawing area.  
You can also override the default size by using the Image Attributes command from the Options menu. See the following topic, "Determining the Size of Your Drawing Area," for more information.
- The *cursor* indicates where a line or other object appears when you start drawing in the drawing area, or what you are pointing to outside the drawing area. The cursor moves as you move your mouse (or press TAB or a DIRECTION key). Inside the drawing area, the cursor's shape changes, depending on which tool you are using. Outside the drawing area, the cursor always appears as an arrow.
- The *Toolbox* contains the tools that you use to create your drawing. The tools allow you to draw, fill, airbrush, erase, enter text, and rearrange the items in the drawing area.

- The *Palette* contains the colors and patterns available for use in the background of the drawing area and with the drawing tools.
- The *Linesize box* contains the available drawing widths.

**HINT** If you are using the keyboard, use TAB and SHIFT+TAB to move between the different areas of the Paintbrush window.

## Determining the Size of Your Drawing Area

The first time you start Paintbrush, it establishes a standard size for a drawing area based on your type of video display and the amount of memory available. If you want to create a drawing that is larger or smaller than the standard size established by Paintbrush, you can change the standard drawing size.

### ▶ To change the standard drawing size:

1. Choose Image Attributes from the Options menu.  
The Image Attributes dialog box appears.

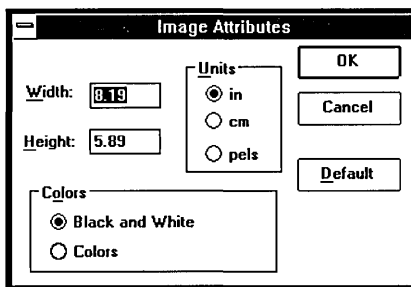

2. Enter the new width and height measurements you want to use for your drawing.  
If necessary, make changes to the other options in the dialog box. See the list that follows for an explanation of each of the options.
3. Choose OK.
4. Choose New from the File menu to open a new drawing using the new standard size.



Paintbrush now uses the new settings in the Image Attributes dialog box each time you start Paintbrush.

**HINT** To start a new Paintbrush drawing quickly, double-click the Eraser tool in the Toolbox. (If you are using the keyboard, move the cursor to the Eraser tool; then press F9 + INSERT.) For more information about using the Eraser tool, see “The Eraser” later in this chapter.

The following list explains how to use the settings in the Image Attributes dialog box:

<u>Use this option</u>	<u>To do this</u>
Width	Change the width of the drawing you want to create.
Height	Change the height of the drawing you want to create.
Units	Select the unit of measurement you want to use when you enter the width and height of your drawing. The standard setting is inches (in). You can also choose to work with centimeters (cm) or picture elements (pels, also known as pixels)—the smallest unit on the screen.
Colors	Choose whether you want to work in black and white or color.
Default	Return the size of the drawing area to the original size established by Paintbrush to accommodate your video display.

**NOTE** You should keep in mind that the larger the drawing and the more colors you use, the more memory required. If you plan to print your drawing at printer resolution, be sure that you enter the correct dimensions (in pixels) for the printed drawing in the Image Attributes dialog box. Also, be sure that the dimensions you specify are in proportion to the current screen dimensions of the drawing. Because printing at printer resolution requires more memory, you cannot print as large a drawing as you can at screen resolution.

## ***Enlarging the Drawing Area***

You can remove the Toolbox, Linesize box, and Palette from the Paintbrush window to increase the size of the drawing area. You can still use the selected tool, drawing width, and color as well as the menu commands when the Toolbox, Linesize box, and Palette are not visible on the screen.

▷ **To remove the Toolbox and Linesize box from the drawing area:**

- Choose Tools and Linesize from the View menu.

The Toolbox and Linesize box disappear from the Paintbrush window, and the checkmarks next to Tools and Linesize on the View menu also disappear. To return the Toolbox and Linesize box to the window, choose Tools and Linesize again.

▷ **To remove the Palette from the drawing area:**

- Choose Palette from the View menu.

The Palette disappears from the Paintbrush window, and the checkmark next to Palette on the View menu also disappears. To return the Palette to the window, choose Palette from the View menu again.

## ***Moving Around in a Large Drawing***

If you create a drawing that is larger than the size of the drawing area, you can use the scroll bars to move around in the drawing using a mouse. If you are using the keyboard, the following table shows the keys you can use to move around in the drawing:

<u>Use this key or key combination</u>	<u>To move</u>
HOME	To the top of the drawing area
END	To the bottom of the drawing area
PAGE UP	Up one screen at a time
PAGE DOWN	Down one screen at a time
SHIFT + UP ARROW	Up one line at a time
SHIFT + DOWN ARROW	Down one line at a time
SHIFT + HOME	To the left edge of the drawing area
SHIFT + END	To the right edge of the drawing area
SHIFT + PAGE UP	Left one screen
SHIFT + PAGE DOWN	Right one screen
SHIFT + LEFT ARROW	To the left one space
SHIFT + RIGHT ARROW	To the right one space

## ***Viewing Your Drawing***

To see more of your drawing, you can remove everything from the screen except your drawing. You can also compact your drawing so that all of it fits inside the current drawing area.

### ***Showing the Entire Screen***

The View Picture command on the View menu displays as much of your drawing as fits on the entire screen by removing everything but your drawing from the screen. Because the menus, Toolbox, Palette, Linesize box, and even the cursor disappear when you choose View Picture, you cannot edit your drawing in any way.

#### **▷ To use the entire screen to display your drawing:**

- ❑ Choose View Picture from the View menu.

***HINT*** To clear the entire screen quickly of everything except your drawing, double-click the Pick cutout tool in the Toolbox. (To choose the Pick cutout tool using the keyboard, move the cursor to the Pick cutout tool; then press F9 + INSERT.)

#### **▷ To cancel the View Picture command:**

- ❑ Click the mouse button.  
Or press ESC.

The screen returns to its normal state.

### ***Zooming Out***

If you create a drawing that is larger than the drawing area and the entire screen, it is still possible to see all of the drawing on the screen at one time.

#### **▷ To display an entire drawing that is larger than the drawing area:**

- ❑ Choose Zoom Out from the View menu.  
Zoom Out shrinks the entire drawing to fit into the drawing area.

While using Zoom Out, you can cut, copy, and paste parts of your drawing called *cutouts*. You create a cutout using either the Pick or Scissors cutout tool (see

“Editing Your Drawing” later in this chapter for more information). You cannot, however, add anything new to a drawing in Zoom Out by using the drawing tools.

▷ **To cancel the Zoom Out command:**

- Choose Zoom In from the View menu.

Or press ESC.

The drawing returns to normal resolution size.

When you use Zoom Out to view a drawing, you might lose some of the line detail in the drawing. Generally, the larger the size of your original, the greater the amount of line detail that you lose when Paintbrush shrinks the drawing. You see this loss of detail only in the compacted version of the drawing. It does not affect your full-size drawing.

## ***Creating a Simple Drawing***

To create a simple drawing:

1. Select a background color.
2. Select a foreground color.
3. Select a drawing width.
4. Select a drawing tool.
5. Draw your picture.
6. Edit your picture.

The following topics describe each of these steps.

## ***Selecting Background and Foreground Colors***

One of the first things to decide when you create a drawing is what color you want to use for the background and what color you want to start drawing with (the foreground color). You select your background and foreground colors from the Palette.

You can change the foreground color at any time while creating a drawing. You can also change the background color at any time and, by doing so, create special effects with tools and commands that use the background color to draw. For

example, you can create shadows around different pieces of text in a drawing using various colors.

You can change the background color used throughout an entire drawing only by choosing the color and then choosing New to start a new drawing.

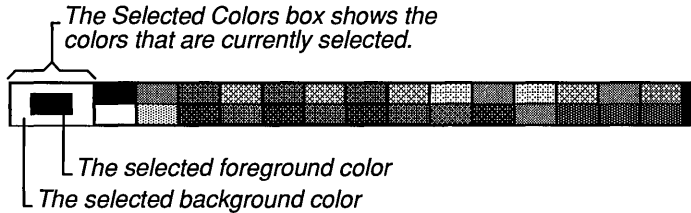

When you start Paintbrush, the selected background color is white and the selected foreground color is black.

▷ **To select a different background color or pattern:**

---

- Point to the color or pattern in the Palette and click the right mouse button.  
Or press TAB to reach the Palette and then use the DIRECTION keys to move the cursor to the color and press DELETE.  
The Selected Colors box shows the color you selected.

If you now choose New from the File menu, Paintbrush opens a new document with the newly selected background color or pattern in the drawing area.

▷ **To select a different foreground color or pattern:**

---

- Point to the color or pattern in the Palette and click the left mouse button.  
Or press TAB to reach the Palette and then use the DIRECTION keys to move the cursor to the color and press INSERT.  
The Selected Colors box shows the color you selected.

## ***Selecting a Drawing Width***

The Linesize box in the lower-left corner of the Paintbrush window displays the available drawing widths. The top line represents a one-pixel width.

An arrow marks  
the selected width.



The drawing width determines the width of an object you draw or the thickness of the border around the object. For example, if you are drawing a line, the drawing width determines the width of the line. If you are drawing a filled box, the drawing width determines the thickness of the border around the box. You might want to experiment with how different drawing widths work with different tools so that you can use them most effectively.

### ▷ To change the width of the drawing line:

- Point to the width you want in the Linesize box and click the mouse button.  
Or press TAB to reach the Palette and then use the DIRECTION keys to move the cursor to the drawing width you want to select and press INSERT.  
An arrow appears next to the drawing width you selected.

## Selecting and Using a Drawing Tool

Before you begin working in the drawing area, you need to select the tool you want to work with from the Toolbox at the left of the Paintbrush window.



The Brush tool is always selected  
when you start Paintbrush.

▷ To select a drawing tool:

- Point to the tool you want to use and click the mouse button.  
Or use the DIRECTION keys to move the cursor to the tool you want to select and press INSERT.  
Paintbrush highlights the selected tool in the Toolbox.

▷ To draw with the selected tool:

1. Move the cursor into the drawing area.
2. Position the cursor where you want to start drawing and press the mouse button.  
The selected tool anchors itself at that spot.
3. Holding down the mouse button, drag the cursor around the drawing area.  
Or, holding down the INSERT key, use the DIRECTION keys to move the cursor.  
If you are drawing an object such as a box or circle, the object expands and contracts, following the cursor's movements.
4. When you are satisfied with the looks of the object, release the mouse button.

For specific information about each of the available tools, see “Working with the Paintbrush Tools” later in this chapter.

## ***Basic Graphics Editing***

If you make a mistake while drawing, you can use the Undo command on the Edit menu or BACKSPACE to make simple corrections.

▷ To edit a drawing with the Undo command:

- Choose Undo from the Edit menu.  
Or press ALT + BACKSPACE.  
Undo deletes everything you have drawn since selecting the tool you are currently working with.

Using just BACKSPACE lets you delete a portion or all of what you have drawn since selecting the tool you are currently working with. BACKSPACE is particularly handy for small cleanup jobs such as deleting stray dots made by the Airbrush.

▷ **To edit a drawing with BACKSPACE:**

---

1. Press BACKSPACE.  
The cursor turns into a square with an X inside. The size of the square depends on the drawing width selected.
2. Press the mouse button and move the cursor over the parts of the object you want to delete.
3. When you finish, release the mouse button.
4. Press the mouse button again to continue drawing with the selected tool.

You can use Undo and BACKSPACE until you do any of these things:

- Select a tool.
- Use a scroll bar.
- Open another application.
- Resize the window.

Once you do any of these, Paintbrush pastes down the objects currently in the drawing area, and Undo and BACKSPACE no longer delete. You must now use an eraser tool or select and edit a portion of your drawing called a *cutout*. For more information about erasing and editing cutouts, see “The Color Eraser,” “The Eraser,” and “Editing Your Drawing” later in this chapter.

---

**CAUTION** To prevent undoing work that you are satisfied with, protect that section of your drawing from Undo and BACKSPACE by reselecting the tool you are currently working with or by taking one of the other actions in the previous list. Then Undo and BACKSPACE can delete only your most recent work.

---

## ***Entering Text***

If you want to use text in your drawing, you need to do the following:

1. Select the foreground color you want to use for the text.
2. Select the Text tool from the Toolbox.
3. Choose the font you want to use.
4. Choose a point size for the font.



5. Choose a style for the font.
6. Enter and position your text.
7. Edit your text.

If you do not already know how to select a foreground color, see “Selecting Background and Foreground Colors” earlier in this chapter. The following topics explain the remaining steps.

## ***Selecting the Text Tool***

When you select the Text tool, you can type text in the drawing area.



**The Text tool**

### **▷ To select the Text tool:**

---

- Point to the tool in the Toolbox and click the mouse button.  
Paintbrush highlights the Text tool in the Toolbox.

## Choosing a Font and Font Size

The Font menu lists all available fonts. The Size menu lists a range of point sizes for all the fonts.

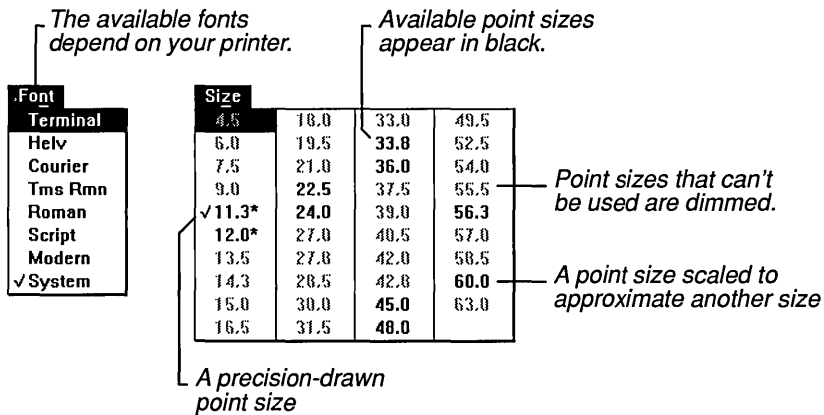

The availability of point sizes depends on the resolution of your printer. If no printer is installed, the available point sizes are based upon the screen resolution of your video display.

### ▷ To choose a font for text:

- Select the name of the font you want to use from the Font menu.

Paintbrush places a checkmark next to the selected font on the Font menu.

The font that you select affects any text that is not pasted down in the drawing area as well as the text that you are about to type. For information about pasting down text, see “Basic Text Editing” later in this chapter.

### ▷ To select a point size for a font:

- Select the point size you want to use from the Size menu.

Paintbrush places a checkmark next to the selected point size on the Size menu.

Point sizes followed by an asterisk are precision-drawn point sizes provided by a font file. Point sizes without an asterisk are point sizes that are scaled by Windows to approximate the designated size.

Windows scales *larger* point sizes when a size that is available for the printer is not available for the screen. Scaled fonts may look slightly different from unscaled fonts. When you choose a *smaller* point size that is available for the printer but not for the screen, Windows substitutes the correct size from a precision-drawn font that resembles the selected font as closely as possible.

## ***Setting the Style Options***

In addition to coming in different sizes, fonts also provide different styles for emphasizing text. You can bold, italicize, underline, and outline the text you type. You can also create a shadow around it in the currently selected background color.

### **▷ To change the style of text:**

- ❑ Select a style you want to use from the Style menu.

Paintbrush places a checkmark next to the selected style on the Style menu.

You can select more than one style for the same text. The styles you select affect text that is not pasted down in the drawing area as well as text that you are about to type. For information about pasting down text, see “Basic Text Editing” later in this chapter.

### **▷ To cancel a style selection:**

- ❑ Select a style from the Style menu again.

The checkmark next to the previously selected style on the Style menu disappears.

### **▷ To cancel all the current style selections:**

- ❑ Choose Normal from the Style menu.

All checkmarks on the Style menu disappear.

## Entering and Positioning Text

Entering text in the Paintbrush drawing area is similar to entering text in a word processing application, except that text does not automatically wrap from line to line in Paintbrush. Also, the cursor does not automatically realign itself with previously entered text if you leave the Text tool and then return.

### ▷ To enter text in the Paintbrush drawing area:

1. Move the cursor to where you want your text to appear and click the mouse button.  
The Text cursor appears as a vertical line.
2. Start typing.  
The text you type starts filling the Paintbrush window at the initial position of the text cursor, while the cursor moves to the right to make room.
3. Press ENTER when you want to start a new line of text, or reposition the Text cursor by clicking the mouse button.  
If you continue typing on the same line, Paintbrush stops entering text when you reach the right edge of the drawing area.

If the size of your drawing is larger than the size of the drawing area, you can use the scroll bars and the appropriate DIRECTION keys to move to other parts of your drawing and enter text there. See “Moving Around in a Large Drawing” earlier in this chapter for more information on using the keyboard to move around in a drawing.

**NOTE** Text can be drawn only in solid colors with Windows—colors in which all pixels are the same color, not a combination of colors. If a non-solid color or a pattern is selected for drawing, text will be drawn in the solid color that is closest to the chosen color or pattern.

For example, if you are using a monochrome monitor and select a light gray as your foreground color, the text characters are drawn in white. If you then change the foreground color to a pattern that is mostly black, the characters are redrawn in black.

## Basic Text Editing

You can correct simple text errors by pressing the BACKSPACE key. BACKSPACE works the same with Paintbrush text as it works in any other Windows application. See Chapter 2, “Basic Skills,” for more information.

You can also select a new foreground color, font, point size, or text style for text in the drawing area. You can use BACKSPACE or make other changes to your text until you do any of these things:

- Select a tool.
- Use a scroll bar.
- Open another application.
- Reposition the text cursor.
- Resize the window.

Once you do any of these, Paintbrush pastes down the text currently in the drawing area. BACKSPACE no longer erases, and you cannot change the color, font, point size, or style of the text. If you want to change or delete the text, you must erase or cut the text out of the drawing and retype it. For more information, see “The Color Eraser,” “The Eraser,” and “Editing Your Drawing” later in this chapter.

## Working with the Paintbrush Tools

The Paintbrush Toolbox appears at the left of the Paintbrush window.

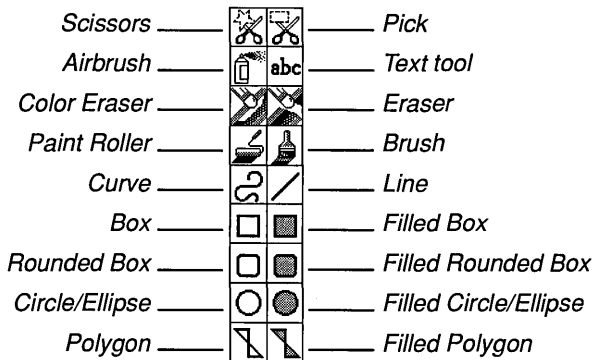

You use the tools in the Paintbrush Toolbox to create your drawings.

▷ To select a tool from the Toolbox:

- Point to the tool and click the mouse button.  
Paintbrush highlights the selected tool in the Toolbox.

The following sections explain the tools in the order that they appear in the Toolbox.

## *The Cutout Tools*

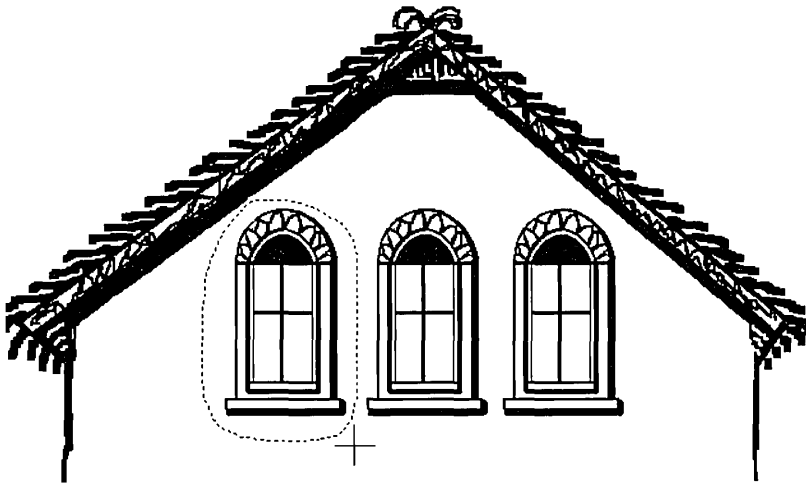

You can define an area of your picture called a *cutout* by using the cutout tools. You can define a free-form cutout with the Scissors tool, or a rectangular or square cutout with the Pick tool. The cutout can be very small or as large as the drawing area.

Define a free-form cutout when you want the cutout area to closely follow the contours of an object in the drawing.

▷ To define a free-form cutout:

1. Select the Scissors cutout tool at the top *left* of the Toolbox and move the cursor into the drawing area.
2. Press the mouse button to anchor the starting point.

3. Holding down the mouse button, draw a line around the part of your picture you want to define as a cutout.
4. When you have completely circled the area, release the mouse button.  
If you make a mistake, click the right mouse button to start over.

Define a rectangular or square cutout with the Pick tool when the size and shape of the cutout area don't need to conform closely to the object's contours.

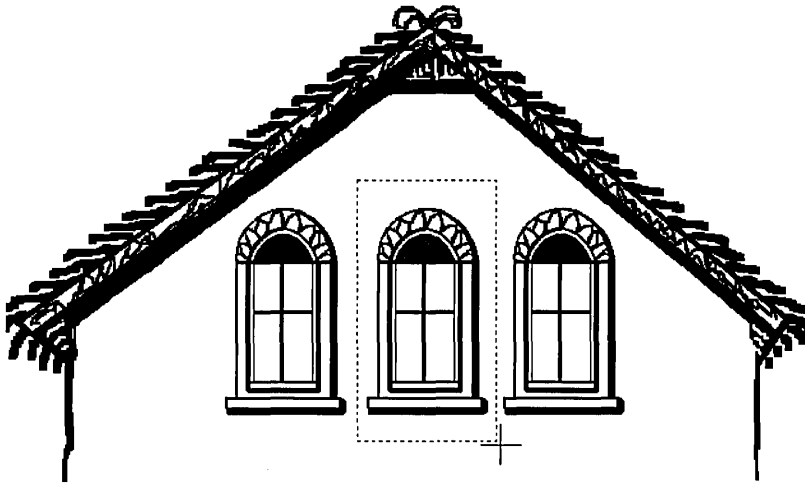

▷ **To define a rectangular or square cutout:**

---

1. Select the Pick cutout tool at the top *right* of the Toolbox and move the cursor into the drawing area.
2. Press the mouse button to anchor one corner of the flexible box.
3. Holding down the mouse button, move the cursor until the box encloses the area you want to define.
4. Release the mouse button.

If you make a mistake, click the right mouse button to start over.

After you define a cutout, you can use commands from the Edit menu to cut, copy, paste, and save the cutout, and commands from the Pick menu to manipulate it in various other ways. For more information about ways of working with cutouts, see “Editing Your Drawing” and “Advanced Paintbrush Features” later in this chapter.

## The Airbrush



The Airbrush tool produces a circular spray of foreground-colored dots.



The Airbrush was used to spray the graffiti on this wall.

### ▷ To use the Airbrush tool:

1. Select the foreground color you want to use.
2. Select the Airbrush tool from the Toolbox and move the cursor into the drawing area.
3. At the location where you want to start the Airbrush spray, press the mouse button and drag the cursor.  
The speed at which you drag the cursor determines the density of the spray.  
The drawing width selected determines the size of the circle of spray.
4. Release the mouse button to stop the spray.

The Airbrush tool is particularly useful for making clouds or for shading “3-D” objects.



## *The Text Tool*



You can add text to your Paintbrush drawings with the Text tool. The text appears in the selected foreground color, font, point size, and font style. For more information about working with the Text tool, see “Entering Text” earlier in this chapter.

## *The Color Eraser*

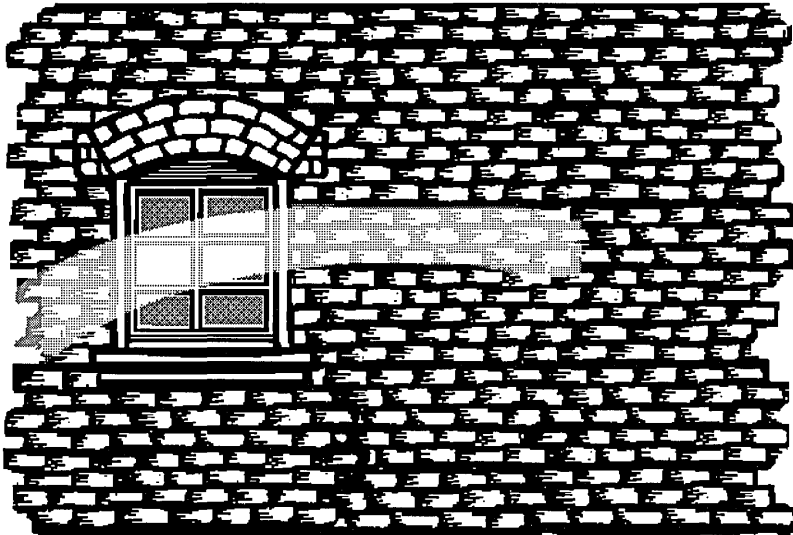

**Use the Color Eraser to change an area of color.**

You can use the Color Eraser in two ways. You can:

- Move the Color Eraser over an area of a drawing, changing the selected foreground color under the eraser to the selected background color.
- Automatically change every occurrence of one color in the drawing area to another color.

▷ **To change a color with the Color Eraser:**

---

1. Select the foreground and background colors you want to use the Color Eraser with. You will use the background color to replace the foreground color.
2. Select the drawing width you want to use.  
The larger the drawing width, the larger the Color Eraser cursor. You can erase small or large areas easily by changing drawing widths.
3. Select the Color Eraser tool from the Toolbox and move the cursor into the drawing area.
4. Press the mouse button and drag the cursor to change any areas of currently selected foreground color under the cursor. (The other colors remain the same.)  
Hold down SHIFT and press the mouse button to make the Color Eraser move in a straight horizontal or vertical line when you drag it.
5. Release the mouse button to stop erasing.

The selected foreground color remains the same in all areas not touched by the Color Eraser.

▷ **To change every occurrence of one color to another color:**

---

1. Make sure that every place that has the colors you want to change is displayed in the drawing area.
2. Select the color you want to change as your foreground color and select the color you want to change to as your background color.
3. Double-click the Color Eraser tool. (Using the keyboard, move the cursor to the Color Eraser tool; then press F9 + INSERT.)  
Every section of the selected foreground color in the drawing area changes to the selected background color.

## The Eraser



The Eraser changes all the foreground color that it touches to the currently selected background color.

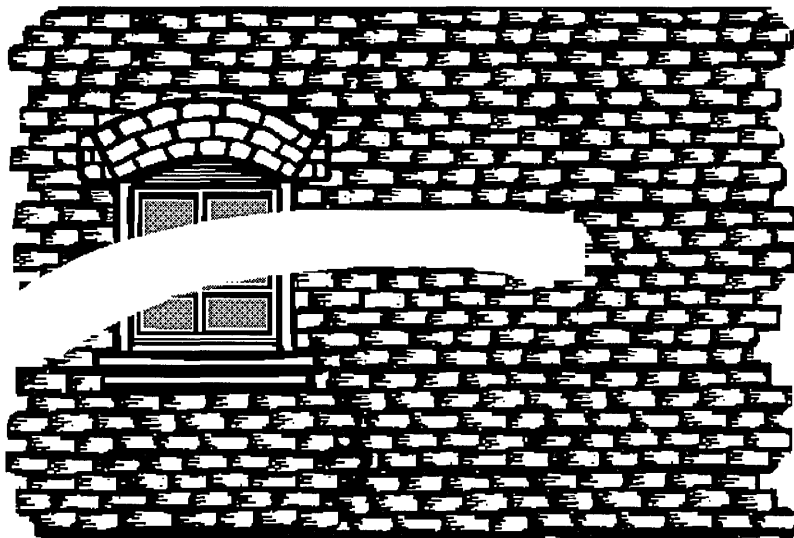

Each spot the Eraser touches changes to the background color.

### ▷ To erase portions of the foreground color with the Eraser:

---

1. Make sure the selected background color is the same as the background color in the area you want to erase.  
If the colors don't match, you will draw with the currently selected background color rather than erase to the original background color.
2. Select the drawing width you want to use from the Linesize box.  
The larger the drawing width, the larger the Eraser cursor. You can erase small or large areas easily by changing drawing widths.
3. Select the Eraser tool from the Toolbox and move the cursor into the drawing area.

4. Press the mouse button and drag the cursor to erase the part of the drawing under the cursor.  
Hold down SHIFT and press the mouse button to make the Eraser move in a straight horizontal or vertical line when you drag it.
5. Release the mouse button to stop erasing.

## The Paint Roller



Using the Paint Roller, you can fill in any closed shape or area with the selected foreground color. You can fill a hollow area enclosed by a border or fill a solid object with a different color or pattern.

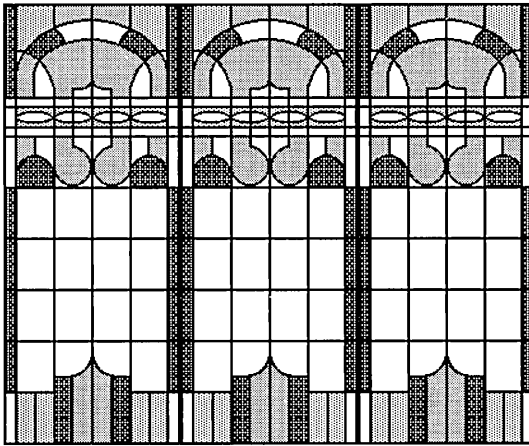

**You can fill in enclosed areas using the Paint Roller.**

### ▷ To fill in a closed area with the Paint Roller:

1. Select the foreground color you want to use in the fill.  
If you fill an object with a pattern rather than a solid color, you will not be able to refill the object. However, you can use the Color Eraser to change the pattern used to fill an object.
2. Select the Paint Roller tool from the Toolbox and move the cursor into the drawing area.

3. Place the cursor inside the area you want to fill and click the mouse button.  
The area fills with the selected foreground color.

If the shape being filled has any breaks in its border, the filling color will leak through and fill the entire drawing area. If this should happen, wait for the color to stop leaking and select Undo from the Edit menu (or press ALT + BACKSPACE) to clean it up. Note that the drawing area itself defines a border, so color fills will stop at the edges of the drawing area.

You can use the Zoom In command from the View menu to close the opening in your object where the color leaked out. See “Editing with Zoom In” later in this chapter for more information.

---

**CAUTION** To prevent undoing work that you are satisfied with, reselect the Paint Roller each time you perform a fill.

---

## The Brush



You can use the Brush tool just like a standard bristle paintbrush to draw freehand shapes and lines in the selected foreground color and drawing width.



A freehand drawing created with the Brush tool

▷ **To draw freehand lines with the Brush tool:**

1. Select the foreground color you want to use.
2. Select the drawing width you want to use.
3. Select the Brush tool from the Toolbox and move the cursor into the drawing area.
4. Press the mouse button and drag the cursor to draw freehand shapes.  
Hold down the SHIFT key as you move the mouse to draw straight horizontal or vertical lines.
5. Release the mouse button to stop drawing.

You can change the shape of the Brush cursor to create different effects as you paint.

▷ **To change the shape of the Brush cursor:**

1. Choose Brush Shapes from the Options menu.  
The Brush Shapes dialog box appears.

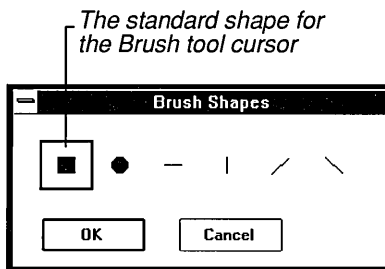

2. Select a cursor shape by clicking it.  
Or use a DIRECTION key to select a shape.
3. Choose OK.  
The Brush Shapes dialog box disappears, and the Brush cursor appears in the drawing area in the selected shape.

**HINT** To open the Brush Shapes dialog box quickly, double-click the Brush tool in the Toolbox.

## The Curve



With the Curve tool, you can draw curved lines in the selected foreground color and drawing width.

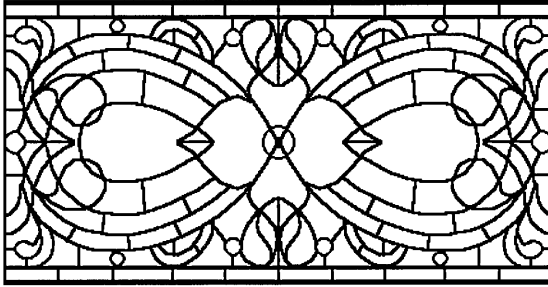

**This stained glass window is made entirely of curved lines.**

### ▷ To draw a curved line:

1. Select the foreground color you want to use.
2. Select the drawing width you want to use.
3. Select the Curve tool from the Toolbox and move the cursor into the drawing area.
4. Press the mouse button to anchor one end of the curve and, while still holding down the button, move the mouse.  
A flexible line stretches from the anchored endpoint to the current cursor position.
5. When the line is the length you want, release the mouse button to anchor the second end of your curve.

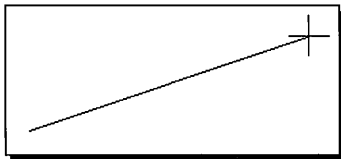

6. Press the mouse button and drag the cursor.  
The line curves in the direction you move the mouse.
7. When you are satisfied with the angle of this first curve, release the mouse button.  
If you want to curve the line in only one direction, click the second end point of the line. Otherwise, go on to the next step.



8. Press the mouse button again and move the cursor away from the first curve to bend your line in the opposite direction.
9. When you are satisfied with the angle of this curve, release the mouse button again.

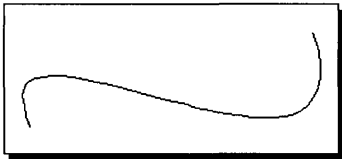

Until you release the left mouse button the second time, you can click the right button to undo the curve and start over again.

When you finish your curved line, Paintbrush colors the curve with the foreground color.



## The Line



You can easily draw straight lines in the selected foreground color and drawing width by using the Line tool.



**A variety of effects created using only straight lines**

### ▷ To draw a straight line:

1. Select the foreground color you want to use.
2. Select the Line tool from the Toolbox and move the cursor into the drawing area.
3. Press the mouse button to anchor one end of the line and, while still holding down the button, move the mouse.  
A flexible line stretches from the anchored end to the cursor position, expanding and contracting as you move the mouse.
4. When you are satisfied with the length and position of the flexible line, release the mouse button to paste the line onto the drawing area.  
If you are not satisfied with the line, click the right mouse button while still pressing the left button to undo the line and start over.

**HINT** To draw a perfectly straight horizontal, vertical, or diagonal line, hold down the SHIFT key as you drag the flexible line.

## The Box and the Filled Box



The Box tool lets you draw hollow squares or rectangles in the selected foreground color and drawing width. The Filled Box tool produces squares and rectangles that are filled with the selected foreground color and bordered by the selected background color.

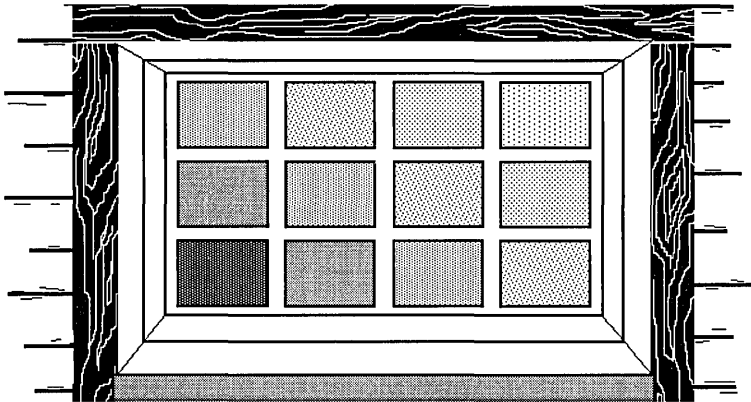

### Boxes and filled boxes

#### ▷ To draw a box or filled box:

1. Select the foreground color you want to use.
2. If you are drawing a filled box, also select a background color for the border.
3. Select the drawing width you want to use.  
If you are drawing a filled box, the drawing width you select determines the thickness of the box's border. If you want a filled box with no border, make the foreground and background colors the same.
4. Select the Box or Filled Box tool from the Toolbox and move the cursor into the drawing area.

5. Press the mouse button where you want to anchor the box and, while still holding down the button, move the mouse.  
A flexible box stretches from the anchor point to the position of the mouse, expanding and contracting as you move the mouse.
6. When you are satisfied with the size of the flexible box, release the mouse button to paste the box on the drawing area.  
Until you release the left mouse button, you can click the right button to undo the box and start over.

**HINT** If you want to draw a square or a filled square, hold down the SHIFT key as you drag your flexible box.

## ***The Rounded Box and the Filled Rounded Box***



The Rounded Box tool works exactly the same as the Box tool, and the Filled Rounded Box tool works exactly the same as the Filled Box tool. The only differences are that rounded and filled rounded boxes have round corners.

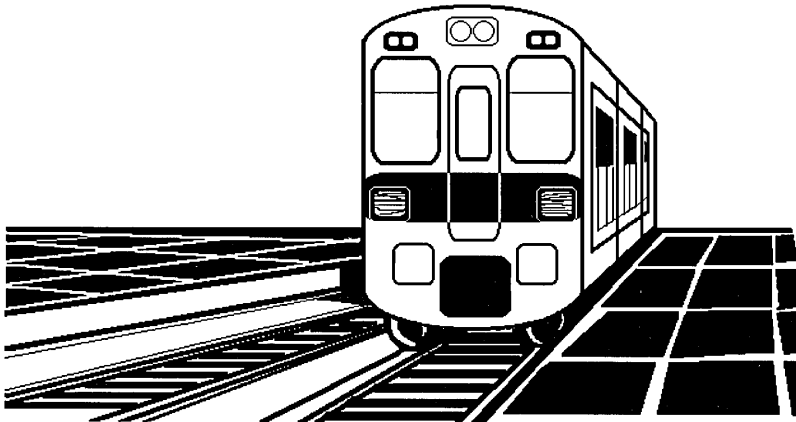

**This streetcar uses rounded and filled rounded boxes.**

To learn how to draw a box or a filled box, see the preceding topic, “The Box and the Filled Box.”

**HINT** If you want to draw a rounded or filled rounded square, hold down the SHIFT key as you drag your flexible rounded box.

## The Circle/Ellipse and the Filled Circle/Ellipse

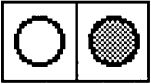

By using the Circle/Ellipse tool, you can draw perfect hollow circles or ellipses in the selected foreground color and drawing width. The Filled Circle/Ellipse tool produces circles and ellipses filled with the selected foreground color and bordered by the selected background color.

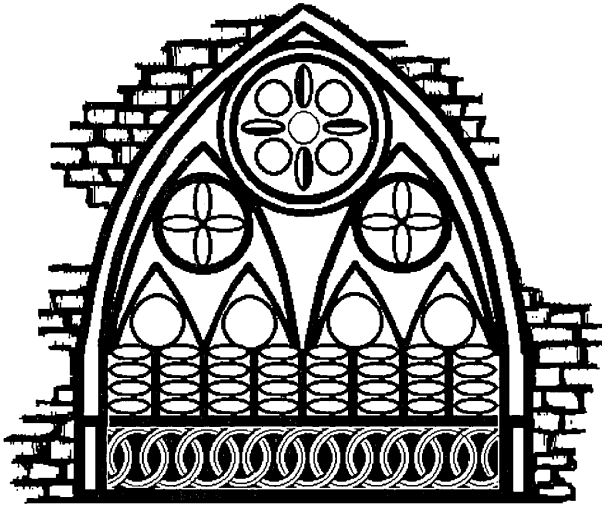

Circles and ellipses – filled and unfilled

### ▷ To draw a hollow or filled circle or ellipse:

1. Select the foreground color you want to use.
2. If you are drawing a filled circle or ellipse, also select a background color for the border.
3. Select the drawing width you want to use.  
If you are drawing a filled circle or ellipse, the drawing width you select determines the thickness of the border around the circle or ellipse. If you want no border, make the foreground and background colors the same.
4. Select the Circle/Ellipse or Filled Circle/Ellipse tool from the Toolbox and move the cursor into the drawing area.

5. Press the mouse button where you want to anchor the circle and, while still holding down the button, move the mouse.  
A flexible circle/ellipse stretches from the anchor point to the position of the cursor, expanding and contracting as you move the mouse.
6. When you are satisfied with the size and shape of the flexible circle/ellipse, release the mouse button to paste it on the drawing area.  
Until you release the left mouse button, you can click the right button to undo the circle/ellipse and start over.

**HINT** If you want to draw a perfect hollow or filled circle, hold down the SHIFT key as you drag your flexible circle.

## The Polygon and the Filled Polygon



Using the Polygon tool, you can draw polygons out of connected straight line segments in the selected foreground color and drawing width. The Filled Polygon tool produces polygons filled with the selected foreground color and bordered by the selected background color.



Polygons and filled polygons

▷ **To draw hollow or filled polygons:**

1. Select the foreground color you want to use.
2. If you are drawing a filled polygon, also select a background color for the border.
3. Select the drawing width you want to use.  
If you are drawing a filled polygon, the drawing width you select determines the thickness of the polygon's border. If you want no border, make the foreground and background colors the same.
4. Select the Polygon or Filled Polygon tool from the Toolbox and move the cursor into the drawing area.
5. Press the mouse button to anchor the starting point of the polygon and, while still holding down the button, move the mouse.  
A flexible line stretches from the anchored starting point to the position of the cursor, expanding and contracting as you move the mouse.
6. When you reach the point where you want the first side of the polygon to end, release the mouse button.  
A line appears from the starting point to the point where you released the mouse button. The end of the first line segment then becomes the starting point for the next segment.
7. Continue adding sides until you are ready to complete your polygon.  
If you become dissatisfied with your polygon, click the right mouse button to undo it and start over.
8. When you are ready to complete your polygon, double-click the mouse button.  
The polygon is automatically closed.

**HINT** To draw straight horizontal, vertical, or diagonal lines, hold down the SHIFT key as you move the mouse.

If you prefer, you can draw the lines for your polygon without dragging flexible lines. Just move the cursor, without pressing the mouse button, to the position where you want the next line to end and click the mouse button. A line appears between the two points. Before you release the mouse button, you can adjust the position of this line.

## ***Editing Your Drawing***

As you are creating a Paintbrush drawing, there are a variety of tools and functions to help you make changes to your drawing. The BACKSPACE key and the Undo command on the Edit menu allow you to delete those parts of a drawing that are not pasted down yet. See “Basic Graphics Editing” and “Basic Text Editing” earlier in this chapter for information about BACKSPACE, Undo, and pasting.

After you paste down part or all of a drawing, you can use the Eraser tool to erase and the Color Eraser tool to change colors. You can also define an area called a cutout and cut, paste, move, sweep, and copy that cutout. You can save a cutout in a disk file and retrieve it to use as part of another drawing. The following sections discuss using the two erasers and working with cutouts. See “The Cutout Tools” earlier in this chapter for information on defining cutouts.

### ***Using the Erasers***

By dragging the Eraser cursor over parts of your drawing, you can remove all the foreground color that the Eraser touches. You can use the Color Eraser to change colors in part or all of your drawing. For more information about using the erasers, see “The Eraser” and “The Color Eraser” earlier in this chapter.

### ***Cutting and Pasting Cutouts***

You can use the Cut and Paste commands on the Edit menu to transfer a defined cutout to and from the Clipboard, just as you transfer selected text to and from the Clipboard in other Windows applications. It is important to remember while cutting and pasting cutouts that you cannot paste a cutout larger than the current drawing area, unless you have zoomed out to display your entire drawing. If you try, Paintbrush pastes only the part of the cutout showing in the drawing area. For more information about using the Clipboard, see Chapter 2, “Basic Skills.”

### ***Moving a Cutout***

After you define a cutout, you can move it anywhere in the drawing area. See “The Cutout Tools” earlier in this chapter for information about defining a cutout.

▷ **To move a cutout:**

1. Move the cursor inside the cutout.
2. Press either mouse button and drag the cutout around in the drawing area.  
If you want to paste the cutout transparently in its new location, use the left mouse button. If you want to paste the cutout opaquely in its new location, use the right mouse button. See “Transparent and Opaque Pasting and Sweeping” later in this chapter for more information.
3. When the cutout is where you want to leave it, release the mouse button.
4. Click the mouse button outside the cutout to permanently paste the cutout in its new position.

## ***Sweeping a Cutout***

When you sweep a cutout, you move the cutout across the drawing area, leaving a trail of copies of the cutout behind.



**Sweeping a cutout to illustrate movement in a drawing**



▷ **To sweep a cutout:**

1. Move the cursor inside the cutout.
2. Press either mouse button and hold down the CTRL key while dragging the cutout across the drawing area.  
If you want to sweep the cutout transparently, use the left mouse button. If you want to sweep the cutout opaquely, use the right mouse button. See “Transparent and Opaque Pasting and Sweeping” later in this chapter for more information.
3. When you finish sweeping the cutout, release the mouse button and the CTRL key.
4. Click either mouse button outside the cutout to permanently paste the cutout in the drawing area.

## ***Copying a Cutout***

When you move a cutout, you can choose to leave a copy of the cutout in its original position.

▷ **To move a cutout and leave a copy behind:**

1. Move the cursor inside the cutout.
2. Press either mouse button and hold down the SHIFT key while you drag the cutout away from the copy.  
If you want to paste the cutout transparently in its new location, use the left mouse button. If you want to paste the cutout opaquely in its new location, use the right mouse button. See “Transparent and Opaque Pasting and Sweeping” later in this chapter for more information.
3. Release the SHIFT key once you have moved the cutout away from the copy.
4. When the cutout is where you want to leave it, release the mouse button.
5. Click either mouse button outside the cutout to paste the cutout permanently in its new position.

## ***Moving, Sweeping, and Copying a Cutout in Zoom-Out Mode***

When you perform a cutout operation in zoom out mode, you can only paste the cutout opaquely. After you choose Paste or Paste From, a box representing the cutout appears in the upper-left corner of the drawing area. You can move the cursor inside the box and drag it to the desired position. To paste it down, click outside the box. You will have to click outside the drawing if you paste a cutout that is as large as the drawing itself.

## ***Transparent and Opaque Pasting and Sweeping***

Whenever you paste or sweep a cutout, you have the option of pasting or sweeping transparently or opaquely. If you paste or sweep transparently, any part of your drawing covered by the cutout shows through. If you paste or sweep opaquely, the entire cutout area covers whatever part of the drawing is underneath it. For example, the following illustrates both transparent and opaque sweeping:

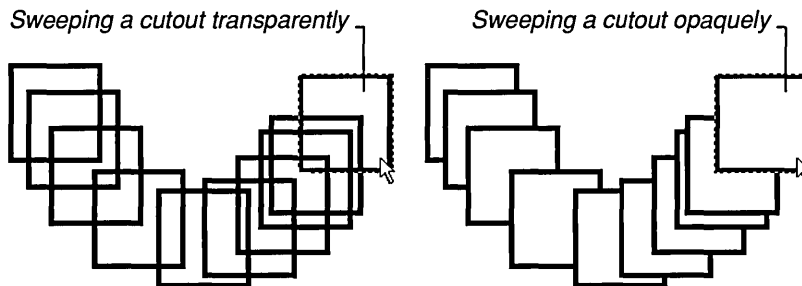

If you want to paste or sweep transparently, the background color for the cutout and the currently selected background color must be the same. Otherwise, the object you paste or sweep won't be transparent.

**HINT** If you want to sweep a cutout opaquely across the screen, you might want to define a freeform cutout. By creating a cutout that closely encircles the object you want to sweep, the shape that you sweep is only the defined object. If you define a rectangular cutout, you get the object inside a box of background color.

## ***Saving a Cutout***

You can save a cutout as a Paintbrush file (.PCX) or as a bitmap file (.BMP). Unless you change the setting in the Save dialog box, Windows automatically assigns the extension .BMP and saves your cutout as a Windows bitmap.

### **▷ To save a cutout:**

1. Choose Copy To from the Edit menu.
2. Type a name for your cutout in the Filename box and choose OK.  
If you want to save your cutout as other than a Windows bitmap file, choose the Options button in the Copy To dialog box and select from the options that appear.

For more information about opening and saving files, see Chapter 2, “Basic Skills.”

If you are concerned about the amount of disk space needed to store a cutout, you can choose the Info button in the Copy To dialog box to see the size of and number of colors in the cutout before you save it. The larger the size of the cutout and the more colors used, the more disk space it requires.

## ***Retrieving a Cutout from Disk***

The Paste From command on the Edit menu retrieves a previously saved cutout from disk and places it in the drawing area. The Paste From command works much like the Open command on the File menu. For more information about opening files, see Chapter 2, “Basic Skills.”

When you paste a previously saved cutout into Paintbrush, the cutout appears in a flexible box in the upper-left corner of the drawing area. (The Pick cutout tool at the top right of the Toolbox is automatically selected.) You need to move the cutout to the location in the drawing area where you want it to appear permanently.

### **▷ To place a cutout where you want it to appear permanently:**

1. Move the cursor inside the flexible box and press the mouse button.
2. Drag the cutout to where you want it to appear in your drawing and release the mouse button.
3. Click the mouse button outside the cutout to paste it on the drawing area.

If you want to see the height, width, number of colors, and number of planes used in the cutout before pasting it, choose the Info button in the Paste From dialog box.

---

**CAUTION** If you paste a previously saved color drawing into a black and white drawing, Paintbrush translates the colors into black and white.

---

## ***Advanced Paintbrush Features***

Paintbrush has a number of other features that allow you to:

- Shrink, enlarge, flip, and tilt defined cutouts.
- Invert colors in a cutout.
- Create drawings containing greater detail.
- Do detailed editing.
- Use custom colors in your drawings.

The following topics explain each of these features.

### ***Shrinking and Enlarging a Cutout***

After you define a cutout, you can use the Shrink + Grow command on the Pick menu to enlarge or shrink the cutout to a different size.

#### ***▷ To change the size of a cutout:***

---

1. Choose Shrink + Grow from the Pick menu.
2. Choose Clear from the Pick menu if you also want the original area to be erased after shrinking or enlarging the cutout.
3. Move the cursor to where you want to anchor the upper-left corner of the flexible box that you use to change the dimensions of your cutout. Then press and hold down the mouse button.
4. Stretch the Shrink + Grow flexible box from the anchored corner by moving the mouse until you are satisfied with the box's dimensions.

To require the dimensions of the flexible box to be in proportion to those of the cutout, hold down the SHIFT key while moving the mouse.

5. When you are satisfied with the dimensions of the flexible box, release the mouse button.  
The cutout shrinks or grows to fit the dimensions of the box.
6. If you are satisfied with the altered cutout, select any tool to paste down your changes and prevent accidentally undoing them.

If you shrink a defined cutout, you can remove what remains of the larger cutout using any of the various ways of editing a drawing.

## ***Flipping a Cutout***

You can use the Flip Horizontally command from the Pick menu to flip a defined cutout from side to side. Flip Vertically, on the same menu, flips a defined cutout from top to bottom.

### **▷ To flip a cutout horizontally or vertically:**

1. Choose Flip Horizontally or Flip Vertically from the Pick menu.  
Paintbrush flips the cutout horizontally or vertically at the current cutout position.
2. Select any tool to paste the cutout on the drawing area.

## ***Inverting Colors in a Cutout***

The Inverse command on the Pick menu allows you to invert the colors in a defined cutout. In a black and white drawing, black becomes white and white becomes black. In a color drawing, a color changes to its complementary color (the color exactly opposite it on the RGB color wheel). For example, blue would become yellow.

▷ **To invert the colors in a cutout:**

1. Choose Inverse from the Pick menu.  
The colors in the cutout are inverted.
2. Click either mouse button outside the cutout to paste the inverted colors on the drawing area.

## ***Tilting a Cutout***

The Tilt command on the Pick menu tilts a defined cutout on an angle that you determine.

▷ **To tilt a cutout:**

1. Choose Tilt from the Pick menu.
2. Choose Clear from the Pick menu if you also want the original area to be erased after tilting the cutout.
3. Move the cursor to where you want to anchor the upper-left corner of the flexible box that you use to determine the angle of tilt. Then press and hold down the mouse button.  
Since you are tilting a copy of your cutout, you can anchor this box anywhere in your drawing.
4. Move the mouse left or right. The bottom of the flexible box shifts with the mouse, tilting the sides of the box and changing the corner angles.  
You can tilt the same cutout as many times as you like.
5. When you are finished creating tilted images, select any tool to paste the tilted cutout on the drawing area.

## Working with Detail

The Cursor Position command on the View menu displays the current cursor position as  $x$ - $y$  coordinates. You can use these width and height coordinates to accurately align text or lines in your drawings. It is particularly helpful when you create charts and tables.

▶ **To use the cursor position coordinates:**

1. Choose Cursor Position from the View menu.

The Cursor Position window appears on the right side of the title bar above the drawing area. You can move it to any position outside the drawing area. See Chapter 2, “Basic Skills,” for information on how to move windows.

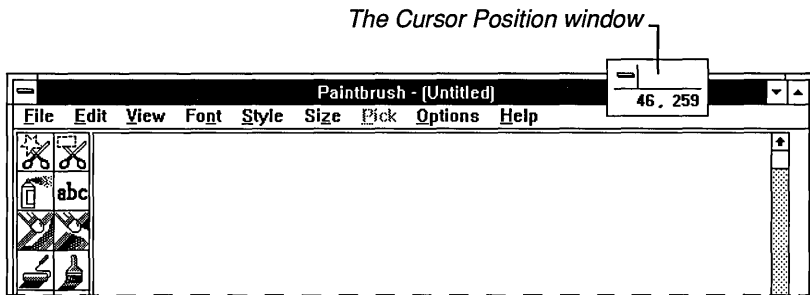

2. Move the cursor around the drawing area.

The coordinates inside the Cursor Position window change to indicate the position of the cursor. The coordinates register only while the cursor is inside the drawing area. If you move the cursor outside the drawing area, the last valid coordinates remain showing in the window until you move back inside the drawing area.

3. When you finish using the coordinates, choose Cursor Position again to remove the window from the screen.

## Editing with Zoom In

The Zoom In command on the View menu lets you magnify a portion of a drawing so you can make changes on a pixel-by-pixel basis.

### ▷ To edit a drawing with Zoom In:

1. Choose Zoom In from the View menu and move the cursor into the drawing area.

The cursor changes to a movable rectangle.

2. Place the rectangle over the area you want to magnify with Zoom In.
3. Click the mouse button, and Paintbrush magnifies the portion of your drawing enclosed by the rectangle.

In the small box that appears in the upper-left corner of the drawing area, you can see how changes you make to the magnified area look at normal resolution.

4. Edit the magnified area in any of the following ways:
  - Click the left mouse button to change a single pixel to the selected foreground color.
  - Click the right mouse button to change a single pixel to the selected background color.
  - Press either mouse button and drag the cursor to change a wide area of pixels.
  - Use the Paint Roller tool to change whole areas of solid color within the magnified area. The Paint Roller works the same with solid colors whether you are working with a full-size drawing or a magnified portion of a drawing. See “The Paint Roller” earlier in this chapter for more information.
5. If you make a mistake, choose Undo from the Edit menu to return to the normal resolution and cancel any changes made to your drawing.
6. When you are satisfied with your changes, choose Zoom Out from the View menu.

**HINT** If you use the Paint Roller tool with a full-size drawing and the paint leaks, Zoom In is very useful for patching the areas where the paint has leaked through.



## Creating Custom Colors

Every color and pattern is made by varying the amount of each of the three primary colors—red, green, and blue—present in the color. This is true even in monochrome (black and white) mode. For instance, white is made by mixing together 255 parts of red, 255 parts of green, and 255 parts of blue. Black, on the other hand, is 0 red, 0 green, and 0 blue.

You can create custom Paintbrush colors and patterns for your drawings by varying the amounts of red, green, and blue (or RGB components) present in the colors provided by Paintbrush. You can change colors and patterns at any time. Changing colors and patterns in mid-drawing does not affect your drawing in any way other than to provide you with more color options.

### ▷ To create a custom color:

1. Select the color you want to modify into a custom color as the foreground color.
2. Choose Edit Colors from the Options menu.  
The Edit Colors dialog box appears.

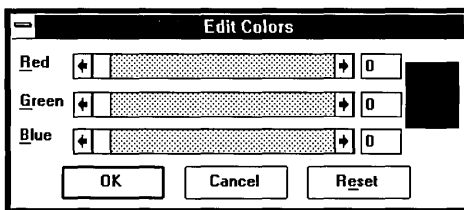

3. Use the scroll boxes inside the scroll bars to increase or decrease the amount of the primary color used, or type in a number from 0 to 255 in the text boxes.  
Imagine that each scroll bar controls the brightness of a red, green, and blue flashlight. Moving the scroll box to the right increases the amount of that RGB component present in the color, lightening it. Moving the scroll box to the left decreases the amount of that RGB component present, darkening the color.  
If you shine the three flashlights on the same point of a piece of paper, the color where the beams of light meet is the composite color, which you see in the large rectangle to the right of the scroll bars.
4. When you are satisfied with your new color, choose OK.

If you are not pleased with your new color, choose Cancel to return to the drawing with the pre-edited color. Or, if you have edited a color several times, you can select Reset to return to the color provided by Paintbrush at the beginning of a session.

When you choose OK, the new color replaces the edited color in the Palette.

**HINT** To move quickly to the Edit Colors dialog box, double-click on the color or pattern that you want to edit in the Palette. (Using the keyboard, move the cursor to the color in the Palette and press F9 + INSERT.)

If you like the new colors and patterns you create, you might want to save them so that they are available the next time you use Paintbrush. Use the Save Colors and Get Colors commands on the Options menu to save or retrieve your color palettes. You save and get custom color files the same way you save and get any other Windows file. Windows automatically assigns the extension .PAL to custom color files. For more information about opening and saving Windows files, see Chapter 2, “Basic Skills.” For more information about working with Windows files, see Chapter 4, “File Manager.”

## ***Working with Paintbrush Files***

You can save your Paintbrush drawings as Paintbrush files or as bitmap files in four formats. Unless you change the setting in the Save As dialog box, Windows automatically saves a *new* drawing as a Windows bitmap file. It saves a drawing that you open and edit in the same format that it was opened in. Except for choosing what kind of a file to save, you save and open Paintbrush files the same way you save and open any other Windows file. For more information about opening and saving files, see Chapter 2, “Basic Skills.”

If you want to save your Paintbrush drawing in other than the default Windows bitmap format for your display, choose the Options button in the Save As dialog box and select from the following options.

- PCX (for Paintbrush files)
- Monochrome bitmap
- 16 Color bitmap
- 256 Color bitmap
- 24-bit bitmap

You should save images in one of the Windows bitmap formats whenever possible, in order to maintain the highest possible level of compatibility across machines and future versions of Windows.

**NOTE** To avoid using up more memory and disk space than is required, you should always use the bitmap format that is closest in size to the number of colors used in the picture.

## ***Converting Microsoft Paint Files***

You can easily convert a Microsoft Paint file to a Paintbrush file. However, you cannot use Paintbrush to work with a Paint file and then resave it as a Paint file.

### **▷ To convert a Microsoft Paint file:**

---

1. Choose Open from the File menu.  
The Open dialog box appears.
2. In the Filename box, type the name of the Paint file followed by the extension .MSP.  
Or, if you do not know the name of the Paint file you want to convert, select the MSP option button from the Open From box, select the directory that contains the .MSP file, and then select the correct file from the Files list box.
3. Choose OK.  
A dialog box appears asking you to confirm that the file should be converted to a Paintbrush file.
4. Choose OK.  
The drawing appears on the screen.
5. Edit the drawing, if you wish.
6. When you are finished working with the drawing, choose Save from the File menu.  
Paintbrush automatically assigns the extension .BMP to the old filename and saves the drawing.

## Printing a Drawing

If you have installed a printer according to the directions in Chapter 5, “Control Panel,” you can print your Paintbrush drawings. When Paintbrush prints a drawing, it preserves the proportions of the drawing, ensuring that objects such as squares and circles do not become rectangles and ellipses on the printed page.

### ► To print the currently displayed drawing:

1. Choose Print from the File menu.

The Print dialog box appears, containing the different print options available.

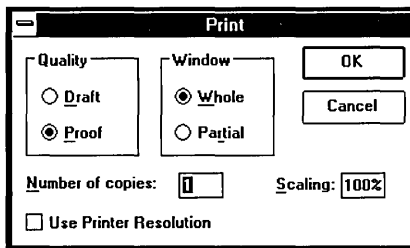

2. Make any necessary changes to the options.

See the following table for explanations of the different options.

3. Choose OK.

If you want to cancel printing, choose Cancel from the dialog box that appears.

The following table explains the different options available in the Print dialog box

#### Use this option

#### To do this

Number of copies

Tell Paintbrush the number of copies that you want to print.

Draft

Produce an un-enhanced copy of your drawing using the fastest speed of your printer. A few printers support only one setting for printing, in which case you will not notice any difference between Draft and Proof.

<u>Use this option</u>	<u>To do this</u>
Proof	Produce a copy of your drawing that makes use of as many of your printer's advanced features as possible. This is the standard setting.
Whole	Print your entire drawing, including those parts not showing in the drawing area. This is the standard setting.
Partial	Print part of your drawing. For more information, see the following section, "Printing Part of a Drawing."
Use Printer Resolution	Print your drawing at printer resolution rather than at screen resolution. Since the dimensions of a pixel on a printer may be different from those for a pixel on a screen, Paintbrush must stretch a drawing to produce the same dimensions on the printed page as you see on the screen.
Scaling	Tell Paintbrush how much to scale the image before sending it to the printer. Scaling by 100 percent implies no scaling.

## ***Printing Part of a Drawing***

When you select the Partial option in the Print dialog box, you must determine which part of your drawing you want to print.

### **▷ To print part of a drawing:**

1. Select Partial from the Print dialog box.  
Paintbrush adjusts the size of your drawing so that the entire image is displayed on the screen, and the cursor becomes a flexible box.
2. Press the mouse button where you want to anchor one corner of the flexible box.
3. Move the box until it contains the portion of the drawing that you want to print.
4. Release the mouse button.

Paintbrush prints the selected portion of the drawing.

## Setting Margins

Paintbrush prints your drawing using the margin settings in the Page Setup dialog box. If you want to position your drawing differently on the page, Paintbrush allows you to adjust the margins.

### ▶ To set the margins you want to use for printing:

1. Choose Page Setup from the File menu.  
The Page Setup dialog box appears.

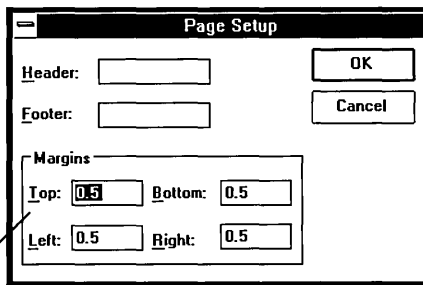

*The standard settings for margins*

2. Type over the standard settings with the margin settings you want to use.  
Paintbrush warns you if your margin settings are too small for the size of your drawing. If your margin settings are larger than the size of your drawing, Paintbrush positions the upper-left corner of the drawing according to the settings in the Top and Left margin boxes.
3. Choose OK.  
When you print, Paintbrush uses the new margin settings in the Page Setup dialog box to position your drawing on the page.

## Printing Headers and Footers

When you print a drawing, you can add explanatory text, the date, a page number, or the filename as a header or footer on the printed page. You can also choose whether you want a header or footer to be left-justified, right-justified, or centered on the page.

▷ **To print a header or footer on a drawing:**

---

1. Choose Page Setup from the File menu.  
The Page Setup dialog box appears.
2. Type the text you want to use as a header or footer in the appropriate box along with any of the codes that can be used in these boxes. See the following table for information about these codes.  
The Header and Footer boxes will scroll as you type in text.
3. Choose OK.

The following table explains the codes that you can type in the Header and Footer boxes:

<u>Type this command</u>	<u>To do this automatically</u>
&d	Enter the current date.
&p	Enter page numbers.
&f	Enter the current filename.
&l	Justify the text that follows at the left margin.
&r	Justify the text that follows at the right margin.
&c	Center the text that follows between left and right margins. This is the default.
&t	Enter the current time.

You can include any or all of these codes in a single header or footer. When you print, any assigned headers or footers appear in their designated places on the printed pages. Headers always appear in the top margin and footers appear in the bottom margin, regardless of how your margins are set.

## Changing the Printer

Paintbrush prints your drawings on the default printer. If you have other printers installed and assigned as active printers, you can make any of these active printers the default printer by using the Printer Setup command on the File menu. If you want to print to an installed printer that is not active, you must use Control Panel to make it active. For more information, see Chapter 5, “Control Panel.”

The printer you change to does not need to be physically connected to your computer. You can change to another printer just to format a drawing for that printer.

### ▷ To change printers:

1. Choose Printer Setup from the File menu.  
The Printer Setup dialog box appears with a list of all the active printers.
2. Select the name of the printer you want to change to from the Printer box.  
If you want to change the print options for the selected printer, choose the Setup button. See Chapter 5, “Control Panel,” for information on print options.
3. Choose OK.

Paintbrush now automatically prints to the newly selected default printer.





---

---

# **Chapter**

# **9**

# **Terminal**

<b>Before Starting</b> .....	<b>317</b>
Hardware Requirements .....	317
Communications Settings of the Remote Computer .....	317
<b>A First Session</b> .....	<b>318</b>
<b>Starting Terminal</b> .....	<b>319</b>
<b>Preparing to Connect</b> .....	<b>320</b>
Opening Terminal Windows .....	320
Entering a Phone Number .....	320
Setting Terminal Emulation .....	322
Specifying Terminal Preferences .....	323
Specifying Communications Settings .....	326
Changing the Modem Command Settings .....	328
<b>Assigning Function Keys</b> .....	<b>330</b>
Showing and Hiding Function Keys .....	333
Timing Sessions with Timer Mode .....	334
<b>Connecting to the Remote Computer</b> .....	<b>334</b>
<b>Transferring Files</b> .....	<b>334</b>
Setting Up File Transfers .....	335
Sending Text Files .....	340

Receiving Text Files .....	341
Viewing Text Files .....	343
Sending Binary Files .....	344
Receiving Binary Files .....	345
<b>Working with Text in the Terminal Window .....</b>	<b>346</b>
Copying Text onto the Clipboard .....	346
Sending the Clipboard Contents .....	347
Sending Selected Text .....	347
Selecting All Text .....	347
Clearing the Buffer .....	348
<b>Printing .....</b>	<b>348</b>
Setting Up the Printer .....	348
Printing Incoming Text .....	349
Printing Selected Text .....	349
<b>Ending Your Communications Session .....</b>	<b>350</b>
Saving Settings Files .....	350
Disconnecting from the Remote Computer .....	350
Exiting Terminal .....	351
<b>If Things Go Wrong .....</b>	<b>351</b>
If the Modem Does Not Dial the Number .....	351
If the Operator Interrupts Your Call .....	351
If the Modem Is Dialing but You Cannot Get Through .....	352
If You Cannot Send or Receive a Text File .....	352
If You Cannot Send or Receive Using the Binary Method .....	353
If Your Incoming Files or Keyboard Entries Are Not Printing .....	353

## ***Before Starting***

This chapter explains how to use Terminal, the Microsoft Windows application that allows you to connect your computer to other computers and exchange information. For example, with Terminal you can hook up to on-line information services, such as Dow Jones News/Retrieval® and CompuServe®, and to on-line bulletin boards. The chapter concludes with a troubleshooting section to help you solve any problems you may encounter in your communications sessions.

The chapter assumes that you are familiar with basic telecommunications concepts and terms, such as *modem*, *baud*, and *protocols*. If exchanging information between computers is new to you, you might want to consult an introductory book on the subject.

Besides the basic hardware requirements for Windows (see “Microsoft Windows 3.0” at the beginning of this manual), you will need additional hardware to make full use of Terminal. You will also need to know the settings required by the remote computer with which you want to communicate.

## ***Hardware Requirements***

You can connect and transfer files to another computer in the same room or to computers in different offices or buildings.

To connect two computers in the same room, you need a special serial cable called a *null modem cable*. Each machine must have its own communications application as well—either Terminal or another application.

To communicate with computers in different locations, you need the following hardware:

- An unused serial port
- A modem and a cable to connect to a serial port

For more information about these components, see your hardware manual or computer dealer.

## ***Communications Settings of the Remote Computer***

You can run Terminal to see what it looks like without knowing the communications settings for the other computer. However, you need this information, in order

to make a connection. To sign on to another computer and transfer data, you need to know that computer's basic settings: baud rate, data bits, stop bits, parity, and flow-control method. If you use an on-line service, such as CompuServe, you can find information about the settings in the introductory package you received when you joined the service.

In addition, you can use Terminal (.TRM) files created with previous versions of Windows without having to change any settings. These files allow Terminal to use the settings you previously specified.

## *A First Session*

Suppose you want to hook up to a remote system that hosts on-line services. You want to read mail and then create, edit, and return a document to a person who also uses the service. Your first communications session might go like this:

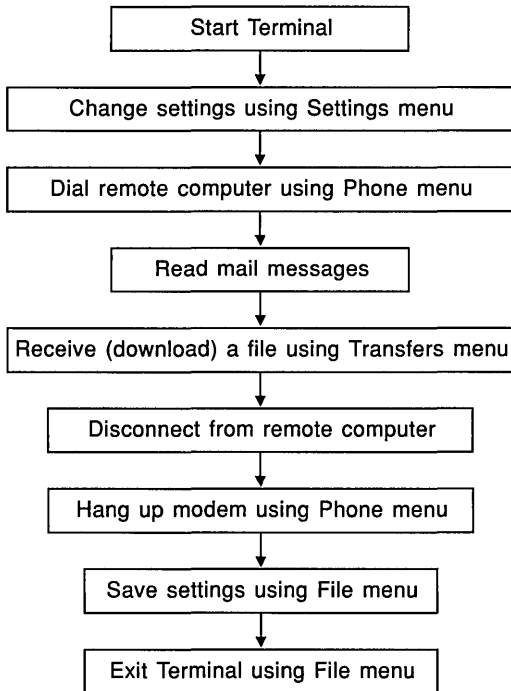

Of course, your actual sessions might differ. Perhaps you will not download files from the remote computer, for example. Or maybe you will use settings specified in a previous session. Choose from the following tasks according to your needs.

## ***Starting Terminal***

### **▷ To start Terminal:**

1. Open the Accessories window.
2. Double-click the Terminal icon.

Or select Terminal and choose Open from the File menu. The following screen appears:

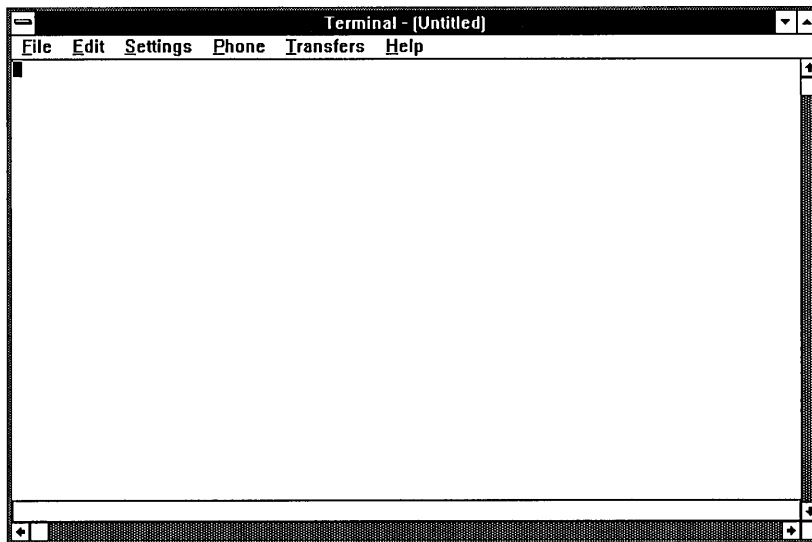

## ***Preparing to Connect***

Each Terminal session requires that you indicate the settings for the remote computer and any other settings you want to specify, or use settings you previously saved in a *settings file*. Settings files are identified by the .TRM extension in the filename. Instructions for opening a .TRM file you have already saved and for specifying new settings follow.

### ***Opening Terminal Windows***

You can use the New and Open commands on the File menu to select a different settings (.TRM) file from the current one.

▷ **To start a new settings file and open a new window:**

- Choose New from the File menu.

You will start with all the standard settings, which you can change to match the remote system to which you want to connect.

▷ **To use a settings file that has already been created and saved:**

1. Choose Open from the File menu.
2. From the displayed list, select the .TRM file you want to use for this session.

### ***Entering a Phone Number***

Terminal dials a phone number to connect to the remote computer when you choose Dial from the Phone menu.

▶ **To enter the phone number you want Terminal to dial:**

1. Choose the Phone Number command from the Settings menu to display the following dialog box:

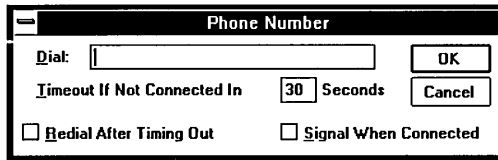

2. In the Dial box, type the phone number that you want the modem to dial.  
You can type parentheses and dashes, but they are not required. Type commas to provide any delays needed for the number to be processed by the telephone system. Each comma inserts a delay of approximately 2 seconds. The following string first dials a 9, then pauses for 4 seconds before dialing the 10-digit number shown:  
9,,1-800-555-1212
3. Set the options you want and then choose OK.

Explanations of these options follow:

**Use this option**

Timeout If Not Connected in  
30 Seconds

Redial After Timing Out

Signal When Connected

**To do this**

Increase the number of seconds you want Terminal to wait for a connect signal from the remote computer (30 seconds is the minimum waiting time). When one modem calls another, the originating modem waits for high-pitched answer tones and data signals. If a remote modem is busy with other calls or is being serviced, it may not answer with signals immediately.

Dial the phone number again if a previous attempt did not result in a connection.

Ring the system bell (beep) when a successful connection to the remote computer has been made. If you are likely to step away from the computer, the bell can be a helpful reminder.



If you want to save these settings for a future communications session, you must save them with a Settings file. See “Saving Settings Files” later in this chapter.

## ***Setting Terminal Emulation***

With Terminal, your computer can emulate the terminal type required by the remote computer with which you are exchanging data. You specify the terminal type with the Terminal Emulation command.

### **▷ To specify the terminal emulation type:**

1. Choose Terminal Emulation from the Settings menu to display the following dialog box:

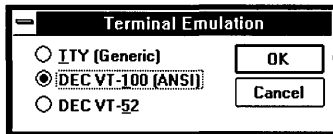

The terminal types shown are the most common ones used by the large, main-frame computers that host on-line services. If you are not sure which terminal to use, select TTY.

2. Select a terminal type and then choose OK.

After you confirm your selection, Terminal adjusts your system so that your computer, keyboard, and terminal perform just as the specified terminal does. If you select TTY, the remote system receives formatting codes for the carriage return, backspace, and tab characters only.

The table in Appendix C, “Terminal Emulation Tables,” describes how the various configurations compare with the behavior of the IBM PC keyboard.

## Specifying Terminal Preferences

You can specify how your terminal performs during a communications session by using the Terminal Preferences command.

### ▶ To specify terminal preferences:

1. Choose Terminal Preferences from the Settings menu to display the following dialog box:

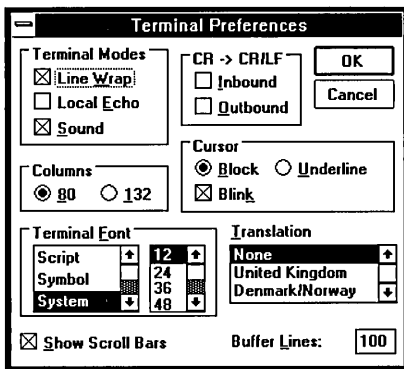

2. Select the options you want and then choose OK. Explanations of these options follow:

#### Use this option

Line Wrap

#### To do this

Automatically wrap incoming characters running past the last specified column to the next line. For example, if the host terminal uses 132-column lines and you have an 80-column terminal, select this option. When Line Wrap is not selected, incoming characters to the right of the specified column width are lost.

<u>Use this option</u>	<u>To do this</u>
Local Echo	<p>Display your keystrokes on your terminal. This option allows you to see the data you are sending to the remote computer as you type it.</p> <p>If the remote system echoes your characters back to you (known as <i>remote echo</i>), do not select Local Echo or you will see duplicated characters on your terminal. If the remote system is not configured for remote echo, select Local Echo to display the outgoing characters as you type them.</p> <p>The remote system may operate in half or full duplex. Half-duplex systems cannot echo your keystrokes to your screen. Full-duplex systems can echo your typing.</p>
Sound	<p>Turn on the system bell (or beep) for the remote computer.</p>
Columns	<p>Specify your monitor type—the common 80-column monitor or the wide 132-column monitor. You can specify 132 if you want an 80-column monitor to behave as if it were a wide monitor, and vice versa. If you specify 132, Terminal will reserve 132 columns for text whether or not 132 columns are entered or received. Therefore, specify 132 only if you must receive text in 132 columns.</p>
Terminal Font	<p>Specify the font to use from the list of currently installed Windows fonts. Both the characters you type and incoming data will appear in the font you choose. After choosing a font, select the display size you want for the font.</p>
Show Scroll Bars	<p>Display the scroll bars. Scroll bars are useful for reviewing information that you have already typed but that has scrolled off the screen.</p>

---

<u>Use this option</u>	<u>To do this</u>
CR to CR/LF	<p>Specify each carriage return as a carriage return plus a linefeed. Linefeeds move text on a printer or monitor down one line, while carriage returns may move the print head or cursor to the left margin (depending on the computer type). When communicating with remote computers, you can specify that a carriage return be interpreted as a carriage return plus a linefeed. Before selecting this option, you will want to know whether the remote computer already sends linefeeds or not.</p> <p>You can select Inbound, Outbound, both, or neither. If you select Inbound, carriage returns in any text coming from the remote computer will be interpreted as carriage returns followed by linefeeds. If you select Outbound, you are assuming that carriage returns you send will be interpreted by the remote computer as carriage returns followed by linefeeds.</p> <p>Whether you select Inbound or Outbound depends on how the remote system handles the end of a line and what it expects from other computers. For example, if it sends carriage returns only, select Inbound to make all incoming carriage returns act like a carriage return followed by a linefeed. If the remote system sends carriage returns followed by linefeeds, do not select Inbound; if you do, each carriage return will be followed by two linefeeds. The same holds true of Outbound; if the remote system expects to get carriage returns and add its own linefeeds, do not select Outbound.</p>
Cursor	<p>Specify whether or not the cursor blinks and what shape it has—Block or Underline.</p>
Translation	<p>Specify a country setting to send and receive data in another language. By selecting a country name, you specify which International Standards Organization (ISO) 7-bit character set to use. Make sure that the host computer recognizes the character set you select.</p>

**Use this option****To do this**

Buffer Lines

Specify how much incoming data is saved in the buffer. You can set the buffer to store from 25 to 400 lines of information. If you type a number that is higher than the available memory, Terminal automatically sets the buffer to the largest number of lines that memory permits. If you type fewer than 25 lines, Terminal reserves 25 lines.

## ***Specifying Communications Settings***

You must specify communications settings before exchanging information with another computer. Check your modem documentation and the remote service package for the correct settings.

▷ **To specify the communications settings:**

1. Choose the Communications command from the Settings menu to display the following dialog box:

The screenshot shows a dialog box titled "Communications". It has a standard window title bar with a close button. Below the title bar are two buttons: "OK" and "Cancel". The dialog is divided into several sections:

- Baud Rate:** A group box containing radio buttons for 110, 300, 600, 1200 (selected), 2400, 4800, 9600, and 19200.
- Data Bits:** A group box containing radio buttons for 4, 5, 6, 7, and 8 (selected).
- Stop Bits:** A group box containing radio buttons for 1 (selected), 1.5, and 2.
- Parity:** A group box containing radio buttons for None (selected), Odd, Even, Mark, and Space.
- Flow Control:** A group box containing radio buttons for Xon/Xoff (selected), Hardware, and None.
- Connector:** A list box showing "None" and "COM1:".
- Parity Check:** A checkbox.
- Carrier Detect:** A checkbox.

2. Select the options appropriate to your system and the remote computer. Then choose OK. Explanations of these options follow:

<u>Use this option</u>	<u>To do this</u>
Baud Rate	<p>Specify the data transfer rate of the two modems. The most common settings are 300, 1200, and 2400 bits per second. Some modems can transmit at more than one baud rate, so check your hardware manual and select a rate that the remote system can handle.</p>
Data Bits	<p>Specify the number of data bits in each data packet sent between the two computers. Most characters are transmitted in 7 or 8 data bits. A few computers require a setting of 4, 5, or 6 data bits, but they are rare.</p>
Parity	<p>Specify the type of parity. If you selected 8 data bits in the previous option, select no parity (None). Mark parity means that the eighth bit is always on (set to 1). Space parity means the eighth bit is always off (set to 0).</p> <p>When Odd is chosen, Terminal adds up the individual data bits used to transmit a character and then adds an eighth bit. If the sum of the bits in the character is even, the system will add a 1 bit to make it odd. If the sum is odd to begin with, Terminal will add a 0 bit to leave it unchanged. Even parity works similarly.</p> <p>When no parity is used to transmit characters in the standard ASCII code set, the eighth bit is still transmitted, but it is ignored by both Terminal and the remote system.</p>
Flow Control	<p>Tell Terminal what to do if the buffer becomes too full to receive more data from the remote system.</p> <p>Xon/Xoff specifies that Terminal pause when the buffer fills. When Terminal is ready for more data, it sends a “go-ahead” signal to the remote computer. This method is known as software handshaking. While it is the standard method for most systems, it cannot be used with a remote system that is configured for hardware handshaking. Select Xon/Xoff if you do not know what type of flow control method is used.</p> <p>Hardware tells Terminal that the remote system uses the hardware method for flow control.</p> <p>None tells Terminal that the remote system uses no method to control the flow of data.</p>

<u>Use this option</u>	<u>To do this</u>
Parity Check	See the byte in which a parity error was encountered. Otherwise, you will see a question mark (?) where the modem detected an error. The question marks will appear at every character that was not transferred correctly.
Carrier Detect	Tell Terminal to use the modem signal for detecting a carrier signal. If your modem still is not connecting after correctly setting the other options, turn off this option to use Terminal's own carrier detection method and try connecting again.
Connector	Select the communications port that your modem uses. If you are using a null modem, select None. Terminal uses COM1 if it is available and then checks COM2, and so forth.
Stop Bits	Specify the time between transmitted characters. Stop bits are not actually bits; they are the timing unit between characters.

## ***Changing the Modem Command Settings***

You can use the Modem Commands command on the Settings menu to specify the settings appropriate for the modem you are using.

When you choose Modem Commands, Terminal displays the commands used for several popular modem types. If your modem is not one of these types, you can enter the appropriate commands for it.

▷ **To change modem command settings:**

1. Choose Modem Commands from the Settings menu to display the following dialog box:

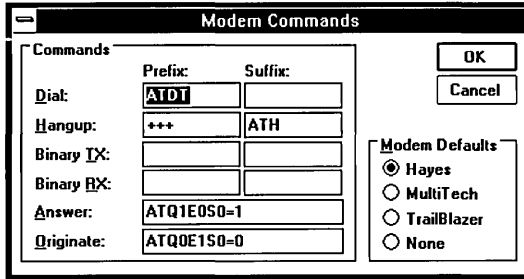

2. Select the modem you are using from the Modem Defaults option. Then choose OK.  
When you select another type of modem, the commands change accordingly. These commands are explained in your hardware manual.
3. If you want to, you can make minor adjustments to the settings by modifying one or more commands in the Commands option. For example, if the Hayes commands are the same ones used by your modem, yet you want to do pulse dialing instead of tone dialing, you would change the Hayes Dial Prefix command from ATDT to ATDP.
4. Choose OK.

If you modify the commands incorrectly, you can reset them to the standard commands by selecting the appropriate modem type again.



## Assigning Function Keys

With function keys, you can automatically execute commands that you would ordinarily have to type. Because Terminal reserves the function keys for other purposes, the function keys you assign must be preceded by the CTRL + ALT key combination.

### ▶ To assign function keys and their commands:

1. Choose Function Keys from the Settings menu to display the following dialog box:

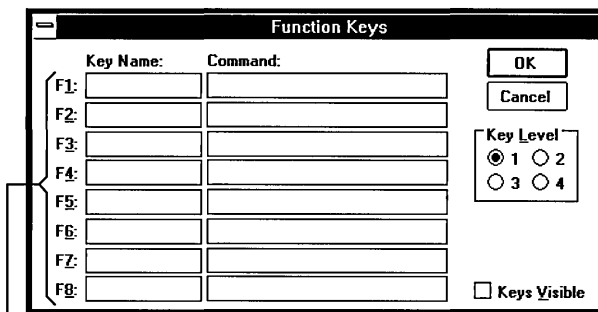

To use these function keys from the keyboard, press CTRL+ALT+ a key from F1 to F8.

In this dialog box, you can define how each function key performs during a Terminal session. You can also rename the key and tell Terminal to display the key choices at the bottom of the Terminal window.

2. Enter a name for each function key you want to specify in the respective Key Name box.  
For example, you could enter *type hello* as the name of a prompt command. Names are optional. However, if you do not name a function key, Terminal won't display it at the bottom of the window.
3. In each corresponding Command box, indicate the function you want each key to perform. Then choose OK.  
For example, you could type *hello* in the Command box that corresponds to the *type hello* key name. Your Terminal window would appear as follows if you displayed function keys as described later in this chapter:

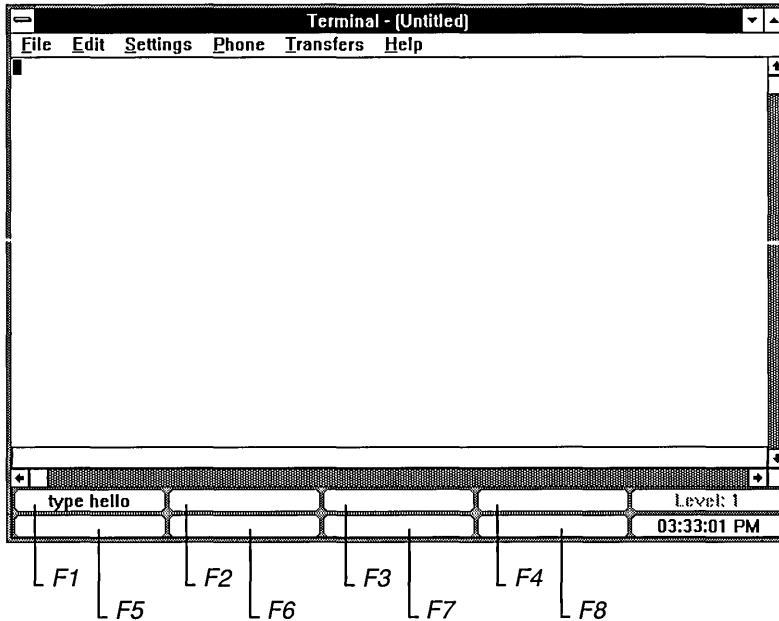

An explanation of each function follows:

<u>Control Code</u>	<u>Function</u>
$\wedge A$ to $\wedge Z$	Sends control code A through control code Z to the remote computer.
$\wedge \$D<NN>$	Causes Terminal to delay for NN seconds before continuing.
$\wedge \$B$	Causes Terminal to transmit a break code of 117 milliseconds in duration.
$\wedge \$C$	Causes the same action as choosing Dial from the Phone menu.
$\wedge \$H$	Causes the same action as choosing Hangup from the Phone menu.
$\wedge \$L1$ to $\wedge \$L4$	Changes to another level of key groups in which keys are defined.

You can assign frequently typed text (strings) to a function key. For example, you can assign a sequence that includes a number, a name, and a password to log on to a remote computer. A sample log-on command sequence might be:

```
^$C^$D03^M^$D02myname^M^$D04password^M
```

where **myname** represents your log-on name or user I.D., and **password** represents your password to the remote computer. These commands would perform the following actions in order:

1. Dial the number that you specified from the Settings menu (^\$C).
2. Wait 3 seconds (^\$D03).
3. Send a carriage return (^M).
4. Wait 2 seconds (^\$D02).
5. Send your log-on name to the remote computer (**myname**).
6. Send a carriage return (^M).
7. Wait 4 seconds (^\$D04).
8. Send your password (**password**).
9. Send a carriage return (^M).

The delays are needed to give the remote computer enough time to respond with prompts. For example, an on-line service would prompt you to enter your log-on name.

You can assign up to 32 function keys in four different levels by using the Key Level box. Assigning function keys to a level allows you to identify up to eight keys in a group. For example, you might want to group the eight function keys that you use most often in Level 1.

▷ To assign function keys to a level:

1. In the Key Level box of the Function Keys dialog box, select 1 for the first key level.
2. Enter up to eight function-key names and commands.
3. Repeat steps 1 and 2 if you want to define another level. You can define up to four levels.
4. Choose OK.

When you start Terminal, it does not automatically display function-key buttons.

▷ To display function-key buttons:

1. Select the check box for the Keys Visible option in the Function Keys dialog box.  
A pad of function-key buttons with their names and key level appears at the bottom of the Terminal window.
2. To remove the display of these buttons, clear the check box for the Keys Visible option.
3. Choose OK.

## ***Showing and Hiding Function Keys***

You can switch the function-key pad display at the bottom of the window on and off as you work.

▷ To display or hide the function keys:

- Choose the Show Function Keys command from the Settings menu. The command changes to Hide Function Keys so that you can remove the display by choosing the command again.

To learn how to specify tasks for function keys, see “Assigning Function Keys” earlier in this chapter.

## ***Timing Sessions with Timer Mode***

When function keys are displayed (with the Show Function Keys command), a box in the lower-right corner of the Terminal window also displays and includes the system time.

When you choose the Timer Mode command from the Settings menu, the timer is set to 00:00:00. Terminal then tracks how long you have been connected to the remote system. That way, you can monitor the length of your hook-up time and avoid charges you did not anticipate.

To see the system time again, click the time display.

### **▷ To time your communications sessions:**

1. Choose Timer Mode from the Settings menu.

When the timer function is active, the Timer Mode command is preceded by a checkmark.

2. To display the system time and reset the timer, turn off the Timer Mode command by choosing it. To simply see the system time without resetting the timer, click the time display.

## ***Connecting to the Remote Computer***

Once you specify the settings for a session or open a Settings file, you can call the remote system. Terminal uses the phone number specified in the Phone Number option on the Settings menu or prompts you to supply the information.

### **▷ To connect to the remote computer:**

- Choose Dial from the Phone menu.

Terminal will begin dialing the number. If you did not specify a number in the Settings menu, the Phone Number dialog box appears. See “Entering a Phone Number” earlier in this chapter.

## ***Transferring Files***

Once you have called another computer and the computers are communicating properly, you can send or receive text or binary files.

## Setting Up File Transfers

Before you send or receive files by using commands on the Transfers menu, you can specify the transfer rules. You should do so only if you plan to send or receive text or binary files. You need not do so if you are simply going to read or send electronic mail.

*Text files* are prepared with a text editor or word processing application (such as Notepad or Write) and saved unformatted. This type of file is known as an ASCII file and contains only the printable ASCII characters and the few control codes needed for minimal formatting, such as carriage returns and linefeeds.

*Binary files* consist of ASCII characters plus the extended-ASCII character set. These files are not converted or translated during the transfer process. If you intend to transfer program files, you must use a binary transfer.

The two methods of transfer—text and binary—differ in a number of ways. In general, it is preferable to send both text and binary files using the binary transfer method because this method checks more rigorously for errors and loss of data. However, if you do not need to send formatting codes and you are not worried about the loss of data, the text transfer method can be faster. Other significant differences between binary and text transfers are summarized in the following list:

### Binary transfers

Automatic retransmission if an error is detected

Suitable for use with any type of file

Protocol (XModem/CRC or Kermit) on each system makes system type irrelevant

Parity is usually not used for error-checking

Transfer of entire file contents only

### Text transfers

Possible suspension of transmission if an error is detected

Suitable for use with ASCII text files only

Lack of protocol makes system specifics important

Parity can be used to detect character transmission errors

Transfer of entire or partial file contents

When communicating with a system that does not recognize either of the binary protocols supported by Windows (XModem/CRC or Kermit), you will need to do a text transfer. Text transfers are intended for use with ASCII text files only.

## ***Preparing to Transfer Text Files***

Text files are ASCII text, with font, style, and size specifications stripped out. Because most applications can work with text alone, this format is useful for transfers between vastly different systems.

### **▷ To prepare for text file transfers:**

1. Choose Text Transfers from the Settings menu to display the following dialog box:

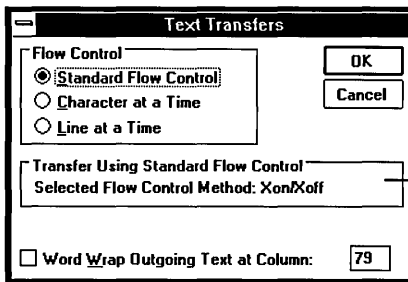

*Specify the flow control method with the Communications command.*

2. Select the options you want to specify and then choose OK. Explanations of the options follow:

#### **Use this option**

#### **To do this**

Standard Flow Control

Use the flow control method you chose with the Communications command. For an explanation of the options, see “Specifying Communications Settings” earlier in this chapter.

Character at a Time

Specify that text files be sent one character at a time. Choosing this option displays the following additional options in the center of the dialog box:

**Use this option****To do this****Delay Between Characters**

Transmits characters evenly and slowly enough to prevent errors. However, no true verification is done on the transmitted data, and no feedback comes from the remote system. You can set the delay by typing a value in the /10 Sec text box.

**Wait for Character Echo**

Sends one character (8 bits) at a time and then waits to echo the character back. Terminal then verifies that the two characters are the same before sending the next character. The transfer continues in this manner until the end of the file is reached. This method is extremely slow and should be used only with a system that echoes characters reliably.

**Line at a Time**

Specify that text be sent one line at a time. If you select this option, the following options appear:

**Delay Between Lines**

Transmits lines evenly and slowly enough to prevent errors. However, no true verification is done on the transmitted data, and no feedback comes from the remote system. You can set the delay by typing a value in the /10 Sec box.

**Wait for Prompt String**

Sends one line and then waits until the remote system sends a string (a message) back to Terminal before sending the next line.

The remote system can assume that this session is occurring interactively and, therefore, sends back “OK. I’m ready for the next line.” at the end of each line. This scenario assumes that you are waiting to see this string in the Terminal window before typing in the next line.

Terminal can also automate this process by allowing you to specify what string of characters it will wait for before sending the next line.



**Use this option****To do this**

Word Wrap  
Outgoing Text  
at Column

^M is the suggested end-of-line code, because if your remote system actually echoes characters instead of sending a prompt string, it will echo the carriage return (^M) at the end of a line. This code indicates that it received the whole line and is ready for the next.

This method is faster than character echo and works better if your remote character echo is unreliable. You can find this out by experimenting or by contacting the administrator of the remote system.

Use this option if the files you want to send were created with a text editor or word processor. You can specify a column up to 132 characters wide, regardless of the size of your terminal. If this option is not chosen, outgoing text will be sent as it is currently formatted. To send a file to a 132-column terminal, enter 131. Reducing the column size by 1 leaves one character space for the end-of-line code (usually ^M).

### ***Preparing to Transfer Binary Files***

Unlike text transfers, which require you to know the settings needed by the remote computer, binary transfers allow you to use standard protocols for data transmission. You must specify the protocol that the remote computer uses. Terminal gives you the choice of two common protocols—XModem/CRC and Kermit—which are explained next.

▷ To prepare for a binary transfer:

1. Choose Binary Transfers from the Settings menu to display the following dialog box:

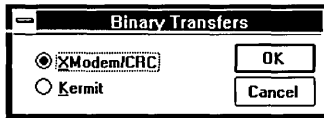

2. Select the protocol you want to use and then choose OK. Explanations of these options follow:

<u>Use this option</u>	<u>To do this</u>
XModem/CRC	<p>Specify the XModem/CRC binary protocol, which uses all 8 bits as data bits and, thus, requires the Parity option to be set to None. (You set parity with the Communications command on the Settings menu.)</p> <p>Terminal initially assumes the cyclic redundancy check (CRC) scheme for error-checking. If the remote system does not support CRC, Terminal automatically uses the checksum scheme.</p>
Kermit	<p>Specify the Kermit protocol, which can use either 7 or 8 bits as data bits; thus, parity can be specified as Even, Odd, or None. Use 8 bits when sending data from the ASCII extended character set (from 128 to 255). Use None for 8-data-bit packets.</p>

## ***Sending Text Files***

If you specified the settings for text transfers using the Settings menu, you are ready to send your file. You can use the Send Text File command on the Transfers menu to send files you have saved in ASCII format (with minimal formatting codes).

### **▷ To send text files:**

1. Choose Send Text File from the Transfers menu to display the following dialog box:

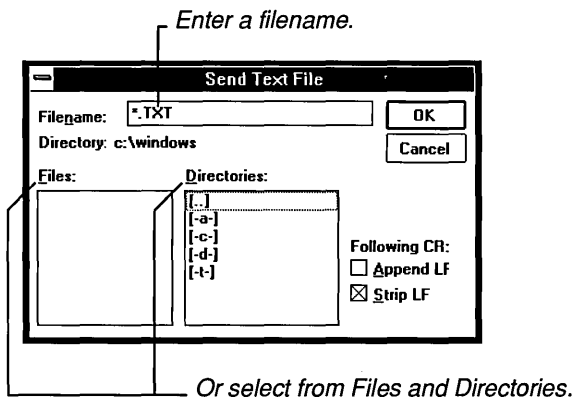

2. In the Filename box, type the name, including the directory path, of the file you want to send, or select a directory and filename from the Directories and Files boxes.
3. To attach a linefeed to the end of each line of the text you send, select Append LF. To strip out linefeeds in the text you send, select Strip LF.

If the remote system adds them to incoming text, you need to strip out linefeeds. For an explanation of linefeeds, see the CR to CR/LF option under “Specifying Terminal Preferences” earlier in this chapter.

4. Choose OK to begin sending the file.  
You will see the file scroll in the Terminal window.

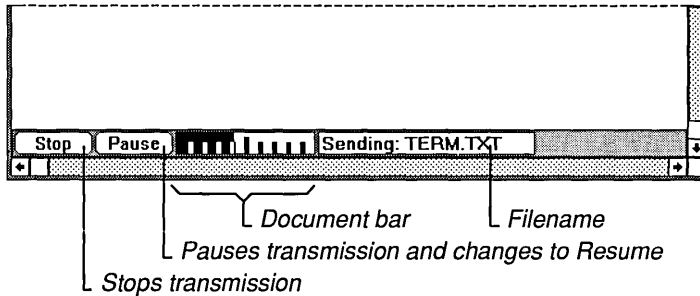

- To pause, resume, or stop the transmission, choose these commands from the Transfers menu or from the control buttons that appear near the bottom of the Terminal window.

## Receiving Text Files

If you specified the settings for text transfers using the Settings menu, you are ready to receive a text file. You can use the Receive Text File command on the Transfers menu to receive a new text file, or to append or overwrite any incoming text file to an already existing file.

### ► To receive a text file:

- Choose Receive Text File from the Transfers menu to display the following dialog box:

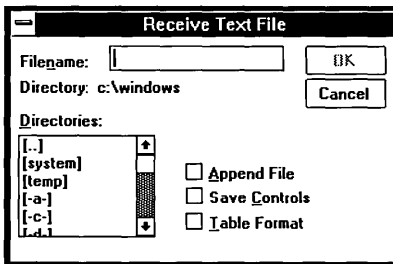

- To receive a new file, type a new filename in the Filename box. Then skip to step 4.

- To append to or overwrite an existing file, select the directory that contains the file and select the filename.

You can also rename an incoming file and assign it to a different directory. To do so, type the directory path and the filename in the Filename box. Alternatively, you could select a directory in the Directories box and type the filename in the Filename box. In this case, you would not choose Append File.

- Select any or all of the boxes at the lower-right corner of the dialog box and choose OK. Descriptions of these options follow this procedure.

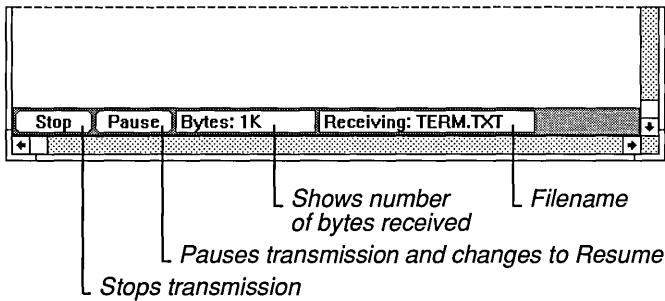

- To pause, resume, or stop the transmission of the incoming file, choose these commands from the Transfers menu or from the control buttons that appear near the bottom of the Terminal window.

<u>Use this option</u>	<u>To do this</u>
Append File	Add incoming information to the end of the specified file instead of overwriting it.  In the Filename box, specify the file you want to append the incoming information to.
Save Controls	Save some of the formatting codes in an incoming text file. Many applications, such as word processing or spreadsheet programs, allow you (or the sender) to save files as text. This means most of the formatting codes are stripped out of the file and it can be sent as a text file. However, the file may retain some formatting codes rather than be saved in pure ASCII form. If you select this option, those formatting codes will be received by your system.

**Use this option****To do this**

Table Format

Receive the incoming text in a tabular format. Terminal will put tab characters between incoming text separated by two or more consecutive spaces.

## Viewing Text Files

If you want to look at a text file before sending it or after receiving it, use the View Text File command.

### ▷ To view a text file:

1. Choose View Text File from the Transfers menu to display the following dialog box:

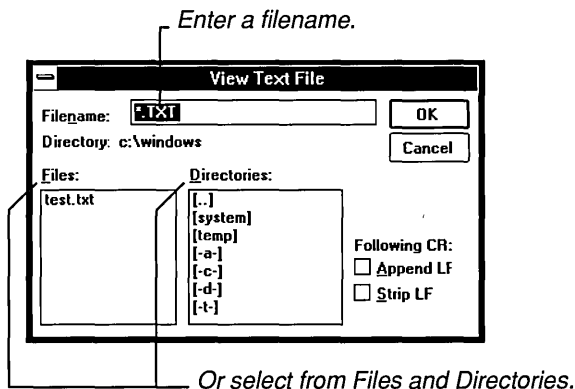

2. Type the name of the file in the Filename box, or select a filename and directory.
3. To attach a linefeed to the end of each line of the text you send, select Append LF. To strip out linefeeds in the text you send, select Strip LF.

If you already specified linefeeds when you received a file, you might want to ignore these options. For an explanation of linefeeds, see the CR to CR/LF option under “Specifying Terminal Preferences” earlier in this chapter.

4. Choose OK to view the specified file.

You will see the file scroll in the Terminal window. The bottom of the window displays buttons the same as when you send a text file.

5. Use the Pause, Resume, and Stop buttons to control the display of the file.

The document bar tells you how much more of the document is yet to be displayed.

## ***Sending Binary Files***

You can use the Send Binary File command on the Transfers menu to send a file in binary format. The file is sent according to the protocol specified with the Binary Transfers command on the Settings menu.

### **▷ To send a binary file:**

1. First, tell the host to prepare to receive a binary file, and indicate the type of protocol to use (XModem/CRC or Kermit).
2. Choose the Send Binary File command from the Transfers menu to display the following dialog box:

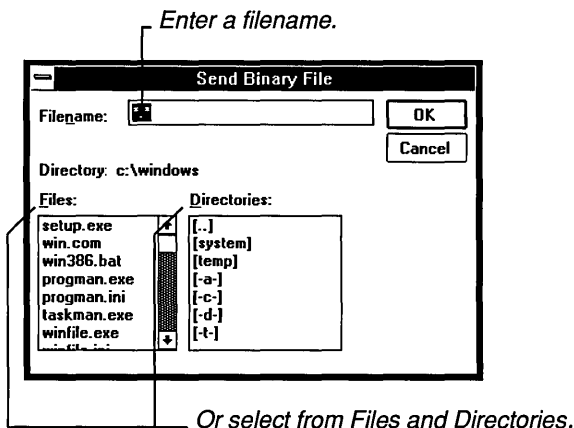

3. Type the name of the binary file you want to send in the Filename box, or select a directory and filename from the Directories and Files boxes.

## 4. Choose OK.

The file transfer begins, and the bottom of the window displays the name of the file being sent and a Stop button.

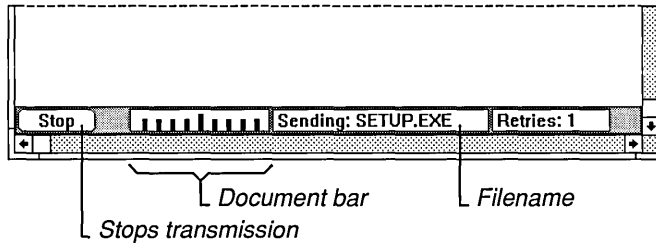

5. To terminate the file transfer, choose Stop. You cannot pause or resume a binary file transfer. Consequently, these buttons and commands are unavailable.

## Receiving Binary Files

The Receive Binary File command on the Transfers menu prepares Terminal to receive a file in binary file format, according to the protocol specified with the Binary Transfers command on the Settings menu.

### ► To receive a binary file:

1. First, tell the host to send a binary file, and indicate the type of protocol to use (XModem/CRC or Kermit).
2. Choose the Receive Binary File command from the Transfers menu.
3. Type the name you want to give the incoming file, including the directory path, in the Filename box.

If you select an existing file from the Files box, Terminal asks for verification that you want to overwrite the existing file.

Occasionally, a communications error prevents the successful transfer of data. When this occurs, the remote system will try again. When the maximum number of retries has been reached, Terminal cancels the file transfer. The Retries box at the bottom of the Terminal window displays the number of times the remote system has tried to send the data. The maximum number of retries for the XModem/CRC protocol is 20. The maximum number of retries for the Kermit protocol is 5.



4. Choose OK.

Terminal displays the name of the binary file being received, the amount of the file already received, and a Stop button.

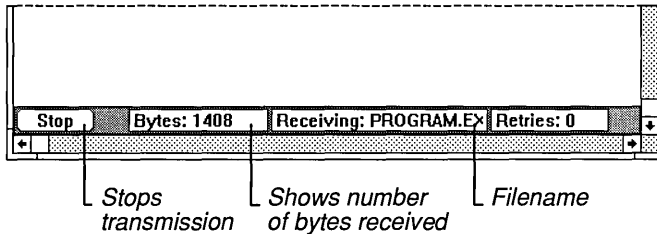

5. To terminate the file transfer, choose Stop.

You cannot pause or resume a binary file transfer. Consequently, those buttons and commands are unavailable.

**NOTE** If Terminal is running as an icon during a binary send or receive, the icon will flash when the transfer is either completed or fails. Restore Terminal to a window to continue your communications session.

## *Working with Text in the Terminal Window*

By using commands on the Edit menu, you can modify the contents of the Terminal window. You can also send, save, append, or print the current selection, or clear the Terminal window. Descriptions of the tasks performed with the Edit menu follow.

### *Copying Text onto the Clipboard*

#### ▷ To copy text onto the Clipboard:

1. Select the text you want to copy.
2. Choose Copy from the Edit menu.

Once a selection is copied, you can then insert it in another position or file using the Paste command.

## ***Sending the Clipboard Contents***

When you *paste* text from the Clipboard, Terminal sends a copy of the Clipboard contents to the remote system. The contents of the Clipboard remain unchanged.

### **▷ To send the contents of the Clipboard to a remote system:**

- Choose Paste from the Edit menu.

The Paste command sends the current contents of the Windows Clipboard.

## ***Sending Selected Text***

Sending text with the Send command is equivalent to choosing the Copy and Paste commands.

### **▷ To send text to a remote system with the Send command:**

1. Select the text you want to send.
2. Choose Send from the Edit menu.

Terminal sends the selected text to the remote system.

## ***Selecting All Text***

Using the Select All command has the same result as selecting the entire contents of the Terminal buffer with the mouse or keyboard. After selecting the text, you can copy or send it.

### **▷ To select all the text in the Terminal window and scroll buffer:**

- Choose Select All from the Edit menu.

## ***Clearing the Buffer***

In some communications applications, text you type beyond a full screen is lost. Terminal, however, displays scroll bars on the window when you type more than a screen of information and puts text that does not appear on the screen into a buffer. This way, you can scroll forward and backward to see text you already typed or received. You might want to clear the buffer to free up memory.

▷ **To clear the contents of the scroll buffer and the window:**

- Choose Clear Buffer from the Edit menu.  
Terminal removes the contents of the Terminal window and any text in the buffer.

## ***Printing***

You can print text (either incoming files or a communications session) in two ways: you can save scroll buffer information in a file and print it from another application such as Write, or you can turn on Printer Echo to have incoming text go directly to a printer as well as to your screen. (To direct your keystrokes to the printer, you must also turn on Local Echo.)

## ***Setting Up the Printer***

If you have connected and installed a printer, you can print text easily. Chapter 5, “Control Panel,” describes how to install a printer. Terminal automatically prints to the designated default printer. If you have several printers connected to your computer and designated as active printers, you can print to one of these printers by selecting it as the default printer. To do so, use the Printer Setup command on the File menu. For more information about active and default printers, see Chapter 5, “Control Panel.”

## ***Printing Incoming Text***

The Printer Echo command on the Settings menu causes Terminal to turn printing mode on and off. When Printer Echo is on, all information received by Terminal is echoed to the printer. If you plan to print incoming text during this communications session, choose this command before you receive information. If Local Echo is turned on, your keystrokes will also go to the printer. See “Specifying Terminal Preferences,” earlier in this chapter, for information on the Local Echo option.

### **▷ To print incoming text and keystrokes:**

1. Choose Printer Echo from the Settings menu.  
When Terminal is in print mode, Printer Echo is preceded by a checkmark. All incoming text is sent directly to the printer.
2. If the incoming text is less than a page long and you want to eject the partial page from the printer, choose Printer Echo again to turn print mode off.

## ***Printing Selected Text***

The best time to print selected text in the Terminal window or scroll buffer is when you are ready to end the communications session.

### **▷ To print text you already received or entered:**

1. Select the text you want to print.  
If you want to select the entire contents of the scroll buffer, choose Select All from the Edit menu.
2. Choose Copy from the Edit menu to place the selected text on the Clipboard.
3. End the Terminal session by choosing Exit from the File menu.
4. Start a word processing or editor program—preferably a Windows-based application such as Write.
5. Paste the contents of the Clipboard into a text file.
6. Use the Print command in the word processing program to print your selection.

## ***Ending Your Communications Session***

To end a communications session, you save the settings file (if you want to use these settings again), disconnect from the remote computer, and exit Terminal. Descriptions of these steps follow.

### ***Saving Settings Files***

You can save Terminal's settings so that you can load them for the next communications session.

▷ **To save the settings file:**

- Choose Save from the File menu.

If you have not saved the settings before, a dialog box asks you for a filename. Terminal automatically assigns the extension .TRM to the file. You can choose Save As to save the settings under a new filename or to overwrite an existing file.

### ***Disconnecting from the Remote Computer***

Disconnecting from the remote computer is an important step in ending your Terminal session.

▷ **To disconnect from the remote computer:**

1. Type the exit command specified by the remote system—typically, *bye*. This command hangs up the remote modem.
2. Choose Hangup from the Phone menu to hang up your modem.

---

**CAUTION** It is important to signal the remote computer with an exit command before choosing Hangup. If you choose Hangup first, you will be disconnected from the remote computer, but its phone connection will remain off the hook. Your account might continue to be charged for connect time until the remote system detects that the connection has been dropped.

---

## ***Exiting Terminal***

You can end a communications session by exiting Terminal and returning to the Program Manager window.

### **▷ To exit Terminal:**

1. Choose Exit from the File menu.
2. If you made changes to the current settings file without saving, Terminal will ask if you want to save the changes, abandon the changes, or cancel your request to exit Terminal.
3. Choose OK.

## ***If Things Go Wrong***

If you have trouble connecting to the remote computer, a number of factors could be causing your problems. The following recommendations cover the most common trouble areas.

### ***If the Modem Does Not Dial the Number***

You might have a hardware connection problem or the baud rate set improperly. Use this checklist to see if you can find the problem:

- Are the correct cables attached to the modem and phone jack, or between the two computers?
- Was the proper COM port specified when you chose the Communications command from the Settings menu? See the Connector option under “Specifying Communications Settings” earlier in this chapter.

### ***If the Operator Interrupts Your Call***

If the modem dials the number but you get a message from the operator, your modem might be misdialing. Use this checklist:

- Is the number correctly entered in the Phone Number option? Choose Phone Number from the Settings menu to check.

- Does your modem run at a slower baud rate?  
You might have to reduce the baud rate so that your modem can interact with the communications port.

If these steps do not work, you might need to have your modem serviced.

## ***If the Modem Is Dialing but You Cannot Get Through***

You might not have the correct settings for the remote computer. Communicating systems must use the same baud rate, although some modems can automatically drop back to the rate of the remote modem and signal Terminal of the change. (Check your hardware manual for this feature.) If you want to transfer data, both systems must also use the same settings for the following options:

- Data bits
- Parity type (none, odd, even, mark, and space)
- Stop bits
- Flow control

If you do not know what settings the remote system is using, refer to its documentation on calling the remote system's information number (not the data transmission number). Request the information and then set Terminal accordingly using the Communications command on the Settings menu.

## ***If You Cannot Send or Receive a Text File***

Communicating systems must use the same handshaking, or flow control, method.

- What software handshaking method, if any, does the remote system use?  
The standard method is Xon/Xoff. However, another method may be used. See "Specifying Communications Settings" earlier in this chapter for more information.
- Does the remote system use hardware handshaking?  
If so, you must select Hardware from the dialog box that appears when you choose the Communications command from the Settings menu. For more information, see "Specifying Communications Settings" earlier in this chapter.

## ***If You Cannot Send or Receive Using the Binary Method***

Communicating systems must use the same transfer protocol. You might have specified a protocol that the remote system does not use.

To change the protocol, choose the Binary Transfers command in the Settings menu. For more information, see “Setting Up File Transfers” earlier in this chapter.

## ***If Your Incoming Files or Keyboard Entries Are Not Printing***

Make sure the printer is properly connected and turned on and that the printer has paper. See Chapter 6, “Print Manager,” for hints on troubleshooting printing problems. If the printer is ready, use this checklist:

- Did you indicate the correct settings using the Printer Setup command on the File menu?
- Did you choose Printer Echo before receiving the file?
- Is the Local Echo option in the Terminal Preferences dialog box selected?  
Local Echo allows your keyboard entries to print.





---

---

**Chapter**  
**10**

***Additional Accessories***

**Calculator .....357**

- Using the Standard Calculator ..... 357
- Performing Calculations ..... 358
- Using Calculator’s Memory ..... 359
- Using Calculator with the Clipboard ..... 359
- Standard Calculator Functions ..... 361
- Using the Scientific Calculator ..... 362
- Working with Different Number Systems ..... 363
- Advanced Calculator Functions ..... 366

**Calendar .....370**

- Calendar’s Different Views of Time ..... 371
- Entering Appointments ..... 372
- Displaying a Different Appointment Day ..... 373
- Using the Month View ..... 375
- Setting an Alarm ..... 375
- Customizing Your Calendar ..... 378
- Managing Calendar Files ..... 382
- Printing Appointments ..... 383

**Cardfile .....386**

- Filling In and Adding Cards ..... 387
- Viewing Cards as a List ..... 388
- Moving Through Your Cards ..... 389

---

Editing Text on Cards .....	391
Restoring a Card .....	393
Deleting a Card .....	394
Duplicating a Card .....	394
Managing Cardfile Files .....	394
Printing a Cardfile File .....	396
Automatic Dialing .....	397
<b>Clock .....</b>	<b>398</b>
<b>Notepad .....</b>	<b>399</b>
Working with Text .....	400
Managing Notepad Files .....	402
Printing a Notepad File .....	404
<b>Recorder .....</b>	<b>405</b>
Recording a Simple Macro .....	405
Playing Back a Macro .....	409
Using the Record Options .....	410
Managing Recorder Files .....	414
Setting Permanent Preferences .....	417
Creating Macros to Use as Demos .....	418
Temporarily Turning Off Recorder .....	419
Guidelines for Creating Macros .....	420
<b>PIF Editor .....</b>	<b>420</b>

# Calculator

The Windows Calculator includes a standard calculator as well as a scientific calculator. The standard calculator allows you to do simple calculations and store them in memory. The scientific calculator allows you to do advanced scientific and statistical calculations.

Both calculators work the same way, so you might want to skim “Using the Standard Calculator,” even if you plan to use only the scientific calculator.

## Using the Standard Calculator

### ▷ To start Calculator:

1. Open the Accessories window.
2. Double-click the Calculator icon.

Or select Calculator and choose Open from the File menu.

If you are starting Calculator for the first time, the standard calculator appears.

*These buttons let you edit the numbers in the display.*

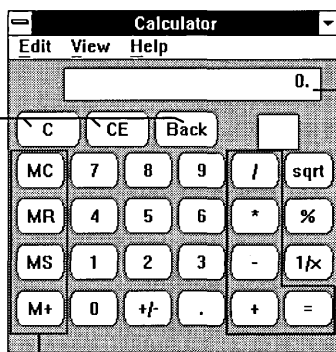

*This is where Calculator displays numbers.*

*These are the basic mathematical operators.*

*These buttons allow you to use Calculator's memory.*

The next time you start Calculator, the last calculator—standard or scientific—that you used appears.

You cannot resize the Calculator window. However, you can reduce Calculator to an icon so that it is readily available when you want to perform calculations.

## ***Performing Calculations***

Calculator is easiest to use with the mouse—just point to a Calculator button and click the mouse button. If you don't have a mouse, each Calculator button has a corresponding key (or combination of keys) on the keyboard. You can find the keyboard equivalent for each Calculator function in “Standard Calculator Functions” or “Advanced Calculator Functions” later in this chapter. For simple calculations, you can use the numbers and basic operators (+, -, \*, /, =) on your keyboard or numeric keypad. (You must press NUM LOCK before you can use the numeric keypad.)

### **▷ To perform a simple calculation using Calculator:**

1. Enter the first number in the calculation.  
The number appears in Calculator's display.
2. Choose the operator you want to use in the calculation.  
If you're not sure which operator to use, see “Standard Calculator Functions” later in this chapter.
3. Enter the next number in the calculation.  
If you make a mistake, choose BACK (or press BACKSPACE) to correct a few digits or choose CE (or press F10) to clear the entire number.
4. Enter any remaining numbers and operators.
5. Choose the equal sign (=).  
Or press EQUALS (=) or ENTER if you are using the keyboard.  
Calculator enters the result in the display.

If you make a mistake and want to restart a calculation, choose C (or press ESC) to clear the entire calculation from Calculator.

## Using Calculator's Memory

Calculator has its own memory, where you can store a value for future use. The following illustration shows the buttons that work with Calculator's memory:

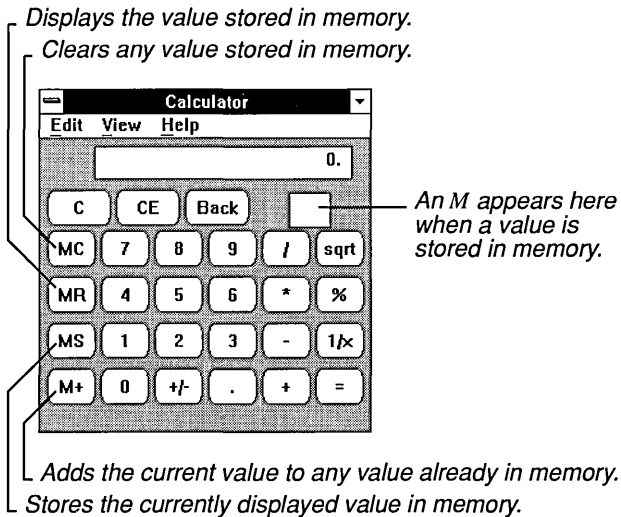

When you store a value in memory, an *M* appears in the box below Calculator's display.

If you store a zero in memory or if a value that you add to memory causes the value there to equal zero, *M* disappears from the box below Calculator's display line. If you store another value in memory with the **MS** button, that value replaces any value currently in memory.

If you don't have a mouse, see "Standard Calculator Functions" later in this chapter to find out how to use the memory functions with the keyboard.

## Using Calculator with the Clipboard

Using the Clipboard, Calculator can supply calculated results to other applications and perform calculations on values supplied by other applications. You can use Calculator with any application with which you can use the Clipboard.

▷ **To copy the value in Calculator's display to the Clipboard:**

- Choose Copy from the Edit menu.

You can now paste the value into any application with which you can use the Clipboard.

▷ **To paste a number from the Clipboard to Calculator's display:**

- Choose Paste from the Edit menu.

Calculator interprets most characters on the Clipboard as if they were entered on the keyboard. When you paste from the Clipboard, however, Calculator interprets some characters as key sequences or function keys. The following describes the meaning of these characters:

<u>Character</u>	<u>Meaning in Pasted Text</u>
c	Clears any value stored in memory. Equivalent to CTRL + C.
e	If in Decimal mode, allows entry of numbers in scientific notation. This character can optionally be followed by a plus (+) or minus (–) to indicate the sign of the exponent. If no sign is present, then + is assumed. If in Hexadecimal mode, specifies the number “E”.
m	Stores the currently displayed value in memory. Equivalent to CTRL + M.
p	Adds the value that is currently displayed to any value in memory. Equivalent to CTRL + P.
q	Clears the current calculation. Equivalent to the ESC key and the C button.
r	Displays the value stored in memory. The value also remains in memory. Equivalent to CTRL + R.

<u>Character</u>	<u>Meaning in Pasted Text</u>
:	If placed before a letter, causes Calculator to interpret the letter as part of a control key sequence. For example, :A is equivalent to CTRL + A.  If placed before a number, causes Calculator to interpret the number as a function key. For example, :4 is equivalent to F4.
\	Same as the Data key, which is normally assigned to the Insert key.

## Standard Calculator Functions

The following table describes each key on the standard calculator, its keyboard equivalent, and its function:

<u>Button</u>	<u>Keystroke</u>	<u>Function</u>
+	+	Adds.
-	-	Subtracts.
*	*	Multiplies.
/	/	Divides.
sqrt	@	Calculates the square root of the currently displayed value.
%	%	Calculates percentages. For example, if you enter 400*75%, Calculator calculates 75% of 400, which is 300.
1/x	r	Calculates the reciprocal of the currently displayed number.
=	= or ENTER	Performs any operation between previous two numbers. Choose again to repeat the last operation. (For example, 4 + 2 = 6. Pressing = again calculates 8; again calculates 10; and so on.)
+/-	F9	Changes the sign of the currently displayed number.
.	. or ,	Inserts a decimal point in the currently displayed number. The decimal point is the standard setting for a decimal separator. You can change the decimal separator setting to enter an international symbol by using Control Panel.
BACK	BACKSPACE LEFT ARROW	Deletes the rightmost digit of the currently displayed number.
CE	DELETE	Clears the currently displayed number.
C	ESC	Clears the current calculation.



Button	Keystroke	Function
MC	CTRL + C	Clears any value stored in memory.
MR	CTRL + R	Displays the value stored in memory. The value also remains in memory.
MS	CTRL + M	Stores the currently displayed value in memory.
M+	CTRL + P	Adds the value that is currently displayed to any value currently in memory.

## Using the Scientific Calculator

The scientific calculator can perform simple, standard mathematical calculations or scientific and statistical calculations. This calculator can also calculate in the binary, octal, and hexadecimal number systems as well as the decimal system that we ordinarily use.

### ▷ To use the scientific calculator:

- Choose Scientific from the View menu.

The scientific calculator appears:

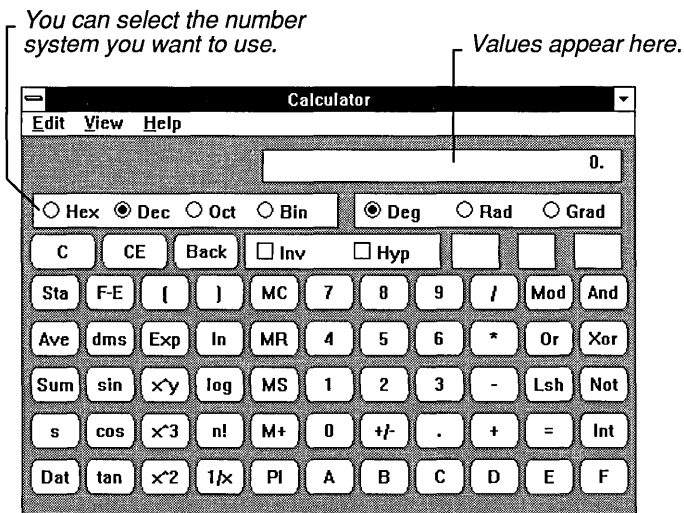

You perform a simple calculation on the scientific calculator the same way you perform a simple calculation on the standard calculator. The instructions appear in “Performing Calculations” earlier in this chapter. The following topics provide information that applies only to the scientific calculator.

## ***Working with Different Number Systems***

When you start the scientific calculator, it is set to work in the decimal number system—the base 10 system that we are accustomed to. This calculator can also work in the binary, octal, and hexadecimal number systems.

When you enter values into the scientific calculator, it accepts only values that are valid for the number system you have selected to work in. For example, if you are working in the hexadecimal number system, B is a valid entry, but if you are working in the decimal number system, B is not.

### ***Converting a Value to Another Number System***

The scientific calculator can convert most values that you are currently working with to any of the other available number systems. The following is a list of the valid ranges for converting numbers:

<u>Number System</u>	<u>Range</u>
Hexadecimal	$-2^{31}-1$ to $2^{31}-1$
Decimal	$-9.999999999999999e-307$ to $9.999999999999999e+307$
Octal	$-2^{31}-1$ to $2^{31}-1$
Binary	$-2^{31}-1$ to $2^{31}-1$

#### **▷ To convert a value to another number system:**

1. Enter the value you want to convert.
2. Select the button for the number system you want to convert to—Hex, Dec, Oct, or Bin.
3. Select the unit of measurement you want Calculator to use to display the result.

When converting to hexadecimal, octal, or binary numbers, you can select Dword, Word, or Byte. See “Advanced Calculator Functions” later in this chapter for more information about these settings.

The value resulting from the conversion appears in the display.

If you convert a decimal number containing decimal places to another number system, Calculator shortens the number to its integer. Numbers converted from the hexadecimal, octal, or binary number systems to the decimal system also appear as integers.

### ***Copying and Pasting in Different Number Systems***

When you use the Copy command on the Edit menu to copy a value from Calculator to the Clipboard, the Clipboard regards the value as a piece of text. It does not distinguish between text and numbers. You can use Copy to transfer a number in any number system from the scientific calculator into another Windows application or accessory.

You can also paste a value in any number system into the scientific calculator from the Clipboard, provided that the number being pasted is in the number system that is currently active.

### ***Using Calculator's Statistical Functions***

In addition to doing simple and programming calculations, the scientific calculator does statistical calculations such as averages and standard deviations.

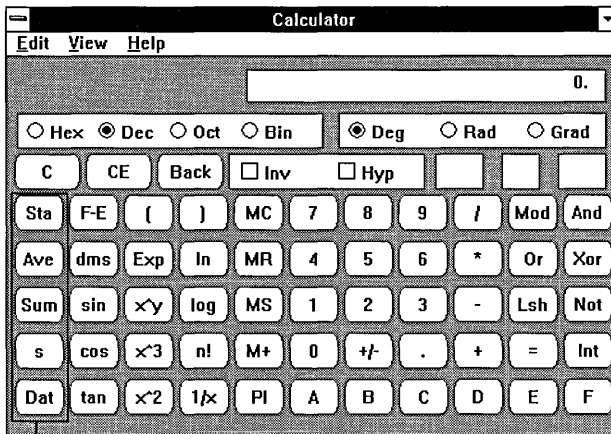

*Use these buttons to perform statistical calculations.*

▷ **To perform a statistical calculation:**

1. Choose Sta.

The Statistics Box appears.

*These buttons assist you in handling data for statistical calculations.*

*The values you enter appear here.*

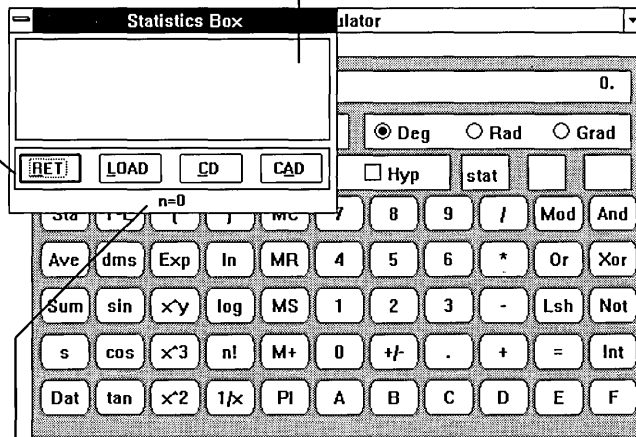

*Indicates the number of values currently entered.*

2. Move the Statistics Box to a position where you can easily work with the numbers and statistical functions you want to use.
3. Enter the first value.

If you are clicking calculator buttons with a mouse, the focus immediately returns to the Calculator, and the value appears in the display area. If you are using the keyboard, choose the RET button in the Statistics Box, and then enter your value.

4. Choose Dat to enter the value in the Statistics Box.
5. Enter any other numbers you want to use, choosing Dat each time to place the number in the Statistics Box.

You can enter as many numbers as your computer's memory allows.

6. Choose the button for the statistical function you want to use in your calculation—Ave (average), Sum (total), or s (standard deviation). See the following section, “Advanced Calculator Functions,” for more information about these functions.

The result of the calculation appears in Calculator’s display.

7. When you complete your statistical calculations, choose Close from the Control menu to remove the Statistics Box.

You can use the Statistics Box buttons in the following ways:

<u>Use this button</u>	<u>To do this</u>
RET	Switch to the main calculator and retain the Statistics Box entries. (To return to the Statistics Box, choose Sta.)
LOAD	Change the number in Calculator’s display to the currently selected number in the Statistics Box.
CD	Delete the currently selected number from the Statistics Box.
CAD	Delete all numbers from the Statistics Box.

## ***Advanced Calculator Functions***

The following tables describe each button specific to the scientific calculator and its functions. They do not describe buttons that also appear on the standard calculator. See “Standard Calculator Functions” earlier in this chapter for descriptions of those buttons. The tables also provide the keyboard equivalent for each function.

## Operators

Button	Keystroke	Function
(	(	Starts a new level of parentheses. The current number of levels appears below the display. The maximum number is 25.
)	)	Closes the current level of parentheses.
And	&	Calculates bitwise AND.
Int	;	Displays the integer portion of a decimal value. Inv + Int displays the fractional portion of a decimal value. For example, if the current value is 47.5, Int displays 47 and Inv + Int displays .5.
Lsh	<	Performs left shift. Inv + Lsh performs right shift. This operation is binary.
Mod	%	Displays the modulus, or remainder, of x/y. For example, 10 Mod 3 displays 1.
Not	~	Calculates bitwise inverse.
Or		Calculates bitwise OR.
Xor	^	Calculates bitwise exclusive OR.

## Number Base Functions

Button	Keystroke	Function
Dword	F2	Displays the full 32-bit representation of the current number.
Word	F3	Displays the lower 16 bits of the current number, but does not change the value.
Byte	F4	Displays the lower 8 bits of the current number, but does not change the value.
Hex	F5	Sets Calculator to work in the hexadecimal number system.
Dec	F6	Sets Calculator to work in the decimal number system. This is the standard setting. Uses Deg, Rad, or Grad in trigonometric functions. Dword, Word, and Byte do not apply here.
Oct	F7	Sets Calculator to work in the octal number system.
Bin	F8	Sets Calculator to work in the binary number system.

## Statistical Functions

Button	Keystroke	Function
Ave	CTRL + A	Calculates the mean of the values currently in the Statistics Box. Inv + Ave calculates the mean of the squares.
Dat	INSERT	Enters the currently displayed number in the Statistics Box.
s	CTRL + D	Calculates standard deviation with the population parameter as $n-1$ . Inv + s calculates standard deviation with the population parameter as $n$ .
Sta	CTRL + S	Activates the Statistics Box and the Ave, Sum, s, and Dat buttons.
Sum	CTRL + T	Calculates the sum (total) of values in the Statistics Box. Inv + Sum calculates the sum of squares.

## Other Functions

Button	Keystroke	Function
cos	o	Calculates the cosine of the currently displayed number. Inv + cos calculates the arc cosine. Hyp + cos calculates the hyperbolic cosine. Inv + hyp + cos calculates the arc hyperbolic cosine.
Deg	F2	Sets trigonometric input for degrees. This function is available in decimal only. (For example, to calculate the cosine of 35 degrees, change to Deg, enter 35, and choose cos.)
dms	m	Converts the currently displayed number to degree-minute-second format (assuming the currently displayed number is in degrees). Inv + dms converts the currently displayed number to degrees (assuming the currently displayed number is in degree-minute-second format).
Exp	x	Allows entry of scientific notation numbers. (For example, to enter the calculation $1.24e + 102$ , enter 1.24, choose Exp, and enter 102.) The exponent has an upper limit of +307. You can continue to enter numbers as long as you do not use keys other than 0-9. Exp can be used only with the decimal number system.
F-E	v	Switches between scientific notation and normal notation. (For example, if the currently displayed number is 1234000.2, F-E returns to 1.2340002e+6. Pressing F-E again calculates 1234000.2.) Calculator always displays numbers larger than $10^{15}$ exponentially. You can use F-E only with the decimal number system.

Button	Keystroke	Function
Grad	F4	Sets trigonometric input for gradients when in decimal mode.
Hyp	h	Sets the hyperbolic function for sin, cos, and tan. The different functions automatically turn off the hyperbolic function after a calculation is completed. (See the individual functions for more information.)
Inv	i	Sets the inverse function for sin, cos, tan, PI, $x^y$ , $x^2$ , $x^3$ , ln, log, Ave, Sum, and s. The different functions automatically turn off the inverse function after a calculation is completed. (See the individual functions for more information.)
ln	n	Calculates natural (base $e$ ) logarithm. Inv + ln calculates $e$ raised to the $x$ th power, where $x$ is the current number.
log	l	Calculates common (base 10) logarithm. Inv + log calculates 10 raised to the $x$ th power.
n!	!	Calculates factorial of the currently displayed number.
PI	p	Displays $\pi$ . Inv + PI displays 6.28 (or $2 * \text{PI}$ ).
Rad	F3	Sets trigonometric input for radians when in decimal mode. (For example, to calculate the cosine of $\text{PI}/2$ radians: turn on Rad. Then choose PI, enter / and 2, and choose cos. Calculator displays 0.41614683654714.) Input can be from $0-2*\text{PI}$ .
sin	s	Calculates the sine of the currently displayed number. Inv + sin calculates the arc sine. Hyp + sin calculates the hyperbolic sine. Inv + hyp + sin calculates the arc hyperbolic sine.
tan	t	Calculates the tangent of the currently displayed number. Inv + tan calculates the arc tangent. Hyp + tan calculates the hyperbolic tangent. Inv + hyp + tan calculates the arc hyperbolic tangent.
$x^y$	y	Computes $x$ raised to the $y$ th power. (For example, to calculate $3.123^{8.82}$ , enter 3.123, choose $x^y$ , enter 8.82, and choose =. Calculator displays 23021.03795695.) Inv + $x^y$ calculates the $y$ th root of $x$ .
$x^2$	@	Squares the currently displayed number. Inv + $x^2$ calculates the square root.
$x^3$	#	Cubes the currently displayed number. Inv + $x^3$ calculates the cube root.



# Calendar

Windows Calendar combines a month-at-a-glance calendar and a daily appointment book.

## ▷ To start Calendar:

1. Open the Accessories window.
2. Double-click the Calendar icon.

Or select Calendar and choose Open from the File menu.

An untitled Calendar window appears, displaying one-hour time intervals for the current date. The first hour that appears at the top of the window is 7:00 a.m.

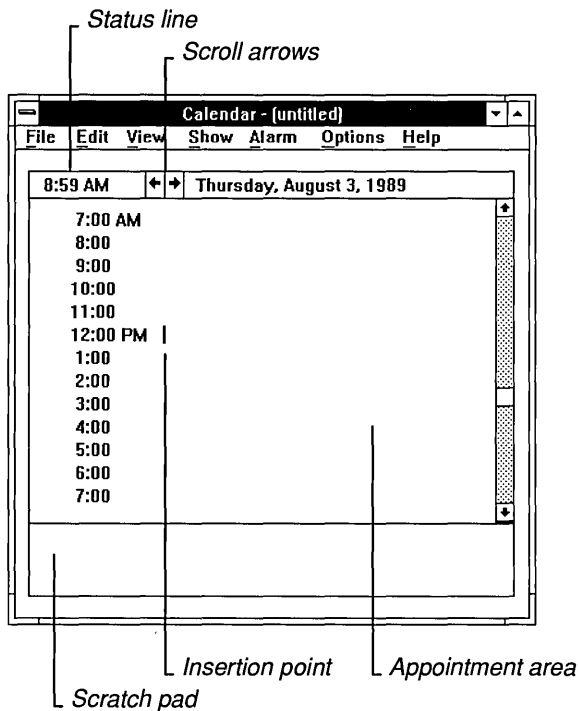

Calendar displays in the status line the system time and date. If the time or date is wrong, you can reset it using Control Panel. For more information, see Chapter 5, “Control Panel.”

## Calendar’s Different Views of Time

Calendar gives you two views of the calendar. When you start Calendar, you see one full day (the Day view). You can change to the Month view to see the whole month at one time.

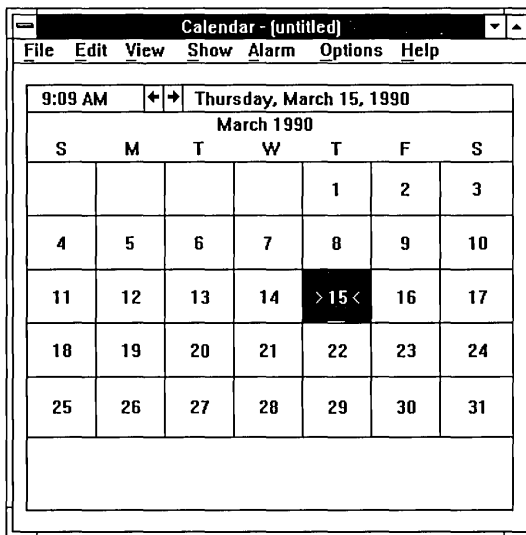

### Calendar’s Month View

#### ► To switch between the Day view and the Month view:

- Choose Month or Day from the View menu.

**HINT** If you have a mouse, you can quickly switch between the Day view and the Month view by double-clicking the date in the status line. You can also change back to the Day view by double-clicking a specific date in the Month view (or by using the DIRECTION keys to move to the date and pressing ENTER).

## ***Entering Appointments***

Entering an appointment involves moving the insertion point to a time in the Day view and typing text that describes the appointment scheduled for that time. You can also set an alarm, if desired, and type notes and reminders in the scratch pad.

The Day view contains a list of times that are initially set at one-hour intervals, beginning with 12 a.m. The insertion point initially appears at 7 a.m. (the starting time).

### **▷ To enter an appointment:**

1. Move the insertion point to the time where you want to enter an appointment.  
If the time is not visible, use the scroll bar or DIRECTION keys to move the time onto the screen.
2. Type the text.  
You can type approximately 80 characters of text describing an appointment. The appointment line scrolls horizontally if you continue typing past the end of the line initially shown in Calendar.

If you are using the keyboard, you can use the keys described in the following list to move the insertion point:

<b><u>Press this</u></b>	<b><u>To move to</u></b>
ENTER	The next time
UP ARROW	The time above
DOWN ARROW	The time below
PAGE UP	The previous screen
PAGE DOWN	The next screen
CTRL + HOME	The starting time (set for 7 a.m. the first time you start Calendar)
CTRL + END	Twelve hours after the starting time

If you want to schedule an appointment for a time not currently displayed, you need to add a special time. For more information, see “Customizing Your Calendar” later in this chapter.

## ***Editing an Appointment***

You can edit the text that describes an appointment in much the same way that you edit text in other Windows applications. For more information, see Chapter 2, “Basic Skills.” When you select Calendar text for editing, however, you can select only one appointment line at a time.

## ***Adding a Note or Reminder***

The daily appointment window has a scratch pad at the bottom in which you can type notes and reminders.

### **▷ To write notes on the scratch pad:**

1. Move the insertion point to the scratch pad.  
Press TAB to move to and from the scratch pad if you are using the keyboard. The insertion point moves to the upper-left corner of the scratch pad.
2. Type your notes and reminders.  
You can type up to three lines of text in the scratch pad. When your text reaches the right border of the scratch pad, Calendar automatically wraps the text to the next line.

## ***Displaying a Different Appointment Day***

You can move to different appointment days by using commands on the Show menu. You can also use this menu to return quickly to the current day’s appointments.

### **▷ To display the previous or next appointment day:**

- Choose Previous or Next from the Show menu.

### **▷ To return to the current appointment day:**

- Choose Today from the Show menu.

The Previous, Next, and Today commands also apply to months when you are using the Month view.

**HINT** To move quickly to the previous day, click the Left scroll arrow in the Calendar status line (or press CTRL + PAGE UP).

To move quickly to the next day, click the Right scroll arrow in the Calendar status line (or press CTRL + PAGE DOWN).

▷ **To change the appointment day to a specific date:**

1. Choose Date from the Show menu.  
Calendar displays the Show Date dialog box.

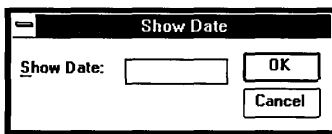

2. Type the date you want Calendar to display in the Show Date box.
3. Choose OK.

You can type any date between January 1, 1980, and December 31, 2099. Type dates in either the mm/dd/yyyy or mm-dd-yyyy format. You do not need to type leading zeros for days or months. If you type a two-digit number for the year, Calendar assumes the 20th century. The following examples show some acceptable date formats:

<u>You can type this</u>	<u>For this date</u>
3/9/90	March 9, 1990
11-17-90	November 17, 1990
1/1/2010	January 1, 2010

## Using the Month View

The Month view lets you see at a glance all the dates in the current month. The current date is highlighted and marked by brackets (for example, >15<).

### ▷ To move to another date in the Month view:

- Point to the date and click the mouse button.  
Or use the DIRECTION keys.

### ▷ To view the previous or next month:

- Choose Previous or Next from the Show menu.

**HINT** To move quickly to the previous month, click the Left scroll arrow in the Calendar status line (or press PAGE UP).

To move quickly to the next month, click the Right scroll arrow in the Calendar status line (or press PAGE DOWN).

### ▷ To move quickly to an appointment day from the Month view:

- Double-click the date in the Month view.  
Or use the DIRECTION keys to move to the date and press ENTER.

## Setting an Alarm

Calendar has an alarm you can set to remind you of appointments. You can set the alarm for as many appointments as you want.

### ▷ To set the alarm for an appointment time:

1. Move the insertion point to the desired time.
2. Choose Set from the Alarm menu.

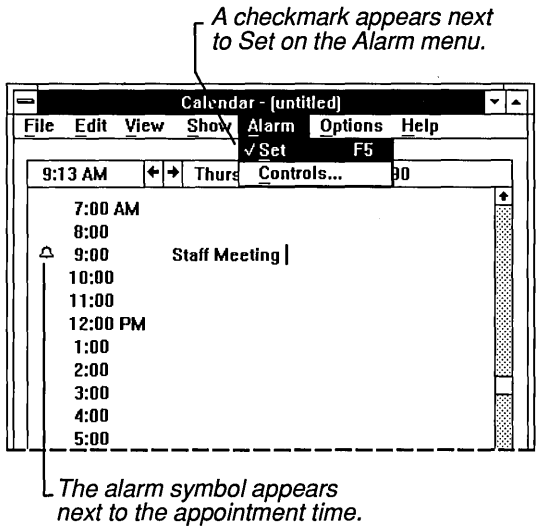

When the alarm goes off, Calendar alerts you in one of the following ways:

<u>If Calendar is</u>	<u>This happens</u>
Active	A dialog box reminds you of the appointment.
Inactive	The title bar at the top of the Calendar window flashes.
An icon	The icon flashes.

### ***Changing the Sound Option***

In addition to visually alerting you about your appointments, the alarm also beeps when it goes off. If you do not want to hear the alarm, you can turn off its sound.

#### **▶ To use a silent alarm:**

1. Choose Controls from the Alarm menu.  
The Alarm Controls dialog box appears.

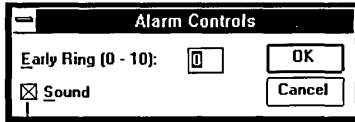

Clear this check box if you don't want sound.

2. Clear the Sound check box.  
Press the SPACEBAR to clear the Sound check box using the keyboard.
3. Choose OK.

### ***Setting the Calendar Alarm to Go Off Early***

You can set the alarm to go off up to 10 minutes before appointment times for which alarms are set.

#### **▷ To set the alarm to go off early:**

1. Choose Controls from the Alarm menu.  
The Alarm Controls dialog box appears.

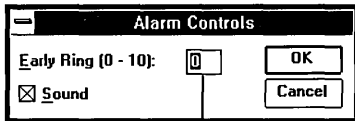

Use this box to set the alarm to go off early.

2. Type a number from 0 to 10 in the Early Ring box.
3. Choose OK.

Alarms continue to go off early until you change the Early Ring setting.



## ***Turning Off the Alarm***

When an alarm goes off, it continues to flash and beep until you turn it off. How you turn off an alarm depends on whether Calendar is an icon, or whether the enlarged Calendar window is active or inactive.

### ***▷ To turn off the alarm:***

---

1. If the Alarm dialog box is not already visible, open the Calendar window or enlarge the Calendar icon.  
Calendar displays the Alarm dialog box.
2. Choose OK.

## ***Removing an Alarm***

If you change your mind about setting an alarm, you can remove the alarm before it goes off.

### ***▷ To remove an alarm:***

---

1. Move to the time the alarm is set for.
2. Choose Set from the Alarm menu.

When you remove an alarm, the checkmark next to Set on the Alarm menu disappears.

## ***Customizing Your Calendar***

You can customize the Day view of your calendar so that it shows other than 60-minute time intervals, uses a 24-hour clock rather than a 12-hour clock, or uses a starting time other than 7 a.m. You can also add special times in the Day view and mark special dates in the Month view.

## Changing Settings in the Day View

The day settings determine the time interval, hour format, and starting time used in the Day view.

### ▷ To change the settings in the Day view:

1. Choose Day Settings from the Options menu.  
Calendar displays the Day Settings dialog box.

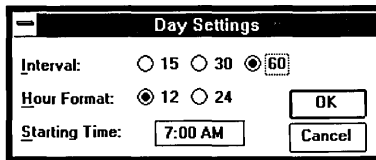

2. Select the options you want to use. See the following table for explanations of the options.
3. Choose OK.

You can set the following options in the Day Settings dialog box:

#### Use this option

#### To do this

Interval

Determine the intervals between daily appointments. You can select intervals of 15, 30, or 60 minutes.

Hour Format

Select either a standard 12-hour clock or a 24-hour clock.

Starting Time

Specify the time that appears at the top of the Calendar window when you first view an appointment day.

## ***Adding a Special Time***

A special time is any time that falls between the intervals you set in the Day Settings dialog box. For example, no matter what time interval you set, 11:10 is a special time.

### **▷ To add a special time to an appointment day:**

1. Choose Special Time from the Options menu.  
Calendar displays the Special Time dialog box.

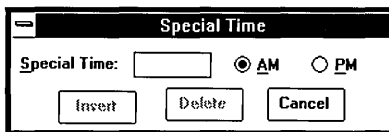

2. Type the time in the Special Time box.
3. Select a.m. or p.m. if you are using a 12-hour clock.
4. Choose Insert.

### **▷ To delete a special time:**

1. Move the insertion point to the time you want to delete.
2. Choose Special Time from the Options menu.  
The Special Time dialog box appears with the selected time in the Special Time box.
3. Choose Delete.

## ***Marking a Date***

You can call attention to special days such as paydays, holidays, birthdays, and anniversaries by *marking* the days in Calendar's Month view. Calendar supplies five different symbols for marking dates. By always marking a specific type of day, such as payday, with the same symbol, you can tell at a glance when that day occurs in the month.

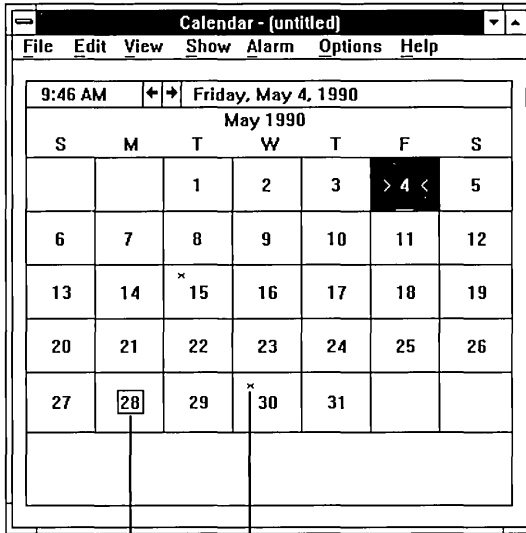

An x designates a payday on this calendar.

A box marks a holiday.

### ► To mark a date in the Month view:

1. Select the date you want to mark.
2. Choose Mark from the Options menu.  
The Day Markings dialog box appears.

Using these marks, you can call attention to special dates.

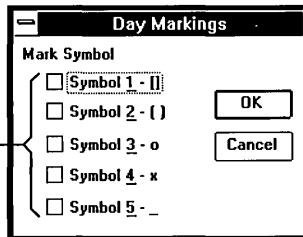

3. Select the check box for the symbol you want to use.

4. Choose OK.

Calendar marks the selected date with the symbol you chose.

▷ **To cancel a mark:**

1. Select the marked date.
2. Choose Mark from the Options menu.  
The Day Markings dialog box appears.
3. Clear the check box for the symbol that marks the selected date and choose OK.  
Calendar removes the mark.

## ***Managing Calendar Files***

Windows automatically assigns the extension .CAL to Calendar files. For information about opening and saving Windows files, see Chapter 2, “Basic Skills.” For information about working with Windows files and directories, see Chapter 4, “File Manager.”

### ***Opening Read-Only Appointment Files***

If you and your co-workers would like to share your daily appointment schedules over a network, you can open appointment files as read-only files. That way you can view someone else’s appointments without accidentally changing or erasing something.

▷ **To open an appointment file as a read-only file:**

1. Choose Open from the File menu.
2. Select or enter the name of the file you want to open.
3. Select the Read Only check box.  
Press the SPACEBAR to select the check box using the keyboard.
4. Choose OK.

### ***Removing an Appointment Day***

You can remove a single appointment day or a range of days that you don’t need anymore from a Calendar file to make room for other appointments.

▷ **To remove appointment days:**

1. Open the file you want to remove appointments from.
2. Choose Remove from the Edit menu.  
Calendar displays the Remove dialog box.

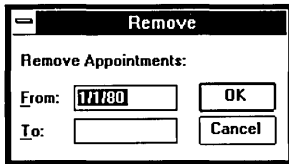

3. In the From box, type the first date you want to remove.
4. In the To box, type the last date you want to remove.  
To remove one day's appointments, leave the To box blank.
5. Choose OK.

## ***Printing Appointments***

If you have connected and installed a printer, you can print your appointments. Chapter 5, "Control Panel," describes how to install a printer. Calendar automatically prints to the designated default printer.

▷ **To print appointments:**

1. Choose Print from the File menu.  
Calendar displays the Print dialog box.

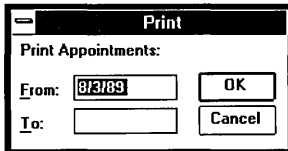

2. In the From box, type the date of the first appointment day you want to print.

3. In the To box, type the date of the last appointment day you want to print.  
To print a single day's appointments, leave the To box blank.
4. Choose OK.

If you have several printers connected to your computer and designated as active printers, you can print to one of these printers by selecting it as the default printer. To do so, use the Printer Setup command on the File menu. For more information about active and default printers, see Chapter 5, "Control Panel."

## ***Setting Margins***

Calendar automatically prints your appointments using the standard margin settings in the Page Setup dialog box. If you want to position your appointments differently on the page, you can adjust the margins before you choose Print.

### **▷ To set the margins for printing appointments:**

1. Choose Page Setup from the File menu.  
The Page Setup dialog box appears.

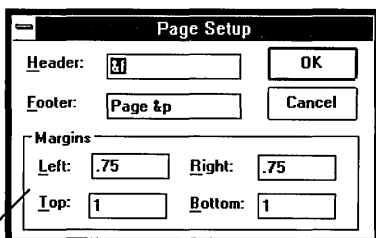

*The standard settings for margins*

2. Type over the standard settings with the margin settings you want to use.
3. Choose OK.  
When you print, Calendar uses the new margin settings in the Page Setup dialog box to position your appointments on the page.

## Printing Headers and Footers

When you print your appointments, you can add explanatory text, the date, a page number, or the filename as a header or footer on the printed pages. You can also choose whether you want a header or footer to be left-justified, right-justified, or centered on the page.

### ► To print a header or footer on your appointments:

1. Choose Page Setup from the File menu.

The Page Setup dialog box appears.

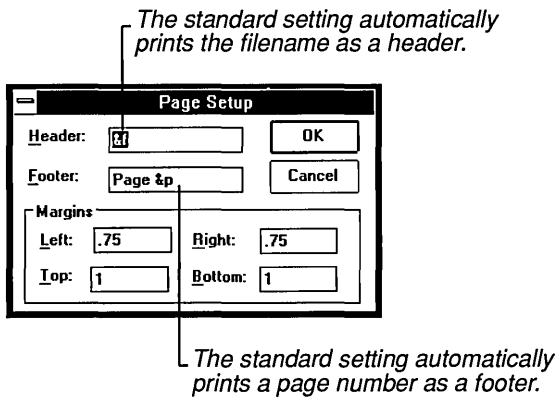

2. Type the text you want to use as a header or footer in the Header or Footer box along with any of the codes that Calendar allows in these boxes. See the following table for more information.
3. Choose OK.



The following table explains the codes that you can type in the Header and Footer boxes:

<u>Type this command</u>	<u>To do this automatically</u>
&d	Enter the current date.
&p	Enter page numbers.
&f	Enter the current filename.
&l	Justify the text that follows at the left margin.
&r	Justify the text that follows at the right margin.
&c	Center the text that follows in the top or bottom margin. This is the default.
&t	Enter the current time.

You can include any or all of these codes in a single header or footer. When you print, any assigned headers or footers appear in their designated places on the printed pages. Headers always appear just above the top margin and footers appear just below the bottom margin.

## ***Cardfile***

Windows Cardfile is like a set of index cards that sorts itself. You can use it to keep track of names, addresses, phone numbers, directions, or anything else you want quick access to.

### **▷ To start Cardfile:**

1. Open the Accessories window.
2. Double-click the Cardfile icon.  
Or select Cardfile and choose Open from the File menu.  
An untitled Cardfile window containing a single, blank card appears.

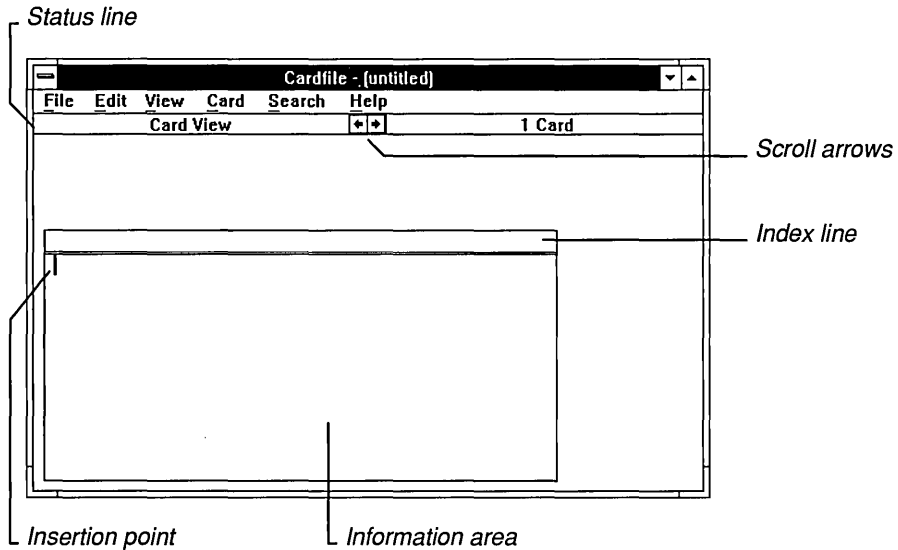

You can change the size of the Cardfile window, but you cannot change the size of the cards.

To create a card file, you fill in as many blank cards as you need. This involves entering text in the index line and information area of the card.

## Filling In and Adding Cards

The index line is the bar at the top of each card. Cardfile uses the text you put in the index line to sort the cards.

### ▶ To fill in a blank card:

1. Choose Index from the Edit menu.  
You can also double-click the index line or press F6.  
Cardfile displays the Index dialog box.

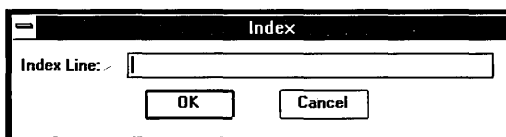

2. Type the text you want in the Index Line box.  
If you make a mistake while typing, press BACKSPACE to correct the text.
3. Choose OK.  
The insertion point returns to the information area of the card.
4. Type the text for the card.  
The text automatically wraps to the next line. For more information about working with text, see Chapter 2, “Basic Skills.”

▷ **To add a new card:**

---

1. Choose Add from the Card menu or press F7.  
Cardfile displays the Add dialog box.

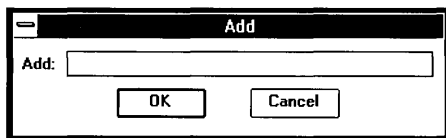

2. Type the text for the new card’s index line in the Add box.
3. Choose OK.  
Cardfile adds the new card to your file in sorted order and scrolls the file to display the new card at the front.
4. Type the text you want to store in the card’s information area.

## ***Viewing Cards as a List***

Cardfile has two viewing options—Cards view and List view. The Cards view is active when you start Cardfile and displays your file as a series of cards. In the List view, Cardfile displays the index line of every card in the file in alphabetical order.

▷ **To display cards as a list:**

---

- Choose List from the View menu.

## Moving Through Your Cards

You can scroll through a file card by card or bring a specific card directly to the front of a file. Cardfile always keeps the cards in alphabetical order based on your entries on the index lines.

### ▷ To scroll through your cards:

- Click the Right or Left scroll arrow in the status bar at the top of the Cardfile window.

If you are using the keyboard, the following keys let you move among the cards in your Cardfile:

<u>Press this</u>	<u>To do this</u>
PAGE DOWN	Scroll forward one card when you are in Cards view. When you are in List view, PAGE DOWN moves forward one page.
PAGE UP	Scroll backward one card when you are in Cards view. When you are in List view, PAGE UP moves back one page.
CTRL + HOME	Bring the first card in the file to the front.
CTRL + END	Bring the last card in the file to the front.
DOWN ARROW	Scroll one card forward when you are in List view.
UP ARROW	Scroll one card backward when you are in List view.

### ▷ To bring a specific card to the front of a file:

1. Choose Go To from the Search menu or press F4.  
Cardfile displays the Go To dialog box.

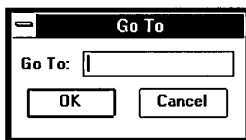

2. Type a portion of the index line text for the card you want to bring to the front; type just enough text to distinguish the card from the other cards.
3. Choose OK.

**HINT** If a card's index line is visible, you can quickly bring the card to the front of the file by pointing to the index line and clicking the mouse button.

If you are using the keyboard, you can quickly bring a card to the front of a file as long as you know the first letter of the index line text. Hold down CTRL and press the appropriate letter key. Cardfile scrolls to display the first card that has that letter at the beginning of its index line. You can now scroll card by card to find the card you want.

### ***Searching for Text in Cardfile***

You can find specific text on cards (not index lines) by using the Find command on the Search menu. You can start a search at any point in the file. Cardfile searches forward from the selected point and, when it reaches the end of the file, automatically continues searching from the beginning of the file. When searching for text, Cardfile ignores capitalization.

#### **▷ To search for text:**

1. Bring to the front of the file the card from which you want to begin the search.
2. Choose Find from the Search menu.  
The Find dialog box appears.

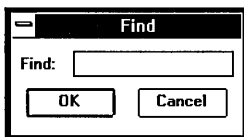

3. In the Find box, type the text you want to find.
4. Choose OK.

Cardfile searches for the text and selects the first occurrence. If there are no occurrences of the text in the file, Cardfile displays a message telling you that it could not find the text.

5. To find the next occurrence of the same text, choose Find Next on the Search menu.

When you choose the Find Next command, Cardfile does not display the Find dialog box but immediately searches for the text.

## ***Editing Text on Cards***

You edit text on a card in much the same way that you edit text in other Windows applications. See Chapter 2, “Basic Skills,” for information about basic editing. There are a few differences in editing a card file, however, that the following sections explain.

### ***Changing the Index Line***

When you edit a card, you edit the index line text separately from the rest of the card—just as you enter this text separately from the rest of the card.

#### **▷ To edit the text in the index line:**

1. Bring to the front of the file the card you want to edit.
2. Choose Index from the Edit menu.  
You can also double-click the index line or press F6.  
The Index dialog box appears with the current index line text selected in the Index Line box.
3. If you want to replace all the text in the index line, type the new text.  
The old text disappears as soon as you type the first character of the new text.
4. If you want to change only a few characters in the index line, click on any character (or press RIGHT ARROW) to move to the characters in error and correct them.
5. Choose OK.  
Cardfile automatically places the card in its correct alphabetical order and then scrolls the file to display the card at the front.

## ***Moving Text to Another Card***

You can use the Clipboard to move text from one card to another in Cardfile.

### **▷ To move text from one card to another:**

1. Select the text you want to move.
2. Choose Cut from the Edit menu.
3. Bring to the front of the file the card to which you want to move the text.
4. Move the insertion point to where you want the text to appear.
5. Choose Paste from the Edit menu.

The text appears in the new location.

You can paste text from the Clipboard to any part of any card except the index line.

## ***Copying Text to Another Card***

If you want to use the same text more than once in a file, you can copy it repeatedly using the Clipboard.

### **▷ To copy text from one card to another:**

1. Select the text you want to copy.
2. Choose Copy from the Edit menu.
3. Bring the card to which you want to copy the text to the front of the file.
4. Move the insertion point to where you want the text to appear.
5. Choose Paste from the Edit menu.

The text appears in the new location.

You can continue pasting the text in as many places as you want.

## ***Pasting a Picture on a Card***

One of Cardfile's most useful features is the ability to transfer artwork from another application to a card. For example, you could create a small map using Paintbrush, then transfer it to a card already containing an address.

### **▷ To transfer a picture to a card:**

1. Copy the picture onto the Clipboard by following instructions in "Editing Your Drawing" in Chapter 8.
2. Start Cardfile or open the Cardfile window.
3. Bring the card to which you want to transfer the picture to the front of the file.
4. Choose Picture from the Edit menu.
5. Choose Paste from the Edit menu.  
The picture appears in the upper-left corner of the card.
6. Drag the picture to where you want it to appear on the card.  
Or use the DIRECTION keys to move the picture.
7. Choose Text from the Edit menu to paste the picture in its permanent location and go back to working with text.

When you transfer a color picture to a card, Cardfile converts the picture to a black-and-white image.

If the picture you paste is larger than the area available to paste it in, only the part of the picture that fits on the card appears. You can use the DIRECTION keys to move different parts of the picture onto the card. If you print the card, only the part of the picture that is visible prints.

## ***Restoring a Card***

If you change your mind about changes you just made to a card, you can restore the card to its original condition as long as it is still at the front of the file. However, once you move a card away from the front, the changes become permanent, and you cannot restore the card.

### **▷ To restore a card:**

- Choose Restore from the Edit menu.



## ***Deleting a Card***

To delete a single card from a file, use the following procedure.

▷ **To delete a card:**

1. Bring to the front of the file the card you want to delete.
2. Choose Delete from the Card menu.  
A dialog box appears, asking you to confirm the deletion.
3. Choose OK.  
Cardfile deletes the card.

Be sure you have the correct card before you delete it. You can replace a deleted card only by retyping the card.

## ***Duplicating a Card***

If the information for several cards is similar, you might want to type the information on one card, duplicate the card, and then edit the copies as necessary.

▷ **To duplicate a card:**

1. Bring the card you want to duplicate to the front of the file.
2. Choose Duplicate from the Card menu.  
Cardfile adds an exact copy of the card to the front of the file.

## ***Managing Cardfile Files***

Windows automatically assigns the extension .CRD to Cardfile files. For information about opening and saving Windows files, see Chapter 2, “Basic Skills.” For information about working with Windows files and directories, see Chapter 4, “File Manager.”

The following topics provide information specific to working with files in Cardfile.

## Determining File Size

The number of cards you can store in a Cardfile file depends on the amount of memory in your computer and the amount of information on the individual cards. As you work on a file, Cardfile keeps track of how many cards are currently in the file and displays the number on the status line. The number of cards might give you an indication of file size, but it does not tell you the actual size of the file in bytes.

## Merging Files

If you want to consolidate two sets of cards, you can do so by merging a second Cardfile file into the file you are currently using.

### ▷ To merge two Cardfile files:

1. Open one of the files that you want to merge.
2. Choose Merge from the File menu.

Cardfile displays the File Merge dialog box.

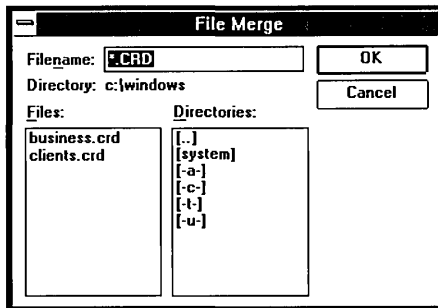

3. Select from the Files box the file you want to merge with the current file, or type the name of the file in the Filename box.
4. Choose OK.

Cardfile merges the cards from the two files, placing them in correct alphabetical order.

You can now use the Save As command from the File menu to save the combined files under a new name or use the Save command to replace the current file with the combined files.

The file that you selected in step 3 to merge with the current file still exists in its original condition. If you want to delete the file, use the Delete command on the File menu in the Windows File Manager.

## ***Printing a Cardfile File***

If you have connected and installed a printer, you can print a single card or an entire file.

### **▷ To print a single card:**

1. Bring the card you want to print to the front of the file.
2. Choose Print from the File menu.

If you want to cancel printing, choose Cancel from the dialog box that appears.

### **▷ To print an entire file:**

- Choose Print All from the File menu.

If you want to cancel printing, choose Cancel from the dialog box that appears.

When printing, Cardfile automatically uses the standard margin settings in the Page Setup dialog box. If you want to position your cards differently on the page, you can use the Page Setup command on the File menu to change these settings. You can also use the Page Setup command to have Cardfile print headers and footers. For more information about using this command, see “Setting Margins” and “Printing Headers and Footers” under “Printing Appointments” in the Calendar section earlier in this chapter.

**HINT** If you change the standard Cardfile margin settings, be sure to set left and right margins that accommodate the size of the cards.

If you have several printers connected to your computer and designated as active printers, you can print to one of these printers by selecting it as the default printer. To do so, use the Printer Setup command on the File menu. For more information about active and default printers, see Chapter 5, “Control Panel.”

## Automatic Dialing

If you have a Hayes or Hayes-compatible modem, Cardfile will automatically dial any phone number stored on a card.

### ▷ To have Cardfile dial a phone number:

1. Bring the card containing the phone number you want to dial to the front of the file.
2. Choose Autodial from the Card menu.  
The Autodial dialog box appears.

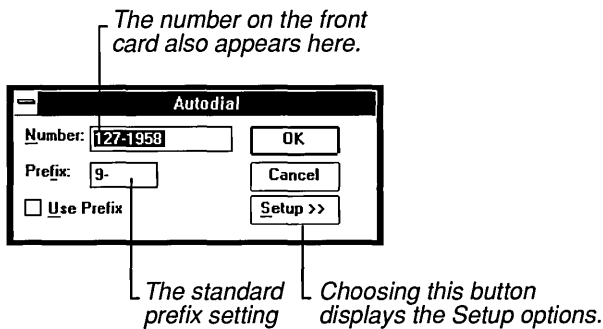

3. If you need to set up your modem for dialing, choose Setup and select the appropriate options. See the list following this procedure for an explanation of these options.
4. Select the Use Prefix check box if you need to use a prefix in front of the number in the Number box.  
Change the standard setting in the Prefix box if necessary.
5. Choose OK.

When you choose the Setup button, the Autodial dialog box expands to display the Setup options.

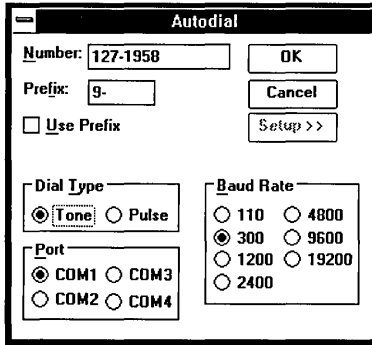

The following list explains the Setup options:

<u>Use this option</u>	<u>To do this</u>
Dial Type	Select the dial type of your telephone. If you normally hear a tone for each number you dial, you have a tone telephone. If you hear a clicking sound, you probably have a pulse telephone.
Port	Select the port to which your modem is connected.
Baud Rate	Tell Cardfile the correct baud rate for your modem. For the correct setting, consult the owner's manual for your modem.

## *Clock*

To help you keep track of the time, Windows provides an accessory called Clock. You can display the Windows clock as an analog or digital clock.

### ▷ To start Clock:

1. Open the Accessories window.
  2. Double-click the Clock icon.
- Or select Clock and choose Open from the File menu.

If you are starting Clock for the first time, a window with a standard analog clock appears. The clock shows the system time.

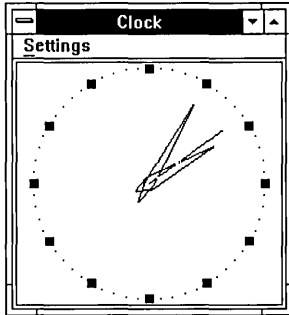

The next time you start Clock, the last mode—*analog or digital*—that you used appears.

You can change the size of the clock and move it wherever you like so that the current time—including seconds—appears on the screen but uses little work space. Clock even continues to display the time when you shrink it to an icon.

▷ **To switch between the analog and digital clocks:**

- Choose Analog or Digital from the Settings menu in the Clock window.

The type of clock you chose continues to appear when you open the Clock accessory until you change the setting again.

If you need to, you can reset the time from Control Panel. See Chapter 5, “Control Panel,” for more information.

## ***Notepad***

Windows Notepad is a text editor. You can use Notepad to jot down notes, write short memos, and create and edit batch files.

▷ **To start Notepad:**

1. Open the Accessories window.
  2. Double-click the Notepad icon.  
Or select Notepad and choose Open from the File menu.
- An empty, untitled Notepad window appears.

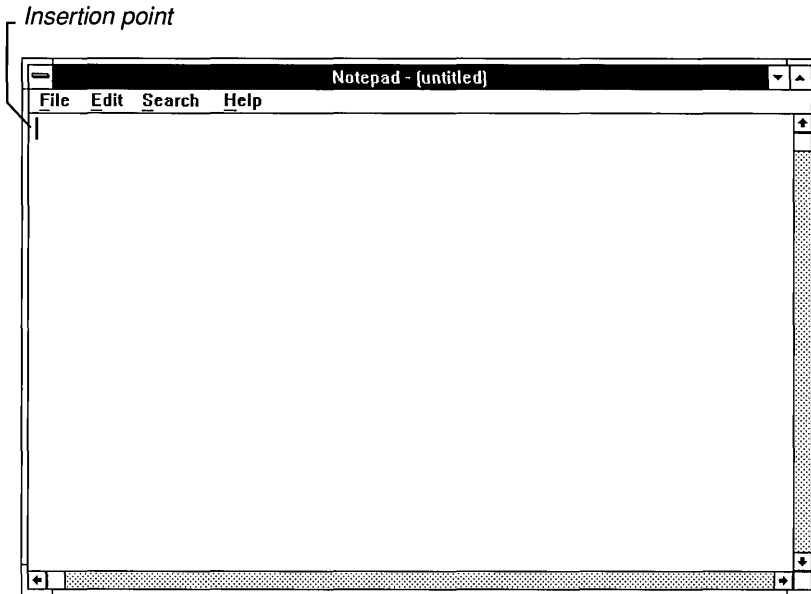

Any text that you type appears at the insertion point in the upper-left corner of the window.

## ***Working with Text***

Working with text in Notepad is much the same as working with text in any other Windows application. See Chapter 2, “Basic Skills,” for more information. There are a few differences, however, that the following sections explain.

### ***Setting the Word Wrap Option***

Text that you type in the Notepad window can go beyond the right border of the window. If you don’t want this to happen, you can set the Word Wrap option. This option automatically wraps text to the beginning of the next line when the text reaches the right edge of the window without affecting your text file. The text file retains the full line of text.

#### **▷ To set the Word Wrap option:**

- ❑ Choose Word Wrap from the Edit menu.  
A checkmark appears next to the Word Wrap command on the menu.

The Word Wrap option remains in effect until you choose Word Wrap again. After choosing Word Wrap again, you must press ENTER to begin a new line.

## ***Moving Around in a Notepad File***

You can use the scroll bars as explained in Chapter 2, “Basic Skills,” to move around your Notepad file using a mouse. If you are using the keyboard, you can use the DIRECTION keys, the SPACEBAR, and ENTER, which are described in Chapter 2, as well as the following keys:

<u>Press this</u>	<u>To move to</u>
HOME	The beginning of a line
END	The end of a line
CTRL + HOME	The beginning of the document
CTRL + END	The end of the document

## ***Selecting Text in Notepad***

In addition to the different ways of selecting text described in Chapter 2, “Basic Skills,” you can select all the text in a given Notepad file. This feature is useful if you want to copy an entire Notepad file to the Clipboard and merge it with another file.

### **▷ To select all the text in a Notepad file:**

- Choose Select All from the Edit menu.

Notepad highlights all the text in your file. If you change your mind, click anywhere in the text area.

## ***Searching for Text in Notepad***

You can find specific text in Notepad by using the Find command on the Search menu. You can start a search at any point in a file and search either forward or backward from that point. You can also specify whether Notepad should match the uppercase and lowercase characters of the text.

When searching for text, Notepad begins the search at the position of the insertion point and ends at the beginning or end of the file, depending on whether you choose Backward or Forward.



▷ **To search for text in Notepad:**

1. Position the insertion point where you want to start the search.
2. Choose Find from the Search menu.  
The Find dialog box appears.

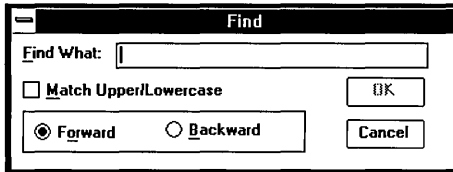

3. In the Find What box, type the text you want to find.
4. Select the Match Upper/Lowercase box if you want to match capitalization exactly.
5. Select Backward if you want to search from the insertion point to the beginning of the file.  
The standard setting is Forward.
6. Choose OK.  
Notepad searches for the text and selects the first occurrence. If there are no occurrences of the text in the portion of the document searched, Notepad displays a message telling you that it could not find the text.
7. To find the next occurrence of the same text, choose Find Next on the Search menu.  
When you choose the Find Next command, Notepad does not display the Find dialog box but immediately searches for the search text.

## ***Managing Notepad Files***

Windows automatically assigns the extension .TXT to Notepad files. For information about opening and saving Windows files, see Chapter 2, “Basic Skills.” Information about working with Windows files and directories can be found in Chapter 4, “File Manager.” The following sections provide information specific to working with Notepad files.

## Determining the Size of a Notepad File

As you work on a file, Notepad keeps track of how much disk space the file is using. The maximum size for a Notepad file is approximately 50,000 characters.

### ▷ To find out the current size of a Notepad file:

1. Choose About Notepad from the Help menu.  
Notepad displays a dialog box that tells you the number of characters currently in the file.
2. Choose OK to close the dialog box.

## Creating a Time-Log File

You can use Notepad to create a log to keep track of how you spend your time.

### ▷ To create a Time-Log file:

- Type *.LOG* in capital letters, beginning at the left margin of the first line in a Notepad file.

Every time you open this file, Notepad automatically adds the current time and date to the end of the file. To keep an accurate log of how you spend your day, you can type notes about your daily activities after each time and date.

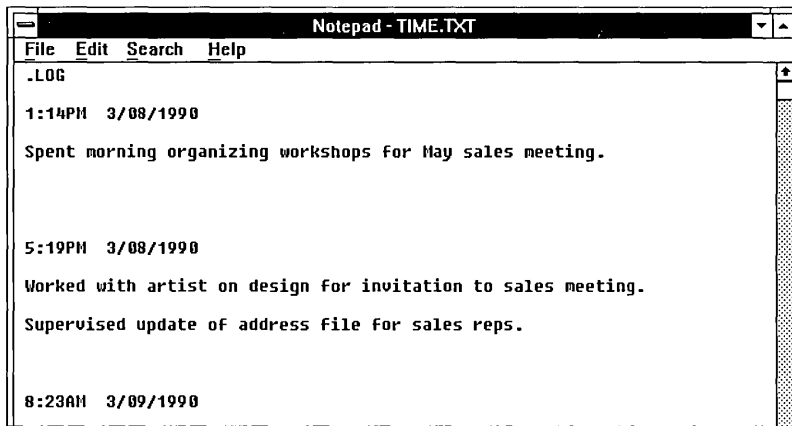

A sample Time-Log file

**NOTE** Notepad uses the system time and date. You can reset the time and date using Control Panel. For more information, see Chapter 5, “Control Panel.”

You can also add the current time and date to any Notepad file that you are working with.

▷ **To add the current time and date to a Notepad file:**

- Choose Time/Date from the Edit menu.

The time and date appear at the location of the insertion point.

## ***Printing a Notepad File***

If you have connected and installed a printer, you can print your Notepad files. Notepad automatically prints to the designated default printer. Chapter 5, “Control Panel,” describes how to install a printer.

▷ **To print the currently displayed file:**

- Choose Print from the File menu.

If you want to cancel printing, choose Cancel from the dialog box that appears.

When printing, Notepad automatically uses the standard margin settings in the Page Setup dialog box. If you want to position your Notepad text differently on the page, you can use the Page Setup command on the File menu to change these settings. You can also use the Page Setup command to have Notepad print headers and footers. For more information about using this command, see “Setting Margins” and “Printing Headers and Footers” under “Printing Appointments” in the Calendar section earlier in this chapter.

If you have several printers connected to your computer and designated as active printers, you can print to one of these printers by selecting it as the default printer. To do so, use the Printer Setup command on the File menu. For more information about active and default printers, see Chapter 5, “Control Panel.”

# Recorder

Windows Recorder allows you to record a sequence of keystrokes and mouse actions—called a *macro*—to play back at a later time. You can use macros to type automatically a special phrase or code that you use frequently or to automate the steps of any routine task.

## ▶ To start Recorder:

1. Open the Accessories window.
2. Double-click the Recorder icon.  
Or select Recorder and choose Open from the File menu.  
The Recorder window appears.

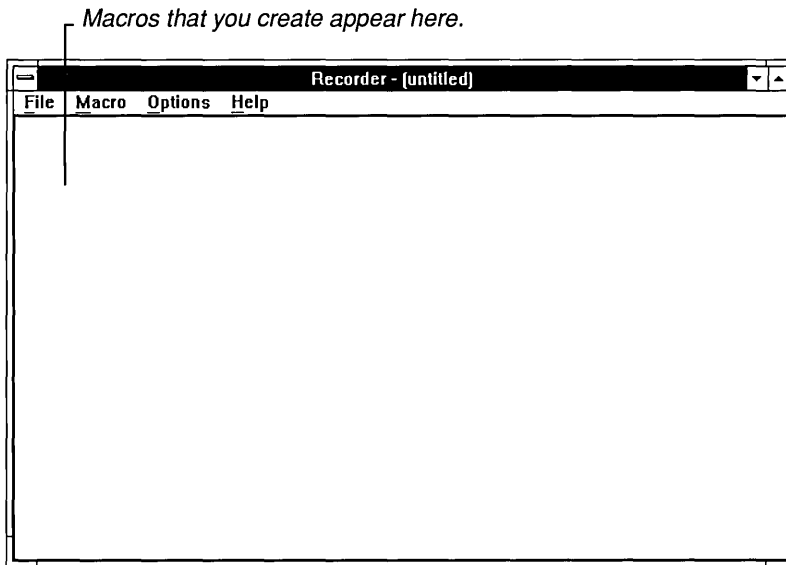

## ***Recording a Simple Macro***

Recorder provides various options that you can set when recording complex macros. When you are recording a simple macro, however, the standard settings for these options should work in most cases.

Recording a simple macro is a straightforward, simple process. However, the Windows environment, which can contain multiple windows and multiple applications, can be a complex one in which to record a macro. It is a good idea to read the sections “Using the Record Options” and “Guidelines for Creating Macros” later in this chapter before recording macros.

▷ **To record a simple macro:**

1. In the application where you are recording the macro, position the cursor where you want to start recording.  
This will also be the position from which you start playing back the macro.
2. Choose Record from the Macro menu in the Recorder window.  
The Record Macro dialog box appears.

Fill in one or both when recording a macro.

The image shows the 'Record Macro' dialog box. It has a title bar 'Record Macro'. Inside, there is a text box for 'Record Macro Name'. Below that is a 'Shortcut Key' section with a text box and a dropdown arrow, and three checkboxes:  Ctrl,  Shift, and  Alt. To the right is a 'Playback' section with a 'To:' dropdown set to 'Same Application', a 'Speed:' dropdown set to 'Fast', and two checkboxes:  Continuous Loop and  Enable Shortcut Keys. At the bottom, there are two dropdowns: 'Record Mouse' set to 'Clicks + Drags' and 'Relative to' set to 'Window'. Below these is a 'Description' text area with a vertical scrollbar on the right. A line from the text above points to the 'Shortcut Key' section.

3. Type a name of up to 40 characters that identifies your macro in the Record Macro Name box or assign the *shortcut key* that you want to use to play back the macro in the Shortcut Key box. (You can do both if you want.)  
Although you do not *have* to assign a shortcut key to a macro, doing so provides an easy way to play back the macro. You can assign a shortcut key by combining the CTRL, SHIFT, or ALT key with any other keyboard key. CTRL is the standard setting. For more information about shortcut keys, see the following section, “Assigning Shortcut Keys.”
4. Choose Start to begin recording your macro.

You probably do not need to change the settings for any of the other options when recording a simple macro. For more information about these options, see “Using the Record Options” later in this chapter.

When you choose Start, Recorder shrinks to a flashing icon. The icon continues flashing until recording stops, although the icon may not be visible if you move another window in front of it.

5. Enter the keystrokes and mouse actions that you want to record.

It is best to use few or no mouse actions when recording a macro. For more information, see “Deciding What to Record” and “Guidelines for Creating Macros” later in this chapter.

6. When you want to stop recording, click the Recorder icon.

Or press CTRL + BREAK to stop recording using the keyboard.

A dialog box appears, asking if you want to save your macro, resume recording, or cancel recording.

7. Choose Save Macro and then OK to save your macro and return to what you were doing before you started recording.

If you want to resume recording where you left off, choose Resume Recording, if necessary, and then choose OK. If you want to cancel recording and throw away what you have recorded so far, choose Cancel Recording and then OK.

## ***Assigning Shortcut Keys***

It is a good idea to assign a shortcut key to a macro. Doing so provides an easy way of using the macro. You just have to press the shortcut key, and the macro starts playing back. However, if you prefer not to assign a shortcut key or if you run out of key combinations to use, you can type a name in the Record Macro Name box in the Record Macro dialog box instead. For more information about names and starting a macro using its name, see the next section, “Using Macro Names and Descriptions,” and “Playing Back a Macro” later in this chapter.

Virtually any key on the keyboard can be used with the CTRL, SHIFT, or ALT key to create a shortcut key. If you want to use a function or keypad key as a shortcut key instead of a basic keyboard key, select the name for the key from the list in the Shortcut Key box.

### **▷ To create a shortcut key using a regular keyboard key:**

---

1. Type the keyboard key that you want to use in the Shortcut Key box.
2. Select the check box for CTRL, SHIFT, or ALT.  
CTRL is the standard setting.

▷ **To assign a shortcut key using a function or keypad key:**

1. Click the Down arrow in the Shortcut Key box.

The Shortcut Key box drops down to display a list of function and keypad key names.

*Names of function and keypad keys available for shortcut keys*

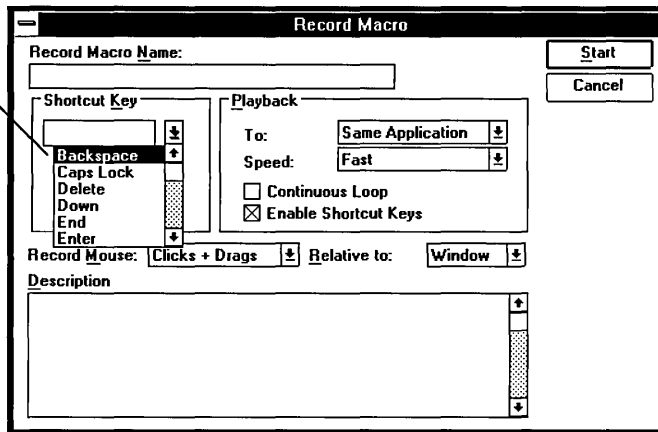

2. Select the name you want to use from the list.

The selected name appears in the Shortcut Key box at the top of the list.

You can also use combinations of CTRL, SHIFT, and ALT as shortcut keys.

---

**CAUTION** Although Recorder does not prevent you from using ALT as a shortcut key, it is best to use it sparingly. Shortcut keys using ALT could easily conflict with Windows shortcut keys.

---

## ***Using Macro Names and Descriptions***

You can store many macros in the same Recorder file. To help you remember the purpose of a macro, you can enter a descriptive name for the macro in the Record Macro Name box in the Record Macro dialog box. The name then appears with the shortcut key on the list of macros in the main Recorder window. If you do not want to assign a shortcut key to a macro, you *must* enter a name in the Record Macro Name box.

A name can contain up to 40 characters. If you want to enter a longer description for your macro, you can use the Description box in the Record Macro dialog box. This box allows you to enter an unlimited amount of text describing the macro.

## ***Playing Back a Macro***

Once you record a macro, you can use it to speed up your work. You must be sure, however, to start the macro when and where it can work properly. For example, suppose you want to play back a macro that automatically enters and sets an alarm for a standing Wednesday-afternoon appointment. Such a macro would not be appropriate to use in any application except Calendar.

### **▷ To play back a macro using the shortcut key:**

1. Open the Recorder window and select the macro you want to play back.
2. Position the cursor in the application's window where you want to start playing back the macro.
3. Press the shortcut key assigned to the macro.

If you have not assigned a shortcut key to a macro, you must use the Run command on the Macro menu to play back the macro. You can also use this command to play back a macro if you don't remember the shortcut key for the macro.

### **▷ To play back a macro using the Run command:**

1. Position the cursor in the application's window where you want to start playing back the macro.
2. Open the Recorder window.
3. Select the macro you want to play back from the Recorder window.
4. Choose Run from the Macro menu.

### **▷ To stop a macro while it is playing back:**

- Press CTRL + BREAK.  
A dialog box appears, confirming the cancellation.



## Maintaining the Recorder Window at Playback

When you start playing back a macro using the Run command, the Recorder window shrinks to an icon. If you want, you can maintain the Recorder window in its position on the screen while the macro plays.

### ▶ To maintain the Recorder window when you use the Run command:

- Choose Minimize on Use from the Options menu.

The checkmark is removed from the menu command.

Choose Minimize on Use again to shrink the Recorder window to an icon during playback.

## Using the Record Options

When you choose Record from the Macro menu, the Record Macro dialog box appears.

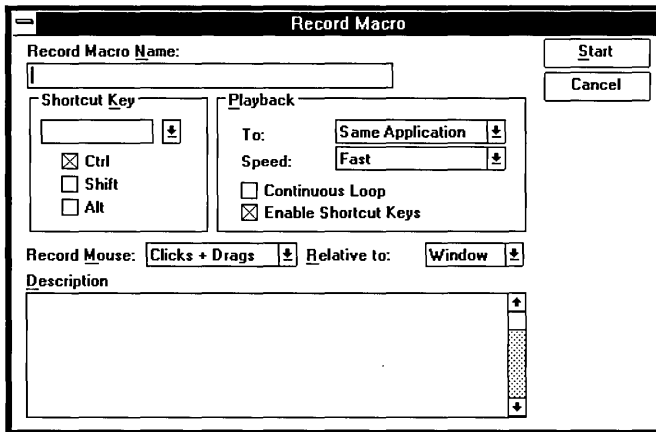

Standard settings appear next to the option names.

In addition to providing the boxes where you assign a shortcut key or a descriptive name to a macro, the Record Macro dialog box provides a number of options that

you can use when recording a macro. These options allow you to decide such things as whether a macro can:

- Record mouse movements relative to only a window or the whole screen.
- Record some or all mouse movements as well as keystrokes or record only keystrokes.
- Play back only in the application where you record the macro or play back anywhere.
- Play back quickly or at the recorded speed.
- Use other macros while it is playing back.

Each time you finish recording a macro, Recorder resets to the standard setting any option that you changed before recording. If you want to permanently change the standard setting for an option, see “Setting Permanent Preferences” later in this chapter. The following sections explain the options in the Record Macro dialog box.

### ***Deciding What to Record***

When you record a macro, Recorder assumes that you want to record all keystrokes and only mouse clicks and drags. You can choose, however, to record as much or as little mouse movement as you want.

Although Recorder allows you to record as much mouse movement as you want, it is best to keep the recording of mouse movements to a minimum. Macros that record keystrokes are generally more reliable. This is because mouse movements that you record in one window might not be appropriate for the window in which you later want to replay the macro, particularly if the windows are not the same size.

#### **▷ To determine the mouse movements you want to record:**

1. In the Record Macro dialog box, click the Down arrow in the Record Mouse box to select the box and display its options.  
Or select the box and press ALT + DOWN ARROW to display the Record Mouse options.
2. Choose the option you want to use. The option then appears as the setting in the Record Mouse box.

The following list describes the options available in the Record Mouse box.

<u>Use this option</u>	<u>To do this</u>
Clicks + Drags	Record keystrokes and all mouse movement while a button is pressed. This is the standard setting. It allows you to record most drawing or editing sequences in a program like Paintbrush.
Ignore Mouse	Record only keystrokes. It is best to use this option when you want to record a macro to be used by a variety of people using different machines. Macros containing mouse movements will work properly only on machines using a video adapter identical to the one used by the system on which the macro was recorded.
Everything	Record keystrokes and all mouse action even when a button is not pressed. You should use this option sparingly, but it is appropriate when you are using an application that pays attention to mouse movement even when no button is pressed.

---

**CAUTION** If you use the Everything option to record keystrokes and all mouse movements, you should press CTRL + BREAK when you want to stop recording your macro. If you use the mouse to stop recording, the movement of the mouse to the Recorder icon can cause the macro to behave incorrectly when played back. The Recorder icon could be in a different location, or the Window could be a different size.

---

### ***Choosing Where to Record***

Recorder assumes that you want to record a macro relative to the window you are currently working in. There may be times, however, when you want to record a macro relative to the entire screen. For example, you might be using a full-screen application.

#### **▷ To record a macro relative to the entire screen:**

1. In the Record Macro dialog box, click the Down arrow in the Relative To box to select the box and display its options.  
Or select the box and press ALT + DOWN ARROW to display the Relative To options from the keyboard.
2. Choose Screen.  
Screen now appears as the setting in the Relative To box.

The Relative To option that you use to record a macro is the same option used to play back the option. You cannot change this option after the macro is recorded.

### ***Choosing Where a Macro Plays Back***

The To option in the Record Macro dialog box gives you a choice of playing back a macro in any application or only in the application in which you record it. Recorder assumes that you want to play back a macro only in the application where you recorded it. Many times, a macro that makes sense in one application might not make any sense in another. For example, a macro that types a long phrase that you use frequently might be appropriate for your word processor, but not for your spreadsheet.

#### **▷ To record a macro that plays back in any application:**

---

1. In the Playback area of the Record Macro dialog box, click the Down arrow in the To box to select the box and display its options.  
Or select the box and press ALT + DOWN ARROW to display the To options.
2. Choose Any Application.  
Any Application now appears as the setting in the To box.

### ***Including Macros Within a Macro***

Recorder allows you to include—or *nest*—up to five levels of macros within a macro. In other words, Macro 1 can contain a macro called Macro 2, Macro 2 can contain a macro called Macro 3, and so on. Recorder assumes that you want a macro to be able to include nested macros. However, you can also record macros that cannot nest other macros inside themselves.

#### **▷ To record a macro that cannot nest other macros:**

---

- Clear the Enable Shortcut Keys check box in the Playback area of the Record Macro dialog box.  
Press the SPACEBAR to clear the Enable Shortcut Keys check box using the keyboard.

---

**CAUTION** Since a macro that contains a nested macro records only a shortcut key, not the actual sequence of steps represented by the shortcut key, any nested macros can be changed at any time. When you change a nested macro, you must be sure not to make changes that cause the macro containing the nested macro to stop working properly.

---

## ***Managing Recorder Files***

Recorder files can contain many macros. The macro name and/or shortcut key identifies each macro in the file, as does any description that you entered for the macro. You can create Recorder macros of up to 64K. Different Recorder files can contain groups of macros for use at specific times or with a specific application, but you can open only one file at a time.

Windows automatically assigns the extension .REC when you save your Recorder files. For information about saving and opening Windows files, see Chapter 2, “Basic Skills.” For information about working with Windows files, see Chapter 4, “File Manager.”

The following sections provide information specific to working with Recorder files.

### ***Changing a Macro's Properties***

You can use the Properties command on the Macro menu to change the following properties that you assigned to a macro when you recorded it:

- The shortcut key assignment
- The name
- The description
- Whether the macro plays back to the same application where it was recorded or to any application
- The speed at which the macro plays back
- Whether or not the macro plays back continuously
- Whether or not the macro can contain other shortcut keys

#### **▷ To change a macro's properties:**

1. Select the macro you want to modify from the Recorder window.
2. Choose Properties from the Macro menu.  
The Macro Properties dialog box appears.

You cannot change the Relative setting.

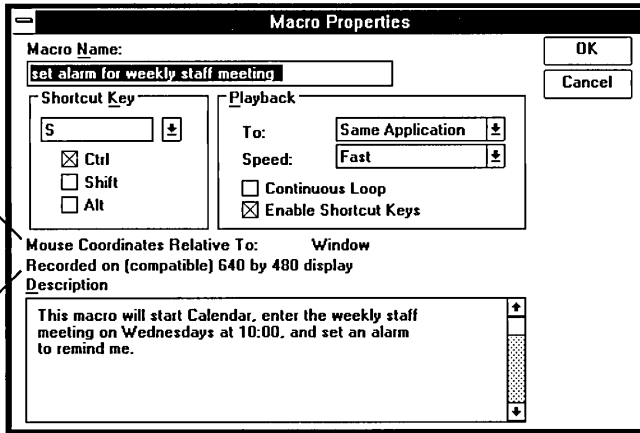

The screen resolution under which the selected macro was recorded

3. You can change any of the macro settings, except Mouse Coordinates Relative To.
4. Choose OK.

The screen resolution information lets you know what kind of video display the macro was recorded on. This is helpful because mouse movements are sensitive to the screen resolution, and macros containing mouse movements seldom work properly on a different type of video adapter.

## ***Deleting Macros from a Recorder File***

You can delete a macro that you are no longer using from a Recorder file to make room for new macros.

### **▷ To delete a macro:**

1. Open the file from which you want to delete macros.
2. Select the macro you want to delete from the Recorder window.
3. Choose Delete from the Macro menu.

A dialog box appears, asking you to confirm the deletion.

4. Choose OK to delete the macro.

## Merging Recorder Files

If you want to consolidate two Recorder files, you can do so by merging a second Recorder file into the file you are currently using.

### ▷ To merge two Recorder files:

1. Open one of the files that you want to merge.
2. Delete any macros that you know are duplicated in the file you want to merge with the current file.
3. Choose Merge from the File menu.  
Recorder displays the File Merge dialog box.

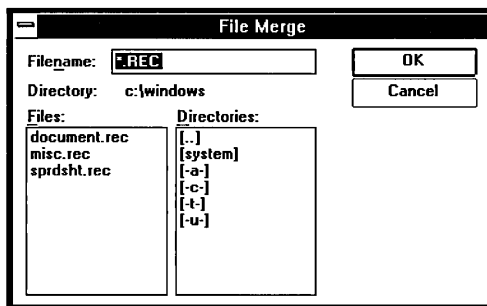

4. Select from the Files box the file you want to merge with the current file, or type the name of the file in the Filename box.
5. Choose OK.  
Recorder merges the two files. If Recorder finds duplicate shortcut key assignments in the files, it clears the duplicate shortcut keys from the file it is merging with the current file. A dialog box appears to inform you of this. You can use the Properties command on the Macro menu to assign new shortcut keys to the macros.
6. Choose Save As from the File menu to save the combined files under a new name or choose Save to replace the current file with the combined files.

## Setting Permanent Preferences

Each time you choose the Record command, the Record Mouse, Relative To, Playback To, and Playback Speed recording options are set to record macros in the following ways:

<u>This option</u>	<u>Is set to</u>
Record Mouse	Record all keystrokes and mouse movements when a mouse button is pressed.
Relative To	Record macros relative to the window in which you are currently working.
Playback To	Record macros that will play back only in the applications in which you record them.
Playback Speed	Record macros that play back quickly.

You can change the standard settings for these options if you want to.

### ▷ To change the standard settings for recording:

1. Choose Preferences from the Options menu.  
The Default Preferences dialog box appears.

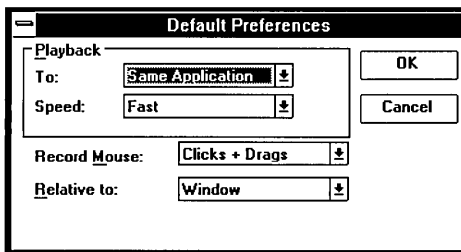

2. Click the Down arrow in the option box for which you want to change the standard setting. This selects the box and displays its settings.  
Or select the box and press ALT + DOWN ARROW to display the options from the keyboard.
3. Select the setting you want Recorder to use as the standard setting.
4. Choose OK.



The settings you select in the Default Preferences dialog box become the standard settings for the appropriate options in the Record Macro dialog box. Recorder continues to use these standard settings until you use the Preferences command to change them again. See “Changing a Macro’s Properties” earlier in this chapter.

## ***Creating Macros to Use as Demos***

Recorder provides certain options for demonstrating features or applications. For instance, you can have a macro play back at a speed appropriate for a demonstration and play back continuously. You can also set a demonstration that runs continuously until you turn off the computer.

### ***Choosing How Fast a Macro Plays Back***

Recorder assumes that you want a macro to play back quickly. However, if you are going to use a macro as a demonstration, you will want the macro to play back at the same speed at which it was recorded.

#### **▷ To play back a macro at the speed at which it was recorded:**

1. In the Playback area of the Record Macro dialog box, click the Down arrow in the Speed box to select the box and display its options.  
Or select the box and press ALT + DOWN ARROW to display the Speed options from the keyboard.
2. Choose Recorded Speed.  
Recorded Speed now appears as the setting in the Speed Box.

### ***Setting Up for a Continuously Running Demo***

If you want to use a macro as a demonstration, you might also want the macro to restart itself each time it reaches the end so that it plays back continuously.

#### **▷ To set a macro to play back continuously:**

- Select the Continuous Loop check box in the Playback area of the Record Macro dialog box.  
Press the SPACEBAR to select the Continuous Loop check box using the keyboard.

If you select the Continuous Loop check box, you can still stop a macro by pressing CTRL + BREAK.

### ***Turning Off Control + Break Checking***

Pressing CTRL + BREAK usually stops the recording or playing back of a macro. If you want to use a macro as a continuously running demonstration, you might want to turn off Recorder's ability to detect the CTRL + BREAK key combination so that you can prevent an automated demonstration from being turned off by anyone who uses the keyboard. The macro runs until you turn off the computer.

#### **▷ To turn off Recorder's ability to detect CTRL + BREAK:**

---

- Choose Control+Break Checking from the Options menu.

The checkmark next to the menu command disappears.

You must restart your computer to stop a continuously running demo after turning off Control+Break Checking.

**HINT** You might also want to turn off Recorder's ability to detect CTRL + BREAK if you want to include a CTRL + BREAK key combination in a macro.

The next time you start Recorder after turning off Control+Break Checking, the command is again set to detect CTRL + BREAK.

## ***Temporarily Turning Off Recorder***

There may be times when you want to temporarily turn off Recorder's ability to detect shortcut keys. For example, you might want to run an application that uses the same shortcut key that one of your macros uses. You can do so without having to exit from Recorder.

#### **▷ To temporarily turn off Recorder's ability to detect shortcut keys:**

---

- Choose Shortcut Keys from the Options menu.

The checkmark next to the menu command disappears.

If you want to use macros again before you exit from Recorder, choose Shortcut Keys again. Otherwise, the next time you start Recorder, the Shortcut Keys command is reset automatically to detect when you press shortcut keys.

## ***Guidelines for Creating Macros***

To get the best results, follow these guidelines when recording macros:

- Get ready for recording the macro.  
If there are applications on the screen that should not be involved in the macro, close or move them out of the way before you start recording.
- Use the mouse sparingly.  
An application window might be a different size and in a different place when you play back a macro. This can create problems with recorded mouse actions. For example, the mouse might go outside of a window's boundaries completely when you play back the macro, or it might point at something different than it did when you were recording the macro.
- Use the Windows shortcut keys to choose menus commands.  
If a window is near the bottom of the screen when you play back a macro, a menu might pop up instead of down, making UP ARROW and DOWN ARROW move the cursor inappropriately.
- Be aware of system incompatibility issues.  
Recorder is sensitive to the screen resolution of the system that mouse movements were recorded on. Macros that use mouse movements will seldom work properly when used on a system that does not use the same graphics adapter as the system on which the macro was recorded.  
Recorder is also sensitive to the keyboard that keystrokes were recorded with. While most keys will play back correctly, it is best not to use a macro recorded using a keyboard set up for one country on a system using a keyboard set up for another country. See Chapter 5, "Control Panel," for more information about keyboard settings.
- Be aware that Recorder is designed for use with Windows applications only.

## ***PIF Editor***

To use a non-Windows application with Windows, you might need a program information file (PIF). A program information file provides special information that Windows needs to run an application, such as the path to the directory where the application is stored and the extension for the command file that starts the application. You can create a new PIF, or edit an existing one, by using PIF Editor. See Chapter 12, "More About Applications," to learn how to use PIF Editor.

---

*Part* | ***Advanced Topics***

**3**

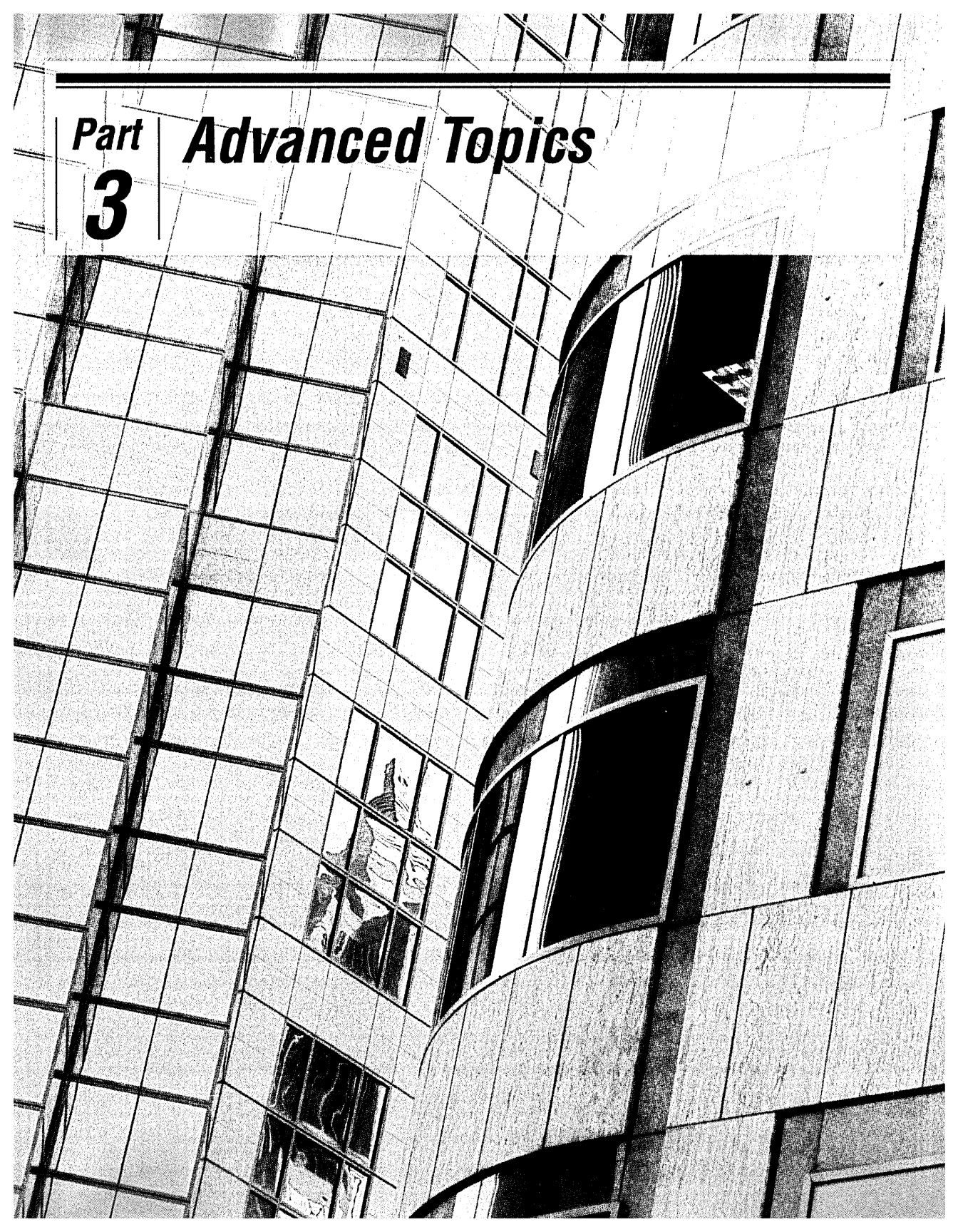

---

---

# ***Advanced Topics***

## **CHAPTERS**

<b>11</b>	<i>Options for Starting Windows</i> . . . . .	<b>425</b>
<b>12</b>	<i>More About Applications</i> . . . . .	<b>433</b>
<b>13</b>	<i>Optimizing Windows</i> . . . . .	<b>491</b>
<b>14</b>	<i>Windows and Networks</i> . . . . .	<b>543</b>

---

---

**Chapter**  
**11**

***Options for Starting Windows***

**The Windows Command Line .....427**

**Starting Windows in a Specific Mode .....428**

**Controlling How Windows Uses Expanded Memory in Real Mode .....429**

**Specifying a Run Command .....431**

**Some Sample Windows Command Lines .....431**

Vertical line on the left side of the page.

## The Windows Command Line

The *Windows command line* is the text you type at the DOS prompt to start Microsoft Windows. Most of the time, you'll probably start Windows simply by typing *win*. However, sometimes you might want to start Windows in a particular mode, or tell Windows to run a particular application at start-up. This chapter explains how to use the Windows start-up options.

The Windows command line tells your computer:

- To start Windows.
- What mode to start Windows in (optional).
- How Windows should use expanded memory (optional).
- The application or command that you want Windows to run when it starts (optional).

The Windows command line has the following form:

*win* **Switches** **RunCommand**

The *win* portion of the Windows command line tells MS-DOS to start Windows. You must always include the *win* portion of the command line; the rest of the command line is optional.

The **Switches** portion of the Windows command line represents optional switches, such as */R*, that you can include on the command line. There are two types of switches: those that specify the mode that Windows runs in, and those that determine how Windows uses expanded memory. The switches are described later in this chapter.

The **RunCommand** portion of the Windows command line represents optional text that you can include to start an application when you start Windows. For more information, see "Specifying a Run Command" later in this chapter.



## ***Starting Windows in a Specific Mode***

Windows can run in three modes: real mode, standard mode, or 386 enhanced mode. When you type *win*, Windows examines your system's configuration and starts in the most appropriate mode for your system. (To determine what mode Windows is running in, choose About Program Manager from the Help menu in Program Manager.)

Windows uses the following criteria when deciding what mode to use:

- Windows runs in 386 enhanced mode if your system is an 80386 computer (or higher) with at least 2MB of memory (640K of conventional memory and 1024K of extended memory).
- Windows runs in standard mode if your system is an 80286 computer (or higher) with at least 1MB of memory (640K of conventional memory and 256K of extended memory).
- Windows runs in real mode if your system is an 8086 or 8088 computer with at least 640K of conventional memory. Windows also runs in real mode if your system is an 80286, 80386, or 80486 computer with less extended memory than specified previously.

Sometimes you might want to run Windows in a specific mode, even if it is not the most efficient one for your system. For example, if you're running applications designed for previous versions of Windows, you would want to run Windows 3.0 in real mode, even though it could run in standard mode or 386 enhanced mode.

To ensure that Windows runs in a particular mode, include the switch for that mode on the Windows command line when you start Windows. For example, to start Windows in real mode, type *win /r*. You can specify one of the following switches:

**Use this switch**

**To do this**

*/R*

Run Windows in real mode.

This switch is most useful if you want to run applications designed for earlier versions of Windows. Many such applications are incompatible with the memory management that Windows performs when running in standard mode or 386 enhanced mode. Chapter 12, "More About Applications," explains more about running older Windows applications.

<u>Use this switch</u>	<u>To do this</u>
/S	<p>Run Windows in standard mode.</p> <p>You might want to use this switch if your system is an 80386 computer with between 2MB of memory (640K conventional, 1024K extended) and 3MB of memory (640K conventional, 2096K extended), and you do not use non-Windows applications with Windows. On such systems, Windows runs faster in standard mode than in 386 enhanced mode, as long as you use only Windows applications.</p> <p>You might also want to use this switch if you are having hardware compatibility problems when running in 386 enhanced mode.</p>
/3	<p>Run Windows in 386 enhanced mode.</p> <p>You might want to use this switch if you want to run Windows in 386 enhanced mode, even though your 80386 computer (or higher) has less than the 2MB of memory that 386 enhanced mode normally requires. This switch works only on 80386 systems with at least 1MB of memory (640K conventional, 384K extended). (Note that if your system has less than 2MB of memory, Windows will probably run more slowly in 386 enhanced mode than in standard mode.)</p>

Specifying a mode switch is optional. If you do not specify a mode, Windows examines your system configuration and starts in the mode most appropriate for your system.

## ***Controlling How Windows Uses Expanded Memory in Real Mode***

When running in real mode, Windows can use your system's expanded memory if there is any. (Windows does not use expanded memory in standard mode or 386 enhanced mode although some Windows applications do.) When Windows starts in real mode, it examines your system's memory configuration and determines the most efficient way to use your expanded memory. For more information about expanded memory, see Chapter 13, "Optimizing Windows."

Normally, Windows uses your system's expanded memory as efficiently as possible. However, sometimes you might want to control Windows' use of

expanded memory. To do so, you can include expanded-memory switches on the Windows command line. You can specify one or more of the following switches:

<u>Use this switch</u>	<u>To do this</u>
<code>/E</code>	Tell Windows how much conventional memory must be available in order to use large-frame EMS mode. If there is less conventional memory available than the amount you specify, Windows starts in small-frame EMS mode instead of large-frame EMS mode.
<code>/L</code>	<p>Move the EMS bank line up or down by 1-kilobyte increments.</p> <p>To move the bank line up, specify the <code>/L</code> switch, followed by a plus sign (+) and the number of kilobytes you want to move the bank line. For example, to move the bank line up 16KB, you would specify the value <code>/l+16</code>.</p> <p>To move the bank line down, specify the <code>/L</code> switch, followed by a minus sign (-) and the number of kilobytes you want to move the bank line. For example, to move the bank line down 8KB, you would specify the value <code>/l-8</code>.</p> <p>(Because the EMS bank line exists only in large-frame EMS mode, the <code>/L</code> switch has no effect when Windows uses small-frame EMS mode.)</p>
<code>/N</code>	Prevent Windows from using any expanded memory. When running in real mode, Windows normally uses expanded memory if it is available.

Note that these switches have no effect when starting Windows in standard or 386 enhanced mode.

See Chapter 13, "Optimizing Windows," for more information on these switches and on expanded memory in general.

## ***Specifying a Run Command***

You can use the **RunCommand** portion of the Windows command line to run a particular application or command immediately after starting Windows. For example, the following command line starts Windows, then immediately runs Microsoft Excel as the foreground application:

```
win c:\excel\excel.exe
```

The **RunCommand** portion of the Windows command line is identical to the text you enter after choosing Run from the File menu in Program Manager or File Manager. See Chapter 2, “Basic Skills,” for more information on the Run command.

The **RunCommand** text must follow any switches you include on the Windows command line. For example, the following command line starts Windows in real mode, then immediately runs the application MYEDITOR.EXE:

```
win /r myeditor.exe
```

## ***Some Sample Windows Command Lines***

This section shows some command lines that illustrate the Windows start-up options.

### ***Sample 1: Starting Windows in Real Mode***

The following command line starts Windows in real mode:

```
win /r
```

### ***Sample 2: Starting Windows and an Application***

The following command line starts Windows, then immediately runs the application TEXTEDIT.COM:

```
win d:\editors\textedit.com
```

The command line tells Windows that the file TEXTEDIT.COM is located in the \EDITORS directory on drive D.

***Sample 3: Starting Windows and Editing a Document***

The following command line starts Windows in standard mode, then immediately opens the document AGENDA.TXT in Notepad:

*win /s agenda.txt*

The command line runs Notepad because Windows associates all files that have the .TXT filename extension with the Notepad application. You can change such file associations in File Manager by choosing the Associate command from the File menu. See Chapter 4, “File Manager,” for details.

***Sample 4: Starting Windows and Editing a Document***

The following command line starts Windows, then runs Microsoft Word and opens the Word document LETTER.DOC:

*win c:\word\word.com letter.doc*

***Sample 5: Preventing Windows from Using Expanded Memory***

The following command line starts Windows in real mode (/R) and prevents it from using any expanded memory (/N):

*win /r /n*

---

---

**Chapter**  
**12**

***More About Applications***

**Working with Different Types of Applications .....437**

- Windows Applications Designed for Windows 3.0 ..... 437
- Older Windows Applications ..... 437
- Non-Windows Applications ..... 440
- Memory-Resident Software ..... 442

**Working with PIFs and PIF Editor .....444**

- Installing Predefined PIFs ..... 445
- Copying PIFs from Other Disks ..... 445
- Starting PIF Editor ..... 446
- Changing PIF Modes ..... 447
- Managing PIFs ..... 448
- Creating PIFs for Batch Files ..... 448
- Changing the Standard PIF Settings ..... 449

**Specifying PIF Options for Standard Mode or Real Mode .....450**

- Program Filename ..... 451
- Window Title ..... 451
- Optional Parameters ..... 451
- Start-up Directory ..... 452
- Video Mode ..... 452
- Memory Requirements ..... 453
- XMS Memory ..... 454
- Directly Modifies ..... 455
- No Screen Exchange ..... 455

Prevent Program Switch .....	456
Close Window on Exit .....	456
Reserve Shortcut Keys .....	456
<b>Specifying Basic PIF Options for 386 Enhanced Mode .....</b>	<b>457</b>
Program Filename .....	458
Window Title .....	459
Optional Parameters .....	459
Start-up Directory .....	459
Memory Requirements .....	459
Display Usage .....	460
Execution .....	461
Close Window on Exit .....	462
<b>Specifying Advanced PIF Options for 386 Enhanced Mode .....</b>	<b>462</b>
Multitasking Options .....	463
Memory Options .....	465
Display Options .....	469
Other Options .....	472
<b>Changing Settings for a Running Application .....</b>	<b>476</b>
Display Options .....	477
Tasking Options .....	477
Priority Options .....	477
Terminate Option .....	478
<b>Freeing Up Memory .....</b>	<b>478</b>
Freeing Memory with Standard PIF Options .....	479
Freeing Memory with 386 Enhanced PIF Options .....	480
<b>If Things Go Wrong .....</b>	<b>482</b>
If You Get Out-of-Memory Messages .....	482
If You Cannot Switch from a Non-Windows Application .....	483
If Your Application Display Is Lost .....	484

If You Get Garbled Data When Using a Communications Application .....	485
If You Press a Key and the Unexpected Happens .....	485
If an Application Is Abnormally Slow .....	486
If You Cannot Take a Snapshot of the Screen .....	488
If You Cannot Paste Information Properly .....	488
If Your Application Remains on the Screen When You Close It ..	489
If You Cannot Quit an Application .....	489
If Your System Stops Responding or Terminates Unexpectedly ..	490



Vertical line on the left side of the page.

## ***Working with Different Types of Applications***

In Microsoft Windows, different types of applications behave differently. There are four basic types of applications:

- Windows applications designed for Windows 3.0
- Older Windows applications, designed for previous versions of Windows
- Non-Windows applications
- Memory-resident software

The following sections explain how to work with each type of application.

### ***Windows Applications Designed for Windows 3.0***

Windows applications are specifically designed to take advantage of Windows' features and to work with other Windows applications. All Windows applications require Windows in order to run.

Many Windows applications were designed to run with Windows 3.0. These applications can take advantage of the additional features and memory capacity that Windows 3.0 provides. To run such applications, use the techniques explained in Chapter 3, "Program Manager."

### ***Older Windows Applications***

Some Windows applications were designed for previous versions of Windows, and might not work correctly with Windows 3.0. If you have an older Windows application, the best thing to do is obtain an updated version of the application for Windows 3.0. Updates are already available for many Windows applications; for more information, check with your application's manufacturer.

This section explains how to tell if an application might be incompatible with Windows 3.0 and explains how to run such an application with Windows.

#### ***Identifying Older Windows Applications***

It can sometimes be difficult to tell, just by looking at a Windows application, whether it was designed for Windows 3.0 or for an earlier version of Windows. The most reliable way to detect an older Windows application is to try running it with Windows in standard or 386 enhanced mode.

Whenever you start a Windows application, if Windows is running in standard mode or 386 enhanced mode, Windows checks the application file to ensure that the application was designed for use with Windows 3.0. If the application was not designed for Windows 3.0, you'll see the following dialog box:

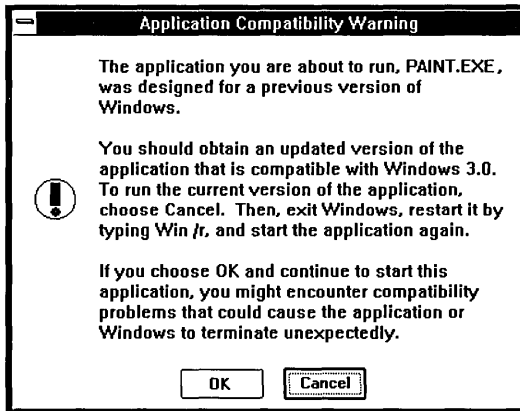

Windows displays this dialog box to warn you that the application might not run properly with Windows 3.0. In general, you should choose Cancel. If you choose OK, Windows will start the application even though it might not be compatible with Windows 3.0.

## ***Running Older Windows Applications***

In order to run an older Windows application with Windows 3.0 in standard mode or 386 enhanced mode, you should obtain an updated version of the application. Until you receive an update, you can still run the application with Windows 3.0, as long as you first start Windows in real mode. Older Windows applications should run successfully with Windows in real mode, since real mode is the operating mode used by previous versions of Windows.

**NOTE** When running in real mode, Windows behaves differently from when it is running in standard mode or 386 enhanced mode. For example, in real mode, Windows does not use extended memory; only your system's conventional and expanded memory is available to applications. For additional information about the differences between Windows operating modes, see the introduction to this guide.

▷ **To run an older application with Windows 3.0:**

1. Exit Windows if you are running in standard mode or 386 enhanced mode.
2. Start Windows in real mode by typing *win /r* at the DOS prompt.
3. Start the application as you would any Windows application.

When you run an older Windows application with Windows 3.0, you might encounter one or more of the following problems:

- The application's menus and dialog boxes might not display fonts correctly.
- The application might not display colors or color bitmaps correctly.
- If the application uses memory incorrectly and Windows is running in standard mode or 386 enhanced mode, the application or Windows might become unstable or terminate unexpectedly.

### ***Sharing Data Between Modes***

Sometimes you might want to exchange data between an application that runs only in real mode and an application that runs only in 386 enhanced mode. (Many older Windows applications can run only in real mode; some Windows applications designed for Windows 3.0 might require the additional memory that is available in standard mode or 386 enhanced mode.)

The procedure that follows explains how to exchange information between applications that require different Windows modes. (The basic techniques for sharing information are explained fully in Chapter 2, "Basic Skills.")

▷ **To transfer data between applications in different modes:**

1. Start Windows in the mode the first application requires.  
For example, if the first application requires real mode, you would start Windows by typing *win /r* at the DOS prompt.
2. Start the first application, and cut or copy the information you want to transfer to the Clipboard. See "Working with Applications" in Chapter 2 for more information.
3. Start Clipboard and save the information on the Clipboard to a file, as explained in "Working with Applications" in Chapter 2.
4. Exit from Windows.

5. Start Windows in the mode the second application requires.  
For example, if the second application requires 386 enhanced mode, you might start Windows by typing *win* (if your system supports 386 enhanced mode).
6. Choose Clipboard from the Main Group in Program Manager.
7. Start Clipboard and open the file you just created, as explained in “Working with Applications” in Chapter 2.
8. Leave Clipboard running, and start the application into which you want to paste the information.
9. Choose the Paste command in the Edit menu to move the information from the Clipboard into the application.

## Non-Windows Applications

A typical non-Windows application (called a standard application in previous versions of Windows) was not designed specifically for Windows. Such applications do not include Windows-type dialog boxes or other Windows-specific elements.

**386**

With 386 enhanced mode, you can run most non-Windows applications in a window. This makes it easy to share information between applications. You can also run multiple non-Windows applications simultaneously.

With real mode or standard mode, you can run non-Windows applications only in a full-screen display. You can start and switch among multiple non-Windows applications; however, while you are using a non-Windows application, Windows suspends other applications.

Because Windows applications use memory cooperatively, Windows can distribute memory among them as efficiently as possible. In contrast, a non-Windows application requests a certain amount of memory when it starts, and keeps that memory until you exit it. If you get an out-of-memory message when starting or running a non-Windows application, see “Freeing Up Memory,” later in this chapter, for information on making more memory available to the application.

### **Changing Settings for a Non-Windows Application**

Whenever you start a non-Windows application, Windows looks for that application’s *program information file*, or *PIF*. A PIF is a special file containing settings that tell Windows how to run a non-Windows application. A PIF’s filename usually matches that of the corresponding application. For example, the main application file for WordPerfect® has the filename WP.EXE; the corresponding PIF would be WP.PIF. When you start a non-Windows application

and Windows cannot find that application's PIF, Windows simply starts the application using the standard settings. Most applications run properly using the standard settings.

The following are some of the reasons you might want to change an application's settings:

- To change the pathname for the application.
- To change the start-up directory that contains the application's data files.
- To specify a program parameter for the application, or to be prompted for parameters whenever you start it.
- To give the application more memory so that it can run properly, or to enable it to run faster (386 enhanced mode only).

386

There are two ways to change an application's settings:

386

- In 386 enhanced mode, while an application is running, you can change certain settings by choosing Settings from the application's Control menu. Your changes will remain in effect until you quit the application. For details, see "Changing Settings for a Running Application" later in this chapter.
- In any Windows mode, you can make more permanent changes by using Windows PIF Editor to edit the application's PIF. If the application does not have a PIF, you can use PIF Editor to create one. For details, see "Working with PIFs and PIF Editor" later in this chapter.

### ***Running a Non-Windows Application from Its PIF***

You can run most non-Windows applications using the standard procedures described in Chapter 3, "Program Manager." You can also run a non-Windows application directly from its PIF. The PIF tells Windows where to find the file that starts the application, and provides other information that determines how the application starts and runs.

You can run an application directly from its PIF just as you can from the application's .EXE file. For example, in File Manager, you can start an application by double-clicking its PIF filename. You can also add a PIF to a Program Manager group just as you would an application. When you do so, specify the PIF's filename, including the .PIF extension, as the application command line.

You can then run that application directly from its PIF. The advantage of running an application from its PIF is that, when you do so, Windows starts and runs the

application using the values in that particular PIF. This can be useful if you have several PIFs for a single application.

### ***Using Multiple PIFs for the Same Application***

Sometimes, you might want to create more than one PIF for an application—for example, to specify different start-up directories for different types of work. In one case, you might want to run a word processing application that starts in a directory with business documents; in another case, you might want to start the same application in a directory that contains personal correspondence.

To set up the word processing application to start in two different directories, you would create two PIFs and assign different directories with the Start-up Directory option. Then, you would save each PIF with a distinguishing name (for example, BUSINESS.PIF and PERSONAL.PIF). Lastly, you would add each PIF to Program Manager and give each PIF a distinguishing title (for example, “Word Processing—Business” and “Word Processing—Personal”). You could then choose either of the resulting application icons to start the word processor. Choosing one would start the word processor in your business directory; choosing the other would start the word processor in your personal correspondence directory.

## ***Memory-Resident Software***

Memory-resident software is loaded into memory when you start it, and is then available whenever you need it, even when another application is running. Memory-resident software comes in two forms:

- Utility software, such as a mouse driver or network software, that loads when you start your computer.

Normally, you do not interact directly with such utilities; however, they are necessary in order to use certain hardware (such as a mouse or network). In addition, some applications require special memory-resident utility software.

- Applications known as *pop-up programs*.

Once you start a pop-up program, it loads into memory, but remains invisible until you press the key combination that displays the program. At that point, the program’s menus or prompts appear, and it temporarily suspends any other applications that were running. When you dismiss the pop-up program, it disappears again, and you resume your previous task.

The following sections explain how to use each type of memory-resident software with Windows.

### ***Using Memory-Resident Utilities with Windows***

Typically, you do not interact directly with memory-resident utilities such as networks and hardware drivers. However, many applications require such utilities in order to work properly. For example, an electronic mail application might require a memory-resident network driver in order to function.

If you want a memory-resident utility to be available to all Windows and non-Windows applications, you should start it before you start Windows. The utility will then be available to all applications you run with Windows; however, it will also take memory away from all applications. In general, most memory-resident utilities should be started from your CONFIG.SYS or AUTOEXEC.BAT files. (These files are usually located in your hard disk's root directory. They tell MS-DOS what commands and utilities to run when starting your computer.)

If only a particular application requires a memory-resident utility, you might want to use a different method to start that utility, so that the utility will not take away memory from other applications. There are two ways to do this:

- If only a particular non-Windows application needs the memory-resident utility, you can create an MS-DOS batch file that starts first the utility and then the application. You would then run that batch file from Windows. For more information on using batch files with Windows, see “Creating PIFs for Batch Files” later in this chapter.
- If only a particular Windows application needs the memory-resident utility, you might want to start the utility from the special batch file WINSTART.BAT. When you start a utility from this batch file, the utility will be available to Windows applications, but not to non-Windows applications. This prevents the utility from taking memory away from non-Windows applications. For more information on using WINSTART.BAT, see Chapter 13, “Optimizing Windows.”

386

### ***Running Pop-Up Programs with Windows***

You should start pop-up programs, such as Borland's SideKick, directly from Windows. You can then switch to and from that program as you would any non-Windows application.



▷ **To use a pop-up program with Windows:**

1. If necessary, create a PIF for the pop-up program as you would for any non-Windows application. The following section, “Working with PIFs and PIF Editor,” explains how to do this.
2. Start the pop-up program as you would any application—for example, by installing it as an item in Program Manager, then double-clicking its icon. Chapter 3, “Program Manager,” explains how to install and start applications. When you start the pop-up program, Windows displays a message confirming that the program has been loaded.
3. To use the pop-up program, press the appropriate key combination to “pop up” the program, just as you would if you were not running it with Windows.  
A few pop-up programs require a key combination that is usually reserved for Windows (for example, ALT + ESC). In that case, you might want to edit the pop-up program’s PIF and select the Reserve Shortcut Keys option for that key combination. If you do so, pressing that key combination will display the pop-up program instead of performing the usual Windows function.  
You can also switch to a pop-up program using normal Windows methods, rather than by pressing the key combination that usually pops up the program.

It can sometimes be useful to load a pop-up program only when you use another application. For example, you might want to load Borland’s SideKick in conjunction with the Framework II © application. Sidekick would then be available from Framework II, and would not take away memory from other applications. To load a pop-up program in conjunction with another application, you would create a batch file that starts first the pop-up program and then the application. For additional information on creating a batch file and running it with Windows, see “Creating PIFs for Batch Files” later in this chapter.

## ***Working with PIFs and PIF Editor***

Whenever you start a non-Windows application, Windows looks for that application’s PIF. As explained earlier in “Changing Settings for a Non-Windows Application,” a PIF is a special file containing settings that tell Windows how to run a non-Windows application. If Windows cannot find a PIF for the application, it simply starts the application using the standard settings. Because most applications run properly using the standard settings, many applications never need a PIF of their own.

However, if an application does not run properly, or if it does not run the way you want it to, you might want to change that application's PIF using PIF Editor. If the application does not have a PIF, you can use PIF Editor to create one.

An application's PIF can come from any of the following sources:

- Windows Setup might create a predefined PIF for that application.
- The application might come with its own predefined PIF.
- You can create a PIF for the application using PIF Editor.

The rest of this section explains how to install, copy, and create PIFs.

## ***Installing Predefined PIFs***

Windows creates predefined PIFs for many popular applications. When you use Setup to install a non-Windows application, it automatically creates and installs a predefined PIF for that application in your personal Windows directory. For information on using Setup to install existing applications, see "Changing the Contents of a Group" in Chapter 3.

When you use Setup to install existing applications, it searches the drive(s) you specify and lists any applications it found on those drives. Setup lists only Windows applications and applications for which Windows includes predefined PIF information. If the application you want is not on Setup's list, Windows does not provide a predefined PIF for that application. You can still install the application from Program Manager, and it will probably run normally even without a PIF. If the application doesn't run the way you want it to, create a PIF for it using PIF Editor.

## ***Copying PIFs from Other Disks***

Your application might come with its own PIF. Check the application documentation or the application disks themselves for a file with the .PIF extension.

Some applications come with PIFs that are designed for IBM's TopView® system. You can use a TopView PIF in the same way that you use a Windows PIF. You can also use the advanced settings available for Windows PIFs by opening the TopView PIF in PIF Editor and saving it again.

▷ **To copy a PIF from another disk to your Windows directory:**

---

1. Insert the disk that contains the PIF into drive A.
2. Start File Manager.
3. Choose the A disk-drive icon.
4. Double-click the A:\ directory icon or press ENTER.  
File Manager lists the files on the disk. Look for the appropriate file with the .PIF filename extension.
5. Select the PIF you want to copy, and choose Copy from the File menu.  
File Manager displays a dialog box.
6. Type the destination directory in the To box. In general, you should install PIFs in your Windows directory, but you can also install a PIF in the same directory as the associated application file.
7. Choose Copy.  
Windows displays a message when it has finished copying the PIF.

Add the application to Program Manager as you would any application. When you start the application, Windows looks for that application's PIF. A typical PIF's filename matches the associated application (for example, the PIF for MYAPP.COM would be MYAPP.PIF).

If the application does not run properly, you might have to change the settings in its PIF. For more information, see the sections on PIF options later in this chapter.

## ***Starting PIF Editor***

▷ **To start PIF Editor:**

---

1. Choose the Accessories Group from the Program Manager window.
2. Choose the PIF Editor icon from the Accessories Group window.  
PIF Editor displays a new, untitled PIF that contains the standard settings. (To edit an existing PIF, choose Open from the File menu, and specify the PIF you want.)  
Changing the PIF settings can affect how and whether the application runs. For more information, see the sections on PIF options later in this chapter.

## Changing PIF Modes

Each PIF contains two sets of options:

- The Standard options are for running the application with Windows in real mode or standard mode.
- The 386 Enhanced options are for running the application with Windows in 386 enhanced mode.

When you start PIF Editor, it automatically displays the correct options for the mode you are running Windows in.

Occasionally, you might want to specify PIF options for a mode you are not currently running Windows in. For example, you might be running Windows in 386 enhanced mode, but want to set PIF options for an application that runs only in real mode. In that case, you would want to change the PIF options before creating a PIF for that application.

**NOTE** Most options have effect only in the mode for which they are entered. For example, you can enter two different values for the Optional Parameters option: one for use with real or standard mode and one for use with 386 enhanced mode. However, a few options, such as Program Filename and Window Title, are common to both modes.

### ▷ To display different PIF options:

---

- Choose the mode you want (Standard or 386 Enhanced) from the Mode menu in PIF Editor. For running an application in real mode, choose Standard.  
If you choose the mode you are not currently running, PIF Editor displays a message warning you that these are the wrong options for the current mode. If you really want to switch PIF modes, choose OK.  
PIF Editor displays the options for the mode you chose.

For information on how to specify PIF options, refer to the appropriate sections later in this chapter.

## Managing PIFs

You create, edit, and save PIFs just as you would any Windows file. For example, to create a new PIF, you would start PIF Editor, choose New from the File menu, edit the PIF options, and save the new PIF with a new filename. You could also create a new PIF by opening an existing PIF, editing it, and saving the changed PIF with a new filename.

Typically, a PIF has the same filename as the associated application file, except that a PIF has a .PIF filename extension. You should save PIFs in your Windows directory or in the directory that contains the associated application file.

## Creating PIFs for Batch Files

You can create a PIF for an MS-DOS batch file you want to run with Windows. An MS-DOS batch file is a text file that contains MS-DOS commands. When you run a batch file, MS-DOS executes each command in the file. A batch file can be particularly useful for running other commands before or after running a non-Windows application. For example, the commands in a batch file might first load a memory-resident program the application needs, then run the application itself. The following is a sample batch file called SKFWLOAD.BAT, which you could create using Notepad:

```
SK.COM  
FW.EXE
```

The first line in the batch file loads a pop-up program, SideKick (SK.COM). The second line starts the application Framework II (FW.EXE).

To run the batch file with Windows, you would create a PIF for it.

### **To create a PIF for a batch file:**

---

1. Choose the PIF Editor icon from the Accessories Group window.
2. Type the filename of the batch file in the Program Filename text box. Include the .BAT extension.  
To use the sample batch file discussed previously, you would type *skfwload.bat* in the text box.
3. Set other PIF options as appropriate. The options you set affect all applications that the batch file starts.
4. Choose Save As from the File menu.

5. Choose OK to use the PIF filename that PIF Editor suggests. Or type a filename for the PIF in the Filename text box, including the .PIF extension.  
Run the batch file by choosing that PIF just as you would choose an application. For example, you could add the PIF to a Program Manager group, then choose it from that group. Or you could start File Manager, then double-click the PIF's filename.

## Changing the Standard PIF Settings

When you start a non-Windows application and Windows cannot find a PIF for that application, it starts the application using the standard settings. You can override these settings by creating a PIF with the filename `_DEFAULT.PIF`. You might want to override the standard settings if, for example, you are running in 386 enhanced mode and you want all applications without PIFs to start in a window rather than in a full-screen display.

### ▷ To override the standard PIF settings:

1. Choose the PIF Editor icon from the Accessories Group window.
2. Change the settings until they appear the way you want them. (Leave the Window Title option blank.)
3. Type a valid program pathname in the Program Filename text box.  
For example, you might type `c:\command.com`.

Windows ignores certain settings, such as Program Filename, when it starts an application using the settings in `_DEFAULT.PIF`. However, because PIF Editor verifies the contents of these fields when you save the PIF, you must still provide complete, valid settings.

4. Choose Save As from the File menu.
5. Type `_default.pif` in the Filename text box, and choose OK.

From now on, whenever Windows cannot find an application's PIF, it will start the application using the settings in your `_DEFAULT.PIF` file, rather than using Windows' standard PIF settings. You can change your standard settings by editing the file `_DEFAULT.PIF` as you would any PIF. To restore Windows' standard settings, just delete the file `_DEFAULT.PIF`.

**NOTE** The settings in `_DEFAULT.PIF` do not affect the settings PIF Editor displays for a new, untitled PIF (the settings you see when you choose New from the File menu). PIF Editor always uses Windows' standard PIF settings when creating an untitled PIF.

## ***Specifying PIF Options for Standard Mode or Real Mode***

As explained earlier in “Non-Windows Applications,” you do not normally need a PIF to run a non-Windows application. However, to change the way a non-Windows application runs with Windows, you can create a PIF for that application (or edit its PIF, if it has one). You create and edit PIFs using PIF Editor.

A PIF contains two sets of options: Standard options and 386 Enhanced options. This section explains how to specify the Standard options. Use these options for running an application with real mode or standard mode.

If you are currently running Windows in real mode or standard mode, PIF Editor displays the Standard options automatically. (If you are running Windows in 386 enhanced mode, you can display the Standard options by choosing Standard from the Mode menu.) For more information on modes and PIF options, see “Changing PIF Modes” earlier in this chapter.

The Standard options appear as follows:

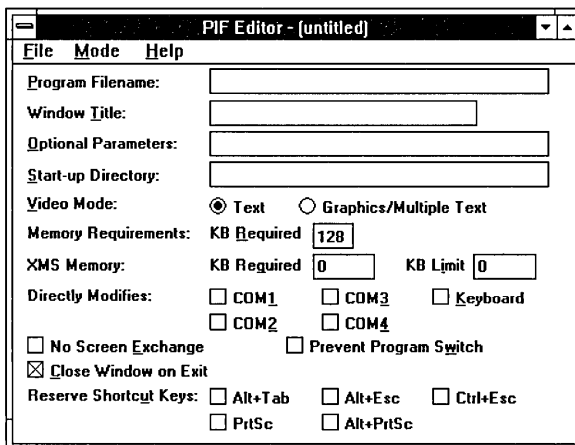

The screenshot shows the PIF Editor window titled "PIF Editor - (untitled)". The window has a menu bar with "File", "Mode", and "Help". The main area contains the following options:

- Program Filename: [text box]
- Window Title: [text box]
- Optional Parameters: [text box]
- Start-up Directory: [text box]
- Video Mode:  Text  Graphics/Multiple Text
- Memory Requirements: KB Required [128]
- XMS Memory: KB Required [0] KB Limit [0]
- Directly Modifies:  COM1  COM3  Keyboard  
 COM2  COM4
- No Screen Exchange  Prevent Program Switch
- Close Window on Exit
- Reserve Shortcut Keys:  Alt+Tab  Alt+Esc  Ctrl+Esc  
 PrtSc  Alt+PrtSc

### **PIF options for standard mode or real mode**

The rest of this section explains each of the Standard options.

## Program Filename

In the Program Filename text box, type the pathname of the file that starts the application. (Windows will use this pathname for starting the application in 386 enhanced mode as well as in standard mode and real mode.)

For most applications, you can type the pathname of the main application file, which usually has the extension .EXE or .COM. For example, to create a PIF for Microsoft Word, you would type *c:\word\word.com*, since you start Word using the file WORD.COM.

If you start the application from a batch file, type the pathname of the batch file, which usually has the .BAT extension. See “Creating PIFs for Batch Files,” earlier in this chapter, for more information on batch files.

You must make an entry in this box.

## Window Title

You can type a descriptive name in the Window Title text box. For example, you might type *IBM Writing Assistant* if you were creating a PIF for that application. The name you type will appear under the application’s icon when the application is minimized. (The application will have the same title when running in 386 enhanced mode.)

This entry is optional. If you leave the Window Title box blank, when the application is minimized, its icon title will contain the application’s filename without the extension.

## Optional Parameters

You can type any application parameters in the Optional Parameters text box. These are the same parameters you type after the application’s filename when starting the program from MS-DOS. For example, if you normally type *word /c* when you start Microsoft Word from MS-DOS, you would type */c* in this box.

Parameters can be filenames, letters, numbers, or any type of information up to 62 characters in length. See the application documentation for valid parameters.

If you want Windows to prompt you for parameters whenever you start the application, type a question mark (?) in this box.



This entry is optional. If the application does not require parameters, or if you do not want to use any parameters when you start this application, leave this box blank.

**NOTE** To use parameters other than the ones you specify in this text box, start the application by choosing Run from the File menu in Program Manager or File Manager. This gives you the opportunity to enter alternate parameters. In that case, the application uses those alternate parameters, not the parameters in the application's PIF.

## ***Start-up Directory***

You can type a pathname in the Start-up Directory text box to specify the drive and directory that you want Windows to make current when the application is started. Some applications require access to certain files in a particular directory. This box lets you tell Windows to start the application in the directory that contains the required files.

Although this entry is optional, it is a good idea to specify a start-up directory. For most applications, you can specify the drive and directory that contains the application file.

## ***Video Mode***

Use the Video Mode options to tell Windows how the application uses the display. The video mode determines how much memory Windows sets aside for storing the contents of the application's display. When you switch away from the application, Windows saves the application's display so that it is restored correctly when you return to the application.

The memory that Windows reserves for the application's display comes out of the memory allocated to the application. Therefore, the more memory the application's display requires, the less memory is available for the application itself.

You can select from two video modes: Text and Graphics/Multiple Text. Text requires less memory than Graphics/Multiple Text. You can select one of the following modes:

<u>Use this option</u>	<u>To do this</u>
Text	Tell Windows that the application will be running only in normal text mode. Text mode uses the least memory; therefore, to make the most memory available to the application, you might want to choose this option, and then run the application solely in text mode.
Graphics/ Multiple Text	Tell Windows that the application will run in graphics mode, or that it will use more than one text screen's worth of display memory. The Graphics/Multiple Text option uses more memory than the Text option; however, choosing this option ensures that enough video memory will be available when you switch back and forth between modes.  ( <i>Multiple text</i> refers to text-mode applications that use more than one video page to display text, and therefore need more video memory than typical text-mode applications. Some BASIC programs use this mode.)

You can make more memory available to the application by selecting the Text option. However, if you are not sure which video mode to use, select Graphics/Multiple Text. This option is the safest. If the application needs the Graphics mode, but the Text option is selected, you will not be able to switch away from the application; the only way to get back to Windows would be to quit the application.

## ***Memory Requirements***

Use the Memory Requirements: KB Required text box to tell Windows how many kilobytes of conventional memory must be free in order to start the application. In general, you should leave this setting at the standard of 128.

Regardless of what you type in the KB Required text box, when you start the application, Windows gives it all available conventional memory. The number in this text box simply determines how much memory must be available before Windows will even try to start the application; it does not limit how much conventional memory the application receives.

If Windows cannot provide as much memory as you specify, when you try to start the application, you will see a message telling you that there is not enough memory to run the application. For more information about specifying memory options and fine-tuning memory requirements, see "Freeing Up Memory" later in this chapter.

**NOTE** A typical application's documentation tells you its system memory requirements. However, this number is usually an estimate of the total amount of system memory you'll need to run the application; rarely is it an accurate description of exactly how much free memory the application really needs.

## ***XMS Memory***

Use the XMS Memory options to tell Windows how much extended memory to give to an application that uses memory according to the Lotus®-Intel-Microsoft-AST® eXtended Memory Specification (XMS) standard. Because very few applications use extended memory, you can usually leave these options at their standard settings. Lotus 1-2-3® version 3.0 is an example of a non-Windows application that does use extended memory. (For more information about extended memory, see Chapter 13, "Optimizing Windows.") The following list explains each option:

<u>Use this option</u>	<u>To do this</u>
KB Required	<p>Tell Windows how many kilobytes of extended memory must be free in order to start the application.</p> <p>Leave this setting at 0 for most applications. Specifying a value other than 0 will dramatically increase the time it takes to switch to and from the application. You should specify a value only if the application requires a certain amount of extended memory in order to run.</p>
KB Limit	<p>Tell Windows how many kilobytes of extended memory it should permit the application to use.</p> <p>This option is useful for limiting an application's access to extended memory, since some applications will take all available extended memory whether they need it or not.</p> <p>Leave at 0 to prevent the application from gaining access to any extended memory.</p> <p>Setting this option to -1 gives the application all the extended memory it requests (up to the maximum amount available). Set this option to -1 only if the application requires large amounts of extended memory. In general, it is not a good idea to set this option to -1, since it slows your system down dramatically.</p>

To prevent the application from using any extended memory, leave both XMS Memory options at the standard setting of 0.

## ***Directly Modifies***

Use the Directly Modifies options to tell Windows that the application uses certain system resources in a way that prevents sharing those resources with other applications. For example, some communications applications take control of the communications port they are using, to the exclusion of other applications. The following list explains each option:

<u>Use this option</u>	<u>To do this</u>
COM1, COM2, COM3, COM4	Tell Windows which communications port(s) the application uses. This information lets Windows prevent two applications from trying to use the same communications port at once (which can result in garbled or lost data).
Keyboard	<p>Tell Windows that because the application takes direct control of the keyboard, Windows will be unable to respond to any shortcut keys you press while you're using the application. This means that you will be unable to switch away from the application or copy its screen onto the Clipboard.</p> <p>Selecting this option can make more memory available to the application, since Windows can then assume that it does not need to save the application's current state or display.</p>

Selecting any of the Directly Modifies options is similar to selecting the Prevent Program Switch option; you will have to quit the application in order to get back to Windows or other applications. If you are uncertain, do not select these options.

## ***No Screen Exchange***

You can conserve memory by selecting the No Screen Exchange option. If you select this option, you will not be able to copy information from the application's window onto the Clipboard using ALT + PRINT SCREEN or PRINT SCREEN. If you are uncertain, do not select this option.

The effect of selecting this option is similar to what happens if you select both the PrtSc and Alt+PrtSc check boxes in the Reserve Shortcut Keys options.

## ***Prevent Program Switch***

You can conserve memory by selecting the Prevent Program Switch option. If you select this option, you will not be able to switch from this application; to use Windows or other applications, you will have to first quit this application. If you are uncertain, do not select this option.

The effect of selecting this option is similar to what happens if you select all the Reserve Shortcut Keys options, or select any of the Directly Modifies options.

## ***Close Window on Exit***

You can use the Close Window on Exit option to close the application's display and return to Windows automatically when you exit the application, rather than leaving the information on the screen. If this option is not selected and you are running the application in text mode, you will see a message reminding you to press any key to resume your Windows session. If you are running the application in graphics mode, you will not see a message; however, pressing any key will clear the screen and continue your Windows session.

## ***Reserve Shortcut Keys***

Use the Reserve Shortcut Keys options to specify the key combinations you want to use for the application, rather than as Windows shortcut keys.

Normally, when you type a Windows shortcut key combination, Windows executes that shortcut key's assigned action; the application never registers that you pressed those keys. However, sometimes you might want to use a shortcut key combination within an application.

Selecting one or more of the Reserve Shortcut Keys options tells Windows to ignore the specified key combination when the application is running in the foreground, and instead let the application respond to the key combination. For example, suppose your word processing application uses the key combination ALT + TAB to insert a special character. When you run the word processor with Windows, pressing ALT + TAB would switch to another application, rather than inserting the special character in your word processor. In order to use ALT + TAB in your word processor, you could edit your word processor's PIF and select the Reserve Shortcut Keys option for the ALT + TAB shortcut key. Thereafter, when using your word processor with Windows, pressing ALT + TAB would insert the special character rather than switch to a different application. (When using other

applications, the key combination ALT + TAB would still act as a normal Windows shortcut key.)

The following list explains each option and describes how Windows uses each shortcut key:

<u>Use this option</u>	<u>To do this</u>
Alt+Tab	Reserve the ALT + TAB shortcut key for the application. Otherwise, Windows toggles between applications when you press this key combination.
Alt+Esc	Reserve the ALT + ESC shortcut key for the application. Otherwise, Windows switches to the next application when you press this key combination.
Ctrl+Esc	Reserve the CTRL + ESC shortcut key for the application. Otherwise, Windows displays the Task List when you press this key combination.
PrtSc	Reserve the PRINT SCREEN shortcut key for the application. Otherwise, Windows copies a full screen onto the Clipboard when you press this key.
Alt+PrtSc	Reserve the ALT + PRINT SCREEN shortcut key for the application. Otherwise, Windows copies a full screen onto the Clipboard when you press this key combination.

## ***Specifying Basic PIF Options for 386 Enhanced Mode***

**386**

As explained earlier in “Non-Windows Applications,” you do not normally need a PIF to run a non-Windows application. However, to change the way a non-Windows application runs with Windows, you can create a PIF for that application (or edit its PIF if it has one). You create and edit PIFs using PIF Editor.

A PIF contains two sets of options: Standard options and 386 Enhanced options. Use the 386 Enhanced options to determine how the application will run with 386 enhanced mode. (For an application you will run with real mode or standard mode, use the Standard options instead.)

The 386 Enhanced options appear in two categories: basic and advanced. The basic options are similar to the PIF options for standard mode. The advanced options fine-tune the way the application runs with 386 enhanced mode. This

section explains each of the basic options for running an application with 386 enhanced mode. For more information on modes and PIF options, see “Changing PIF Modes” earlier in this chapter.

If you are currently running Windows in 386 enhanced mode, PIF Editor displays the 386 Enhanced options automatically. (If you are running Windows in real mode or standard mode, you can display the 386 Enhanced options by choosing 386 Enhanced from the Mode menu.)

The basic options for 386 enhanced mode appear as follows:

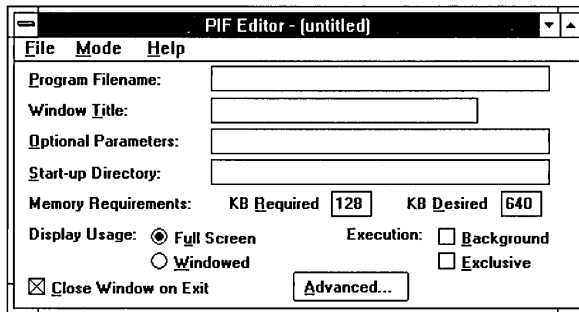

**PIF options for 386 enhanced mode**

## ***Program Filename***

In the Program Filename text box, type the pathname of the file that starts the application. (Windows will use this pathname for starting the application in standard mode and real mode as well as in 386 enhanced mode.)

For most applications, you can type the pathname of the main application file, which usually has the extension .EXE or .COM. For example, to create a PIF for Microsoft Word, you would type *c:\word\word.com*, since you start Word using the file WORD.COM.

If you start the application from a batch file, type the pathname of the batch file, which usually has the .BAT extension. See “Creating PIFs for Batch Files,” earlier in this chapter, for more information on batch files.

## Window Title

You can type a descriptive name in the Window Title text box. For example, you might type *IBM Writing Assistant* if you were creating a PIF for that application. The name you type will appear in the window's title bar, and under its icon when the application is minimized. (The application will have the same title when running in real mode or standard mode.)

This entry is optional. If you leave the Window Title box blank, when the application is running with 386 enhanced mode, its title bar will contain the application's filename without the extension.

## Optional Parameters

This option is identical to the corresponding Standard option; for information, see "Specifying PIF Options for Standard Mode or Real Mode" earlier in this chapter.

**NOTE** The optional parameters you enter when PIF Editor is displaying the 386 Enhanced options apply to 386 enhanced mode only. This means that you can enter different parameters for running the same application in real or standard mode, and for running it in 386 enhanced mode.

## Start-up Directory

This option is identical to the corresponding Standard option; for information, see "Specifying PIF Options for Standard Mode or Real Mode" earlier in this chapter.

## Memory Requirements

Use the Memory Requirements text boxes to allocate conventional memory to the application.

**NOTE** The Memory Requirements options refer to the amount of free memory the application needs. When setting these options, do not use the memory requirements listed in the application's documentation. Such "requirements" usually refer to the total amount of memory your system should have, not to the amount of memory that must be free in order for the application to run. Application manufacturers normally specify more memory than the application actually needs; this ensures that your system will have enough memory to run MS-DOS, the utilities in your CONFIG.SYS and AUTOEXEC.BAT files, and the application.



The following list explains each Memory Requirements option:

<u>Use this option</u>	<u>To do this</u>
KB Required	<p>Tell Windows how many kilobytes of conventional memory must be free in order to start the application. In general, you should leave this setting at the standard of 128.</p> <p>Windows will start the application only if there is at least as much free memory as the KB Required option specifies. Otherwise, you will see a message telling you that there is not enough memory to run the application. If other applications are running, you can close one or more of them and try running the application again. For more information about making more memory available, see “Freeing Up Memory” later in this chapter.</p> <p>The KB Required option does not limit how much memory the application receives; Windows gives it as much memory as possible, up to the limit set by the KB Desired option.</p> <p>Set this option to -1 to give the application all available conventional memory.</p>
KB Desired	<p>Limit the amount of conventional memory Windows will give the application. Windows will give an application up to, but no more than, the amount of memory you specify in this box. The standard of 640K provides the maximum amount of conventional memory any application can use.</p> <p>You might want to set KB Desired to an amount less than 640K in order to reserve more memory for other applications.</p> <p>A setting of -1 tells Windows to give this application as much memory as possible, up to the maximum of 640K.</p>

## ***Display Usage***

Use the Display Usage options to tell Windows how to display the application when you start it. You can select one of the following options:

<u>Use this option</u>	<u>To do this</u>
Full Screen	Start the application in a full-screen display rather than in a window. The application retains mouse support.
Windowed	Start the application in a window. Mouse support goes to Windows, not to the application. Running an application in a window takes more memory than running it in a full screen. However, you gain the advantages of running in a window, including easily sharing information between applications.

Once the application is running, you can move it from a window to a full-screen display, or vice versa, by pressing ALT + ENTER.

## ***Execution***

Use the Execution options to control when the application can run and how it cooperates with other applications. The following list explains each option:

<u>Use this option</u>	<u>To do this</u>
Background	Allow the application to run while you are using another application. For example, a communications program might run in the background, accepting information from another computer, while you work with a word processing application. If you do not select this option, the application will be suspended when you switch to another application.
Exclusive	<p>Suspend other applications while this application is in the foreground (even if the other applications have their Background options selected). Selecting this option can give this application more memory and processor time.</p> <p>You can set this option both for applications that run in a window and those that run in a full screen. It is best to run exclusive applications in a full screen, since this gives them the full benefit of using the Exclusive option. When you run an exclusive application in a window, Windows reserves some resources for itself and for running Windows applications.</p>

## ***Close Window on Exit***

Normally, when you quit a non-Windows application, Windows closes the application's window automatically. Clear this option if you want Windows to leave the application's window on the screen after you quit the application.

# ***Specifying Advanced PIF Options for 386 Enhanced Mode***

**386**

The PIF options for 386 enhanced mode appear in two categories: basic and advanced. The basic options are similar to the Standard PIF options; see the preceding section for more information.

The advanced PIF options let you fine-tune how the application runs with 386 enhanced mode and how it uses memory and other system resources. In most cases, you will not need to change the advanced options; you can simply leave them with the standard settings. If you plan to change these options, it is best to be familiar with memory issues, Windows, and the applications you use. Some of the technical concepts discussed in this section are described in more detail in Chapter 13, "Optimizing Windows."

### **▷ To display the advanced PIF options for 386 enhanced mode:**

- Choose the Advanced button at the bottom of the PIF Editor window.  
PIF Editor displays a dialog box with the advanced options. The advanced options appear as follows:

Advanced Options	
<b>Multitasking Options</b>	
Background Priority: <input type="text" value="50"/>	Foreground Priority: <input type="text" value="100"/>
<input checked="" type="checkbox"/> Detect Idle Time	
OK	
Cancel	
<b>Memory Options</b>	
EMS Memory: KB Required <input type="text" value="0"/>	KB Limit <input type="text" value="1024"/> <input type="checkbox"/> Locked
XMS Memory: KB Required <input type="text" value="0"/>	KB Limit <input type="text" value="1024"/> <input type="checkbox"/> Locked
<input checked="" type="checkbox"/> Uses High Memory Area <input type="checkbox"/> Lock Application Memory	
<b>Display Options</b>	
Video Memory: <input checked="" type="radio"/> Text <input type="radio"/> Low Graphics <input type="radio"/> High Graphics	
Monitor Ports: <input type="checkbox"/> Text <input type="checkbox"/> Low Graphics <input checked="" type="checkbox"/> High Graphics	
<input checked="" type="checkbox"/> Emulate Text Mode <input type="checkbox"/> Retain Video Memory	
<b>Other Options</b>	
<input checked="" type="checkbox"/> Allow Fast Paste	<input type="checkbox"/> Allow Close When Active
Reserve Shortcut Keys: <input type="checkbox"/> Alt+Tab <input type="checkbox"/> Alt+Esc <input type="checkbox"/> Ctrl+Esc	
<input type="checkbox"/> PrtSc <input type="checkbox"/> Alt+PrtSc <input type="checkbox"/> Alt+Space	
<input type="checkbox"/> Alt+Enter	
Application Shortcut Key: <input type="text" value="None"/>	

### Advanced PIF options for 386 enhanced mode

The advanced options are divided into four groups: Multitasking Options, Memory Options, Display Options, and Other Options. The sections that follow explain each group of options.

## Multitasking Options

Use the Multitasking options to determine how the application will run in relationship to other applications. The Multitasking options appear as follows:

<b>Multitasking Options</b>	
Background Priority: <input type="text" value="50"/>	Foreground Priority: <input type="text" value="100"/>
<input checked="" type="checkbox"/> Detect Idle Time	

### Advanced PIF options: Multitasking

The following sections explain each Multitasking option.

## ***Background Priority***

Use the Background Priority text box to specify how much processor time the application should receive when it is running in the background. The application will receive this priority only when its Background option is selected and the foreground application's Exclusive option is not selected.

You can specify a value from 0 to 10000; the standard background priority is 50. The figure you specify is meaningful only when compared to other applications' background and foreground priorities; it refers to the amount of computer processor time the applications use.

For example, suppose you have four applications running. One application is running in the foreground with a foreground priority of 200. The other three applications are running in the background with a background priority of 50 each. The total priority of all four applications is 3 times 50 (the background priorities), plus 200 (the foreground priority), or 350. Of this total, the foreground application will get 200 out of 350, or 57 percent of the processor time. Each of the background applications will get 50 out of the total of 350, or one-seventh of the processor time.

**NOTE** While an application is running, you can change its priorities by changing options in the Control menu. See "Changing Settings for a Running Application" later in this chapter.

## ***Foreground Priority***

Use the Foreground Priority text box to specify how much processor time you want the application to receive when it is running in the foreground. You can specify a value from 0 to 10000; the standard foreground priority is 100.

The figure you specify is meaningful only when compared to other applications' background and foreground priorities; it refers to the amount of computer processor time the applications use. For more information on how Windows interprets application priorities, see the preceding section, "Background Priority."

## Detect Idle Time

Select the Detect Idle Time option to let Windows give resources to other applications while this application is idle—that is, waiting for input from you.

Leave this option selected except in rare cases; this enhances the performance of the entire system.

If an application is running extremely slowly, it is possible that Windows might incorrectly consider it to be idle. Try clearing this option to speed up such an application.

## Memory Options

The advanced PIF options include options that control how the application uses the computer's available memory when running with 386 enhanced mode. The Memory options appear as follows:

Memory Options			
EMS Memory:	KB Required	<input type="text" value="0"/>	KB Limit <input type="text" value="1024"/> <input type="checkbox"/> Locked
XMS Memory:	KB Required	<input type="text" value="0"/>	KB Limit <input type="text" value="1024"/> <input type="checkbox"/> Locked
<input checked="" type="checkbox"/> Uses High Memory Area		<input type="checkbox"/> Lock Application Memory	

### Advanced PIF options: Memory

The following sections explain each Memory option.

### EMS Memory

Although Windows uses only extended memory when running in 386 enhanced mode, it simulates expanded memory for applications that use expanded memory. Use the EMS Memory options to specify how much expanded memory Windows should provide to the application. Although few applications actually require expanded memory, many run better if they can use it. (See Chapter 13, "Optimizing Windows," for an explanation of the different types of memory.)

The following list explains each EMS Memory option:

**Use this option**

**To do this**

KB Required

Tell Windows how many kilobytes of expanded memory it must be able to provide in order to start the application. In general, you can leave this option at the standard setting of 0, which tells Windows that this application does not require expanded memory.

The KB Required option does not limit how much expanded memory the application receives; Windows gives it as much expanded memory as the application requests, up to the limit set by the KB Limit option (or until no more memory is available).

Windows will start the application only if it can provide at least as much expanded memory as the KB Required option specifies. Otherwise, Windows displays a message telling you that there is not enough memory to run the application. If other applications are running, you can close one or more of them and try running the application again. For more information about making more memory available to the application, see “Freeing Up Memory” later in this chapter.

KB Limit

Limit the amount of expanded memory Windows will provide to the application. Windows will give an application as much expanded memory as it requests, up to the amount you specify in this text box (or until no more memory is available).

This option is useful for limiting an application’s access to expanded memory, since some applications will take all available expanded memory whether they need it or not.

To prevent Windows from providing any expanded memory to the application, set this option to 0.

The standard setting of 1024 tells Windows to provide the application with as much expanded memory as it asks for, up to a limit of 1024K, or until there is no more memory available.

<u>Use this option</u>	<u>To do this</u>
Locked	Tell Windows not to swap the application's expanded memory to the hard disk. Locking an application's memory can improve that application's performance, but it slows down the rest of your system.

## ***XMS Memory***

Use the XMS Memory options to tell Windows how much extended memory to give to an application that uses memory according to the Lotus-Intel-Microsoft-AST eXtended Memory Specification (XMS) standard. Because very few applications use extended memory, you can usually leave these options at their standard settings. The following list explains each option:

<u>Use this option</u>	<u>To do this</u>
KB Required	<p>Tell Windows how many kilobytes of extended memory it must be able to provide in order to start the application. In general, you can leave this option at the standard setting of 0, which tells Windows that this application does not require extended memory.</p> <p>The KB Required option does not limit how much extended memory the application receives; Windows gives it as much extended memory as the application requests, up to the limit set by the KB Limit option (or until no more memory is available).</p> <p>Windows will start the application only if it can provide at least as much extended memory as the KB Required option specifies. Otherwise, Windows displays a message telling you that there is not enough memory to run the application. If other applications are running, you can close one or more of them and try running the application again. For more information about making more memory available to the application, see "Freeing Up Memory" later in this chapter.</p>



<u>Use this option</u>	<u>To do this</u>
KB Limit	<p>Limit the amount of extended memory Windows will provide to the application. Windows will give an application as much extended memory as it requests, up to the amount you specify in this text box (or until no more memory is available).</p> <p>This option is useful for limiting an application's access to extended memory, since some applications will take all available extended memory whether they need it or not.</p> <p>To prevent Windows from providing any extended memory to the application, set this option to 0.</p> <p>The standard setting of 1024 tells Windows to provide the application with as much extended memory as it asks for, up to a limit of 1024K, or until there is no more memory available.</p>
Locked	<p>Tell Windows not to swap the application's extended memory to the hard disk. Locking an application's memory can improve that application's performance, but it slows down the rest of your system.</p>

### ***Uses High Memory Area***

The Uses High Memory Area option tells Windows that the application is allowed to use the high memory area (HMA) of RAM. The high memory area is the first 64K of extended memory.

If the HMA is available when Windows starts, each application can allocate its own private HMA. However, the HMA is used by some memory-resident utilities such as networks. If such a utility is using the HMA when you start Windows in 386 enhanced mode, no other application will be able to use the HMA.

Keep this option selected for most applications. If the HMA is available and the application uses it, more memory will be available to the application. If the application does not use the HMA, no memory is wasted.

Clear this option to prevent the application from using the HMA even when the HMA is available.

## Lock Application Memory

Select the Lock Application Memory option to speed up some applications. While the application is running, if this option is selected, Windows will keep the application in memory and not swap it to the hard disk. Although selecting this option can speed up the application, it slows down the rest of your system.

**NOTE** This option affects how the application's conventional memory is handled. The use of its expanded and extended memory is controlled separately by the Locked options in the EMS Memory and XMS Memory sections of this dialog box. See Chapter 13, "Optimizing Windows," for more information on memory.

## Display Options

Use the Display options to determine how the application appears on the screen and how Windows handles memory for the application's display. The Display options appear as follows:

Display Options			
Video Memory:	<input checked="" type="radio"/> Text	<input type="radio"/> Low Graphics	<input type="radio"/> High Graphics
Monitor Ports:	<input type="checkbox"/> Text	<input type="checkbox"/> Low Graphics	<input checked="" type="checkbox"/> High Graphics
	<input checked="" type="checkbox"/> Emulate Text Mode	<input type="checkbox"/> Retain Video Memory	

### Advanced PIF options: Display

The following sections explain each Display option.

### Video Memory

Use the Video Memory options to tell Windows how the application initially uses the display. The video mode determines how much memory Windows provides for the application's display when you start the application.

You can select from three video modes: Text, Low Graphics, and High Graphics. The following list explains each option:

<u>Use this option</u>	<u>To do this</u>
Text	Tell Windows to set aside enough memory to initially display the application in text mode. Text mode requires the least amount of memory (usually less than 16K).
Low Graphics	Tell Windows to set aside enough of the application's memory to initially display it in low-resolution graphics mode. On most video adapters, this mode corresponds to CGA resolution graphics, and requires about 32K of memory.
High Graphics	<p>Tell Windows to set aside enough of the application's memory to initially display it in high-resolution graphics mode. EGA and VGA video adapters display applications in high-resolution graphics mode, which usually requires about 128K of memory.</p> <p>Selecting both this option and the Retain Video Memory option will ensure that there's always enough memory to run the application; however, less memory will be available for other applications.</p>

Windows uses the Video Memory options to reserve enough memory for the application's initial display. After the application is running, Windows can adjust the application's display memory depending on the application's current video mode. For example, if you start the application in graphics mode and later change it to text mode (which requires less memory), Windows releases the extra memory for use by other applications. If you change to a video mode that requires more memory, Windows tries to provide the additional memory.

If you switch to a higher video mode and there is not enough additional memory available, the application's display might be partially or totally lost. You can prevent this by ensuring that there will always be enough display memory available for this application. To do this, select the highest video mode the application will run in. Also, select the Retain Video Memory option to tell Windows not to release extra video memory to other applications. See the description of that option later in this section.

**NOTE** The exact effects of the Video Memory options depend on the video adapter for your system. For example, some video adapters, such as Hercules © and CGA, have only one graphics mode; on these adapters, there is no difference between Low Graphics and High Graphics.

## ***Monitor Ports***

Some applications interact directly with system hardware input and output ports in order to control the display adapter. If an application does this, Windows might need to monitor that application's interaction with the hardware ports. This ensures that, when you switch away from and return to the application, Windows can restore the application's display correctly.

For most applications, you can leave these options at their standard settings. You should change these options only if the application's display does not appear as it should, since monitoring the application's video operations slows the application down considerably.

If the application's display does not appear as it should, select the option for the mode the application was running in when the problem occurred, and try running the application again. If the display is still not restored correctly, try selecting the other Monitor Ports options until the display appears as it should. The following list explains each option:

<u>Use this option</u>	<u>To do this</u>
Text	Tell Windows to monitor all video operations when the application is running in text mode. Few applications require this option.
Low Graphics	Tell Windows to monitor all video operations when the application is running in low-resolution graphics mode. Few applications require this option.
High Graphics	Tell Windows to monitor all video operations when the application is running in high-resolution graphics mode. Most applications require this option.

**NOTE** Some display adapters, such as the IBM VGA, will not be affected by these options.

## ***Emulate Text Mode***

The Emulate Text Mode option can increase the rate at which the application displays text. For most applications, you can leave this option selected.

Try clearing this option if the text is garbled, the cursor appears in the wrong place, or the application will not run.

## ***Retain Video Memory***

Use the Retain Video Memory option to tell Windows not to release the application's extra video memory for use by other applications.

Some applications can use several different video modes; usually, you can change the video mode from the application itself. For example, Microsoft Word lets you change back and forth between Text and Graphics modes. If you are using such an application and the Retain Video Memory option is not selected, Windows adjusts the application's video memory to accommodate the application's current video mode. If you change to a video mode that requires less memory, Windows releases the extra memory for use by other applications. If you later change back to a mode that requires more memory, Windows gives the application additional memory for its display.

This dynamic allocation of video memory works well as long as you do not run out of memory. However, if you run out of memory and then change the application to a more memory-intensive video mode, Windows might not be able to provide enough memory to support that mode, and the application's display might be lost.

Selecting both this option and the appropriate Video Memory option ensures that there will always be enough memory available for Windows to handle the application's display correctly. The Video Memory option ensures that there will be enough video memory to display the application when it starts; the Retain Video Memory option ensures that Windows will not release any of the application's video memory to other applications. Note that if you select both options, the memory will not be available for other applications even when it is not actually in use.

## ***Other Options***

The Advanced PIF options include several additional options you can use to customize the way the application runs with Windows in 386 enhanced mode. The Other options appear as follows:

<b>Other Options</b>	
<input checked="" type="checkbox"/> Allow Fast Paste	<input type="checkbox"/> Allow Close When Active
Reserve Shortcut Keys:	<input type="checkbox"/> Alt+Tab <input type="checkbox"/> Alt+Esc <input type="checkbox"/> Ctrl+Esc <input type="checkbox"/> PrtSc <input type="checkbox"/> Alt+PrtSc <input type="checkbox"/> Alt+Space <input type="checkbox"/> Alt+Enter
Application Shortcut Key:	None

### Advanced PIF options: Other options

The following sections explain each option.

#### ***Allow Fast Paste***

Select this option if the application is capable of accepting information pasted from the Clipboard using the fastest method. Most applications can use the fastest pasting method without problems. Windows can detect most applications that cannot handle fast pasting and, for those applications, automatically uses the slower pasting method instead.

Clear this option only if you are having trouble pasting information into the application. Occasionally, Windows is unable to detect an application that cannot accommodate the fastest pasting method; then, when you choose Paste from the application's Control menu, nothing happens. To fix this problem, cancel the paste operation by pressing ESC, and quit the application. In the application's PIF, clear the Allow Fast Paste option, save the PIF, and restart the application.

#### ***Allow Close When Active***

Use this option to tell Windows that it can close the application without requiring you to choose the application's exit command. This feature lets you exit Windows without having to close every application separately.

Select this option only if you are sure that the application uses standard MS-DOS file handles. If you are unsure, do not select this option.

---

**CAUTION** Selecting this option could result in data loss or damage to your files. Windows might close an application before the application closes its open files; as a result, you could lose any changes you made to those files.

---

## ***Reserve Shortcut Keys***

Selecting one or more of the Reserve Shortcut Keys options tells Windows to ignore the specified key combination when the application is running in the foreground, and instead let the application respond to the key combination. The following list explains how Windows uses each shortcut key:

<u>Use this option</u>	<u>To do this</u>
Alt+Tab	Reserve the ALT + TAB shortcut key for the application. Otherwise, Windows switches between applications when you press this key combination.
Alt+Esc	Reserve the ALT + ESC shortcut key for the application. Otherwise, Windows switches to the next application when you press this key combination.
Ctrl+Esc	Reserve the CTRL + ESC shortcut key for the application. Otherwise, Windows displays the Task List when you press this key combination.
PrtSc	Reserve the PRINT SCREEN shortcut key for the application. Otherwise, Windows copies a full screen onto the Clipboard when you press this key.
Alt+PrtSc	Reserve the ALT + PRINT SCREEN shortcut key for the application. Otherwise, Windows copies the contents of the active window onto the Clipboard when you press this key combination.
Alt+Space	Reserve the ALT + SPACEBAR shortcut key for the application. Otherwise, Windows displays the application's Control menu when you press this key combination.
Alt+Enter	Reserve the ALT + ENTER shortcut key for the application. Otherwise, Windows toggles the application in or out of a window (if it can run in one) when you press this key combination.

The Reserve Shortcut Keys options for 386 enhanced mode are similar to the corresponding options for standard mode. For additional information, see "Specifying PIF Options for Standard Mode or Real Mode" earlier in this chapter.

## Application Shortcut Key

When running in 386 enhanced mode, Windows provides a special feature called an *application shortcut key*. When an application is running and you press its application shortcut key, it immediately becomes the foreground application. An application shortcut key lets you switch to a particular application quickly, no matter where you are in Windows or what other application you are using.

To assign an application shortcut key to an application, you use the Application Shortcut Key option in the application's PIF. The key combination you specify must include either the ALT or CTRL key. For example, the key combinations CTRL + Y, ALT + F4, CTRL + SHIFT + F11, and CTRL + ALT + 7 are all valid application shortcut keys. You cannot specify a key combination that includes the ESC, ENTER, TAB, SPACEBAR, PRINT SCREEN, or BACKSPACE keys.

Once you assign an application shortcut key, when that application is loaded, that key combination works only as a shortcut key. This means that no application (including Windows, Windows applications, and the application that owns the shortcut key) can use that key combination for any other purpose. For this reason, you should select application shortcut keys carefully.

For example, suppose you specify ALT + F as the application shortcut key for PFS:® FirstChoice®. In many Windows applications, ALT + F acts as a shortcut key; it displays the File menu. However, if you are using Notepad when FirstChoice is loaded, pressing ALT + F switches FirstChoice into the foreground, rather than displaying Notepad's File menu.

Avoid assigning the same shortcut key to more than one application.

### ▷ To specify a shortcut key:

1. Select the Application Shortcut Key option.
2. Press the key combination you want.

Windows will interpret any key combination you press as an application shortcut key definition except for keys that allow you to move away from the option (such as TAB).

3. Choose OK.

If you press an invalid key combination, Windows displays a dialog box telling you there is something wrong with the shortcut key definition and sets the key definition to its previous value.



▷ **To delete a shortcut key definition:**

1. Select the Application Shortcut Key option.
2. Press SHIFT + BACKSPACE to set the shortcut key to None. This means that no shortcut key is defined for this application.

Or, while entering a key combination, press BACKSPACE to set the shortcut key definition to its previous value.

## ***Changing Settings for a Running Application***

**386**

The previous sections explained how to use a PIF to change the way a non-Windows application starts and runs. When a non-Windows application is running with Windows in 386 enhanced mode, you can also make temporary changes to the way the application runs. To do so, you choose Settings from the application's Control menu. Your changes stay in effect until you quit the application.

This section briefly explains the settings you can change while the application runs. Most of these settings are similar to settings in the application's PIF; for details on each setting, see the appropriate sections earlier in this chapter.

▷ **To change settings for a running application:**

1. Choose the Settings command from the application's Control menu. Windows displays the following dialog box:

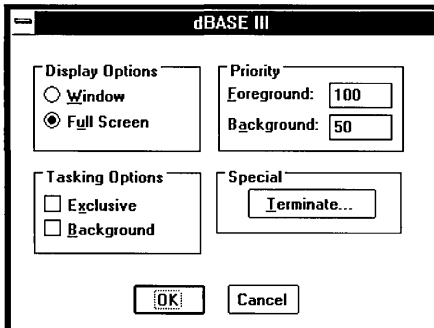

2. Change the appropriate setting.

The following sections describe the options you can select.

## Display Options

Use the Display options to change how the application appears—either in a full-screen display or in a window. You can select one of the following options:

<u>Use this option</u>	<u>To do this</u>
Window	Move the application into a window.
Full Screen	Move the application into a full-screen display.

You can also move a running application from a window to a full-screen display, or vice versa, by pressing ALT + ENTER.

**NOTE** If you want to use a mouse with a non-Windows application, you must run it full screen. When you run a non-Windows application in a window, the mouse functions with Windows only.

## Tasking Options

Use the Tasking options to control how the application shares system resources with other applications. You can select one or both of the following options:

<u>Use this option</u>	<u>To do this</u>
Exclusive	Suspend other applications while this application is the active application. (If this application is running in a window, Windows applications will continue to run, but other non-Windows applications will be suspended.)
Background	Allow this application to run in the background while you are working with other applications. (However, this application will still be suspended while you are using an exclusive application.)

## Priority Options

Use the Priority options to specify how much processor time the application should receive, relative to other applications. Giving the application a high priority makes it run faster than applications with lower priorities; conversely, giving it a priority lower than other applications will slow it down.

You can set the following options:

<u>Use this option</u>	<u>To do this</u>
Foreground	Control how fast the application runs, relative to other applications, when it is the foreground application.
Background	Control how fast the application runs, relative to other applications, when it is the background application.  For this option to take effect, you must also specify Background in the Tasking options.

## ***Terminate Option***

Choose Terminate to quit a non-Windows application when you cannot use the usual methods from within the application—for example, when the application does not respond to the commands you type. Ordinarily, when running from MS-DOS, if an application does not respond to your commands, you have to restart your computer. Windows provides the Terminate option so that you can close the application and then save any open files in other applications. After terminating the application and saving other applications' open files, you should exit Windows, and then restart your computer by pressing CTRL + ALT + DEL.

---

**CAUTION** Use the Terminate option only as a last resort. Terminating an application can result in lost data. If you don't restart your computer after terminating an application, Windows and/or MS-DOS may become unstable.

---

## ***Freeing Up Memory***

If you get out-of-memory messages when you try to run an application, you can free up memory in a number of ways, including the following:

- Close other applications.
- Run non-Windows applications in a full-screen display instead of in a window (386 enhanced mode only). To move an application from a window to a full-screen display, press ALT + ENTER.
- Minimize Windows applications to icons. To minimize an application to an icon, bring it to the foreground and press ALT + SPACEBAR. Then select the Minimize command, or click the Minimize button.

- Clear or save the Clipboard contents. For more information on using the Clipboard, see “Working with Applications” in Chapter 2.
- If you are using a desktop wallpaper, set the desktop wallpaper to None. See Chapter 5, “Control Panel,” for information.
- Change PIF options for the application you want to run.
- Change PIF options for other non-Windows applications that you want to run simultaneously (386 enhanced mode only).

386

The following sections explain what PIF options will free memory for non-Windows applications running with Windows in real or standard mode and 386 enhanced mode, respectively.

## ***Freeing Memory with Standard PIF Options***

If you are using Windows in real or standard mode, and you get an out-of-memory message when trying to run a non-Windows application, first try the techniques listed in the previous section. If you still get an out-of-memory message, consider changing the following PIF options:

<u>Option</u>	<u>Suggested Change</u>
Memory Requirements	<p>If Windows displays an out-of-memory message when you try to start the application, reduce the amount specified in Memory Requirements: KB Required.</p> <p>If Windows succeeds in starting the application, but the application subsequently displays its own out-of-memory message, you might need to free up more memory before starting Windows. See Chapter 13, “Optimizing Windows.”</p>
XMS Memory	<p>If the application does not need extended memory, make sure that XMS Memory: KB Required and XMS Memory: KB Limit are set to 0.</p>
Prevent Program Switch	<p>Select this option to make more memory available to the application; however, if you do so, you will have to quit the application to return to Windows.</p>

<u>Option</u>	<u>Suggested Change</u>
No Screen Exchange	Select this option to prevent Windows from allocating memory for copying information onto the Clipboard with PRINT SCREEN or ALT + PRINT SCREEN. This makes more memory available for the application; however, you will not be able to copy this application's display onto the Clipboard.
Video Mode	Select Video Mode: Text to reduce the amount of memory Windows sets aside for the application's display. This makes more memory available for the application; however, if you change modes while using the application, you might not be able to switch away from the application.

## ***Freeing Memory with 386 Enhanced PIF Options***

**386**

When Windows is running in 386 enhanced mode, Windows applications and non-Windows applications share memory resources. The more memory you give to one application, the less is available to others. If you get an out-of-memory message when trying to start an application, first try the techniques listed at the beginning of this section, "Freeing Up Memory."

If you still get an out-of-memory message, try changing that application's PIF. You can free up memory for an application by changing the following settings in its PIF:

<u>Option</u>	<u>Suggested Change</u>
Memory Requirements	<p>If Windows displays an out-of-memory message when you try to start the application, reduce the amount specified in the KB Required option.</p> <p>If Windows succeeds in starting the application, but the application subsequently displays its own out-of-memory message and then terminates, increase the amount specified in the KB Required and KB Desired options. (An application might also run out of memory if it doesn't have enough extended or expanded memory. If you suspect this is the case, try increasing the amounts in the XMS Memory and EMS Memory options.)</p>

<u>Option</u>	<u>Suggested Change</u>
Display Usage	Select Full Screen instead of Windowed. Windowed applications require more memory to run.
Execution	Select the Exclusive option to suspend other applications while this application is in the foreground. This makes more memory available to the application, but prevents other applications from running simultaneously.
Display Options	Select the Video Memory: Text option if you are sure that you will use only Text mode while running an application. Text mode requires less memory than the other modes. Clear the Retain Video Memory option to release reserved memory to the system.

If you still get out-of-memory messages after changing the application's PIF, try changing the PIFs for other applications you plan to run at the same time. You can free up additional memory for an application by changing the following settings in other applications' PIFs:

<u>Option</u>	<u>Suggested Change</u>
Memory Requirements	Reduce the amount specified in other applications' KB Desired options. (Do not reduce it so much that the other applications will not be able to run effectively.)
Display Usage	Select other applications' Full Screen options.
Execution	Clear other applications' Background options to prevent them from running in the background. This makes more memory available to the application you want to run, but prevents the other applications from running at the same time.  You might want to do this to prevent particular applications from running in the background while others continue. To prevent all applications from running in the background, it is much easier to simply select the foreground application's Exclusive option.

<u>Option</u>	<u>Suggested Change</u>
Lock Application Memory	Clear other applications' Lock options (Lock Application Memory, XMS Memory: Locked, and EMS Memory: Locked) to release memory to the system. This makes more memory available to the application you want to run, but might slow down the application(s) for which you clear the Lock options.

If you still get out-of-memory messages, see Chapter 13, "Optimizing Windows," for more information on freeing up memory.

## ***If Things Go Wrong***

Most applications will run without problems. However, occasionally, you might see error messages when starting or running an application; or, a key or function might not work as it should. The following recommendations cover the most common trouble areas.

### ***If You Get Out-of-Memory Messages***

If you get out-of-memory messages when you try to run a non-Windows application, see "Freeing Up Memory," earlier in this chapter, for recommendations about how to make more memory available to the application. If you follow those recommendations, but still cannot get the non-Windows application to run, make sure that your system has enough physical memory and is configured correctly. For minimum memory requirements, see "What You Need to Run Windows" in the introduction of this guide. Chapter 13, "Optimizing Windows," explains how to configure your system's memory.

If you get out-of-memory messages when you try to run a Windows application, see Chapter 13, "Optimizing Windows," for information about making more memory available to Windows and Windows applications.

**NOTE** A few non-Windows applications use extended memory in a way that is incompatible with the version of HIMEM.SYS that comes with Windows 3.0. If a non-Windows application will not start because there is insufficient extended memory available, first try the methods described in "Freeing Up Memory" earlier in this chapter. If these methods do not work, disable the HIMEM.SYS command line in your CONFIG.SYS file, restart your computer, start Windows in real mode (by typing *win /r*), and restart the

application. For information on editing your CONFIG.SYS file, see “Freeing Up Memory Before Starting Windows” in Chapter 13.

## ***If You Cannot Switch from a Non-Windows Application***

If you are unable to switch away from a non-Windows application, one of the following might be the reason:

- The application’s PIF might reserve one or more Windows shortcut keys for the application.  
Quit the application and edit its PIF. So that you can switch from the application, clear the Reserve Shortcut Keys options for ALT + TAB, ALT + ESC, and CTRL + ESC.
- The application might be using a video mode that Windows does not support. Therefore, Windows cannot save and restore the application’s display.  
Quit the application and edit its PIF. Try selecting a higher video mode.

If you are running Windows in real or standard mode, and you are unable to switch away from the application, one of the following might be the reason:

- The Prevent Program Switch option might be selected in the application’s PIF.  
Quit the application and edit its PIF. So that you can switch from the application, clear the Prevent Program Switch option.
- The wrong video mode might be selected in the application’s PIF.  
Quit the application and edit its PIF. Try selecting a higher video mode.
- If you have an EGA display, the device driver EGA.SYS might not be properly installed in your CONFIG.SYS file. EGA.SYS is included with Windows, and resides in your Windows system directory. Normally, Setup should install EGA.SYS in your CONFIG.SYS file automatically.  
Run Setup again to ensure that EGA.SYS is installed correctly. For information about running Setup again, see Appendix A, “Using Setup to Maintain Windows.” For more information about EGA.SYS, see Appendix D, “Command Lines in the CONFIG.SYS File.”
- One or more Directly Modifies options might be set in the application’s PIF.  
Quit the application and edit its PIF; try clearing one or more Directly Modifies options.



- The application might be intercepting all keyboard input. Some applications intercept keyboard input before Windows can receive and process your keystrokes.

You cannot switch away from such an application; you must quit the application in order to return to Windows or switch to other applications.

---

**CAUTION** Sometimes an application's PIF contains settings that purposely prevent you from switching from that application, because doing so might result in a lost display or lost data. Use caution when changing these settings.

---

## ***If Your Application Display Is Lost***

**386**

If you are running Windows in 386 enhanced mode and you lose the display of a non-Windows application, the cause is often one of the following:

- The application might require the Monitor Ports options to be selected in its PIF.

Quit the application, select the appropriate Monitor Ports option in its PIF, and restart the application.

- If the application switched to a higher video mode (for example, from text mode to graphics mode), there might not be enough memory to accommodate the new video mode.

To prevent this problem from recurring, select a higher Video Memory option in the application's PIF; also, select the Retain Video Memory option in the application's PIF.

For more information about these PIF options, refer to the PIF descriptions earlier in this chapter.

If the same thing happens when you are running Windows in real or standard mode, the preceding alternatives will not work.

## ***If You Get Garbled Data When Using a Communications Application***

When using a non-Windows communications application with Windows, you might see garbled data. The cause might be that the baud rate setting is too high for your application or modem to handle. In this case, you need to do the following:

1. Stop the data transmission.
2. Check to make sure the remote computer can use a slower baud rate.
3. Change the baud rate setting in the communications application.
4. Try running the application again.

**386**

If you see garbled data when running a communications application with Windows in 386 enhanced mode, you might need to adjust the Device Contention options in Control Panel. To do so, start Control Panel and choose the 386 Enhanced icon. See Chapter 5, “Control Panel,” for more information.

## ***If You Press a Key and the Unexpected Happens***

If the desired action does not take place when you press a key combination, the cause is usually that another running application or Windows is using the key combination for another purpose.

The following is a list of some common problems and solutions:

- You press a key combination that should perform a function in an application, but it instead performs a Windows function (for example, you unexpectedly switch to the next application).

You are probably pressing a Windows shortcut key. If you want that key combination to work differently when using a particular application, select the Reserve Shortcut Keys option for that shortcut key in the application’s PIF. (For a list of Windows shortcut keys, see “Reserve Shortcut Keys” earlier in this chapter.)

- You press a Windows shortcut key such as ALT + TAB, but something happens other than the normal Windows function.

The key combination you pressed has probably been reserved for an application and no longer works as a Windows navigation tool. Check the PIF of the foreground application to see if a Windows key combination has been reserved for that application. See the Reserve Shortcut Keys options and (if you are

running Windows in 386 enhanced mode) the Application Shortcut Key option. These options are described earlier in this chapter.

**386**

- You press a key combination and unexpectedly switch to a particular application (386 enhanced mode only).

If pressing a particular key combination always switches to the same application, that key combination is probably assigned to that application as an application shortcut key.

Check that application's PIF. If you want to use the key combination for any other purpose, you need to assign the application a different application shortcut key.

**386**

- If you are running Windows in 386 enhanced mode, and you hear a beep whenever you press a key while using the application, Windows might have suspended that application. This might happen if, for example, you try to display the application in a window, but it cannot run in a window.

To resume using the application, press ALT + ENTER to return it to a full-screen display.

**386**

- If you are running Windows in 386 enhanced mode and the application's title contains the word "Select" or "Mark," Windows is expecting you to select information for transfer onto the Clipboard. To return to the application, press ESC, click the right mouse button in the application window, or complete the copy operation.

**386**

- If you are running Windows in 386 enhanced mode and the application's title contains the word "Scroll" or "Mark," Windows is expecting you to use the keyboard to scroll the information in the application's window. To return to the application, press ESC.

## ***If an Application Is Abnormally Slow***

If a Windows application is running very slowly, your system is probably low on memory. You can tell that there's not enough memory when your system's disk light is frequently lit. This indicates that Windows is swapping information to disk to make room in memory for other information, or that Windows is re-reading information from the disk into memory. For information on making more memory available, see "Freeing Up Memory" earlier in this chapter and Chapter 13, "Optimizing Windows."

If a non-Windows application is running very slowly, there are several possible causes:

- The application was not given enough memory when it was started. Although it can run with that amount of memory, it runs more slowly.

Free up some memory before running Windows. Windows cannot give a non-Windows application any more conventional memory than was available when you started Windows. Therefore, freeing up memory before starting Windows can make more memory available to each non-Windows application. Chapter 13, “Optimizing Windows,” explains how to free up memory before you start Windows.

**386**

If you are running Windows in 386 enhanced mode, try increasing the KB Required and KB Desired settings in the application’s PIF.

**386**

- Windows is not giving the application enough of the computer’s processor time (386 enhanced mode only).

The application might not be getting enough processor time, or other running applications are getting too much processor time. To reallocate processor time, choose the Settings command in the application’s Control menu and change the Background or Foreground option while the application is running. Or change the Foreground Priority and Background Priority options in the application’s PIF. (You might also want to change the Priority options for other applications that you plan to run at the same time as this application.)

Sometimes Windows applications might use more processor time than you want. To make more time available to a non-Windows application, change it to exclusive status. To do so, select the Exclusive option in the application’s PIF, or choose the Settings command in the application’s Control menu and select Exclusive.

**386**

- Windows is incorrectly treating that application as idle (386 enhanced mode only).

Occasionally, Windows interprets a non-Windows application’s pauses for maintenance activity as idle time. When Windows thinks an application is idle, it gives more processing time to other applications; this slows down an active application. To prevent Windows from trying to tell whether the application is idle, clear the Detect Idle Time option in the application’s PIF.

## ***If You Cannot Take a Snapshot of the Screen***

If you are having trouble moving or copying information onto the Clipboard, one of the following might be the cause:

- If you are running Windows in real or standard mode, the No Screen Exchange option might be selected in the application's PIF. This option prevents you from copying information onto the Clipboard using PRINT SCREEN or ALT + PRINT SCREEN. This option might have been set to give the application enough memory to run. Try clearing this option, starting the application, and copying the information again.
- The PRINT SCREEN or ALT + PRINT SCREEN key combinations, normally Windows shortcut keys, might have been reserved for an application. Try clearing the corresponding Reserve Shortcut Key options in the foreground application's PIF.
- If you are running Windows in real or standard mode, the wrong Video Mode option might be selected in the application's PIF. Try selecting a higher video mode.
- If you are running Windows in 386 enhanced mode, it might not have enough memory to perform this activity. Close some applications and, if necessary, refer to "Freeing Up Memory" earlier in this chapter.

**386**

## ***If You Cannot Paste Information Properly***

A number of situations can affect Windows' ability to paste information from the Clipboard into an application. The following list explains some common problems:

- The information on the Clipboard might not be in Text format. (Windows cannot paste graphics into a non-Windows application.)  
Try saving the information you want to paste as a separate file and then reading that file into the application.
- The application might be unable to accommodate the fastest pasting method.  
If you are running Windows in 386 enhanced mode, the Allow Fast Paste option in the application's PIF is normally selected, since most applications can accommodate the fastest pasting method. However, if the application cannot use the fastest method, it might not respond when you try to paste into it. Try quitting the application, clearing the Allow Fast Paste option in the application's PIF, restarting the application, and doing the paste again.

**386**

## ***If Your Application Remains on the Screen When You Close It***

Normally, when you quit a non-Windows application, Windows clears the application's display automatically. However, if the Close Window on Exit option is not selected in the application's PIF, the application's display will remain on the screen even though the application is no longer running.

If you are running Windows in real or standard mode, you can clear the screen and return to Windows by pressing any key or clicking a mouse button. If you are running Windows in 386 enhanced mode, you can remove the inactive application window by double-clicking the window's Control menu icon.

To allow Windows to remove the application's display automatically, edit the application's PIF and select the Close Window on Exit option.

## ***If You Cannot Quit an Application***

Occasionally, a non-Windows application might encounter an error, so that you cannot exit the application normally. In that case, first try pressing CTRL + C or CTRL + BREAK.

If pressing CTRL + C or CTRL + BREAK does not work, try terminating the application using the End Task command in the Task List.

### **▷ To terminate an application using the End Task command:**

1. Press ALT + TAB to switch back to Windows.
2. Press CTRL + ESC to display the Task List.
3. Select the application from the Task List.
4. Choose End Task to terminate the application.

If you cannot switch back to Windows, then you will not be able to exit Windows normally. Restart your computer by pressing CTRL + ALT + DEL.

**386**

If you are running Windows in 386 enhanced mode, you can also terminate the application using the Terminate option in the application's Control menu.

▷ **To terminate an application using the Terminate option:**

---

1. Display the application in a window by pressing ALT + SPACEBAR.
2. Choose the Settings command from the Control menu.
3. Choose Terminate.

---

**CAUTION** Use the End Task and Terminate options only as a last resort. Terminating an application can result in lost data.

---

## ***If Your System Stops Responding or Terminates Unexpectedly***

If your current application, Windows, or your computer stops responding, the application or Windows terminates unexpectedly, or your computer restarts unexpectedly, one of the following may be the cause:

- You are running an older Windows application that is incompatible with Windows 3.0. Try running the application after starting Windows in real mode (by typing *win /r*). For more information about running older Windows applications, see “Windows Applications” earlier in this chapter.
- Your computer is connected to a network that does not support Windows, and you are running a Windows or non-Windows application that accesses the network directly. For additional information, see Chapter 14, “Networks and Windows.”
- You are using hardware that is incompatible with Windows. See the Hardware Compatibility List supplied with Windows for more information on hardware compatibility. Sometimes, you can get around a hardware incompatibility by adjusting settings in your SYSTEM.INI file. For more information about SYSTEM.INI, use Notepad to open the SYSINI.TXT file.

---

---

**Chapter**  
**13**

***Optimizing Windows***

**What Is Optimizing? .....493**

**What Are System Resources? .....494**

    Understanding Memory ..... 494

    Understanding Disk Space ..... 496

**Configuring Your System's Memory .....499**

    Configuring an 80386 or 80486 Computer ..... 499

    Configuring an 80286 Computer ..... 500

    Configuring an 8086 or 8088 Computer ..... 502

**Optimizing Your System .....503**

    Improving the Efficiency of Your Hard Disk ..... 507

    Freeing Up Memory Before Starting Windows ..... 515

    Working with Windows Swap Files ..... 520

    Working with Application Swap Files ..... 529

    Using SMARTDrive ..... 530

    Using RAMDrive ..... 535

    Using the TEMP Environment Variable ..... 537

    Controlling Windows' Use of Expanded Memory ..... 538

    Installing the EMM386 Expanded Memory Emulator ..... 540



A vertical line on the left side of the page.

## ***What Is Optimizing?***

*Optimizing* is customizing your system so that it uses its resources most efficiently for the tasks you usually perform. Typically, optimizing involves improving one or more aspects of your system's performance, but sometimes sacrificing something else. For example, you might improve your system's capacity, but have less disk space available as a result. In Microsoft Windows, optimizing your system usually means balancing the following performance factors:

<u>Performance factor</u>	<u>What it affects</u>
Speed	Your system's speed affects the time it takes for Windows or an application to start up, carry out a task, redisplay a window, and so on.
Capacity	Your system's capacity determines how many applications you can run simultaneously, and how much data applications can store in memory at a time.
Free disk space	The amount of available disk space can affect your hard disk's speed and efficiency. In addition, some applications need extra disk space to store temporary files while they run. When running in 386 enhanced mode, Windows can also use some of your available disk space to increase your system's capacity; you might want to control how much disk space Windows uses for this purpose.

The most important thing you can do to improve Windows' performance is to configure your system's memory properly. After you configure your system's memory for optimum performance with Windows, you can use other procedures and utilities to improve performance further. For information about configuring memory, see "Configuring Your System's Memory" later in this chapter. For information about optimization procedures, see "Optimizing Your System" later in this chapter.

## ***What Are System Resources?***

Your system's resources determine its limitations. Most computers have two types of system resources: disk space and memory. In Windows, the available resources can affect:

- Which applications you can run.
- How many applications you can run simultaneously.
- How fast Windows and applications run.
- How much data you can store from one session to the next.

The sections that follow explain each resource and how Windows uses it.

### ***Understanding Memory***

Memory provides temporary storage for applications and data. It exists on your computer's main system board or on add-in memory boards. All applications must be loaded into memory in order to run.

In general, the more memory you have, the more applications you can run with Windows at a time. You can increase the amount of memory on your system by plugging a memory board into a slot inside the machine. For example, you might add a 2MB memory board to a system that already has 1MB of memory.

Your system may have up to three different kinds of memory:

- Conventional memory
- Extended memory
- Expanded memory

The sections that follow explain each type of memory.

#### ***Conventional Memory***

*Conventional memory* exists on all 8086, 8088, 80286, 80386, and 80486-based computers. Most computers have at least 256K of conventional memory, and can accommodate up to 640K of conventional memory.

When you start MS-DOS, it uses up some of your computer's conventional memory. Next, MS-DOS starts the utilities and applications listed in your

CONFIG.SYS and AUTOEXEC.BAT files. These utilities and applications use up more conventional memory. The memory that is left over is available for running applications (including Windows).

## ***Extended Memory***

One way to add more memory to your system is to install *extended memory*. Extended memory is general-purpose memory beyond 640K on 80286, 80386, and 80486 computers. In effect, it is a simple extension of your computer's conventional memory. (Many 80286 and 80386 computers come with 640K of conventional memory and 256K of extended memory, for a total of 1MB of memory.)

To use extended memory efficiently, you should install a special program called an *extended memory manager*. An extended memory manager "administrates" the use of your system's extended memory, so that several programs do not try to use the same memory at the same time. An extended memory manager is required in order to run Windows in standard or 386 enhanced mode. Windows includes the extended memory manager HIMEM.SYS.

Extended memory is very fast and efficient for applications to use. However, many non-Windows applications are not designed to use extended memory.

When running in standard or 386 enhanced mode, Windows takes full advantage of extended memory and its performance benefits. Because of this, Windows runs best if extended memory is available. (When running in real mode, Windows uses extended memory only for storing information that would otherwise be discarded and later read back from the disk.)

## ***Expanded Memory***

Another way to add memory in excess of 640K to your system is to install *expanded memory*. Most personal computers can accommodate expanded memory. Expanded memory exists separately from your system's conventional and extended memory.

To use expanded memory, you must install a special program called an *expanded memory manager*, which comes with the expanded memory board. The expanded memory manager is necessary because, in order to gain access to expanded memory, applications (including Windows) must request it from the expanded memory manager.

Some applications are unable to use expanded memory because they were not designed to interact with an expanded memory manager. However, because

expanded memory was introduced before extended memory, more applications are designed to use expanded than extended memory.

Because an expanded memory manager gives applications access to only a limited amount of expanded memory at a time, expanded memory is slower and more cumbersome to use than extended memory. Therefore, Windows uses expanded memory only when running in real mode. (When running in 386 enhanced mode, Windows can simulate expanded memory for applications that require it, even if your system does not have any expanded memory.)

In real mode, Windows uses only expanded memory that conforms to version 4.0 of the Lotus-Intel-Microsoft Expanded Memory Specification (LIM EMS 4.0). (However, Windows applications can use LIM EMS 3.2 for storing data in memory.) Windows uses expanded memory primarily for storing background applications.

Some expanded memory boards, such as the AST RAMpage! ® AT or Intel Above™ Board/AT, can be set up with extended memory, with expanded memory, or with both. For most systems, Windows runs best if you set up your expanded memory board with all extended memory. For details, see “Configuring Your System’s Memory” later in this chapter.

For additional information about expanded memory, see “Controlling Windows’ Use of Expanded Memory” later in this chapter.

### ***Identifying Your System’s Memory Configuration***

It’s important to know how much and what type of memory your computer has. As explained earlier in this chapter, your system’s memory configuration significantly affects your system’s speed and capacity.

The best way to identify your system’s memory configuration is to use a utility or diagnostics program that is designed specifically for your computer. Most computers and memory boards come with utility programs that tell you exactly what types of memory you have and how much of each type you have. Some programs even let you change your memory configuration. For more information on the program(s) that came with your computer, consult the documentation that accompanied your computer and any memory boards you have installed.

## ***Understanding Disk Space***

Disks provide long-term and temporary storage for program files and data files. The most common types of disk media are diskettes and hard disks. Applications and other files are stored on these media magnetically, much as information is

stored on a cassette tape. In this chapter, *disk space* refers to space that is available on your hard disk.

It's best if there is some disk space left after you have installed all the software and data files you need. There are several reasons you might need free disk space:

- You need disk space to save documents and other data files.
- Some applications use available disk space to store temporary files and data while they're running.
- When low on memory, Windows and some applications can use free disk space to temporarily store information that does not fit in memory. See the following sections for more information on how Windows uses free disk space.

### ***Disk Space and 386 Enhanced Mode***

386

When running in 386 enhanced mode, Windows can simulate additional memory by *swapping*. Swapping involves moving information between memory and the hard disk to make room in memory for other information. Using swapping, Windows can provide much more memory than your system physically has.

When Windows swaps information to the hard disk, it stores the information in a *swap file*. A swap file is a hidden file that reserves space on the hard disk for Windows to use for swapping.

The amount of available disk space determines how large your swap file can be. The larger the swap file, the more memory Windows can provide. For more information about swap files, see "Working with Windows Swap Files" later in this chapter.

### ***Disk Space, Real Mode, and Standard Mode***

In real mode or standard mode, each time you start a non-Windows application, Windows creates a temporary *application swap file* for that application. When you switch away from the application, Windows moves some or all of the application from memory to the application swap file. This helps make your system's memory resources last longer. When you exit Windows, it deletes any application swap files it created during that session. (Windows does not use application swap files when running in 386 enhanced mode.)

The amount of available disk space determines how many application swap files Windows can create; this, in turn, determines how many non-Windows applications you can start before running out of memory. For more information about application swap files, see "Working with Application Swap Files" later in this chapter.

## ***Checking Your System's Disk Space***

It's often useful to know how much disk space is available on your system. As explained earlier in this chapter, the amount of free disk space can affect your ability to store files and data. The amount of available disk space can even affect your system's capacity for running multiple applications.

Often, there will be less free disk space when you are running Windows than when you are not running Windows. This is because Windows uses swap files, which take up some disk space. (See the previous sections for more about how Windows uses disk space.) To tell how much disk space Windows is using, compare the amount of free disk space when Windows is running to the amount of free disk space when Windows is not running.

**386**

If you are running Windows in 386 enhanced mode, you can limit the size of your Windows swap file to conserve disk space. For more information, see "Working with Windows Swap Files" later in this chapter.

### **▷ To check the amount of free disk space when Windows is running:**

1. Choose the File Manager icon from the Main Group in Program Manager.
2. Choose the disk-drive icon for the drive you want to check.

For example, to find out how much disk space is free on drive D, you would choose the D disk-drive icon.

In the status bar at the bottom of the File Manager window, you'll see a number that indicates how many bytes of disk space are currently available on that disk drive. (If the status bar does not appear, you can display it by choosing Status Bar from the Options menu.)

### **▷ To check the amount of free disk space when Windows is not running:**

1. Exit Windows.
2. Type the MS-DOS command *dir* at the DOS prompt.  
MS-DOS displays information about the files in your current directory. The last line of information tells you how many bytes of disk space are free on that drive.

## ***Configuring Your System's Memory***

The most effective way to improve how Windows runs on your system is to configure your system's memory correctly. There are many ways to configure memory for maximum efficiency with Windows. The best configuration for you will depend on the type of computer you have, which Windows mode you use, and the memory requirements of the applications you run.

Your system's memory configuration consists not only of the hardware that's installed in your system; it also includes the software settings and utilities listed in your CONFIG.SYS file. When you install Windows on your computer, Setup checks the settings in your computer's CONFIG.SYS file. If necessary, Setup updates your CONFIG.SYS file so that it includes the necessary settings and command lines.

The following sections provide basic recommendations for configuring different types of computers for use with Windows. Each section describes the memory your system should have, and lists the command lines your CONFIG.SYS file should contain. After reading the configuration section that applies to your computer, see "Optimizing Your System," later in this chapter, for ways you can further improve Windows' performance on your system.

### ***Configuring an 80386 or 80486 Computer***

When you start Windows on an 80386 or 80486 computer, Windows checks to see how much memory is available, and starts in the mode most appropriate for your system. If your system has at least 2MB of memory, Windows runs in 386 enhanced mode; with between 1MB and 2MB, Windows runs in standard mode; and with less than 1MB, Windows runs in real mode. (To find out what mode Windows is running in, choose the About Program Manager command from the Help menu in Program Manager.)

To run Windows most efficiently, your 80386 or 80486 computer should have the following memory:

- 640K of conventional memory.
- Extended memory, if possible. The more extended memory your system has, the better.

To run Windows in standard mode, you'll need at least 256K of extended memory.



To run Windows in 386 enhanced mode, you'll need at least 1024K of extended memory.

- If you have a configurable expanded memory board, you should reconfigure it all as extended memory. (See the documentation that came with your expanded memory board for information on how to reconfigure it.)

Your CONFIG.SYS file should contain the following command lines:

- A command line for an extended memory manager such as HIMEM.SYS.  
To use extended memory, Windows requires HIMEM.SYS or a compatible memory manager. When you install Windows, Setup automatically installs HIMEM.SYS, and adds the HIMEM.SYS command line to your CONFIG.SYS file.
- A command line for the expanded memory manager that came with your expanded memory board, if you have one. For details, consult the documentation that accompanied your expanded memory board.
- A command line for the SMARTDrive disk-caching utility.  
Windows runs much faster if you use SMARTDrive. "Using SMARTDrive," later in this chapter, explains how to install and optimize SMARTDrive.
- The FILES command line. You should set FILES = 30.
- The BUFFERS command line. In general, you should set BUFFERS = 20 or less. If you are using SMARTDrive, you can set BUFFERS = 10.
- If necessary, a command line for the expanded memory emulator EMM386.SYS.  
*An expanded memory emulator* is a software utility that converts extended memory into expanded memory. For more information, see "Installing the EMM386 Expanded Memory Emulator" later in this chapter.
- If necessary, a command line for the device driver EGA.SYS.  
If your system has an EGA monitor and you run non-Windows applications with Windows in real mode or standard mode, your CONFIG.SYS file should contain a command line like the following:

```
device = c:\windows\ega.sys
```

## Configuring an 80286 Computer

When you type *win* on an 80286 computer, Windows checks your system configuration. If your computer has at least 1MB of memory, Windows runs in standard mode. Otherwise, Windows runs in real mode.

80286 computers can accommodate two types of additional memory: expanded and extended. You can configure most expanded memory boards so that they provide all expanded memory, all extended memory, or a mixture of both. However, you cannot reconfigure most extended memory boards; they provide only extended memory.

To run Windows most efficiently, your 80286 computer should have the following memory:

- At least 1MB of memory, consisting of the following:
  - 640K of conventional memory.
  - At least 256K of extended memory. The more extended memory your system has, the better.
- As much expanded memory as necessary for applications that require it.

Some applications require expanded memory. To run such an application on an 80286 computer—either with Windows or from MS-DOS—your system must include as much expanded memory as the application needs.

If your 80286 system has a configurable expanded memory board, you should configure it so that it provides only as much expanded memory as the applications need. To improve Windows' performance, configure any additional memory as extended. (See the documentation that came with your expanded memory board for information on how to reconfigure it.)

Your CONFIG.SYS file should contain the following command lines:

- A command line for an extended memory manager such as HIMEM.SYS.

To use extended memory, Windows requires HIMEM.SYS or a compatible memory manager. When you install Windows, Setup automatically installs HIMEM.SYS in your Windows directory, and adds the HIMEM.SYS command line to your CONFIG.SYS file.
- A command line for the expanded memory manager that came with your expanded memory board, if you have one. For details, consult the documentation that accompanied your expanded memory board.
- A command line for the SMARTDrive disk-caching utility.

Windows runs much faster if you use SMARTDrive. "Using SMARTDrive," later in this chapter, explains how to install and optimize SMARTDrive.
- The FILES command line. You should set FILES = 30.
- The BUFFERS command line. In general, you should set BUFFERS = 20 or less. If you use SMARTDrive, you can set BUFFERS = 10.

- If necessary, a command line for the device driver EGA.SYS.  
If your system has an EGA monitor and you run non-Windows applications with Windows in real mode or standard mode, your CONFIG.SYS file should contain a command line like the following:

*device = c:\windows\ega.sys*

## **Configuring an 8086 or 8088 Computer**

On an 8086 or 8088 computer, Windows runs only in real mode. To run Windows most efficiently, your 8086 or 8088 computer should have the following memory:

- At least 640K of conventional memory.
- As much expanded memory as possible. For Windows to use it, the expanded memory must conform to the LIM EMS 4.0 standard.

Your CONFIG.SYS file should include the following command lines:

- A command line for the expanded memory manager that came with your expanded memory board, if you have one. For details, consult the documentation that accompanied your expanded memory board.
- A command line for the SMARTDrive disk-caching utility, if you have expanded memory.

Windows runs much faster if you use SMARTDrive. "Using SMARTDrive," later in this chapter, explains how to install and optimize SMARTDrive.

- The FILES command line. You should set FILES = 30.
- The BUFFERS command line. In general, you should set BUFFERS = 20 or less. If you are using SMARTDrive, you can set BUFFERS = 10.
- If necessary, a command line for the device driver EGA.SYS.

If your system has an EGA monitor and you run non-Windows applications with Windows in real mode or standard mode, your CONFIG.SYS file should contain a command line like the following:

*device = c:\windows\ega.sys*

## Optimizing Your System

Before you begin optimizing your system, you should consider how you use your system and Windows. You also need to decide what aspects of system performance are most important to you: speed, capacity, and/or disk space. This will depend on which applications you use and what you do with them.

For example, if you normally use a single spreadsheet to manage small amounts of information, speed will probably be most important to you. On the other hand, if you need to run a database, a word processor, and a communications application simultaneously, it will be more important to have enough memory capacity to load all three at once. And, if you are running applications that need extra disk space, you'll also want to be sure you have enough extra disk space to run those applications. Remember to consider the requirements of the applications you want to use.

Once you've decided whether to optimize your system for speed, capacity, free disk space, or a combination of these, you need to decide which method(s) to use to optimize your system. There are several different methods; most have both advantages and drawbacks. For example, using SMARTDrive provides improved speed, but can reduce your system's capacity.

Some optimization methods, such as using SMARTDrive, will be useful for almost everyone. Other methods will help only if you use a specific type of application or have a particular system configuration. The following list shows the methods you can use, what aspect(s) of your system each method improves, and when you would want to use each method. (The methods appear in order of importance.)

**NOTE** Although many of these optimization methods are effective in themselves, the most effective way to improve your system's performance is to configure your system's memory correctly for the way you use Windows and the types of applications you use. For more information, see "Configuring Your System's Memory" earlier in this chapter.

<u>Method</u>	<u>What It Improves</u>	<u>When to Use It</u>
Install additional extended memory	Speed and capacity	If you have an 80286, 80386, or 80486 computer. See “Configuring an 80386 or 80486 Computer” and “Configuring an 80286 Computer” earlier in this chapter.
Free up memory before starting Windows	Capacity and speed	If you want to make more conventional memory available to Windows and applications. See “Freeing Up Memory Before Starting Windows” later in this chapter.
Install SMARTDrive	Speed	If your computer has a hard disk and extended or expanded memory. On most systems, Windows runs much faster if you install SMARTDrive. (However, installing SMARTDrive might result in decreased capacity.) See “Using SMARTDrive” later in this chapter.
Compact your hard disk	Speed	You should compact your disk regularly for good disk maintenance. You should also compact your disk before installing Windows on it, and before creating a permanent swap file on it. See “Improving the Efficiency of Your Hard Disk” later in this chapter.
Free up disk space	Disk space	If you are low on disk space. There are several ways to free up disk space. See “Improving the Efficiency of Your Hard Disk” later in this chapter.

<u>Method</u>	<u>What It Improves</u>	<u>When to Use It</u>
Use a permanent Windows swap file instead of a temporary one	Speed	If you run Windows in 386 enhanced mode and do not mind reserving disk space for Windows' exclusive use. A permanent swap file is very fast, but takes up disk space even when Windows is not running. See "Working with Windows Swap Files" later in this chapter.
Use a temporary Windows swap file instead of a permanent one	Disk space and capacity	If you run Windows in 386 enhanced mode and do not want to reserve disk space for Windows' use. A temporary swap file is much slower than a permanent swap file, but does not take up disk space when Windows is not running. See "Working with Windows Swap Files" later in this chapter.
Tell Windows to create application swap files on a hard disk with more free space	Capacity	If you run Windows in real or standard mode and you have more than one hard disk. See "Working with Application Swap Files" later in this chapter.
Tell Windows to create application swap files on a faster hard disk	Speed	If you run Windows in real or standard mode and you have more than one hard disk. See "Working with Application Swap Files" later in this chapter.
Install RAMDrive	Speed and disk space	If you have a diskless workstation. A RAM disk can also improve speed if you run applications that use many small temporary files.

<u>Method</u>	<u>What It Improves</u>	<u>When to Use It</u>
Set your TEMP environment variable to a faster hard disk or to a RAM disk	Speed	If you run applications that store temporary files in the directory specified by the TEMP variable. See “Using the TEMP Environment Variable” later in this chapter.
Change your hard disk controller’s interleave	Speed	If you are running SMARTDrive and your hard disk still responds sluggishly. See “Improving the Efficiency of Your Hard Disk” later in this chapter.
Install EMM386	Ability to run certain applications	If you have an 80386 or 80486 computer and run applications that require expanded memory when you are not running Windows in 386 enhanced mode. See “Installing the EMM386 Expanded Memory Emulator” later in this chapter.
Install additional expanded memory	Capacity	If you have an 8086 or 8088 computer, or if you have an 80286 computer and want to run applications that require expanded memory. See “Configuring an 80286 Computer” and “Configuring an 8086 or 8088 Computer” earlier in this chapter.
Fine-tune Windows’ use of expanded memory	Speed and capacity	If you have expanded memory and you run Windows in real mode. See “Controlling Windows’ Use of Expanded Memory” later in this chapter.

The rest of this section explains each method.

## Improving the Efficiency of Your Hard Disk

As explained earlier in “Understanding Disk Space,” the amount of free disk space can affect your system’s performance and capacity. In addition, it is important that the information on your disk be structured as efficiently as possible.

You can use the following methods to improve your hard disk’s efficiency:

- Delete files you don’t need.

If your disk is getting full, you should delete files you don’t need or use often. Depending on how you use Windows, you might want to delete certain Windows files to free disk space. The following section lists the Windows files you might want to delete.

- Run the CHKDSK utility to recover lost disk space.

Running CHKDSK can fix lost file clusters that are taking up space on your hard disk.

- Compact your hard disk.

Running a disk-compact utility reorganizes the file structure on your hard disk, so that all the free disk blocks are together. This can greatly improve your system’s speed.

- Change your hard disk controller’s interleave.

A disk’s *interleave* affects how many times the disk must revolve in order for an entire disk track to be read. An improperly interleaved hard disk can be slow and inefficient.

The following sections explain each method.

**386**

**NOTE** If you run Windows in 386 enhanced mode, you can also conserve disk space by preventing Windows from swapping any information to disk. You should do this only if disk space is at a premium, since it can drastically reduce your system’s capacity. To prevent Windows from swapping, edit your SYSTEM.INI file and set *Paging=No* in the [386enh] section of the file. For more information on changing SYSTEM.INI, open the file SYSINI.TXT with a text editor such as Notepad.

### Deleting Unnecessary Files

As explained in “Understanding Disk Space” earlier in this chapter, disk space is a valuable system resource. With Windows, free disk space can provide not only storage for files; it can provide additional capacity for running applications.



If you need more disk space, an easy solution is to delete some unnecessary files. There are three categories of files you might want to delete:

- Application files, documents, or utilities that you no longer need or use.
- Temporary files that were left on your hard disk when an application or Windows terminated unexpectedly.
- Windows files that were installed automatically by Setup, but which you do not need or plan to use. See the list later in this section for details.

---

**CAUTION** Do not delete any Windows files other than the ones listed later in this section.

---

### **Basic Recommendations**

- It is particularly important to delete unnecessary files before compacting a hard disk.
- In general, keep as much disk space free as possible.

### **Advantages**

- Frees up disk space.
- Easy to do.
- Can improve your system's capacity for running both Windows and non-Windows applications, if Windows is running in 386 enhanced mode with a temporary swap file.
- Can allow you to start a larger number of non-Windows applications, if Windows is running in real mode or standard mode.

**386**

### **Disadvantages**

- Makes some Windows features unavailable, if you delete Windows files.

▷ **To delete unnecessary files:**

---

1. While running Windows, exit all applications except Program Manager and File Manager. If you plan to delete Windows wallpaper files, use Control Panel to set your desktop wallpaper to None.
2. If you want, use File Manager to delete any unwanted application files or documents. For information on using File Manager, see Chapter 4, “File Manager.”  
At the end of this procedure is a list describing the Windows files you can delete if you do not plan to use them.
3. Exit Windows and all applications.
4. Delete any files that remain in your TEMP directory, the directory that applications use to store temporary files. (If you have a TEMP directory, it is specified in your AUTOEXEC.BAT file using the SET TEMP command.)  
You should periodically clean out your TEMP directory. To avoid deleting a temporary file that is currently in use, you should delete files in your TEMP directory only when you are not running Windows or any applications.
5. Delete any files that start with the characters ~WOA. These files are application swap files. Normally, Windows deletes application swap files when you exit the associated applications; however, these files might remain on your hard disk if Windows terminates unexpectedly. You can safely delete application swap files if Windows is not currently running.
6. Delete any file named WIN386.SWP. This file is a temporary Windows swap file. Normally, Windows deletes it when you exit Windows. However, a temporary Windows swap file might be left on your hard disk if Windows terminates unexpectedly. You can safely delete WIN386.SWP if Windows is not currently running. (Do not delete files named 386SPART.PAR or SPART.PAR.)
7. If your system is very short on disk space, you might want to delete some Windows files in order to conserve disk space. See the list that follows this procedure for more information on files you can delete.

You can delete the following Windows files if you do not plan to use them:

<u>Filename(s)</u>	<u>Description</u>
*.BMP	Bitmap files with the .BMP filename extension. Setup automatically installs several bitmap files for use as desktop wallpaper.
SOL.EXE, SOL.HLP	Solitaire game and its help text.
REVERSI.EXE, REVERSI.HLP	Reversi game and its help text.
MSDOS.EXE	The MS-DOS Executive.
PBRUSH.EXE, PBRUSH.HLP	Paintbrush accessory and its Help text.
WRITE.EXE, WRITE.HLP	Write accessory and its Help text.
CALENDAR.EXE, CALENDAR.HLP	Calendar accessory and its Help text.
CALC.EXE, CALC.HLP	Calculator accessory and its Help text.
CARDFILE.EXE, CARDFILE.HLP	Cardfile accessory and its Help text.
TERMINAL.EXE, TERMINAL.HLP	Terminal accessory and its Help text.
RECORDER.EXE, RECORDER.HLP, RECORDER.DLL	Recorder accessory, its Help text, and its dynamic-link library.
CLOCK.EXE	Clock accessory.
EMM386.SYS	Expanded memory emulator.

### ***Running the CHKDSK Utility***

The MS-DOS utility CHKDSK can fix lost file clusters that are taking up space on your hard disk. Files can get “lost” when an application terminates unexpectedly, leaving temporary files on the hard disk without saving or deleting them properly. Over time, lost files can accumulate and take up disk space.

When you run CHKDSK with the /F option, it finds and fixes any lost files. If you want, CHKDSK converts them to visible files that you can examine and delete.

---

**CAUTION** Always exit Windows before running CHKDSK with the /F option; never run CHKDSK /F from within Windows. Loss of data might result.

---

### Basic Recommendations

- Run CHKDSK /F occasionally to make sure there are no lost file clusters on your disk.
- Run CHKDSK /F before compacting your disk.
- You also might want to run CHKDSK /F after an application terminates unexpectedly.

### Advantages

- Frees up disk space.
- Easy to do.
- Can improve your system's capacity for running applications, if you are running Windows in 386 enhanced mode with a temporary swap file.

386

### Disadvantage

- Must not be run from Windows.

### ▷ To clean up lost files using CHKDSK:

---

1. Exit from Windows.
2. Change to the hard disk you want to clean up. For example, to clean up files on your drive D, you would type *d:* at the DOS prompt.
3. Enter the command *chkdsk /f*.  
The /F option tells CHKDSK to fix any lost file clusters it finds.
4. If CHKDSK finds any lost clusters, it asks if you want to convert the lost clusters to files. If you want to inspect the contents of the lost clusters before deleting them, type *y* for Yes. (If you are sure the lost clusters do not contain information you want, type *n* for No. CHKDSK will then simply delete the information; you can then skip the remaining steps in this procedure.)

If you answer *y*, CHKDSK converts any lost file clusters to visible files with filenames similar to FILE0001.CHK. It puts the files it finds in the disk's root directory. CHKDSK also displays information about the disk it just checked.

5. Use the MS-DOS TYPE command to examine the .CHK files. For example, to examine the file FILE0001.CHK, you would type *type file0001.chk* at the DOS prompt. (To interrupt the TYPE command, press CTRL + C.)

Sometimes, a .CHK file might contain information you want to keep. For example, if a word processing application terminated before you saved your edits, you might find your lost edits in a recovered CHKDSK file.

6. Delete any .CHK files you don't want.

## ***Compacting Your Hard Disk***

Over time, as applications read from and write to your hard disk, information on your disk can become *fragmented*. Fragmentation occurs when a file, instead of being stored in a single location, is broken into fragments that are stored in different locations on the disk. Although fragmentation doesn't affect the validity of the information—your files are still complete when you read them into an application—it takes much longer to read them from the disk. It also takes longer for applications to write files back to the disk.

To compact your hard disk, you run a disk-compaction utility. Disk-compaction utilities reorganize the information on your disk so that all the information in each file is stored as close together as possible. This makes reading from and writing to your hard disk much more efficient.

---

**CAUTION** Run disk-compaction utilities directly from MS-DOS, after exiting Windows. Never run a disk-compaction utility from Windows; damage to the files on your hard disk might result.

---

### **Basic Recommendations**

- You should compact your hard disk(s) regularly to help keep your system's performance from degrading due to fragmentation.
- You should compact a hard disk immediately before installing Windows on it.
- You should compact a hard disk before creating a permanent Windows swap file on it.
- It is a good idea to delete any unnecessary files, and then run CHKDSK /F, before compacting a hard disk.

### Advantages

- Makes it faster to read and write files on the hard disk. This, in turn, speeds up your system's performance.
- Can significantly speed up the time it takes for Windows and applications to start up.
- Easy to do.
- Can allow you to create a larger permanent Windows swap file.
- Can improve the efficiency of a temporary Windows swap file.

386

386

### Disadvantages

- Takes several minutes to run.
- Must not be run from Windows.
- Windows does not include a disk-compaction utility. However, various disk-compaction utilities are available. (Disk-compaction utilities are sometimes called defragmentation utilities or disk organizers.) See your local computer store for details.

#### ▷ To compact a hard disk:

1. Delete any unnecessary files from that disk using the steps outlined in "Deleting Unnecessary Files" earlier in this chapter.
2. If you are running Windows, exit from Windows.
3. Run the CHKDSK utility with the /F option.  
Never run CHKDSK /F from Windows. The previous section explains how to run CHKDSK /F.
4. Ensure that you are not running any programs that use the hard disk.
5. Run your disk-compaction utility according to the manufacturer's instructions.

### **Changing Your Hard Disk's Interleave**

A hard disk's *interleave* determines how many times the disk must revolve in order for an entire disk track to be read.

On a hard disk, data is organized in concentric circles called *tracks*. As the disk spins, the data on a track is brought beneath the disk head for reading and writing.

Each track is divided into sections called *sectors*. Each sector is referred to by its sector number.

The disk controller reads one sector at a time. On many systems, the disk spins so fast that by the time the controller is ready to read the next numbered sector on that track, that sector has already spun past the disk head. If the sectors were arranged around the track in strict numerical order (sector 1, sector 2, and so on), the disk would have to rotate an extra time to read each sector.

On most hard disks, the sectors are “interleaved”—arranged so that successively numbered sectors are spaced farther apart on a track. For example, instead of arranging sectors in numerical order (1, 2, 3, and so on) successive sectors might be placed 2 or 3 sectors away from each other. On a hard disk with an interleave of 3:1, the controller would read sequential sectors by reading every third sector on the track; the sector numbers on a track might be 1, 7, 13, 2, 8, 14, 3, 9, 15, and so on. This spacing gives the controller time to process the sector it has just read; by the time it is ready to read the next sector, that sector is just moving beneath the head.

The optimum interleave for each hard disk depends on the type of hard disk and controller. The interleave is particularly important if you are using SMARTDrive, since SMARTDrive reads entire disk tracks into its memory cache.

### **Basic Recommendation**

- It is a good idea to adjust your hard disk’s interleave so that it is optimum for your disk type and controller.

### **Advantages**

- An optimum interleave can drastically improve your system’s speed, particularly if you are using SMARTDrive.
- Does not take up memory or disk space.
- Needs to be done only once (although you might want to experiment to find the best interleave for your system).

### **Disadvantages**

- Windows does not include a utility for adjusting the interleave of your hard disk. You can purchase such a utility from your computer store.
- Some disk-interleaving utilities require that you reformat your hard disk; however, a few utilities are capable of safely resetting the interleave without affecting the data on the hard disk.

## ***Freeing Up Memory Before Starting Windows***

You can make more conventional memory available to Windows, and to applications running with Windows, by minimizing how much memory is already in use when you start Windows. Windows can use only the memory that is available when you start it. If memory-resident software is already using memory, then Windows cannot use that memory.

The following section explains how to “streamline” your CONFIG.SYS and AUTOEXEC.BAT files so that they start only programs that you really need. It also explains how to conserve conventional memory when starting memory-resident software.

### ***Streamlining Your CONFIG.SYS and AUTOEXEC.BAT Files***

When you start your computer, the settings in your CONFIG.SYS and AUTOEXEC.BAT files can start device drivers, utilities, and other programs that use memory. You can make more memory available to Windows by removing unnecessary commands and utilities from these files.

#### **Basic Recommendation**

- Avoid starting unnecessary memory-resident software from your CONFIG.SYS and AUTOEXEC.BAT files.

#### **Advantages**

- Can improve your system’s speed.
- Makes more memory available to non-Windows applications that you start from Windows.
- Fairly easy to do.

#### **Disadvantages**

- To effectively streamline your CONFIG.SYS and AUTOEXEC.BAT files, you should know the function of each of the command lines in those files.  
Because the information in these files can determine how your computer starts and runs, you should not change these files unless you know what effect your changes may have.
- When you stop using a utility, you lose the features that the utility provides.



For example, if you disable the RAMDrive command line in your CONFIG.SYS file, you will no longer have a RAM disk, and you will thereby lose the benefits associated with a RAM disk.

---

**CAUTION** Use care when changing your CONFIG.SYS and AUTOEXEC.BAT files. If you incorrectly change or disable some values, your system may not function properly. Therefore, it is important to make a system diskette that contains a backup copy of these files.

---

▷ **To streamline your CONFIG.SYS and AUTOEXEC.BAT files:**

---

1. Make a system diskette that includes a backup copy of both your CONFIG.SYS file and your AUTOEXEC.BAT file.

You can make a system diskette by starting File Manager and then choosing Make System Diskette from the Disk menu. Then copy your current CONFIG.SYS and AUTOEXEC.BAT files to the diskette. (These files are normally located in the root directory of your first hard disk, which is usually drive C.) For more information on performing these tasks, see Chapter 4, “File Manager.”

2. Use a text editor such as Notepad to open and edit each file.
3. Edit the command lines in each file. (For specific information on the command lines in each file, see the sections that follow.)
4. Disable any command lines for unnecessary device drivers and utilities.

When streamlining your CONFIG.SYS and AUTOEXEC.BAT files, it is better to simply disable command lines than to delete them. That way, if you accidentally disable a command line you really need, you can restore it easily. To disable a command line, insert the MS-DOS command REM (for “remark”) at the beginning of the line. For example, to disable the following CONFIG.SYS command line:

*device = c:\device\mouse.sys*

you would insert REM in front of it, as follows:

*rem device = c:\device\mouse.sys*

5. Save the file.
6. When you have finished editing both files, restart your computer.

If your system does not start properly, insert the system diskette you created in step 1 in drive A, and start your computer again. If you know which command line(s) are causing the problem, edit the appropriate file (CONFIG.SYS or AUTOEXEC.BAT) on your hard disk, and restart your computer. Or, to start over, copy the backup version of the file from the diskette to your hard disk.

**NOTE** If you use the REM command to disable command lines in your CONFIG.SYS file, and you are using a version of MS-DOS earlier than 4.0, you'll see a message such as "Unrecognized command in CONFIG.SYS" when you start your computer. Once you are sure that your computer works properly with the command lines disabled, you might want to delete the disabled command lines to avoid the message.

### **Your CONFIG.SYS File**

Your CONFIG.SYS file is a text file that defines device drivers and specifies your MS-DOS configuration. For example, a typical CONFIG.SYS file might specify the location of the MS-DOS file COMMAND.COM, define an extended memory manager, and specify how many files an application can have open at once. MS-DOS runs the command lines in your CONFIG.SYS file before those in your AUTOEXEC.BAT file. (Your CONFIG.SYS file is located in the root directory of your first hard disk, which is usually drive C.)

### **Basic Recommendations**

- Disable command lines for any unnecessary device drivers using the method explained in the preceding section.

Your CONFIG.SYS file should define only device drivers that you absolutely need. (Device drivers are defined using the DEVICE command.)

Do not disable the HIMEM.SYS or SMARTDRV.SYS command lines. When you install Windows, Setup adds those command lines to your CONFIG.SYS file if your system needs those device drivers. For a list of the device drivers your system needs, see the section that applies to your system in "Configuring Your System's Memory" earlier in this chapter.

- Your CONFIG.SYS file should contain a FILES command line that looks like the following:

```
files = 30
```

The FILES command specifies the maximum number of files each application can have open at a time. The larger the number you specify for FILES, the more memory is used up. In general, you should set FILES to 30.

Setting FILES to a value higher than 30 allows each application to open more files, but uses up more conventional memory.

There is no significant advantage to setting FILES to a value lower than 30. With a value below 30, Windows and applications might not run.

- Your CONFIG.SYS file should contain a BUFFERS command line that looks like the following:

```
buffers = 20
```

The `BUFFERS` command line sets the number of disk buffers that MS-DOS allocates in memory when your computer starts. These buffers allow MS-DOS to improve disk access time in certain cases. The larger the number you specify for `BUFFERS`, the more conventional memory is used up. In general, you should set `BUFFERS` to a value from 10 to 20.

If you are using SMARTDrive, you can conserve conventional memory by setting `BUFFERS` to 10.

Setting `BUFFERS` to a value higher than 20 might improve disk access time in some cases (but not as much as other methods, such as using SMARTDrive). However, doing so will use more memory.

- If your `CONFIG.SYS` file includes the `LASTDRIVE` command, you can save some memory by setting `LASTDRIVE` to a letter such as *j* or *k*, rather than to *z*. (If you use a network, this may limit the number of network disk drives you can use simultaneously.)
- If your `CONFIG.SYS` file contains a `SHELL` command that specifies your environment space, you can save some memory by specifying a smaller environment. This will limit how many environment variables you can define using the MS-DOS `SET` command.
- If you are using MS-DOS 3.3 or later, your `CONFIG.SYS` file should contain a `STACKS` command line that looks like the following:

```
stacks = 0,0
```

### **Your `AUTOEXEC.BAT` File**

Your `AUTOEXEC.BAT` file is a special MS-DOS batch file. Like any batch file, it lists MS-DOS commands; when you run the batch file, MS-DOS executes the commands in the file. Unlike other batch files, MS-DOS automatically executes the commands in your `AUTOEXEC.BAT` file immediately after it completes the commands in your `CONFIG.SYS` file. (Your `AUTOEXEC.BAT` file is located in the root directory of your first hard disk, which is usually drive C.)

Typically, an `AUTOEXEC.BAT` file starts memory-resident utilities such as a network and sets up environment variables that are used later by applications. In addition, your `AUTOEXEC.BAT` file might set your DOS prompt or start pop-up programs such as Borland's SideKick.

### **Basic Recommendations**

- If you use a mouse only with Windows and Windows applications, you might want to disable any command lines that start and enable mouse-driver software such as `MOUSE.COM`.

- Disable command lines that start pop-up programs or other memory-resident software. Instead of starting some memory-resident programs from AUTOEXEC.BAT, you might want to start them from within Windows. For more information on running memory-resident software, see the following section and Chapter 12, “More About Applications.”
- Leave intact any command lines that start or enable a network.
- If you have a RAM disk, you might want to set your TEMP variable to the RAM disk. Doing so can speed up applications that store temporary files in the directory specified by the TEMP variable. For example, if your RAM disk has the drive letter E, you might enter the following command lines, which create the directory \TEMP on the RAM disk, then set the TEMP variable to that directory:

```
mkdir e:\temp  
set temp = e:\temp
```

For more information about the TEMP variable, see “Using the TEMP Environment Variable” later in this chapter.

### ***Conserving Memory When Starting Memory-Resident Utilities***

As discussed in the previous section, you’ll probably want to start some memory-resident utilities (such as network drivers) before starting Windows. This ensures that the utilities will be available to all applications you run with Windows. However, doing so takes memory away from non-Windows applications.

There are two ways to conserve memory when starting memory-resident utilities:

- If a particular non-Windows application needs the memory-resident utility, you can start both the utility and the application from the same batch file. This gives the application access to the utility, and does not take memory away from other applications. For more information about running batch files with Windows, see “Creating PIFs for Batch Files” in Chapter 12.
- If only a Windows application uses the memory-resident utility, you might want to start the utility from the special batch file WINSTART.BAT. WINSTART.BAT is a normal batch file, except that Windows automatically runs it after starting in 386 enhanced mode. When you start a utility from WINSTART.BAT, that utility will be available to Windows applications, but not to non-Windows applications. This prevents the utility from taking memory away from non-Windows applications. For example, some Windows programs require the memory-resident IBM Personal Communications/3270 utility. Since this utility uses a fair amount of memory, but is only needed by particular Windows programs, WINSTART.BAT would be an ideal way to start it.

## **Working with Windows Swap Files**

**386**

When you're running Windows in 386 enhanced mode and get low on memory, Windows compensates by swapping information from memory to a *swap file* on your hard disk. A swap file is a hidden file that reserves space on the hard disk for Windows to use for swapping. There are two kinds of Windows swap files: permanent and temporary.

A *permanent swap file* stays on your hard disk until you remove it, and it stays the same size until you change it. It is much faster than a temporary swap file, since it consists of contiguous disk blocks. A permanent swap file stays on your hard disk even when you are not using Windows.

A *temporary swap file* is created dynamically each time you start Windows. When Windows starts in 386 enhanced mode, it checks for the existence of a permanent swap file. If it doesn't find one, it creates a temporary swap file in your Windows directory. When you exit Windows, it deletes the temporary swap file.

**NOTE** A third type of swap file, the *application swap file*, is used only when Windows is running in real or standard mode. For more information, see "Working with Application Swap Files" later in this chapter.

When you are running Windows, you can tell which type of Windows swap file you are currently using, and how large it is, by using Setup.

### **▷ To display information about your swap file:**

- Choose the Windows Setup icon from the Main Group in Program Manager. Setup displays information about your system configuration, including the type of Windows swap file you are currently using: permanent, temporary, or none. If you are using a permanent swap file, Setup also displays your swap file's size and location.

The following sections explain how to work with permanent and temporary Windows swap files.

### **Working with a Permanent Windows Swap File**

**386**

You can set aside a portion of your hard disk for Windows' exclusive use by creating a permanent Windows swap file. Such a swap file is very fast, because it consists of contiguous disk blocks; that is, all parts of the file are together on the disk, rather than fragmented into several pieces. (For more information about

fragmented information on your hard disk, see “Compacting Your Hard Disk” earlier in this chapter.) Another reason that a permanent swap file is so fast is that Windows can access the file directly, bypassing the MS-DOS file system.

**NOTE** A permanent Windows swap file consists of two hidden, write-protected files. The files are named SPART.PAR and 386SPART.PAR. Do not delete, move, or rename these files.

### **Basic Recommendation**

- Whenever possible, use a permanent Windows swap file instead of a temporary one.

### **Advantages**

- Makes Windows run much faster when low on memory.
- Ensures that there will be disk space available for swapping if you run out of real memory.
- Lets you control how much disk space Windows uses for swapping.
- Easy to do.
- Can be adjusted as necessary, or removed altogether.

### **Disadvantages**

- Reduces free disk space. Once you set aside part of your disk as a permanent Windows swap file, only Windows can use that disk space, even when Windows isn’t running.
- Works only on hard disk drives. You cannot set up a permanent Windows swap file on a network disk drive or a memory disk (such as a RAM disk).

### ***Setting Up a Permanent Windows Swap File***

**386**

You can set aside a portion of your hard disk for Windows’ exclusive use by creating a permanent Windows swap file. To create such a swap file, you use the Swapfile application.

▷ **To set up a permanent Windows swap file:**

1. If possible, compact your disk before setting up a permanent swap file. Because a permanent swap file can exist only in contiguous disk space, compacting your disk can make it possible to create a larger permanent swap file. For more information, see “Compacting Your Hard Disk” earlier in this chapter.
2. Start Windows in real mode by typing *win /r* at the DOS prompt.
3. If necessary, close any applications (including File Manager) so that only Program Manager is still running.
4. Run Swapfile by choosing Run from the File menu, typing *swapfile*, and choosing OK.

If you already have a permanent Windows swap file, Swapfile asks what you want to do with your permanent swap file. See the following section for more information.

If you do not currently have a permanent swap file, Swapfile displays the following dialog box:

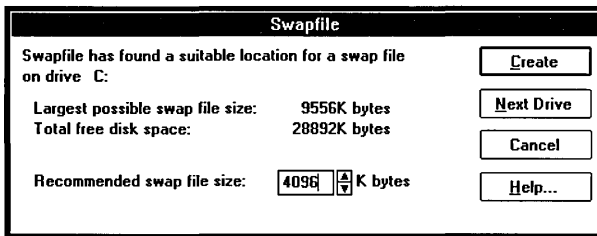

Swapfile examines your hard disk drives to see how much contiguous (unfragmented) space on each disk drive is available for a swap file. (To see information for the next hard disk with sufficient space for a swap file, choose Next Drive.) Swapfile displays the following information about the first disk drive that has sufficient space:

- The size of the largest swap file that can be created on this disk drive (that is, the size of the largest available block of contiguous disk space).
- The total amount of disk space available on this disk drive. This number includes both contiguous and discontinuous disk space.

Based on these two pieces of information, Swapfile recommends a size for the permanent swap file. Swapfile always recommends a file size that will take up no more than half your available disk space.

The first time you set up a permanent swap file, you should probably use the values that Swapfile suggests. If that doesn't work the way you want, you can always go back and adjust the size of the swap file.

5. Make any necessary changes to the options and choose Create.

Swapfile creates a hidden swap file of the specified size on the specified hard disk. The swap file will remain this size, and will stay on your hard disk even when you are not using Windows.

6. Exit from Windows.

7. Start Windows in 386 enhanced mode by typing *win*.

When low on memory, Windows will swap information from memory to the permanent swap file you just created.

The following list explains the options in the Swapfile window:

<u>Use this option</u>	<u>To do this</u>
Recommended swap file size	Specify a size for the permanent swap file you are creating. You can change the file size by clicking the Up or Down scroll arrow to the right of this value.
Create	Tell Swapfile to create a swap file on the specified hard disk drive, using the file size that currently appears in the Recommended swap file size option.
Next Drive	Tell Swapfile to examine the next hard disk drive. Swapfile then displays information about the next disk drive, and recommends a swap file size for that drive.
Cancel	Exit from Swapfile without creating a permanent swap file.
Help	Display information about the Swapfile options.

### ***Changing Your Permanent Windows Swap File***

**386**

Once you have set up a permanent Windows swap file, you can easily change its size or location. You might want to do this to make more disk space available or to give Windows more swapping space. When you make any changes to your permanent swap file, Swapfile simply deletes the current swap file and creates a new one with the size and location you specify.



▷ **To change your existing permanent swap file:**

1. Start Windows in real mode by typing *win /r* at the DOS prompt.
2. If necessary, close any applications (including File Manager) so that only Program Manager is still running.
3. Run Swapfile by choosing Run from the File menu, typing *swapfile*, and choosing OK.

Swapfile displays the following dialog box:

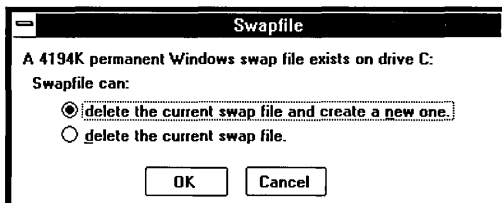

4. Select the option “delete the current swap file and create a new one” and choose OK.

Whenever you make changes to your permanent swap file, you first delete the current file and then create a new swap file. After you select this option, Swapfile deletes your current swap file and displays a message confirming the deletion. You can then create a new swap file.

After deleting your existing swap file, Swapfile displays the following dialog box so that you can create a new swap file:

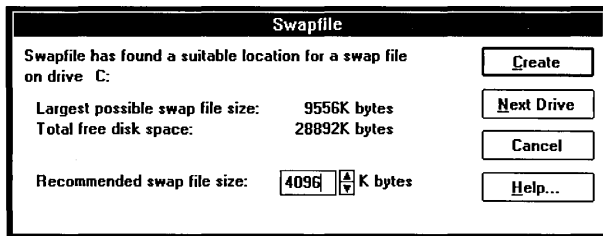

5. Make any changes to the options, and choose Create.

Making the swap file smaller than your previous swap file will free up disk space, but will decrease your system’s capacity and speed.

Making the swap file larger than your previous swap file will increase your system's capacity and speed, but use up more disk space.

Changing the swap file's location from one disk drive to another will affect your system's performance only if one disk drive runs faster or more efficiently than the other. In addition, since different disk drives might have different amounts of free space, the optimum size for the swap file might differ from drive to drive.

6. Exit from Windows.
7. Restart Windows in 386 enhanced mode by typing *win* at the DOS prompt.

### ***Removing Your Permanent Windows Swap File***

**386**

If you no longer want Windows to use a permanent swap file, you can remove your permanent swap file. Windows then uses a temporary swap file instead. See the following section for the advantages and disadvantages of using a temporary swap file.

#### **▷ To remove your permanent Windows swap file:**

1. Start Windows in real mode by typing *win /r* at the DOS prompt.
2. If necessary, close any applications (including File Manager) so that only Program Manager is still running.
3. Run Swapfile by choosing Run from the File menu, typing *swapfile*, and choosing OK.

Swapfile displays the following dialog box:

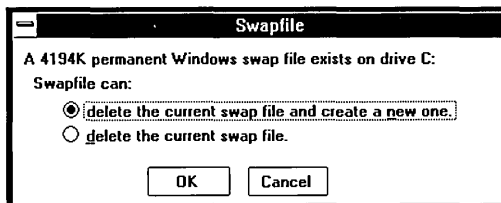

4. To delete your permanent swap file, select the option "delete the current swap file" and choose OK.

Swapfile deletes your permanent swap file and displays a confirmation message.

5. Exit from Windows.
6. Start Windows in 386 enhanced mode by typing *win* at the DOS prompt.

From now on, Windows will create a temporary swap file each time it starts in 386 enhanced mode; it deletes the temporary swap file when you exit from Windows.

Even without a permanent Windows swap file, you can still control how much disk space Windows uses for swapping. See the following section for more information.

### ***Working with a Temporary Windows Swap File***

**386**

If you choose not to use a permanent Windows swap file, when you start Windows in 386 enhanced mode, it automatically creates a temporary swap file instead. Later, if you run low on memory, Windows uses the temporary swap file to provide additional capacity, just as it does with a permanent swap file. The difference is that, when you exit from Windows, it deletes the temporary swap file. A permanent swap file, on the other hand, remains on your disk even when you are not using Windows.

Your temporary Windows swap file is named WIN386.SWP, and is normally located in your Windows directory. You can tell Windows to put your temporary swap file in a different location by changing a setting in your SYSTEM.INI file. (Never delete, move, or rename your Windows swap file directly.) For more information, see “Changing the Location of Your Temporary Windows Swap File” later in this chapter.

The size of your temporary swap file will vary depending on how much memory you need. When Windows starts, it normally creates a 1024K temporary swap file. It enlarges the file as necessary to accommodate any additional memory requirements, and reduces the file if you need less memory. You can limit how much disk space your temporary swap file uses by changing settings in your SYSTEM.INI file. For more information, see “Controlling the Size of Your Temporary Windows Swap File” later in this chapter.

#### **Basic Recommendations**

- Use a temporary Windows swap file if you do not want Windows to use up disk space when it is not running.
- Whenever possible, use a permanent swap file instead of a temporary swap file. (You might have to use a temporary swap file if there is not enough contiguous disk space to create a permanent swap file.)

### Advantages

- Takes up disk space only when you are running Windows in 386 enhanced mode.
- Fairly easy to do.
- Can be adjusted as necessary.
- Does not require contiguous disk space.

### Disadvantages

- Slows down start-up time for Windows because Windows must create the temporary swap file.
- Slower than a permanent swap file.

### ***Setting Up a Temporary Windows Swap File***

**386**

If you have not set up a permanent Windows swap file, you need do nothing to set up a temporary swap file, since Windows creates one automatically each time it starts. Windows normally creates the temporary swap file in your Windows directory. The following section explains how to specify a different drive for the swap file.

If you are currently using a permanent swap file, you can change to a temporary swap file simply by removing your permanent swap file. For information on how to do this, see “Removing Your Permanent Windows Swap File” earlier in this chapter.

### ***Changing the Location of Your Temporary Windows Swap File***

**386**

Normally, Windows creates its temporary swap file in the Windows directory. You can tell Windows to create the file in the root directory of a specific disk drive by changing the PagingDrive setting in your SYSTEM.INI file. If you have more than one hard disk, you might want to ensure that Windows creates the file on the fastest hard disk.

### Basic Recommendations

- If you have more than one hard disk, you can improve Windows’ capacity by setting PagingDrive to the hard disk with the most free space.
- If you have more than one hard disk and the disks differ in efficiency, you can improve Windows’ speed by setting PagingDrive to your fastest hard disk.

- Do not set PagingDrive to a RAM disk. Doing so would not result in an increase in speed, since Windows would simply swap information from one area of memory to another.

▷ **To specify a different drive for your temporary swap file:**

---

1. Open your SYSTEM.INI file using a text editor such as Notepad. Your SYSTEM.INI file is located in your Windows directory.
2. Find the [386enh] section of the file. (If you're using Notepad, you can do this by choosing Find from the Search menu, typing [386enh], and choosing OK.)
3. Add or change the PagingDrive setting to tell Windows on which drive to create the temporary swap file. The PagingDrive setting must be a drive letter followed by a colon (:).

For example, to tell Windows to create its temporary swap file on drive E, you would type the following:

*PagingDrive = e:*

4. Save your SYSTEM.INI file.
5. Exit and restart Windows.

***Controlling the Size of Your Temporary Windows Swap File***

386

If you don't have a permanent swap file, Windows creates a temporary swap file when you start Windows. Normally, this file starts out with a size of 1024K; Windows enlarges the file as necessary, depending on your memory requirements. However, sometimes you might want more control over the file's size, particularly if your computer is short on disk space.

▷ **To control the size of your temporary Windows swap file:**

---

1. Open your SYSTEM.INI file using a text editor such as Notepad. Your SYSTEM.INI file is located in your Windows directory.
2. Find the [386enh] section of the file. (If you're using Notepad, you can do this by choosing Find from the Search menu, typing [386enh], and choosing OK.)
3. Define the size you want for your temporary swap file by specifying values for the MinUserDiskSpace and/or the MaxPagingFileSize settings. (If the [386enh] section does not contain these settings, simply add the setting(s) you want.) You can specify either or both settings. The following list explains each setting:

<u>Use this setting</u>	<u>To do this</u>
MinUserDiskSpace	Tell Windows how much disk space to leave free when creating the temporary swap file. For example, if you set <i>MinUserDiskSpace</i> = 2048, Windows would always leave at least 2048K of disk space free.
MaxPagingFileSize	Specify a maximum size for the temporary swap file. For example, if you set <i>MaxPagingFileSize</i> = 1024, Windows would never create a swap file larger than 1024K.

4. Save your SYSTEM.INI file.
5. Exit and restart Windows.

## ***Working with Application Swap Files***

In real mode or standard mode, when you start a non-Windows application, Windows creates a temporary *application swap file* for that application. (Windows does not use application swap files in 386 enhanced mode.) When you switch away from the application, Windows moves some or all of the application from memory to the application swap file. This helps make your system's memory resources last longer. When you exit the application, Windows deletes the associated application swap file.

Application swap files are hidden files with names that start with the characters ~WOA. Windows puts these files in the directory specified by the Swapdisk setting in your SYSTEM.INI file. If the Swapdisk setting is not set, Windows places the files in your Windows directory.

The location Windows uses to store application swap files can affect your system's speed and available disk space.

### **Basic Recommendations**

- Set the Swapdisk setting to a hard disk with at least 512K of free disk space. If you have more than one hard disk, set Swapdisk to the disk with the most free space.
 

The more disk space Windows can use for application swap files, the more non-Windows applications you can run at a time.
- If you have more than one hard disk and the disks differ in speed, you might want to set the Swapdisk setting to the fastest disk.

- Usually, it is not a good idea to set Swapdisk to a RAM disk. If the Swapdisk setting specifies a RAM disk, when Windows tries to swap application information from memory to disk, it instead swaps it to another area of memory (since the RAM disk exists in memory).

However, you might want to set Swapdisk to a RAM disk if you run Windows in real mode with a single non-Windows application. In that case, setting Swapdisk to a RAM disk will enable you to switch to and from the application quickly.

▷ **To change the location Windows uses for application swap files:**

---

1. Open your SYSTEM.INI file using a text editor such as Notepad. Your SYSTEM.INI file is located in your Windows directory.
2. Find or add the [NonWindowsApp] section of the file.  
If you're using Notepad, you can do this by choosing Find from the Search menu, typing *[NonWindowsApp]*, and choosing OK.
3. Add or change the Swapdisk setting.  
Set Swapdisk to the directory and drive you want.  
For example, to tell Windows to create application swap files in the \TEMP directory on drive D, you would type the following:  
*swapdisk = d:\temp*
4. Save your SYSTEM.INI file.
5. Exit and restart Windows.

For more information about SYSTEM.INI settings, open the SYSINI.TXT file using a text editor such as Notepad.

## ***Using SMARTDrive***

SMARTDrive is a disk-caching program for computers that have a hard disk and extended or expanded memory. Disk-caching programs can reduce the amount of time your computer spends reading data from your hard disk. SMARTDrive, unlike other disk-caching programs, cooperates with Windows to provide the most effective use of your system's memory.

SMARTDrive saves information read from your hard disk in your computer's expanded or extended memory. When an application tries to read that information from the hard disk, SMARTDrive supplies the information directly from memory

instead. SMARTDrive always copies new or modified information to the hard disk, so there is no danger of losing information when you turn off your computer.

You install SMARTDrive by adding the SMARTDrive command line to your CONFIG.SYS file. (When you installed Windows, Setup should have done this for you.)

### **Basic Recommendations**

Because the optimum settings for SMARTDrive depend on your Windows mode, the applications you run, and your system configuration, there is no single “best setting” for SMARTDrive. After installing SMARTDrive, you might want to experiment to find the optimum settings for your system.

The following are basic recommendations you can start with:

- You should use SMARTDrive if your system has a hard disk and at least 512K of extended memory or 256K of expanded memory. Windows runs much faster with SMARTDrive.
- If you run Windows in standard or 386 enhanced mode, run SMARTDrive in extended memory.
- If you always run Windows in real mode and your system has expanded memory, run SMARTDrive in expanded memory. (Add the /A switch to the SMARTDrive command line.)
- To start with, set the normal cache size as large as possible, and set the minimum cache size to 256K. “Specifying the Size of the SMARTDrive Cache,” later in this chapter, explains more about figuring out the best cache size for your system.
- If possible, compact your hard disk regularly. SMARTDrive runs best if the files on your hard disk are not fragmented.

### **Advantages**

- Improves speed on all systems.
- Ideal for users who work with many applications and files at once. It is especially useful when you run multiple non-Windows applications.
- Installed automatically by Setup.
- Fairly easy to adjust.



### Disadvantages

- Reduces your system's capacity.
- Requires either extended or expanded memory.
- Cannot be used in conjunction with other disk-caching programs.

**NOTE** Windows/386™ version 2.x will not run in conjunction with SMARTDrive version 3.0.

### *Installing SMARTDrive*

When you install Windows, Setup copies the SMARTDRV.SYS file to your Windows directory and adds the SMARTDrive command line to your CONFIG.SYS file. If, for some reason, Setup did not install SMARTDrive on your system, or if you later removed SMARTDrive, you can install it by using the following procedure.

#### ▷ To install SMARTDrive:

1. Configure your system's memory for optimum efficiency with Windows. See "Configuring Your System's Memory" earlier in this chapter.
2. Make a system diskette that includes a backup copy of your CONFIG.SYS file. You can make a system diskette by starting File Manager and then choosing Make System Diskette from the Disk menu. Then copy your current CONFIG.SYS file to the diskette. For more information on performing these tasks, see Chapter 4, "File Manager."
3. Open your CONFIG.SYS file using a text editor such as Notepad.
4. Add a command line for SMARTDRV.SYS to your CONFIG.SYS file.

The command line tells MS-DOS where to find the SMARTDRV.SYS file, defines the size of SMARTDrive's memory cache, and (optionally) specifies whether to use extended or expanded memory. The following is a typical SMARTDrive command line:

```
device = c:\windows\smartdrv.sys 1024 256
```

This command line tells MS-DOS that SMARTDRV.SYS is in the \WINDOWS directory on drive C. It runs SMARTDrive in extended memory, since SMARTDrive runs in extended memory by default. It gives SMARTDrive a 1024K cache, and specifies a minimum cache size of 256K.

If you run SMARTDrive in extended memory, the SMARTDRV.SYS command line must come after the HIMEM.SYS command line.

If you run SMARTDrive in expanded memory, the SMARTDRV.SYS command line must come after the command line for your expanded memory manager.

5. Disable or remove any other command lines for disk-caching software.
6. Save the changes to your CONFIG.SYS file.
7. Restart your computer.

For additional information about setting up and optimizing SMARTDrive on your system, see the following sections. For details about the SMARTDrive command line and its optional parameters, see the following sections and Appendix D, “Command Lines in the CONFIG.SYS File.”

### ***Running SMARTDrive in Extended or Expanded Memory***

SMARTDrive can run in either extended or expanded memory. By default, it uses extended memory. To run SMARTDrive in expanded memory instead, add the /A switch to the end of the SMARTDrive command line.

#### **Basic Recommendation**

- You should run SMARTDrive in extended memory unless your system has only expanded memory. In that case, run SMARTDrive in expanded memory.

### ***Specifying the Size of the SMARTDrive Cache***

The size of SMARTDrive’s disk cache affects SMARTDrive’s efficiency. In general, the larger the cache, the less often SMARTDrive needs to read data from the disk.

The SMARTDrive command line specifies two values for the cache size:

- The *normal cache size* determines the size of the cache when SMARTDrive starts or when Windows is not running. The normal cache size is the first numeric parameter on the SMARTDrive command line.
- The *minimum cache size* limits how much Windows can reduce the cache size. Windows reduces the size of SMARTDrive’s cache to recover memory for its own use. Windows and SMARTDrive then cooperate to provide optimum use of your system’s memory. When you exit Windows, it restores the cache to its normal size. The minimum cache size is the second numeric parameter on the SMARTDrive command line.

When Windows starts in standard mode or 386 enhanced mode and SMARTDrive’s cache is in extended memory, Windows immediately reduces

the cache to its minimum size. (Windows cannot reduce an expanded-memory cache when running in standard mode or 386 enhanced mode.)

If Windows is running in real mode and SMARTDrive's cache is in expanded memory, Windows reduces the cache size gradually as the memory becomes necessary. (Windows cannot reduce an extended-memory cache when running in real mode.)

The following SMARTDrive command line starts SMARTDrive in extended memory, sets the normal cache size to 1024K, and sets the minimum cache size to 256K:

```
device = c:\windows\smartdrv.sys 1024 256
```

When creating its cache, SMARTDrive rounds the specified cache size down to the nearest multiple of the largest disk track size. In other words, the actual size of the SMARTDrive cache depends on how many disk tracks will fit in the cache. When you start SMARTDrive, it determines how many disk tracks can fit in the amount of memory you specified for the cache. Thereafter, SMARTDrive will cache no more than that number of disk tracks at a time. For example, if the track size on your hard disk is 10K and you have set up a 256K cache, then 25 tracks will fit in the cache. SMARTDrive will then cache no more than 25 tracks at a time, and will create a cache that uses 250K, not 256K, of memory.

In general, SMARTDrive runs most efficiently with disks that have small tracks. If you have several hard disks with different track sizes, SMARTDrive uses the largest track size to determine how many tracks it can cache at a time. For example, if one hard disk has a track size of 10K and the other has a track size of 5K, and you have set up a 128K cache, SMARTDrive determines that 12 of the 10K tracks will fit in the cache. Thereafter, it will cache no more than 10 tracks at a time, even though it could cache 25 of the 5K disk tracks.

**NOTE** The SMARTDrive driver uses at least 17K of conventional memory in order to run. The larger the cache sizes you specify, the more conventional memory SMARTDrive uses.

### **Basic Recommendations**

Because the optimum cache sizes for SMARTDrive depend on how you use your system, there is no single "best setting." You should experiment to find the best cache sizes for your system.

The following are basic recommendations you can start with:

- Set the normal cache size to between 256K and 1024K. (Set it as large as possible within that range.)  
Setting the cache size to less than 256K is not a good idea, since SMARTDrive will probably not be able to cache enough information to be effective.  
Setting the cache size larger than 1024K might not be the best use of your system's memory. Although, in general, a larger cache is faster, you get less return on your memory investment as the cache size increases above 1024K. For example, increasing a 256K cache to 512K might improve your system's speed by 20 percent. However, increasing a 1024K cache the same amount, from 1024K to 1280K, might improve speed by only 2 percent.
- Set the minimum cache size to at least 256K.  
When Windows is running, it can reduce the cache to recover memory for its own use. Setting the minimum cache size above 1024K might prevent Windows from making effective use of memory. Setting the minimum cache size below 256K might handicap SMARTDrive while Windows is running, since a cache smaller than 256K is not particularly useful.

### ***Using Alternative Disk-Caching Programs with Windows***

Although you can use other disk-caching programs in conjunction with Windows 3.0, there are drawbacks to doing so. SMARTDrive is designed to cooperate with Windows; other disk-caching programs might not do so. Using other disk-caching programs might result in less effective memory management, slower performance, or even memory-management conflicts between the disk-caching program and Windows.

## ***Using RAMDrive***

RAMDrive is a memory-resident utility that lets you use part of your system's memory as if it were a hard disk drive. This memory area is called a *RAM disk* because it exists in memory (RAM). RAM disks are much faster than hard disks because your computer can read information faster from memory than from a hard disk. A RAM disk appears to be a normal hard disk drive; you can use it just as you would any disk drive. The most important difference between a real disk drive and a RAM disk is that, since it exists only in memory, information on a RAM disk is lost when you turn off or reset your computer.

### **Basic Recommendations**

- Install RAMDrive only if you really need a RAM disk. In many cases, using the same amount of memory for SMARTDrive will improve your system's speed more than RAMDrive would.
- You might want to install RAMDrive if you use a diskless workstation on a network, and the workstation has plenty of memory.
- You might also want to install RAMDrive if you often run applications that use many small temporary files. In that case, set up a RAM disk of about 256K, and set your TEMP environment variable to the RAM disk. For additional information, see "Using the TEMP Environment Variable" later in this chapter.

### **Advantages**

- Provides you with a very fast disk drive.
- Provides additional disk space for temporary storage.
- Fairly easy to set up.

### **Disadvantages**

- Uses additional memory, which can cut down your system's speed and capacity. (For many systems, SMARTDrive is a better use of your system's memory than RAMDrive.)
- When you turn off your computer, it does not save information that is stored on the RAM disk. Because of this, the RAM disk is best for storing temporary files, not for saving data files that may change.
- Whenever you restart your computer, the RAM disk is re-created. This means you must recopy information (except temporary files) to your RAM disk each time you start your computer.

### ***Setting Up RAMDrive***

When you install Windows, Setup puts a copy of the RAMDRIVE.SYS file in your Windows directory.

▷ **To set up RAMDrive:**

1. Configure your system's memory for optimum efficiency with Windows. For more information, see "Configuring Your System's Memory" earlier in this chapter.
2. Make a system diskette that includes a backup copy of your CONFIG.SYS file.  
You can make a system diskette by starting File Manager and then choosing Make System Diskette from the Disk menu. Then copy your current CONFIG.SYS file to the diskette. For more information on performing these tasks, see Chapter 4, "File Manager."
3. Open your CONFIG.SYS file using a text editor such as Notepad.
4. Add a command line for RAMDRIVE.SYS to your CONFIG.SYS file.  
The command line tells MS-DOS where to find the RAMDRIVE.SYS file and how much memory to allocate to RAMDrive. The following is a typical RAMDrive command line:  

```
device = c:\windows\ramdrive.sys 256 /e
```

  
This command line gives RAMDrive 256K of extended memory and tells MS-DOS that RAMDRIVE.SYS is in the \WINDOWS directory on drive C.  
If you run RAMDrive in extended memory, the RAMDRIVE.SYS command line must come after the command line that starts HIMEM.SYS.
5. Save the changes to your CONFIG.SYS file.
6. Restart your computer.

For more information about the RAMDrive command line and its optional parameters, see Appendix D, "Command Lines in the CONFIG.SYS File."

### ***Using Other Memory-Disk Programs with Windows***

Although you can use other memory-disk programs in conjunction with Windows, it is best to use RAMDrive. When you run RAMDrive in extended memory, it cooperates with the version of HIMEM.SYS that comes with Windows, and uses less conventional memory than other memory-disk programs.

### ***Using the TEMP Environment Variable***

Many applications use temporary files to store data while they're running. Some of these applications store temporary files in the directory specified by the TEMP

environment variable. For information about how your applications store temporary files, consult the applications' documentation.

You set the TEMP variable using the MS-DOS SET command. (Typically, the SET command is in your AUTOEXEC.BAT file.) For example, the following command line sets the TEMP variable to the C:\TEMPFILES directory:

```
set temp=c:\tempfiles
```

Setting the TEMP variable affects only those applications that check for the value of TEMP. The location you specify for temporary files can affect the speed of applications that use the TEMP variable. For example, if the TEMP variable specifies a relatively slow hard disk, applications that store temporary files on that drive might run at less than optimum speed.

### **Basic Recommendations**

- Set the TEMP variable to a subdirectory, not to the root directory.  
MS-DOS allows you to create only a limited number of files in the root directory of a disk, but lets you create as many files as you need within a subdirectory.
- Set the TEMP variable to a disk that has enough free space for the temporary files your application creates. Consult the application's documentation for more information about how the application uses temporary files.
- If you use RAMDrive, you might want to set the TEMP variable to your RAM disk.

Because it's much faster to read information from memory than from a hard disk, an application that uses temporary files might run faster if it stores its temporary files on a RAM disk. Since most applications delete their temporary files when they're finished using them, you don't need to worry about saving copies of those files before turning off your computer.

## ***Controlling Windows' Use of Expanded Memory***

If your system has expanded memory that meets the LIM EMS 4.0 standard, Windows makes extensive use of that expanded memory when running in real mode. Depending on how much conventional and expanded memory is available, Windows uses expanded memory in one of two ways: small-frame EMS mode or large-frame EMS mode.

In Windows, small-frame EMS mode is more efficient if there is less conventional memory available, and is especially useful for running a single, large Windows

application. Large-frame EMS mode is better for running multiple Windows applications simultaneously. However, with large-frame EMS mode, less total memory is available to each individual application.

Normally, when you start Windows in real mode, Windows determines which EMS mode to use, based on how much conventional and expanded memory is available. However, sometimes you might want more control over which EMS mode Windows uses. For example, since small-frame EMS mode is better for running a single, large application, if you only run one application at a time, you might want to ensure that Windows uses small-frame EMS mode.

### ***Running Windows in Small-Frame EMS Mode***

If you are running only one Windows application at a time, you can try using the /E switch to make sure Windows is starting in small-frame EMS mode. Typically, in small-frame EMS mode, there is more expanded memory available for the application you want to run.

The /E switch tells Windows how much conventional memory must be available in order to use large-frame EMS mode. If there is less conventional memory available than you specified, Windows starts in small-frame mode instead of large-frame mode. Therefore, to make sure Windows starts in small-frame mode, specify an amount of conventional memory that you're sure will not be available (for example, 999K).

#### **▷ To run Windows in real mode and small-frame EMS mode:**

---

- Start Windows by typing the following:

```
win /r /e 999
```

This command line starts Windows in real mode (/R) and tells it to use small-frame EMS mode if there is less than 999K of conventional memory available (/E 999). Since no computer will have more than 640K of conventional memory available, this is a reliable way to ensure that Windows uses the small-frame EMS mode.

### ***Moving the EMS Bank Line in Large-Frame EMS Mode***

With large-frame EMS mode, Windows divides all available memory into two sections: global memory and banked memory. The *EMS bank line* is the dividing line between these two sections of memory. *Global memory* is located below the EMS bank line, and is available to all applications. *Banked memory* is located above the bank line, and is available to one application at a time.



With large-frame EMS mode, applications need both global and banked memory in order to run. Therefore, if you run out of either global or banked memory, you might not be able to start additional applications.

You can “fine-tune” the way Windows uses large-frame EMS mode by moving the EMS bank line up or down in memory. Moving the bank line down makes more banked memory available and reduces the amount of global EMS memory available. Moving the bank line up does the opposite; it decreases banked memory and increases global memory.

You might want to move the bank line if you are running an application that runs out of banked memory before it runs out of global memory, or vice versa. Optimizing by moving the EMS bank line is generally by trial and error: you set the bank line at a particular position, run the application, observe which type of memory it runs out of first, and adjust the bank line as necessary until you find the optimum position for the line.

To move the bank line, you start Windows with the /L switch. This switch moves the bank line up or down by 1-kilobyte increments. (Because the EMS bank line exists only in large-frame EMS mode, the /L switch has no effect when you start Windows in small-frame mode.)

▷ **To move the EMS bank line:**

- Start Windows in real mode with the /R and /L switches.

You can use the /L switch to move the bank line from 1 to 16 kilobytes in either direction. For example, the following command line starts Windows in real mode and moves the EMS bank line down 8 kilobytes:

```
win /r /l -8
```

The following command line starts Windows in real mode and moves the EMS bank line up 16 kilobytes:

```
win /r /l +16
```

## ***Installing the EMM386 Expanded Memory Emulator***

**386**

An *expanded memory emulator* is a utility that simulates expanded memory for applications that use expanded memory. Windows includes the expanded memory emulator EMM386.SYS (for use on 80386 and 80486 systems only). (When you install Windows, Setup copies the EMM386.SYS file to your Windows directory.) You should use EMM386.SYS only if necessary.

When running in 386 enhanced mode, Windows can simulate expanded memory for applications that need it. However, sometimes you might use applications that require expanded memory when you're not running Windows in 386 enhanced mode. You might want to install EMM386.SYS in the following situations:

- When your CONFIG.SYS or AUTOEXEC.BAT file starts programs that require expanded memory.
- When you want to run an application that requires expanded memory with Windows in real mode, or when you are not running Windows.

**NOTE** To use a Windows application that requires expanded memory with Windows in standard mode, you need to configure your system so that it provides as much physical expanded memory as the application needs. For more information, see "Configuring Your System's Memory" earlier in this chapter.

### Basic Recommendations

- Install EMM386 only if you really need it.
- If you install EMM386, allocate it as much memory as the application needs. For example, if you want to run an application that requires 256K of expanded memory when you are not running Windows, you would allocate 256K of memory to EMM386.

### ▷ To install EMM386.SYS:

1. Configure your system's memory for optimum efficiency with Windows. For more information, see "Configuring Your System's Memory" earlier in this chapter.
2. Make a system diskette that includes a backup copy of your CONFIG.SYS file. You can make a system diskette by starting File Manager and then choosing Make System Diskette from the Disk menu. Then copy your current CONFIG.SYS file to the diskette. For more information on performing these tasks, see Chapter 4, "File Manager."
3. Open your CONFIG.SYS file using a text editor such as Notepad. Your CONFIG.SYS file is normally located in your hard disk's root directory.

4. Add a command line for EMM386.SYS to your CONFIG.SYS file.

The command line tells MS-DOS where to find the EMM386.SYS file and how much extended memory to allocate to EMM386. EMM386 will then provide that amount of expanded memory to applications that need it.

The following is a typical EMM386 command line:

```
device = c:\windows\emm386.sys 640
```

It gives EMM386 640K of memory and tells MS-DOS that EMM386.SYS is in the \WINDOWS directory on drive C.

The EMM386.SYS command line must come after the command line that starts HIMEM.SYS, but before any command lines for programs that use expanded memory.

5. Disable or remove any other command lines for expanded memory management software.
6. Save the changes to your CONFIG.SYS file.
7. Restart your computer.

For more information about the EMM386 command line and its optional switches and arguments, see Appendix D, "Command Lines in the CONFIG.SYS File."

### ***Using Alternatives to EMM386***

If possible, you should use the version of EMM386 that came with the version of Windows you are using. EMM386 was designed to cooperate with Windows and its management of extended memory. Windows will not run in standard or 386 enhanced mode in conjunction with current versions of other expanded memory emulators (for example, 386-Max <sup>™</sup>, CEMM, and QEMM). If you use one of these utilities instead of EMM386, Windows will run only in real mode. (Note that future versions of these utilities might be enhanced so that they cooperate with Windows.)

---

---

**Chapter**  
**14**

***Networks and Windows***

**Getting Windows from a Network** .....545

**Using Networks with Windows** .....546

    Guidelines for Using Networks ..... 546

    Windows Network Features ..... 547

    Using an Unsupported Network ..... 547

**Putting Windows on a Network** .....553

    Giving Users Access to Network Applications ..... 554

    Putting Additional Network Files on a User's System ..... 556

Vertical line on the left side of the page.

## Getting Windows from a Network

If a system administrator has put a shared copy of Microsoft Windows on a network, you can install it on your system by running Setup with the /N (network) switch.

Setup copies some Windows files to your personal Windows directory, which is usually located on your hard disk. You specify the name of your personal Windows directory when you run Setup. This directory is required in order to run Windows.

By maintaining your own copies of these files, you can customize Windows according to your preferences, even though you are still sharing most Windows files with the other users on the network.

**NOTE** Check with your network system administrator for any special instructions before installing the shared copy of Windows.

### ▷ To install a shared copy of Windows from a network:

---

1. Connect to the network.
2. Change to the directory where Windows is located on the network.
3. Type *setup /n* at the DOS prompt.
4. Follow the instructions on the screen.

Setup will ask you where it should put your Windows files. Type in the path-name of your personal Windows directory. Setup will copy to your directory only the files that contain information relevant to your system.

If you are using a diskless workstation (your machine does not have a hard disk), follow the preceding instructions for installing a shared copy of Windows from a network. But instead of having Setup copy the Windows files to a hard disk, specify that Setup should copy them to your personal Windows directory on a network disk drive. Ask your system administrator if you are not sure what directory you should use as your personal Windows directory.

## ***Using Networks with Windows***

Windows provides many features that make it easier to work with a network's resources. But before you can use these features, you need to be aware of some basic guidelines for using networks. This section lists these guidelines, outlines Windows network features, and describes what to do if your network does not support some or all of these features.

### ***Guidelines for Using Networks***

You can avoid many problems when using Windows with a network by following these guidelines:

- Make sure your network software is compatible with Windows 3.0 by reading the NETWORK.TXT file that is included with Windows. This file contains a list of all network versions that are compatible with Windows 3.0.
- Always start the network before you start Windows.

You can connect to network disk drives and printers after you start Windows, but you must make sure the network software is running on your machine before you start Windows. Otherwise your system will likely fail.
- Ask your network system administrator about the procedures you should follow for storing your personal files.

You might be required to keep your files out of a shared directory, where you could lose them or interfere with the files of other users.
- Every time you connect to a network disk drive to start Windows (or another shared application), use the same letter to designate that network disk drive on your system.

For example, if you select the letter W when you connect to the network disk drive to set up a shared copy of Windows on your local hard drive, Windows will record W as the path it should use in the future to look for the shared Windows files. If you connect to the same network disk drive next time using any letter other than W, you will not be able to run Windows correctly.
- Every time you connect to a network printer, use the same port for that particular printer.

Control Panel remembers the printer settings for a particular port. Therefore, if you change the port you are using for a printer, the settings for the new port may not be correct for that printer.

## ***Windows Network Features***

This *User's Guide* describes a number of Windows features that enable you to work with a network more easily. The following list describes where to find information about these features.

Windows allows you to:

- Configure Windows for a particular type of network. For information, see “Changing Settings” in Appendix A.
- Connect your system to a particular network disk drive. On some networks, you can even browse through network disk drives to find the one you want. For information, see Chapter 4, “File Manager.”
- Set options that are specific to your network. For information, see Chapter 5, “Control Panel.”
- Set up network printer connections. For information, see Chapter 5, “Control Panel.”
- Take advantage of special features offered by Windows Print Manager when using a network printer. For information, see Chapter 6, “Print Manager.”
- Configure your system so that your network can take advantage of expanded memory. For information, see Chapter 13, “Optimizing Windows.”

## ***Using an Unsupported Network***

The extent to which you can use Windows network features depends on the network you use. An unsupported network is one that does not allow you to use all of these features.

Contact your network manufacturer for information about a version of its network software that is compatible with Windows 3.0.

If you are using an unsupported network, you might have trouble running Windows or certain applications. This section contains recommendations for overcoming trouble areas you might encounter.



## ***If Your System Fails When You Start Windows in Standard Mode***

If your system fails when you start Windows in standard mode, it is possible that your network does not support Windows in this mode. Try starting Windows in real mode by typing *win /r* at the DOS prompt.

386

## ***If Your System Fails When You Start Windows in 386 Enhanced Mode***

Depending on what unsupported network you are using, your system might fail when you start Windows in 386 enhanced mode for one of two possible reasons:

- Most likely, your network does not support Windows in this mode.  
Try starting Windows in standard mode by typing *win /s* at the DOS prompt.
- Windows might not run in 386 enhanced mode if the network is not set up to handle the way your network card uses memory. This problem can take two forms.

First, the network may require a larger buffer for direct memory access (DMA) data transfers than Windows normally provides. Second, your network may not be able to run unless Windows is prevented from using a portion of memory between 640K and 1MB to map unused address space.

You can make Windows running in 386 enhanced mode compatible with your network card by changing the NetDMASize or EMMExclude setting in your SYSTEM.INI file. Whether you will need to change these settings depends on your network hardware.

---

**CAUTION** Use care when changing your SYSTEM.INI file. If you incorrectly change its contents, your system may not function properly. See your network administrator before changing these settings.

---

386

▷ **To change the size of the direct memory access buffer:**

1. Open your SYSTEM.INI file using a text editor such as Notepad.  
Your SYSTEM.INI file is located in your personal Windows directory.
2. Find the [386enh] section of the file. (If you are using Notepad, you can do this by choosing Find from the Search menu, typing [386enh], and choosing OK.)
3. Add the NetDMASize setting if you need to tell Windows how much memory (in kilobytes) to reserve for direct memory access. The default value is 32 on Micro Channel machines (such as the IBM PS/2 ®) or 0 on other machines.  
For example, to tell Windows to provide a 32K buffer for direct memory access, you would type the following:  
*NetDMASize= 32*
4. Save your SYSTEM.INI file.
5. Exit and restart Windows in 386 enhanced mode.

386

▷ **To prevent Windows from scanning or using a part of conventional memory:**

1. Open your SYSTEM.INI file using a text editor such as Notepad.  
Your SYSTEM.INI file is located in your personal Windows directory.
2. Find the [386enh] section of the file. (If you are using Notepad, you can do this by choosing Find from the Search menu, typing [386enh], and choosing OK.)
3. Add the EMMEExclude setting to specify a range of memory addresses.  
Windows will be prevented from scanning these addresses when running in 386 enhanced mode.  
For example, to tell Windows not to scan the addresses between C800:0000 and D000:0000, you would type the following:  
*EMMEExclude = C800-CFFF*
4. Save your SYSTEM.INI file.
5. Exit and restart Windows in 386 enhanced mode.

If, after trying the preceding methods, you still cannot run Windows on the network, you can try running Windows without loading the network onto your system. Ask your system administrator for assistance.

## ***If Your System Fails When You Run a Network-Specific Application***

Your system might run Windows, but fail when you are running a particular application that is network-specific (in other words, an application that is directly accessing the network). There are two reasons why this could happen:

- The network-specific application might not run if you are running Windows in standard mode or 386 enhanced mode.

If this is the case, try running Windows in real mode by typing *win /r* at the DOS prompt.

You might also be able to solve this problem by obtaining a special Windows library for your network from your network vendor.

- Windows might fail when you are running the application and then switch to or from a non-Windows application.

If this happens, avoid switching to another application.

If you are running the non-Windows application with Windows in real or standard mode, you can prevent switching from it by selecting the Prevent Program Switch option in the application's program information file (PIF). For more information, see "Specifying PIF Options for Standard Mode or Real Mode" in Chapter 12.

**386**

If you are using Windows in 386 enhanced mode, you might also need to avoid the invisible switching that Windows does to run applications in the background.

If the network-specific application is a Windows application, make sure that any non-Windows applications you are running at the same time will not run in the background. For more information on running applications in the background, see "Specifying Advanced PIF Options for 386 Enhanced Mode" in Chapter 12.

If the network-specific application is a non-Windows application, try running it in exclusive mode. For more information on running applications in exclusive mode, see "Specifying Basic PIF Options for 386 Enhanced Mode" in Chapter 12.

If the application creates or deletes files, it might not be running exclusively even if it has been set to run in exclusive mode. This is because Windows is alerted anytime a file is manipulated. You can prevent this alert by changing the FileSysChange setting in your SYSTEM.INI file.

▷ **To prevent Windows from getting file manipulation messages:**

---

1. Open your SYSTEM.INI file using a text editor such as Notepad.  
Your SYSTEM.INI file is located in your personal Windows directory.
2. Find the [386enh] section of the file. (If you are using Notepad, you can do this by choosing Find from the Search menu, typing [386enh], and choosing OK.)
3. Type the line *FileSysChange=no* in the section.
4. Save your SYSTEM.INI file.
5. Exit and restart Windows in 386 enhanced mode.

***If an Application Does Not Run Correctly in Standard Mode***

If you are running Windows in standard mode, a Windows application might not run correctly if it requires a larger buffer for transferring data over the network than Windows normally provides.

You can increase the buffer size by changing the NetHeapSize setting in the [standard] section of your SYSTEM.INI file.

▷ **To increase the size of the data transfer buffer:**

---

1. Open your SYSTEM.INI file using a text editor such as Notepad.  
Your SYSTEM.INI file is located in your personal Windows directory.
2. Find the [standard] section of the file. (If you are using Notepad, you can do this by choosing Find from the Search menu, typing [standard], and choosing OK.)
3. Add the NetHeapSize setting to tell Windows the maximum buffer size (in kilobytes) required for data transfers. The default value is 8.  
For example, to make the buffer size 16K, you would type the following:  
*NetHeapSize = 16*
4. Save your SYSTEM.INI file.
5. Exit and restart Windows in standard mode.

**386**

## ***If an Application Does Not Run Correctly in 386 Enhanced Mode***

If you are running Windows in 386 enhanced mode, a Windows application might not run correctly if it requires a larger buffer for transferring data over the network than Windows normally provides.

You can increase the buffer size by changing the `NetHeapSize` setting in the `[386enh]` section of your `SYSTEM.INI` file.

### **▷ To increase the size of the data transfer buffer:**

1. Open your `SYSTEM.INI` file using a text editor such as Notepad.  
Your `SYSTEM.INI` file is located in your personal Windows directory.
2. Find the `[386enh]` section of the file. (If you are using Notepad, you can do this by choosing Find in the Search menu, typing `[386enh]`, and choosing OK.)
3. Add the `NetHeapSize` setting to tell Windows the maximum buffer size (in kilobytes) required for data transfers. The default value is 12. All values are rounded up to the nearest 4K.

For example, to make the buffer size 16K, you would type the following:

```
NetHeapSize = 16
```

4. Save your `SYSTEM.INI` file.
5. Exit and restart Windows in 386 enhanced mode.

## ***If You Cannot Run Any Non-Windows Applications***

If you are not able to run any non-Windows applications while you are connected to the network, try the following:

- Run in a lower Windows mode.  
If you are running Windows in 386 enhanced mode, try running Windows in standard mode instead by typing `win /s` at the DOS prompt. If non-Windows applications do not run with Windows in standard mode, try running Windows in real mode by typing `win /r`.
- Avoid switching to or from any non-Windows applications.
- If you are running Windows in 386 enhanced mode, you can try running non-Windows applications in exclusive mode. For more information on exclusive mode, see “Specifying Basic PIF Options for 386 Enhanced Mode” in Chapter 12.

**386**

## ***If You Cannot Connect to Network Drives or Printers***

If you are running Windows, but cannot connect to network disk drives or printers, try connecting to them before starting Windows.

# ***Putting Windows on a Network***

This section is intended for system administrators or anyone who will install Windows on a network to be shared by multiple users.

The Microsoft License Agreement that came with your Windows package gives you permission to install Windows on a network. For information on this license, see the Grant of License section of this agreement or contact the Microsoft Information Center.

Most of the files on the Windows disks are compressed. To put Windows on the network, you must decompress these files by using the Expand decompression program that is included with Windows. To operate Expand efficiently, you will need to create an MS-DOS batch file. The following procedure contains the commands necessary to create this batch file.

This procedure assumes you are copying Windows from the Windows disks in drive A to the \WINDOWS network directory on network disk drive W. You should replace these pathnames with the actual ones you are using, where appropriate.

### **▷ To install Windows on a network:**

1. Connect to the network.
2. Change to the directory where you want to put the shared copy of Windows.
3. Type *copy con expall.bat* at the DOS prompt.

This DOS command means that what you type next will be copied into the EXPALL.BAT batch file. You can use any filename for this batch file as long as it contains the .BAT extension.

4. Type the following at the DOS prompt:

```
a:
for %%i in (*.*) do w:\windows\expand %%i w:\windows\%%i
w:
```

This MS-DOS code creates a program that will allow you to enter the pathnames of the source and destination of the Windows files.

5. At the DOS prompt, press CTRL + Z.  
This MS-DOS command closes the batch file.
6. Insert Windows Disk 2 into drive A and type the following at the DOS prompt:  
*copy a:expand.exe w:\windows*  
The Expand decompression program is copied to your network Windows directory.
7. Insert Windows Disk 1 into drive A and type the following:  
*expall a:\*. \* w:\windows*  
This command will run the EXPALL batch file program, which copies and expands the files from the Windows disks to the WINDOWS directory on network disk drive W. You should enter the network disk drive and directory of your choice.
8. Repeat Step 7 for the remaining Windows disks.
9. Make all Windows files and the network share read-only.

Users may now connect to this directory and run Setup as described in “Getting Windows from a Network” earlier in this chapter.

## ***Giving Users Access to Network Applications***

You can give users easier access to applications running on the network by modifying the SETUP.INF file when you put Windows on the network. This text file is included with Windows and remains in the shared Windows directory.

Windows Setup uses this file, among other reasons, to determine the initial contents of the user’s Program Manager groups. By modifying the file, you can add applications to these groups and customize their settings.

The [progman.groups] section of SETUP.INF lists the groups in the Program Manager window. Following this section is a list of the applications that are displayed as icons in each group when a user starts Windows. Each application is listed by title, pathname, icon filename, and icon number. These fields are separated by commas. The icon fields are optional.

If you want Windows to install an application that is on the network and place it in the user’s Program Manager window, you need to add to SETUP.INF a title (of your choice) and the pathname of that application.

You have the option of specifying which icon will be displayed by including an *icon filename* and/or an *icon number*.

The icon filename identifies the file that contains the icon you want to use. If you want to use an icon that is assigned to another application, you can enter that application's filename as the icon filename. If you don't specify an icon filename, the displayed icon will be one from the application file. Or, if the application file does not contain any icons, the icon will come from Program Manager.

If the file you select contains more than one icon, you can specify the one you want to use by entering the appropriate icon number. This number corresponds to the order in which the icon is listed in the file. If you do not enter an icon number, Program Manager will use the first icon listed in the file.

### ▷ To add a network application to a user's Program Manager window:

1. Open the SETUP.INF file by using Write.
2. Choose the No Conversion option in the Write dialog box.
3. In the section for the group where you want the application to appear, type the program title, pathname, and, optionally, the icon filename and icon number of the application. The fields must be separated by commas.
4. Choose Save from the File menu to save the changes.

The following are examples of different entries that you could put in SETUP.INF if you wanted to add a shared copy of Microsoft Word to a user's Program Manager window.

*"Microsoft Word" ,k:\word\word.exe*

*"Microsoft Word" ,k:\word\word.exe,progman.exe*

*"Microsoft Word" ,k:\word\word.exe,,2*

*"Microsoft Word" ,k:\word\word.exe,progman.exe,2*

### ***Keeping a User's Files Off a Shared Directory***

When a user runs an application, Program Manager changes the user's directory to the one that contains the application. As a result, a user running a shared application from the network might accidentally leave personal files in the shared directory. These files will use up disk space and possibly interfere with other users.

You can avoid this problem when you add the application to SETUP.INF. First, make sure the application is located on the user's path. Then, instead of typing the network pathname for the application, type the user's personal Windows directory followed by the application filename.



For example, if EXCEL.EXE is located in K:\APPS, and that directory is in the user's path, type *c:\excel.exe* in SETUP.INF. Then, when the user selects the Excel icon, Windows will change to the user's directory (C:\) and run Microsoft Excel from the user's path. Any document files the user creates will stay in the user's directory rather than in the shared network directory.

## ***Putting Additional Network Files on a User's System***

When a user runs the network version of Setup, Windows will copy selected files to the user's system. You can copy additional files to the user's Windows directory by adding the filenames to the [net] section of the user's SETUP.INF file.

### **▷ To put additional files in the user's Windows directory:**

1. Open the SETUP.INF file by using a text editor, such as Notepad.
2. Find the [net] section of the file. (If you are using Notepad, you can do this by choosing Find from the Search menu, typing *[net]*, and choosing OK.)
3. Type a drive number, a colon, the filename, and a title (optional) for the file you want to copy.

You must enter a drive number, but it does not matter what number you use. Include a title only if you want a message to appear during Setup that indicates when this file is being copied to the user's disk.

The following are acceptable entries in the [net] section of SETUP.INF:

*2:NEW.PIF*

*2:NEW.PIF, "Network Application Settings"*

---

---

# ***Appendixes***

<b><i>A</i></b>	<b><i>Using Setup to Maintain Windows</i></b>	<b><i>559</i></b>
<b><i>B</i></b>	<b><i>Special Characters</i></b>	<b><i>567</i></b>
<b><i>C</i></b>	<b><i>Terminal Emulation Tables</i></b>	<b><i>573</i></b>
<b><i>D</i></b>	<b><i>Command Lines in the CONFIG.SYS File</i></b>	<b><i>583</i></b>



---

---

# Appendix A

## Using Setup to Maintain Windows

When you installed Microsoft Windows, you ran the Windows Setup program. During this process, you provided Windows with information about the hardware and software you are using with Windows.

If you make additions or changes to this hardware or software, you will need to inform Windows by running Setup again. In many instances, you will be able to do this from within Windows. Other situations will require you to run Setup from outside of Windows. This appendix describes how to use Setup to maintain your Windows environment.

### Running Setup from Windows

By running Setup from Windows, you can:

- Change some of the hardware options you set when you installed Windows.
- Add applications already installed on your hard disk to the Windows environment.

#### ▷ To run Setup from Windows:

- Choose the Windows Setup icon from the Main Group window.  
The Windows Setup window appears. It lists your current hardware and software settings.

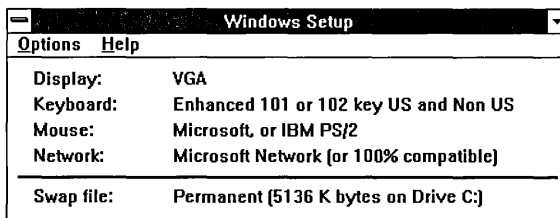

## Changing Settings

Suppose you want to add a mouse to your system, or you want to upgrade the display device you specified when you first ran Setup. You can easily inform Windows of such changes by using Setup. Setup allows you to change:

- The type of display device you are using.
- The keyboard you are using.
- The mouse you are using.
- The type of network you are on.

Windows Setup will allow you to install only those drivers included with Windows. For information on changing to a driver not supplied with Windows, see “Installing a Device Driver Not Supplied with Windows,” later in this appendix.

**NOTE** You will have to restart Windows or reboot your computer if you change settings using Setup. For this reason, it is a good idea to close all your running applications before you start Setup to change settings.

### ▷ To change your display, keyboard, mouse, or network:

1. Make sure that your hardware is set up to match the setting to which you are changing.
2. Choose the Change System Settings command from the Options menu.  
The Change System Settings dialog box appears.

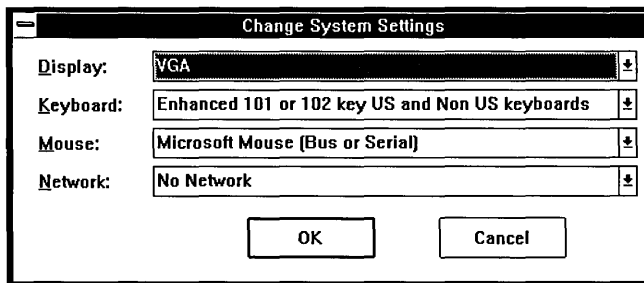

3. Choose the Down arrow at the right of the setting that you want to change.  
A drop-down list box appears. It lists the settings that you can select.
4. Make sure that your hardware is listed in the list box.
5. Select the setting that you want.
6. Choose OK.  
Setup may request that you insert a Windows disk into drive A. If it does, put the disk in drive A and close the drive door, or type the pathname of the appropriate device-driver file. Then choose OK.  
The Windows Setup window displays the new setting.
7. Choose Exit from the Options menu.  
A dialog box appears that contains a Restart Windows button and may contain a Reboot button.
8. If a Reboot button appears, make sure there are no disks in any diskette drive and choose Reboot. Then restart Windows.  
Otherwise, choose Restart Windows.

## ***Adding Existing Applications***

After you install an application on your system, you can use Setup to make sure it will run smoothly with Windows.

If you are adding just one Windows application, it might be easier to use Program Manager rather than Setup. For information on adding an application using Program Manager, see Chapter 3, "Program Manager."

If you are adding several Windows applications or one or more non-Windows applications, using Setup is the best method.

Setup will add only those non-Windows applications for which Setup has information. Setup includes information for many major applications, but not all. If Setup does not create a PIF for the application you want to add, you can create one. For more information on creating a PIF, see Chapter 12, "More About Applications."

▷ **To add an application to Windows:**

1. Choose Set Up Applications from the Options menu.  
Setup displays a dialog box that allows you to direct Setup to search all drives, one drive, or the current path for applications.
2. Choose the Down arrow to the right of the search option you want.
3. Choose OK.  
At the completion of the search, the Set Up Applications dialog box appears.

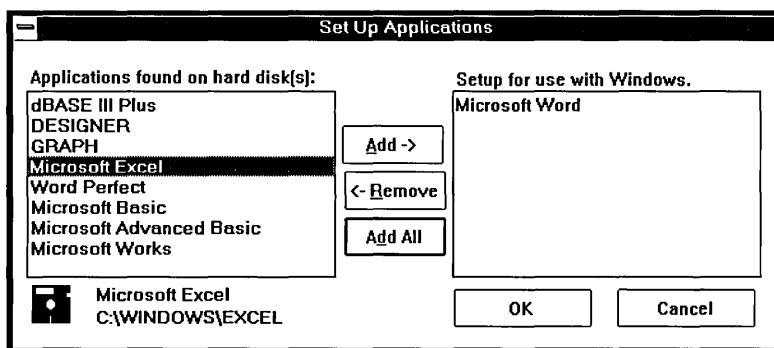

In the list box at the left, Setup lists the names of all the applications it found. These names are taken from the application; they are not supplied by Setup.

When you select one of these applications, Setup displays the pathname of that application in the lower-left corner of the dialog box. Because more than one application can have the same name, check the pathname to make sure the application is the one you want.

4. Select from the list box on the left the applications you want to add.  
If you are using a mouse, click on each application you want to select. If you are using the keyboard, use the DIRECTION keys to move to the application you want and press the SPACEBAR to select it.  
You can select more than one application by repeating this step for each application you want.  
If you change your mind about selecting an item, you can cancel the selection by clicking it again or, with the keyboard, by moving to it and pressing the SPACEBAR again.

5. After you select all the applications you want, choose Add to move them to the list box on the right. If you are using the keyboard, you do this by pressing ALT + A.  
To add all the listed applications to the right list box, choose Add All. With the keyboard, you can do this by pressing ALT + D.  
If you change your mind about adding an application after you add it to the right list box, click the application, and then choose Remove. With the keyboard, move to the application and press the SPACEBAR to select it. Then press ALT + R to move it back to the left list box.
6. Once you are sure you have selected the applications you want Windows to set up, choose OK.

## ***Running Setup from MS-DOS***

By running Setup from MS-DOS, you can:

- Install a device driver (for a display, keyboard, mouse, network, or system) that is not supplied with Windows.  
Use Control Panel to install printer drivers. For more information, see Chapter 5, "Control Panel."
- Install an updated version of a device driver that you previously installed.

## ***Installing a Device Driver Not Supplied with Windows***

A specific set of device drivers was supplied with Windows 3.0. Additional device drivers become available as they are completed. See your device driver manufacturer for information about these device drivers.

Microsoft also periodically provides the Driver Library Disk, which contains device drivers that are made available after Windows 3.0 was released. You can request the Driver Library Disk from Microsoft. See the Hardware Compatibility List for contact information.

If you want to install a device driver that is not included with Windows, you must run Setup from MS-DOS.



Before running Setup, check for any special installation instructions that came with the device driver. There may be other things you will have to do to set up the hardware. Some drivers supply set-up information files that tell Setup what type of files (such as font files) the driver supports. If you are not sure what your device driver supports, contact the device-driver manufacturer.

▷ **To install a device driver not supplied with Windows:**

---

1. Exit Windows.

Do not use the DOS Prompt icon in the Main Group window. Using this icon will result in an incorrect set-up.

2. Type *setup* and press ENTER.

Setup lists your current Windows configuration.

3. Press the UP or DOWN ARROW key to select the setting you want to change and press ENTER.

A list of choices is displayed.

4. Scroll to the bottom of the list using the DOWN ARROW key.

5. Select Other and press ENTER.

Select Other even if you are installing an updated version of a driver that appears on the list.

Setup prompts you for the disk containing the device driver.

6. Insert the disk into drive A. Setup displays a list of the device drivers on that disk. Then select the appropriate driver and press ENTER.

Or type the pathname of the device driver and press ENTER.

(You might be prompted for additional disks if more than one disk was provided from the device driver vendor.)

Setup then copies the appropriate files to your Windows system directory and displays the updated list of your hardware.

7. Press ENTER to complete the process.

8. At the DOS prompt, type *win* to start Windows.

## ***If Your System Hangs When You Run Setup***

Normally, Setup examines your hardware and displays the components you are using in the Windows Setup window. It is possible that an unusual hardware configuration could conflict with this hardware detection, leaving your system unresponsive (hanging).

If this happens, try running Setup with the /I switch by typing *setup /i* at the DOS prompt. This switch will prevent Setup from doing any hardware detection. Setup will display a default list of hardware instead of a list of your current hardware. You will need to change the settings to match your hardware. Follow the instructions in Setup.

## ***Starting Over When Things Go Wrong***

If, for some reason, changes to your files have left Windows inoperable, you will need to run Setup from MS-DOS.

### **▷ To install Windows from scratch:**

1. Exit Windows.
2. Delete the Windows directory and all the files and subdirectories contained in it.
3. Follow the procedure you used when you originally installed Windows. For more information, see “Installing Windows with Setup” in Chapter 1.



---

---

# Appendix B

## Special Characters

This appendix explains how to enter characters that usually are not found on your computer's keyboard. Some examples of these characters are accented letters (é, ç, ö), currency symbols (£, ¥), mathematical symbols ( $\pm$ ,  $\mu$ ), and fractions ( $\frac{1}{2}$ ).

Your computer uses a character set to translate your keystrokes into the symbols you see on your screen or in your printed documents. Windows supports the American National Standards Institute (ANSI) character set, which includes 256 characters, numbered 0 to 255.

### Using ANSI Characters with Windows

Since Windows uses the ANSI character set, you can enter any of the ANSI characters in files you create with Windows. If the character is on the keyboard, just press the key. If the character is not on the keyboard, you can still enter it by using a special key combination.

**▷ To enter an ANSI character that isn't on your keyboard:**

---

1. Locate the character you want on the ANSI chart (on the next page) and notice its corresponding numeric code in the column to the left.
2. Press NUM LOCK to activate the numeric keypad on your keyboard if the keypad is not already active.
3. Hold down ALT and type 0 and the 3-digit code from the ANSI chart on your numeric keypad.

For example, to type the British pound symbol (£) in a Windows application, you would first locate it on the ANSI chart and notice that its character code is 163. Then you would hold down ALT while you typed 0163 on the numeric keypad.

**NOTE** If you want to save a file using a special ANSI character in the filename, first check your computer's manual to make sure the character exists in your computer's character set. If the character does not exist in your computer's character set, Windows substitutes another character, which means you might have trouble locating the file later.

## ANSI Character Set

0 ■	32	64 @	96 `	128 ■	160	192 À	224 à
1 ■	33 ?	65 A	97 a	129 ■	161 ì	193 Á	225 á
2 ■	34 "	66 B	98 b	130 ■	162 ç	194 Â	226 â
3 ■	35 #	67 C	99 c	131 ■	163 £	195 Ã	227 ã
4 ■	36 \$	68 D	100 d	132 ■	164 ¢	196 Ä	228 ä
5 ■	37 %	69 E	101 e	133 ■	165 ¥	197 Å	229 å
6 ■	38 &	70 F	102 f	134 ■	166 ¡	198 Æ	230 æ
7 ■	39 '	71 G	103 g	135 ■	167 \$	199 Ç	231 ç
8 ■	40 (	72 H	104 h	136 ■	168 "·	200 È	232 è
9 ■	41 )	73 I	105 i	137 ■	169 ©	201 É	233 é
10 ■	42 *	74 J	106 j	138 ■	170 ù	202 Ê	234 ê
11 ■	43 +	75 K	107 k	139 ■	171 «	203 Ë	235 ë
12 ■	44 ,	76 L	108 l	140 ■	172 ¬	204 Ì	236 ì
13 ■	45 -	77 M	109 m	141 ■	173 -	205 Í	237 í
14 ■	46 .	78 N	110 n	142 ■	174 ®	206 Î	238 î
15 ■	47 /	79 O	111 o	143 ■	175 ¯	207 Ï	239 ï
16 ■	48 0	80 P	112 p	144 ■	176 °	208 Ð	240 ð
17 ■	49 1	81 Q	113 q	145 ´	177 ±	209 Ñ	241 ñ
18 ■	50 2	82 R	114 r	146 ´	178 ²	210 Ò	242 ò
19 ■	51 3	83 S	115 s	147 ■	179 ³	211 Ó	243 ó
20 ■	52 4	84 T	116 t	148 ■	180 ´	212 Ô	244 ô
21 ■	53 5	85 U	117 u	149 ■	181 µ	213 Õ	245 õ
22 ■	54 6	86 V	118 v	150 ■	182 ¶	214 Ö	246 ö
23 ■	55 7	87 W	119 w	151 ■	183 ·	215 ×	247 ÷
24 ■	56 8	88 X	120 x	152 ■	184 ¸	216 Ø	248 ø
25 ■	57 9	89 Y	121 y	153 ■	185 ¹	217 Ù	249 ù
26 ■	58 :	90 Z	122 z	154 ■	186 º	218 Ú	250 ú
27 ■	59 ;	91 [	123 {	155 ■	187 »	219 Û	251 û
28 ■	60 <	92 \	124	156 ■	188 ¼	220 Ü	252 ü
29 ■	61 =	93 ]	125 }	157 ■	189 ½	221 Ý	253 ý
30 ■	62 >	94 ^	126 ~	158 ■	190 ¾	222 Þ	254 þ
31 ■	63 ?	95 _	127 ■	159 ■	191 ⅞	223 ß	255 ÿ

■ Indicates that this character is not supported by Windows.

## Using Other Character Sets with Windows

Character sets can vary among computer manufacturers. Most manufacturers follow a standard definition of characters 0 to 127, which correspond to the letters, numbers, and symbols you see on a standard U.S. keyboard. Manufacturers often differ, however, in their definitions of characters 128 to 255, which correspond to the special characters described at the beginning of this appendix. Thus, the British pound symbol is character 163 in ANSI but character 156 in the IBM personal computer's standard U.S. character set.

The IBM PC extended character set is shown in the following chart. Windows can display and print only those characters that also appear on the ANSI chart. Windows does not support the other characters, each of which is denoted by a rectangle.

### IBM PC Extended Character Set

128	Ç	144	É	160	á	176	■	192	■	208	■	224	■	240	■
129	ü	145	æ	161	í	177	■	193	■	209	■	225	ß	241	±
130	é	146	œ	162	ó	178	■	194	■	210	■	226	■	242	■
131	â	147	ô	163	ú	179	■	195	■	211	■	227	¶	243	■
132	ä	148	ö	164	ñ	180	■	196	■	212	■	228	■	244	■
133	à	149	ò	165	ñ	181	■	197	■	213	■	229	■	245	■
134	ã	150	û	166	≡	182	■	198	■	214	■	230	μ	246	■
135	ç	151	ù	167	☉	183	■	199	■	215	■	231	■	247	■
136	ê	152	ÿ	168	¿	184	■	200	■	216	■	232	■	248	◊
137	ë	153	ÿ	169	—	185	■	201	■	217	■	233	■	249	■
138	è	154	ÿ	170	¬	186	■	202	■	218	■	234	■	250	■
139	ï	155	ç	171	½	187	■	203	■	219	■	235	■	251	■
140	î	156	£	172	¼	188	■	204	■	220	■	236	■	252	■
141	ì	157	¥	173	¡	189	■	205	■	221	■	237	■	253	²
142	ñ	158	■	174	«	190	■	206	■	222	■	238	■	254	··
143	ñ	159	■	175	»	191	■	207	■	223	■	239	■	255	■

■ Indicates that this character is not supported by Windows.

You can use your computer's character set codes for any characters between 128 and 255 that also exist in the ANSI character set, even if the ANSI code for the character is different. Windows performs the conversion to ANSI for you. If there is no corresponding ANSI character, Windows displays an arbitrary character.

▷ **To enter a character using your computer's character code:**

1. Look up the code for the character in your computer manual.
2. Check the ANSI chart to make sure the character is included.
3. Press NUM LOCK to activate the numeric keypad on your keyboard if the keypad is not already active.
4. Hold down ALT and type the 3-digit code from your computer's character set on your numeric keypad. Do not type 0 before the code.
5. Release ALT.

For example, to type the British pound symbol in Windows when using an IBM personal computer, you would hold down ALT while you type *156*. Windows would convert 156 to its ANSI equivalent, 0163.

**NOTE** If, after typing special characters in Windows, you work on your files with a non-Windows application, you might find that different characters have been substituted for your special characters. This is because the non-Windows application interprets the ANSI character codes as if they were the codes for your computer's character set.

## ***Using Special Characters in a Non-Windows Application***

Non-Windows applications use your computer's character set, but the procedure for typing the character's value differs slightly from what you may be used to.

### **▷ To type a special character in a non-Windows application:**

1. Look up the code for the character in your computer manual.
2. Press NUM LOCK to activate the numeric keypad on your keyboard if the keypad is not already active.
3. Hold down ALT and type the 3-digit code from your computer's character set on your numeric keypad.
4. Release ALT.

## ***Using Special Characters in a Non-Windows Document***

If you work in Windows on files created with non-Windows applications, you might find that any special characters appear as arbitrary characters—for example, a black rectangle (■). Windows attempts to translate these characters, but you will probably need to convert each character to its corresponding ANSI character.

Microsoft Windows Write has an automatic conversion feature that converts characters in non-Windows files to the ANSI character set. See “Managing Write Files” in Chapter 7 for more information.





---

---

# Appendix C

## Terminal Emulation Tables

This appendix defines the technical specifications for terminal emulations when you use the Microsoft Windows Terminal application. There are two tables for each terminal emulation:

- Definition of the IBM PC equivalent keystrokes and the corresponding characters transmitted
- Definition of the functions supported by Windows and their corresponding escape sequences

The letter “1” is italicized (*l*) in all tables to help distinguish it from the numeral “1.”

### VT 52 Terminal - Keyboard

The following are the IBM PC equivalent keystrokes and corresponding characters transmitted for the Digital Equipment Corporation VT 52 Terminal keystrokes.

VT52 keyboard	IBM PC keyboard	Characters transmitted	
		ASCII	HEX
PF1	F1	ESC P	1B 50
PF2	F2	ESC Q	1B 51
PF3	F3	ESC R	1B 52
PF4	F4	ESC S	1B 53
LEFT ARROW	LEFT ARROW	ESC D	1B 44
UP ARROW	UP ARROW	ESC A	1B 41
RIGHT ARROW	RIGHT ARROW	ESC C	1B 43
DOWN ARROW	DOWN ARROW	ESC B	1B 42

The host computer may prompt you to put your keyboard in *keyboard application mode*, a terminal emulation mode required for some applications. The following table lists keystrokes and characters for keyboard application mode.

VT52 keyboard	IBM PC keyboard	Characters transmitted	
		ASCII	HEX
0	0	ESC ? p	1B 3F 70
1	1	ESC ? q	1B 3F 71
2	2	ESC ? r	1B 3F 72
3	3	ESC ? s	1B 3F 73
4	4	ESC ? t	1B 3F 74
5	5	ESC ? u	1B 3F 75
6	6	ESC ? v	1B 3F 76
7	7	ESC ? w	1B 3F 77
8	8	ESC ? x	1B 3F 78
9	9	ESC ? y	1B 3F 79
-	-	ESC ? m	1B 3F 6D
,	, (or *)	ESC ? l	1B 3F 6C
.	.	ESC ? n	1B 3F 6E
ENTER	+	ESC ? M	1B 3F 4D
LEFT ARROW	LEFT ARROW	ESC O D	1B 4F 44
UP ARROW	UP ARROW	ESC O A	1B 4F 41
RIGHT ARROW	RIGHT ARROW	ESC O C	1B 4F 43
DOWN ARROW	DOWN ARROW	ESC O B	1B 4F 42

## ***VT 52 Terminal - Functions***

The following are the supported functions for the Digital Equipment Corporation VT 52 Terminal and their corresponding escape sequences.

---

<b>Function</b>	<b>Escape sequence</b>
ANSI MODE ENTER	ESC <
CURSOR MOVE DOWN	ESC B
CURSOR MOVE HOME	ESC H
CURSOR MOVE LEFT	ESC D
CURSOR MOVE RIGHT	ESC C
CURSOR MOVE UP	ESC A
CURSOR POSITION SET	ESC Y <i>l c</i>
ERASE TO END OF LINE	ESC K
ERASE TO END OF SCREEN	ESC J
IDENTIFY	ESC Z
KEYPAD APPLICATION	ESC =
KEYPAD NUMERIC	ESC >
LINE FEED REVERSE	ESC I

---

## ***VT 100 Terminal - Keyboard***

The following are the IBM PC equivalent keystrokes and corresponding characters transmitted for the Digital Equipment Corporation VT 100™ Terminal keystrokes.

---

<b>VT100 keyboard</b>	<b>IBM PC keyboard</b>	<b>Characters transmitted</b>	
		<b>ASCII</b>	<b>HEX</b>
PF1	F1	ESC O P	1B 4F 50
PF2	F2	ESC O Q	1B 4F 51
PF3	F3	ESC O R	1B 4F 52
PF4	F4	ESC O S	1B 4F 53
LEFT ARROW	LEFT ARROW	ESC [ D	1B 5B 44
UP ARROW	UP ARROW	ESC [ A	1B 5B 41
RIGHT ARROW	RIGHT ARROW	ESC [ C	1B 5B 43
DOWN ARROW	DOWN ARROW	ESC [ B	1B 5B 42

---

The host computer may prompt you to put your keyboard in *keyboard application mode*, a terminal emulation mode required for some applications. The following table lists keystrokes and characters for keyboard application mode.

VT100 keyboard	IBM PC keyboard	Characters transmitted	
		ASCII	HEX
0	0	ESC O p	1B 4F 70
1	1	ESC O q	1B 4F 71
2	2	ESC O r	1B 4F 72
3	3	ESC O s	1B 4F 73
4	4	ESC O t	1B 4F 74
5	5	ESC O u	1B 4F 75
6	6	ESC O v	1B 4F 76
7	7	ESC O w	1B 4F 77
8	8	ESC O x	1B 4F 78
9	9	ESC O y	1B 4F 79
-	-	ESC O m	1B 4F 6D
,	, (or *)	ESC O l	1B 4F 6C
.	.	ESC O n	1B 4F 6E
ENTER	+	ESC O M	1B 4F 4D
LEFT ARROW	LEFT ARROW	ESC O D	1B 4F 44
UP ARROW	UP ARROW	ESC O A	1B 4F 41
RIGHT ARROW	RIGHT ARROW	ESC O C	1B 4F 43
DOWN ARROW	DOWN ARROW	ESC O B	1B 4F 42

## VT 100 Terminal - Functions

The following are the supported functions for the Digital Equipment Corporation VT 100 Terminal and their corresponding escape sequences.

Substitute one or more values (separated by semicolons) from the specified table (\* Tn) for the <x1> and <x3> arguments.

Substitute a value from the specified table (\* Tn) for the <x2> argument.

Substitute a value specifying the desired number of characters or lines for the <n> argument.

Substitute a value specifying the desired line and column number for the <l> and <c> arguments.

Substitute a value specifying the desired row numbers for the top row and bottom row of the scrolling region for the <tr> and <br> arguments.

Function	Escape sequence
BACKSPACE	^H
CARRIAGE RETURN	^M
CHARACTER DELETE	ESC [ <n> P
CHARACTER INSERT	ESC [ <n> @
CHARACTER WIDTH DOUBLE	ESC # 6
CHARACTER WIDTH SINGLE	ESC # 5
CURSOR MOVE DOWN	ESC [ <n> B
CURSOR MOVE LEFT	ESC [ <n> D
CURSOR MOVE RIGHT	ESC [ <n> C
CURSOR MOVE UP	ESC [ <n> A
CURSOR POSITION SET	ESC [ <l> ; <c> H
CURSOR POSITION SET (ABSOLUTE)	ESC [ <l> ; <c> f
CURSOR RESET	ESC 8
CURSOR SAVE	ESC 7
ERASE ENTIRE LINE	ESC [ 2 K
ERASE ENTIRE SCREEN	ESC [ 2 J
ERASE FROM START OF LINE	ESC [ 1 K

Function	Escape sequence
ERASE FROM START OF SCREEN	ESC [ 1 J
ERASE NORMAL DATA FROM START OF SCREEN	ESC [ ? 1 J
ERASE NORMAL DATA ON LINE	ESC [ ? 2 K
ERASE NORMAL DATA ON SCREEN	ESC [ ? 2 J
ERASE NORMAL DATA TO END OF LINE	ESC [ ? 0 K
ERASE NORMAL DATA TO END OF SCREEN	ESC [ ? 0 J
ERASE NORMAL DATA TO START OF LINE	ESC [ ? 1 K
ERASE TO END OF LINE	ESC [ 0 K
ERASE TO END OF SCREEN	ESC [ 0 J
ESCAPE	ESC
IDENTIFY	ESC Z
INDEX	ESC D
INDEX REVERSE	ESC M
KEYPAD APPLICATION	ESC =
KEYPAD NUMERIC	ESC >
LINE DELETE	ESC [ <n> M
LINE FEED	^J
LINE HEIGHT DOUBLE (BOTTOM)	ESC # 4
LINE HEIGHT DOUBLE (TOP)	ESC # 3
LINE INSERT	ESC [ <n> L
NEXT LINE	ESC E
READ CURSOR POSITION	ESC [ <l> ; <c> R
READ STATUS	ESC [ Ps 5
RING BELL	^G
SET SCROLLING REGION	ESC [ <tr> ;   r
TAB CLEAR	ESC [ g
TAB CLEAR ALL	ESC 3 g
TAB MOVE-HORIZONTAL	^I
TAB SET	ESC H
TERMINAL MODES RESET	ESC [ <x1> l (* T1)



Function	Escape sequence
TERMINAL MODES SET	ESC [ <x1> h (* T1)
TERMINAL PARAMETERS REQUEST	ESC [ {so/} x
TRANSMIT DEVICE ATTRIBUTES	ESC [ c
SET MEDIA COPY OFF	ESC [ 4 <x2> (* T2)
SET MEDIA COPY ON	ESC [ 5 <x2> (* T2)
VIDEO ATTRIBUTE SET	ESC [ <x3> m (* T3)
CHANGE G0 CHAR SET TO GRAPHICS	ESC ( O
CHANGE G0 CHAR SET UK	ESC ( A
CHANGE G0 CHAR SET US ASCII	ESC ( B
CHANGE G1 CHAR SET TO GRAPHICS	ESC ) O
CHANGE G1 CHAR SET UK	ESC ) A
CHANGE G1 CHAR SET US ASCII	ESC ) B
G0 ALTERNATE CHARACTER ROM	ESC ( 2
G1 ALTERNATE CHARACTER ROM	ESC ) 2

TABLE 1 - TERMINAL MODES &lt;x1&gt;

Function	Escape sequence
LINEFEED/NEULINE	?0
APPLICATION/CURSOR KEYS	?1
ANSI/VT 52	?2
132/80 COLUMN	?3
SMOOTH/JUMP SCROLL	?4
REVERSE/NORMAL SCREEN	?5
RELATIVE/ABSOLUTE ORIGIN	?6
CHARACTER WRAP ON/OFF	?7
AUTO REPEAT ON/OFF	?8
INTERLACE ON/OFF	?9

TABLE 2 - MEDIA COPY MODES &lt;x2&gt;

Function	Escape sequence
COPY ENTIRE SCREEN TO PRINT PORT	0
COPY ENTIRE SCREEN TO MODEM	2
DISABLE TRANSPARENT PRINT MODE	4
ENABLE TRANSPARENT PRINT MODE	5
COPY CURSOR ROW TO PRINT PORT	?1
COPY CURSOR ROW TO MODEM	?3
DISABLE COPY PRINT MODE	?4
ENABLE COPY PRINT MODE	?5

TABLE 3 - VIDEO ATTRIBUTES &lt;x3&gt;

Function	Escape sequence
ATTRIBUTES OFF	0
BOLD	1
UNDERSCORE	4
BLINK	5
NEGATIVE (REVERSE)	7



---

---

## Appendix D

# Command Lines in the CONFIG.SYS File

To install memory-resident utilities such as SMARTDrive, you add a command line for the utility to your system's CONFIG.SYS file. This appendix explains the HIMEM, SMARTDrive, RAMDrive, EMM386, and EGA command lines. (For more information about what each utility does and how to install it, see Chapter 13, "Optimizing Windows.")

## Using the HIMEM.SYS Command Line

HIMEM is an extended memory manager—a utility that “administrates” the use of your system's extended memory so that no two applications can use the same memory at the same time.

You install HIMEM by adding the HIMEM command line to your CONFIG.SYS file. The HIMEM command line must come before any command lines for applications or device drivers that use extended memory.

The HIMEM command line tells your computer:

- Where to find the HIMEM program file.
- The minimum amount of space an application must use in the High Memory Area (HMA) in order for HIMEM to give that application use of the HMA (optional).
- How many extended memory handles HIMEM should make available (optional).
- Whether or not to disable shadow RAM (optional).
- What type of system you are using (optional).

The HIMEM command line has the following form:

```
device=pathname\himem.sys /hmamin=m /numhandles=n/shadow:  
on/off/machine:name
```

The following list explains each part of the command line.

**Use this value**

**To do this**

*device* =

Tell MS-DOS to install a device driver—in this case, HIMEM. You must include this part of the command line.

**pathname***\himem.sys*

Specify the pathname of the HIMEM program file. For example, if HIMEM.SYS is in the root directory of drive C, you would type *c:\himem.sys*. HIMEM.SYS should always be located on your start-up disk drive. If the HIMEM.SYS file is in the directory you use to start MS-DOS, you don't need to include a pathname. However, you must always include the filename (HIMEM.SYS).

*/hmamin=m*

Specify how many kilobytes of memory an application must use in the High Memory Area (HMA) in order for HIMEM to give that application use of the HMA. Only one application can use the HMA at a time; HIMEM gives the HMA to the first application that meets the memory-use requirements set by this switch. You can specify a value from 0 to 63.

To ensure the most efficient use of your system's HMA, set /HMAMIN to the request size of the application that uses the most HMA memory.

The /HMAMIN switch is optional; the default value is 0. Omitting this switch (or setting it to 0) tells HIMEM to give the HMA to the first application that requests it.

The /HMAMIN switch has no effect when Windows is running in 386 enhanced mode.

*/numhandles=n*

Specify the maximum number of Extended Memory Block (EMB) handles that can be in use simultaneously. You can specify a value from 1 to 128; the default is 32. Each additional handle requires an additional 6 bytes of memory.

**Use this value****To do this**

*/shadow:on/off*

Tell HIMEM whether or not to disable shadow RAM. Some computers make ROM code run faster by “shadowing” it in RAM—that is, by copying the ROM code into faster RAM memory at startup. However, this uses up some extended memory.

Normally, on systems that use shadow RAM and have less than 384K of extended memory, HIMEM attempts to disable shadow RAM in order to recover additional extended memory for Windows’ use. (HIMEM can disable shadow RAM only on certain types of systems.) When HIMEM disables shadow RAM, the ROM code runs in the slower ROM instead of RAM; therefore, your system might run slightly slower.

The */SHADOW* option lets you control HIMEM’s treatment of shadow RAM. To leave the ROM code running from RAM, even on systems with less than 384K of memory, specify the value */shadow:on*. To tell HIMEM to disable shadow RAM, specify the value */shadow:off*.

*/machine:name*

Tell HIMEM what type of computer you are using. Normally, HIMEM can detect your system type successfully; however, there are a few computers that HIMEM cannot detect. On such systems, HIMEM uses the default system type (IBM AT or compatible). You might need to include the */MACHINE* option if your computer is a type that HIMEM cannot detect, and if HIMEM does not work properly on your system using the default system type. Currently, the only system that requires this switch is the Acer © 1100. If you are using an Acer 1100, include the value */machine:acer1100*.

The */NUMHANDLES* option has no effect when Windows is running in 386 enhanced mode.

## Sample HIMEM Command Lines

This section shows three sample HIMEM command lines and explains what they do.

### **Sample One: Running HIMEM with the Default Values**

The following command line runs HIMEM using the default values:

```
device = himem.sys
```

The command line does not include a pathname for HIMEM.SYS; therefore, MS-DOS looks for the HIMEM.SYS file in the root directory of the disk from which MS-DOS started. Because this command line does not include additional switches, HIMEM uses the default values for those switches. HIMEM will give the HMA to the first application that requests it, and will allow the simultaneous use of up to 32 extended memory handles.

### **Sample Two: Controlling Use of the HMA with HIMEM**

The following command line tells HIMEM to give an application access to the HMA only if that application will use at least 40K of that memory:

```
device = c:\windows\himem.sys /hmamin=40
```

The command line tells MS-DOS to look for the HIMEM.SYS file in the \WINDOWS directory on drive C. Because the /NUMHANDLES switch is not included, HIMEM will allow the simultaneous use of up to 32 extended memory handles.

### **Sample Three: Increasing the Number of Memory Handles that HIMEM Provides**

The following command line tells HIMEM to allow simultaneous use of up to 128 extended memory handles:

```
device = c:\devices\himem.sys /numhandles=128
```

The command line tells MS-DOS to look for the HIMEM.SYS file in the \DEVICES directory on drive C. 128 is the maximum number of handles that HIMEM supports; by default, HIMEM allows simultaneous use of only 32 handles.

## Using the SMARTDrive Command Line

SMARTDrive is a disk-caching program for computers that have a hard disk and extended or expanded memory.

**NOTE** Windows/386 version 2.x will not run in conjunction with SMARTDrive version 3.0.

You install SMARTDrive by adding the SMARTDrive command line to your CONFIG.SYS file. The SMARTDrive command line tells your computer:

- Where to find the SMARTDrive program file.
- The size of the SMARTDrive memory cache.
- Whether SMARTDrive should use expanded or extended memory.

The SMARTDrive command line has the following form:

*device=pathname\smartdrv.sys NormalCacheSize MinimumCacheSize /a*

The following list explains each part of the command line.

<u>Use this value</u>	<u>To do this</u>
<i>device =</i>	Tell MS-DOS to install a device driver—in this case, SMARTDrive. You must include this part of the command line.
<i>pathname\smartdrv.sys</i>	Specify the pathname of the SMARTDrive program file. For example, if SMARTDRV.SYS is in the \WINDOWS directory on drive C, you would type <i>c:\windows\smartdrv.sys</i> . If the SMARTDRV.SYS file is in the drive and directory you use to start MS-DOS, you don't need to include a pathname. However, you must always include the filename (SMARTDRV.SYS).



Use this value

To do this

**NormalCacheSize**

Specify the normal size of the SMARTDrive memory cache in kilobytes. This size will be in effect when Windows is not running.

You can specify a value from 128 to 8192 (8MB). For example, to give SMARTDrive a 640K memory cache, specify *640*. (Because SMARTDrive caches entire disk tracks, it rounds the cache size down to the nearest multiple of the largest disk track size on your system.)

The **NormalCacheSize** value is optional; if you don't specify an amount, the SMARTDrive cache will use 256K of memory. If there is not enough memory to create a cache of the size you specify, SMARTDrive creates a smaller cache using the available memory.

**MinimumCacheSize**

Specify the minimum size for the SMARTDrive cache.

With an extended-memory cache, when Windows starts in standard mode or 386 enhanced mode, it immediately reduces SMARTDrive's cache to the minimum size. This lets Windows recover memory for its own use.

With an expanded-memory cache, Windows reduces the cache when running in real mode; however, instead of immediately reducing the cache to its minimum size, Windows reduces the cache gradually as it needs the additional expanded memory.

The **MinimumCacheSize** value is optional; if you don't specify an amount, Windows can reduce the cache size to its default minimum size, 256K. (If you include a value for **MinimumCacheSize**, you must also include a value for **NormalCacheSize**.)

**Use this value**

*/a*

**To do this**

Specify that you want SMARTDrive's cache to use expanded memory, or that you want it to use your extended memory board as expanded memory. For SMARTDrive to use expanded memory, your system must be configured so that it provides expanded memory, and the command line for the expanded memory manager (such as EMM386, 386MAX, CEMM, or QEMM) must appear in your CONFIG.SYS file *before* the SMARTDrive command line.

This switch is optional; leave it out if you want SMARTDrive's cache to use extended memory. For SMARTDrive to use extended memory, your system must be configured so that it provides extended memory, and the command line for the extended memory manager (such as HIMEM.SYS) must appear in your CONFIG.SYS file *before* the SMARTDrive command line.

## ***Sample SMARTDrive Command Lines***

This section shows two sample SMARTDrive command lines and explains what they do.

### ***Sample One: Running SMARTDrive in Extended Memory***

If you have an 80286 or 80386 computer, you'll probably want to run SMARTDrive in extended memory and give it as much memory as possible. When you run Windows in standard mode or 386 enhanced mode, it shrinks SMARTDrive's cache to release memory for its own use. Windows and SMARTDrive then cooperate to provide both effective disk caching and efficient memory management.

**NOTE** To run SMARTDrive in extended memory, the SMARTDrive command line must appear in your CONFIG.SYS file after the HIMEM command line.

The following command line runs SMARTDrive in extended memory:

```
device = smartdrv.sys 1024 256
```

This command line tells MS-DOS to look for the SMARTDRV.SYS file in the drive and directory from which you start MS-DOS. It gives SMARTDrive 1024K (1MB) of extended memory, so the normal cache size is 1024K. It specifies a minimum cache size of 256, so that Windows cannot make the cache any smaller than 256K. (Windows will shrink an extended-memory cache only when running in standard mode or 386 enhanced mode.)

### ***Sample Two: Running SMARTDrive in Expanded Memory***

Normally, you'll want to run SMARTDrive in expanded memory only if you run Windows in real mode.

The following command line runs SMARTDrive in expanded memory:

```
device = c:\win\smartdrv.sys 2048 256 /a
```

This command line tells MS-DOS to look for the SMARTDRV.SYS file in the \WIN directory on drive C. It gives SMARTDrive 2048K (2MB) of expanded memory, so the normal cache size is 2048K. It specifies a minimum cache size of 256, so that Windows cannot make the cache any smaller than 256K. (Windows will shrink an expanded-memory cache only when running in real mode.)

## ***Using the RAMDrive Command Line***

RAMDrive is a utility that lets you use part of your system's memory as if it were a hard disk. This memory area is called *RAMdisk*.

**NOTE** Windows/386 version 2.x will not run in conjunction with RAMDrive version 3.0.

To set up a RAM disk, you add the RAMDrive command line to your CONFIG.SYS file. The RAMDrive command line tells your computer:

- Where to find the RAMDrive program file.
- How much memory you want the RAM disk to use.
- Attributes of the RAM disk (optional), such as the sector size and the number of root-directory entries.
- Whether the RAM disk should use expanded or extended memory.

You can set up as many RAM disks as you want. Add one RAMDrive command line to your CONFIG.SYS file for each RAM disk you want.

The RAMDrive command line has the following form:

```
device = pathname\ramdrive.sys DiskSize SectorSize NumEntries /e /a
```

The following list explains each part of the command line.

<u>Use this value</u>	<u>To do this</u>
<i>device =</i>	Tell MS-DOS to install a device driver—in this case, RAMDrive. You must include this part of the command line.
<i>pathname\ramdrive.sys</i>	Specify the pathname of the RAMDrive program file. For example, if RAMDRIVE.SYS is in the \WINDOWS directory on drive C, you would type <i>c:\windows\ramdrive.sys</i> . If the RAMDRIVE.SYS file is in the drive and directory you use to start MS-DOS, you don't need to include a pathname. However, you must always include the filename (RAMDRIVE.SYS).
<b>DiskSize</b>	Specify how many kilobytes of memory you want to use for the RAM disk. For example, to create a 640K RAM disk, type <i>640</i> . If you don't specify an amount, RAMDrive will create a 64K RAM disk. You can specify a value from 16 to 4096.
<b>SectorSize</b>	Specify the sector size in bytes. The size can be 128, 256, 512, or 1024 bytes. (If you include a <b>SectorSize</b> value, you must also include a value for <b>DiskSize</b> .)  Normally, you should omit this value; the RAM disk will then use the default sector size of 512 bytes.

Use this value

**NumEntries**

*/e*

To do this

Limit the number of directory entries (files and directories) you can create in the RAM disk's root directory. The limit can be from 2 to 1024 entries; the limit you specify will be rounded up to the nearest sector size boundary. If you do not specify a limit, you'll be able to create up to 64 entries in the RAM disk's root directory. (If you include a value for **NumEntries**, you must also include values for **DiskSize** and **SectorSize**.)

If there is not enough memory to create the RAM disk as specified, RAMDrive will try to create it with a limit of 16 directory entries. This may result in a RAM disk with a different limit from the one you specified.

Create the RAM disk in extended memory.

For RAMDrive to use extended memory, your system must be configured so that it provides extended memory, and the command line for the extended memory manager (such as HIMEM.SYS) must appear in your CONFIG.SYS file *before* the RAMDrive command line.

Although specifying a memory type is optional, it is highly recommended. In general, it is best to create a RAM disk in extended memory if your system has extended memory. If you omit both the /E switch and the /A switch (described next), RAMDrive will use your system's base (conventional) memory. It is not a good idea to use base memory for a RAM disk, since doing so reduces the performance of Windows.

**Use this value***/a***To do this**

Create the RAM disk in expanded memory.

For RAMDrive to use expanded memory, your system must be configured so that it provides expanded memory, and the command line for the expanded memory manager (such as EMM386, 386MAX, CEMM, or QEMM) must appear in your CONFIG.SYS file *before* the RAMDrive command line.

Although specifying a memory type is optional, it is highly recommended. If you omit both the /A switch and the /E switch (described previously), RAMDrive will use your system's conventional memory. It is not a good idea to use conventional memory for a RAM disk, since doing so reduces the performance of Windows.

## ***Sample RAMDrive Command Lines***

This section shows three sample RAMDrive command lines and explains what they do.

### ***Sample One: Running RAMDrive in Extended Memory***

The following command line gives RAMDrive 64K of extended memory:

```
device = ramdrive.sys /e
```

The /E switch tells RAMDrive to use extended memory; because the command line does not specify how much memory to use, RAMDrive uses the default (64K).

Because this command line does not include a pathname for RAMDRIVE.SYS, MS-DOS looks for the RAMDRIVE.SYS file in your hard disk's root directory.

**NOTE** To run RAMDrive in extended memory, the RAMDrive command line must appear in your CONFIG.SYS file after the HIMEM command line.

### **Sample Two: Running RAMDrive in Expanded Memory**

The following command line tells RAMDrive to run in expanded memory, and gives RAMDrive the maximum amount (4096K) of expanded memory that RAMDrive can use:

```
device = c:\windows\ramdrive.sys 4096 /a
```

The command line tells MS-DOS to look for the RAMDRIVE.SYS file in the \WINDOWS directory on drive C.

### **Sample Three: Specifying Additional RAM Disk Attributes**

You can create a RAM disk with a specific number of disk sectors, and can limit how many entries the disk can contain in its root directory.

The following command line gives RAMDrive 1024K of extended memory:

```
device = d:\devices\ramdrive.sys 1024 512 64 /e
```

The command line creates a RAM disk with 512-byte sectors and a limit of 64 root-directory entries. It tells MS-DOS to look for the RAMDRIVE.SYS file in the \DEVICES directory on drive D.

## **Using the EMM386.SYS Command Line**

EMM386 is an expanded memory emulator—a utility that uses extended memory to simulate expanded memory. You should install EMM386.SYS only if you run applications that require expanded memory with Windows in real mode, or if you run such applications when you are not running Windows.

You install EMM386 by adding the EMM386 command line to your CONFIG.SYS file. The EMM386 command line tells your computer:

- Where to find the EMM386 program file.
- How much memory you want EMM386 to use.
- How you want EMM386 to use memory.

The EMM386 command line has the following form:

```
device=pathname\emm386.sys Memory MemoryOptions
```

The following list explains each part of the command line.

<u>Use this value</u>	<u>To do this</u>
<i>device =</i>	Tell MS-DOS to install a device driver—in this case, EMM386. You must include this part of the command line.
<b>pathname</b> \emm386.sys	Specify the pathname of the EMM386 program file. For example, if EMM386.SYS is in the \WINDOWS directory on drive C, you would type <i>c:\windows\emm386.sys</i> . If the EMM386.SYS file is in the drive and directory you use to start MS-DOS, you don't need to include a pathname. However, you must always include the filename (EMM386.SYS).
<b>Memory</b>	<p>Specify how many kilobytes of memory you want EMM386 to use. For example, to give EMM386 640K of memory, specify <i>640</i>. You can specify a value from 16 to 32768. (EMM386 rounds the value down to the nearest multiple of 16.)</p> <p>EMM386 reserves the memory you specify for the common memory pool. The memory will be available to applications as expanded memory.</p> <p>This value is optional; if you don't specify an amount, EMM386 will use 256K of memory.</p>
<b>MemoryOptions</b>	<p>Fine-tune the way EMM386 uses memory.</p> <p>The EMM386 memory options are optional parameters you can include on the EMM386 command line. You use these options to control the location of the EMS page frame, determine how EMM386 uses certain addresses, and so on. For more information, see "Specifying EMM386 Memory Options" later in this appendix.</p>



## **Sample EMM386 Command Lines**

This section shows two sample EMM386 command lines and explains what they do. (The sample command lines in this section do not illustrate the memory options; for information on EMM386 memory options, see the following section, “Specifying EMM386 Memory Options.”)

### **Sample One: Running EMM386 Using the Default Values**

The following command line runs EMM386 using the default values:

```
device = emm386.sys
```

Because this command line does not include a pathname for EMM386.SYS, MS-DOS looks for the EMM386.SYS file in your hard disk’s root directory. This command line allocates to EMM386 the default amount of memory (256K). This means that EMM386 can provide up to 256K of expanded memory to applications that need expanded memory.

### **Sample Two: Allocating Memory to EMM386**

The following command line gives EMM386 4096K of memory, and tells MS-DOS to look for the EMM386.SYS file in the \WINDOWS directory on drive C:

```
device = c:\windows\emm386.sys 4096
```

## **Specifying EMM386 Memory Options**

Normally, you don’t need to specify memory options on the EMM386 command line, since EMM386 usually runs properly using the default values.

However, in some cases, you may want to control how EMM386 uses memory—for example, where EMM386 puts the EMS page frame, or which addresses it can use for EMS pages. EMM386 provides several command-line options that let you fine-tune the way it uses memory. You can use as many of these options as you want, in any order you want; be sure to include the options you want after the EMM386 pathname and memory amount (if any).

The following list describes the EMM386 memory options:

<u>Use this option</u>	<u>To do this</u>
<i>w=on/off</i>	Enable or disable support for the Weitek Coprocessor. To enable support, include the value <i>w = on</i> on the command line. To disable support, include the value <i>w = off</i> instead. By default, Weitek Coprocessor support is disabled.
<i>frame=address</i>	<p>Specify the base address of the 64K page frame.</p> <p>Normally, you won't need to specify a base address; by default, EMM386 uses a contiguous 64K region of memory, and does not place the page frame below C000:0000. However, sometimes it is not possible to identify adapter memory absolutely. If a conflict occurs, you may need to ensure that EMM386 places the page frame at a particular location.</p> <p>To specify a specific base address for the page frame, use the FRAME option to specify the address you want. For example, to place the page frame at C800:0000, include <i>frame=C800</i> on the EMM386 command line.</p>
<i>pn=address</i>	<p>Define the address of a specific page.</p> <p>The P option has the form <i>pn=address</i>, in which <b>n</b> is the number of the page you are specifying, and <b>address</b> is the address you want. For example, to place page 4 at the address CC00, include <i>p4=CC00</i> on the EMM386 command line.</p> <p>If you use the FRAME option, you cannot use the P option to specify addresses for pages 0 through 3.</p>
<i>x=addressrange</i>	Prevent EMM386 from using a particular range of addresses for an EMS page. To specify the range, include this option on the command line, followed by the range of addresses you want to exclude. For example, to prevent EMM386 from using segments 8000:0000 through 9000:0000, include the value <i>x=8000-9000</i> on the command line.

<u>Use this option</u>	<u>To do this</u>
<i>b=address</i>	Specify the lowest address. By default, 4000:0000 is the lowest address. To specify a different low address, include this option on the command line, followed by the address you want. For example, to make 8000:0000 the lowest address, include the value <i>b=8000</i> . You can specify an address from 1000:0000 to EC00:0000.
<i>l=minXMS</i>	Ensure that the specified amount of extended memory will still be available after EMM386 is loaded. Specify the memory in kilobytes. For example, to ensure that 640K of extended memory will be available after loading EMM386, include the value <i>l=640</i> on the command line.
<i>a=altregs</i>	Specify how many fast alternate register sets you want to allocate to EMM386. For example, to allocate 16 register sets to EMM386, include the value <i>a=16</i> on the command line. You can specify a number from 0 to 254; the default is 7 sets.
<i>h=handles</i>	Specify how many handles EMM386 can use. For example, to let EMM386 use 127 handles, include the value <i>h=127</i> on the command line. You can specify from 1 to 255 handles; the default is 255.

## ***Sample EMM386 Command Lines with Memory Options***

This section shows some sample EMM386 command lines that illustrate how to use EMM386 memory options.

### ***Sample One: Specifying the Location of the EMS Page Frame***

There are several ways to specify the base address for the EMS page frame. Each of the following sample command lines sets the page frame's base address at D000:0000, and gives EMM386 512K of memory.

```
device = emm386.sys 512 frame=D000
```

```
device = emm386.sys 512 p0=D000 p1=D400 p2=D800 p4=DC00
```

## ***Sample Two: Excluding a Range of Memory Addresses***

Like the command lines in the preceding section, the following command line sets the page frame's location at the address D000:0000, and gives EMM386 512K of memory. In addition, however, this command line keeps EMM386 from using the memory addresses E000:0000 to EC00:0000.

```
device = emm386.sys 512 frame=D000 x=E000-EC00
```

## ***Using the EGA.SYS Command Line***

You need the EGA.SYS device driver if your system has an EGA monitor and you run non-Windows applications with Windows in real mode or standard mode.

EGA.SYS enables Windows to keep track of the current state of the EGA video display. EGA.SYS does so by maintaining an exact copy of the contents of your system's video control registers. Whenever a non-Windows application writes to a video control register, EGA.SYS duplicates the application's change in the copy of that register that EGA.SYS maintains.

To use EGA.SYS, add a command line like the following to your CONFIG.SYS file:

```
device = c:\windows\ega.sys
```

The EGA.SYS command line simply defines EGA.SYS as a device driver, and tells MS-DOS the location of the EGA.SYS file.



---

---

# Glossary

**386 enhanced mode** A mode that Windows runs in to access the virtual memory capabilities of the Intel 80386 processor. This mode allows Windows to use more memory than is physically available and to provide multitasking for non-Windows applications.

## A

---

**active** Describes the window or icon to which the next keystroke or command will apply. If a window is active, its title bar changes color to differentiate it visually from other open windows. If an icon is active, the Control menu appears.

**active printer** The printer currently connected to a port.

**ANSI character set** The American National Standards Institute 8-bit character set. It contains 256 characters.

**application** A computer program used for a particular kind of work, such as word processing or database management. This term is used interchangeably with “program” in this manual. *See also* Windows application, Non-Windows application.

**application icon** A graphic that appears only after you start an application and then minimize it. Application icons are the only icons that appear on the desktop, outside window borders.

**application shortcut key** A key combination that brings an application to the foreground when running Windows in 386 enhanced mode.

**application window** A window that contains a running application. The name of the application appears at the top of this window. An application window may contain multiple document windows.

**ASCII character set** The American Standard Code for Information Interchange 8-bit character set. It consists of the first 128 (0-127) characters of the ANSI character set.

**associate** To identify a filename extension as “belonging” to a certain application. When you select a file with an extension that has been associated with an application, that application is opened automatically.

## B

---

**background** The area behind the active window.

**binary file** A file containing characters that are in machine-readable form.

**bitmap** An image stored as an array of bits.

**boot** To start your computer, or to restart it, loading the disk operating system (DOS).

**branch** A segment of the File Manager Directory Tree, representing a directory and any subdirectories within it.

**built-in font** (also known as resident or hardware font) A font that is built into the read-only memory (ROM) of a printer.

## C

---

**cartridge font** A font contained in a cartridge that physically plugs into your printer. A cartridge font is usually used by laser printers in the HP LaserJet family, but some dot-matrix printers also use font cartridges. *See also* font cartridge.

**cascade** A way of arranging open windows on the desktop so that they overlap each other, with the title bar of each window remaining visible.

**cascading menu** A menu that opens from a command on another menu.

**check box** A small square box that appears in a dialog box and that can be selected or cleared. When the check box is selected, an X appears in the box. A check box represents an option that you can set.

**choose** To use a mouse or key combinations to pick an item that begins an action in Windows.

**click** To press and release a mouse button quickly.

**Clipboard** A temporary storage location used to transfer data between documents and between applications.

**close** To remove a document window or application window from the desktop. You can choose to save or abandon the document in a document window before you close the application.

**collapse** To “hide” additional directory levels below a selected directory in File Manager.

**COM port** *See* serial port.

**command** A word or phrase, usually found in a menu, that you choose in order to carry out an action.

**command button** A button in a dialog box. It carries out or cancels the selected action. Two common command buttons are labeled Cancel and OK.

**communications settings** Special settings that you use to tell Windows how to send information using a serial device such as a modem or printer. *See also* serial port.

**confirmation message** A message displayed by Windows when you have specified a destructive action, asking you if you are sure you want to proceed. For example, Windows displays a confirmation message when you tell it to delete a file.

**Control menu** The menu appearing on every application that runs in a window and on some non-Windows applications. Icons, some dialog boxes, and windows within an application workspace also have Control menus. For applications running in a Window and for icons and dialog boxes, Control-menu commands move, change the size of, and close windows. For non-Windows applications, the Control-menu commands transfer information and perform other miscellaneous functions. *Also known as* System menu.

**Control-menu box** The icon that opens the Control menu for the window. It is always at the left of the title bar.

**conventional memory** The first 640K of memory that MS-DOS uses to run applications.

**copy** To put a copy of the selected text or item on the Clipboard so you can transfer it to another location. Most Windows applications have a Copy command that performs this task.

**current directory** The directory that is currently highlighted in the Directory Tree or whose directory window is the active window.

**cut** To move text from a document into a temporary storage area called the Clipboard.

## D

---

**data file** Any file created within an application: a word processing document, a spreadsheet, a database file, a chart, and so forth. *Also known as* document.

**default button** The command button in some dialog boxes selected as the most logical or safest choice. This button has a bold border when the dialog box appears, and pressing ENTER chooses the button.

**default printer** The printer that Windows applications automatically use when you choose the Print command. You can have only one default

printer, and the default printer must also be an active printer.

**desktop** The screen background for Windows on which windows, icons, and dialog boxes appear.

**desktop pattern** A geometric pattern that appears across the desktop. You can use Control Panel to design your own pattern or choose one from patterns provided by Windows.

**destination directory** The directory to which you intend to copy or move one or more files.

**dialog box** A rectangular box that either requests or provides information. Many dialog boxes present options to choose among before Windows can carry out a command. Some dialog boxes present warnings or explain why a command can't be completed.

**DIRECTION keys** The four arrow keys on your computer keyboard. Each arrow key is named for the direction the key points: UP ARROW, DOWN ARROW, LEFT ARROW, and RIGHT ARROW.

**directory** A collection of files and subdirectories that are stored at the same location on a disk. The name of the directory identifies its location. Part of the structure for organizing your files on a disk. *See also* subdirectory.

**directory path** *See* pathname.

**Directory Tree** A graphic display in File Manager of the directory structure of a disk. The directories on the disk are shown as a branching structure that resembles a tree. Directories are shown as branches off the top-level directory, known as the root directory.

**directory window** A File Manager window that lists the contents of a directory. Each directory window shows all the files and other directories contained in the directory.

**disk drive** A device used for storing and retrieving data on disks.

**disk-drive icon** An icon in File Manager that represents a disk drive. Different icons depict floppy disk drives, hard disk drives, network disk drives, RAM drives, and CD-ROM drives.

**document window** A window within an application window. A document window contains a document you create or modify by using an application. There can be more than one document window in an application window.

**DOS prompt** The letter designation for the active drive. The prompt appears at the left side of the computer screen and is followed by a colon.

**double-click** To rapidly press and release a mouse button twice without moving the mouse. Double-clicking carries out an action, such as opening an icon.

**downloadable font** *See* soft font.

**drag** To move an item on the screen by holding down the mouse button while moving the mouse. For example, you can move a window to another location on the screen by dragging its title bar.

**drive icon** *See* disk-drive icon.

**drop-down list box** A single-line dialog box that opens to display a list of choices.

## **E**

---

**EMS memory** A type of expanded memory available on systems that conform to the Lotus-Intel-Microsoft Expanded Memory Specification (LIM EMS).

**emulation mode** A mode in which a device such as a printer can imitate the behavior of a different device. *See also* terminal emulation.

**EPT port** A port requiring a special card and special software. Only certain printers, such as the IBM Personal Pageprinter, use this port.



**exclusive application** An application that has sole use of the computer's resources while it is running in the foreground with Windows in 386 enhanced mode. When an exclusive application is running in a window, it gets most, but not all, of the resources.

**expand** To show currently hidden levels in the Directory Tree. With File Manager, you can expand a single directory level, one branch of the tree, or all branches at once.

**expanded memory** Memory in addition to conventional memory that is available for applications. It is allocated in 16K blocks. Windows will make use of expanded memory only if the /R switch is used at start-up. Windows running in 386 enhanced mode simulates expanded memory for the applications that need it. Windows running in standard mode or 386 enhanced mode allows applications to use expanded memory, but it does not use expanded memory itself in the management of applications.

**extend selection** To select more than one object. For example, you can select a group of files to be moved or copied with File Manager.

**extended memory** Memory in addition to conventional memory that is not readily accessible to MS-DOS or MS-DOS applications. Extended memory cannot be used on 8086/88 computers. Windows running in standard mode or 386 enhanced mode uses extended memory to manage and run applications.

**extension** The period and three letters at the end of a filename. An extension identifies the kind of information a file contains. For example, files created with Calendar have the extension .CAL.

## F

---

**file** A document or application that has been given a name. All documents are stored as files in Windows.

**file attribute** A characteristic of a file—for example, the read-only attribute—that can be changed using File Manager.

**file format** The structure or arrangement of data stored in a file.

**filename** The name of a file. Windows uses DOS filename conventions.

**fixed-width font** A font in which all characters have uniform widths.

**flow control** The processes and procedures used to regulate the rate at which data is transferred from one device to another. *Also known as* handshake.

**font** A graphic design applied to all numerals, symbols, and characters in the alphabet. A font usually comes in different sizes and provides different styles, such as bold, italic, and underlining for emphasizing text.

**font cartridge** A piece of hardware that is plugged into a printer to supply one or more fonts.

**font family** A group designation that describes the general look of a font. For example, the Roman font family contains fonts with serifs and variable character widths, such as Tms Rmn.

**font set** A group of fonts designed for use with a specific device resolution. Windows includes seven sets of fonts.

**font size** *See* point size.

**footer** Text that appears at the bottom of every page of a document when it is printed.

**foreground** The area of the screen occupied by the active window.

**format** (1) The appearance of text on the pages of a document. (2) To prepare a disk so that it can hold information. Formatting a disk erases all information that was previously on it.

**full-screen application** Any non-Windows application that occupies the whole screen rather than running in a window.

**G**

---

**graphics resolution** The level of quality at which Windows prints graphics. The higher the resolution, the better the quality of the printed graphics (and the slower the printing).

**group** A collection of programs in Program Manager. Grouping your programs makes them easier to find when you want to start them.

**group icon** The graphic that represents a Program Manager group that is minimized. Double-clicking the group icon opens the group window.

**group window** A window that displays the items in a group within Program Manager. These items can be applications or data files associated with applications.

**H**

---

**handshake** A flow-control, or “go-ahead,” signal sent by a local computer to a remote computer when working with a communications program such as Terminal. XON/XOFF is the standard software handshaking method, although it can’t be used with remote systems that use a hardware handshaking method.

**header** Text that appears at the top of every page of a document when it is printed.

**hidden file** A system file that cannot be viewed, such as your MS-DOS BIOS file.

**high memory area** *See* HMA.

**highlighted** Indicates that an object or text is selected and will be affected by your next action. Highlighted text appears in reverse video on monochrome displays or in color on some color displays. Highlighted objects might change color or be surrounded by a selection cursor.

**HMA** (high memory area) The first 64K of extended memory. This area is used by some applications.

**I**

---

**icon** A graphical representation of various elements in Windows, such as disk drives, applications, and documents.

**inactive window** Any open window that you are not currently working in.

**insertion point** The place where text will be inserted when you type. The insertion point usually appears as a flashing vertical bar in an application’s window or in a dialog box. The text you type appears to the left of the insertion point, which is pushed to the right as you type.

**L**

---

**list box** Within a dialog box, a box listing available choices—for example, the list of all available files in a directory. If all the choices won’t fit, the list box has a vertical scroll bar.

**LPT port** *See* parallel port.

**M**

---

**macro** A series of actions recorded using the Recorder accessory. When you run the macro, Recorder carries out all the recorded actions. Macros can be assigned to special keys, called shortcut keys, or to longer descriptive names.

**mark** To select text in a non-Windows application.

**Maximize button** The small box containing an Up arrow at the right of the title bar. Mouse users can click the Maximize button to enlarge a window to its maximum size. Other users can use the Maximize command on the Control menu.

**memory-resident software** Software that is loaded into memory and is available for use even when another application is active. *Also known as* TSR software.

**menu** A list of items, most of which are Windows commands. Menu names appear in the menu bar near the top of the window. You use a command on a menu by selecting the menu name, then choosing the command.

**menu bar** The horizontal bar containing the names of all the application menus. It appears below the title bar.

**Minimize button** The small box containing a Down arrow at the right of the title bar. Mouse users can click the Minimize button to shrink a window to an icon. Other users can use the Minimize command on the Control menu.

## N

---

**network** A group of computers connected by cables and using special software that allows them to share equipment (such as printers) and exchange information.

**network disk drive** A disk drive that is available for public use on a network. Network disk drives are often used to store data files for many people in a work group.

**non-Windows application** Computer programs that were not designed to run within the Windows environment. Non-Windows applications do not necessarily follow any of the Windows user interface conventions. Although most non-Windows applications can run with Windows, there may be limitations regarding how many of Windows' features they can take advantage of.

## O

---

**open** To display the contents of a file in a window or to enlarge an icon to a window.

**option** A choice in a dialog box. An option affects the way in which a command is carried out. Dialog boxes have several kinds of options, including mutually exclusive option buttons and non-exclusive check boxes.

**option button** A small round button that appears in a dialog box and is used to select an option. Within a group of related option buttons, you can select only one button.

## P

---

**parallel interface** An interface between a computer and a printer in which the computer sends multiple bits of information to the printer simultaneously. Parallel and Centronics interfaces are the same type.

**parallel port** A connection on a computer, usually LPT1, where you plug in the cable for a parallel printer. Windows supports parallel ports LPT1 through LPT3.

**parameter** Information added to the command that starts an application. This information determines how the application will run. For example, to start Microsoft Word in character mode, you would type *word /c* at the DOS prompt. The */c* is the parameter. A parameter can be a filename or any type of information up to 62 characters in length.

**paste** To transfer the contents of the Clipboard to an application. Many applications have a Paste command that performs this task.

**pathname** The directions to a directory or file within your system. For example, C:\WINDOWS3\APPTS\JUNE.CAL is the pathname of the JUNE.CAL file in the APPTS subdirectory in the WINDOWS3 directory on drive C.

**pels** See pixels.

**personal Windows directory** The directory, usually located on your hard disk, that contains the Windows files that were loaded to your system when you ran Windows Setup.

**PIF** (program information file) A file that provides information that Windows needs to run a non-Windows application. For example, you use a PIF to tell Windows to run a non-Windows

**application** in a full screen rather than in a window or to specify a start-up directory.

**pixels** The smallest graphic units on the screen. Also known as picture elements (pels).

**point** To move the pointer on the screen until it rests on the item you want to select or choose.

**point size** The height of a printed character. A point equals 1/72 of an inch.

**pointer** The arrow-shaped cursor on the screen that indicates the position of the mouse.

**port** A connection on a computer where you plug in the cable that carries data to another device.

**print queue** A list of files that have been sent to a particular printer. The list indicates the file currently printing and those waiting to be printed.

**Printer Cartridge Metrics file** (PCM) A file that contains Printer Fonts Metrics files for each font on a font cartridge.

**printer driver** Special software that controls how your computer and printer interact. A printer-driver file supplies Windows with information such as the printing interface, descriptions of fonts, special features, and so on.

**Printer Font Metrics file** (PFM) A file that supplies a Windows printer driver with information about a font, such as family, point size, widths of individual characters, and more.

**program information file** *See* PIF.

**program item icon** The graphic that represents an application that you can start from Program Manager. A program item icon is contained in a group window.

**proportional font** A font in which different characters have varying widths.

**protected mode** The operating mode of a computer that is capable of addressing extended memory directly.

**protocol** A set of rules that define how computers communicate with each other.

## Q

---

**queue** *See* print queue.

## R

---

**RAM** (random access memory) The memory that is used to run applications and perform other necessary tasks while the computer is on. When you turn the computer off, all information in RAM is lost. *See also* virtual memory.

**raster font** A font created as a graphic bitmap image. It is available only in a fixed size—not scalable. A raster font is used mostly on the screen, but is also used by some dot-matrix printers and built into some laser printers.

**read-only file** A file that you can only open and read. You cannot edit a read-only file and save it again.

**real mode** An operating mode that Windows runs in to provide maximum compatibility with versions of Windows applications prior to 3.0. Real mode is the only mode available for computers with less than 1MB of extended memory.

**Restore button** The small box containing a Down arrow and an Up arrow at the right of the title bar. The Restore button appears after you have enlarged a window to its full size. Mouse users can click the Restore button to return the window to its previous size. Other users can use the Restore command on the Control menu.

**root directory** The highest directory of a disk. The root directory is created when you format the disk. From the root directory, you can create other directories.

## S

**scaled point size** A point size that approximates a specified point size for use on the screen.

**screen font** A raster font designed to duplicate a printer font on the screen. *See also* raster font.

**scroll** To move text or graphics up or down, or left or right, in order to see parts of the file that cannot fit on the screen.

**scroll bars** The bars at the bottom and right edge of a window whose contents are not entirely visible. Each scroll bar contains a small box, called a scroll box, and two scroll arrows to allow different types of scrolling.

**scroll buffer** In Terminal, the buffer that holds typed or received information that does not fit on the screen.

**select** To highlight an item by clicking it with the mouse or using key combinations. Selecting does not initiate an action. After selecting an item, you choose the action you want to affect the item. *See also* choose and highlighted.

**selection cursor** The marking device that shows where you are in a window, menu, or dialog box. The selection cursor can appear as a highlight or as a dotted rectangle around the text in a dialog box option.

**serial interface** An interface between a computer and a printer in which the computer sends single bits of information to the printer, one after the other. Serial, asynchronous, and RS232 interfaces are all the same type.

**serial port** A connection on a computer, usually COM1, where you plug in the cable for a serial printer or another serial communications device, such as a modem.

**server** *See* network disk drive.

**share** A partition of a network disk drive.

**shortcut key** A key combination that carries out some action in Windows. For example, pressing ALT + ESC switches among loaded applications.

**shrink** To reduce a window to an icon at the bottom of the desktop using the Minimize button. The document or application remains open and can be the active document or application.

**soft font** A font that is downloaded to your printer's memory from a disk provided by the font manufacturer.

**solid color** The color that appears on a display when all pixels are the same color. On a monochrome display, there are only two solid colors: black and white.

**source directory** The directory that contains the file or files you intend to copy or move.

**spool** To print a document or file in the background while working on something else.

**standard mode** The normal operating mode for running Windows. This mode provides access to extended memory and also lets you switch among non-Windows applications.

**standard setting** Standard settings are settings shipped with Windows. For example, if you print a drawing or document from one of the Windows accessories without entering new margin settings, the accessory uses standard margin settings to print.

**subdirectory** A directory contained within another directory. All directories are subdirectories of the root directory.

**swap file** An area of your hard disk that is set aside for exclusive use by Windows in 386 enhanced mode. This area is used only when your system runs low on memory.

**switch** *See* parameter.

**System menu** *See* Control menu.

**system time** The time set by your computer's internal clock.

## T

---

**task** An open application, when you are using Task Manager.

**terminal emulation** A setting specified with Terminal that causes your computer to emulate a remote computer. Terminal emulation allows your computer to display data it receives and to use features of the remote computer.

**text box** A box within a dialog box where you type information needed to carry out the chosen command. The text box may be blank when the dialog box appears or may contain text.

**text file** A file containing only letters, digits and symbols. A text file usually consists of characters coded from the ASCII character set.

**tile** A way of arranging open windows on the desktop so that no windows overlap but all windows are visible. Each window takes up a portion of the screen.

**title bar** The horizontal bar located at the top of a window and containing the title of the window. On many windows, the title bar also contains the Control-menu box and Maximize and Minimize buttons.

**TSR software** *See* memory-resident software.

## V

---

**vector font** A series of dots connected by lines that can be scaled to different sizes. Plotters typically use vector fonts. *Also known as* stroke font.

**virtual machine** An environment created by Windows running in 386 enhanced mode in which an application can run and behave as if it had an entire machine all to itself. Windows in 386 enhanced mode can have multiple applications

running in their own separate virtual machines at the same time.

**virtual memory** A memory management system used by Windows running in 386 enhanced mode, which allows Windows to behave as if there were more memory than is actually present in the system. Virtual memory equals the amount of free RAM plus the amount of disk space allocated to a swap file that Windows uses to simulate additional RAM.

**volume label** A name that identifies a disk. The volume label appears in the title bar of the Directory Tree window.

## W

---

**wallpaper** A picture or bitmapped pattern that appears as the Windows desktop.

**wildcard character** A character that represents another character. In filenames, you can use the asterisk (\*) as a wildcard character to indicate any character or group of characters that might match that position in other filenames. For example, \*.EXE represents all files that end with the .EXE filename extension.

**window** A rectangular area on your screen in which you view an application or document. *See also* application window and document window.

**Windows application** Any application that was designed especially for Windows and will not run without Windows. All Windows applications follow the same conventions for arrangement of menus, style of dialog boxes, use of the keyboard and mouse, and so on.

**word wrap** A feature that moves text from the end of a line to the beginning of a new line as you type. With word wrap, you do not press ENTER at the end of each line in a paragraph.

**workspace** The area of a window that displays the information contained in the application or document you are working with.



---

---

# Index

386 Enhanced command, in PIF Editor, 447  
386 enhanced mode  
    conserving disk space by preventing swapping, 507  
    Control menu, 60  
    Control Panel options for, 192 – 193  
    defined, xxiii  
    device contention options, 190 – 192  
    Edit commands, 32, 60  
    freeing up memory for applications, 480 – 482  
    making the network card compatible with, 548  
non-Windows applications with  
    changing settings for, 476  
    described, 50, 440  
permanent swap file for  
    adjusting size of, 524  
    changing location of, 524  
    described, 521  
    displaying information about, 520  
    removing, 525  
    setting up, 522  
PIF options for  
    Allow Close When Active, 473  
    Allow Fast Paste, 473  
    Application Shortcut Key, 475  
    Close Window on Exit, 462  
    Display Usage, 460  
    EMS Memory, 465  
    Emulate Text Mode, 472  
    Execution, 461  
    Lock Application Memory, 469  
    Memory Requirements, 460  
    Monitor Ports, 471  
    Multitasking, 463, 465  
    Optional Parameters, 451  
    Program Filename, 458  
    Reserve Shortcut Keys, 474  
    Retain Video Memory, 472  
    Start-up Directory, 452  
    Uses High Memory Area, 468  
    Video Memory, 470  
    Window Title, 459  
    XMS Memory, 467 – 468  
printer ports, setting access priorities for, 164  
requirements for running, x  
Settings command, 33  
starting Windows in, 429  
temporary swap file for  
    changing location of, 527  
    controlling size of, 528

PIF options for (*continued*)  
    temporary swap file for (*continued*)  
        deleting to free up disk space, 509  
        described, 520, 526  
        setting up, 527  
386SPART.PAR file, 509, 521  
\_DEFAULT.PIF file, 449

## A

---

About Application command, in Help menu, 72  
Accessories  
    Calculator, 357  
    Calendar, 370  
    Cardfile, 386  
    Clock, 398  
    Notepad, 399  
    Paintbrush, 263  
    PIF Editor, 444  
    Recorder, 405  
    Terminal, 317  
    Write, 223  
Accessories group, described, 80  
Active printer, 169  
Active windows  
    closing, 48  
    defined, 54  
Add command, in Cardfile, 388  
Add dialog box, in Cardfile, 388  
Airbrush tool, in Paintbrush, 281  
Alarm Controls dialog box, 377  
Alarms, in Calendar  
    removing, 378  
    setting for an appointment time, 375  
    setting for early ring, 377  
    shutting off, 378  
    silent alarm option, 376  
Alert Always command, in Print Manager, 204  
All Pages option, in Write, 256  
Allow Close When Active option, in PIF Editor, 473  
Allow Fast Paste option, in PIF Editor, 473  
Always Warn option, in Control Panel, 191  
Analog command, in Clock, 399  
ANSI character set  
    *See also* Character set  
    chart, 568  
    converting to, 570  
    entering characters not on keyboard, 567  
ANSI format for Write documents, 253



Append File option, in Terminal, 342  
Application icons, defined, xxiii  
Application Shortcut Key option, in PIF Editor, 475  
Application swap files  
    controlling location of, 530  
    deleting to free up disk space, 509  
    described, 529  
    using RAM disk for, 530  
Application windows  
    described, 19  
    moving, 41  
    opening the Control menu for, 28  
    rearranging, 55  
    selecting, 54  
Applications  
    *See also* Program items  
    adding with the Setup program, 562  
    associating documents with, 135  
    changing default directory for, 97  
    compatibility with Windows 3.0, 438  
    defined, xxiii  
    freeing up memory while running, 478  
    icons for, 82  
    identifying older versions, 437  
    improving access to network, 554  
    non-Windows. *See* Non-Windows applications  
    PIFs for. *See* PIFs  
    problems running in 386 enhanced mode, 552  
    problems running in standard mode, 551  
    problems with, 482 – 489  
    processing speed, described, 493  
    quitting, 63  
    returning to Program Manager from within, 97  
    running in real mode, 438  
    running older versions with Windows, 438  
    running two or more at once  
        described, 50  
        device contention options, 190 – 192  
        processing time options, 192 – 193  
    starting  
        from a directory window, 51, 137  
        from a document or program file, 137  
        from a group, 51, 96  
        from a network, 546  
        from the Windows command line, 431  
        with the Run command, 52  
    swap files for, 529 – 530  
    temporary files for, 509  
    transferring data between modes, 439  
    Windows. *See* Windows applications  
    working with different types, described, 437  
Appointments calendar. *See* Calendar  
Archive file attribute, 134

Arrange Icons command, in Program Manager  
    rearranging group icons, 86  
    rearranging program item icons, 86  
Arranging  
    application windows, 55  
    File Manager windows, 114, 120  
    icons  
        individually, 86  
        with Task List, 56  
        with the Arrange Icon command, 84, 86  
        with the Auto Arrange command, 84  
    overlapping group windows, 84  
Arrow keys, defined, xxiv  
ASCII files, transferring, 335  
Associate command, in File Manager  
    associating documents with an application, 136  
    deleting an association, 137  
Associate dialog box, 136  
Associating documents with applications, 135  
Attributes. *See* File attributes  
Auto Arrange command, in Program Manager, 83  
Auto command, restoring Clipboard format, 61  
Autodial command, in Cardfile, 397  
Autodial dialog box, 397 – 398  
AUTOEXEC.BAT file  
    described, 518  
    editing to free up memory, 516 – 518  
Automatic phone dialing, by Cardfile, 397

---

## **B**

Back button, in on-line Help, 74  
Background color, selecting for a drawing, 270  
Background Priority option  
    in PIF Editor, 464  
    of the Settings command, 477  
Backing up Write files, 255  
Batch files, creating PIFs for, 448  
Baud Rate option  
    in Cardfile, 398  
    in Terminal, 327  
Beep, turning sound on and off, 190  
Binary files  
    and nonconversion to Write format, 254  
    defined, 335  
Binary number system, with scientific calculator, 364  
Binary Transfers command, in Terminal, 339  
Binary Transfers dialog box, 339  
Bitmaps  
    creating, 155  
    displaying as wallpaper, 155  
Bold type  
    in a Paintbrush drawing, 276

**Bold type** (*continued*)

- in Write documents, 237
  - purpose in this guide, xxii
- Box tool, in Paintbrush, 291 – 292
- Browse button, in on-line Help, 74

**Browsing**

- through filenames of program items, 90
- through list of network servers, 106

Brush Shapes command, in Paintbrush, 287

Brush Shapes dialog box, 287

Brush tool, in Paintbrush, 286 – 287

Buffer Lines option, in Terminal, 326

**BUFFERS** command line

in CONFIG.SYS file, 500 – 501, 517

By Name command, in File Manager, 117

By Type command, in File Manager, 117

**C****Calculator**

- copying a value to the Clipboard, 360
- described, 357
- entering simple calculations, 358
- memory functions, described, 359
- pasting from the Clipboard
  - binary, octal, and hex values, 364
  - decimal values, 360
- scientific
  - described, 362 – 363
  - number systems, 363 – 364
  - statistical calculations, 364 – 366
  - Statistics Box buttons, described, 366
  - table of number base functions, 367
  - table of operators, 366
  - table of statistical functions, 368
  - table of trig and log functions, 368 – 369
- standard
  - described, 357 – 358
  - memory functions, described, 359
  - table of standard calculator functions, 361
- starting, 357
- using with the Clipboard, 359, 361

**Calendar**

- Alarm Controls dialog box, 377
- customizing, 378 – 381
- Day Settings dialog box, 379
- day view
  - adding a special time, 380
  - adding notes, 373
  - changing the day settings, 379
  - deleting a special time, 380
  - displaying different appointment days, 373 – 374
  - editing appointments, 373

**Calendar** (*continued*)

- day view (*continued*)
    - entering appointments, 372
    - removing alarms, 378
    - setting alarms for appointments, 375
    - setting alarms to ring early, 377
    - shutting off an alarm, 378
    - silent alarm option, 376
  - described, 370
  - managing files
    - opening read-only files, 382
    - removing appointments, 382
  - Mark dialog box, 381
  - month view
    - described, 375
    - displaying appointments for a date, 375
    - marking dates, 380 – 382
  - Page Setup dialog box, 384 – 385
  - Print dialog box, 383
  - printing appointments
    - changing the margins, 384
    - with headers and footers, 385 – 386
    - with standard settings, 383
  - Remove dialog box, 383
  - Show Date dialog box, 374
  - Special Time dialog box, 380
  - starting, 370
  - switching between day view and month view, 371
- Canceling**
- dialog boxes, 41
  - menus, 26
  - selections
    - in dialog boxes, 38
    - in directory windows, 128
- Capacity of computer system, described, 493**
- Cardfile**
- Add dialog box, 388
  - adding cards to a file, 388
  - Autodial dialog box, 397 – 398
  - deleting a card, 394
  - described, 386
  - duplicating a card, 394
  - editing cards
    - changing the index line, 391
    - copying text to another card, 392
    - described, 391
    - moving text to another card, 392
    - pasting pictures, 393
  - entering an index line, 387
  - entering card information, 388
  - Find dialog box, 390
  - finding text, 390 – 391
  - Go To dialog box, 389

**Cardfile (continued)**

- Index dialog box, 387
  - listing the cards, 388
  - managing files
    - merging files, 395
    - tracking the number of cards, 394
  - Merge dialog box, 395
  - moving through cards
    - bringing a card to the front, 389 – 390
    - scrolling, 389
  - phone dialing, 397
  - printing cards
    - entire file, 396
    - single card, 396
  - restoring a changed card, 393
  - starting, 386
- Carrier Detect option, in Terminal, 328
- Cartridge fonts, installing, 179
- Cartridges option, in Control Panel, 168
- Cascade command
  - rearranging application windows, 55
  - rearranging document windows, 66
  - rearranging File Manager windows, 114, 120
  - rearranging group windows, 84, 86
  - rearranging icons, 55
- Cascading menus, defined, 28
- Change All option, in Write, 230
- Change Attributes command, in File Manager, 135
- Change Attributes dialog box, 135
- Change command, in Write, 229
- Change dialog box, 230
- Change option, in Write, 230
- Change Selection option, in Write, 230
- Change System Settings command, in Setup, 560
- Change System Settings dialog box, 560
- Change, then Find option, in Write, 230
- Changing
  - directories, 108
  - program item properties, 96
- Character at a Time option, in Terminal, 336
- Character sets
  - converting to ANSI, 570
  - entering ANSI characters, 567
  - with non-Windows applications, 571
- Characters
  - character styles
    - in a document, 237
    - in a Paintbrush drawing, 276
  - formatting, 237
  - subscript, 238
  - superscript, 238
  - translation of, 567 – 571
- Check boxes, selecting options, 40

- Checkmark next to command names, defined, 28
- CHKDSK program, 54, 510 – 511
- Choosing
  - defined, xxiii
  - menu commands, 27
- Circle/Ellipse tool, in Paintbrush
  - drawing circles and ellipses, 293 – 294
  - drawing perfect circles, 294
- Clear Buffer command, in Terminal, 348
- Clear command, in Paintbrush, 303
- Clearing check boxes, 40
- Clicking, defined, xxiii
- Clicks + Drags option, in Recorder, 412
- Clipboard
  - clearing contents of, 62
  - copying an entire screen to, 58
  - copying information to, 57
  - cutting and pasting cutouts in drawings, 296
  - defined, 56
  - file formats supported by, 61
  - moving information to, 57
  - opening files, 62
  - pasting information from, 59
  - saving contents in a file, 61
  - size of, 56
  - using with Calculator, 359, 361
  - using with Terminal, 346
  - viewing contents of, 61
- Clock
  - analog display, 398
  - digital display, 399
  - starting, 398
- Close All Directories command, in File Manager, 121
- Close command, on Control menus
  - closing directory windows, 121
  - closing the Change dialog box, 230
  - closing the Find dialog box, 229
  - described, 32
  - exiting Windows, 12
- Close Window on Exit option, 456, 462
- Closing
  - See also* Quitting
  - active windows, 48
  - dialog boxes, 41
  - directory windows, 121
  - files. *See* Saving documents and files
  - menus, 26
  - on-line Help, 74
- Collapse Branch command, in File Manager, 111
- Collapsing a directory, 111
- Color dialog box, 148 – 149
- Color Eraser tool, in Paintbrush, 282 – 283

- Colors
  - custom, in Paintbrush, 306 – 307
  - filling in shapes with, 285 – 286
  - for text in a drawing, 277
  - for the desktop
    - creating a color scheme, 148 – 149
    - defining custom colors, 150 – 152
    - removing a color scheme, 150
    - using an existing color scheme, 147
  - inverting in cutouts, 302
  - leaking through borders, 286
  - replacing in a drawing, 282 – 283
  - selecting in Paintbrush, 270
- Colors option, in Paintbrush, 266
- Columns option, in Terminal, 324
- Command buttons, described, 35
- Command lines
  - EGA.SYS, 599
  - EMM386.SYS, 594
  - HIMEM.SYS, 583
  - RAMDRIVE.SYS, 590
  - SMARTDRIVE.SYS, 587
  - Windows
    - described, 427
    - samples of, 431
- Commands option, in Help menu, 72
- Communications command, in Terminal, 326
- Communications dialog box, 326
- Communications with remote computers. *See* Terminal
- CONFIG.SYS file
  - adding EMM386.SYS command line, 541
  - and memory configuration, 499
  - described, 517
  - editing to free up memory, 516 – 517
  - for an 80286 computer, 501
  - for an 80386 or 80486 computer, 500
  - for an 8086 or 8088 computer, 502
  - sample EMM386 command lines, 596 – 598
  - sample HIMEM command lines, 586
  - sample RAMDrive command lines, 593 – 594
  - sample SMARTDrive command lines, 589 – 590
- Configure dialog box
  - changing printer ports, 164
  - changing standard print options, 166
  - changing timeout options, 171
  - removing installed printers, 173 – 174
- Configuring memory
  - on an 80286 computer, 500 – 501
  - on an 80386 or 80486 computer, 499
  - on an 8086 or 8088 computer, 502
- Configuring ports. *See* Ports
- Configuring printers
  - active, 169
  - Configuring printers (*continued*)
    - default, 170
    - described, 164
    - ports
      - choosing, 163 – 164
      - setting access priorities for 80386 computers, 164
    - print options
      - changing, 166
      - described, 167 – 168
    - timeout options
      - changing, 171 – 172
      - described, 171
  - Confirm on Delete option, in File Manager, 133
  - Confirm on Mouse Operation option
    - in File Manager, 133
  - Confirm on Replace option, in File Manager, 133
  - Confirm on Subtree Delete option, in File Manager, 133
  - Confirmation command, in File Manager, 132
  - Confirmation dialog box, 132
  - Confirmation messages, in File Manager, 132
  - Connect Net Drive command, in File Manager
    - browsing through network disk drives, 106
    - connecting to a network disk drive, 105
  - Connect Network Drive dialog box, 105
  - Connecting
    - to network printers, 172
    - to network servers, 105 – 106
    - to remote computers, 334
  - Connector option, in Terminal, 328
  - Control codes for Terminal function keys, 331
  - Control-menu box, described, 21
  - Control menus
    - commands in, 32
    - Control-menu box for, 21
    - described, 28
    - Edit commands in, 60
    - opening, 28 – 29
  - Control Panel
    - 386 enhanced mode
      - dialog box, 191
      - options, 190 – 193
    - changing printer ports, 163 – 164
    - changing the keyboard speed, 189
    - Color dialog box, 148 – 149
    - colors. *See* Desktop
    - Configure dialog box
      - changing printer ports, 164
      - changing standard print options, 166
      - changing timeout options, 171
      - removing installed printers, 173 – 174
    - Currency Format dialog box, 185
    - Custom Color Selector dialog box, 150
    - customizing the mouse, 187 – 188

Control Panel (*continued*)

- Date & Time dialog box, 188
  - Date Format dialog box, 182
  - Desktop dialog box, 153
  - desktop. *See* Desktop
  - Fonts dialog box
    - adding a font, 177
    - removing a font, 180
  - icons for Control Panel options
    - choosing, 147
    - described, 146 – 147
  - installing new printers, 159
  - International dialog box, 181
  - international settings, 180 – 186
  - Keyboard dialog box, 189
  - List of Printers box, 162
  - Mouse dialog box, 187
  - network options, 177
  - Number Format dialog box, 186
  - Ports dialog box, 176
  - Printers dialog box
    - adding printers, 159 – 160
    - choosing the active printer, 169
    - choosing the default printer, 170
    - printing without using Print Manager, 175
  - removing a printer, 173 – 174
  - setting system date and time, 188 – 189
  - Settings dialog box, 176
  - Setup Printer dialog box, 165 – 166
  - Sound option, 190
  - starting, 145
  - Time Format dialog box, 184
- Control+Break Checking command, in Recorder, 419
- Controls command, in Calendar, 376
- Conventional memory, described, 494
- Conventions used in this guide, described, xxi
- Copies option, in Write, 256
- Copy command
  - copying a PIF to your Windows directory, 446
  - copying files or directories, 131
  - copying from a non-Windows application, 57
  - copying from a Windows application, 57
  - copying program items to a group, 95
  - copying selected text, 69
  - copying text from the Terminal window, 346
  - copying text to a Cardfile card, 392
  - copying the display in Calculator, 360
  - described, 32
- Copy Diskette command, in File Manager, 140
- Copy To command, for saving cutouts, 300
- Copying
  - Cardfile text to another card, 392
  - cutouts in drawings, 298

Copying (*continued*)

- diskettes, 140 – 141
  - files to a group window or icon, 91
  - files to another directory, 130 – 131
  - from non-Windows applications, 57
  - from Windows applications, 57
  - multiple files at once, 131
  - program items between groups, 94
- Correcting typing mistakes, 67
- Country option, in Control Panel, 181
- CR to CR/LF option, in Terminal, 325
- CRC. *See* Cyclic redundancy check scheme
- Create Directory command, in File Manager, 123
- Create Directory dialog box, 123
- Creating directories, 123
- Creating drawings
  - Airbrush tool, 281
  - Box tool, 291 – 292
  - Brush tool, 286 – 287
  - changing standard drawing size, 265 – 266
  - choosing font for text, 275 – 276
  - Circle/Ellipse tool, 293 – 294
  - Color Eraser tool, 282 – 283
  - Curve tool, 288 – 289
  - defining cutouts, 279 – 280
  - described, 263
  - entering text, 274 – 277
  - Eraser tool, 284 – 285
  - Filled Box tool, 291 – 292
  - Filled Circle/Ellipse tool, 293 – 294
  - Filled Polygon tool, 294 – 295
  - Filled Rounded Box tool, 292
  - Line tool, 290 – 291
  - moving in a large drawing, 267
  - Paint Roller tool, 285 – 286
  - Paintbrush window, described, 265
  - Polygon tool, 294 – 295
  - Rounded Box tool, 292
  - selecting a drawing line width, 271
  - selecting a drawing tool, 272
  - selecting colors, 270
  - Text tool, 274
  - using a drawing tool, 272
- Creating groups, 87
- Currency Format dialog box, 185
- Current directory, defined, 103
- Cursor
  - See also* Selection cursor
  - changing blink rate, 158
  - in Paintbrush window
    - changing brush shapes, 287
    - described, 264
    - displaying *x-y* coordinates, 304

Cursor option, in Terminal, 325  
 Cursor Position command, in Paintbrush, 304  
 Curve tool, in Paintbrush, 288 – 289  
 Custom Color Selector dialog box, 150  
 Customizing  
   Calendar, 378 – 381  
     desktop appearance. *See* Desktop  
     keyboard, 189  
     mouse, 187  
     system resource usage. *See* Optimizing Windows  
 Cut command, on Edit menus  
   cutting from a Windows application, 57  
   deleting selected text, 69  
   moving text to another Cardfile card, 392  
   transferring a cutout to the Clipboard, 296

Cutouts  
   changing size, 301  
   copying, 298  
   creating  
     free-form, 279  
     rectangular or square, 280  
   cutting and pasting, 296  
   described, 279  
   flipping, 302  
   inverting colors, 302  
   pasting from a file to a drawing, 300  
   sweeping, 297 – 298  
   tilting, 303  
 Cutting. *See* Copying  
 Cyclic redundancy check scheme, 339

## D

Daily appointment calendar. *See* Calendar  
 Data Bits option, in Terminal, 327  
 Data files. *See* Documents  
 Data transfer  
   between applications, 56  
   between computers. *See* File transfers  
   between modes, 439  
   increasing buffer size for, 551  
   with networks, 548  
 Date & Time dialog box, 188  
 Date command, in Calendar, 374  
 Date Format dialog box, 182  
 Dates  
   adding current date to Notepad files, 404  
   changing the format of, 182 – 183  
   changing the system date, 188  
   marking in Calendar, 380 – 382  
 Day command, in Calendar, 371  
 Day.Markings dialog box, 381  
 Day Settings command, in Calendar, 379

Day Settings dialog box, 379  
 Default option, in Paintbrush, 266  
 Default PIF settings, 449  
 Default Preferences dialog box, 417  
 Default printer, 170  
 Delete command  
   clearing the Clipboard, 62  
   deleting a macro, 415  
   deleting Cardfile cards, 394  
   deleting files or directories, 132  
   deleting groups, 88  
   deleting program items from groups, 94  
 Delete dialog box, in File Manager, 132  
 Deleting  
   associations between files and applications, 136  
   cards from Cardfile, 394  
   files from a print queue, 202  
   files or directories, 131  
   font files, 180  
   groups, 88  
   macros, 415  
   portions of a drawing  
     with BACKSPACE or Undo, 272  
     with the Eraser tool, 284 – 285  
   program items from a group, 94  
   text, 69  
 Demonstrations, creating macros for, 418 – 419  
 Deselect All command, in File Manager, 128  
 Desktop  
   changing cursor blink rate, 158  
   changing icon spacing, 156  
   changing width of window borders, 157  
   color schemes for  
     choosing existing scheme, 147  
     creating, 148 – 149  
     defining custom colors, 150 – 152  
     removing, 150  
   defined, xxiv  
   grid lines, 157  
   initial appearance, 79  
   lining up windows and icons, 157  
   patterns for  
     changing, 153 – 154  
     choosing, 152  
     creating, 154  
     removing, 154  
   saving the appearance for future sessions, 81  
   wallpaper for  
     choosing a bitmap, 155  
     creating, 155  
 Desktop dialog box, 153  
 Detect Idle Time option, in PIF Editor, 465

- Device contention options
  - for 386 enhanced mode, 190 – 192
- Device drivers, installing, 563
- Device Not Selected timeout option, 171 – 172
- Diagonal lines, drawing perfectly straight, 291
- Dial command, in Terminal, 334
- Dial Type option, in Cardfile, 398
- Dialog boxes
  - closing, 41
  - described, 33
  - moving, 41
  - moving within, 34
  - opening the Control menu for, 30
  - options within
    - check boxes, 40
    - command buttons, 35
    - described, 33
    - drop-down list boxes, 38
    - list boxes, 36
    - option buttons, 39
    - text boxes, 36
- Digital command, in Clock, 399
- Direct memory access buffer
  - changing size settings in SYSTEM.INI file, 549
- DIRECTION keys, defined, xxiv
- Directly Modifies options, in PIF Editor, 455
- Directories
  - changing, 108
  - changing default for applications, 97
  - changing sort order, 117
  - collapsing, 111
  - copying, 130 – 131
  - creating, 123
  - current, 103
  - defined, xxiv
  - deleting, 131
  - destination, 128
  - expanding, 109 – 110
  - for a shared copy of Windows, 545
  - moving, 128
  - naming conventions, 122
  - renaming, 133
  - root, 101
  - searching for, 123
  - selecting
    - from directory windows, 125 – 127
    - from the Directory Tree, 108
  - source, 128
- Directory icons, described, 104
- Directory path, in Directory Tree window, 103
- Directory Tree
  - collapsing directory levels, 111
  - described, 101 – 104
- Directory Tree (*continued*)
  - displaying for another disk drive, 104
  - expanding directory levels, 109 – 110
  - selecting from, 108
- Directory windows
  - arranging, 120
  - canceling selections, 128
  - changing default displays, 115 – 116
  - changing sort order, 116 – 117
  - choosing the types of files to display, 118
  - closing
    - all open windows, 121
    - the active window, 121
  - described, 101, 111
  - display options, 114 – 120
  - icons in, 112
  - opening, 112
  - replacing contents of, 114
  - selecting, 113
  - selecting files and directories from
    - all, 127
    - more than one group, 127
    - multiple consecutive, 126
    - multiple nonconsecutive, 126
    - one at a time, 125
  - sort options for, 117
  - starting applications from, 137
  - status bar, 120
  - updating, 121
- Disconnect Net Drive command, in File Manager, 106
- Disconnecting
  - from network printers, 173
  - from network servers, 106
  - from remote computers, 350
- Disk-drive icons, described, 103
- Disk drives, changing, 104
- Disk space
  - and 386 enhanced mode, described, 497
  - and real or standard mode, described, 497
  - conserving by preventing swapping, 507
  - controlling amount used for swapping, 524 – 526
  - displaying number of kilobytes available, 498
  - effect on performance, described, 493
  - freeing up by deleting files, 507
- Disk-caching program, 530 – 535, 587 – 590
- Diskettes
  - copying, 140 – 141
  - formatting, 138
  - system, 139
- Disks
  - labeling, 141
  - volume labels, defined, 103

Display options  
 for the Settings command, 477  
 in PIF Editor, 469

Display Usage options, in PIF Editor, 460

Document windows  
 described, 19  
 opening the Control menu for, 29  
 selecting, 32  
 switching among, 65

Documents  
*See also* Files  
 adding to groups, 88 – 91  
 associating with applications  
 in File Manager, 135 – 136  
 in Program Manager, 91  
 deleting associations, 136  
 opening from group windows, 96  
 opening read-only, 64  
 printing. *See* Printing  
 saving, 64  
 working with in Write. *See* Write  
 working with text, basic techniques, 66 – 69

DOS. *See* MS-DOS

DOS prompt  
 icon for, 53  
 running programs from, 53  
 starting, 53

Dotted box. *See* Selection cursor

Double-clicking, defined, xxiv

Double-click speed, changing, 187

Draft option, in Paintbrush, 309

Draft Quality option, in Write, 256

Drawing area  
 changing standard size, 265  
 described, 264  
 displaying entire drawing, 268 – 269  
 displaying entire screen, 268

Drawings  
 creating. *See* Creating drawings  
 editing. *See* Editing drawings  
 managing files. *See* Paintbrush files  
 printing  
 a portion of drawing, 310  
 changing printers, 313  
 changing standard margins, 311  
 currently displayed drawings, 309 – 310  
 viewing, 268 – 269

Driver Library Disk, 162

Drop-down list boxes  
 described, 38  
 opening, 39

Duplicate command, in Cardfile, 394

Duplicating cards in Cardfile, 394

## E

Echo, keystroke, 324

Edit Colors command, in Paintbrush, 306

Edit Colors dialog box, in Paintbrush, 306

Edit commands in 386 enhanced mode, 32, 60

Editing drawings  
 aligning text and lines, 304  
 basic techniques, 273  
 by zooming in, 305  
 changing cutout size, 301  
 copying cutouts, 298  
 creating custom colors, 306 – 307  
 flipping cutouts, 302  
 inverting colors in cutouts, 302  
 opaque pasting and sweeping, 299  
 pasting cutouts, 300  
 pixel by pixel, 305  
 sweeping cutouts, 297 – 298  
 text, 278  
 tilting cutouts, 303  
 transparent pasting and sweeping, 299  
 using eraser tools, 296  
 using the Clipboard, described, 296

Editing graphics  
 in Paintbrush. *See* Editing drawings  
 in Write. *See* Pictures; editing in Write

Editing text  
 basic techniques, 69  
 in a Paintbrush drawing. *See* Editing drawings  
 in Calendar. *See* Calendar  
 in Cardfile cards, 391 – 392  
 in Terminal, 346 – 348  
 in Write. *See* Write; editing documents

EGA.SYS command line  
 in CONFIG.SYS file, 502, 599

Ellipses, drawing hollow or solid, 293

Ellipsis following command names, defined, 28

EMM386 utility  
 command lines for, 594 – 598  
 installing, 540

EMS bank line, moving, 430, 540

EMS memory. *See* Expanded memory

EMS Memory options, in PIF Editor, 465

Emulate Text Mode option, in PIF Editor, 472

End mark, in Write window, 224

End Task option, in Task List, 489

Enlarge Font command, in Write, 239

Enlarging windows, 45

Entering text in documents, 66

Eraser tool, in Paintbrush, 284 – 285



**Erasing**

- color in a drawing, 282 – 283
- portions of a drawing
  - with BACKSPACE, 272 – 273
  - with the Undo command, 272 – 273
  - with the Eraser tool, 284 – 285
- text in a drawing, 278

**Error checking**

- cyclic redundancy check scheme, 339

**Error messages. *See* Messages****Everything option, in Recorder, 412****Exclusive in Foreground option, in Control Panel, 193****Exclusive option**

- in PIF Editor, 461
- of the Settings command, 477

**Execution options, in PIF Editor, 461****Exit command**

- closing a window, 49
- deleting all files from print queues, 202
- exiting from the Print Manager window, 206
- exiting Terminal, 351
- quitting an application, 63
- quitting File Manager, 142

**Exit Windows command, 11, 98****Expand All command, in File Manager, 110****Expand Branch command, in File Manager, 110****Expand One Level command, in File Manager, 110****Expanded memory**

- controlling use by Windows, 429, 538
- described, 495
- installing additional, 506
- providing by using EMM386, 540
- reconfiguring as extended memory, 501
- use by applications, 465

**Expanded memory emulator, installing, 540****Expanded memory manager, 495****Expanding a directory, 109 – 110****Extended memory**

- described, 495
- installing additional, 504
- reconfiguring expanded memory as, 501
- running SMARTDrive in, 533
- use by applications
  - with 386 enhanced mode, 467 – 468
  - with standard or real mode, 454

**Extending a selection**

- in a list box, 38
- in directory windows, 125 – 126

---

**F**

---

**File attributes**

- described, 134 – 135
- setting, 135

**File Attributes option, in File Manager, 116****File Details command, in File Manager, 115****File formats, choices for Write documents, 254****File information line, in print queue, 200****File Manager**

*See also* Directories and Directory windows

- Associate dialog box, 136
- Change Attributes dialog box, 135
- Confirmation dialog box, 132
- Connect Network Drive dialog box, 105
- copying files and directories, 130
- Create Directory dialog box, 123
- Delete dialog box, 132
- described, 101
- Disconnect Net Drive dialog box, 106
- Include dialog box, 118
- making a system diskette, 139
- Move dialog box, 130
- moving files and directories, 128
- printing files, 134
- quitting, 142
- replacing Program Manager as the startup program, 102
- Search dialog box, 123
- Search Results window, 124
- selecting files. *See* Directory windows
- setting file attributes, 134
- shrinking to an icon, 120
- Sort By dialog box, 117
- starting, 101
- View Other dialog box, 115

**windows**

- arranging, 120
- closing, 121
- updating, 121

**File Merge dialog box**

- in Cardfile, 395
- in Recorder, 416

**File servers. *See* Network servers****File transfers**

- binary
  - described, 335
  - preparing for, 338
  - receiving files, 345 – 346
  - sending files, 344
- protocols for, 335
- specifying communications settings for, 326 – 328

File transfers (*continued*)

## text

- described, 335
- preparing for, 336 – 338
- receiving files, 341 – 343
- sending files, 340 – 341
- viewing files, 343 – 344

## File type option, in File Manager, 119

## Filename extensions

- associating with applications, 136
- conventions for naming files and directories, 122
- deleting associations, 136
- for bitmap files, 155
- for Calendar files, 382
- for Cardfile files, 394
- for Clipboard files, 62
- for group files, 87
- for Notepad files, 402
- for Paintbrush cutout files, 300
- for Paintbrush drawings, 307
- for Paintbrush palette files, 307
- for PIF files, 448
- for program files, 92
- for Recorder files, 414
- for temporary files, 13
- for Terminal files, 320, 350
- for Write files, 254 – 255
- when saving files, 65

## Files

- attributes, 134
- binary transfers, 335
- Clipboard, 61
- copying
  - to a group window or icon, 91
  - to another directory, 130 – 131
- deleting, 131
- deleting to optimize Windows, 508 – 511
- for communications settings, 320
- managing Calendar files
  - opening read-only files, 382
  - removing appointments, 382
- managing Cardfile files
  - merging files, 395
  - tracking file size, 394
- managing Notepad files
  - adding current time and date, 404
  - creating time-log file, 403 – 404
  - displaying file size, 402
- managing Paintbrush files
  - described, 307
  - opening, 308
  - printing a drawing, 309 – 313
  - saving, 308

Files (*continued*)managing Paintbrush files (*continued*)

- using Microsoft Paint files, 308

## managing Recorder files

- changing macro properties, 414
- deleting macros, 415
- merging files, 416

## managing Write files

- backing up, 255
- converting non-Windows files to Write format, 254
- managing Write files (*continued*)
  - converting Word files to Write format, 253
  - format choices when saving documents, 254
  - opening binary files, 254
  - opening Text Only files, 253

## moving

- several at once, 130
- to another directory, 128

## naming conventions, 122

## opening, 64

## opening read-only, 64

## personal, using with a network, 546

## printing. See Printing

## renaming, 133

## saving with ANSI characters in filename, 567

## searching for, 123

## selecting from directory windows, 125 – 127

## sorting in directory windows, 116 – 117

## starting applications from, 137 – 138

## temporary, 13, 509

## text transfers, 335

## FILES command line

- in CONFIG.SYS file, 500 – 501, 517

## Filled Box tool, in Paintbrush, 291 – 292

## Filled Circle/Ellipse tool, in Paintbrush, 293 – 294

## Filled Polygon tool, in Paintbrush, 294 – 295

## Filled Rounded Box tool, in Paintbrush, 292

## Find command

- in Cardfile, 390
- in Notepad, 402
- in Write, 228

## Find dialog box

- in Cardfile, 390
- in Notepad, 402
- in Write, 228

## Find Next option, in Write, 230

## Finding text

- in Cardfile cards, 390 – 391
- in Notepad documents, 401 – 402
- in Write documents, 228 – 229

## Flash if Inactive command, in Print Manager, 204

## Flip Horizontally command, in Paintbrush, 302

## Flip Vertically command, in Paintbrush, 302

Floppy disks. *See* Diskettes  
Flow Control options, in Terminal, 327  
Font Installer, 179  
Fonts  
    defined, 178  
    deleting font files, 180  
    for printers, 168  
    in a Paintbrush drawing, 275 – 276  
    in Write  
        and default printer, 239  
        changing font name, 239 – 240  
        changing font size, 240  
        described, 239  
    installing screen fonts, 178  
    problems with, 214  
    viewing printer fonts on the screen, 178  
Fonts command, in Write, 240  
Fonts dialog box  
    adding a font, 179  
    removing a font, 180  
Footer command, in Write, 247, 249  
Footers  
    adding to documents, 247 – 249  
    defined, 247  
    in Calendar appointments, 385 – 386  
    in Paintbrush drawings, 311 – 312  
    using page numbers as, 249  
Foreground color, selecting for a drawing, 270  
Foreground Priority option  
    in PIF Editor, 464  
    of the Settings command, 477  
Format Diskette command, in File Manager, 139  
Formatting diskettes, 138  
Formatting text. *See* Write; formatting documents  
Free disk space  
    effect on performance, 493  
    increasing by deleting files, 507  
Freehand drawing, with Brush tool, 286  
From/To Pages option, in Write, 256  
Full Screen option  
    in PIF Editor, 461  
    of the Settings command, 477  
Full-duplex systems, 324  
Function keys  
    in Terminal window, 333  
    shortcut keys for macros, 408  
Function Keys command, in Terminal, 330  
Function Keys dialog box, 330 – 332

## G

---

Games group, described, 80  
Generic/Text Only printer driver, 162  
Get Colors command, in Paintbrush, 307  
Go To command, in Cardfile, 389  
Go To dialog box  
    in Cardfile, 389  
    in Write, 226  
Go To Page command, in Write, 226  
GOTO key, 225  
Granularity, for the sizing grid, 157  
Graphics  
    creating in Paintbrush. *See* Creating drawings  
    editing in Write, 232 – 233  
    mode, for applications, 453, 470 – 471  
    resolution, printing problems with, 216  
Graphics Resolution option, in Control Panel, 168  
Group icons, defined, xxiv  
Group windows  
    defined, 81  
    opening, 82  
    opening documents from, 96  
    rearranging, 55, 84  
    rearranging icons when resizing, 83  
    resizing, 42  
    shrinking, 82  
Groups  
    adding items to  
        from File Manager, 91  
        from Program Manager, 88 – 89  
        from Setup, 93  
    appearing when Windows starts up, 79 – 80  
    changing contents of, 88  
    changing the description of, 88  
    copying files to, 91  
    copying items between, 94  
    creating, 87  
    defined, xxiv  
    deleting, 88  
    deleting items from, 94  
    described, 80  
    icons for, 81  
    moving items between, 95  
    starting applications from, 51, 96

---

**H**

Half-duplex systems, 324

Handshaking

- data transfer problems, 352
- printing problems, 215
- specifying in Terminal, 327

Hanging indent

- creating, 245 – 246
- defined, 245

Hangup command, in Terminal, 350

Hard disk

- changing the interleave, 513
- compacting, 512 – 513
- disk space, described, 497
- methods for improving efficiency of, 507

Hardware Compatibility List, 162

Header command, in Write, 247, 249

Headers

- adding to documents, 247 – 249
- defined, 247
- in Calendar appointments, 385 – 386
- in Paintbrush drawings, 311 – 312
- using page numbers as, 249

Height option, in Paintbrush, 266

Help option, in Setup Printer dialog box

- for printer information, 168

Hexadecimal number system

- using with scientific calculator, 364

Hidden file attribute, 135

“Hidden” windows. *See* Inactive windows

Hide Function Keys command, in Terminal, 333

High Memory Area option, in PIF Editor, 468

High Priority command, in Print Manager, 203

Highlighting. *See* Selecting

HIMEM utility, 500 – 501, 583 – 586

Horizontal lines, drawing perfectly straight, 291

Hour Format option, in Calendar, 379

Hue, defined, 150

Hyphens, for optional line breaks, 231

---

**I**

IBM PC extended character set, 569

**Icons**

- changing, 91
- changing spacing of, 156
- copying files to, 91
- defined, xxiv
- described, 23 – 25
- directory, 104
- disk-drive, 103
- for applications, 82

**Icons (continued)**

- for network applications, 554
- group, xxiv, 81
- in Control Panel window, 146 – 147
- in directory windows, 113
- in on-line Help, 74
- lining up, 157
- moving, 41
- opening Control menus for, 29
- program item, xxv, 81
- rearranging
  - individually, 86
  - with Task List, 56
  - with the Arrange Icons command, 84, 86
  - with the Auto Arrange command, 84
- restoring windows from, 46
- shrinking windows to, 44
- switching to, 55

Idle option, in Control Panel, 192

Ignore if Inactive command, in Print Manager, 204

Ignore Mouse option, in Recorder, 412

Image Attributes command, in Paintbrush, 265

Image Attributes dialog box, 265 – 266

Inactive applications, messages from, 63

Inactive printer, making active, 169

**Inactive windows**

- making active, 54
- rearranging to make visible, 84
- selecting when “hidden”, 54

Include command, in File Manager, 118

Include dialog box, 118

**Indentation, paragraph**

- changing, 244
- hanging indent, 245
- vs. changing margins, 244

Indents command, in Write

- changing paragraph indentation, 244
- creating a hanging indent, 246

Index button, in on-line Help, 74

Index cards. *See* Cardfile

**Index command**

- in Cardfile
  - changing the index line, 391
  - filling in a blank card, 387
- in Help menu, 72

Index dialog box, 387

Inserting text, 66

**Insertion point**

- in Notepad window, 400
- in text boxes, 36
- in Write window, 224
- moving through a Write document, 224 – 225

## Installing printers

- checking compatibility, 162
- printer-driver files
  - described, 159
  - Generic/Text Only, 162
  - installing a new version, 161
  - using the current version, 161
- unlisted in Control Panel, 163
- using Control Panel, 159 – 160

## Installing Windows, 7 – 8

## International dialog box, 181

## International settings

- currency format, 185
- date format, 182 – 183
- number format, 186
- options, described, 181 – 182
- time format, 183 – 184

## Interval option, in Calendar, 379

## Inverse command, in Paintbrush, 303

## Italics

- in a Paintbrush drawing, 276
- in Write documents, 237
- purpose in this guide, xxii

**K**

## Kermit option, in Terminal, 339

## Keyboard

*See also* on-line Help

- changing the repeat rate, 189
- for correcting typing mistakes, 67
- for moving in a Notepad file, 401
- for moving in Calendar, 372
- for moving in Write documents, 225
- for moving through cards in Cardfile, 389
- for moving within text, 67
- for scrolling, 48
- for selecting from directory windows, 125
- for selecting from the Directory Tree, 108
- for selecting text in documents, 68
- for using on-line Help, 70, 72
- for working with dialog boxes, 34 – 41
- for working with menus, 26 – 29
- for working with windows, 42 – 47
- formats, defined
  - KEY1 + KEY2, xxiii
  - KEY1, KEY2, xxiii
- function keys in Terminal, 330 – 332
- IBM PC equivalent keystrokes
  - for VT 100 terminals, 576
  - for VT 52 terminals, 573
- recording key sequences. *See* Recorder

Keyboard (*continued*)

- shortcut keys
  - for macros, 407 – 408
  - in Write, 225
- using in Paintbrush
  - for moving in a large drawing, 267
  - mouse button equivalents, 263
- using with Calculator
  - numeric keypad, 358
  - standard calculator functions, 361

## Keyboard buffer for applications, 455

## Keyboard command, in Help menu, 72

## Keyboard dialog box, 189

## Keyboard Layout option, in Control Panel, 181

**L**

## Label Disk command, in File Manager, 141

## Labeling disks, 141

Labels. *See* Volume labels

## Landscape orientation, 166

## Language option, in Control Panel, 181

## Large-frame EMS mode

- moving bank line in, 539
- specifying amount of conventional memory for, 430

## Last Modification Date option

- in File Manager, 115, 117

## Last Modification Time option, in File Manager, 116

## LASTDRIVE command line

- in CONFIG.SYS file, 518

## Line at a Time option, in Terminal, 337

## Line breaks, optional, 231

## Line spacing, changing, 243

## Line tool, in Paintbrush, 290 – 291

## Line Wrap option, in Terminal, 323

## Lines

- aligning in the Paintbrush window, 304
- connecting into polygons, 294 – 295
- drawing curves, 288
- drawing freehand, 286
- drawing straight lines
  - diagonal, 291
  - freehand, 290
  - horizontal, 291
  - vertical, 291

## Linesize box in Paintbrush window

- described, 265
- removing, 267

## List boxes

- described, 36
- drop-down, 38
- selecting multiple items from, 38
- selecting single items from, 37

List command, in Cardfile, 388  
 List of Printers box, 162  
 List Separator option, in Control Panel, 182  
 Local Echo option, in Terminal, 324  
 Lock Application Memory option, in PIF Editor, 469  
 Logarithmic functions, using with Calculator, 368 – 369  
 Long Date Format option, in Control Panel, 183  
 Low Priority command, in Print Manager, 203  
 Lower Case command, in File Manager, 120  
 Luminosity, defined, 150

## M

Macro Properties dialog box, 415  
 Macros. *See* Recorder  
 Magnetic grid on desktop, 157  
 Magnifying portions of a drawing, 305  
 Main group, described, 80  
 Make System Diskette command  
   in File Manager, 139, 537  
 Margins  
   changing for Calendar appointments, 384  
   changing for Paintbrush drawings, 311  
   changing for whole document, 252  
   standard, in Write documents, 247  
 Mark command  
   described, 32  
   in Calendar, 381  
 Maximize button, described, 22  
 Maximize command, on Control menus  
   described, 32  
   restoring a window to its previous size, 45  
 Measurement option, in Control Panel, 182  
 Medium Priority command, in Print Manager, 203  
 Memory  
   and swapping by Windows, 497  
   configuring  
     on an 80286 computer, 501  
     on an 80386 or 80486 computer, 499 – 500  
     on an 8086 or 8088 computer, 502  
   conserving with keyboard option, 455  
   conserving with Prevent Program Switch option, 456  
   conventional, described, 294  
   expanded, described, 495  
   extended, described, 495  
   for large drawings, 264  
   for wallpaper, 156  
   freeing up, 478 – 482, 515 – 518  
   functions in Calculator, described, 359  
   identifying your system's configuration, 496  
   installing the expanded memory emulator, 540  
   network card for, 548  
   reconfiguring expanded as extended, 501

Memory (*continued*)  
   reserving, for direct memory access, 549  
   used by the Clipboard, 62  
   using a RAM disk, 535, 591 – 594  
   using the EMM386 utility, 594 – 598  
   using the HIMEM utility, 583 – 586  
   using the SMARTDrive program, 530, 587 – 590  
 Memory option, in Control Panel, 168  
 Memory Requirements option, in PIF Editor, 453, 460  
 Memory-resident software  
   described, 442  
   minimizing use of memory, 515, 519  
   running with Windows, 51, 443  
   starting from the WINSTART.BAT file, 519  
 Menu bars, described, 22  
 Menus  
   canceling, 26  
   cascading, 28  
   commands  
     active vs. inactive, 28  
     choosing, 27  
     dimmed, 28  
   Control, 28  
   conventions, 27  
   defined, xxiv  
   described, 25  
   selecting, 26  
 Merge command  
   merging Cardfile files, 395  
   merging Recorder files, 416  
 Merging files  
   in Cardfile, 395  
   in Recorder, 416  
 Messages  
   from inactive applications, 63  
   from Print Manager, 204  
   suppressing in File Manager, 132  
   system, 13 – 14  
 Microsoft Paint files, using in Paintbrush, 308  
 Minimize button, described, 22  
 Minimize command, on Control menus  
   described, 32  
   shrinking a group window to an icon, 82  
   shrinking a window to an icon, 44  
 Minimize on Use command  
   described, 120  
   retaining the Recorder window for macro playback, 410  
   shrinking Program Manager to an icon, 97  
 Modem commands, in Terminal, 329  
 Modems  
   choosing commands for, 328  
   connecting to serial port, 317  
   entering phone number for Terminal sessions, 320 – 322

Modems (*continued*)

- problems with
  - failure to dial, 351
  - misdialing, 351
- supported by Windows, x

## Modes

- 386 enhanced. *See* 386 enhanced mode
- for running Windows, defined, xxiii – xxv
- graphics, 453, 470 – 471
- large-frame EMS, 538
- multiple text, for applications, 453
- real. *See* Real mode
- small-frame EMS, 538
- standard. *See* Standard mode
- text, for applications, 453, 470 – 471

## Monitor Ports options, in PIF Editor, 471

## Monochrome monitor, using with Paintbrush, 277

## Month command, in Calendar, 371

Monthly calendar. *See* Calendar

## Mouse buttons

- changing double-click speed, 187
- clicking, defined, xxiii
- double-clicking, defined, xxiv
- right vs. left
  - in Paintbrush, 263
  - switching functions, 188

## Mouse dialog box, 187

## Mouse pointer

- changing speed of movement, 187
- in Write window, 224

## Mouse-driver software, minimizing use of memory, 518

## Move command

- described, 32
- moving a window, icon, or dialog box, 42
- moving files or directories, 130
- moving program items between groups, 95

## Move dialog box, in File Manager, 130

## Move Picture command, in Write, 232

## Moving

- Cardfile text among cards, 392
- data between applications, 56
- dialog boxes, 41
- files to another directory, 128
- icons, 41
- multiple files at once, 130
- program items between groups, 95
- windows, 41
- within dialog boxes, 34

MS-DOS Executive. *See* File Manager

## MS-DOS

- applications. *See* Non-Windows applications
- commands to avoid running from Windows, 54
- naming conventions for files, 122

MS-DOS (*continued*)

- wildcard characters for specifying filenames, 123, 128
- Multiple Text mode for applications, 453
- Multitasking
  - See also* Applications, running two or more at once
  - options for 386 enhanced mode, 192 – 193, 463 – 465

---

**N**

---

## Name command, in File Manager, 115

## Name option, in File Manager, 117, 119

## Naming conventions, for files and directories, 122

## Nested macros, 413

## Network command, in Print Manager

- ignoring network queue status, 209
- printing directly to the network, 210

## Network Connections dialog box, 172

## Network Options dialog box

- network printing with Print Manager, 210
- updating network queues, 209

## Network options, choosing, 177

## Network printers

- connecting to, 172
- disconnecting from, 173

## Network printing

- described, 206
- print queues
  - displaying all files for a printer, 206
  - displaying files you send, 200
  - displaying other network queues, 207
  - updating, 208 – 209
- printing large files, 209
- with Print Manager, 209
- without Print Manager, 174

## Network servers

- adding new connections to the Previous list, 105
- browsing, 106
- choosing from previous connections, 105
- connecting to, 105 – 106
- described, 104
- disconnecting from, 106
- displaying connections with Print Manager, 200

## Networks

- features of Windows for, 547
- guidelines for using with Windows, 546 – 550
- improving access to applications, 554
- installing network applications in Program Manager, 555
- installing Windows on, 553
- problems with
  - connecting to network drivers or printers, 553
  - non-Windows applications won't run, 552
  - system fails at start-up, 548 – 549
  - system fails with specific application, 550

Never Warn option, in Control Panel, 192

New command, on File menus

- adding program items and documents to groups, 89
- creating a new group, 87
- opening a drawing with a new color, 270
- opening a drawing with a new standard size, 265
- opening a new settings file, 320

New Program Object dialog box, 87

Next command

- described, 32
- selecting an open directory window, 113
- switching among document windows, 65
- viewing the next Calendar day or month, 373, 375

No Screen Exchange option, in PIF Editor, 455

Non-Windows applications

- changing settings for
  - described, 441
  - with PIF Editor. *See* PIF Editor
  - with the Settings command, 476 – 478
- conserving memory when running, 519

Control menu, 30

- copying an entire screen, 58
- copying information from, 57
- copying PIFs from non-Windows disks, 445
- creating multiple PIFs for, 442
- creating single PIFs for, 448
- defined, xxiv
- described, 49
- display of, 49
- full-screen, 49
- group in Program Manager, described, 80
- improving speed with SMARTDrive, 531
- installing predefined PIFs for, 445
- memory-resident. *See* Memory-resident software
- network problems with, 552
- pasting into, 59 – 60
- PIFs for, described, 445
- printing with, 197
- problems with. *See* Troubleshooting
- quitting, 63
- running from a PIF, 441
- running from MS-DOS, 53
- running in a window, 461, 477
- using special characters with, 571
- with 386 enhanced mode, 50

Normal command, in Write, 276

Notepad

- described, 400
- entering and editing text, 400
- Find dialog box, 402
- finding text, 401 – 402

Notepad (*continued*)

- managing files
  - adding current time and date, 404
  - creating time-log files, 403 – 404
  - displaying file size, 402
- moving through a document, 401
- printing files, 404
- selecting text, 401
- starting, 399
- word wrap option, 400

Null modem cable, 317

Number base functions, using with Calculator, 367

Number Format dialog box, 186

Number of Copies option, in Paintbrush, 309

Number systems

- converting values with scientific calculator, 364

Numbers, changing display format of, 186

Numeric keypad keys

- shortcut keys for macros, 408

## O

---

Octal number system

- using with scientific calculator, 364

On-line Help

- buttons in, 74
- described, 70
- exiting, 74
- Help menu options, described, 72
- requesting, 70
- retracing steps through, 74
- searching for a topic, 73
- selecting topics, 74
- using the Help menu, 71
- viewing next or previous topic, 74

Open command, on File menus

- converting a Microsoft Paint file, 308
- opening a document or file, 64
- opening a settings file, 320
- opening read-only Calendar files, 382
- retrieving a Clipboard file, 62
- starting
  - an application from a directory window, 137
  - an application from File Manager, 52
  - an application from Program Manager, 51
  - Calculator, 357
  - Calendar, 370
  - Cardfile, 386
  - Clock, 398
  - File Manager, 102
  - Notepad, 399
  - Paintbrush, 263
  - PIF Editor, 446



Open command, on File menus (*continued*)  
starting (*continued*)

- Recorder, 405
- Write, 223

Opening

Control menus

- for application windows, 28
- for dialog boxes, 30
- for document windows, 29
- for icons, 29
- for non-Windows applications, 30

directory windows, 112

documents, 64

drop-down list boxes, 39

files, 64

Operators, using with Calculator, 366

Optimizing Windows

- by adjusting permanent swap file size, 523
- by changing the hard disk's interleave, 513
- by compacting the hard disk, 512 – 513
- by configuring memory correctly, 499
- by controlling temporary swap file size, 528
- by controlling use of expanded memory, 539
- by deleting unnecessary files, 508 – 511
- by freeing up memory before starting, 515 – 518
- by installing additional expanded memory, 506
- by installing additional extended memory, 504
- by reconfiguring expanded memory as extended, 501
- by setting location of application swap files, 529 – 530
- by setting the TEMP environment variable, 538
- by using a permanent swap file, 521 – 524
- by using a temporary swap file, 526 – 528
- by using the EMM386 utility, 540, 596 – 598
- by using the HIMEM utility, 583 – 586
- by using the RAMDrive utility, 535, 591 – 594
- by using the SMARTDrive utility, 530 – 535, 587 – 590
- by using the WINSTART.BAT file, 519
- described, 493
- disk space, described, 497
- memory, described, 494 – 495
- table of methods for, 503

Option buttons

- described, 39
- selecting, 40

Optional hyphens, in Write documents, 231

Optional Parameters option, in PIF Editor, 451

Orientation option, in Control Panel, 168

Other command, in File Manager, 115

Other Net Queue command, in Print Manager, 207

Other Net Queue dialog box, 207

Overlapping windows

- rearranging, 84, 120
- selecting when “hidden”, 114

## P

---

Page breaks

- automatic, 234 – 235
- confirming, 236
- manual, 235 – 236
- searching for, 229
- when changing printers, 257

Page layout

- changing for whole document, 252
- standard, 247

Page Layout command, in Write, 252

Page Layout dialog box, 252

Page numbering, changing for whole document, 252

Page numbers

- from automatic page breaking, 235
- using as header or footer, 249

Page orientation, 166

Page Setup command

- printing a header or footer in a drawing, 312
- printing a header or footer on appointments, 385
- setting margins for printing a drawing, 311
- setting margins for printing appointments, 384

Page Setup dialog box

- in Calendar, 384
- in Paintbrush, 311

Page status area, in Write window, 224

Paint files, using in Paintbrush, 308

Paint Roller tool, in Paintbrush, 285 – 286

Paintbrush

- advanced features, 301
- Airbrush tool, 281
- Box tool, 291 – 292
- Brush Shapes dialog box, 287
- Brush tool, 286 – 287
- Circle/Ellipse tool, 293 – 294
- Color Eraser tool, 282 – 283
- creating a drawing. *See* Creating drawings
- Curve tool, 288 – 289
- Edit Colors dialog box, 306
- editing a drawing. *See* Editing drawings
- editing text in a drawing, 278
- Eraser tool, 284 – 285
- Filled Box tool, 291 – 292
- Filled Circle/Ellipse tool, 293 – 294
- Filled Polygon tool, 294 – 295
- Filled Rounded Box Tool, 292
- Image Attributes dialog box, 265
- Line tool, 290 – 291
- managing files
  - described, 307
  - opening, 307
  - saving, 307

- Paintbrush (*continued*)
  - managing files (*continued*)
    - using Microsoft Paint files, 307
  - mouse vs. keyboard, 263
  - Page Setup dialog box, 311 – 312
  - Paint Roller tool, 285 – 286
  - Pick cutout tool, 280
  - Polygon tool, 294 – 295
  - Print dialog box, 309
  - printing a drawing
    - changing printers, 313
    - changing standard margins, 311
    - currently displayed drawing, 309 – 310
    - portions of, 310
    - problems with, 216
    - with headers and footers, 311 – 312
  - Rounded Box tool, 292
  - Scissors cutout tool, 279
  - starting, 263
  - Text tool, 274
  - window, described, 263 – 265
- Palette command, in Paintbrush, 267
- Palette, in Paintbrush window
  - described, 265
  - removing, 267
- Paper Orientation option, in Control Panel, 168
- Paper Size option, in Control Panel, 167
- Paper source option, in Control Panel, 167
- Paragraph format
  - changing alignment, 243
  - changing indentation, 244
  - changing line spacing, 243
  - creating hanging indents, 245 – 246
  - described, 240
  - paragraph marks, 242
  - using the Ruler, 240 – 244
- Paragraph marks
  - adding, 242
  - deleting, 243
  - searching for, 229
- Parameters for applications, 451, 459
- Parity Check option, in Terminal, 328
- Parity option, in Terminal, 327
- Parity, using with file transfers, 335
- Partial option, in Paintbrush, 310
- Paste command, on Edit menus
  - copying a cutout from the Clipboard, 296
  - copying a number to Calculator's display, 360
  - copying a picture to a Cardfile card, 393
  - copying into a non-Windows application, 60
  - copying into a Windows application, 59
  - copying text to a Cardfile card, 392
  - described, 32
- Paste command, on Edit menus (*continued*)
  - inserting cut or copied text, 70
  - sending Clipboard contents to a remote system, 347
- Paste From command, for retrieving cutouts, 300
- Pasting
  - cutouts from files, 300
  - cutouts in drawings, 296
  - numbers in Calculator
    - binary, octal, and hex values, 364
    - decimal values, 360
  - opaquely
    - described, 299
    - when moving a cutout, 297 – 298
  - pictures onto cards, 393
  - portions of a drawing, 273
  - text into the active window, 70
  - to non-Windows applications, 59 – 60, 488
  - to Windows applications, 59
  - transparently
    - described, 299
    - when moving a cutout, 297 – 298
- Pathname, defined, xxv
- Patterns
  - filling in shapes with, 285 – 286
  - for the desktop
    - changing, 153 – 154
    - choosing, 152
    - creating, 154
    - removing, 154
  - selecting for a drawing, 270
- Pause button
  - in Print Manager, 201
  - in Terminal, 344
- Phone Number command, in Terminal, 321
- Phone Number dialog box, 321, 334
- Phone numbers
  - automatic dialing by Cardfile, 397
  - for Terminal sessions, 320 – 322
- Pick cutout tool, in Paintbrush, 280
- Picture command, in Cardfile, 393
- Pictures
  - creating in Paintbrush. *See* Creating drawings
  - editing in Write
    - changing picture size, 233
    - moving pictures, 232 – 233
  - pastings on cards in Cardfile, 393
- PIF Editor
  - changing modes, 447
  - creating a PIF
    - for a batch file, 448
    - for an application, 448

PIF Editor (*continued*)

- options for 386 enhanced mode
  - advanced, 462 – 475
  - basic, 452, 457 – 474
- options for standard or real mode, 450 – 457
- overriding default PIF settings, 449

## PIFs

- See also* PIF Editor
- copying from non-Windows disks, 445
- creating, 448
- described, 444
- for batch files, 448
- installing predefined PIFs, 445
- multiple PIFs for an application, 442
- running non-Windows applications from, 441

## Pixels, editing one by one, 305

## Placeholders in bold text, defined, xxii

## Playback Speed option, in Recorder, 417

## Playback To option, in Recorder, 417

## Point size, defined, 178

## Pointer, described, 22

## Pointing with the mouse, defined, xxv

## Polygon tool, in Paintbrush

- using lines at any angle, 294 – 295
- using lines with fixed angles, 295

Pop-up programs. *See* Memory-resident software

## Port option, in Cardfile, 398

## Portrait orientation, 166

## Ports

- choosing, 163 – 164
- communications settings for, 175
- for communications applications, 455
- for remote communications, 317

## Ports dialog box, 176

## Preferences command, in Recorder, 417

## Prevent Program Switch option, in PIF Editor, 456

## Previous command, in Calendar, 373, 375

## Print All command, in Cardfile, 396

## Print command

- in Calendar, 383
- in Cardfile, 396
- in File Manager, 134
- in Notepad, 404
- in Paintbrush, 309
- in Write, 255

## Print dialog box

- in Calendar, 383
- in Paintbrush, 309
- in Write, 256

## Print File Size command, in Print Manager, 205

## Print Manager

*See also* Printing, Network printing

described, 198

## Network Options dialog box

- network printing with Print Manager, 210
- updating network queues, 209

## Other Net Queue dialog box, 207

print queues. *See* Print queues

## Selected Net Queue dialog box, 207

## starting, 199

## window

- described, 199
- exiting, 205
- opening, 199
- showing network queues, 200
- showing one queue, 199

## Print options

- defined, 166
- for printer configuration, described, 167

## Print queues

- changing order of files, 200
- defined, 198
- deleting files, 202
- displaying
  - all files for a network printer, 206
  - described, 198
  - file information line, 200
  - for multiple printers, 200
  - for network printers, 200
  - for other networks, 207
  - printer queue information line, 199
- file size display, turning off, 205
- interrupting printing, 201
- time/date display, turning off, 205
- updating network queues, 208 – 209

## PRINT SCREEN key

- copying screens to the Clipboard, 58

## Printer echo

- printing incoming text, 349
- setting for Terminal sessions, 349

## Printer Echo command, in Terminal, 349

Printer installation. *See* Installing printers

## Printer option, in Control Panel, 167

## Printer queue information line, 199

## Printer Setup command

- in Paintbrush, 313
- in Write, 257

## Printer Setup dialog box, in Write, 257

## Printer-driver files

- and non-Windows applications, 197
- described, 159
- for more than one printer, 167
- Generic/Text Only printer driver, 162

Printer-driver files (*continued*)

- installing new version, 161
- non-Windows printer drivers, 163
- obtaining the Driver Library Disk, 162
- removing, 174
- using existing version, 161

## Printer-specific settings, 166

## Printers

*See also* Printer-driver files

- active, 169
- compatibility of, 162
- configuring
  - changing the print options, 166 – 168
  - choosing a connection, 163 – 164
  - choosing the active printer, 169
  - choosing the default printer, 170
  - choosing timeout options, 171 – 172
  - described, 164
  - setting access priorities for 80386 computers, 164
- connecting to a network printer, 172
- default, 170
- disconnecting from a network printer, 173
- fonts for, 168
- Help (print option), 168
- installing, 158 – 162
- printer-driver files, described, 159
- problems with. *See* Printing; problems with removing, 173 – 174
- using Generic/Text Only printer driver, 162

## Printers dialog box

- adding printers, 159 – 160
- choosing the active printer, 169
- choosing the default printer, 170
- printing without Print Manager, 175

## Printing

- Calendar appointments, 383 – 386
- cards in Cardfile, 396
- from File Manager, 134
- from Terminal, 348 – 349
- Notepad files, 404
- on a network. *See* Network printing
- Paintbrush drawings, 309 – 313
- preparing printers for. *See* Printers
- problems with
  - garbled output, 213
  - incorrect page format, 213
  - installed fonts do not print, 214
  - lines missing from a Paintbrush drawing, 216
  - lost blocks of text, 215
  - part of a document does not print, 216
  - printer does not print, 212
- text files from File Manager, 134
- to a file, 210 – 211

Printing (*continued*)

- transferred files, 348 – 349
- with non-Windows applications, 197
- with Print Manager
  - changing order in print queue, 200
  - changing printing speed, 202 – 203
  - deleting files from print queues, 202
  - described, 198
  - displaying messages, 204
  - displaying print queues, 198 – 200, 205
  - interrupting printing, 201
  - on a network, 206 – 209
  - using Pause and Resume buttons, 201
- with Windows applications, described, 197
- without Print Manager, 174
- Write documents
  - changing printers, 257
  - print options, 255 – 256

## Printing speed, changing, 202 – 203

## Priority options, for non-Windows applications, 477

Problems. *See* Troubleshooting

## Procedures command, in Help menu, 72

## Processing time

- and options for 386 enhanced mode, 192 – 193
- and printing speed, 203

## Program Filename option, in PIF Editor, 451, 458

## Program Group Properties dialog box, 87

## Program item icons

- defined, xxv
- described, 82

## Program Item Properties dialog box, 90

## Program items

- adding
  - from File Manager, 91
  - from Program Manager, 88 – 89
  - from Setup, 93
- browsing through, 90
- changing icons for, 91
- changing properties of, 96
- command line for, 90
- copying to another group, 94
- deleting, 94
- icons for, 82
- moving to a different group, 95

## Program Manager

- changing layout of, 81
- described, 79 – 80
- groups, described, 80
- installing network applications in, 555
- New Program Object dialog box, 87
- Program Group Properties dialog box, 87
- Program Item Properties dialog box, 90
- quitting, 11 – 12, 98

Program Manager (*continued*)  
  replacing with File Manager as start-up program, 102  
  returning to, 97  
  shrinking, 97  
  starting, 79  
Proof option, in Paintbrush, 310  
Properties command, in Program Manager  
  changing a group's description, 88  
  changing a macro's properties, 414  
  changing a program item's properties, 96  
Protected mode. *See* Standard mode, 386 enhanced mode  
Protocols  
  for binary and text transfers, 335  
  Kermit, described, 339  
  XModem/CRC, described, 339

## Q

---

Queues. *See* Print queues

### Quitting

  applications, 10, 63  
  File Manager, 142  
  non-Windows applications, 489  
  Program Manager, 11 – 12, 98  
  Windows, 11 – 12, 98

## R

---

### RAM disk

  defined, 535  
  setting the TEMP environment variable to, 519, 538  
  using for application swap files, 530

### RAMDrive utility

  command lines for, 591 – 594  
  described, 535  
  setting up, 536

Read Only file attribute, 134

Read-only files, 64

### Real mode

  controlling use of expanded memory, 429  
  defined, xxv  
  freeing up memory for applications, 479  
  PIF options for. *See* Standard mode  
  requirements for running, x  
  running applications in, 438  
  starting Windows in, 428

### Rearranging. *See* Arranging

Receive Binary File command, in Terminal, 345

Receive Binary Files dialog box, 345

Receive Text File command, in Terminal, 341

Receive Text File dialog box, 341

### Record command, in Recorder

  choosing options for recording a macro, 410  
  recording a simple macro, 406

Record Macro dialog box, 406

Record Mouse box, 411

Record Mouse option, in Recorder, 417

### Recorder

  Default Preferences dialog box, 417

  described, 405

  File Merge dialog box, 416

  guidelines for recording macros, 420

  Macro Properties dialog box, 415

  macros for demonstrations

    creating, 418

    disabling CTRL + BREAK, 419

  managing files

    changing macro properties, 414

    deleting macros, 415

    merging files, 416

  naming macros, 408

  options for playing back macros

    continuous playback, 418

    minimizing Recorder at playback, 410

    play back in any application, 413

    play back in one application, 413

    slow speed, 418

  options for recording macros

    changing standard settings, 417 – 418

    described, 410

    including mouse movements, 411 – 412

    macros that cannot nest, 413

    nested macros, 413

    relative to window or full screen, 412

    standard settings, described, 417

  playing back a macro, 409

  Record Macro dialog box, 406

  Record Mouse box, 411

  recording simple macros, 405 – 407

  shortcut keys

    assigning to macros, 407 – 408

    disabling temporarily, 419

  starting, 405

  stopping a macro during playback, 409

### Rectangles

  drawing hollow or solid, 291 – 292

  drawing with round corners, 292

Redial After Timing Out option, in Terminal, 321

Reduce Font command, in Write, 239

Reducing. *See* Shrinking

Refresh command, in File Manager, 121

Registering Windows, xi

Relative To option, in Recorder, 417

### Remote computers

*See also* Terminal

  communications settings for, 318

  connecting to, 334

Remote computers (*continued*)  
 disconnecting from, 350

Remote echo, defined, 324

Remove command, in Calendar, 383

Remove dialog box, in Calendar, 383

Rename command, in File Manager, 133

Renaming files and directories, 133

Repaginate command, in Write, 234

Repaginate Document dialog box, 234

Repaginating Document dialog box, 236

Repeat Last Find command, in Write, 311

Repeat rate of keyboard, changing, 189

Replace on Open command, in File Manager, 114

Replacing  
 contents of the active directory window, 114  
 text, 69

Requirements for running Windows, x

Reserve Shortcut Keys options, in PIF Editor, 457, 474

Resizing windows, 42

Restore button, described, 22

Restore command  
 described, 32  
 restoring a window to its previous size, 47  
 restoring an icon to a window, 46  
 undoing changes to a Cardfile card, 393

Resume button  
 in Print Manager, 201  
 in Terminal, 344

Retain Video Memory option, in PIF Editor, 472

Reversi. *See* on-line Help in Reversi

Reversing edit commands, 69

Revisions for Windows, xi

Root directory, described, 101

Rounded Box tool, in Paintbrush, 292

Ruler Off command, in Write, 241

Ruler On command, in Write, 241

Ruler, in Write window  
 changing line spacing with, 244  
 changing paragraph alignment with, 243  
 changing paragraph indentation with, 244  
 deleting tabs with, 251  
 displaying, 241  
 hiding, 241  
 setting tabs with, 251

Run command  
 playing back a macro, 409  
 starting an application, 52, 138  
 starting Swapfile, 522

Running. *See* Starting

## S

Saturation, defined, 150

Save As command, on File menus  
 backing up a Write document, 255  
 creating a PIF, 448  
 overriding standard PIF settings, 449  
 saving a drawing in nonstandard format, 307  
 saving a file under another name, 65  
 saving a settings file under a new name, 350  
 saving the Clipboard contents, 62

Save Colors command, in Paintbrush, 307

Save command, on File menus  
 saving a document or file, 65  
 saving a drawing, 307  
 saving a settings file, 350  
 saving a Write document, 254

Save Controls option, in Terminal, 342

Saving documents and files  
 formatting choices in Write, 254  
 with different names, 65  
 with the same name, 65

Scientific calculator  
 displaying, 362  
 functions, 366 – 369

Scissors cutout tool, in Paintbrush, 279

Scratch pad, in Calendar, 373

Screen fonts  
 installing, 178  
 viewing printer fonts on screen, 178

Scroll bars  
 described, 22  
 displaying in Terminal sessions, 324  
 for moving in a Paintbrush drawing, 267  
 for moving through a Write document, 224  
 in the Directory Tree window, 104  
 viewing text in windows and dialog boxes, 47

Scroll buffer in Terminal window, 348

Search button, in on-line Help, 74

Search command, searching for files or directories, 123

Search dialog box  
 in File Manager, 123  
 in on-line Help, 73

Search Results window in File Manager, 124

Searching for files or directories, 123

Select All command  
 selecting all files in a directory window, 127  
 selecting all text in a Notepad file, 401  
 selecting all text in the Terminal window, 347

Selected Net Queue command, in Print Manager, 206

Selected Net Queue dialog box, 207

## Selecting

- application windows, 54
- check boxes, 40
- defined, xxv
- directories and files from directory windows, 125, 127
- directories from the Directory Tree, 108
- directory windows, 113
- from drop-down list boxes, 39
- from list boxes
  - multiple items, 38
  - single items, 37
- “hidden” windows, 114
- menus, 26
- option buttons, 40
- text
  - described, 67
  - in text boxes, 36
  - with the Mark command, 57

Selection bar, described, 226 – 227

Selection cursor, described, 22

Send Binary File command, in Terminal, 344

Send Binary File dialog box, 344

Send command, in Terminal, 347

Send Text File command, in Terminal, 340

Send Text File dialog box, 340

Serial ports. *See* Ports

Set command, in Calendar

- removing an alarm, 378

- setting an alarm, 375

Set System Default option, in File Manager, 116 – 119

Set Up Applications command, in Setup, 93, 562

Set Up Applications dialog box, 93, 562

Settings command, on Control menus

- changing settings for a running application, 476

- terminating a non-Windows application, 490

Settings dialog box, 176, 476

Settings files in Terminal. *See* Terminal

Setup Printer dialog box, 165 – 166

Setup program

- adding applications to Windows, 562

- adding program items to groups, 93

- Change System Settings dialog box, 560

- changing system settings, 560

- described, 7

- installing device drivers, 563

- reinstalling Windows, 565

- running from Windows, 559

- running to install Windows, 7

- Set Up Applications dialog box, 93, 562

- using to maintain the Windows environment, 559

Shading a drawing, with the Airbrush tool, 281

## Shapes

- cutting out, 279

- drawing circles

- with Circle/Ellipse tool, 293 – 294

- with perfect proportions, 294

- drawing ellipses, 293

- drawing freehand, 286

- drawing polygons

- using lines at any angle, 294 – 295

- using lines at fixed angles, 295

- drawing rectangles

- with round corners, 292

- with square corners, 291 – 292

- drawing squares

- with perfect proportions, 292

- with rounded corners, 292

- with square corners, 291 – 292

- filling in with color, 285 – 286

SHELL command line, in CONFIG.SYS file, 518

Short Date Format option, in Control Panel, 183

Shortcut keys

- assigning to macros, 407 – 408

- disabling temporarily in Recorder, 419

- for moving an application to foreground, 475

- for switching to a pop-up program, 444

- in menus, described, 28

- in Write, 225

- problems with, 483, 485

- reserving for applications

- in 386 enhanced mode, 457, 474

- in standard or real mode, 457

Shortcut Keys command, in Recorder, 419

Show Date dialog box, 374

Show Function Keys command, in Terminal, 333

Show Hidden/System Files option, in File Manager, 119

Show Scroll Bars option, in Terminal, 324

Shrink + Grow command, in Paintbrush

- adjusting cutout size, 301

- adjusting picture size for printing, 216

Shrinking

- cutouts in a drawing, 301

- File Manager when applications start, 120

- group windows, 82

- Program Manager on application start-up, 97

- windows to icons, 44

Signal When Connected option, in Terminal, 321

Size command, on Control menus

- changing the size of a window, 43

- described, 32

Size of windows

- changing, 42

- minimum, 42

Size option, in File Manager, 115, 117

- Size Picture command, in Write, 233
- Small-frame EMS mode, running Windows in, 539
- SMARTDrive program
  - command lines for, 587 – 590
  - described, 530
  - installing, 532
  - running in extended or expanded memory, 533
  - specifying the disk cache size, 533 – 535
- Soft fonts, installing, 179
- Solitaire. *See* on-line Help in Solitaire
- Sort By command, in File Manager, 117
- Sort By dialog box, 117
- Sorting contents of directory windows, 116 – 117
- Sound option
  - in Control Panel, 190
  - in Terminal, 324
- Source directories, defined, 128
- Spaces, searching for, 229
- SPART.PAR file, 509, 521
- Special Time command, in Calendar, 380
- Special Time dialog box, 380
- Speed of computer system
  - described, 493
  - improving by using RAMDrive, 535, 591 – 594
  - improving by using SMARTDrive, 530 – 535
- Spooling. *See* Print Manager
- Spray painting with the Airbrush tool, 281
- Squares
  - drawing hollow or solid, 291 – 292
  - drawing perfect squares
    - with round corners, 292
    - with square corners, 292
- STACKS command line, in CONFIG.SYS file, 518
- Standard applications. *See* Non-Windows applications
- Standard calculator
  - displaying, 357
  - functions, 361
- Standard command, in PIF Editor, 447
- Standard Flow Control option, in Terminal, 336
- Standard mode
  - defined, xxv
  - freeing up memory for applications, 479
  - non-Windows applications with, described, 440
  - PIF options for
    - Close Window on Exit, 456
    - Directly Modifies, 455
    - Memory Requirements, 453
    - No Screen Exchange, 455
    - Optional Parameters, 451
    - Prevent Program Switch, 456
    - Program Filename, 451
    - Reserve Shortcut Keys, 457
    - Start-up Directory, 452
  - Standard mode (*continued*)
    - PIF options for (*continued*)
      - Video Mode, 452
      - Window Title, 451
      - XMS Memory, 454
    - problems running applications in, 551
    - requirements for running, x
    - starting Windows in, 429
    - transferring information, 32
  - Start-up Directory option, in PIF Editor, 452
  - Starting
    - applications
      - from a directory window, 137
      - from a document or program file, 137
      - from a group, 51, 96
      - from a network, 546
      - from directory windows, 51
      - from the Windows command line, 431
      - with the Run command, 52
    - Calculator, 357
    - Calendar, 370
    - Cardfile, 386
    - Clock, 398
    - Control Panel, 145
    - DOS prompt, 53
    - File Manager, 102
    - Notepad, 399
    - Paintbrush, 263
    - Print Manager, 199
    - Program Manager, 79
    - Recorder, 405
    - Terminal, 319
    - Windows
      - general instructions for, 8
      - in 386 enhanced mode, 429
      - in real mode, 428
      - in standard mode, 429
      - options for, described, 427
      - Write, 223
  - Starting Time option, in Calendar, 379
  - Statistical calculations, 364 – 366
  - Statistical functions, using with Calculator, 368
  - Statistics Box buttons, described, 366
  - Status Bar command, in File Manager, 120
  - Status bar, in directory windows, 120
  - Status messages. *See* Messages
  - Stop Bits option, in Terminal, 328
  - Stop button, in Terminal, 344
  - Subscript, 238
  - Superscript, 238
  - Support for Windows, xi



## Swap files

application. *See* Application swap files  
described, 520

displaying information about, 520

## permanent

adjusting size of, 524  
changing location of, 524  
described, 521  
removing, 525  
setting up, 522

## temporary

changing location of, 528  
controlling size of, 528  
deleting to free up disk space, 509  
described, 520, 526  
setting up, 527

## Swapfile program

options, described, 523  
using to create a Windows swap file, 521

## Swapping

described, 497  
preventing, 507

## Sweeping

cutouts in drawings, 297 – 298  
opaquely  
described, 299  
when dragging a cutout, 298  
transparently  
described, 299  
when dragging a cutout, 298

## Switch To command, on Control menus

described, 32  
opening Task List, 55

## Switches

for command lines in CONFIG.SYS, 583 – 599  
for controlling use of expanded memory, 430  
for starting Windows, 428 – 429

## Switching among windows, 54, 65

## System diskettes, making, 139

## System file attribute, 135

System messages. *See* MessagesSystem resources. *See* Optimizing Windows

## System settings

and network compatibility, 548  
changing, 560

## SYSTEM.INI file

MaxPagingFileSize setting, 528  
MinUserDiskSpace setting, 528  
PagingDrive setting, 528  
Swapdisk setting, 529

**T**

---

Table Format option, in Terminal, 343

## Tabs

decimal, 250  
deleting, 251  
preset, 249  
removing with the Ruler, 251  
searching for, 229  
setting with the Ruler, 251  
setting your own, 249 – 250

## Tabs command, in Write

deleting tabs, 251  
setting tabs, 250

## Tabs dialog box, 250

## Task List

rearranging icons, 56  
rearranging windows, 55  
switching among windows, 54  
terminating a non-Windows application, 489

Tasking options, for non-Windows applications, 477

Telecommunications. *See* Terminal

## TEMP environment variable

setting to a RAM disk, 519, 538  
specifying, 538

## Temporary files, application

deleting to free up disk space, 509  
specifying the directory for, 538

## Terminal

assigning function keys, 330  
Binary Transfers dialog box, 339  
Communications dialog box, 326  
communications session, described, 318  
connecting to a remote computer, 334  
displaying function keys, 333  
editing text  
clearing the window and buffer, 348  
copying to the Clipboard, 346  
pasting to the remote system, 347  
selecting all text, 347  
sending selected text, 347  
ending a Terminal session  
disconnecting from the remote computer, 350  
saving Settings files, 350  
Function Keys dialog box, 330 – 331  
hardware requirements, 317  
Phone Number dialog box, 321, 334  
preparing a Terminal session  
assigning function keys, 330 – 332  
choosing modem commands, 328  
choosing options for binary transfers, 338 – 339  
choosing options for text transfers, 336 – 338  
choosing terminal emulation type, 322

Terminal (*continued*)

- preparing a Terminal session (*continued*)
    - choosing terminal preferences, 323 – 326
    - entering a phone number, 320 – 322
    - opening settings files, 320
    - setting the timer, 334
    - specifying communications settings, 326 – 328
    - turning on print mode, 349
  - printing
    - selected text, 349
    - setting up a printer, 348
    - starting print mode, 349
  - problems with
    - binary transfers fail, 353
    - modem dials but cannot connect, 352
    - modem fails to dial, 351
    - operator interrupts call, 351
    - text fails to print, 353
    - text transfers fail, 352
  - quitting, 351
  - Receive Binary Files dialog box, 345
  - Receive Text File dialog box, 341
  - Send Text File dialog box, 340
  - starting, 319
  - Terminal Emulation dialog box, 322
  - Terminal Preferences dialog box, 323
  - Text Transfers dialog box, 336
  - transferring binary files
    - receiving, 345 – 346
    - sending, 344
  - transferring files, described, 335
  - transferring text files
    - receiving, 341 – 343
    - sending, 340 – 341
    - viewing, 343 – 344
  - View Text File dialog box, 343
- Terminal emulation
- described, 322
  - tables
    - described, 573
    - for VT 100 terminals, 576 – 581
    - for VT 52 terminals, 573 – 575
- Terminal Emulation command, 322
- Terminal Font option, in Terminal, 324
- Terminal Preferences command, 323
- Terminate option, with 386 enhanced mode, 478
- Text
- breaking into pages
    - automatic page breaks, 234 – 235
    - confirming page breaks, 236
    - manual page breaks, 235 – 236
  - deleting, 69
  - editing after selecting, 69

Text (*continued*)

- editing in Terminal, 346 – 348
  - editing in Write, 224 – 226
  - entering in a Paintbrush drawing
    - aligning accurately, 304
    - choosing character styles, 276 – 277
  - entering in a Paintbrush drawing
    - choosing fonts, 275 – 276
    - described, 274
  - entering in Cardfile, 387 – 388
  - entering in Write documents, 224
  - entering, basic techniques, 66
  - finding and changing, in Write, 229 – 231
  - finding in Cardfile, 390 – 391
  - finding in Notepad, 401 – 402
  - formatting
    - character styles, 237
    - documents. *See* Write
  - inserting, 67
  - printing. *See* Printing
  - replacing, 69
  - searching techniques, in Write, 228
  - selecting
    - described, 67
    - in Notepad, 401
    - in text boxes, 36
    - in Write, 226 – 227
    - options for, 68
    - with the Mark command, 57
  - typing, 224
- Text boxes, described, 36
- Text command, in Cardfile, 393
- Text editor. *See* Notepad
- Text files
- defined, 335
  - printing with File Manager, 134
- Text mode, for applications, 453, 470 – 471
- Text tool, in Paintbrush, 274
- Text Transfers command, in Terminal, 336
- Text Transfers dialog box, 336
- Tile command
- rearranging application windows, 55
  - rearranging document windows, 66
  - rearranging File Manager windows, 114, 120
  - rearranging group windows, 84, 86
  - rearranging icons, 55
- Tilt command, in Paintbrush, 303
- Time
- adding to a Notepad file, 404
  - changing the format of, 183 – 184
  - changing the system time, 189
  - displaying with Clock, 398 – 399
  - logging with Notepad, 403 – 404

Time (*continued*)

- setting alarms in Calendar, 375 – 377
- timing Terminal sessions, 334
- Time Format dialog box, 184
- Time Slice option, in Control Panel, 192
- Time/Date command, in Notepad, 404
- Time/Date Sent command, in Print Manager, 205
- Timeout If Not Connected in 30 Seconds option in Terminal, 321
- Timeout options, described, 171
- Timer Mode command, in Terminal, 334
- Title bars, described, 22
- Today command, in Calendar, 373
- Toolbox
  - Airbrush tool, 281
  - Box Tool, 291 – 292
  - Brush tool, 286 – 287
  - Color Eraser tool, 282 – 283
  - Curve tool, 288 – 289
  - described, 264
  - Eraser tool, 284 – 285
  - Filled Box tool, 291 – 292
  - Line tool, 290 – 291
  - Paint Roller tool, 285 – 286
  - Pick cutout tool, 280
  - removing from Paintbrush window, 267
  - Scissors cutout tool, 279
  - selecting a drawing tool, 272
  - Text tool, 274
- Tools and Linesize command, in Paintbrush, 267
- Transferring data. *See* Data transfer
- Transferring files. *See* File transfers
- Translation option, in Terminal, 325
- Transmission Retry timeout option, 171 – 172
- Trigonometric functions
  - using with Calculator, 368 – 369
- Troubleshooting
  - application problems, 482 – 489, 551
  - modems. *See* Modems
  - network problems. *See* Networks
  - printing problems. *See* Printing; problems with running Setup to reinstall Windows, 565
- TSR programs. *See* Memory-resident software
- Type option, in File Manager, 117
- Typographic conventions, described, xxii

---

**U**

## Underlining

- in a Paintbrush drawing, 276
  - in Write documents, 237
- Undo command, on Edit menus
    - canceling changes to a drawing, 305
    - deleting portions of a drawing, 272
    - described, 69
  - Undoing previous edit operations, 69
  - Units option, in Paintbrush, 266
  - Update Net Queues command, in Print Manager, 208
  - Updating directory windows, 121
  - Upgrades for Windows, xi
  - Use Printer Resolution option, in Paintbrush, 310
  - Uses High Memory Area option, in PIF Editor, 468
  - Using Help command, in Help menu, 72
- 
- V**

- Vertical lines, drawing perfectly straight, 291
- Video Memory options, in PIF Editor, 470
- Video Mode options, in PIF Editor, 452
- View Other dialog box, in File Manager, 115
- View Picture command, in Paintbrush, 268
- View Text File command, in Terminal, 343
- View Text File dialog box, 343
- Volume labels
  - assigning or changing, 141
  - described, 103
- VT 100 terminals
  - escape sequences for supported functions, 578 – 581
  - IBM PC equivalent keystrokes, 576
- VT 52 terminals
  - escape sequences for supported functions, 575
  - IBM PC equivalent keystrokes, 573

---

**W**

## Wallpaper

- choosing a bitmap for, 155
  - creating, 155
  - described, 155
  - freeing up disk space by deleting, 510
  - freeing up memory by removing, 156
- Warning beep, turning on or off, 190
  - Warning messages. *See* Messages
  - Weitek Coprocessor, 597
  - Whole option, in Paintbrush, 310
  - Width option, in Paintbrush, 266
  - Wildcard characters
    - for specifying groups of files, 119, 123, 128
    - searching for, 229
  - WIN386.SWP file, 509, 526
  - Window title
    - described, 22
    - specifying for a non-Windows application, 451, 459
  - Window Title option, in PIF Editor, 451, 459

- Windowed option
  - in PIF Editor, 461
  - of the Settings command, 477
- Windows (program)
  - See also* Standard mode, 386 enhanced mode, Real mode
  - adding applications with Setup, 562
  - command line
    - described, 427
    - samples of, 431
  - described, xi, xiii – xvi
  - Help. *See* On-line Help
  - installing, 7 – 8
  - installing on a network, 553
  - installing shared copy from a network, 545
  - MS-DOS commands to avoid running, 54
  - network features, 547
  - new features, xvii – xviii
  - optimizing. *See* Optimizing Windows
  - quitting, 10, 98
  - registering, xi
  - requirements for running, x
  - running Setup to change system settings, 559
  - starting
    - general information for, 8
    - in 386 enhanced mode, 429
    - in real mode, 428
    - in standard mode, 429
    - options for, described, 427
  - structure of, described, 17
  - technical support for, xi
  - upgrades for, xi
  - using memory-resident software with, 443
- Windows (screen elements)
  - cascading, 84
  - changing border width, 157
  - changing size of, 32, 42
  - closing, 32, 48
  - common parts of, 21
  - defined, xxv
  - Directory Tree, 101
  - directory. *See* Directory windows
  - document. *See* Document windows
  - enlarging, 32, 45
  - for applications, 19
  - group. *See* Group windows
  - inactive. *See* Inactive windows
  - lining up on desktop, 157
  - minimum size of, 42
  - moving, 32, 41
  - opening, 82
  - rearranging with Task List, 55
  - restoring
    - from icons, 46
    - to previous size, 32, 46
  - scrolling through text, 47
  - shrinking to icons, 32, 44
  - switching among, 54, 65
  - tiling, 84
- Windows applications
  - See also* Applications
  - affected by printing speed, 203
  - copying an entire screen, 58
  - copying information from, 57
  - cutting information from, 57
  - defined, xxv
  - described, 49
  - group in Program Manager, described, 80
  - notification of new products, xi
  - pasting to, 59
  - printing with, 174, 197 – 211
  - quitting, 63
  - running older versions, 438
  - switching among, 54
  - transferring data between, 56
- Windows in Background option, in Control Panel, 193
- Windows in Foreground option, in Control Panel, 193
- WINSTART.BAT file, 519
- Word breaks, optional, 231
- Word processing. *See* Write
- Word wrap
  - absence in Paintbrush, 277
  - for text transfers in Terminal, 338
  - in Notepad documents, 400
  - in Write documents, 224
  - Terminal Line Wrap option, 323
- Word Wrap command, in Notepad, 400
- Word Wrap Outgoing Text at Column option
  - in Terminal, 338
- Workspace, described, 22
- Workstation, diskless, 545
- Write
  - breaking documents into pages
    - automatic page breaks, 234 – 235
    - confirming page breaks, 236
    - manual page breaks, 235 – 236
  - Change dialog box, 230
  - character formats
    - choosing, 238
    - displaying, 237
    - displaying fonts, 239
    - saving, 237
    - superscript and subscript, 238
    - using fonts, 239 – 240

**Write (continued)**

- editing documents
  - changing text, 229 – 231
  - finding special characters, 229
  - finding text, 228
  - inserting optional hyphens, 232
  - moving to specific pages, 225 – 226
  - selecting text, 226 – 227
  - using cursor movement keys, 224 – 225
  - using scroll bars, 224
- editing pictures
  - changing picture size, 233
  - moving pictures, 232 – 233
- entering text, 224
- Find dialog box, 228
- Fonts dialog box, 240
- formatting documents, 237 – 252
- Go To dialog box, 226
- Indents dialog box, 244
- managing files
  - backing up, 255
  - opening non-Windows text files, 254
  - opening non-Write documents, 253
  - opening Windows text files, 253
  - saving documents, 254
- Page Layout dialog box, 252
- paragraph formats
  - aligning paragraphs, 243
  - changing indentation, 244 – 246
  - changing line spacing, 244
  - creating with the Ruler, 241 – 244
  - described, 240
  - using paragraph marks, 242
- Print dialog box, 256
- printing documents
  - changing page layout settings, 256
  - changing printers, 257
  - print options, 255 – 256
- Repaginate Document dialog box, 234
- Repaginating Document dialog box, 236
- starting, 223
- Tabs dialog box, 250
- whole document formats
  - changing page layout, 252
  - described, 246
  - setting tabs, 249 – 251
  - using headers and footers, 247 – 249
- Write dialog box, 253 – 254
- Write window, described, 223 – 224

---

**X**

---

- XModem/CRC option, in Terminal, 339
- XMS memory. *See* Extended memory
- XMS Memory options, in PIF Editor
  - for 386 enhanced mode, 467 – 468
  - for standard mode, 454

---

**Z**

---

- Zoom In command, in Paintbrush
  - canceling Zoom Out, 269
  - editing a drawing, 305
  - fixing color leaks, 286
- Zoom Out command, in Paintbrush
  - canceling Zoom In, 305
  - displaying an entire drawing, 268

# MICROSOFT PRODUCT ASSISTANCE REQUEST

Microsoft Product Support Services - Phone (206) 454-2030

*Windows hot line - 206 637-7898*

---

## Instructions

When you need assistance with a Microsoft product, call our Product Support Services group at (206) 454-2030. So that we can answer your question as quickly as possible, please gather all information that applies to your problem. Note or print out any on-screen messages you get when the problem occurs. Have your manual and product disks close at hand and have all the information requested on this form available when you call.

## Diagnosing a Problem

So that we can assist you more effectively, please be prepared to answer the following questions regarding your problem, your software, and your hardware.

1. Can you reproduce the problem?  
 yes  no
2. Does the problem occur with another copy of the original disk of your Microsoft Software?  
 yes  no
3. Does the problem occur with another system (if available)?  
 yes  no
4. If you were running other windowing or memory-resident software at the same time, does the problem also occur when you don't use the other software?  
 yes  no

## Product

---

Product name

---

Version Number

---

Registration Number

## Software

### Operating System

---

Name/Version number

### Windowing Environment

If you were running Microsoft Windows or another windowing environment, give name and number of windowing software:

---

### CD ROM Software

---

Name/Version number

### Other Software

Name/Version number of any other software you were running when problem occurred, including memory-resident software (such as keyboard enhancers or print spoolers):

---

---

---

# Hardware

So that we can assist you more effectively, please be prepared to answer the following questions regarding your problem, your software, and your hardware.

## Computer

\_\_\_\_\_  
Manufacturer/model

\_\_\_\_\_  
Total memory

### Floppy-disk drives

Number:  1  2  Other

Size:  3 1/2"  5 1/4"

Number of Sides:  1  2

Density:  Single  Double  Quad

Capacity:

5 1/4":  160K  360K  1.2 megabytes

3 1/2":  360K  400K  720K  800K  
 1.4 megabytes

### System Memory

\_\_\_\_\_  
Manufacturer/model

\_\_\_\_\_  
Total memory

(If using DOS, you can run CHKDSK to determine the amount of memory available. If using Apple Macintosh Finder, select "About The Finder..." from the Apple menu to determine the amount of memory available.)

## Peripherals

### Hard Disk

\_\_\_\_\_  
Manufacturer/model

\_\_\_\_\_  
Capacity(megabyte)

### Printer/Plotter

\_\_\_\_\_  
Manufacturer/model

Serial  Parallel

Printer peripherals, such as font cartridges, downloadable fonts, sheet feeders:

\_\_\_\_\_  
\_\_\_\_\_

### Mouse

Microsoft Mouse:  Bus  Serial  InPort™  
 Other

\_\_\_\_\_  
Manufacturer/model

### Boards

Add-on RAM board

\_\_\_\_\_  
Manufacturer/model

Graphics-adaptor board

\_\_\_\_\_  
Manufacturer/model

Other boards installed

\_\_\_\_\_  
Manufacturer/model

### Modem

\_\_\_\_\_  
Manufacturer/model

## CD ROM Player

\_\_\_\_\_  
Manufacturer/model

Version of Microsoft MS-DOS® CD ROM Extensions:

\_\_\_\_\_

## Network

Is your system part of a network?  Yes  No

\_\_\_\_\_  
Manufacturer/model

What hardware and software does your network use?

\_\_\_\_\_  
\_\_\_\_\_  
\_\_\_\_\_

Microsoft Corporation  
One Microsoft Way  
Redmond, WA 98052-6399

**Microsoft**<sup>®</sup>  
Making it all make sense™

0989 Part No. 06851