

**The
Connection Machine
System**

CM-5 Site Preparation Guide

**Domestic
November 10, 1992**

**Thinking Machines Corporation
Cambridge, Massachusetts**

Copyright © 1992 by Thinking Machines Corporation. All rights reserved.

Thinking Machines Corporation
245 First Street
Cambridge, Massachusetts 02142-1264
(617) 234-1000/876-1111

**Site Preparation Guide
Table of Contents**

Customer Site Contact List	2
Introduction	3
Site Preparation Checklist	4
Receiving Area	4
Route to Computer Room	5
Computer Room	6
Control Processor Configuration Data	8
Miscellaneous Issues	9
Receiving Dock to Computer Room Diagrams	10
Computer Room Floor Preparation Diagrams	13
Primary Power Wiring Requirements	60

CM-5 Site Preparation Guide

Customer Site Contact List

Customer: _____

Main
Address: _____

Phone: _____

Delivery
Address: _____

Contact: _____
Phone: _____

Documentation
Address: _____

Component Delivery
Address: _____
Room: _____

Site System
Administrator: _____

Facilities
Manager: _____

Phone: _____
Modem: _____
Email: _____
Fax: _____

Phone: _____
Modem: _____
Email: _____
Fax: _____

Computer room
Phone: _____

Computer room
Phone: _____

Sales Acct
Manager: _____

Local Support
Contact: _____

Regional
Sales Phone: _____
Email: _____

Regional
Office Phone: _____
Phone: _____

Customer Support Cambridge:
1-617-234-4000 Mon—Fri, 8 am — 8 pm EST Email: Customer-Support@think.com

Introduction

Well in advance of the scheduled delivery of your CM-5 system, Thinking Machines Customer Support Group (CSG) will request an appointment to conduct a pre-installation site survey. This survey will determine your site's readiness to receive the system.

This document is intended to help you prepare for that survey. It identifies the various features of a computer facility that are likely to be involved in the delivery and installation of a CM-5 system. These are the same topics that will be examined during the CSG survey.

We recommend that you conduct your own site survey before the CSG visit, using this document as a guide. This will prepare you to participate more fully in the CSG survey and help you evaluate more critically any modifications to the site that may be called for. It is organized into five sections, each covering a different aspect of installation planning. These sections include:

- **Site preparation check list** — This is a detailed list of issues that can influence the efficient receipt and installation of your CM-5. Because the CM-5 feels at home in virtually any conventional mainframe/supercomputer room setting, few, if any, of the checklist topics are likely to need special attention.
- **Site planning diagrams** — This section contains a set of drawings that illustrate key points in the checklist. In particular, they show how to evaluate the route from the receiving area to the computer room.
- **Physical characteristics tables** — These tables summarize the chief physical specifications of the CM-5, including its dimensions, weight, power source requirements, power dissipation (cooling requirements), and environmental specifications.
- **Raised floor preparations** — This section shows how a computer room's raised floor must be prepared for receiving a CM-5 system. It contains four sets of tile diagrams.
 - The first set provides detailed dimension information for the basic cabinet frame.
 - The second set illustrates the footprints of all possible CM-5 system configurations, from a single device cabinet up to eight device cabinets and two network cabinets. These drawings provide a system-level view of the tile cutouts needed for supplying cooling air to the cabinets and for power cable access.
 - The third set provides detailed measurements for the tile cutouts.
 - The fourth set shows the location of the cabinet leveller feet in relation to the floor tiles; these are the points at which the floor may need to be reinforced with tile support pedestals.
- **Primary power wiring instructions** — This section describes the wiring requirements of the branch circuit needed to deliver primary power to the CM-5 system. It will be of particular interest to the professional electrician who will install the circuit.

Site Preparation Checklist

As you analyze your computer facility, use the following checklist as a guide to be certain important points are not overlooked and as a means for recording information about the facility for later discussion with the CSG survey team.

Receiving Area

___ What are normal receiving times?

hours _____

days of week _____

___ Are there any special constraints that could affect delivery timing? For example, are there sports arenas, convention centers, or other facilities in the vicinity that might generate heavy traffic conditions?

___ If after-hours delivery becomes necessary, please identify a contact for making special delivery arrangements.

Contact name: _____

Address: _____

Phone: _____

___ Identify the delivery route(s) and any restrictions affecting access to the receiving area. For example, does the approach to the receiving area involve:

a one-way street?

low overhead clearance (e.g., overpass)?

narrow passageway (e.g., through an alley)?

an area that may have variable obstacles (e.g., through a parking lot)?

___ The receiving area must accommodate a tractor-trailer unit 60+ feet long. The driver must have a clear path for backing the trailer to the receiving area and must be able to leave it parked for at least 5 hours.

CM-5 Site Preparation Guide

Site Preparation Checklist

(continued)

Receiving Area (continued)

___ Is there a receiving dock? If so, the following characteristics are important to know.

___ Dimensions (height_____, width_____, depth_____)?

___ Does it have a load capacity of at least 4500 pounds?

___ Does it have a dock leveler?

___ Does it have a dock plate?

___ If ground delivery is required, the surface of the receiving area must be smooth and hard enough for caster wheels to roll easily. If the surface is gravel, for example, plywood sheets may be needed to provide a smooth path to the building entrance.

___ Will a ramp be needed to move the CM from the receiving area into the building? If so, verify that it has a rise-to-run ratio of less than 1:6 (e.g., less than 2 inches per foot). The ramp must also have a load capacity of at least 4,500 pounds.

___ The horizontal and vertical clearances needed in the doorway may vary, depending on how it is approached. The following factors, for example, can influence how wide and/or how tall the doorway must be.

___ If a ramp is used and leads directly to the building entrance, more vertical clearance will be needed to allow for the cabinet's greater height when on a slope. Figure 1 illustrates this vertical clearance requirement for a CM-5 in its shipping configuration.

___ If the building entrance is approached from the side (e.g., via a ramp up to a landing), the landing area must provide a sufficient turning radius. See Figure 3.

___ If the CM cannot be moved to its final destination (i.e., computer room) immediately, check for a suitable temporary storage area. This area should be large enough to accommodate all of the containers shipped with your system. As a rule of thumb, a CM-5 system with three CM-5 cabinets and one DataVault fills a single 10-foot by 30-foot tractor trailer. This area must also be protected from dampness and high temperatures.

Route to Computer Room

___ Evaluate the route from the receiving area to the computer room.

___ Note any obstacles in the path the equipment will follow. Are they fixed in place or movable?

___ Do all doorways have sufficient horizontal or vertical clearance? The critical dimensions for moving cabinets in shipping crates and on caster brackets are shown in Figure 2.

___ Verify that floor surfaces along route are smooth enough for rolling cabinets.

Site Preparation Checklist

(continued)

Route to Computer Room (continued)

- Verify that all floor surfaces can support the weight of the heaviest cabinet distributed among four wheels.
 - If the route requires turning corners, verify that the passageway provides a sufficient turning radius at each corner. See Figure 4.
 - If the route includes any inclines or steps that require ramps, verify that the gradient does not exceed 2 inches per foot. Any ramps must have a load capacity of at least 4500 pounds.
 - If the route requires movement by elevator, verify that the elevator meets the following requirements:
 - Its doorway must have sufficient horizontal and vertical clearance.
 - Its interior dimensions must accommodate a cabinet and at least one passenger. If the elevator is not deep enough for the cabinet to be loaded straight into the elevator, verify that it is wide enough for the cabinet to be installed at an angle. See Figure 5.

NOTE: When determining an elevator's interior dimensions, take into account any fixed railings or other objects that might reduce usable space. Also keep in mind the need for access to the control panel.
 - Its load capacity must be at least 3300 pounds.
 - It must hold stable (not sink) when it first receives a heavy load.
 - It must stop level with the floors.
 - It must provide smooth acceleration/deceleration when loaded.
 - When was it last inspected? Date: _____
- NOTE:** If the elevator routinely carries heavy loads (close to its rated capacity), it is important that the last inspection be recent to verify its current safety.

Computer Room

- Verify that the computer room has sufficient space. Refer to Figure 6 through Figure 16 for details of floor space requirements.

NOTE: As you evaluate computer room floor space, keep in mind that, once the CM-5 cabinets are in place, the installers will need a clear path for removing equipment used in the installation. For installations of multiple CM-5 cabinets, the largest installation equipment to be removed is the mobile staging unit, which measures 89 inches x 38 inches x 59 inches (W x D x H). For single-cabinet installations, the largest objects to be removed are the crate panels. Refer to Table for crate panel dimensions.

Site Preparation Checklist

(continued)

Computer Room (continued)

- ___ Will the system be expanded? If expansion is planned, evaluate the location of the initial installation for its ability to accommodate the additional equipment. It is strongly recommended that the CM's initial location allow for any expected expansion to minimize the need for modifying and recabling the original CM configuration.
- ___ Check the location and capacity of the room's air cooling facility. Refer to Tables 3, 4, and 5.
- ___ Verify that the computer room floor is raised at least 12 inches. See Figure 17.
- ___ Verify that pressurized chilled air can reach the area of the floor that will be under the CM cabinets (i.e., that no cables, duct work or other obstructions impede air flow between the chilled air source and the CM). Refer to Table 5 for environmental details.
- ___ Check area of the floor that will be under the CM cabinets for the following:
 - ___ Note tile dimensions. Diagrams in this guide assume 2-foot x 2-foot tiles.
 - ___ Verify that air and cable access holes can be cut in the floor tiles.
 - ___ Verify that raised floor support structure (i.e., joists) will support the CM.
 - ___ Verify that a sufficient supply of support pedestals is available for use as auxiliary supports under the leveler feet and where floor tiles are weakened by cutouts.
- ___ Verify that a separate 208 V, 100 A, 5-wire supply and circuit breaker are provided for each device cabinet. Refer to Table 3 for CM power specification details.
- ___ Verify that a separate 208 V, 60 A, 5-wire supply and circuit breaker are provided for each network cabinet. Refer to Table 3 for CM power specification details.
- ___ Verify that power sources with the appropriate characteristics are available for any DataVault, CM-HIPPI, CM-IOPG, CM-TUD, and/or external Control Processor cabinets the system may include. Refer to Table 3 for these power specification details.
- ___ Is each primary power circuit equipped with UPS or power conditioning units?
- ___ Check for availability and location of emergency power cutoff switches for the branch circuits that power the CM and peripheral devices. They must be visible and easily accessible. The last section of this guide, Primary Power Wiring Requirements, provides detailed instructions for connecting CM-5 equipment to its primary power branch circuit.
- ___ Check for availability of a lockable storage facility for storing spare parts and tools.
- ___ Verify that telephone service is available close to the CM to allow convenient consultation with Thinking Machines Corporation during troubleshooting.

Site Preparation Checklist

(continued)

Control Processor Configuration Data

The installation process can be expedited by planning ahead for the Control Processors that will be installed with the CM-5 system. If you pre-allocate network addresses for all Control Processors you expect to have installed, Thinking Machines personnel will build the installation software package with these addresses included, thereby eliminating a step in the software installation process.

The following list identifies the different types of Control Processors that are available with the CM-5 system. Use this list to guide you with the Control Processor configuration portion of the checklist.

- CP-1 _____
- CP-2 _____
- IOCP _____
- S-1 _____
- DS-1 _____

___ How many Sun computer systems will be installed as part of the CM-5 system? This information should be available in your CM-5 purchase order and/or contract.

___ Enter the number of each type that you expect to have installed.

___ If possible, allocate network addresses for each Control Processor. Use the form below to record them. Keep this list of network addresses available to give to the CSG survey team when they visit. As part of the survey process, they will create a diagram showing how the various Control Processors will be incorporated into the system and will annotate the diagram with these addresses.

:	_____	_____	_____	_____
:	_____	_____	_____	_____
:	_____	_____	_____	_____
:	_____	_____	_____	_____
:	_____	_____	_____	_____
:	_____	_____	_____	_____
:	_____	_____	_____	_____
:	_____	_____	_____	_____

___ If your site is running NIS, what is the domain name? _____

___ If your site already has an Ethernet network, identify its type: thin _____, thick _____

Site Preparation Checklist

(continued)

Miscellaneous Issues

- Does the facility provide space for temporary storage of empty shipping crates?
- Are trash containers available for disposable packing materials?
- Are there any special site access requirements? For example, will installation personnel require escorts? Can installation personnel remain on site overnight? Must all installers be U.S. citizens?
- Can Federal Express shipments be made to the site? If not, are other overnight delivery services available?
- Does the facility have special access restrictions beyond the initial installation period?

CM-5 Site Preparation Guide

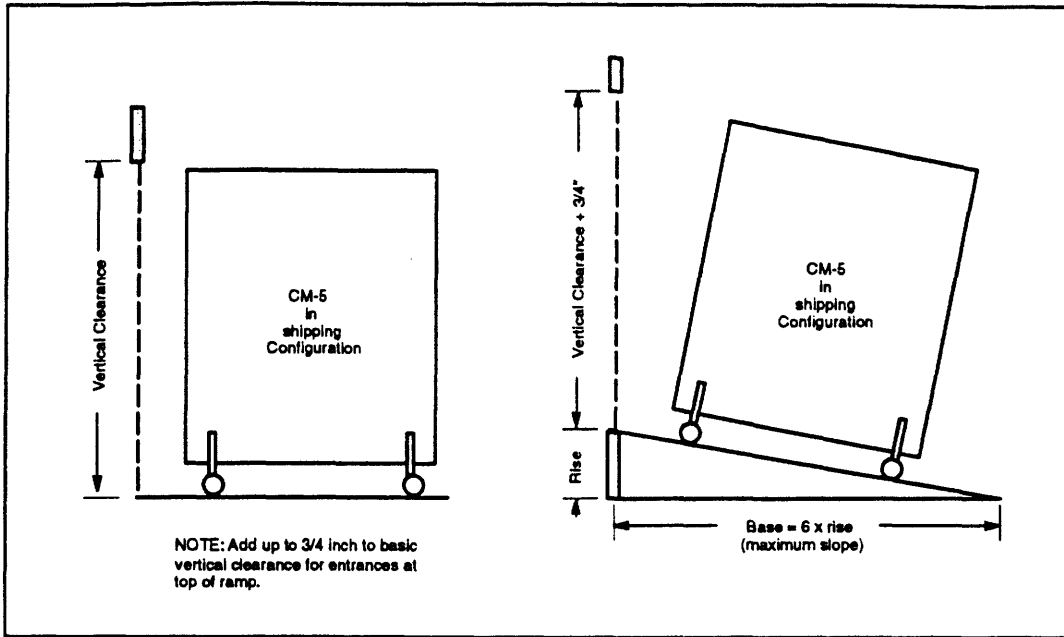

Figure 1. Ramp incline specifications for CM-5 in shipping configuration.

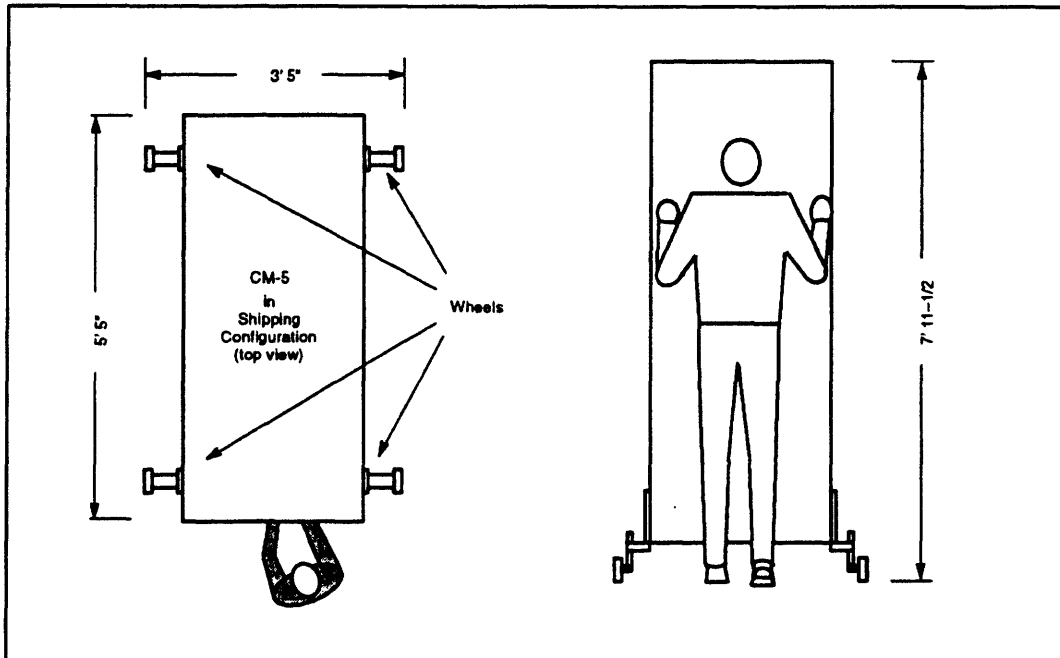

Figure 2. Footprints of CM-5 in shipping configuration.
(drawing is not to scale)

CM-5 Site Preparation Guide

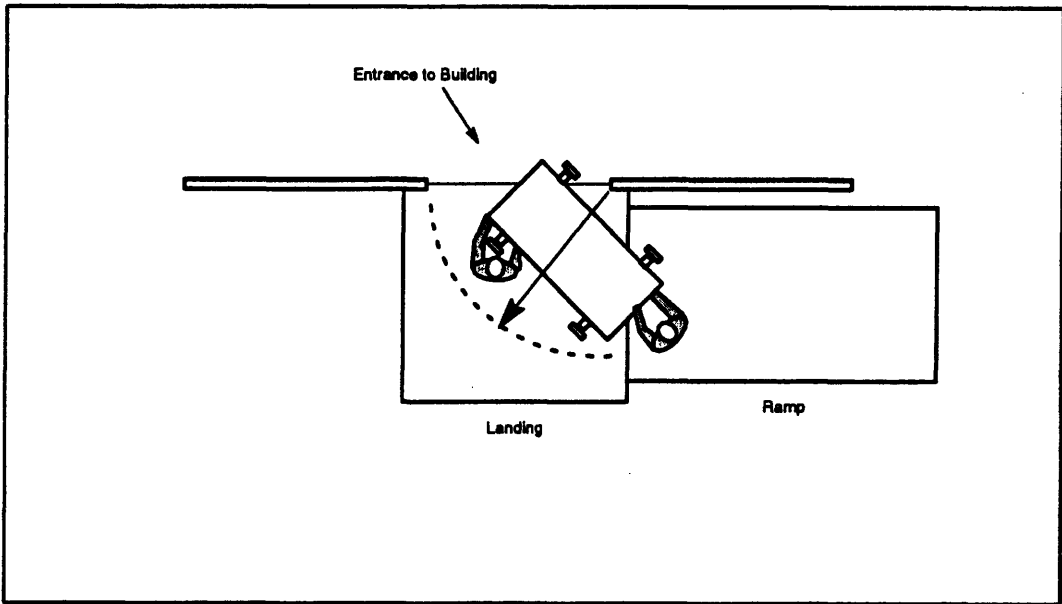

Figure 3. CM-5 turning radius requirement.
(drawing is not to scale)

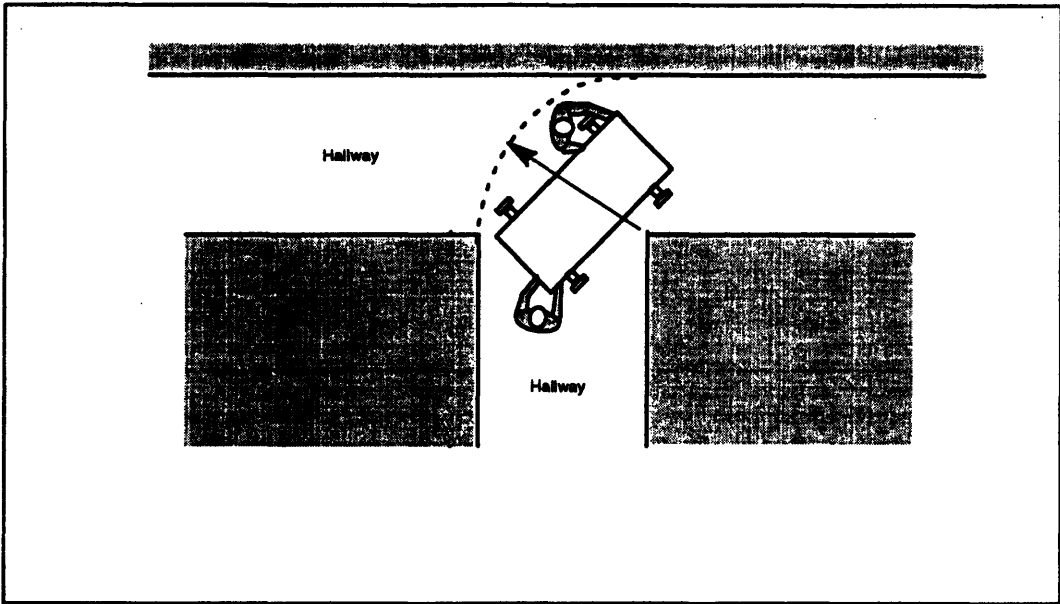

Figure 4. CM-5 passageway clearance requirement.
(drawing is not to scale)

CM-5 Site Preparation Guide

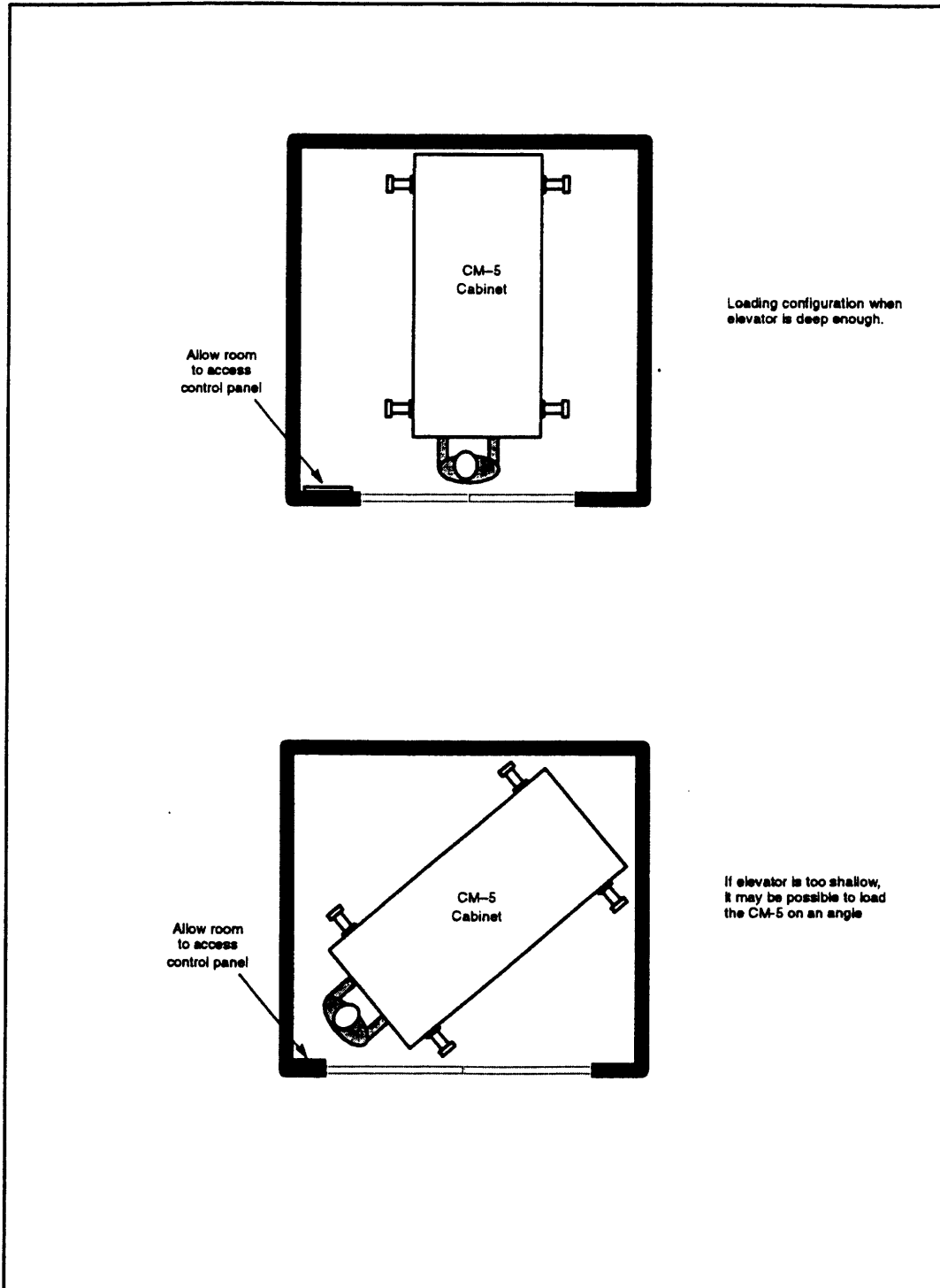

Figure 5. Conveying CM-5 via elevator in shipping crate.

CM-5 Site Preparation Guide

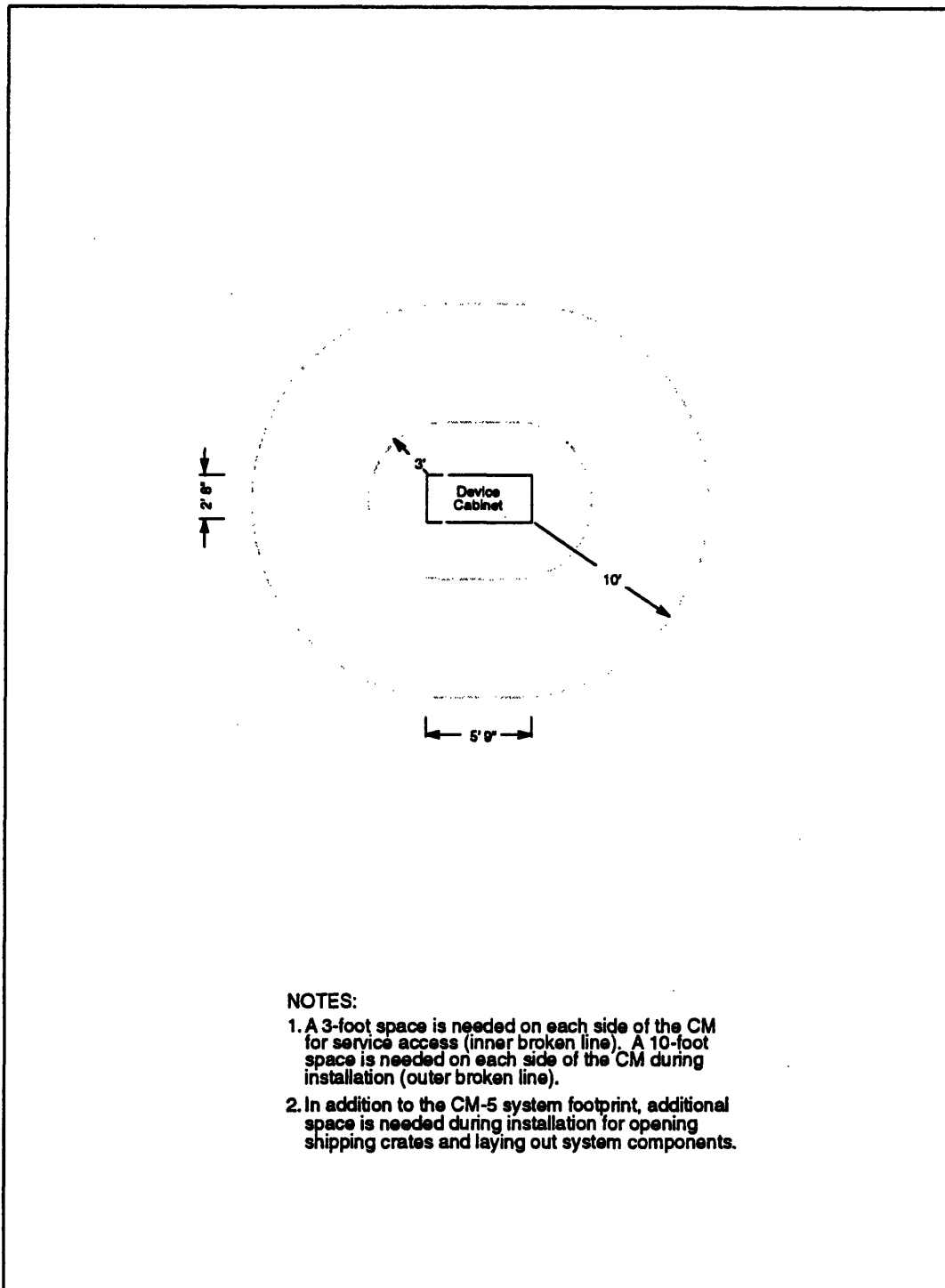

Figure 6. Minimum space requirement for one CM-5 cabinet
(drawing is not to scale)

CM-5 Site Preparation Guide

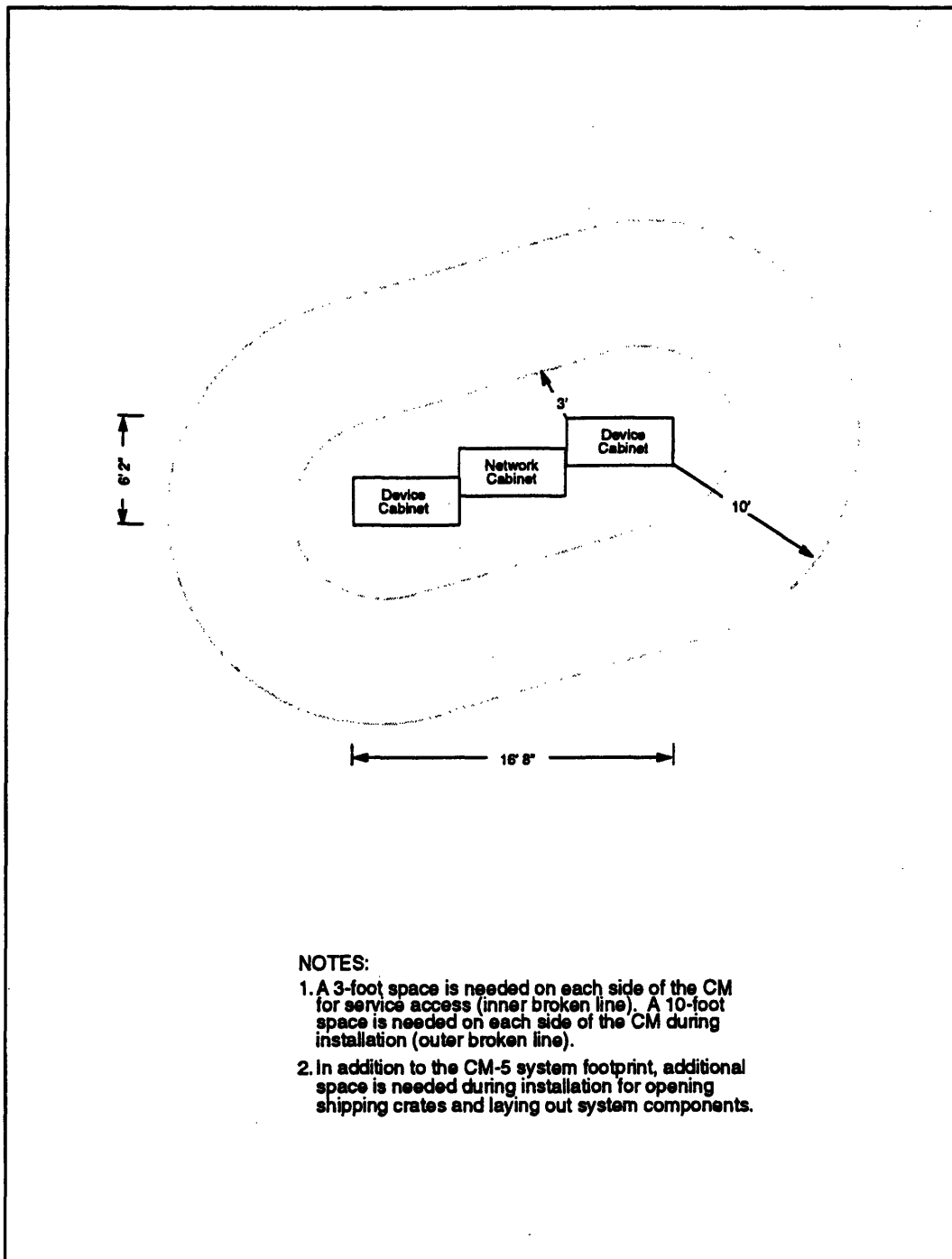

Figure 7. Overall footprint and access requirements for three CM-5 cabinets
(drawing is not to scale)

CM-5 Site Preparation Guide

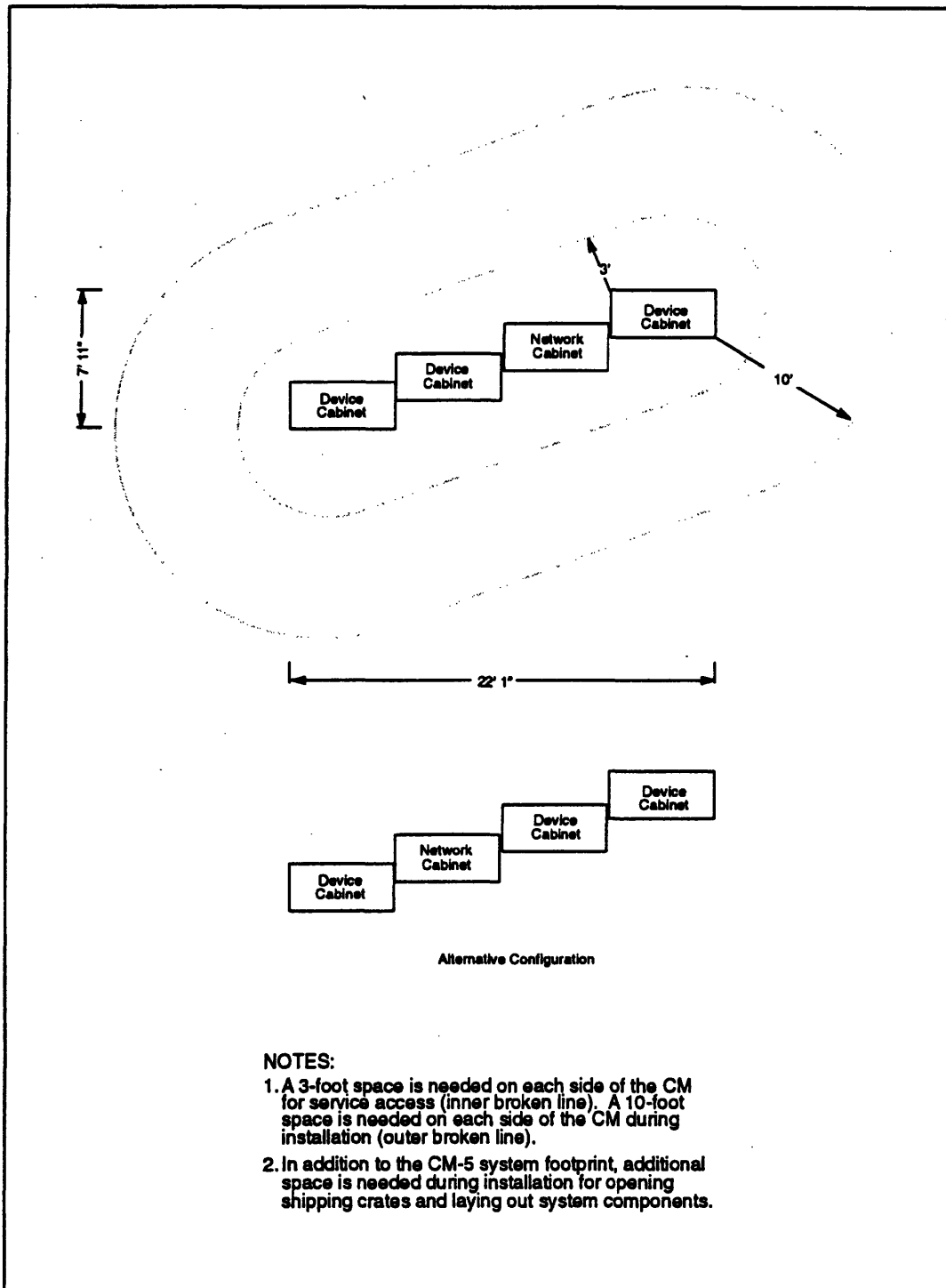

Figure 8. Overall footprint and access requirements for four CM-5 cabinets
(drawing is not to scale)

CM-5 Site Preparation Guide

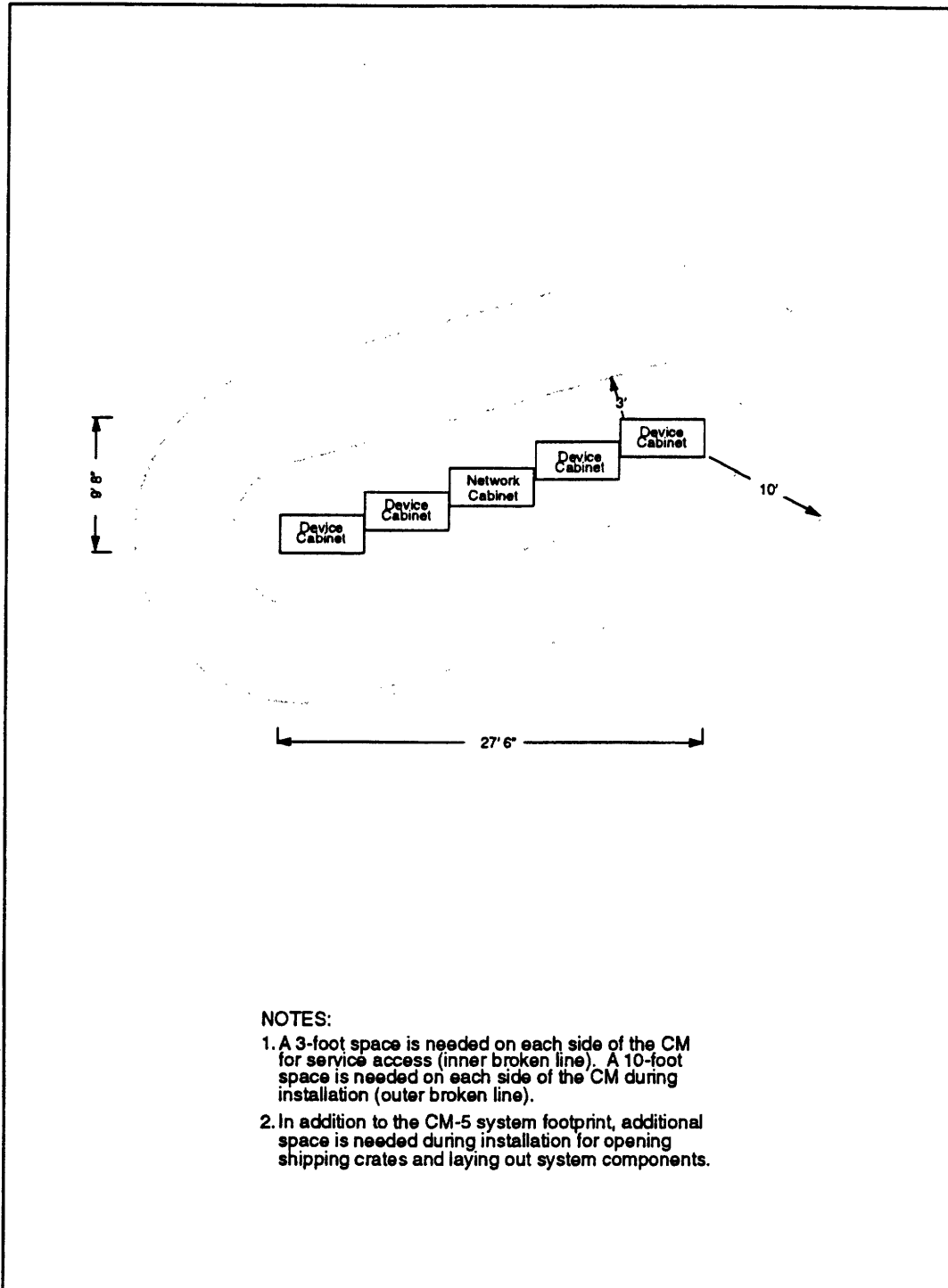

Figure 9. Overall footprint and access requirements for five CM-5 cabinets
(drawing is not to scale)

CM-5 Site Preparation Guide

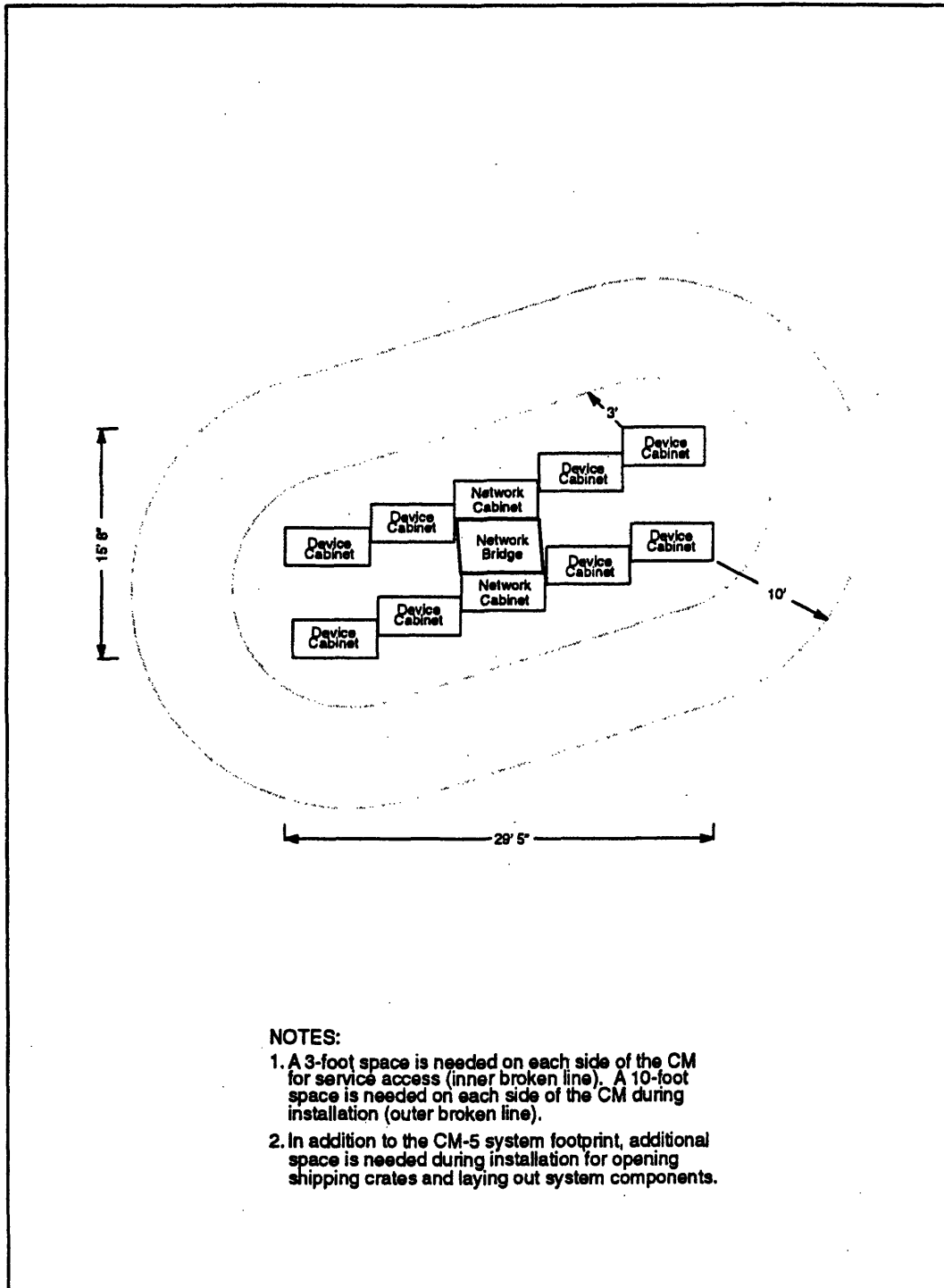

Figure 10. Overall footprint and access requirements for 10 CM-5 cabinets (drawing is not to scale)

CM-5 Site Preparation Guide

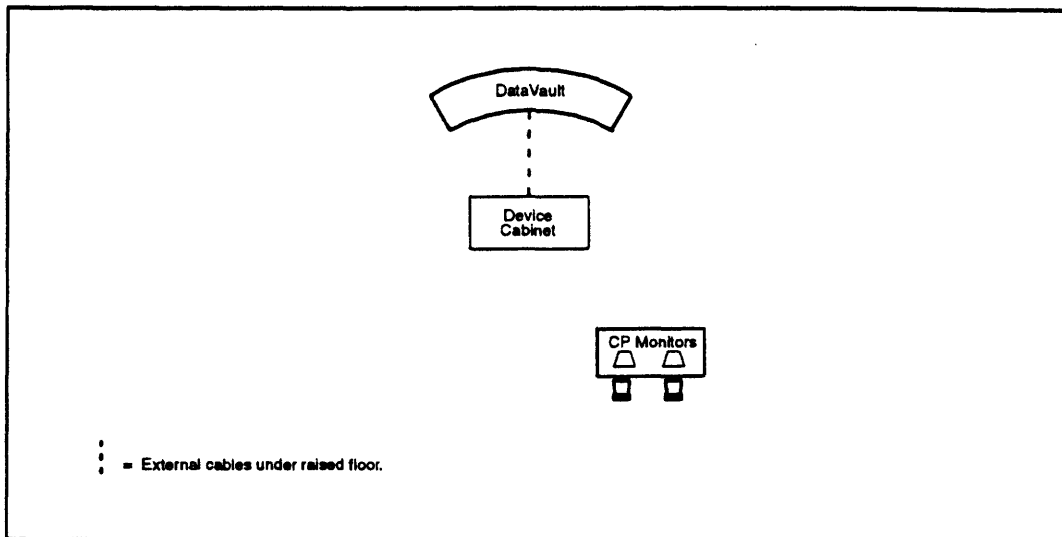

Figure 11. Example of simple CM-5 configuration with a single device cabinet, two monitors, and a DataVault (drawing is not to scale)

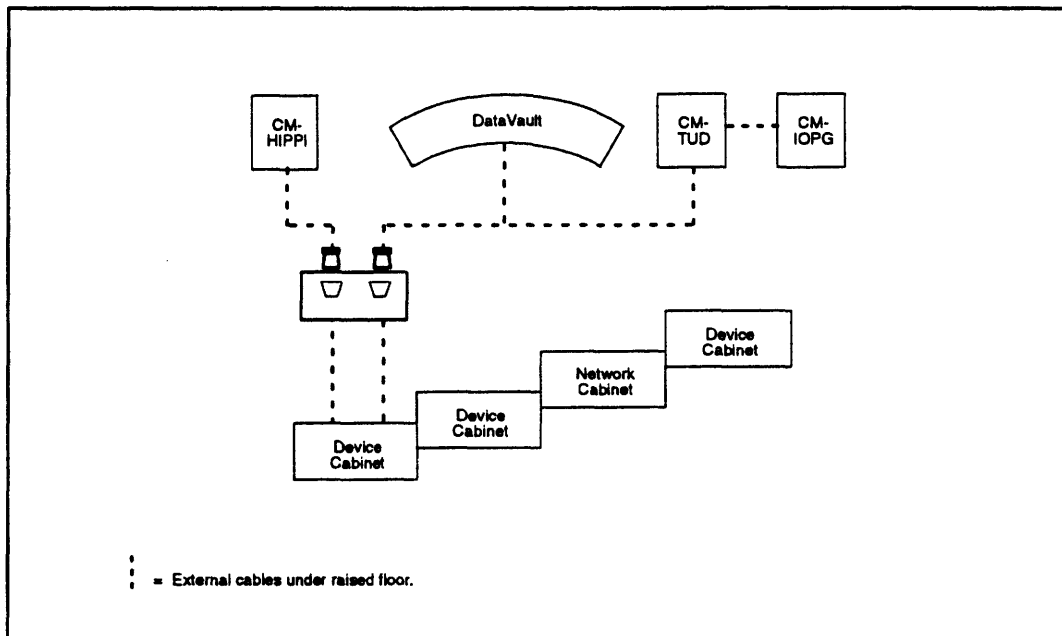

Figure 12. Example of CM-5 system layout with three device cabinets, a network cabinet, a HIPPI interface, a cartridge tape system, and a DataVault (drawing is not to scale)

CM-5 Site Preparation Guide

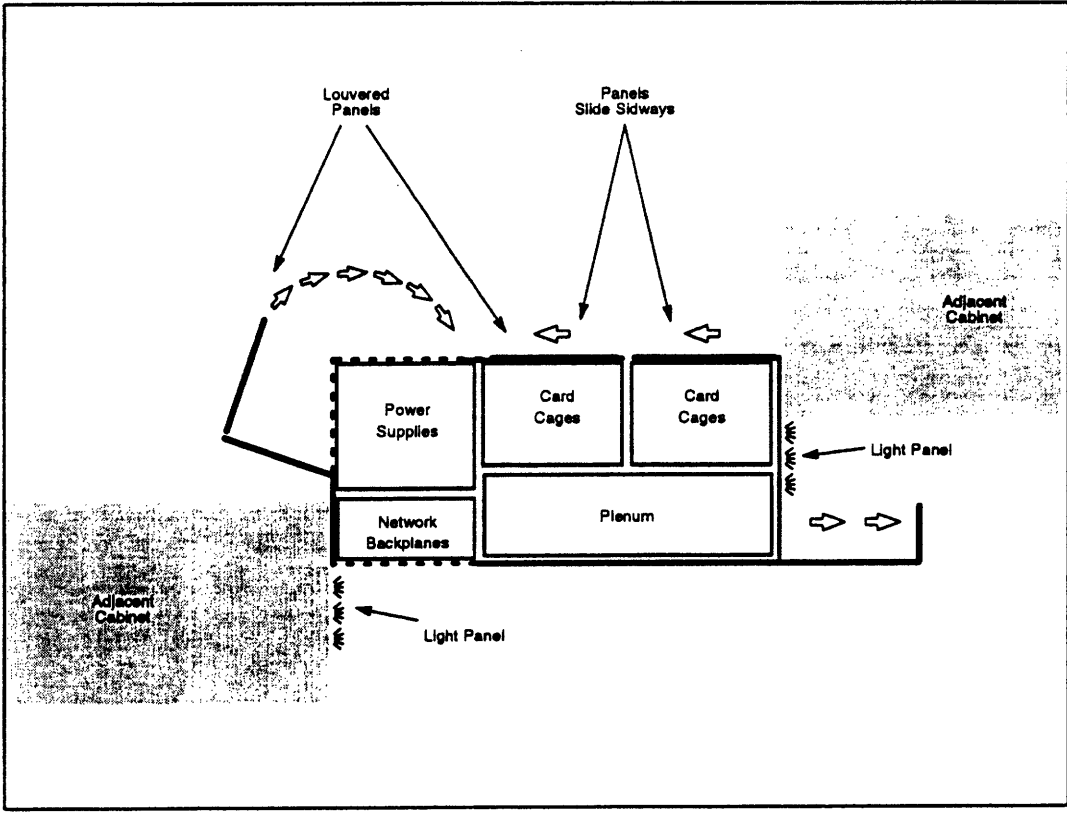

Figure 13. Typical CM-5 Device Cabinet service access details (drawing is not to scale)

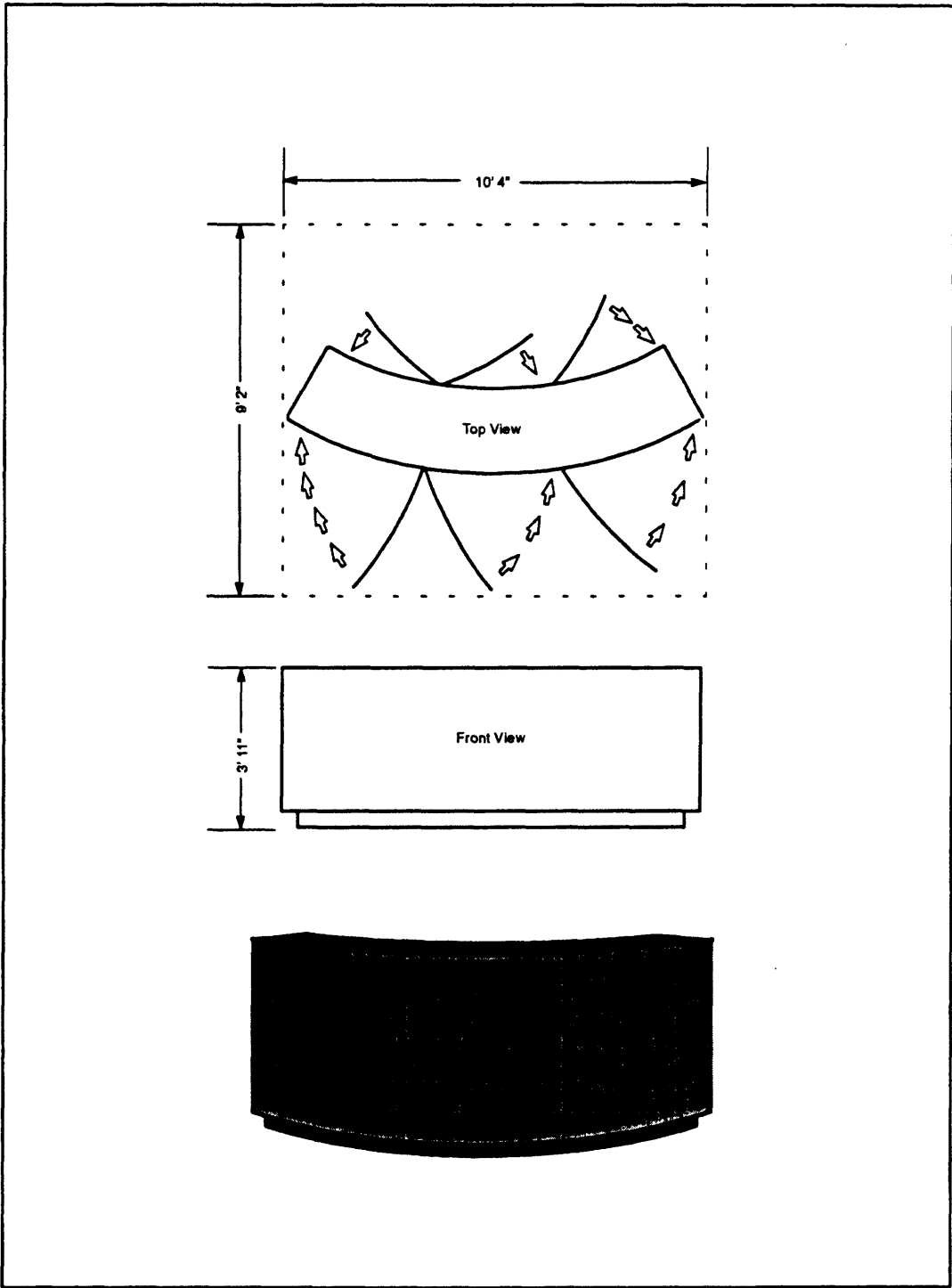

Figure 14. DataVault cabinet dimensions and access requirements (drawing is not to scale)

CM-5 Site Preparation Guide

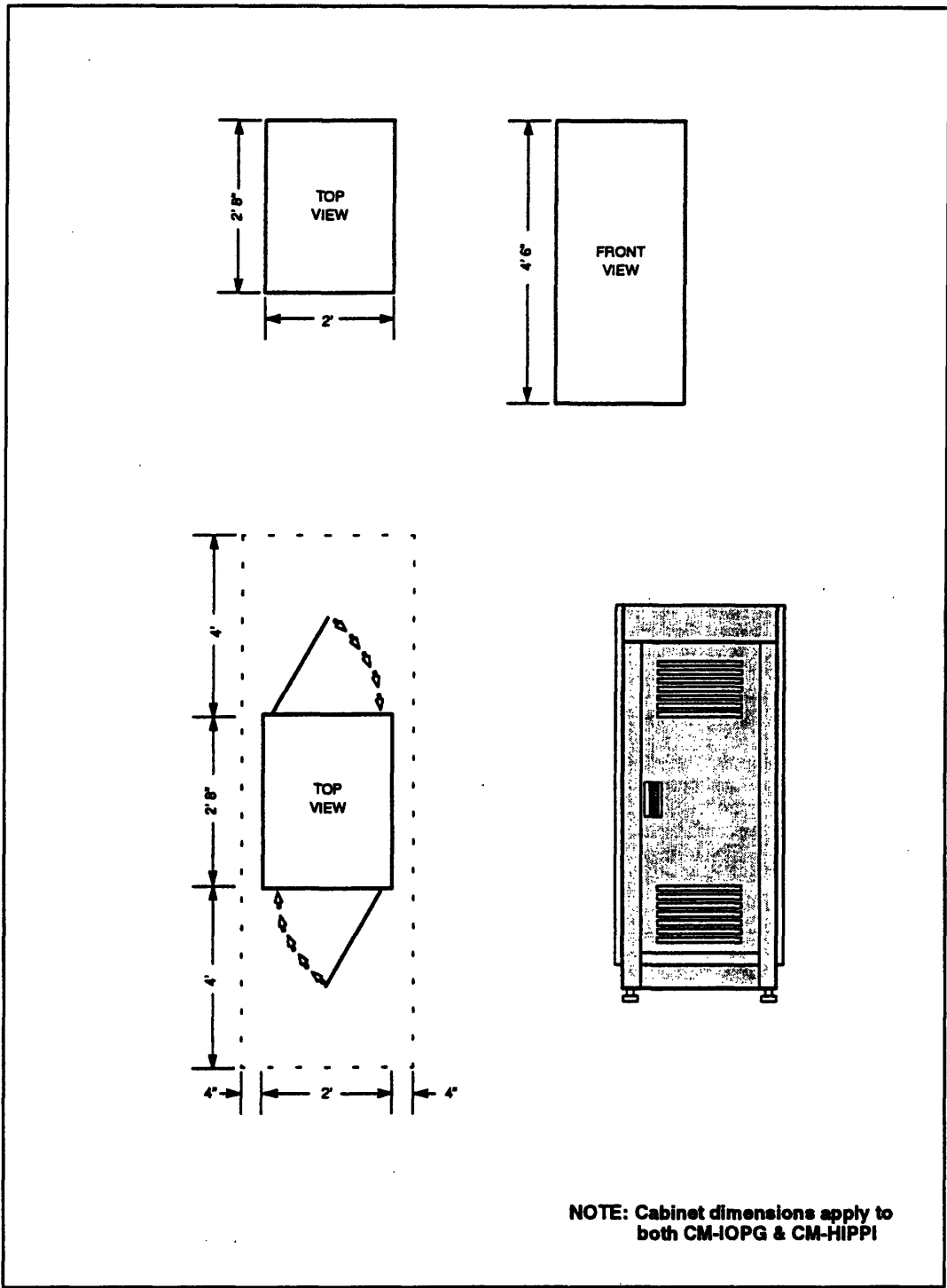

Figure 15. CM-IOPG and CM-HIPPI cabinet dimensions and access requirements (drawing is not to scale)

CM-5 Site Preparation Guide

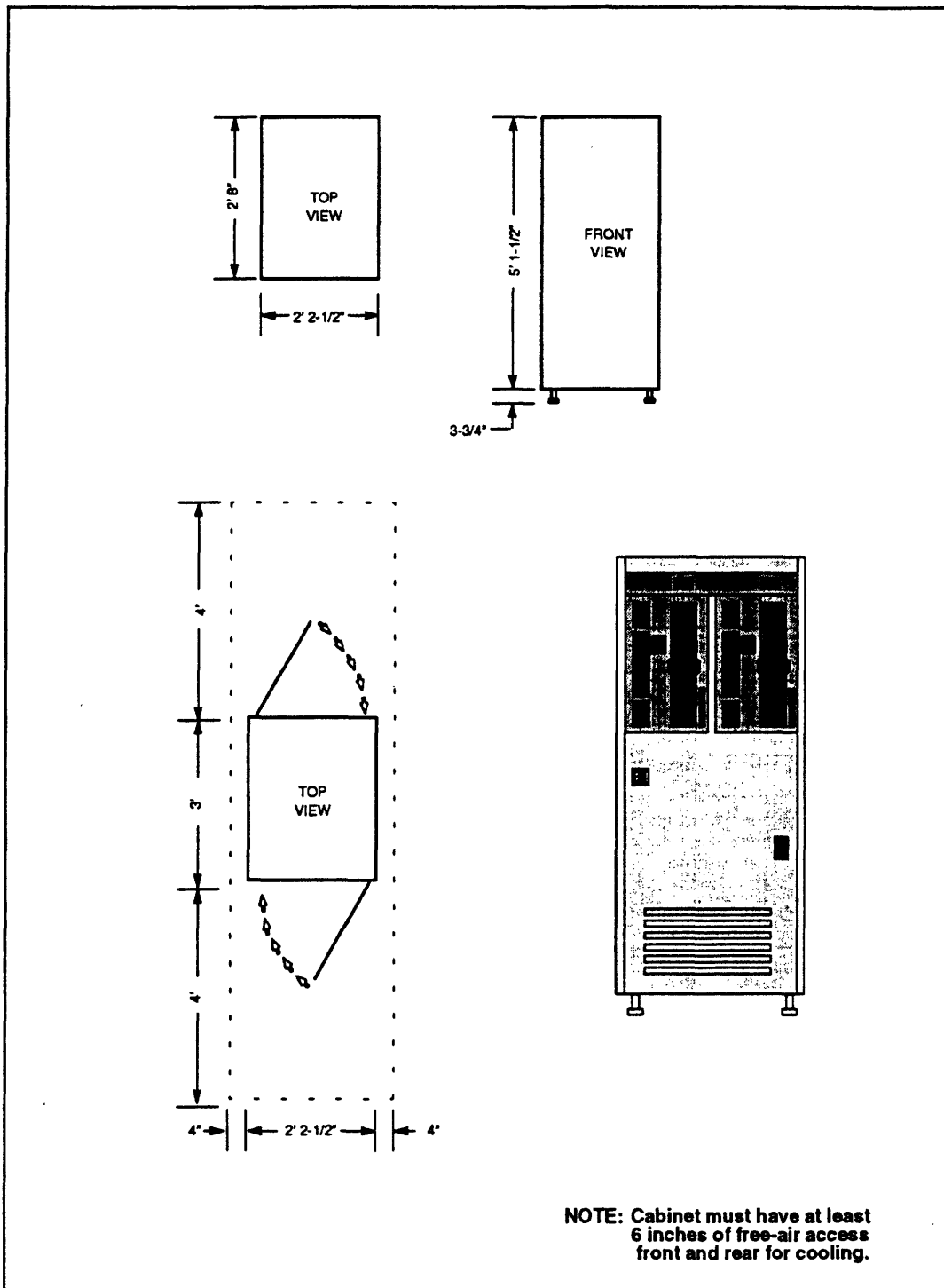

Figure 16. CM-TUD cabinet dimensions and access requirements
(drawing is not to scale)

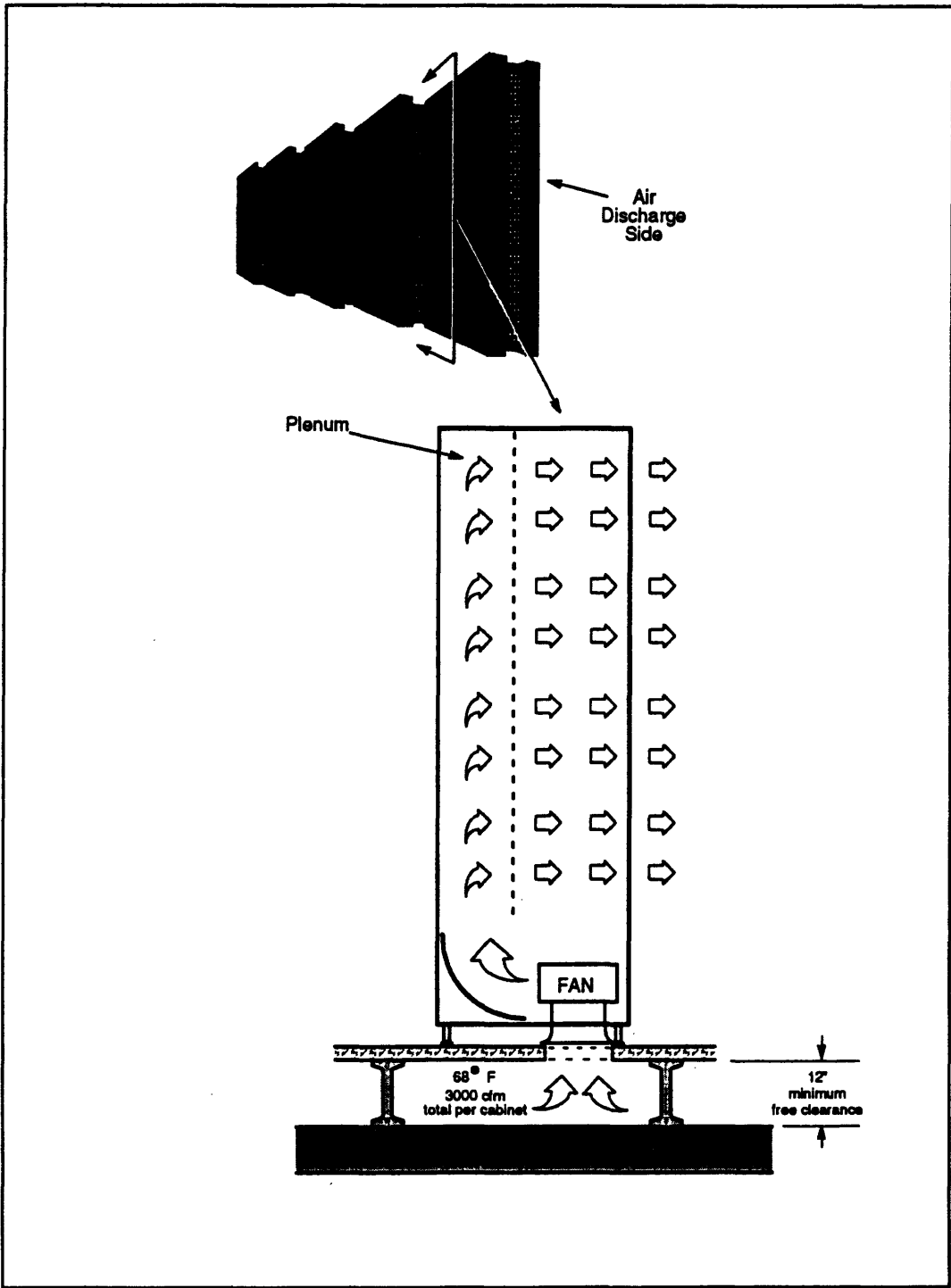

Figure 17. Cabinet cooling air flow — cutaway view

CM-5 Site Preparation Guide

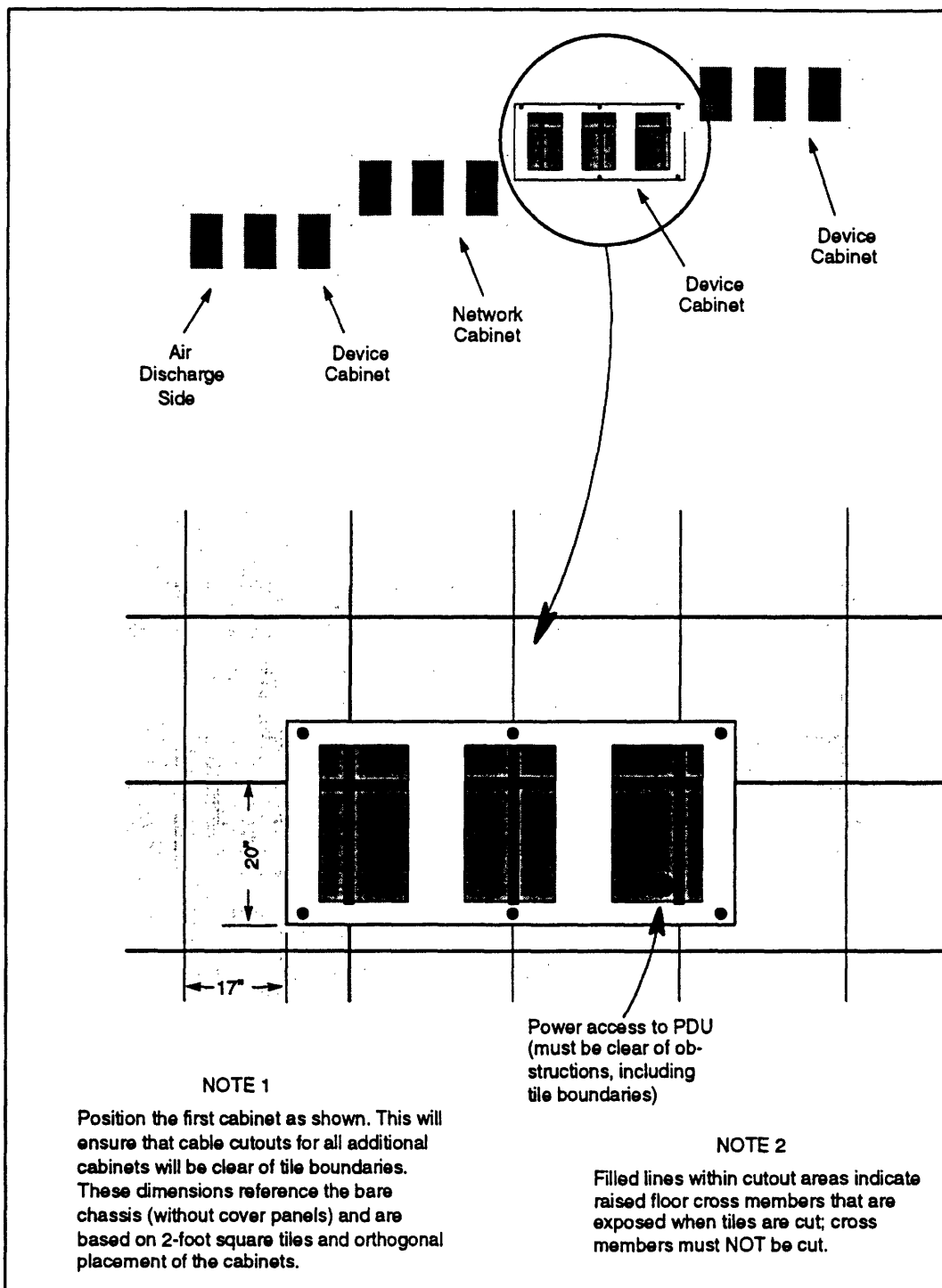

Figure 18. Cabinet placement for first cabinet (drawing is not to scale)

CM-5 Site Preparation Guide

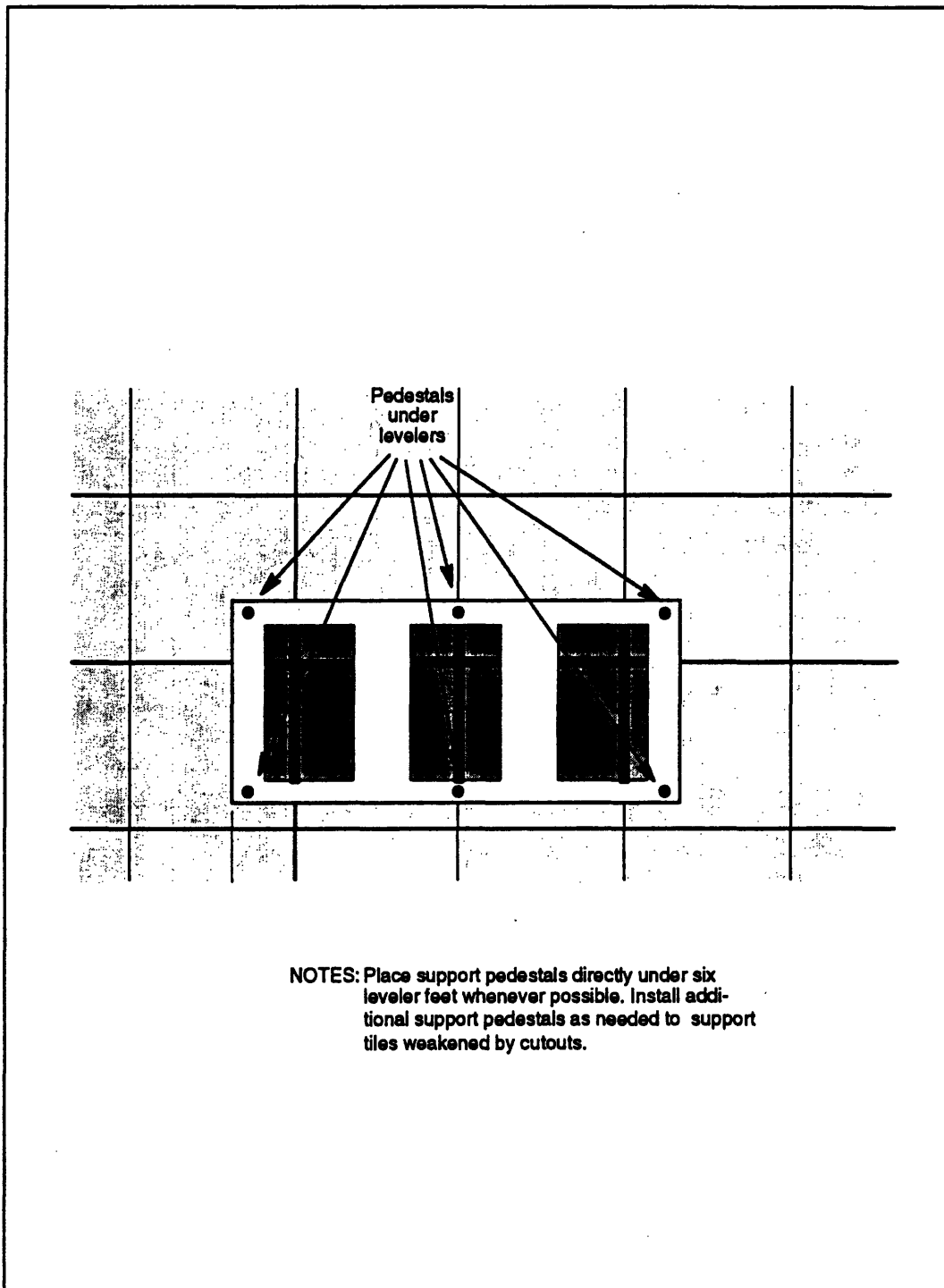

Figure 19. Support pedestal placement — general guidelines
(drawing is not to scale)

CM-5 Site Preparation Guide

Table 1
CM-5 Physical Dimensions—Shipping

	Width (inches)	Depth (inches)	Height (inches)	Weight (pounds)
Device cabinet	41	65	83-1/2	2780*
Network cabinet	41	65	83-1/2	2480
CM-5 door crate	88	38	58	425
CM-5 small crate (one large and one small crate per cabinet)	56	28	35	200
CM-5 large crate (one large and one small crate per cabinet)	89	34	37	500
Mobile staging unit (one unit included per installation)	66	38	59	350
Circuit board box (1)	46	46	42	seenote**
DataVault (shipped in four crates, as follows)				
End crate (2)	35	60	55	868each
Center crate (1)	35	52	55	798
Base (1)	122	35	14	85
DataVault parts (3)***	47	47	37	550
CM-HIPPI	24	32	66	275
CM-IOPG	24	32	66	275
CM-TUD	26-1/2	36	61-1/2	650

* This shipping weight is for a cabinet with 8 PN chassis (256 addresses). The shipping weight for a cabinet with 8 SDA chassis is 3290 pounds. Consult with the Thinking Machines Customer Support Group for the specific weight of a device cabinet with a different configuration of PN and/or SDA chassis.

** Eight pounds per circuit board; number of circuit board crates depends on system size.

*** Three parts crates, containing a MicroVAX, disk drives, etc., per DataVault.

CM-5 Site Preparation Guide

Table 2
CM-5 Physical Dimensions—Installed

	Width (inches)	Depth (inches)	Height (inches)	Weight (pounds)
Device cabinet				
PN EPVs	69	32	86	3100*
SDA EPVs	69	32	86	3388**
Network cabinet	69	32	86	3100
DataVault	47	124	37.5	2500
CM-HIPPI	66	24	32	275
CM-IOPG	66	24	32	275
CM-TUD	61.5	26.5	36	650

- * This is the maximum weight for a device cabinet with 8 PN chassis (256 addresses); each chassis weighs 36 pounds. The site survey team will provide specific weights for device cabinets with fewer PNs or a mix of PNs and SDAs.
- ** This is the maximum weight for a device cabinet with 8 SDA chassis (256 addresses); each chassis weighs 100 pounds. The site survey team will provide specific weights for device cabinets with fewer SDAs or a mix of PNs and SDAs.

CM-5 Site Preparation Guide

**Table 3
CM-5 Power Source Requirements**

Input power

Device cabinet	5 wire	208 VAC	50/60 Hz	3 phase	100 A service
Network cabinet	5 wire	208 VAC	50/60 Hz	3 phase	60 A service
System Administration Console	3 wire	120 VAC	50/60 Hz	1 phase	15 A service
DataVault	5 wire	208 VAC	50/60 Hz	3 phase	30 A service
CM-HIPPI	3 wire	208 VAC	50/60 Hz	1 phase	30 A service
CM-IOPG	3 wire	208 VAC	50/60 Hz	1 phase	15 A service
CM-TUD	3 wire	208 VAC	50/60 Hz	1 phase	15 A service

Power receptacle specifications

Device cabinets	Primary power is hardwired to CM-5 cabinets; no receptacles are required; use 1/0 or 2 gauge wire; 1-1/4 inch, type B, UL metallic or non-metallic flexible conduit must be provided
Network cabinets	Primary power is hardwired to CM-5 cabinets; no receptacles are required; use 6 gauge wire; 1 inch, type B, UL metallic or non-metallic flexible conduit must be provided
System Administration Console	Six 120 V, 15 A power sources, each fitted with a NEMA 5-15R receptacle per System Administration Console.
DataVault cabinet	208 V, 30 A power source fitted with one NEMA L21-30R receptacle per DataVault; one 120 V, 15 A power source with a NEMA 5-15 receptacle is needed for each DataVault's local monitor
CM-HIPPI cabinet	208 V, 30 A power source fitted with one NEMA L6-30R receptacle per CM-HIPPI cabinet
CM-IOPG cabinet	208 V, 15 A power source fitted with one NEMA L6-15R receptacle per CM-IOPG cabinet
CM-TUD cabinet	208 V, 15 A power source fitted with one NEMA L6-15R receptacle per CM-TUD cabinet
System support equipment	120 V, 15 A power sources with NEMA 5-15 receptacles are needed to support miscellaneous field service support equipment (minimum of 4 duplex).

CM-5 Site Preparation Guide

Table 4
CM-5 Power Dissipation Specification
(per cabinet)

	Watts	KVA	BTUs hour	Tons of AC
Device cabinet	24,100	32	82,000	7
Network cabinet	3060	4.0	10,000	0.8
DataVault	3300	5.5	23,083	1.4
CM-HIPPI	1000	1.33	3400	0.3
CM-IOPG	500	0.67	1700	0.15
CM-TUD	1600	2.13	5500	0.5

NOTE: These values are for CM-5 systems with Vector Units.

Table 5
CM-5 System Environment Specifications

Ambient Room Temperature

Maximum	70° F (required by peripheral equipment)
Relative humidity	40%—80% (no condensation)

CM-5 Cabinet Cooling Requirements

Maximum air temperature at cabinet intake	68° F
Minimum air flow rate (total per cabinet)	3000 cubic feet per minute

CM-5 Site Preparation Guide

Table 6
CM-5 System
External Signal Cabling

Name	Quantity	Length	Description
CMIO bus	1 bus segment per I/O device*	50 or 80 feet**	Connects CM-5 IOBA to DataVault, CM-HIPPI, and/or CM-IOPG; supplied by Thinking Machines.
Ethernet	1 drop per CM-5 (1 in, 1 out)	Site dependent	Connects CM-5 control processors, servers, and I/O station managers to customer's Ethernet network. Thinking Machines provides thin net (BNC) connectors.
External Diagnostic Network cable	1 per CM-5	27.5 feet***	Connects external diagnostic control processor to the CM-5 diagnostic network root; supplied by Thinking Machines.
Console cable	1 per console	300 feet	Connects console unit to external control processors, servers, and I/O device station managers. This length applies to cables that conform to RS-432 electrical standards.

* One CMIO bus segment is needed to connect a single I/O device to a CM-5 IOBA. Additional I/O devices can be daisy-chained to the first device, requiring a separate CMIO bus segment for each additional device. Maximum total length of a CMIO bus daisy chain is 200 feet.

** CMIO bus segments are available in two standard lengths: 50 and 80 feet.

*** The external diagnostic processor can be placed up to 20 feet away from the device cabinet to which it is cabled; approximately 7 feet of the external diagnostic network cable are used for internal cable routing.

CM-5 Site Preparation Guide

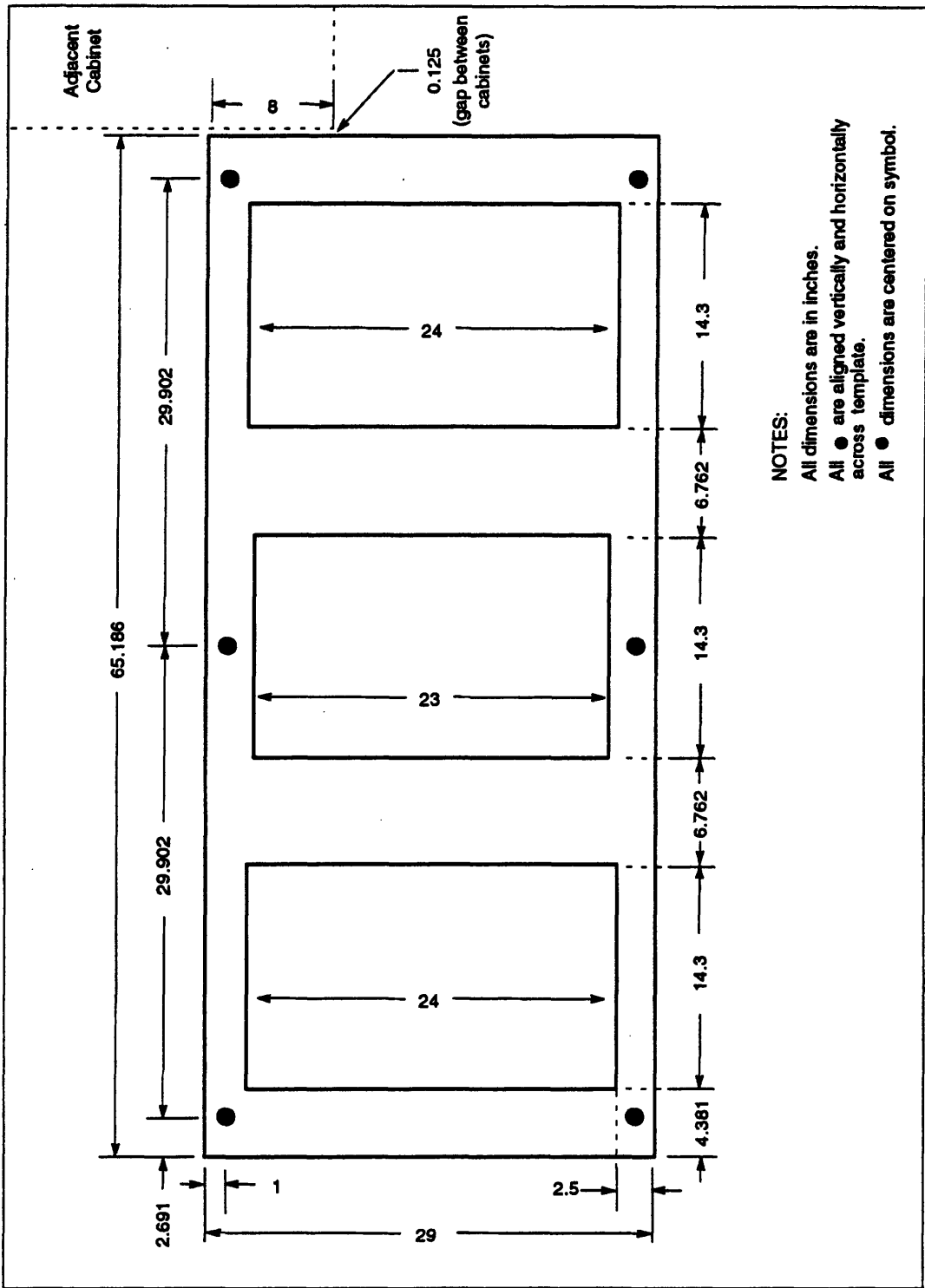

NOTES:
 All dimensions are in inches.
 All ● are aligned vertically and horizontally across template.
 All ● dimensions are centered on symbol.

Figure 20. Air intake cutout and support pedestal locations—decimal
 (drawing is not to scale)

CM-5 Site Preparation Guide

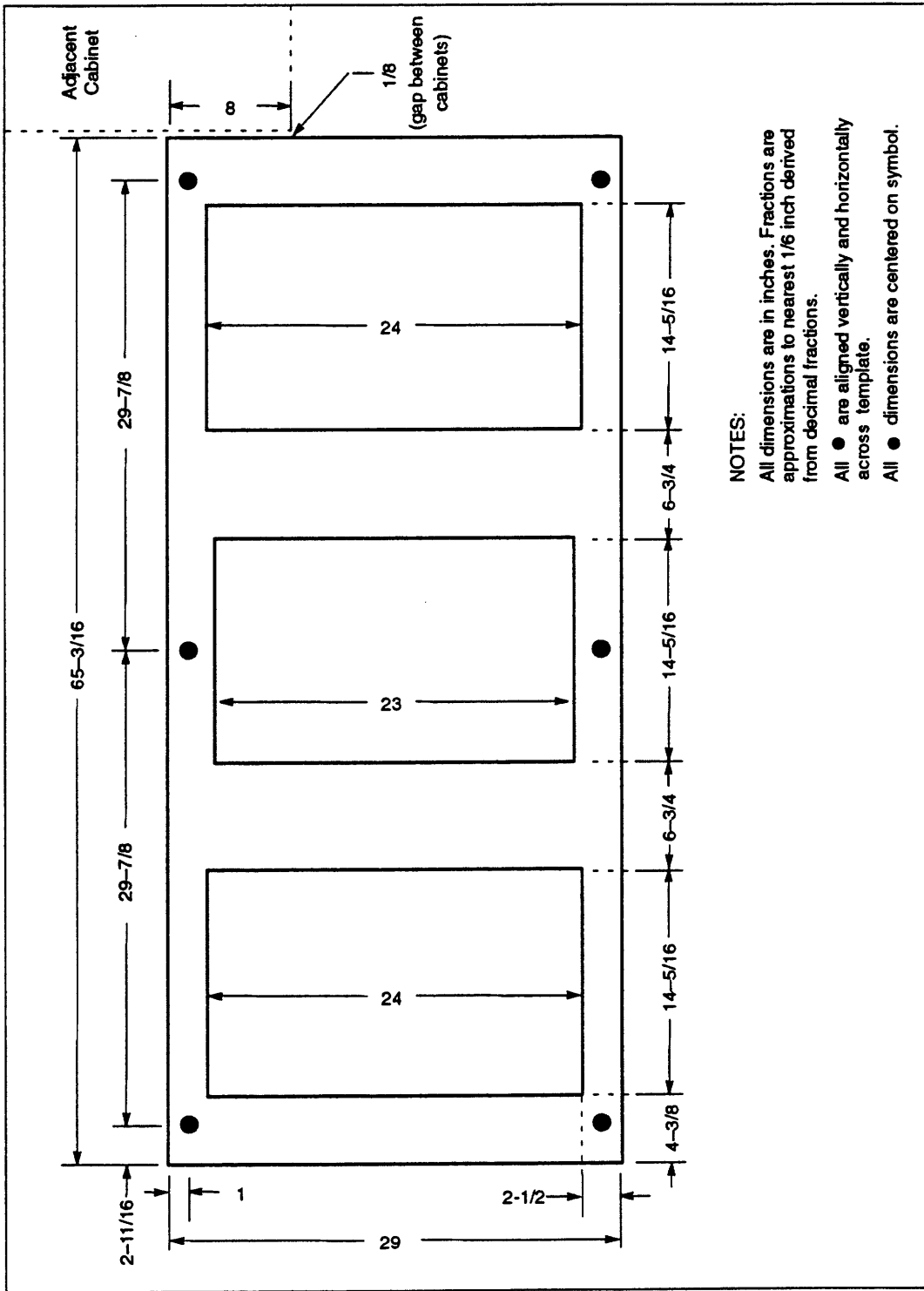

NOTES:
 All dimensions are in inches. Fractions are approximations to nearest 1/8 inch derived from decimal fractions.
 All ● are aligned vertically and horizontally across template.
 All ● dimensions are centered on symbol.

Figure 21. Air intake cutout and support pedestal locations (drawing is not to scale)

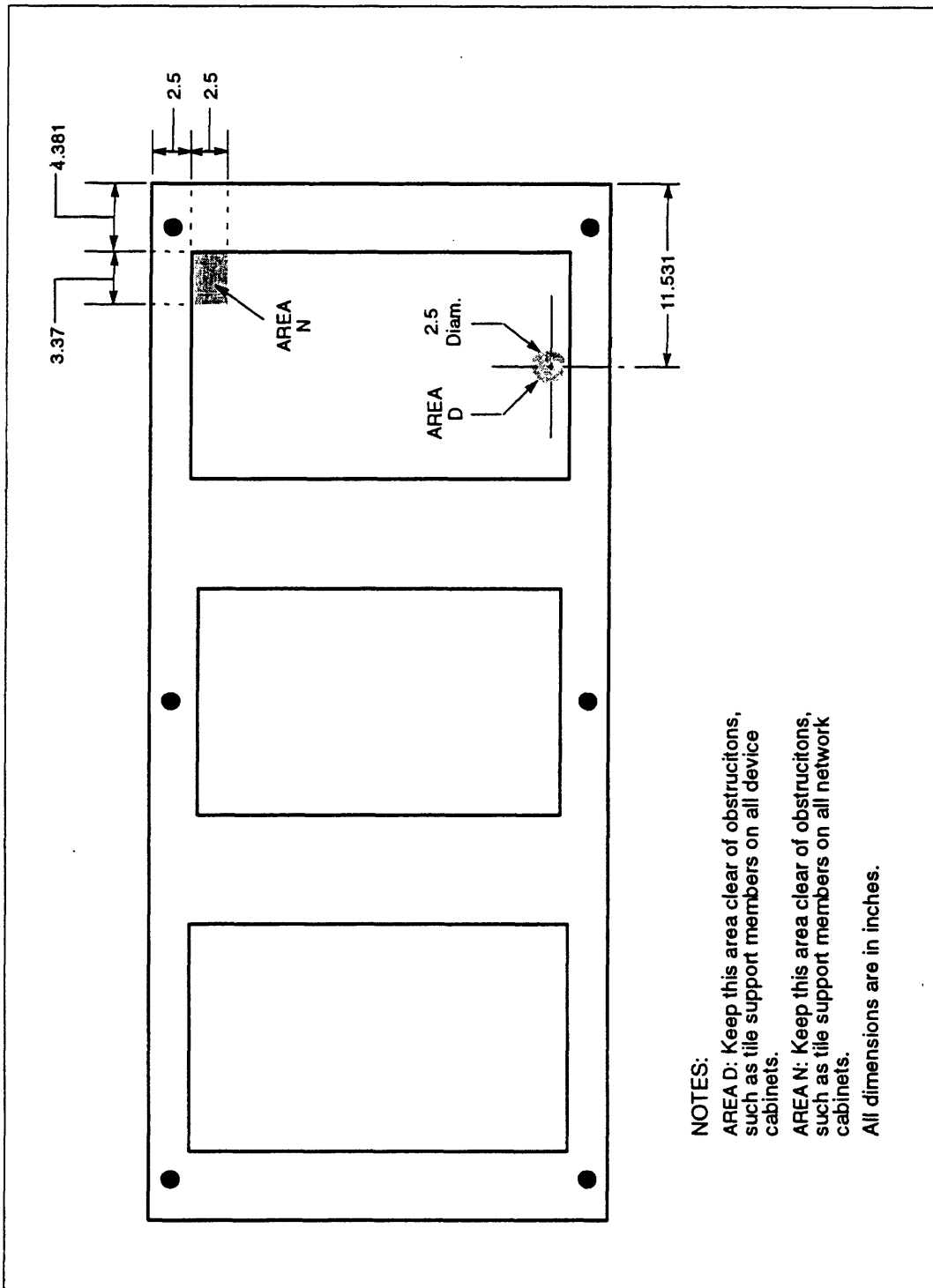

Figure 22. Power cable access requirements
(drawing is not to scale)

CM-5 Site Preparation Guide

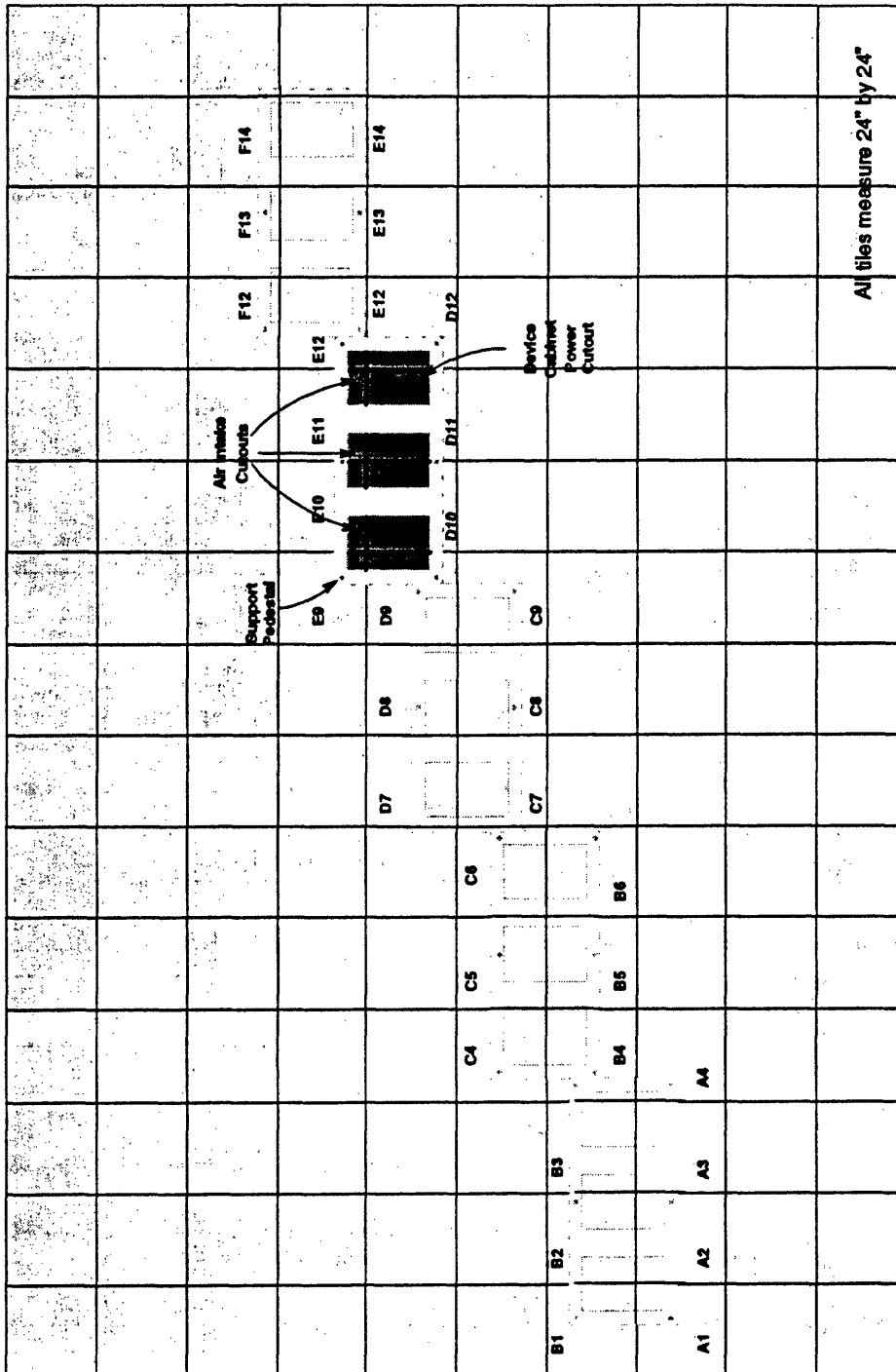

Figure 23. Air intake cutout and support pedestal locations — 1 cabinet
(drawing is not to scale)

CM-5 Site Preparation Guide

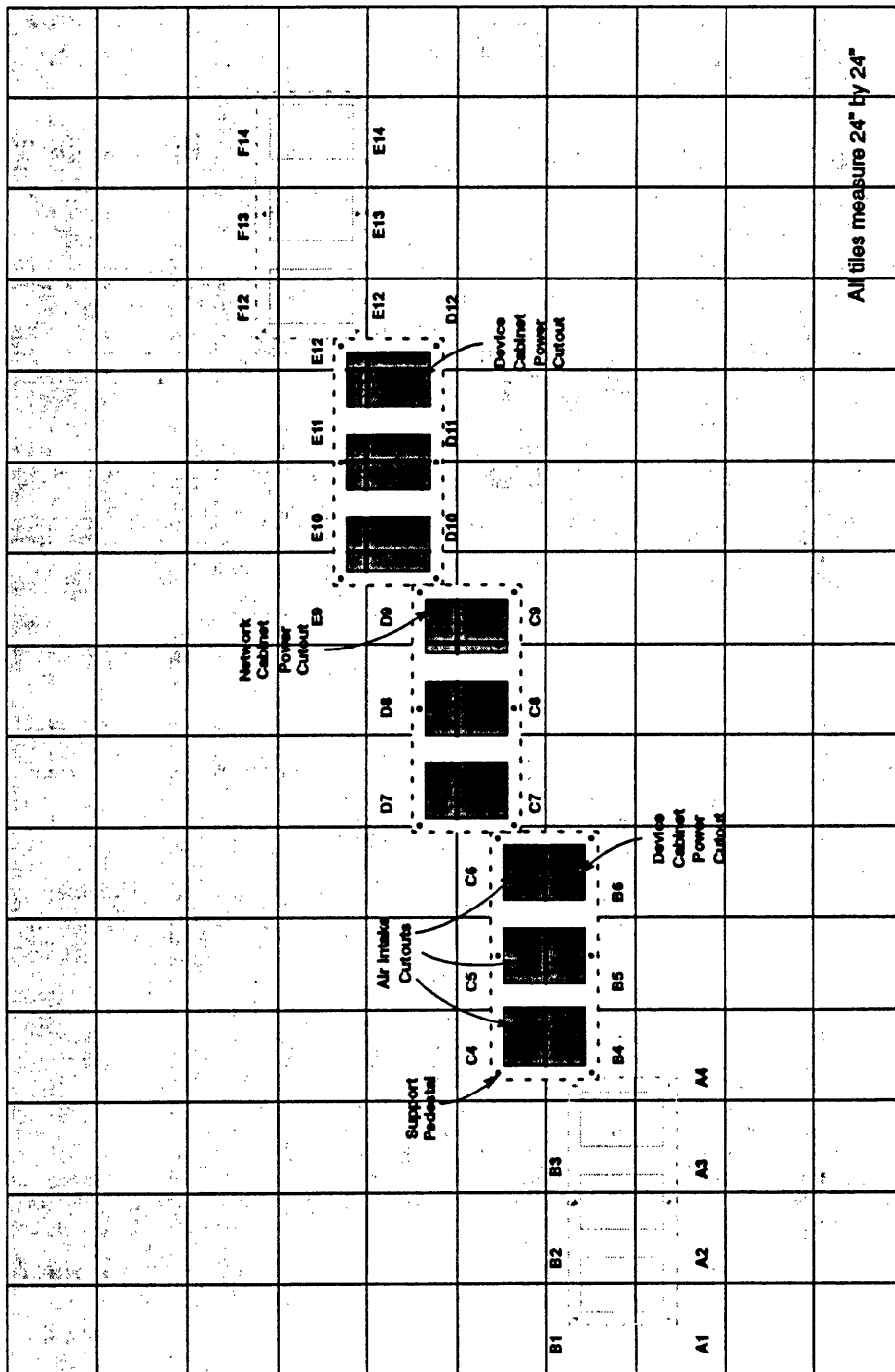

Figure 24. Air intake cutout and support pedestal locations — 3 cabinets (alternate)
(drawing is not to scale)

CM-5 Site Preparation Guide

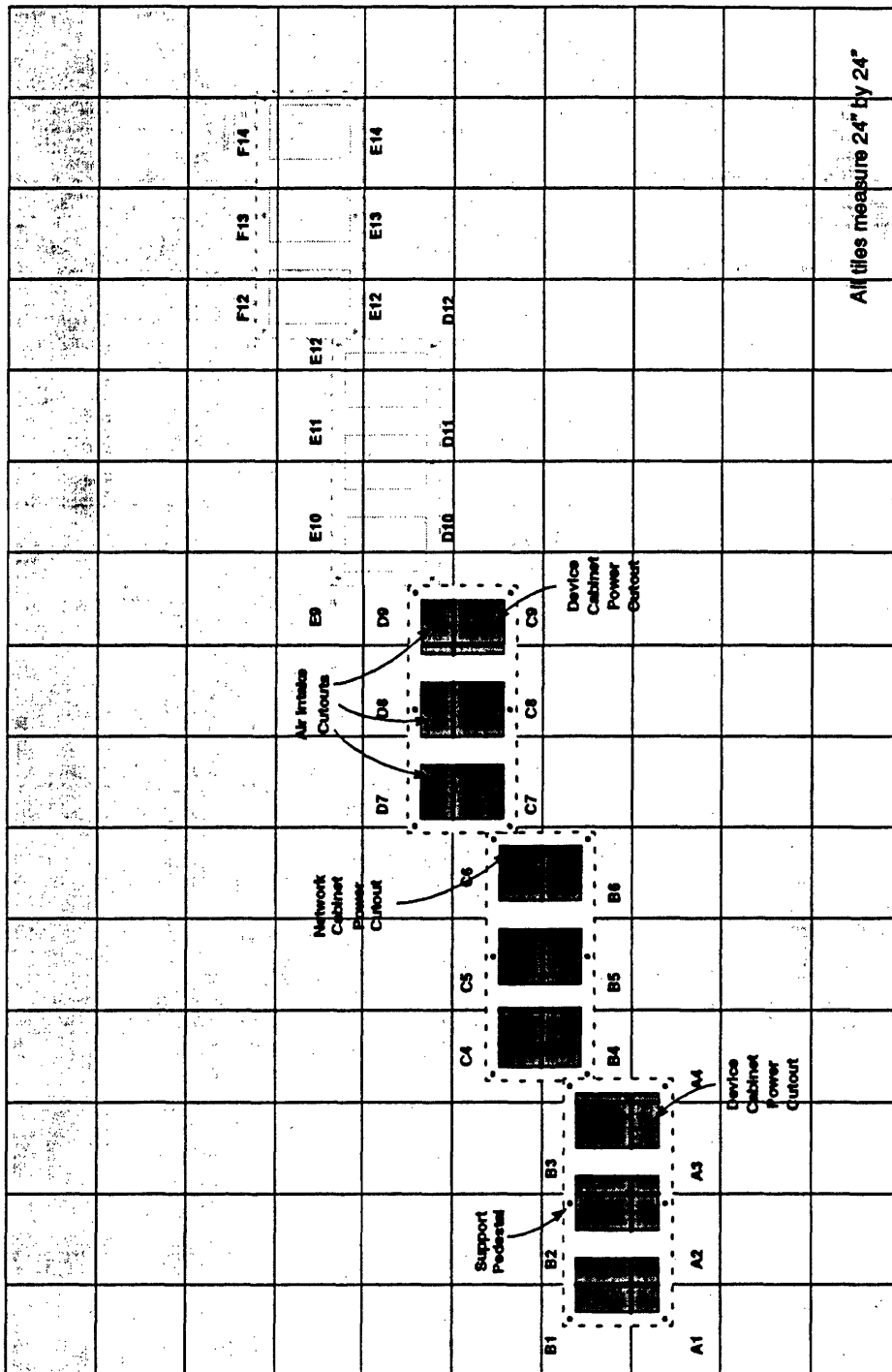

Figure 25. Air intake cutout and support pedestal locations — 3 cabinets
(drawing is not to scale)

CM-5 Site Preparation Guide

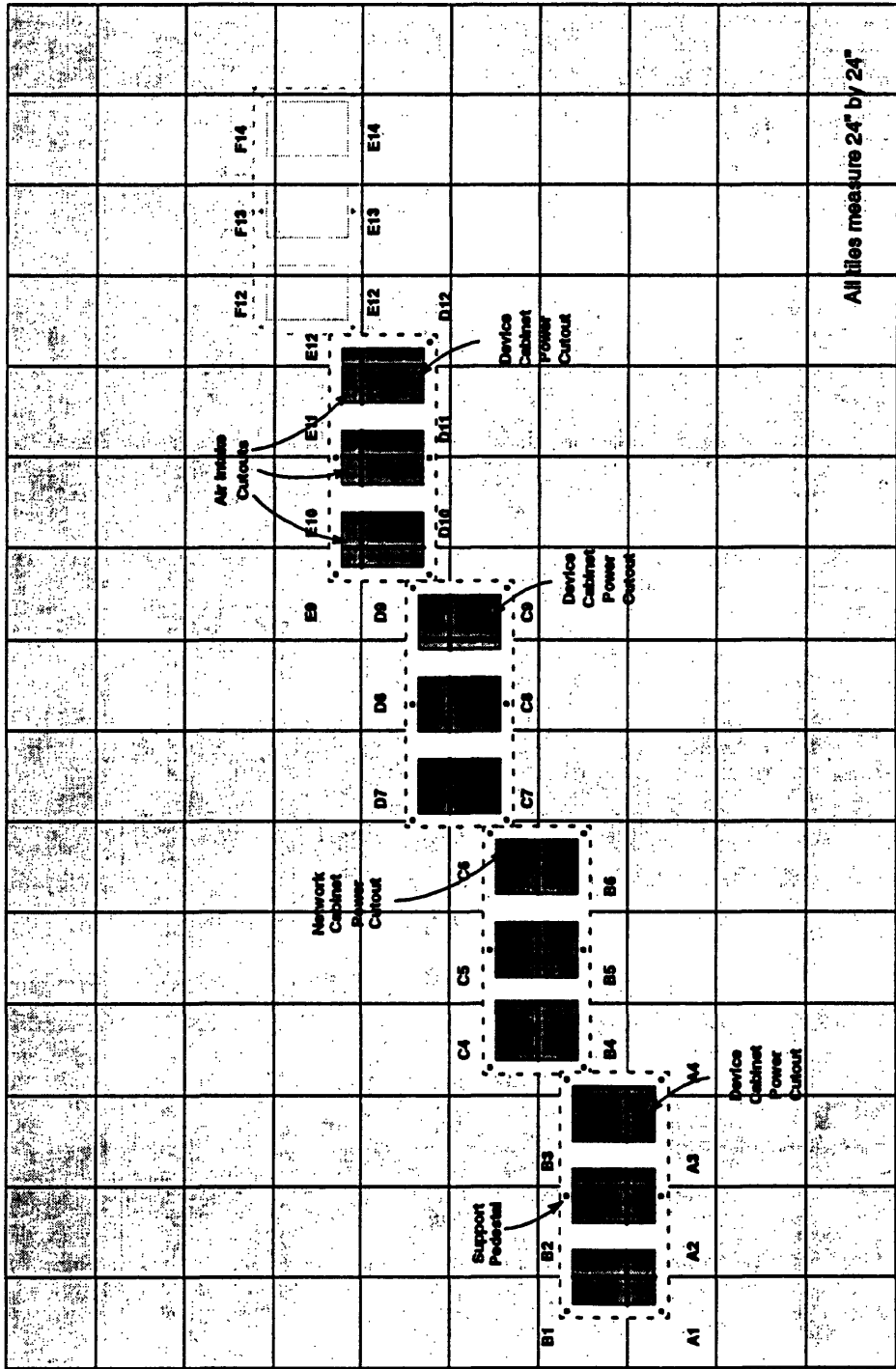

Figure 26. Air intake cutout and support pedestal locations — 4 cabinets
(drawing is not to scale)

CM-5 Site Preparation Guide

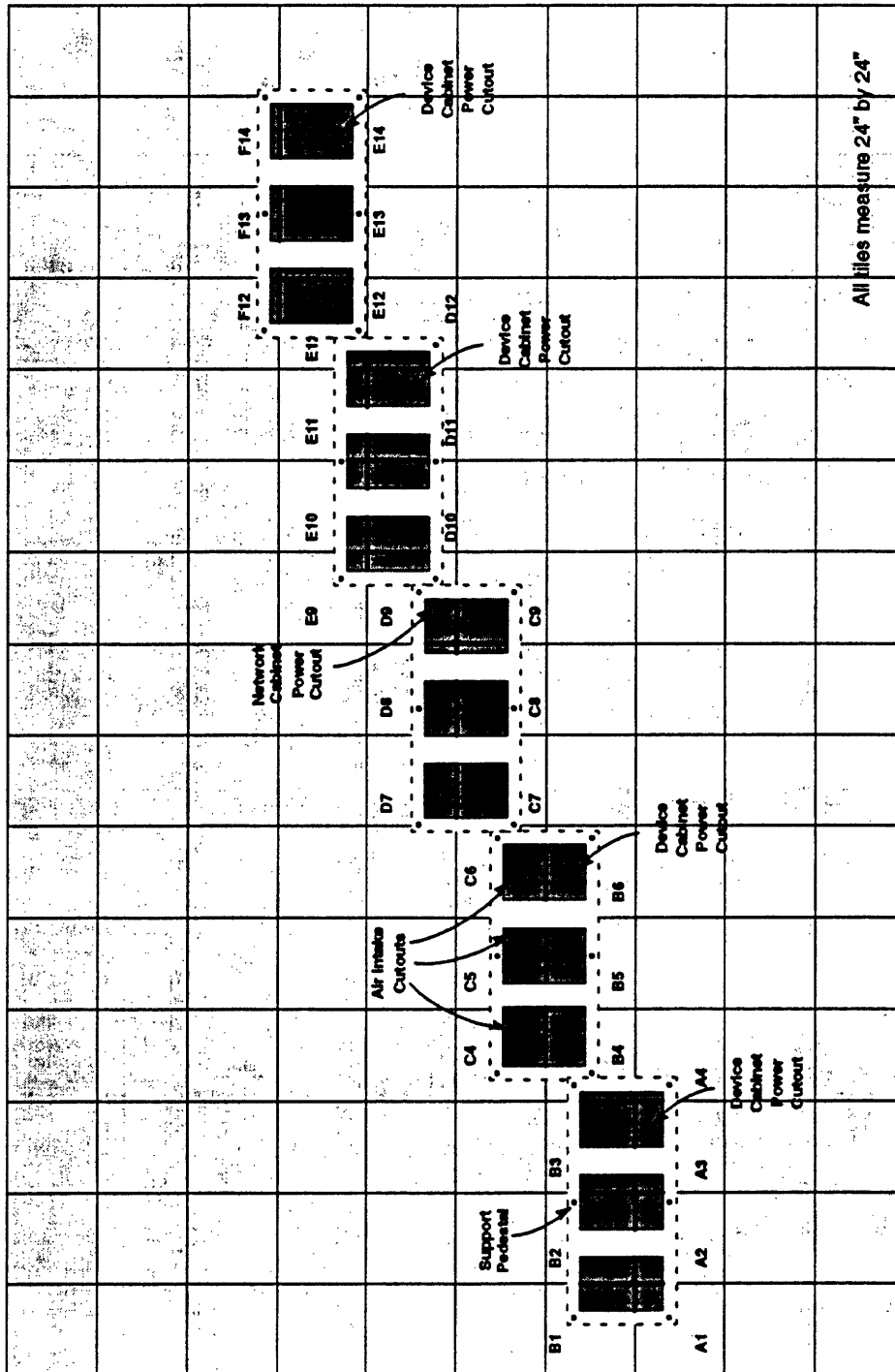

Figure 27. Air intake cutout and support pedestal locations — 5 cabinets
(drawing is not to scale)

CM-5 Site Preparation Guide

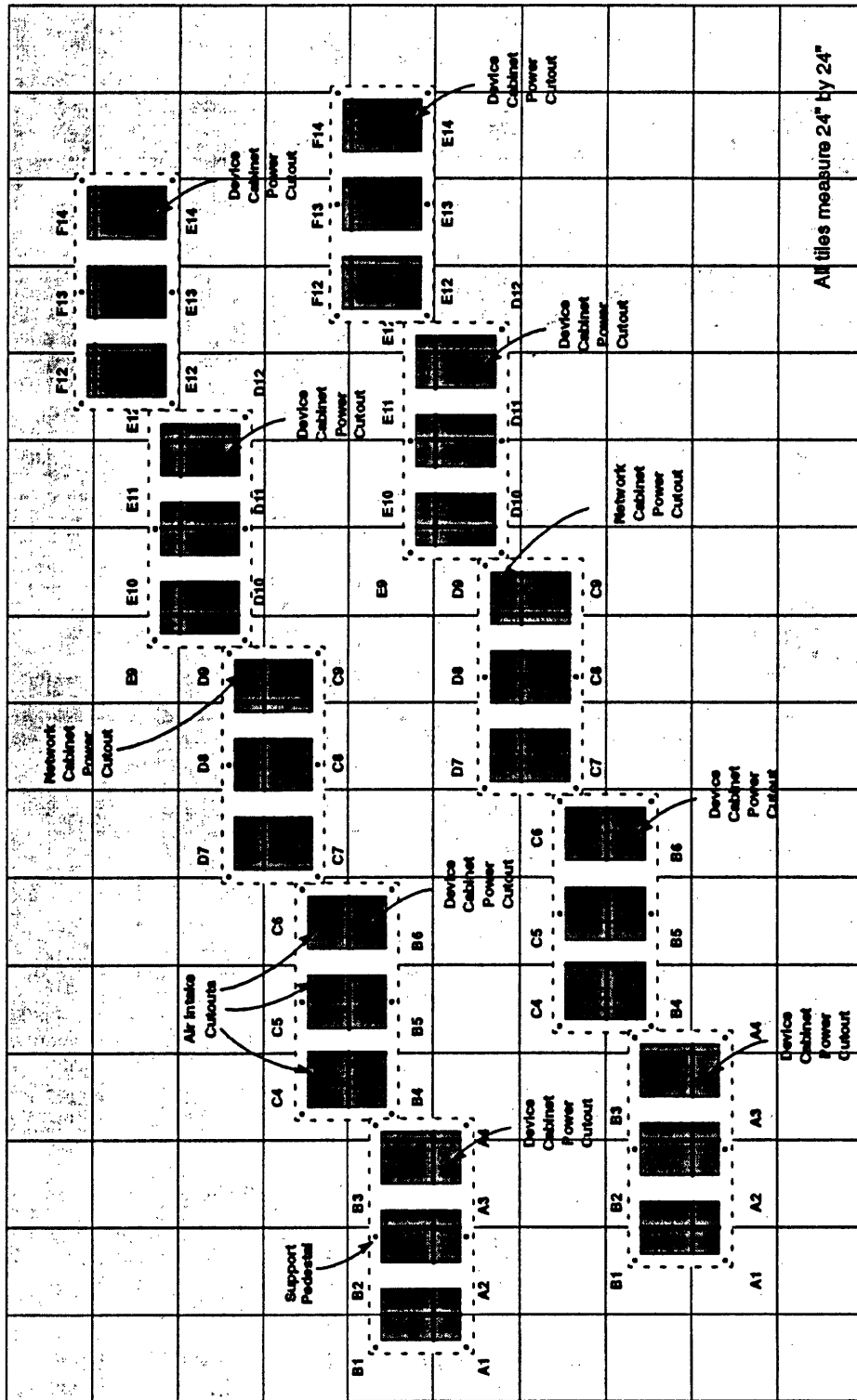

Figure 28. Air intake cutout and support pedestal locations — 2 bolts (drawing is not to scale)

CM-5 Site Preparation Guide

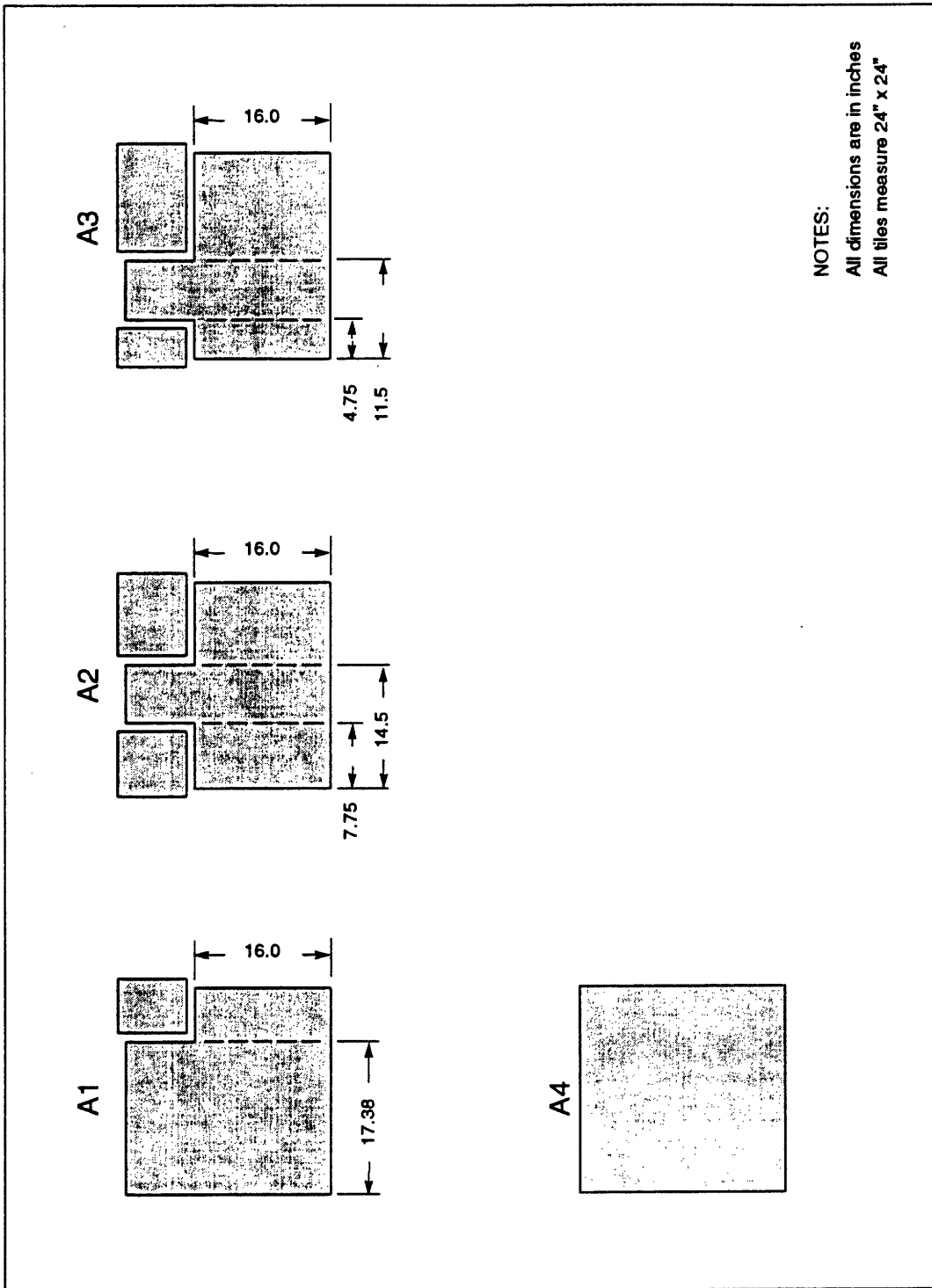

Figure 29. Tile cutout measurements
(drawing is not to scale)

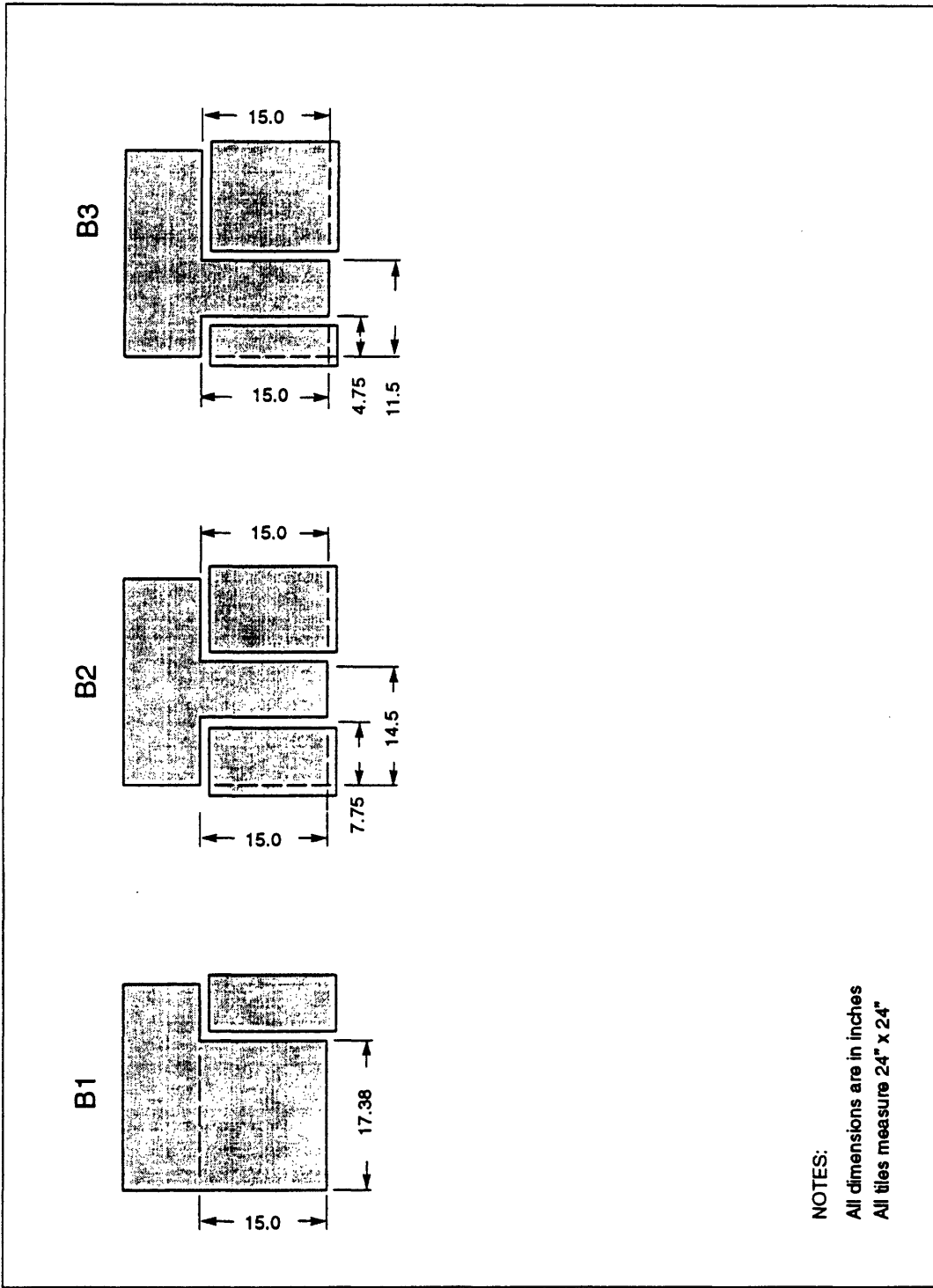

Figure 30. Tile cutout measurements
(drawing is not to scale)

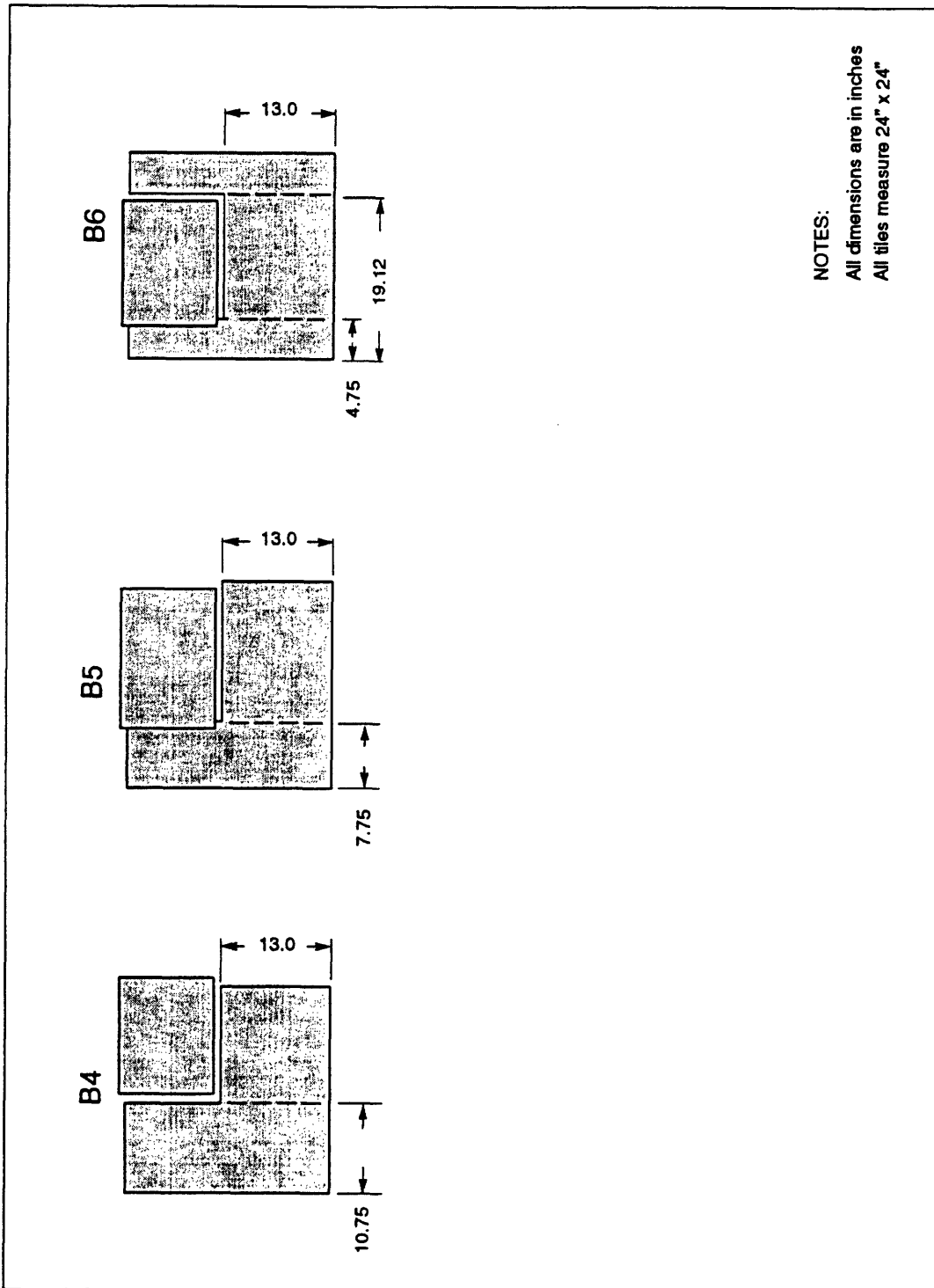

Figure 31. Tile cutout measurements
(drawing is not to scale)

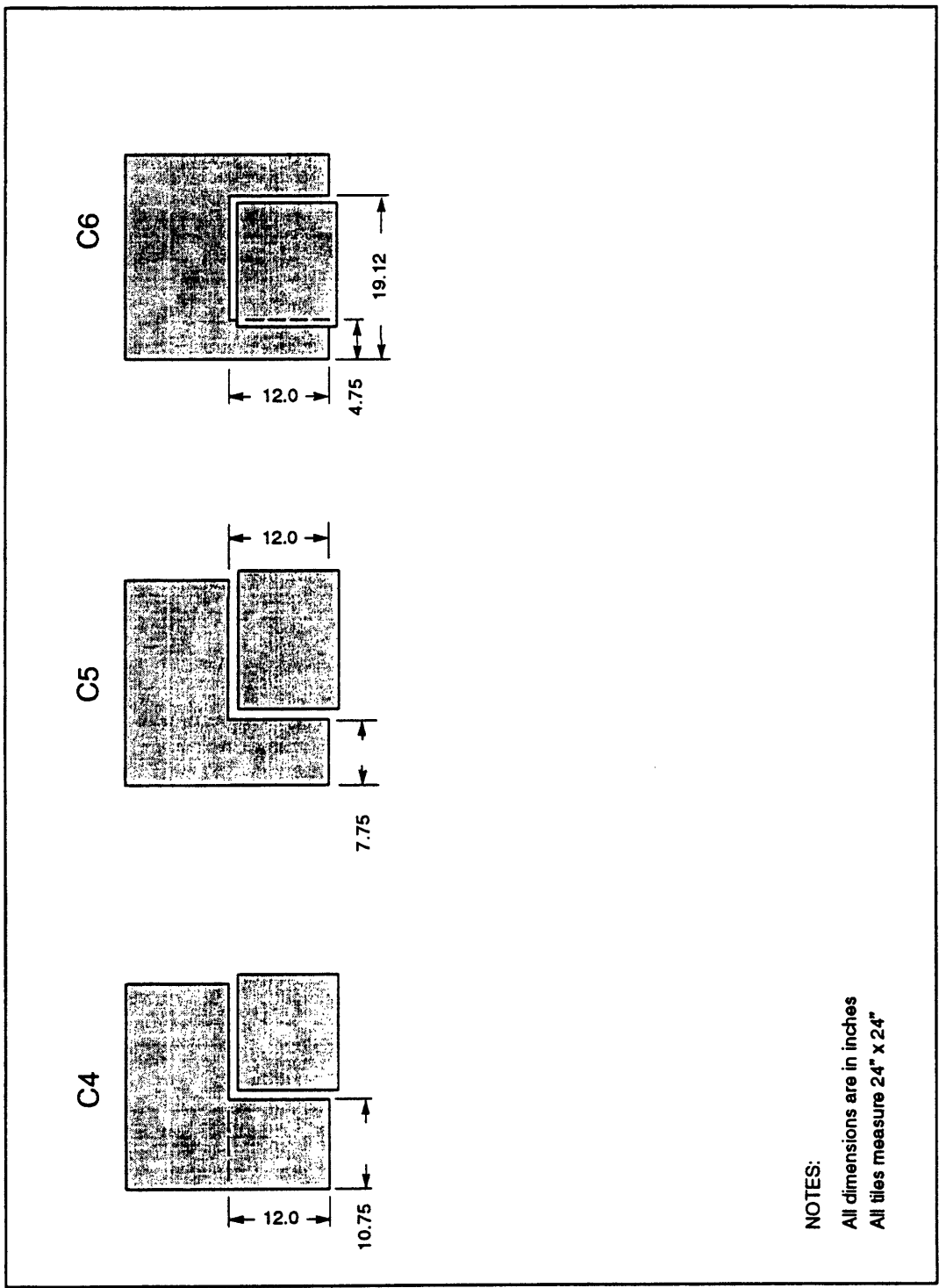

Figure 32. Tile cutout measurements
(drawing is not to scale)

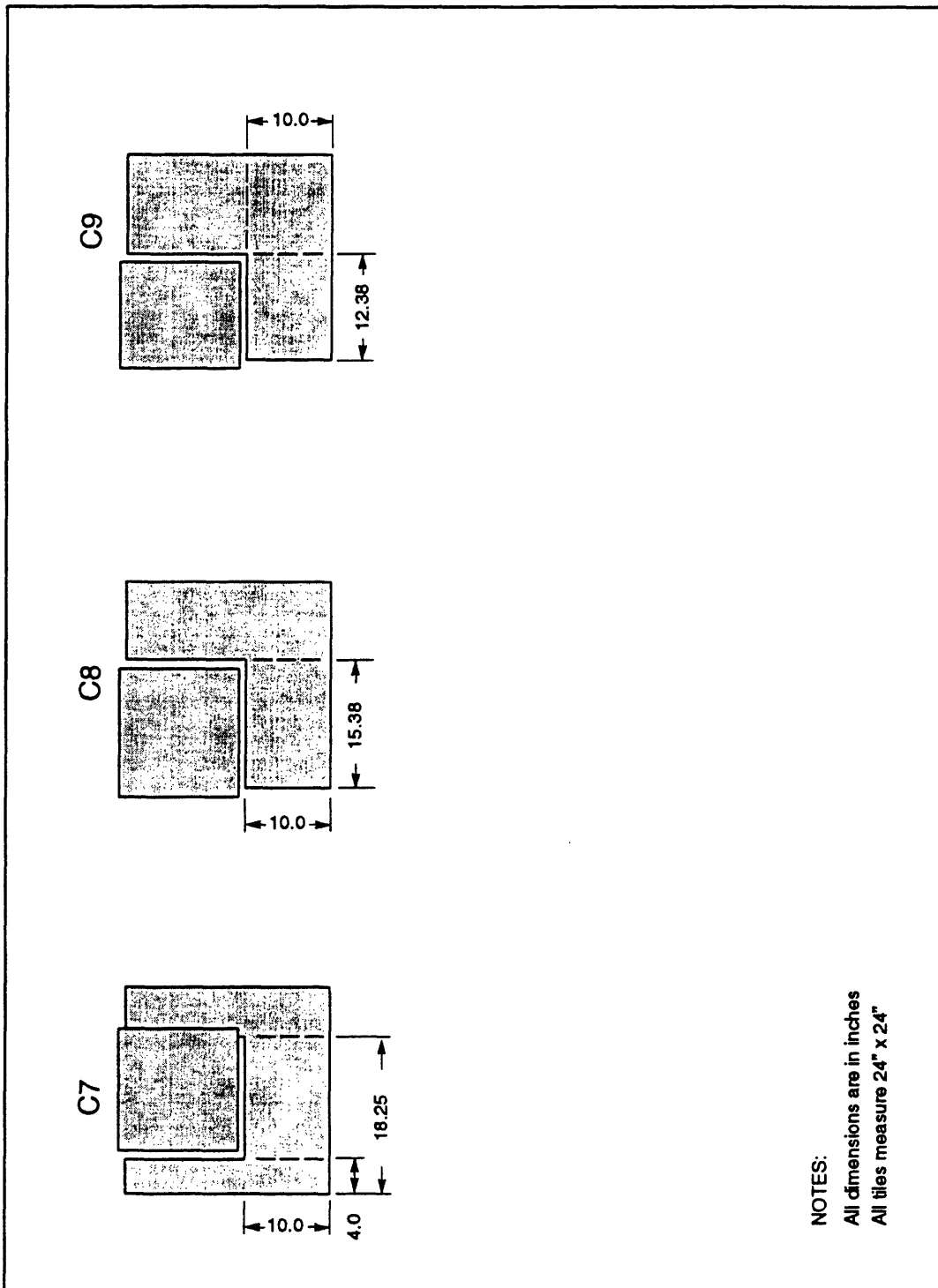

Figure 33. Tile cutout measurements
(drawing is not to scale)

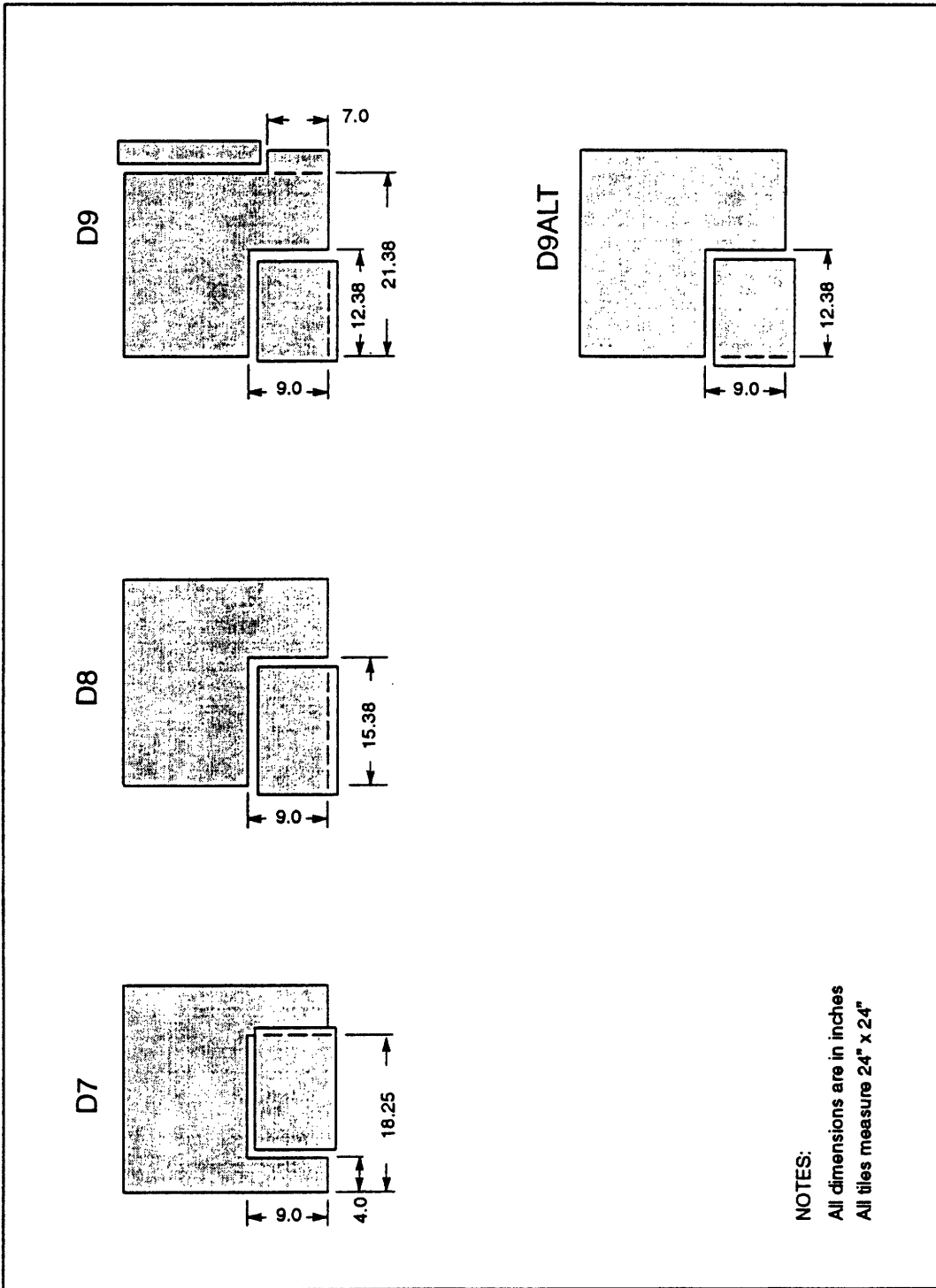

Figure 34. Tile cutout measurements
(drawing is not to scale)

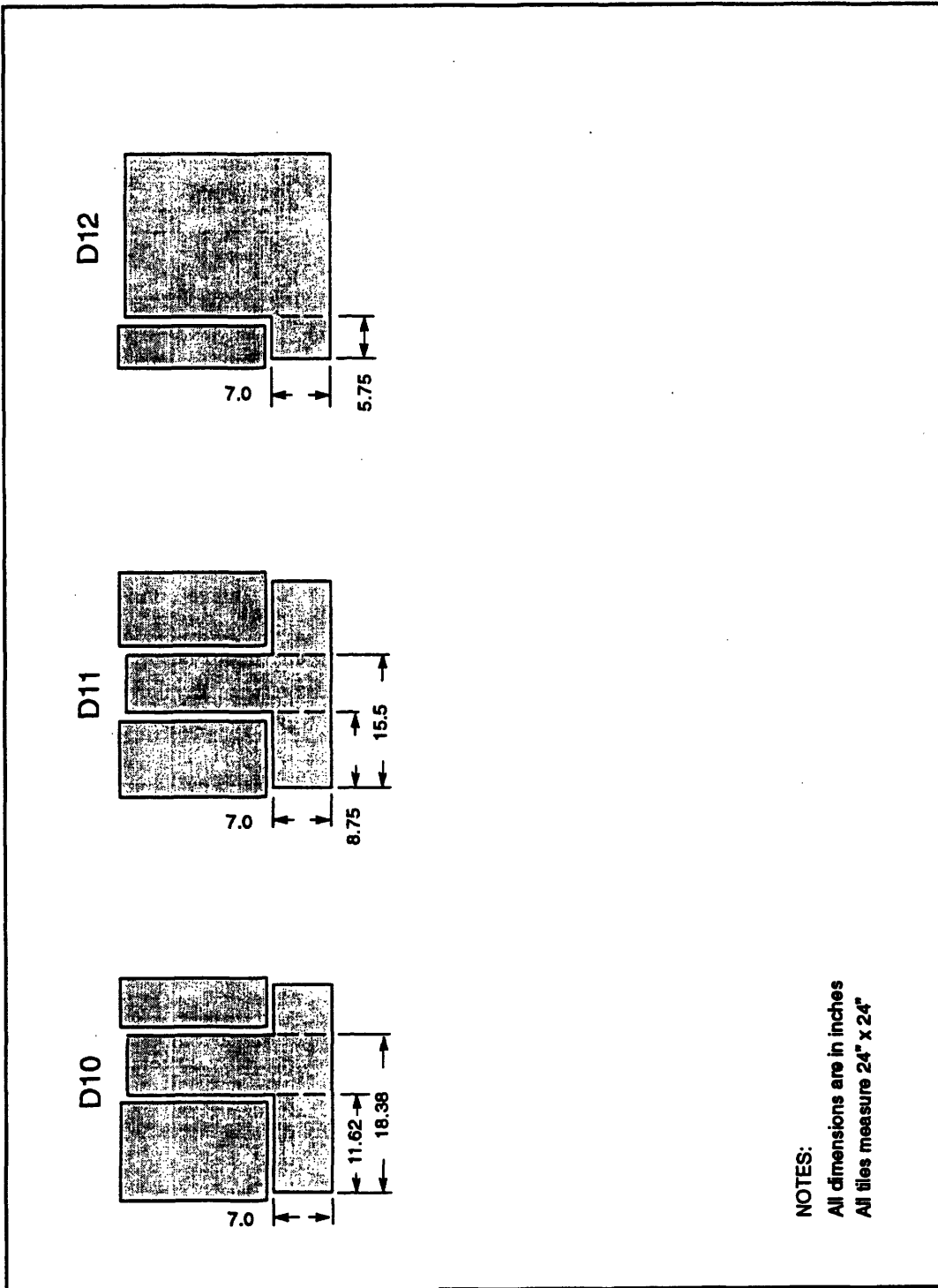

Figure 35. Tile cutout measurements
(drawing is not to scale)

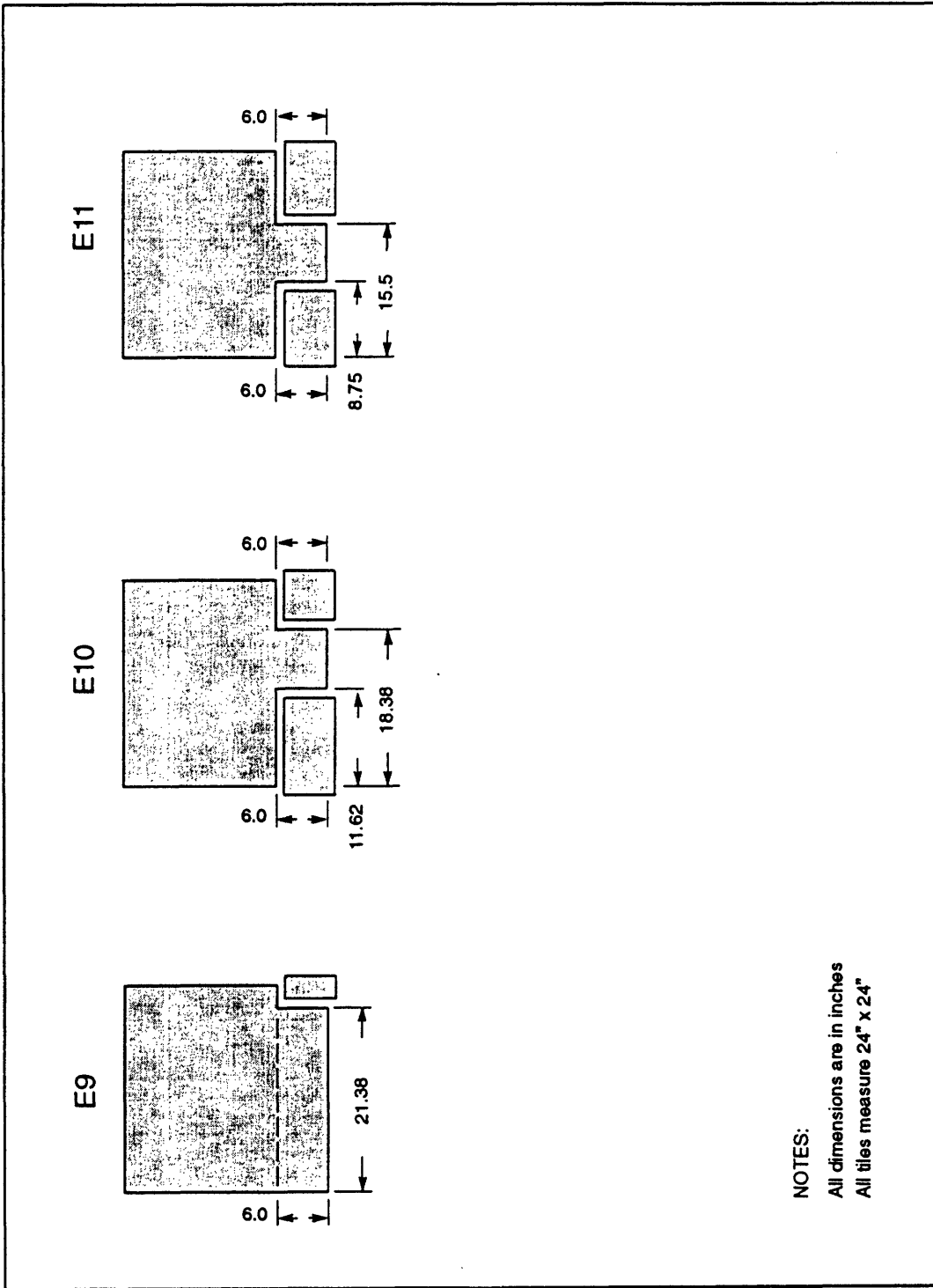

Figure 36. Tile cutout measurements
(drawing is not to scale)

CM-5 Site Preparation Guide

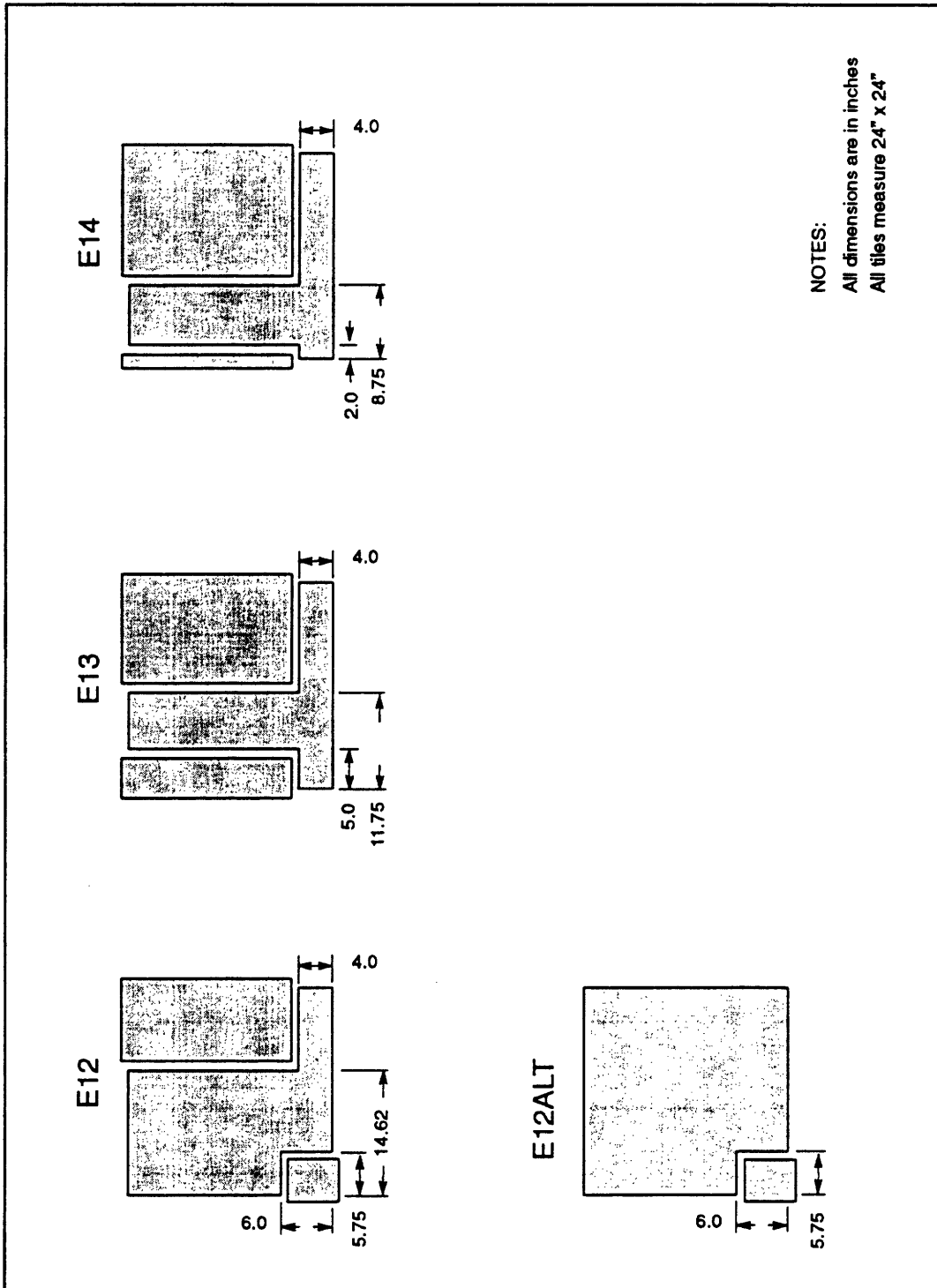
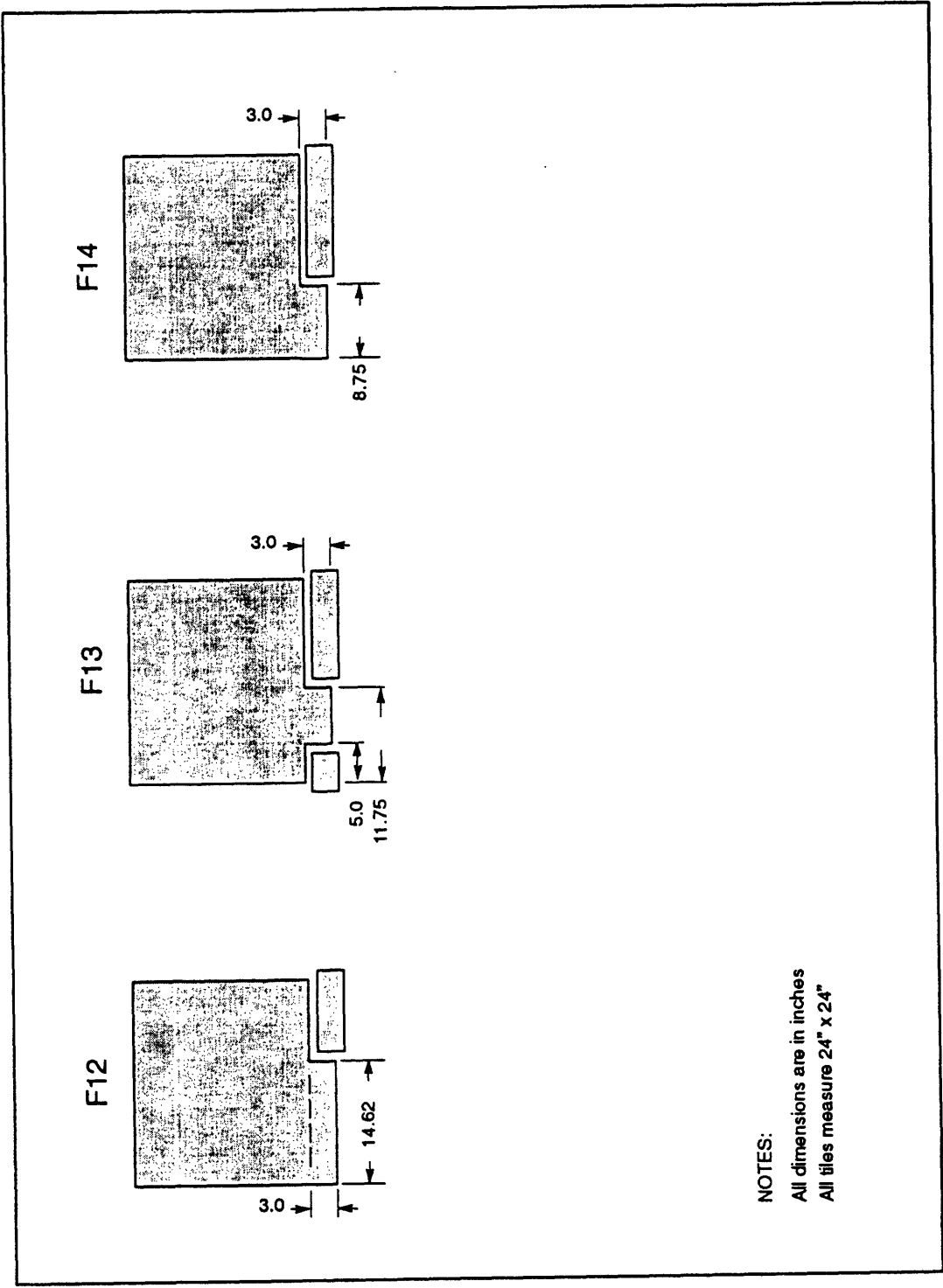

Figure 37. Tile cutout measurements
(drawing is not to scale)



NOTES:
All dimensions are in inches
All tiles measure 24" x 24"

Figure 38. Tile cutout measurements
(drawing is not to scale)

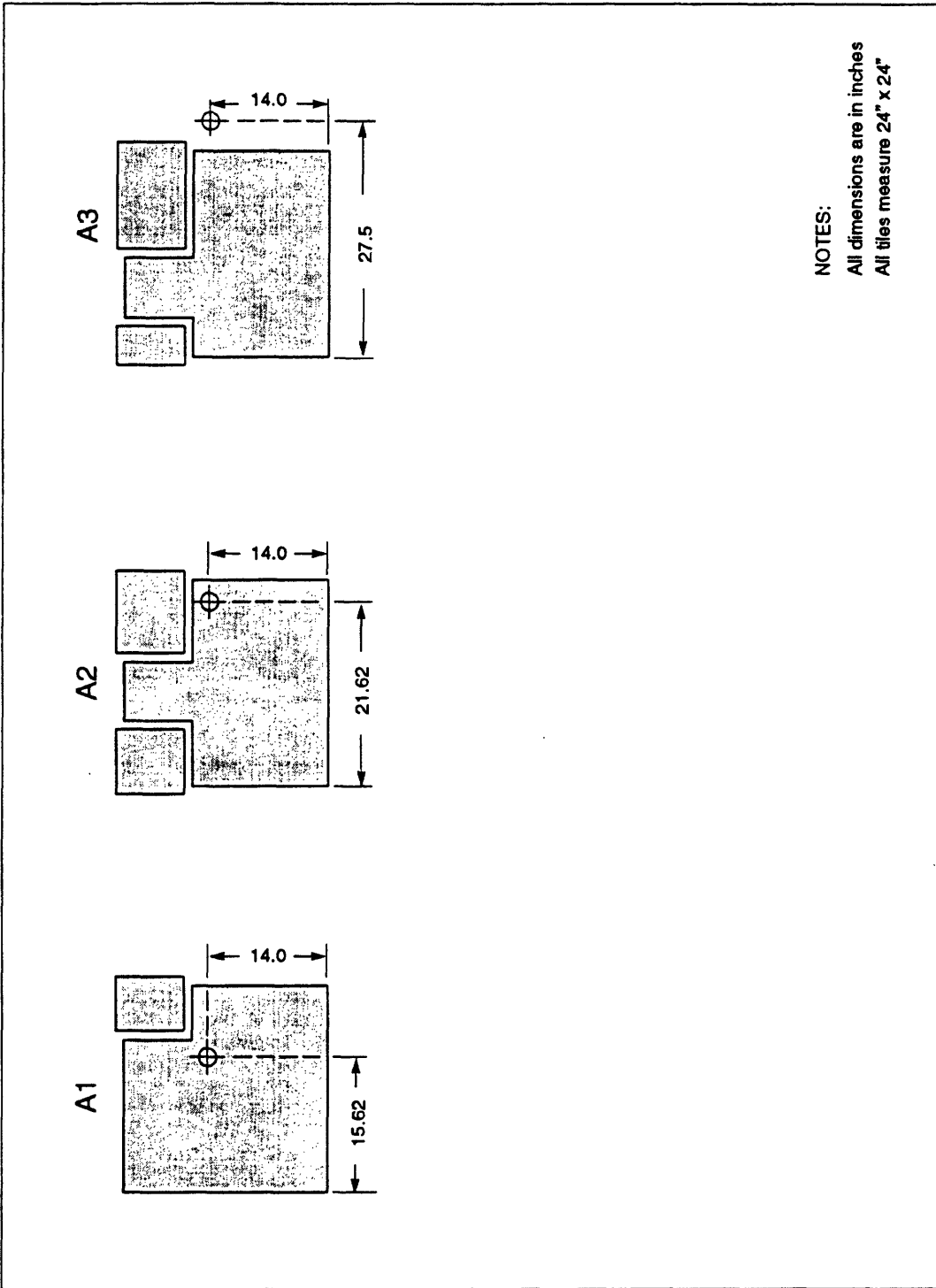

Figure 39. Support pedestal placement measurements
(drawing is not to scale)

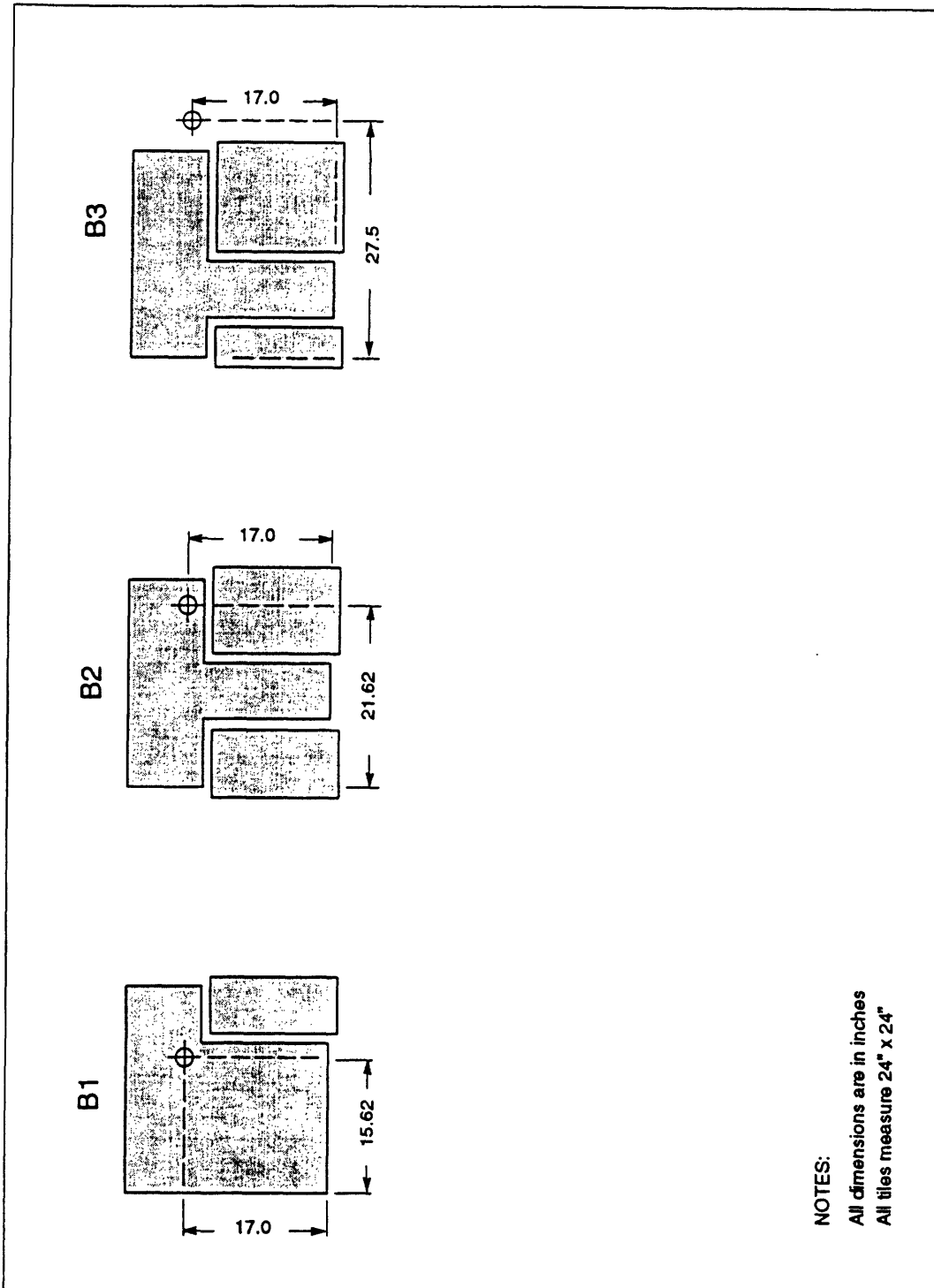

Figure 40. Support pedestal placement measurements
(drawing is not to scale)

CM-5 Site Preparation Guide

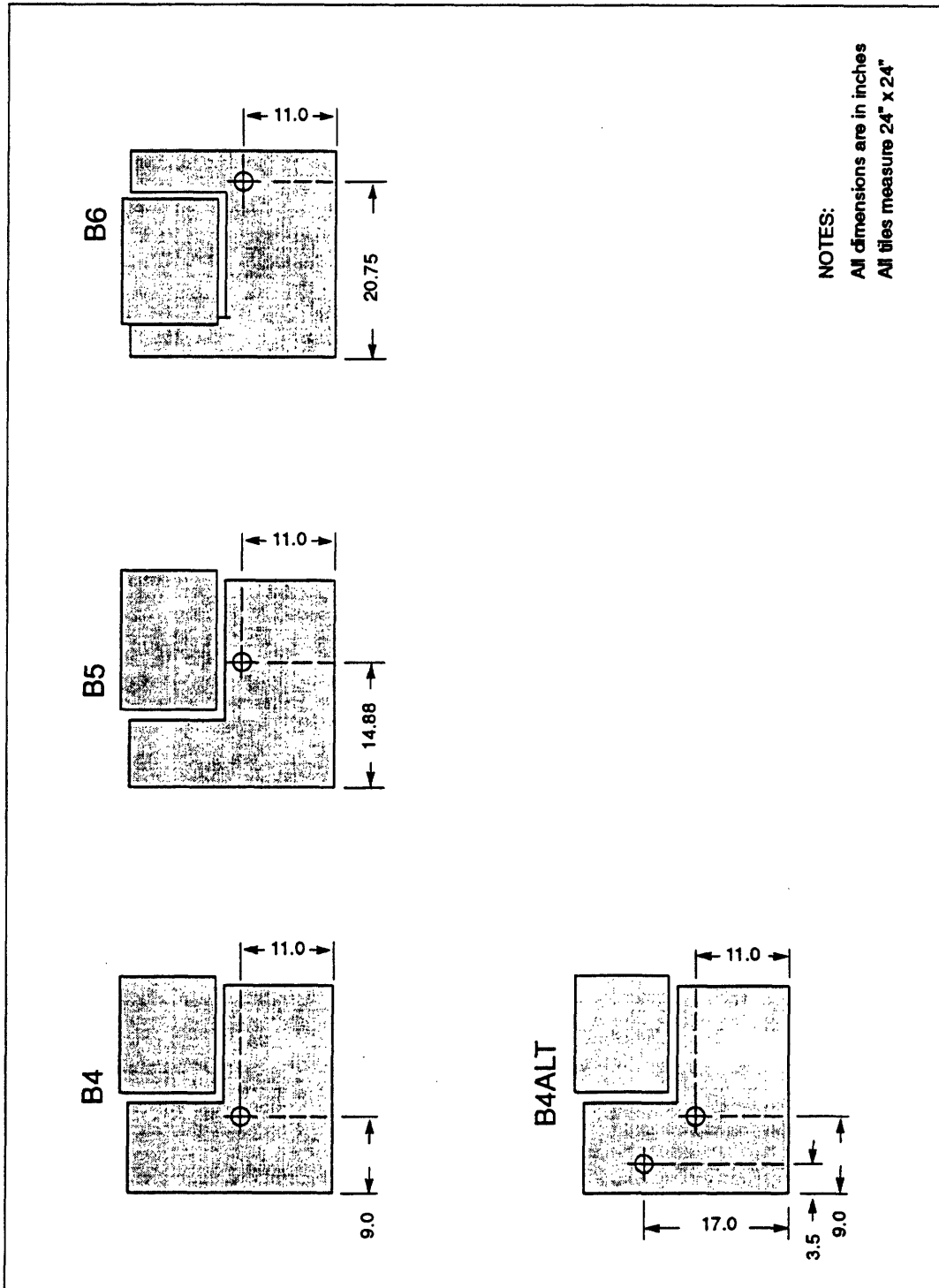

Figure 41. Support pedestal placement measurements
(drawing is not to scale)

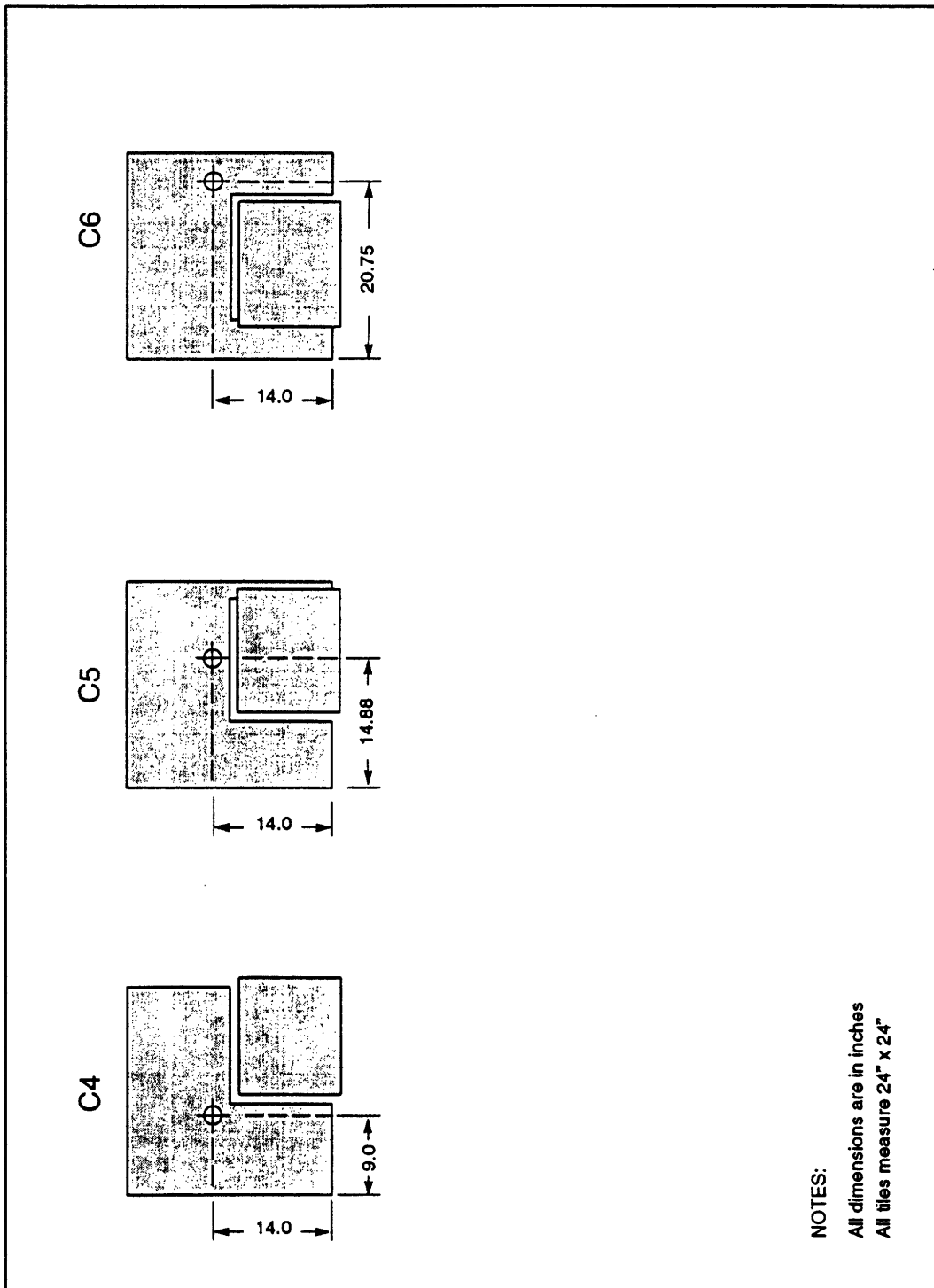

Figure 42. Support pedestal placement measurements
(drawing is not to scale)

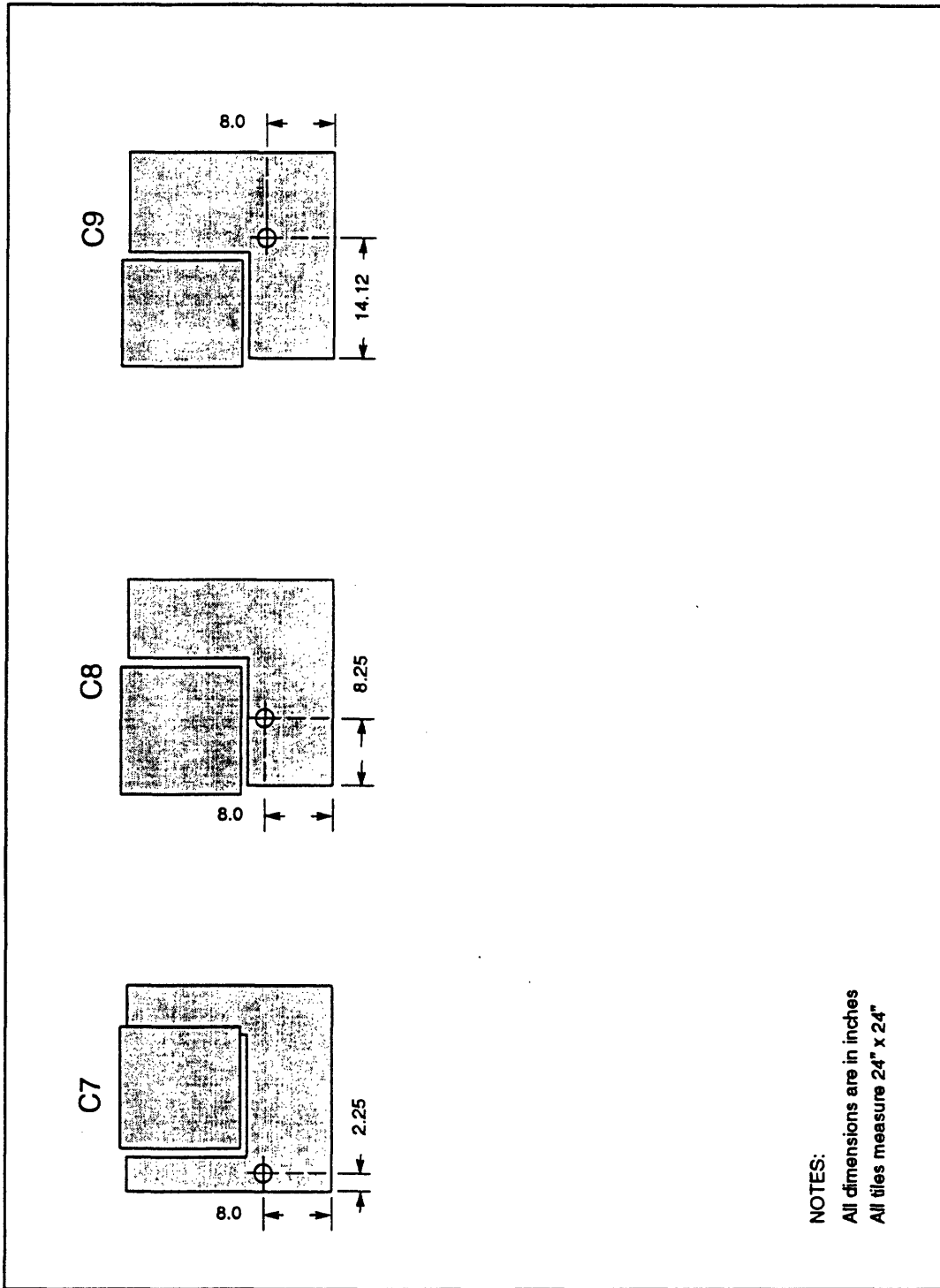

Figure 43. Support pedestal placement measurements
(drawing is not to scale)

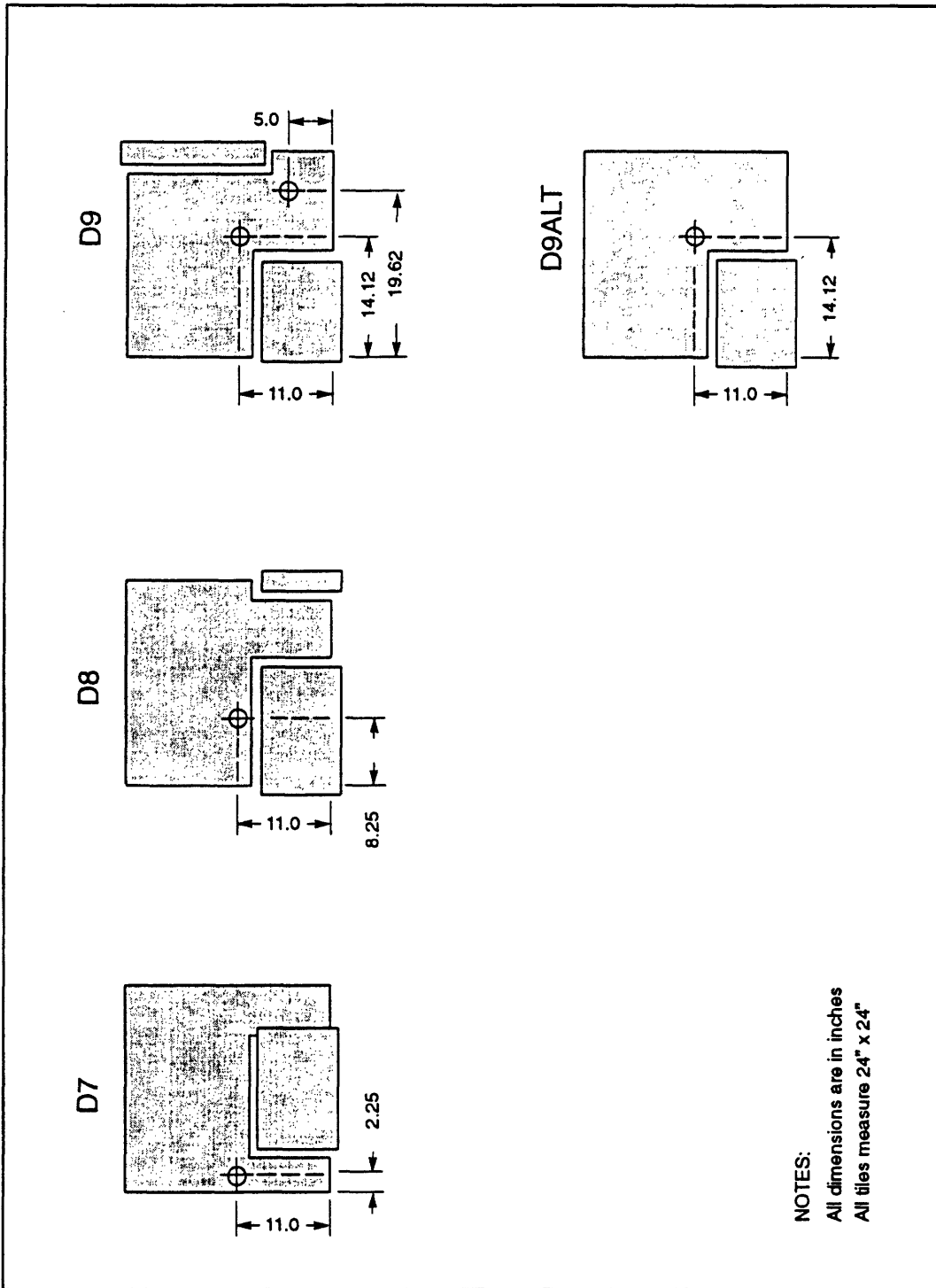
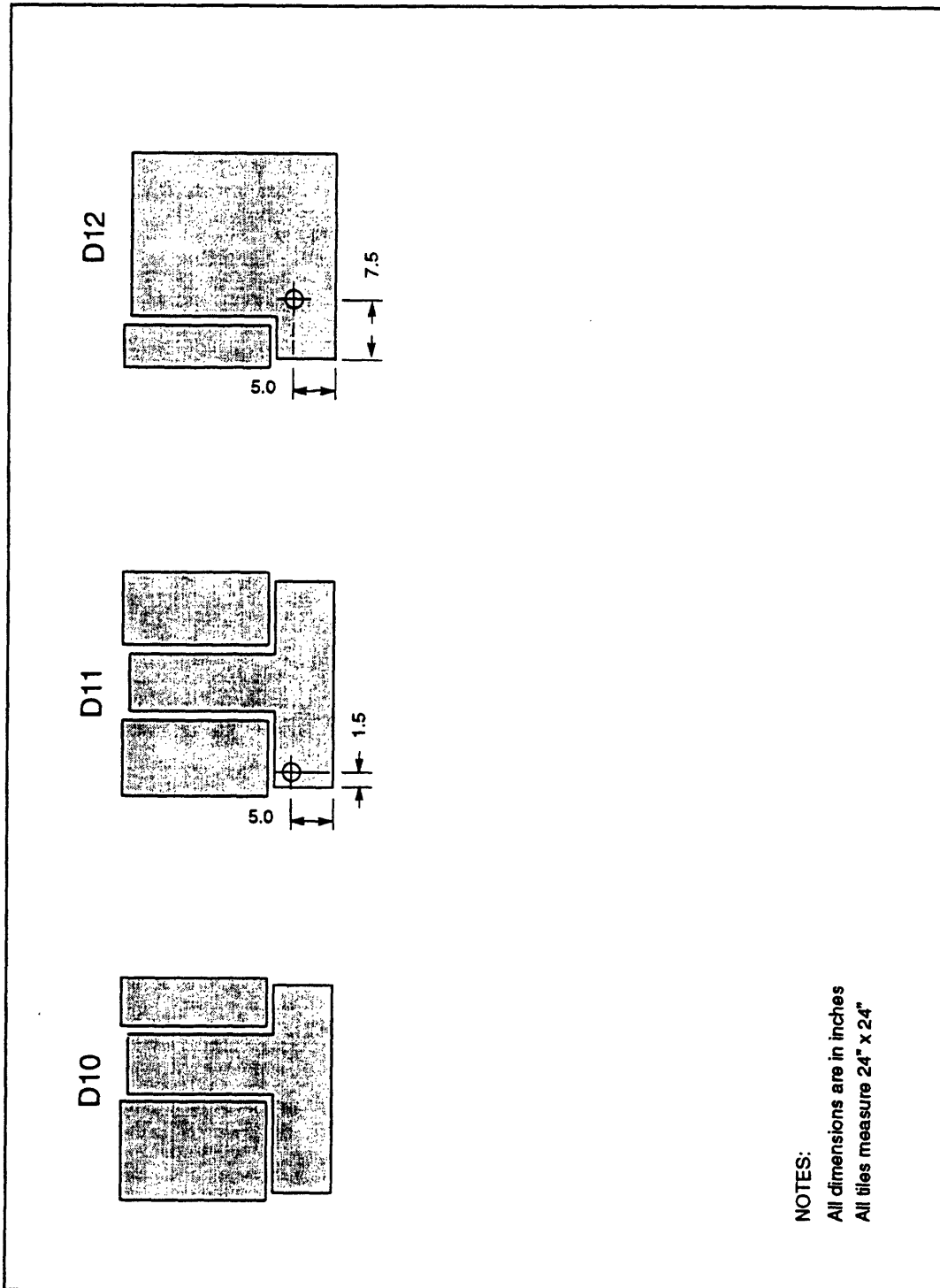

Figure 44. Support pedestal placement measurements
(drawing is not to scale)



NOTES:
All dimensions are in inches
All tiles measure 24" x 24"

Figure 45. Support pedestal placement measurements
(drawing is not to scale)

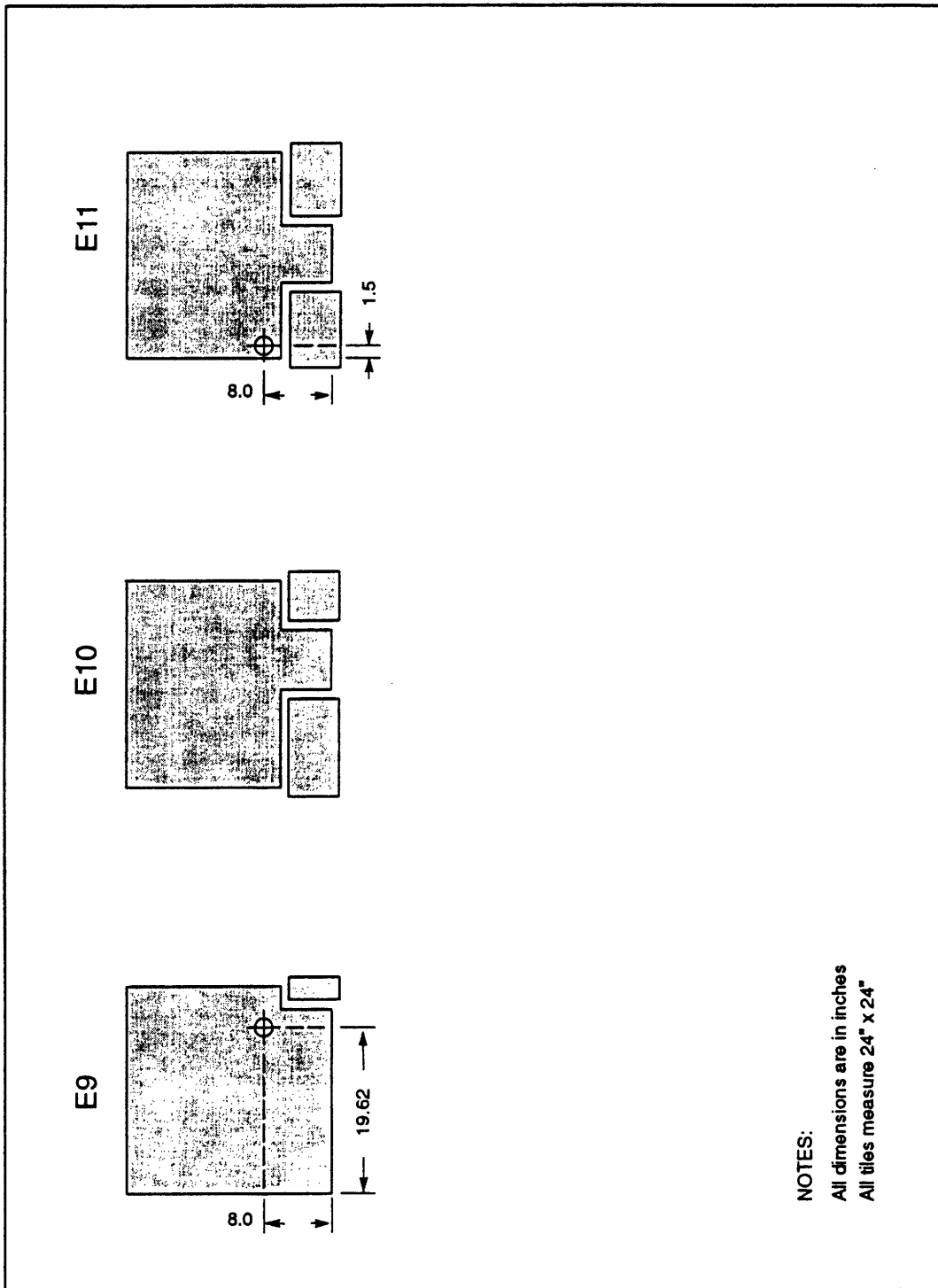
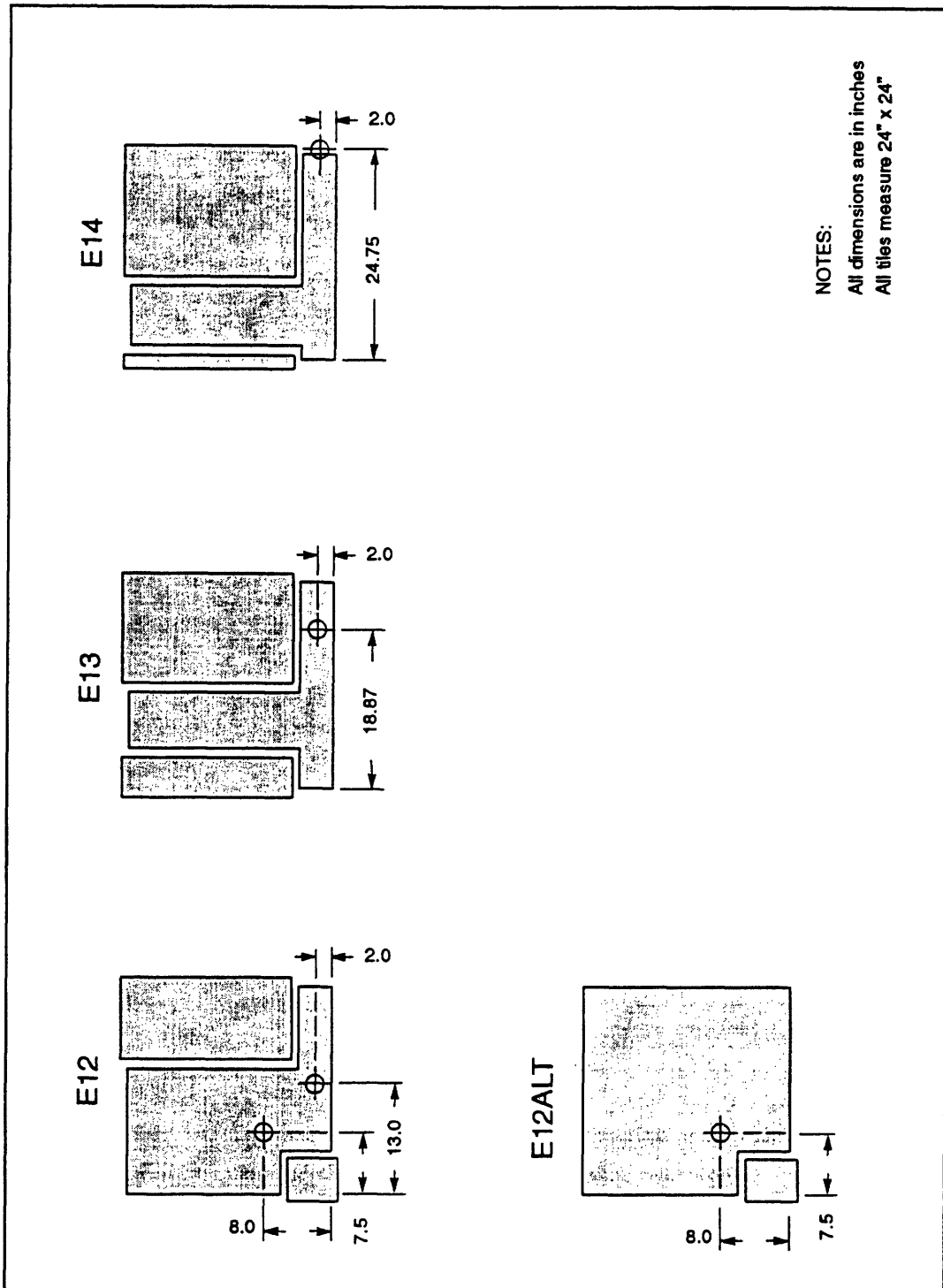

Figure 46. Support pedestal placement measurements
(drawing is not to scale)



NOTES:
 All dimensions are in inches
 All tiles measure 24" x 24"

Figure 47. Support pedestal placement measurements
 (drawing is not to scale)

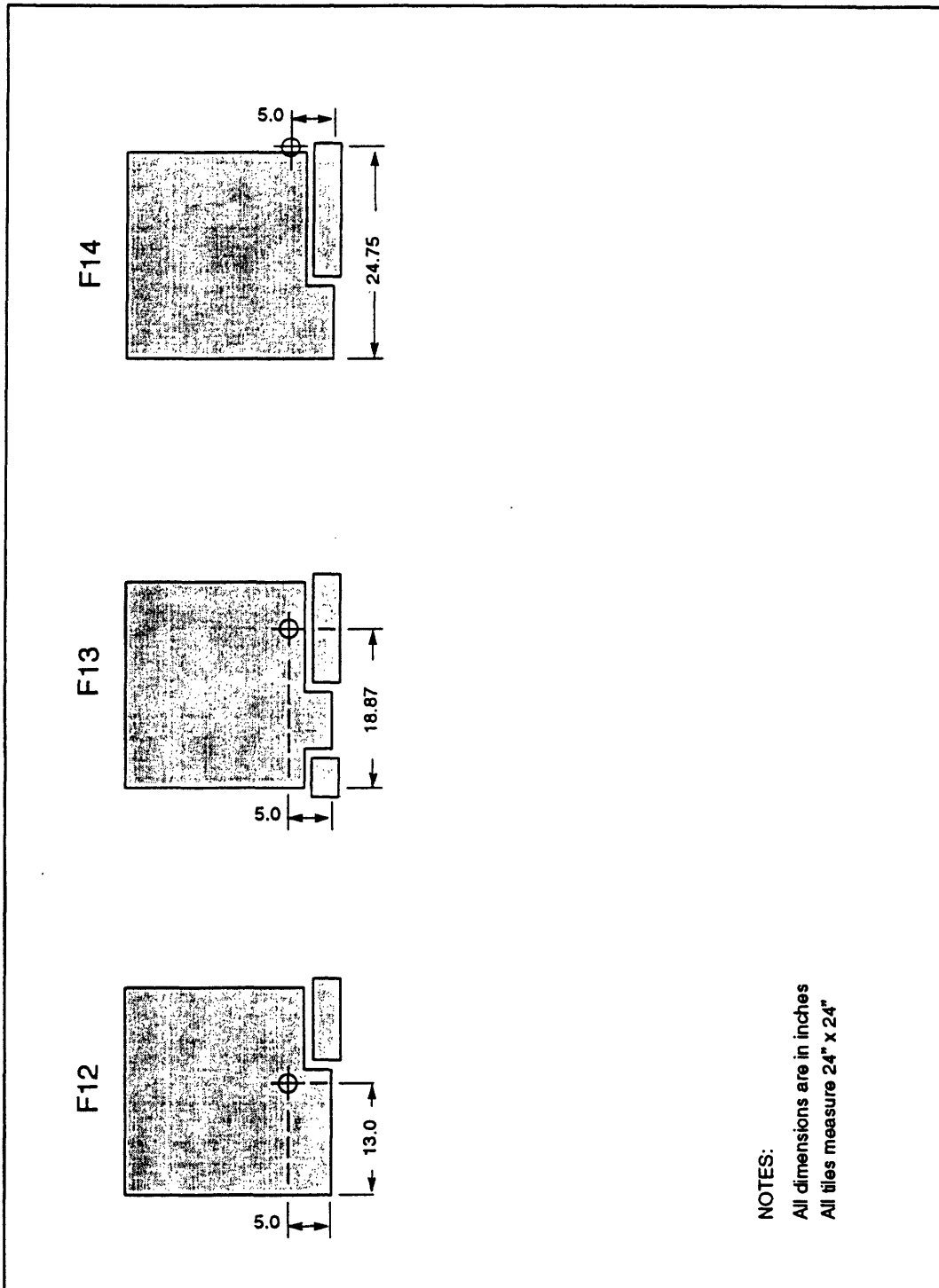

Figure 48. Support pedestal placement measurements
(drawing is not to scale)

Primary Power Wiring Requirements

Overview

Electrical installation of CM-5 cabinets must be performed by a properly trained and qualified installer. Failure to comply with this requirement could lead to severe injury from electrical shock to the installer, creation of a potential fire hazard.

Properly qualified installers are either specially trained and authorized Thinking Machines Corporation customer service personnel or professional electricians with licenses valid in the locale in which the installation will be performed. Installation must be performed in strict accordance with installation requirements given in this document and in compliance with local and national electrical codes. Failure to observe these requirements can lead to a fatal injury and/or damage to the equipment and its surroundings.

Warning

THE EQUIPMENT MAIN CIRCUIT BREAKER DOES NOT DISCONNECT BRANCH CIRCUIT POWER FROM THE FIELD WIRING TERMINALS.

Installers are warned that the field wiring terminals within the CM-5 cabinets are live whenever the branch circuit supplying power to the equipment is energized (ON). These terminals can be rendered safe only by disconnecting the device controlling power to the branch circuit.

Installers must be certain to disconnect (turn OFF) the branch circuit power before removing the access cover plate to the field wiring terminals. It is also essential that positive preventive action be taken to ensure that power to the branch circuit servicing the equipment cannot be inadvertently turned on while service personnel are working on the field wiring terminals.

Electrical Requirements, CM-5 Device Cabinets

The CM-5 Device Cabinet must be connected to a branch circuit rated for 3 phase, 5 wire, 100 Amp service. Connection must be by means of copper wire only, either #1/0 AWG or #2 AWG, with insulation rated for operation at 85° C, minimum.

Power terminals shall be torqued to 180 inch-pounds for #1/0 wire and to 150 inch-pounds for #2 wire. The grounding bolt must be torqued to 75 inch-pounds.

Electrical Requirements, CM-5 Network Cabinets

Electrical installation of the CM-5 Network Cabinet must be performed in the same manner as described above for the Device Cabinet, except that the conductor and torque specifications shall be as described in the next paragraph.

CM-5 Site Preparation Guide

The CM-5 Network Cabinet must be connected to a branch circuit rated for 3 phase, 5 wire, 60 Amp service. Connection must be by means of #8 AWG copper wire only, with insulation rated for operation at 85° C, minimum.

Power terminals shall be torqued to 30 inch-pounds, and the grounding bolt must be torqued to 40 inch-pounds.

Electrical Requirements, Device and Network Cabinets

The branch circuit must be protected by a properly sized overcurrent protection device, such as a fuse or circuit breaker. This device must be capable of interrupting the maximum short-circuit current deliverable by the source power system so as to clear a short circuit fault in the equipment before any damage is sustained by either the equipment or the branch circuit conductors.

Connection of the equipment cabinet to protective earth ground must be by means of the same size and type conductor as for the three live conductors and neutral.

Because of the high leakage currents associated with CM-5 equipment (both Device and Network Cabinets), a solidly connected earth ground conductor must be properly installed before power is applied to the equipment. Properly sized ground terminal lugs are provided in each cabinet for this purpose. Failure to properly connect the ground terminal can result in a fatal electrical shock to anyone touching the equipment cabinet.

The branch circuit wiring, including its overcurrent protection device and disconnect device, must be provided and installed by an appropriately licensed electrician only. Installation must be in accordance with all applicable electrical codes. Thinking Machines personnel shall not attempt to provide or install such wiring, even on a temporary basis.

The equipment field wiring terminals to which the branch circuit conductors are attached must be torqued to the specifications shown on the reverse side of the terminal access cover plate. Failure to do so can result in risk of fire and damage to the equipment. Note that torque specifications differ among cabinets, and that the torque specifications are different for power terminals and grounding studs. The installer is cautioned to follow the wiring specifications on the label inside the field wiring access cover plate.