

Compaq Deskpro EX and EXS

Illustrated Parts Map

Compaq Deskpro EX and EXS
Series of Personal Computers
Desktop Models



COMPAQ

©2000 Compaq Computer Corporation. COMPAQ and the Compaq logo Registered U.S. Patent and Trademark Office.

Microsoft, MS-DOS, Windows and other names of Microsoft products referenced herein are trademarks or registered trademarks of Microsoft Corporation.

Intel and Pentium are registered trademarks of Intel Corporation. MMX and Celeron are trademarks of Intel Corporation.

Product names mentioned herein may be trademarks and/or registered trademarks of their respective companies.

Part Number: 215877-001



Spare Part Number: 201857-001



Documentation (Not shown)

Description	Spare Part No.
<i>Maintenance & Service Guide</i>	201855-001
<i>Service Reference Guide</i>	152611-001
<i>Illustrated Parts Map</i>	201857-001
<i>Compaq Quick Troubleshooting Guide</i>	153837-001

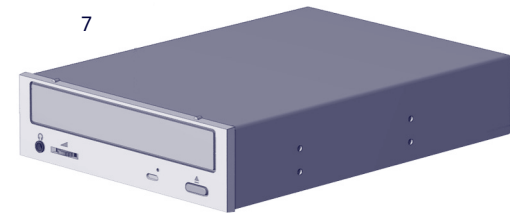
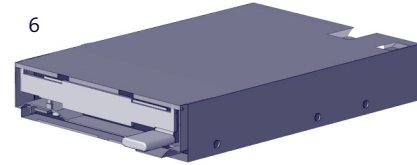
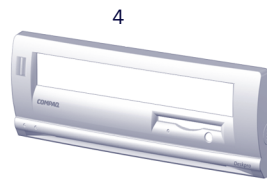
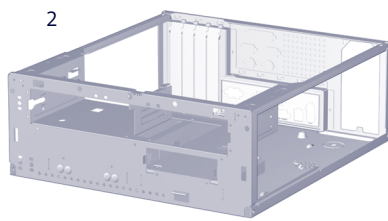
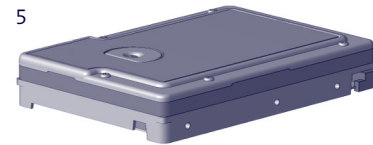
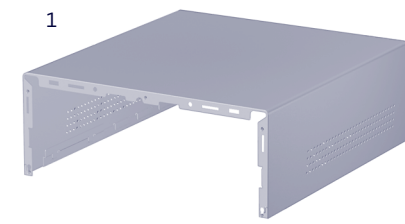

System Unit

Item	Description	Spare Part No.
1	Computer cover	Not spared
2	Chassis/basepan	Not spared
3	Power supply	201829-001
4	Front bezel	213434-001

Mass Storage Devices

Item	Description	Spare Part No.
5	10-GB Hard drive with (4) mounting screws	203139-001
*	15-GB Hard drive with (4) mounting screws	202903-001
6	Diskette drive, 3.5-inch	191714-001
7	48X CD-ROM drive	187263-001

*Not shown

Cables (Not shown)

Description	Spare Part No.
LED/power cable, 21"	222039-001
CD audio cable	149806-001
Dual connection cable, CD/hard drive, 18"	215392-001
Diskette drive cable, 15.5"	161735-001

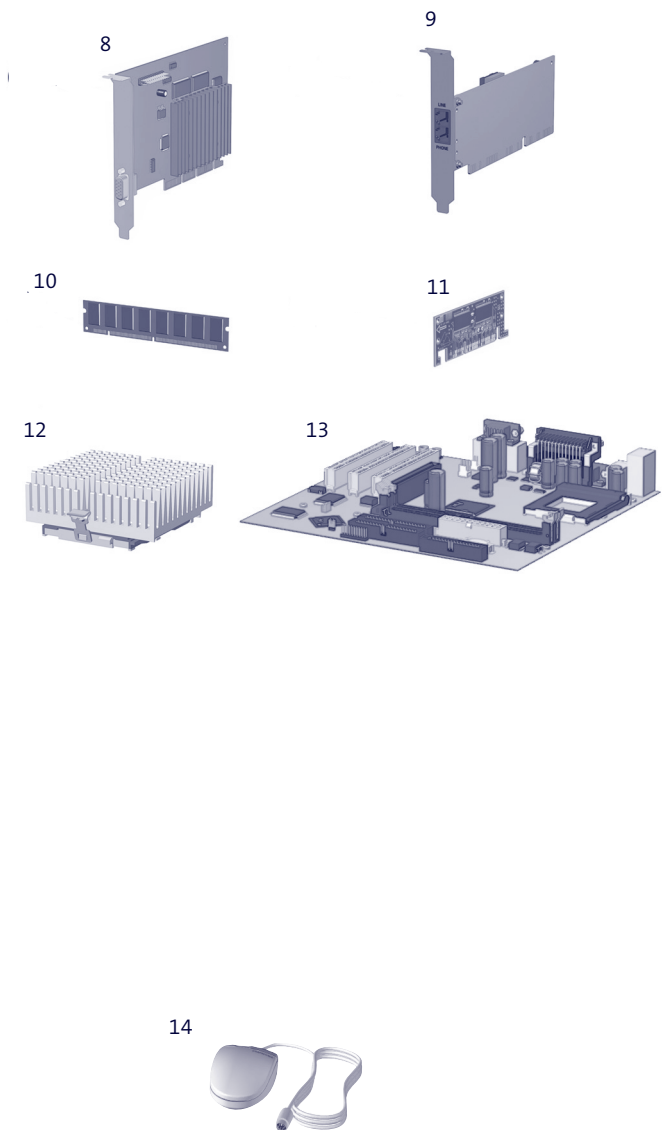

Standard and Optional Boards

Item	Description	Spare Part No.
8	Nvidia M64, 16MB SDRAM AGP Card	182757-001
*	Vanta LT 8MB SDRAM Graphics Card	201827-001
*	Mitac/Nvidia NV-15, 32MB Graphics Card	180284-001
9	10/100 PCI Network Interface Card	188297-001
	Memory Module (SDIMM, 133MHz)	
10	64MB	170080-001
*	128MB	170081-001
*	256MB	192014-001
11	AIMM (GPA) 4MB, 133MHz Graphics Card	192012-001
	Processor, Intel Pentium III	
12	566/66 MHz with heatsink (191832-001) and clip (223575-001)	203967-001
*	600/66 MHz with heatsink (191832-001) and clip (223575-001)	192011-001
*	667/66 MHz with heatsink (191832-001) and clip (223575-001)	192007-001
*	700/66 MHz with heatsink (191832-001) and clip (223575-001)	203968-001
*	733/133 MHz with heatsink (191832-001) and clip (223575-001)	192008-001
*	800/133 MHz with heatsink (191832-001) and clip (223575-001)	192009-001
*	866/133 MHz with fansink (191845-002). Fansink includes fan, heatsink, and clip.	192006-001
*	933/133 MHz with fansink (191845-002). Fansink includes fan, heatsink, and clip.	203969-001
13	System board	203966-001

*Not shown

Miscellaneous Parts

Item	Description	Spare Part No.
14	Mouse, scroll, opal	334689-002
*	Mouse, two-button, opal	166861-001

*Not shown

15



Miscellaneous Screw Kit (Not shown)

Description	Spare Part No.
Miscellaneous Screw Kit, includes:	179180-001
6-32 x 1/4 hi-top, thread-forming screw with serrations (5 ea.) (192308-001)	
6-19 x 5/16 panhead, plastite screw (4 ea.) (101346-068)	
6-19 x 5/16 hi-top, taptite screw with captive washer (4 ea.) (114399-069)	
6-32 x 3/16 hi-top, thread-forming screw with serrations (5 ea.) (192308-003)	
M3 x 5mm, hi-top, taptite screw with serrations (4 ea.) (247348-001)	
6-32 x 3/16 buttonhead tamper-resistant, taptite screw with serrations (3 ea.) (296769-002)	
6-32 x 5/16 hi-top, taptite screw (4 ea.) (109834-568)	
6-19 x 1/2 Panhead, plastite screw (5 ea.) (101346-071)	
Thumbscrew, molded cap (4 ea.) (179333-002)	

Keyboards

Item	Description	Spare Part No.
15	Easy Access Keyboard-US	123130-xxx
*	Spacesaver, Opal	269513-xxx
*	Dutch	-331
*	Finnish	-351
*	French	-051
*	International	-B31
*	Norwegian	-091
*	Spanish	-071
*	Swedish	-101
*	United Kingdom	-031
*	U.S.	-001

*Not shown