



**Technical Information Manual**

**IBM IntelliStation E Pro**

**Professional Workstation (Type 6893)**





# **Technical Information Manual**

**IBM IntelliStation E Pro**

**Professional Workstation (Type 6893)**

**Note**

Before using this information and the product it supports, be sure to read the general information under Appendix E, "Notices and Trademarks" on page 67.

**Second Edition (September 1998)**

**The following paragraph does not apply to the United Kingdom or any country where such provisions are inconsistent with local law:** INTERNATIONAL BUSINESS MACHINES CORPORATION PROVIDES THIS PUBLICATION "AS IS" WITHOUT WARRANTY OF ANY KIND, EITHER EXPRESS OR IMPLIED, INCLUDING, BUT NOT LIMITED TO, THE IMPLIED WARRANTIES OF MERCHANTABILITY OR FITNESS FOR A PARTICULAR PURPOSE. Some states do not allow disclaimer of express or implied warranties in certain transactions, therefore, this statement may not apply to you.

This publication could include technical inaccuracies or typographical errors. Changes are periodically made to the information herein; these changes will be incorporated in new editions of the publication. IBM may make improvements and/or changes in the product(s) and/or the program(s) described in this publication at any time.

This publication was developed for products and services offered in the United States of America. IBM may not offer the products, services, or features discussed in this document in other countries, and the information is subject to change without notice. Consult your local IBM representative for information on the products, services, and features available in your area.

Requests for technical information about IBM products should be made to your IBM reseller or IBM marketing representative.

© Copyright International Business Machines Corporation September 1998. All rights reserved.

Note to U.S. Government Users — Documentation related to restricted rights — Use, duplication or disclosure is subject to restrictions set forth in GSA ADP Schedule Contract with IBM Corp.

---

# Contents

<b>Preface</b> . . . . .	vii
Manual Style . . . . .	vii
Related Publications . . . . .	viii
<b>Chapter 1. System Overview</b> . . . . .	1
Hardware Features . . . . .	1
Software Features . . . . .	3
Wake on LAN . . . . .	3
Wake Up on Ring . . . . .	3
Alert on LAN . . . . .	3
Asset ID . . . . .	3
Network Enablement . . . . .	4
Operating System Support . . . . .	4
Euro Sign Support Information . . . . .	4
<b>Chapter 2. System Board Features</b> . . . . .	5
Microprocessor . . . . .	5
Pentium II Microprocessor with MMX Technology . . . . .	5
Chip Set Control . . . . .	5
L2 Cache . . . . .	6
System Memory . . . . .	6
Memory DIMM Options . . . . .	6
PCI Bus . . . . .	7
IDE Bus Master Interface . . . . .	7
PCI-to-ISA Bridge . . . . .	8
USB Interface . . . . .	8
Video Subsystem . . . . .	9
Matrox Millennium G200 AGP Graphics Adapter . . . . .	9
Matrox Millennium II AGP Graphics Adapter . . . . .	9
STB Glyder MAX-2+ AGP Graphics Adapter . . . . .	9
Audio . . . . .	11
Input/Output Controller . . . . .	12
Diskette Drive Interface . . . . .	12
Serial Ports . . . . .	12
Parallel Port . . . . .	12
Keyboard and Mouse Ports . . . . .	13
IntelliStation E Pro Network Connection . . . . .	13
Real-Time Clock and CMOS . . . . .	14
Flash EEPROM . . . . .	15
Riser Card . . . . .	15
Physical Layout . . . . .	16
System Board, Type 6893 . . . . .	16
System Board Switches . . . . .	16
Clear CMOS Request Jumper . . . . .	18
Riser Card . . . . .	18
Connector Panel . . . . .	20
<b>Chapter 3. Physical Specifications</b> . . . . .	21
SCSI Adapter . . . . .	22
Cabling Requirements for Wake on LAN Adapters . . . . .	22

<b>Chapter 4. Power Supply</b> . . . . .	23
Power Input . . . . .	23
Power Output . . . . .	23
Component Outputs . . . . .	24
Output Protection . . . . .	25
Connector Description . . . . .	25
<b>Chapter 5. System Software</b> . . . . .	26
BIOS . . . . .	26
Plug and Play . . . . .	26
POST . . . . .	26
Configuration/Setup Utility Program . . . . .	27
Advanced Power Management (APM) . . . . .	27
Advanced Configuration and Power Interface (ACPI) . . . . .	27
Flash Update Utility Program . . . . .	27
Diagnostic Programs . . . . .	27
<b>Chapter 6. IBM System Management Tools</b> . . . . .	28
Components of IBM System Management Tools . . . . .	28
DMI Service Provider . . . . .	28
DM BIOS Instrumentation . . . . .	28
IBM PC System Monitor . . . . .	29
IBM AssetCare . . . . .	30
IBM Alert On LAN . . . . .	35
IBM SMART Reaction Client . . . . .	36
SMART Reaction . . . . .	37
IBM SMART Reaction . . . . .	37
How SMART Reaction Responds to a Potential Problem . . . . .	38
SMART Reaction Restore Process . . . . .	39
Critical Data Mirroring . . . . .	39
Intel LANDesk Client Manager . . . . .	39
Advanced Configuration and Power Interfaces (ACPI) . . . . .	40
Wake on LAN . . . . .	40
Wake on LAN components . . . . .	40
How Wake on LAN works . . . . .	41
Definition of the Wake-up Frame . . . . .	41
Give your IntelliStations a wake-up call . . . . .	42
IBM LANClient Control Manager version 2.0 (LCCM) . . . . .	42
System Deployment . . . . .	43
Flashing the CMOS or BIOS . . . . .	44
Installing Software . . . . .	44
LCCM New Client Scenario . . . . .	44
Low-level Management . . . . .	45
<b>Chapter 7. System Compatibility</b> . . . . .	46
Hardware Compatibility . . . . .	46
Hardware Interrupts . . . . .	47
Diskette Drives and Controller . . . . .	48
Hard Disk Drives and Controller . . . . .	49
Software Compatibility . . . . .	49
Software Interrupts . . . . .	49
Machine-Sensitive Programs . . . . .	49
<b>Appendix A. Connector Pin Assignments</b> . . . . .	50

Memory Connectors	50
ISA Connectors	52
PCI Connectors	53
IDE Connectors	55
Diskette Drive Connector	56
Power Supply Connector	56
Modem/Ring Wakeup and Wake on LAN Connectors	57
Alert on LAN Connector	57
RFID Connector (Asset ID)	57
Fan Connector	58
USB Port Connectors	58
Mouse and Keyboard Port Connectors	58
Serial Port Connectors	59
Parallel Port Connector	59
Monitor Port Connector	60
Ethernet Connector	60
<b>Appendix B. System Address Maps</b>	<b>61</b>
System Memory Map	61
Input/Output Address Map	61
DMA I/O Address Map	63
PCI Configuration Space Map	64
<b>Appendix C. IRQ and DMA Channel Assignments</b>	<b>65</b>
<b>Appendix D. Error Codes</b>	<b>66</b>
POST Error Codes	66
Beep Codes	66
<b>Appendix E. Notices and Trademarks</b>	<b>67</b>
Year 2000 Readiness and Instructions	67
<b>References</b>	<b>69</b>
<b>Index</b>	<b>70</b>

---

## Figures

1.	Memory Configurations	7
2.	Serial Port Assignments	12
3.	Parallel Port Assignments	13
4.	Riser Card Characteristics	15
5.	Microprocessor Speed (Switches 1-4)	16
6.	ROM Recovery (Switch 5)	17
7.	System Board Ethernet Control (Switch 6)	17
8.	Privileged Access Password Control (Switch 7)	17
9.	Diskette Drive Device Access (Switch 8)	18
10.	Clear CMOS Request Jumper (J9)	18
11.	Power Input Requirements	23
12.	Power Output (145 Watt)	23
13.	System Board	24
14.	Keyboard Port	24
15.	Auxiliary Device Port	24
16.	ISA-Bus Adapters (Per Slot)	24
17.	PCI-Bus Adapters (Per Slot) either/or	24
18.	USB Port	24
19.	Internal SCSI Drives	25
20.	Enhanced Asset Information Area	31
21.	Device Types	32
22.	Serialization Information Area Header	34
23.	User Information Area Header	34
24.	Configuration Information Area Header	34
25.	5.25-Inch Diskette Drive Reading, Writing, and Formatting Capabilities	48
26.	3.5-Inch Diskette Drive Reading, Writing, and Formatting Capabilities	48
27.	System Memory Connector Pin Assignments	50
28.	ISA Connector Pin Assignments	52
29.	PCI Bus Connector	53
30.	PCI Connector Pin Assignments	53
31.	IDE Connector Pin Assignments	55
32.	Diskette Drive Connector Pin Assignments	56
33.	Power Supply Connector Pin Assignments	56
34.	J13 Modem/Ring Wakeup Connector Pin Assignments	57
35.	J22 Wake on LAN Connector Pin Assignments	57
36.	J12 Alert on LAN Connector Pin Assignments	57
37.	J5 Asset ID Connector Pin Assignments	57
38.	J14 Front Fan Connector Pin Assignments	58
39.	USB Port Connector Pin Assignments	58
40.	Mouse and Keyboard Port Connector Pin Assignments	58
41.	Serial Port Connectors Pin Assignments	59
42.	Parallel Port Connector Pin Assignments	59
43.	Monitor Connector Pin Assignments	60
44.	Ethernet Connector	60
45.	Pin Assignments for the Ethernet Connector	60
46.	System Memory Map	61
47.	I/O Address Map	61
48.	DMA I/O Address Map	63
49.	IRQ Channel Assignments	65
50.	DMA Channel Assignments	65



---

## Preface

This publication provides information for the IBM IntelliStation E Pro. It is intended for developers who want to provide hardware and software products to operate with this computer. It offers the details of how the computer works. Users of this publication should have an understanding of computer architecture and programming concepts.

---

## Manual Style

In this manual, some signals are represented in a small, all-capital-letter format (-ACK). A minus sign in front of the signal indicates that the signal is active low. No sign in front of the signal indicates that the signal is active high.

The use of the term *hex* indicates a hexadecimal number. Also, when numerical modifiers such as “K”, “M” and “G” are used, they typically indicate powers of 2, not powers of 10. For example, 1 KB equals 1 024 bytes ( $2^{10}$ ), 1 MB equals 1 048 576 bytes ( $2^{20}$ ), and 1 GB equals 1 073 741 824 bytes ( $2^{30}$ ).

When expressing storage capacity, MB equals 1 000 KB (1 024 000). The value is determined by counting the number of sectors and assuming that every two sectors equals 1 KB.

**Note:** Depending on the operating system and other system requirements, the storage capacity available to the user might vary.

**Attention!** The term *reserved* describes certain signals, bits, and registers that should not be changed. Use of reserved areas can cause compatibility problems, loss of data, or permanent damage to the hardware. When the contents of a register are changed, the state of the reserved bits must be preserved. When possible, read the register first and change only the bits that must be changed.

---

## Related Publications

In addition to this manual, the following IBM publications provide information related to the operation of the IBM IntelliStation E Pro. To order publications in the U.S. and Puerto Rico, call 1-800-879-2755. In other countries, contact an IBM reseller or an IBM marketing representative.

- *IntelliStation E Pro User Guide*  
This hardcopy publication comes with your computer and is also available on the *Ready-to-Configure Utility Program CD* that comes with your computer. It contains information on setting up, configuring, operating, and maintaining your computer. Also included are warranty information, instructions for diagnosing and solving problems, and information on how to obtain help and service.
- *Installing Options in Your IntelliStation E Pro*  
This publication contains instructions for installing options in the computer. It is available in Adobe® .PDF format on the *Ready-to-Configure Utility Program CD* that comes with your computer as well as on the World Wide Web at:  
<http://www.pc.ibm.com/support>
- *Understanding Your IntelliStation E pro*  
This online document, available on the *Ready-to-Configure Utility Program CD* that comes with your computer, includes general information about using computers and detailed information about the features of the IntelliStation E Pro.
- *About Your Software*  
This publication (provided only with computers that have IBM-preinstalled software) contains information about the preinstalled software package.
- *Hardware Maintenance Manual*  
This publication contains information for trained service technicians. It is available on the World Wide Web at :  
<http://www.pc.ibm.com/support>  
It can also be ordered from IBM. To purchase a copy, refer to the "Getting Help, Service, and Information" section in the *IntelliStation E Pro User Guide*.
- *Advanced Management Documentation*  
These publications contain information for network administrators who configure and service local area networks (LANs). It is available on the World Wide Web at :  
[http://www.pc.ibm.com/us/ibmpc/tech\\_library.htm](http://www.pc.ibm.com/us/ibmpc/tech_library.htm)
- *Adaptec SCSI Documentation*  
These publications are provided with computer models that have an IBM-installed SCSI adapter. They include information on configuring the SCSI adapter and instructions for installing and configuring SCSI devices. Look for these publications on the *Ready-to-Configure Utility Program CD* that comes with your computer.

---

## Chapter 1. System Overview

The IntelliStation E Pro is a versatile product designed to provide state-of-the-art computing power with room for future growth.

---

### Hardware Features

The major features are:

- An Intel® Pentium® II microprocessor with MMX™ technology and 100 MHz Front Side Bus (FSB) and 512 KB of L2 cache with ECC
- Up to 768 MB of SDRAM system memory with ECC
- Integrated IDE bus master controller, ultra DMA/33 capable
- Preinstalled Adaptec Ultra Wide SCSI adapter (on some models)
- SCSI hard disk drive (on models with the Adaptec adapter)
- EIDE hard disk drive, 7200 rpm (on some models)
- System management
  - Wake on LAN support
  - Alert on LAN support
  - DMI (Desktop Management Interface) BIOS and DMI software
  - System management controller
  - Integrated network protocols
  - Enablement for remote administration
  - Asset ID support
  - IBM System Management Tools
- 32X Max IDE CD-ROM drive<sup>1</sup>
- Asset security
  - Security settings provided by the Configuration/Setup Utility Program
    - Power-on and administrator password protection
    - Startup-sequence control
    - Hard disk drive and diskette drive access control
    - I/O port control
    - Enhanced security for administrator password and startup sequence
  - Chassis-intrusion detector
  - Cover lock
  - U-bolt and security cabling (optional)
  - Operating system security
  - Diskette write-protection

---

<sup>1</sup> Variable read rate. Actual playback speed will vary and is often less than the maximum possible.

## Chapter 1. System Overview

- Video adapter
  - Matrox Millennium G200 AGP Graphics Adapter (some models only)
  - Matrox Millennium II AGP Graphics Adapter (some models only)
  - STB Glyder MAX-2+ AGP Graphics Adapter (some models only)
- Integrated 16-bit, stereo audio controller and built-in high quality speaker (supports SoundBlaster, Adlib, and Microsoft Windows Sound System applications)
- Integrated Ethernet controller and connector with Wake on LAN
- Token Ring Adapter
  - IBM PCI Token-Ring adapter with Wake on LAN is optional
- Expansion
  - Four drive bays, four expansion slots (one ISA, two PCI, and one shared ISA/PCI)
  - AGP expansion slot, used for graphics adapter
- ISA/PCI I/O-bus compatibility
- Industry-standard compatibility
- EnergyStar compliance
- 3.5-inch, 1.44 MB diskette drive
- Input/Output Features
  - One 25-pin, ECP/EPP parallel port
  - Two 9-pin, UART serial ports
  - Two 4-pin, USB ports
  - One 6-pin, keyboard port
  - One 6-pin, mouse port
  - One 15-pin, DDC2B-compliant monitor port
  - Three 3.5 mm audio jacks (line out, line in, microphone)

---

## Software Features

The following features are supported by the IBM IntelliStation E Pro.

### Wake on LAN

The power supply of the computer supports the Wake on LAN feature. With the Wake on LAN feature, the computer can be turned on when a specific LAN frame is passed to the PC over the LAN.

To use the Wake on LAN feature, the computer must be equipped with a network subsystem that supports Wake on LAN.

The menu used for setting the Wake on LAN feature is found in the Configuration/Setup Utility Program.

### Wake Up on Ring

All models are configurable to turn on the computer after a ring is detected from an external or internal modem. The menu used for setting the Wake Up on Ring feature is found in the Configuration/Setup Utility Program. Two options control this feature:

- **Serial Ring Detect:** Use this option if the computer has an external modem connected to the serial port.
- **Modem Ring Detect:** Use this option if the computer has an internal modem.

### Alert on LAN

The IntelliStation E Pro features Alert on LAN, a product of the IBM/Intel Advanced Manageability Alliance. Alert on LAN can notify you when a system has been tampered with or removed from the network. This new feature is part of the IBM AssetCare, which also includes other innovations such as SMART Reaction data protection software.

### Asset ID

The Asset ID feature uses radio-frequency technology to read and write an EEPROM inside your computer. The radio-frequency interface includes an Asset ID antenna inside the computer that enables communications between industry-standard radio-frequency devices and your computer EEPROM. The information in the EEPROM includes configuration data and serial numbers of key components. There are also blank fields that can be recorded with the users choice of information. This information can be used to track the movement of the computer for inventory and security purposes. The menu used for enabling the Asset ID feature is found in the Configuration/Setup Utility Program. For more information about Asset ID information, see "IBM AssetCare" on page 30 and "Asset ID" on page 35.

### Network Enablement

The IntelliStation E Pro is enabled to support management over a network. The following is a list of functions that are supported:

- Selectable startup sequence
- Selectable Automatic Power On Startup Sequence
- Update POST/BIOS from network
- Wake on LAN
- CMOS Save/Restore utility program
- CMOS setup over LAN
- Alert on LAN
- Wake Up on Ring

### Operating System Support

Although a variety of operating systems can be used with IntelliStation E Pro computers, full function is provided only with Windows NT 4.0. (Some models also fully support Windows 95, Windows 98, and Windows NT 3.5.) When operating systems other than these are used, the IntelliStation E Pro will work, but without all of the advanced functions. For a list of operating systems that are compatible with the IntelliStation E Pro, refer to the *About Your Software* and the IBM online compatibility report on the World Wide Web at [http://www.pc.ibm.com/us/intellistation/tech\\_library.html](http://www.pc.ibm.com/us/intellistation/tech_library.html).

**Note:** Windows NT 4.0 and various support programs are preinstalled in some IntelliStation E Pro computers. Refer to *About Your Software* for a detailed description of the preinstallation package. Also, a *Ready-to-Configure Utility Program CD* is included with all models. The *Ready-to-Configure Utility Program CD* contains applications and device driver support for the preinstalled operating system (if applicable), and several other operating systems.

### Euro Sign Support Information

The *Euro Sign* is the name given to the proposed currency symbol of the European Union. According to the European Commission, the Euro will exist as a currency beginning 1 January 1999, but will only gradually move into general use with the introduction of coins and notes in 2002.

IBM and various other personal computer industry companies plan to support the Euro Sign on products released in 1999. For support information on products released prior to that date, see the appropriate Web site for your product.

For your computer to support the Euro Sign, a proper combination of both hardware (computer, keyboard, and printer) and software (operating systems, application programs, and device drivers) is required.

There are many Web sites that provide Euro Sign information and support (some are listed below). First, determine the computer hardware and software you are using. Then, visit the Web sites that apply to your system for the latest Euro Sign information and support. In many cases, updates are available for Euro Sign support. These updates can be downloaded and installed on your computer.

- <http://www.adobe.com>
- <http://www.ibm.com>
- <http://www.microsoft.com/europe/euro>  
(The "euro product update" is available for Windows 95 and Window NT)

---

## Chapter 2. System Board Features

This section includes information about system board features. For an illustration of the system board, see "System Board, Type 6893" on page 16.

---

### Microprocessor

The IntelliStation E Pro comes with an Intel Pentium II microprocessor with MMX technology. The microprocessor, which has a heat sink attached, plugs directly into a connector on the system board. For information on replacing a microprocessor or installing an upgrade, refer to *Installing Options in Your IntelliStation E Pro*.

### Pentium II Microprocessor with MMX Technology

The features of this microprocessor are as follows:

- Optimization for 32-bit software
- Operation at a lower voltage level than previous microprocessors
- 64-bit microprocessor data bus
- 100 MHz FSB
- 512 KB L2 cache with ECC
- 32-bit microprocessor address bus
- Math coprocessor
- MMX technology, which boosts the processing of graphic, video, and audio data
- L2 cache integrated into the microprocessor
  - 4-way set associative
  - Nonblocking
  - 50-percent processor speed performance increase over placement of L2 cache on the system board

More information on these microprocessors is available at <http://www.intel.com> on the World Wide Web.

---

### Chip Set Control

Two components, the Intel 440BX and PIIX4E, make up the chip set that is the interface between the microprocessor and the following:

- Memory subsystem
- PCI bus
- Busmaster IDE connection
- High-performance, PCI-to-ISA bridge
- USB ports
- SMBus
- AGP bus
- Enhanced DMA controller
- RTC

### L2 Cache

The IntelliStation E Pro computer is equipped with a Pentium II microprocessor with MMX technology and 512 KB of L2 cache. The L2 cache ECC function is automatically enabled when ECC memory is installed. If nonparity memory is installed, the L2 cache ECC is disabled. (For information on overriding these settings, refer to Configuration/Setup Utility Program in the *IntelliStation E Pro User Guide*.)

### System Memory

The system memory interface is controlled by the 440BX chip set. Synchronous dynamic random access memory (SDRAM) is standard.

The maximum amount of system memory is 768 MB. For memory expansion, the system board provides three dual inline memory module (DIMM) connectors. DIMM sizes of 16MB, 32MB, 64MB, 128MB, and 256MB with a speed of 100 MHz are supported. The amount of memory preinstalled varies by model.

### Memory DIMM Options

#### Important

Be sure to observe the following guidelines when adding memory DIMM options to your computer.

- The IntelliStation E Pro does not support EDO memory.
- Only 168-pin, 100 MHz, 3.3v industry standard memory DIMMs are supported.
- There are two types of memory DIMMs available for the IntelliStation E Pro computer: *Registered Memory* technology and *Unregistered Memory* technology.
- Registered Memory DIMMs are not compatible with Unregistered Memory DIMMs.
- The 256 MB ECC Memory DIMM is *Registered Memory* technology.
- Only the 256 MB ECC Registered Memory DIMM (IBM OBI Part Number 01K1132) is supported on the IntelliStation E Pro computer.
- The 16 MB, 32 MB, 64 MB, and 128 MB DIMMs are *Unregistered Memory* technology.
- When adding additional memory DIMMs, be sure that all installed memory DIMMs are of the same type. For example:
  - All installed DIMMs are Registered Memory
  - or –
  - All installed DIMMs are Unregistered Memory

For information on the pin assignments for the memory module connectors, see “Memory Connectors” on page 50.

The following figure shows some possible configurations for the supported DIMMs.

**Note:** Values in the following table are represented in megabytes (MB).



Figure 1. Memory Configurations

Total Memory (MB)	Mem 0	Mem 1	Mem2
16	16	0	0
32	16	16	0
32	32	0	0
48	16	16	16
48	32	16	0
64	32	16	16
64	32	32	0
64	64	0	0
96	32	32	32
96	64	32	0
128	64	32	32
128	64	64	0
128	128	0	0
160	32	64	64
192	64	64	64
224	32	64	128
256	256	0	0
256	128	64	64
256	128	128	0
288	32	128	128
384	128	128	128
768	256	256	256

## PCI Bus

The fully synchronous 33 MHz PCI bus originates in the chip set. Features of the PCI bus are:

- Integrated arbiter with multi-transaction PCI arbitration acceleration hooks for high performance graphics
- Built-in PCI bus arbiter with support for up to five masters
- Microprocessor-to-PCI memory write posting with 5-Dword-deep buffers
- Converts back-to-back sequential microprocessor-to-PCI memory write to PCI burst write
- PCI-to-DRAM posting 18 Dwords
- PCI-to-DRAM up to 100+ MB/sec bandwidth
- Multitranaction timer to support multiple short PCI transactions within one PCI ARB cycle
- PCI 2.1 compliant
- Delayed transaction
- PCI parity checking and generation support

## IDE Bus Master Interface

The system board incorporates a PCI-to-IDE interface that complies with the *AT Attachment Interface with Extensions*.

The Intel PIIX4E functions as a *bus master* for the IDE interface. The chip set is PCI 2.1 compliant; it connects directly to the PCI bus and is designed to allow concurrent operations on the PCI bus and IDE

## Chapter 2. System-Board Features

bus. The chip set is capable of supporting PIO mode 0–4 devices and IDE DMA mode 0–2 devices, ultra DMA 33 transfers up to 33 Mbytes/sec.

The IDE devices receive their power through a four-position power cable containing +5 V dc, +12 V dc, and ground. When adding devices to the IDE interface, one device is designated as the master device and another is designated as the slave or subordinate device. These designations are determined by switches or jumpers on each device. There are two IDE ports, one designated 'Primary' and the other 'Secondary,' allowing for up to four devices to be attached. The total number of physical IDE devices is dependent on the mechanical package.

For the IDE interface, no resource assignments are given in the system memory or the direct memory access (DMA) channels. For information on the resource assignments, see “Input/Output Address Map” on page 61 and Figure 49 on page 65 (for IRQ assignments).

Two connectors are provided on the riser for the IDE interface. For information on the connector pin assignments, see “IDE Connectors” on page 55.

### PCI-to-ISA Bridge

On the system board, the Intel PIIX4E provides the interface between the peripheral component interface (PCI) and industry standard architecture (ISA) buses. The chip set is used to convert PCI bus cycles to ISA bus cycles; the chip set also includes all the subsystems of the ISA bus, including two cascaded interrupt controllers, two DMA controllers with four 8-bit and three 16-bit channels, three counters equivalent to a programmable interval timer, and power management. The PCI bus operates at 33 MHz. The ISA bus operates at 8.25 MHz.

For the ISA bus, no resource assignments are given in the system memory or the DMA channels. For information on resource assignments, see “Input/Output Address Map” on page 61 and Figure 49 on page 65 (for IRQ assignments).

### USB Interface

Universal serial bus (USB) technology is a standard feature of the computer. Using the chip set, the system board provides the USB interface with two connectors. A USB-enabled device can attach to each connector, and if that device is a hub, multiple peripherals can attach to the hub and be used by the system. The USB connectors use Plug and Play technology for installed devices. The speed of the USB is up to 12 MB/sec with a maximum of 127 peripherals. The USB is compliant with Universal Host Controller Interface Guide 1.0.

Features provided by USB technology include:

- Support for hot pluggable devices
- Support for concurrent operation of multiple devices
- Suitable for different device bandwidths
- Support for up to five meters length from host to hub or from hub to hub
- Guaranteed bandwidth and low latencies appropriate for specific devices
- Wide range of packet sizes
- Limited power to hubs

For information on the connector pin assignments for the USB interface, see “USB Port Connectors” on page 58.

---

## Video Subsystem

The video subsystem on the system board includes one of the following:

- Matrox Millennium G200 AGP Graphics Adapter
- Matrox Millennium II AGP Graphics Adapter
- STB Glyder MAX-2+ AGP Graphics Adapter

### Matrox Millennium G200 AGP Graphics Adapter

The Matrox Millennium G200 AGP Graphics Adapter supports all video graphics array (VGA) modes and is compliant with super video graphics array (SVGA) modes and Video Electronics Standards Association (VESA) 1.2. Some enhanced features are:

- On board memory: 8 MB SGRAM standard, upgradable to 16 MB
- 250 MHz RAMDAC
- MGA-G200 128-bit DualBus graphics chip
- Advanced 2D, 3D and software DVD video acceleration
- High Quality 3D rendering engine

For information on resource assignments, see Appendix B, “System Address Maps” on page 61 and Appendix C, “IRQ and DMA Channel Assignments” on page 65.

### Matrox Millennium II AGP Graphics Adapter

The Matrox Millennium II AGP Graphics Adapter supports all video graphics array (VGA) modes and is compliant with super video graphics array (SVGA) modes and Video Electronics Standards Association (VESA) 1.2. Some enhanced features are:

- Dual ported on board WRAM memory: 8 MB SGRAM standard, upgradable to 16 MB
- 250 MHz RAMDAC
- 2D resolutions - True color (16.7M colors)
- 1920 X 1200 True color

For information on resource assignments, see Appendix B, “System Address Maps” on page 61 and Appendix C, “IRQ and DMA Channel Assignments” on page 65.

### STB Glyder MAX-2+ AGP Graphics Adapter

The STB Glyder MAX-2+ AGP Graphics Adapter supports all video graphics array (VGA) modes and is compliant with super video graphics array (SVGA) modes and Video Electronics Standards Association (VESA) 1.2. Some enhanced features are:

- 66 MHz AGP-2 based graphics accelerator
  - Pipelined command queuing
  - Side banding
  - DMA and Execute modes compact.
- 8 MB flexible multifunction memory
- 230 MHz RAMDAC
- 2D Resolutions - True Color (16.7M colors)
- 1280 x 1024 @85 Hz
  - max resolution: 1600 x 768 @ 85 Hz
  - 3D Resolutions by color depth

## Chapter 2. System-Board Features

compact.

- True color (up to): 1280 X 1024 -- 16 bit Z, .5 MB texture
- 8 bit color (64K colors): 1600 x 1200 -- 16 bit Z, .5 MB texture
- Business Graphics Winmark: 221
- CDRS: 27.07 with 400 MHz
- 3D Features
  - Triangle setup engine
  - Color dithering
  - Double buffering
  - Z-buffer (16-bit)
  - Fogging (fade to white)
  - Depth cueing (fade to black)
  - Hardware Zoom
  - Gouraud shading
  - Bilinear MIP mapping
  - True Alpha blinding
  - Video textures
  - Perspective correction
  - Bilinear filtering
  - Palletized Textures
  - Onchip texture cache (1K)
  - Texture Bus Mastering

---

### Audio

All models come with integrated audio. Some models come with a Crystal audio adapter. These models, which are capable of playing and recording sounds, support SoundBlaster, Adlib, and Microsoft Windows Sound System applications. The audio adapter in these models has a 4237B Crystal audio chip with integrated SRS 3D sound technology that supports FM synthesis.

The device drivers for the preinstalled audio adapter are on the hard disk drive. The device drivers are also available on the *Ready-to-Configure* CD provided with all models.

If you connect an optional device to the audio adapter, follow the instructions provided by the manufacturer. (Note that device drivers might be required. If necessary, contact the manufacturer for information on these device drivers.)

The following ports are available on the integrated audio controller:

- *Line Out* port for connecting powered speakers. Your audio system requires a set of speakers connected to the Line Out port in order to hear audio from the adapter. These speakers must be powered with a built-in amplifier. In general, any powered speakers designed for use with personal computers can be used with your audio adapter. These speakers are available with a wide range of features and power outputs.
- *Line In* port for connecting musical devices, such as a portable CD-ROM or stereo.
- *Microphone* for connecting a microphone.

---

<sup>2</sup> An electronic device connected to the Game/MIDI port might require an optional adapter cable. For more information, refer to the documentation that comes with the electronic device.

---

### Input/Output Controller

Control of the integrated input/output (I/O) and diskette drive controllers is provided by a single module, the SMC 37C673. This module, which supports Plug and Play, controls the following features:

- Diskette drive interface
- Serial port
- Parallel port
- Keyboard and mouse ports
- General purpose I/O ports

### Diskette Drive Interface

The IntelliStation E Pro has four drive bays for installing internal devices. The following is a list of devices that the diskette drive subsystem supports:

- 1.44 MB, 3.5 inch diskette drive
- 1.44 MB, 3.5 inch, 3-mode drive for Japan
- 1.2 MB, 5.25 inch diskette drive
- 1 Mbps, 500 Kbps, or 250 Kbps internal tape drive

One connector is provided on the system board for diskette drive support. For information on the connector pin assignments, see “Diskette Drive Connector” on page 56.

### Serial Ports

Integrated into the system board are two universal asynchronous receiver/transmitter (UART) serial ports. The serial ports include a 16-byte data, first-in first-out (FIFO) buffer, and have programmable baud rate generators. The serial ports are NS16450 and PC16550A compatible.

For information on the connector pin assignments, see “Serial Port Connectors” on page 59.

**Note:** Current loop interface is not supported.

The following figure shows the serial port assignments used in configuration.

Port Assignment	Address Range (hex)	IRQ Level
Serial 1	03F8–03FF	IRQ4
Serial 2	02F8–02FF	IRQ3
Serial 3	03E8–03FF	IRQ4
Serial 4	02E8–02FF	IRQ3

The default setting for serial port is COM1.

### Parallel Port

Integrated in the system board is support for extended capabilities port (ECP), enhanced parallel port (EPP), and standard parallel port (SPP) modes. The modes of operation are selected through the Configuration/Setup Utility program with the default mode set to SPP. The ECP and EPP modes are compliant with IEEE 1284.

The following figure shows the parallel port assignments used in the configuration.

<i>Figure 3. Parallel Port Assignments</i>		
Port Assignment	Address Range (hex)	IRQ Level
Parallel 1	03BC–03BE	IRQ7
Parallel 2	0378–037F	IRQ5
Parallel 3	0278–027F	IRQ5

The default setting for the parallel port is Parallel 1.

The system board has one connector for the parallel port. For information on the connector pin assignments, see “Parallel Port Connector” on page 59.

## Keyboard and Mouse Ports

The keyboard and mouse subsystem is controlled by a general purpose 8-bit microcontroller; it is compatible with 8042AH. The controller consists of 256 bytes of data memory and 2 KB of read-only memory (ROM).

The controller has two logical devices: one controls the keyboard and the other controls the mouse. The keyboard has two fixed I/O addresses and a fixed IRQ line and can operate without the mouse. The mouse cannot operate without the keyboard because, although it has a fixed IRQ line, the mouse relies on the addresses of the keyboard for operation. For the keyboard and mouse interfaces, no resource assignments are given in the system memory addresses or DMA channels. For information on the resource assignments, see “Input/Output Address Map” on page 61 and Figure 49 on page 65 (for IRQ assignments).

The system board has one connector for the keyboard port and one connector for the mouse port. For information on the connector pin assignments, see “Mouse and Keyboard Port Connectors” on page 58.

## IntelliStation E Pro Network Connection

All IntelliStation E Pro models are equipped with an integrated Ethernet that supports the Wake on LAN feature.

Features of the integrated Ethernet adapter are:

- IEEE 802.3 compliance
- Operates in shared 10BASE-T or 100BASE-TX environment (auto-negotiation)
- Transmits and receives data at 10 Mbps or 100 Mbps
- RJ-45 connector for LAN attachment
- Operates in symmetrical multiprocessing (SMP) environments
- Wake on LAN support
- Remote Program Load (RPL) and Dynamic Host Configuration Protocol (DHCP) support
- Alert on LAN support
- Viewable MAC Address provided
- PCI 2.1 compliant bus master

Features of the optional Token-Ring adapter are:

- Transmits and receives data at 4 Mbps or 16 Mbps
- RJ-45 and D-shell connectors for LAN attachment
- Wake on LAN support
- Remote Program Load (RPL) and Dynamic Host Configuration Protocol (DHCP) support

### Real-Time Clock and CMOS

The real-time clock is a low-power clock that provides a time-of-day clock and a calendar. The clock settings are maintained by an external battery source of 3 V ac.

The system uses 242 bytes of memory to store complementary metal-oxide semiconductor (CMOS) memory. Moving a jumper on the system board erases CMOS memory.

To locate the battery, see “System Board, Type 6893” on page 16.



---

## Flash EEPROM

The system board uses an 8 Mb flash electrically-erasable, programmable, read-only memory (EEPROM) to store system programs that include basic input/output system (BIOS), IBM logo, Configuration/Setup Utility, and Plug and Play data.

As part of the continuing work to improve quality, IBM might make changes and enhancements to the system programs. When updates are released, they will be available on the World Wide Web at

<http://www.pc.ibm.com/us/intellistation>

or through the PC Company Bulletin Board Service in files that can be downloaded onto a diskette. Instructions for using the system programs updates will be available in a README file included in the downloaded files.

---

## Riser Card

The system board uses a riser card to route PCI and ISA bus signals to the expansion connectors. Each ISA-expansion connector is 16 bits, and each PCI-expansion connector is 32 bits. PCI-expansion connectors support the 32 bit, 5 V dc, local-bus signalling environment that is defined in *PCI Local Bus Specification 2.1*. The ISA bus is buffered to provide sufficient drive for the ISA-expansion connectors, assuming two low-power Schottky (LS) loads per slot.

The system board uses a riser card. The following figure summarizes the characteristics of the two riser card.

<i>Figure 4. Riser Card Characteristics</i>	
<b>Expansion Slots</b>	<b>4x4 Riser Card</b>
Shared ISA/PCI	1*
Dedicated ISA	1*
Dedicated PCI	2

\* Indicates full size adapter slots.

For information on the connector pin assignments, see “ISA Connectors” on page 52 and “PCI Connectors” on page 53.

## Physical Layout

The system board might look slightly different from the one shown.

**Note:** A diagram of the system board, including switch and jumper settings, is attached to the underside of the computer cover.

## System Board, Type 6893

- 1** Battery
- 2** Microprocessor-speed switches
- 3** Microprocessor
- 4** DIMM 0
- 5** DIMM 1
- 6** DIMM 2
- 7** Clear CMOS Request jumper
- 8** AGP connector

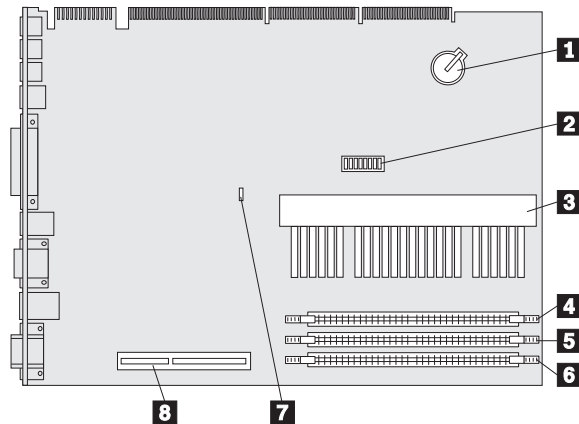

**Note:** An illustration of the system board and additional information are provided on a label found inside the computer.

## System Board Switches

Switches are provided on the system board to allow for custom configuration. The switches, which are contained in an eight-position switch block on the system board, are rocker switches. The side of the rocker that is pushed down is the active side.

Switches 1 through 4 determine the speed of the microprocessor (CPU) and local processor bus. Switch settings for the Intel microprocessors supported by IntelliStation E Pro are shown in the following table. Note that the two speeds shown for each microprocessor are the microprocessor core speed followed by the local processor bus speed (for example, 350/100 MHz).

Figure 5. Microprocessor Speed (Switches 1-4)

Microprocessor	Switch 1	Switch 2	Switch 3	Switch 4
350/100 MHz	Off	Off	On	On
400/100 MHz	On	On	Off	On
450/100 MHz	Off	On	Off	On

IntelliStation E Pro computers are designed to support 100MHz FSB microprocessors.

**Note:** Only the switch values shown in the preceding table are supported. Using unsupported switch settings will cause unpredictable results.

Switch 5 is ROM Recovery.

<i>Figure 6. ROM Recovery (Switch 5)</i>	
Normal operation	Off (factory default)
ROM Recovery	On

Switch 6 enables or disables the system board Ethernet. When the Ethernet disable switch is *On*, the system board Ethernet is disabled. This switch must be on when a Wake on LAN adapter is installed. (Note that only one Wake on LAN device can be used.)

<i>Figure 7. System Board Ethernet Control (Switch 6)</i>	
Disable	On
Enable (factory default)	Off

Switch 7 enables or disables the privileged access password (PAP). Note that this password is also referred to as the *administrator password*. Refer to the *IntelliStation E Pro User Guide* and *Installing Options in Your IntelliStation E Pro* for important information on erasing lost or forgotten passwords.

<i>Figure 8. Privileged Access Password Control (Switch 7)</i>	
Administrative Password Locked (factory default)	Off
Administrative Password Unlocked	On

## Chapter 2. System-Board Features

Switch 8 controls writing to the diskette drive.

<i>Figure 9. Diskette Drive Device Access (Switch 8)</i>	
Write enabled (factory default)	Off
Write protected	On

## Clear CMOS Request Jumper

This jumper, on the system board, is used for clearing CMOS in the event that it becomes corrupted or needs to be refreshed for any reason. For the location of the Clear CMOS Request jumper, refer to “System Board, Type 6893” on page 16.

<i>Figure 10. Clear CMOS Request Jumper (J9)</i>	
Pins	Description
1 and 2	Normal (Factory default)
2 and 3	Clear CMOS/Password

## Riser Card

The riser card in your computer has two ISA slots and three PCI slots. The third PCI connector from the top shares a slot with the ISA connector directly *below* it. The other slots are dedicated to either the ISA or PCI bus. You can install only one adapter in the shared slot, for a total of four slots.

The following illustration shows the expansion slots and connectors on the riser card.

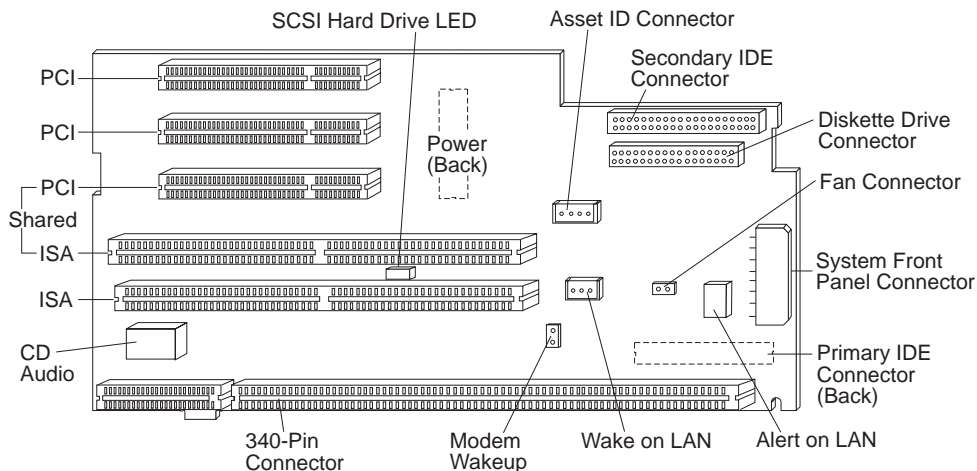

The riser card plugs into the system board via a 340-pin connector and expansion adapters plug into the ISA- or PCI-expansion connectors (slots) on the riser card. Each ISA-expansion connector provides a 16-bit-wide data path, and each PCI-expansion connector provides a 32-bit-wide data path.

Shared slots will accommodate either an ISA adapter installed in the ISA connector, or a PCI adapter installed into the PCI connector. Shared slots cannot accommodate ISA and PCI adapters at the same time.

**Note:** The front fan is thermally controlled by the System Management Controller. The front fan for most configurations will be on for a short period of time, then will be turned off when the temperature of the system is controlled.

Each PCI-expansion connector is capable of driving one, low-power Schottky load. Each ISA-expansion connector is capable of driving two, low-power Schottky loads. The ISA bus is permanently set to the PCI bus speed divided by four.

The PCI bus shares interrupts with the ISA bus. Free interrupts are automatically assigned to PCI devices during POST. If no interrupts are available for the PCI devices, an 18xx POST error message is generated.

### Connector Panel

Connectors for attaching input/output devices are provided on the rear connector panel. The connectors are:

- USB (2)
- Mouse
- Keyboard
- Serial (2)
- Parallel
- Monitor
- Ethernet with an RJ-45 connector
- Audio with line out, line in, and microphone connectors

Connectors for features that are integrated into the system board can be identified by a symbol label directly below the connector. Connectors provided by an adapter might not have an identifying symbol.

For pinout details on connectors, see Appendix A, “Connector Pin Assignments” on page 50.

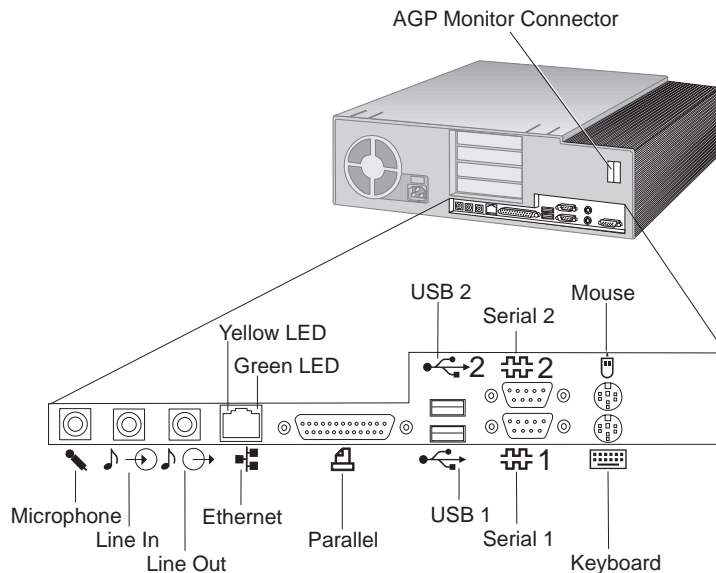

#### Notes:

1. Models equipped with a SCSI adapter have an external connector for connecting SCSI devices. See the SCSI documentation provided with your computer for more information.
2. some models might have a 15-pin video connector on the system board. This connector is disabled and cannot be used.

## Chapter 3. Physical Specifications

This section lists the physical specifications for the IntelliStation E Pro

### Notes:

- The maximum altitude for all models is 2133.6 m (7000 ft.). This is the maximum altitude at which the specified air temperatures apply. At higher altitudes, the maximum air temperatures are lower than those specified.
- The IntelliStation E Pro computer complies with FCC Class A.

<p><b>Dimensions</b></p> <ul style="list-style-type: none"> <li>• Height: 128 mm (5.0 in.)</li> <li>• Width: 450 mm (17.7 in.)</li> <li>• Depth: 440 mm (17.3 in.)</li> </ul> <p><b>Weight</b></p> <ul style="list-style-type: none"> <li>• Minimum configuration as shipped: 9.9 kg (22 lb)</li> <li>• Maximum configuration: 11.3 kg (25 lb)</li> </ul> <p><b>Environment</b></p> <ul style="list-style-type: none"> <li>• Air temperature:           <ul style="list-style-type: none"> <li>– System on: 10° to 32°C (50° to 90°F)</li> <li>– System off: 10° to 43°C (50° to 110°F)</li> </ul> </li> <li>• Humidity:           <ul style="list-style-type: none"> <li>– System on: 8% to 80%</li> <li>– System off: 8% to 80%</li> </ul> </li> <li>• Maximum altitude: 2134 m (7000 ft)</li> </ul> <p><b>Electrical Input</b></p> <ul style="list-style-type: none"> <li>• Sine-wave input (50 to 60 Hz) is required</li> <li>• Input voltage:           <ul style="list-style-type: none"> <li>– Low range:               <ul style="list-style-type: none"> <li>- Minimum: 90 V ac</li> <li>- Maximum: 137 V ac</li> <li>- Voltage switch setting: 115 or 115 V</li> </ul> </li> <li>– High range:               <ul style="list-style-type: none"> <li>- Minimum: 180 V ac</li> <li>- Maximum: 265 V ac</li> <li>- Voltage switch setting: 230 or 230 V</li> </ul> </li> <li>– Input kilovolt-amperes (kVA) (approximately):               <ul style="list-style-type: none"> <li>- Minimum configuration as shipped: 0.08 kVA</li> <li>- Maximum configuration: 0.52 kVA</li> </ul> </li> </ul> </li> </ul> <p><b>Note:</b> Power consumption and heat output vary depending on the number and type of optional features installed and the power-management optional features in use.</p>	<p><b>Heat Output</b></p> <ul style="list-style-type: none"> <li>• Approximate heat output in British thermal units (Btu) per hour:           <ul style="list-style-type: none"> <li>– Minimum configuration: 245 Btu/hr (70 watts)</li> <li>– Maximum configuration: 700 Btu/hr (204 watts)</li> </ul> </li> </ul> <p><b>Airflow</b></p> <ul style="list-style-type: none"> <li>• Approximately 0.56 cubic meters per minute (20 cubic feet per minute)</li> </ul> <p><b>Acoustical Noise-Emission Values</b></p> <ul style="list-style-type: none"> <li>• Average sound-pressure levels:           <ul style="list-style-type: none"> <li>– At operator position:               <ul style="list-style-type: none"> <li>- 34 dBA idle</li> <li>- 37 dBA operating</li> </ul> </li> <li>– At bystander position—1 meter (3.3 ft):               <ul style="list-style-type: none"> <li>- 29 dBA idle</li> <li>- 32 dBA operating</li> </ul> </li> </ul> </li> <li>• Declared (upper limit) sound power levels:           <ul style="list-style-type: none"> <li>– 4.5 bels idle</li> <li>– 4.9 bels operating</li> </ul> </li> </ul> <p><b>Note:</b> These levels were measured in controlled acoustical environments according to procedures specified by the American National Standards Institute (ANSI) S12.10 and ISO 7779, and are reported in accordance with ISO 9296. Actual sound-pressure levels in your location might exceed the average values stated because of room reflections and other nearby noise sources. The declared sound power levels indicate an upper limit, below which a large number of computers will operate.</p>
---	--

### SCSI Adapter

Some computers come with an Adaptec SCSI-II Ultra Wide adapter installed in one of the expansion slots. This adapter provides an interface between the PCI bus and SCSI devices. SCSI technology is useful with multitasking operating environments because instructions can be sent concurrently to every drive in the system, and the drives can then execute these instructions simultaneously.

An extra cable is provided with SCSI models. The cable included with the IntelliStation E Pro has four connectors: one connector for attaching the cable to the SCSI adapter and three connectors for attaching optional SCSI devices.

For information on the adapter and connecting SCSI devices, refer to the SCSI documentation that comes with the computer.

### Cabling Requirements for Wake on LAN Adapters

Wake on LAN adapters have two headers: a 3-pin, right-angle header for providing AUX5 (Auxiliary 5 volts), and a 2-pin straight header for connecting the wakeup signal to the system board (or riser card). The IntelliStation E Pro has a 3-pin header on the riser card that provides the AUX5 and wakeup signal connections. The Wake on LAN adapter option will provide a Y-cable that has the 3-pin riser card connector on one end and splits into the 3-pin and 2-pin connectors required to interface the card. When a Wake on LAN adapter is installed in the system and attached to the AUX5 power, the system board Ethernet function must be disabled via switch 6 on the system board (refer to "System Board Switches" on page 16 for switch information).



## Chapter 4. Power Supply

The power supply requirements are supplied by 145-watt IntelliStation E Pro power supply. The power supply provides 3.3-volt power for the Pentium microprocessor and core chip set and 5-volt power for ISA and PCI adapters. Also included is an auxiliary 5-volt (AUX 5) supply to provide power to power management circuitry and the system board Ethernet function, or a Wake on LAN adapter. The power supply converts the ac input voltage into four dc output voltages and provides power for the following:

- System board
- Adapters
- Internal drives
- Keyboard and auxiliary devices
- USB devices

A logic signal on the power connector controls the power supply; the front panel switch is not directly connected to the power supply.

The power supply connects to the riser card with a 2 x 10 connector.

### Power Input

The following figure shows the input power specifications. The power supply has a manual switch to select the correct input voltage.

<i>Figure 11. Power Input Requirements</i>	
Specification	Measurements
Input voltage, low range	90 (min) to 137 (max) V ac
Input voltage, high range	180 (min) to 265 (max) V ac
Input frequency	50 Hz $\pm$ 3 Hz or 60 Hz $\pm$ 3 Hz

### Power Output

The power supply outputs shown in the following figures include the current supply capability of all the connectors, including system board, DASD, PCI, and auxiliary outputs.

<i>Figure 12. Power Output (145 Watt)</i>			
Output Voltage	Regulation	Minimum Current	Maximum Current
+5 volts	+5% to -4%	1.5 A	18.0 A
+12 volts	+5% to -5%	0.2 A	4.2 A
-12 volts	+10% to -9%	0.0 A	0.4 A
-5 volts	+10% to -10%	0.0 A	0.3 A
+3.3 volts	+2% to -2%	0.0 A	10.0 A
+5 volt (auxiliary)	+5% to -10%	0.02 A	.720 A

The total combined 3.3 V/5 V power should not exceed 100 watts.

### Component Outputs

The power supply provides separate voltage sources for the system board and internal storage devices. The following figures show the approximate power that is provided for specific system components. Many components draw less current than the maximum shown.

<i>Figure 13. System Board</i>		
Supply Voltage	Maximum Current	Regulation Limits
+3.3 V dc	3000 mA	+2% to -2.0%
+5.0 V dc	4000 mA	+5.0% to -4.0%
+12.0 V dc	25.0 mA	+5.0% to -5.0%
-12.0 V dc	25.0 mA	+10.0% to -9.0%

<i>Figure 14. Keyboard Port</i>		
Supply Voltage	Maximum Current	Regulation Limits
+5.0 V dc	275 mA	+5.0% to -4.0%

<i>Figure 15. Auxiliary Device Port</i>		
Supply Voltage	Maximum Current	Regulation Limits
+5.0 V dc	300 mA	+5.0% to -4.0%

<i>Figure 16. ISA-Bus Adapters (Per Slot)</i>		
Supply Voltage	Maximum Current	Regulation Limits
+5.0 V dc	2000 mA	+5.0% to -4.0%
-5.0 V dc	200 mA	+5.0% to -5.0%
+12.0 V dc	1500 mA	+5.0% to -5.0%
-12.0 V dc	300 mA	+10.0% to -9.0%

<i>Figure 17. PCI-Bus Adapters (Per Slot) either/or</i>		
Supply Voltage	Maximum Current	Regulation Limits
+5.0 V dc	2000 mA	+5.0% to -4.0%
+3.3 V dc	3030 mA	+5.0% to -4.0%

**Note:** For each PCI connector, the maximum power consumption is rated at 10 watts for +5 V dc and +3.3 V dc combined. Typical power budget assumptions use 7.5 watts per adapter. If maximum power is used then the overall system configuration will be limited in performance.

<i>Figure 18. USB Port</i>		
Supply Voltage	Maximum Current	Regulation Limits
+5.0 V dc	500 mA	+5.0% to -4.0%

*Figure 19. Internal SCSI Drives*

Hard Drive	Supply Voltage	Maximum Current	Regulation Limits
9.1 GB	+5.0 V dc	960 mA (startup max.); 800 mA (idle avg.); 1090 mA (operating max.); 1180 mA (peak seek)	+5.0% to -5.0%
9.1 GB	+12.0 V dc	1700 mA (startup max.); 600 mA (idle avg.); 840 mA (operating max.); 2200 mA (peak seek)	+5.0% to -5.0%

**Note:** Some adapters and hard disk drives draw more current than the recommended limits. These adapters and drives can be installed in the system; however, the power supply will shut down if the total power used exceeds the maximum power that is available.

---

## Output Protection

The power supply protects against output overcurrent, overvoltage, and short circuits. See the power supply specifications on the previous pages for details.

A short circuit that is placed on any dc output (between outputs or between an output and dc return) latches all dc outputs into a shutdown state, with no damage to the power supply. If this shutdown state occurs, the power supply returns to normal operation only after the fault has been removed and the power switch has been turned off for at least one second.

If an overvoltage fault occurs (in the power supply), the power supply latches all dc outputs into a shutdown state before any output exceeds 130% of the nominal value of the power supply.

---

## Connector Description

The power supply for the IntelliStation E Pro has four, 4-pin connectors. The total power used by the connectors must not exceed the amount shown in “Component Outputs” on page 24. For connector pin assignments, see Appendix A, “Connector Pin Assignments” on page 50.

---

# Chapter 5. System Software

This section briefly describes some of the system software included with the computer.

---

## BIOS

The IntelliStation E Pro uses IBM basic input/output system (BIOS) stored in a flash electrically erasable programmable read only memory (EEPROM).

Key features of the BIOS are:

- PCI support according to PCI BIOS Specification 2.1
- Microsoft's PCI IRQ Routing Table
- Plug and Play support according to Plug and Play BIOS Specification 1.1
- Advanced Power Management (APM) support according to APM BIOS Interface Specification 1.2
- Wake on LAN support
- Remote Program Load (RPL) and Dynamic Host Configuration Protocol (DHCP)
- Startable CD-ROM support
- Flash-over-LAN support
- Alternate Startup Sequence
- Enable/disable of system board Ethernet controller
- IBM Look and Feel – Screen arrangements, etc.
- ACPI (Advanced Configuration and Power Interfaces)
- IDE Logical Block Addressing (LBA support)
- LSA 2.0 support
- Bootable CD ROM support
- LS120 support
- DM BIOS 2.1 (DMI 2.0 compliant)
- PC97 compliant

---

## Plug and Play

Support for Plug and Play conforms to the following:

- Plug and Play BIOS Specification 1.1 and 1.0
- Plug and Play BIOS Extension Design Guide 1.0
- Plug and Play BIOS Specification, Errata and Clarifications 1.0
- Guide to Integrating the Plug and Play BIOS Extensions with system BIOS 1.2
- Plug and Play Kit for DOS and Windows

---

## POST

The IntelliStation E Pro uses IBM power-on self-test (POST) software with initialization code added for the chip set and integrated controllers. BIOS is stored in flash EEPROM.

POST software locates any hardware problems or configuration changes. If an error occurs while POST is running, an error code in the form of a text message displays on the screen. For further information on POST errors, refer to the *IntelliStation E Pro User Guide*.

---

## Configuration/Setup Utility Program

The Configuration/Setup Utility program provides menus for selecting options for devices, I/O ports, date and time, system security, start options, advanced setup, ISA legacy resources, and power management.

More information on using the Configuration/Setup Utility program is provided in the *IntelliStation E Pro User Guide*.

---

## Advanced Power Management (APM)

The IBM IntelliStation computer comes with built-in energy-saving capabilities. Advanced Power Management (APM) is a feature that reduces the power consumption of systems when they are not being used. When enabled, APM initiates reduced-power modes for the monitor, microprocessor, and hard disk drive after a specified period of inactivity.

The BIOS supports APM 1.1. This enables the system to enter a power-managed state, which reduces the power drawn from the ac wall outlet. Advanced Power Management is enabled through the Configuration/Setup Utility Program and is controlled by the individual operating system.

For more information on APM, see the *IntelliStation E Pro User Guide* and *Understanding Your IntelliStation E pro*.

## Advanced Configuration and Power Interface (ACPI)

When Automatic Configuration and Power Interface (ACPI) BIOS mode is enabled, the operating system is allowed to control the power management features of your computer and the settings for APM BIOS mode are ignored. Not all operating systems support ACPI BIOS mode. See “Advanced Configuration and Power Interfaces (ACPI)” on page 40 for more information. Refer to your operating system documentation to determine if ACPI is supported.

---

## Flash Update Utility Program

The flash update utility program is a stand alone program to support flash updates. This utility program updates the BIOS code in flash and the Machine Readable Information (MRI) to different languages.

The flash update utility program is available on a 3.5 inch diskette (refer to “Flash EEPROM” on page 15).

---

## Diagnostic Programs

The diagnostic programs that comes with the IntelliStation E Pro are provided as a startable *IBM Enhanced Diagnostic* diskette image on the hard disk and on the *Ready-to-Configure Utility Program* CD. It runs independently of the operating system. The user interface for running the diagnostics and utilities is provided by Watergate Software's PC-Doctor. It can also be downloaded from the following World Wide Web page: [http://www.pc.ibm.com/support/desktop/desktop\\_support.html](http://www.pc.ibm.com/support/desktop/desktop_support.html). For more information on this diagnostic program, see the *IntelliStation E Pro User Guide*.

---

# Chapter 6. IBM System Management Tools

IBM System Management Tools are a collection of hardware and software features designed to make it easier to manage your system over a computer network. When used in conjunction with the appropriate network management software, these tools provide systems administrators the ability to remotely manage and monitor your computer.

IBM System Management tools consist of the following components:

- Desktop Management Interface (DMI) Service Provider 2.0
- Desktop Management (DM) BIOS 2.0 Instrumentation
- IBM PC System Monitor Instrumentation
- IBM AssetCare
- IBM Alert on LAN
- IBM SMART Reaction Client
- Intel LANDesk® Client Manager 3.1.

When you install IBM System Management Tools, all of the essential components are installed. However, you can choose whether to install the two optional tools, Intel LANDesk Client Manager and IBM SMART Reaction Client.

IBM Alert on LAN requires additional hardware support. This support is provided with some computer models only.

---

## Components of IBM System Management Tools

A description of each of the components of IBM System Management Tools follows:

### DMI Service Provider

The Desktop Management Interface (DMI) Service Provider 2.0 is a mechanism for gathering information about the hardware and software in your computer. It is used to help administrators manage and control hardware and software products on desktop computers and network servers. The DMI Service Provider can be used to remotely track information such as serial numbers, memory attributes, product-specific characteristics of installed peripherals, and operating system information from each DMI-compliant component and manage that information in the Management Information Format (MIF) database. The service provider passes this information to management applications as requested. This information can be accessed using a DMI browser. DMI browsers are provided by all major operating systems and all major LAN management packages, including TME 10 NetFinity, Intel LANDesk, and Microsoft SMS. It controls communications between itself and manageable products by means of instrumentation. Support documentation is built into the browser's Help system.

### DM BIOS Instrumentation

This application retrieves information such as memory configuration, BIOS version and date, and microprocessor and cache information from the system BIOS.

## IBM PC System Monitor

This application monitors system-board temperatures, system voltages, and fan speed, and detects removal of the computer cover. Data is reported to the DMI service provider. System management software, such as IBM NetFinity Services or Intel LANDesk Client Manager, can then be used to send an alert to the user or to the system administrator if a problem occurs. The IBM PC System Monitor must be installed in addition to NetFinity in order to enable environmental monitoring in NetFinity (PC System Monitor and NetFinity can be installed in either order).

### System Management Chip (LM80)

The IBM IntelliStation contains a National System Management chip (LM80) that provides low cost instrumentation capabilities for a PC in order to lower the total cost of ownership over the life cycle of the PC. The System management chip monitors the system at all times looking for potential failures before the system fails. Notification can be provided across the LAN.

System Management controller monitors the following:

- System temperature sensing and fan control
- Voltages (+5,+12,-12,+3.3,+1.5,2.5, and -5)
- Intrusion detect for security (detects when chassis lid has been removed, even if power is off). Uses mechanical switch in the speaker/fan assembly.
- Serial Bus interfaces (SMBus version)

These hardware functions allow the LCM, LCCM, and LDCM Network software to remotely monitor the client PCs over the network for these critical parameters. When machines are found with out-of-range parameters, appropriate repair, backup, and shutdown actions may be taken.

The LM80 physically resides on the SMBus interface. The device address for the LM80 is 0x50 hex.

The SMBus protocol is used to read/write data to/from ALL registers onboard the LM80. There is a protocol established for reading and writing these registers to maintain consistency in the eventuality that the thread is broken (context switch) while servicing it. Each of these registers and their functionality is spelled out in the Software Interface section of this document.

LM80 contains virtually all the signal conditioning and front end analog circuitry necessary to interface to the power supply voltages, fan and chassis intrusion alarm onboard as well as having a fully self contained temperature sensor. An SMBus (Integrated Circuit, 2 wire serial) slave bus interface is also provided for future compatibility with other SMBus devices.

At initial power on configuration, the LM80 will be programmed with predetermined threshold values for temperature, voltage, and fan control. During system operation IBM PC System Monitor code polls the LM80 and generates an alert when the measured value is outside of the programmed min and max range.

### System Management Bus (SMBus) Controller

PIIX4E contains a SMBus Host interface to allow the CPU to communicate with SMBus slaves. The PIIX4E also provides an SMBus slave interface to allow external masters to monitor power management events. The SMBus controller is logically a subset of the PIIX4E power management controller.

### Power Management Controller

PIIX4E contains support for advanced power management features, including clock control, and various low-power state control logic. In combination with the onboard battery backed RTC logic, the PIIX4E provides full hardware and software based power control. It contains full support for the Advanced Configuration and Power Interface (ACPI) specification. APM is also supported for "legacy OS's." These features are controlled via software.

PIIX4E supports the following power management functions:

- Global and Local Device Management
- Suspend and Resume logic
- Supports Thermal Alarm
- Support for External Microcontroller (LM80)
- Wake up events supported:
  - Wakeup from a LAN request. Used with the integrated planar Ethernet or Wake on Lan (WOL) LAN adapters (Token Ring or Ethernet).
  - Connectors for WOL LAN adapters located on Niagara BX Riser.
  - Wakeup from UART Ring Indicate ( Serial Port 1 only)
  - Wakeup on RTC date and time
  - Wakeup on switch input
  - Wakeup from external ring (used with internal modems). Connector located on Niagara BX riser.
  - Wakeup from a PCI PME# (PCI Power Management) event.

### IBM AssetCare

This application is used to retrieve serial numbers and system configuration information. Serial numbers can be dynamically retrieved from IDE and SCSI hard drives, memory DIMMs, and DDC2B compliant monitors. Serial numbers for other system components, including CPU, CD-ROMs, system unit, riser cards, floppy drives, power supplies, and the motherboard, are readable from the Enhanced Asset Information Area, which resides in an EEPROM and can be accessed either through a radio-frequency link or through the system's SMBus.

The system BIOS determines the type of access to the Enhanced Asset Information Area EEPROM that is allowed. The EEPROM is partitioned into 8 blocks of 128 bytes each. Blocks 0-5 are reserved for Asset ID data, which includes system and subsystem serialization data, system configuration data, and other system data that may be user specified.

The six blocks are grouped into three areas of two blocks each. The first two blocks (blocks 0 and 1) are referred to as the Serialization Information Area. These blocks are reserved for system and subsystem serial information. The data within the area consists of a 16 byte header followed by serial numbers. The User Information Area (blocks 2 and 3) is reserved for user information. This area consists of a 16 byte header and a 232 byte area and an 8 byte reserved area. The Configuration Information Area (blocks 4 and 5) includes an area header followed by the configuration data. The data stored in this area is maintained by the system BIOS at each boot time.



*Figure 20. Enhanced Asset Information Area*

Device Address	Word Address	Block	Description	RF Access	System Access
A8	00-7F	0	Serialization Information Area	Read only	Read/write
A8	80-FF	1	Serialization Information Area	Read only	Read/write
AA	00-7F	2	User Information Area	Read/write	Read/write
AA	80-FF	3	User Information Area	Read/write	Read/write
AC	00-7F	4	Configuration Information Area	Read only	Read only
AC	80-FF	5	Configuration Information Area	Read only	Read only

Data can be written and read through either the RF interface to the system or the SMBus. Writing and reading via the RF interface requires a portable hand held reader or door reader. Software residing in the hand held reader and portal gate controller are required to support the RF interface. Access to the EAI area data from the system side is provided by the DMI browser provided with the software.

When data is written to the EIA through the SMBus it is done either dynamically or statically and depends on the data. Dynamic update of some of the data is done either by the system BIOS or by the AssetCare software each time it is loaded by obtaining the information directly from the device or operating system. Other types of information must be entered and updated by a system administrator or other authorized person. All data entered into the EAI area must be associated with one of the device types defined in Figure 22.

Although every device entered must use one of the device types defined, the inclusion of a specific entity in the EAI area is optional. However, to get maximum utility from the EAI hardware, the data should be as complete and accurate as possible.

## Chapter 6. IBM System Management Tools

Figure 21 (Page 1 of 2). Device Types

Device Type	Device Number	Device Number	Dynamic Update	Comment
0	0-7	Null	No	Device not included in RFID EEPROM
1	0-7	CPU	No	
2	0-7	Reserved		Do not use
3	0-7	Other IDE Devices	No	Includes IDE devices that do not support electronic serial number retrieval, including CD-ROMs. This device type is used for serialization data only.
4	0	System	No	
5	0	Riser card	No	
6	0-7	Floppy	No	
7	0	Power supply	No	
8	0	Base Planar	No	
9	0	Smart Card Reader	No	
0A	0	Cache Card	No	
0B	0-7	Reserved	Yes	
0C	0-7	PCI Devices	No	
0D	0-7	ISA PnP Devices	No	
0	0	Monitor	Yes	
0F	0-7	IDE Devices	Yes	Used by serialization for all IDE HDD with electronic serial number. Used by configuration for all IDE devices.
10	0-7	Reserved		
11	0-7	DIMM	Yes	DIMM with electronic serial number
12	0-7	Network Interface	No	
13	0-7	SCSI Devices		Used by serialization for all SCSI HDD with electronic serial number. Used by configuration for all SCSI devices.
14	0-7	Graphics Adapters	No	
15-1E	0-7	Reserved		Reserved for future use
1F	2	Network connection	No	
1F	3	User device	No	User specified device type
1F	4	Preload Profile	No	User specified Preload
1F	5	User asset data	No	User specified asset information
1F	6	Lease data	No	User specified lease information

*Figure 21 (Page 2 of 2). Device Types*

Device Type	Device Number	Device Number	Dynamic Update	Comment
1F	7	Owner data	No	User specified information

## Chapter 6. IBM System Management Tools

Figure 22. Serialization Information Area Header

Offset (Hex)	Contents	Description
00-03	SER#	Area Identifier = SER# for serialization area
4	Length	Number and bytes in each entry field
5	maxFields	Maximum number of entities that may reside in the area
6	versionID	Serialization Information Area version identifier
7	HdrShchecksum	Checksum for the serialization data area
8	AreaChecksum	Checksum for the serialization data area
9	AreaStatus	Provides status about the area as follows: bit 0: RF dirty - a value of 1 indicates the data in the area has been modified by an RF operation.
0A-0F	reserved	Reserved for future use

The two checksums for the serialization area are included in the area header. The checksum for the header is used to check the data contained in the first 7 bytes (0-6) of the header. The checksum for the area is used to check the data located in all of the area locations. The number of data locations included in the checksum can be found from the Length and maxFields fields of the header as  $\text{Length} * \text{maxFields} + 16$ .

Figure 23. User Information Area Header

Offset (Hex)	Contents	Description
00-03	USR#	Area Identifier = USR#
4	Length	Number of bytes used in User Information Area including header
5	Reserved	Reserved for future use. Must read 0.
6	versionID	Asset Information Area version identifier
7	HdrChecksum	Checksum for the first 7 bytes of the header
8	AreaChecksum	Checksum for all user data area
9	AreaStatus	Provides status about the area as follows: bit 0: RF dirty - a value of 1 indicates that data in the area has been modified by an RF operation.
0A-0F	Reserved	Reserved for future use

Figure 24 (Page 1 of 2). Configuration Information Area Header

Byte Offset (Hex)	Contents	Description
00-03	CON#	Area Identifier = CON# for configuration area
4	Length	Number of bytes used in configuration area including header
5	Reserved	Reserved for future use
6	versionID	Asset Information Area version identifier
7	Checksum	Checksum for the first 7 bytes of the header
8	AreaChecksum	Checksum for all configuration data

*Figure 24 (Page 2 of 2). Configuration Information Area Header*

Byte Offset (Hex)	Contents	Description
9	AreaStatus	Provides status about the area as follows: bit 0: RF dirty - a value of 1 indicates that data in the area has been modified by an RF operation. bit 1-7: Reserved
0A-0F	Reserved	Reserved for future use

System configuration information includes processor type and speed, hard drive size, and memory configuration as well as information about on-board devices. Both the serial number and system configuration information can be retrieved by system management applications as well as through radio-frequency (RF) hand held readers and RF access-control gates. The radio-frequency (RF) interface to the Enhanced Asset Information Area enables the customer to perform asset deployment, asset tracking / inventory, and asset access control. This function is referred to as Asset ID.

## Asset ID

The essential component of Asset ID is a radio-frequency interface within each PC that allows access to the EAI EEPROM data. The Asset ID antenna enables communication between the PC and industry-standard radio-frequency handheld scanners. The Asset ID EEPROM contains information about the system, including its configuration and the serial numbers of key components. The Asset ID EEPROM also includes a number of blank fields you can record with your choice of end-user information. Asset ID enables you to read and write information to an EEPROM inside an IBM PC by using a handheld scanner, even while the PC is still in the carton.

Asset ID allows you to take accurate physical inventories of systems and their components without searching for a label or opening the chassis. Passing the handheld scanner near the box allows it to read system information such as model numbers, serial numbers, processor speed, hard disk drive size and memory, as well as any end-user information you choose to record.

When used in conjunction with a compatible radio-frequency security system, Asset ID can be used to assist security personnel in preventing unauthorized removal of PCs. Using this radio-frequency identification system, Asset ID detects the movement of the PC. If movement is not authorized, the system disables the PC.

Handheld scanners and other scanning devices must be purchased separately from Asset ID Partners, third-party companies who have worked closely with IBM to ensure the compatibility of this technology with industry standards. A listing of Asset ID partners is available at:

<http://www.pc.ibm.com/us/desktop/assetid/partners.html>.

## IBM Alert On LAN

Alert On LAN instrumentation allows the Ethernet to be configured to send chassis intrusion, LANboot tamper, presence heartbeat, and environmental alerts even while the machine is in a soft off state. The instrumentation allows the alerts to be enabled and configured remotely and enables operating system lockup detection and other alerts to be received through system management packages, such as LANDesk Workgroup Manager and IBM NetFinity Manager.

A PC equipped with Alert on LAN acts as its own security guard. When someone unplugs the system from its power supply or network, an alert is instantly generated to a network administrator, to building security, or to whomever you designate. When paired with an IBM Netfinity server or Intel LANDesk server products, Alert on LAN can send a message to your pager.

## Chapter 6. IBM System Management Tools

Alert on LAN sends either status or alert packets to your management server. Even after the system is powered off, Alert on LAN-enabled PCs draw a trickle charge that allows generation and transmission of packets via the integrated 10/100 Ethernet controller.

Alert on LAN leverages existing industry-standard technologies, such as the Desktop Management Interface (DMI) and Wake on LAN to provide security for your client PCs, even when they have been powered off.

- Protect your assets

Alert on LAN protects your computer assets at the time they are most vulnerable: after they have been powered off. An Alert on LAN-enabled PC is always on guard.

Alert on LAN sends a status packet at regular intervals regardless of the power state of the client system. If the system is disconnected from its power source or network, the management server will detect the loss of packets and trigger a warning alert.

Alert on LAN monitors the chassis intrusion feature of DMI-compliant management chips. Even if the PC has been powered off, Alert on LAN will issue an alert notification whenever a system chassis is opened.

Alert on LAN can notify you if the processor has been removed from a client system.

- Reduce response times

Alert on LAN can monitor each system in your network as it powers up, and notify you of configuration changes, hard drive failures, or other POST errors.

Alert on LAN can also notify you when a client operating system fails to load or crashes during routine operations. You can respond without waiting for the user to file a complaint, helping to ensure that their productivity is maintained.

Alert on LAN monitors the system variables measured by a DMI-compliant manageability chip-temperature, fan speed, voltage and chassis intrusion. Whenever any of these variables fall outside of the recommended parameters, Alert on LAN can generate an alert.

- Customized responses

You can determine how Alert on LAN reacts to each scenario described above. When you know that systems are being serviced or retired, you can simply remotely disable the client from the management server so no alerts are generated when it is unplugged or its chassis is opened.

You can program Alert on LAN to notify network administrators or building security that a system is being tampered with or removed. You can have your management server dial a pager and deliver a numeric or alphanumeric message that enables you to respond to a problem when you are in a different location.

You can determine how sensitive Alert on LAN is to day-to-day problems.

## IBM SMART Reaction Client

This application is designed to protect data on computers that have Self-Monitoring, Analysis, and Reporting Technology (S.M.A.R.T.) hard disk drives. S.M.A.R.T. monitors the status of a hard disk drive and generates predictive failure analysis (PFA) alerts if a potential failure exists within the drive. IBM SMART Reaction Client intercepts these alerts and converts them to useful responses (such as displaying screen messages at the client workstation or alerting additional parties that a specific workstation has a potential hard disk failure).

IBM SMART Reaction Client has a full-function backup and restoration program, as well as a mirroring program, which can be used to dynamically "mirror" the contents of up to 64 folders to another hard disk. As source files are saved, the mirror files are automatically updated to contain the same data.

IBM SMART Reaction Client also has a built-in scheduler for scheduling backup, restore, and mirror operations. The IBM SMART Reaction Manager program must be installed and running on at least one network computer before IBM SMART Reaction Client can be installed on any client workstation. IBM SMART Reaction Manager, as well as complete documentation on the IBM SMART Reaction program (Client and Manager), is available at <http://www.pc.ibm.com/us/desktop/sr> on the World Wide Web.

In the SMART Reaction environment, the Client system is constantly monitoring the Hard Disk for potential problems. This is done by using the SMART technologies included in the Hard Disk to periodically monitor the disk using a technique known as Predictive Failure Analysis. If the Hard Disk begins to have a high number of retries when reading or writing data, a SMART Alert is passed to the DMI Instrumentation Code running on the Client System. This Alert is then passed to SMART Reaction Client application, which will automatically react to the potential failure based on Administrator defined policies.

---

### SMART Reaction

IBM SMART Reaction automatically backs up data from S.M.A.R.T. hard disk drives that predict an imminent failure. In addition to data backup, SMART Reaction can trigger a rich set of customizable responses, including e-mail or pager notification to your technical support staff.

SMART Reaction also allows you to protect your most critical client data directories by having them constantly "mirrored" on a server- when data in these directories changes, an identical copy is automatically stored on the server.

SMART Reaction can help save time and money by allowing remote and unattended system backups and data restoration.

SMART Reaction can be used as a stand-alone application, but it also integrates seamlessly into many of the most popular backup applications, providing enhanced functionality at no additional expense.

Preparing for data disasters: Despite hard disk drive manufacturers' efforts to produce hard disk drives that won't fail, occasionally they do. And when they do, it can be a catastrophe for your business.

That's why leading hard disk drive manufacturers created an industry standard for hard disk drives called Self-Monitoring, Analysis and Reporting Technology (S.M.A.R.T.) S.M.A.R.T. drives are designed to monitor specific parameters of their own performance, such as the rate of read-write errors, and issue an alert when these parameters indicate a potential problem. (Approximately 60% of hard disk failures are predictable.) The alert can be sent to the user and/or a network administrator, who can then back up the data on the drive and request a timely repair.

IBM SMART Reaction software goes an important step further by responding to a S.M.A.R.T. drive alert automatically, even if the system and network are unattended. Upon receiving a S.M.A.R.T. alert, SMART Reaction software can immediately start backing up the disk's data to a server or other data device of your choice. SMART Reaction can also be programmed to initiate a response that will help ensure timely repair of the faulty drive, from e-mailing a network administrator to paging a technician.

### IBM SMART Reaction

IBM SMART Reaction adds an important new tool to IBM's comprehensive suite of asset protection solutions, which provide customers with system security and data protection capabilities that help protect technology and information assets. These enhanced capabilities help to offer the "Total Benefit of Ownership" (TBO).

IBM SMART Reaction is a client/server application that allows a network administrator to perform:

## Chapter 6. IBM System Management Tools

- Regularly scheduled system backups (attended or unattended).
- Continuous or periodic backups (mirroring) of critical data files.
- Emergency system backups when a S.M.A.R.T. Predictive Failure alert is issued.

SMART Reaction builds upon and complements the full range of systems management features found in IBM commercial PCs, including Wake on LAN, LANClient Control Manager (LCCM), DMI BIOS, Instrumentation Code and S.M.A.R.T. hard disk drives.

The SMART Reaction application consists of two components:

1. The SMART Reaction Manager, which resides on a Windows NT 4.0 system (either a server or a workstation), and
2. The SMART Reaction Client, which resides on the client system and supports either Windows 95 or Windows NT 4.0 Workstation.

In the SMART Reaction environment, S.M.A.R.T. technologies included in each client hard disk drive monitor the disk periodically using a technique known as Predictive Failure Analysis (PFA). If the hard disk drive begins to experience a high number of retries when reading or writing data, a S.M.A.R.T. Alert is passed to the DMI Instrumentation Code running on the client system. This alert is then passed to the SMART Reaction Client application, which will automatically respond to the potential failure based on administrator-defined policies.

### How SMART Reaction Responds to a Potential Problem

Once SMART Reaction on the client system receives a S.M.A.R.T. alert, it can respond in several ways as defined by the network administrator:

#### 1. Notification

The first response is to notify the user and/or selected support personnel and administrators that there is a potential problem with the client system hard disk drive. The user can be notified with a pop-up message that can be customized to include information such as detailed instructions, telephone numbers, etc. SMART Reaction can also send an e-mail notification of the problem to appropriate persons at local or remote addresses. Finally, SMART Reaction can also be programmed to issue a pager notification if the server has telephony support.

#### 2. Data backup with legacy tools

To help protect your critical data, the SMART Reaction Manager can automatically begin a backup process using your network's legacy backup software. SMART Reaction is compatible with many of the industry-leading backup programs from manufacturers such as Seagate, Cheyenne, AD5M, etc.) This capability helps ensure that IBM PCs that support SMART Reaction technology can be integrated seamlessly into your existing network. SMART Reaction will simply pass the backup command to your backup software for processing via your normal procedures.

#### 3. Backup with SMART Reaction

SMART Reaction also includes its own set of robust backup capabilities that enable it to protect your data without relying on other backup software. A DMI alert passed to the SMART Reaction Manager includes information such as drive size, partitioning, file format and current capacity. This enables SMART Reaction Manager to allocate the necessary space on the administrator-defined backup file server. Once the space is allocated, SMART Reaction Client transfers all of the data on the client hard disk to the server.

#### 4. Continuous data mirroring

Aside from the initial S.M.A.R.T. alert notification, SMART Reaction can be configured such that the user does not need to take any action to continue working and remain productive. That's because SMART Reaction will automatically copy any new data they save to the selected file server. In



essence, there will be a "mirror-image" of their hard drive maintained on the server until such time as their local drive is repaired. Network administrators can program the frequency of the data mirroring to provide this functionality without compromising system performance needlessly.

### **SMART Reaction Restore Process**

Now that the user's data is protected, SMART Reaction's innovative functionality continues to provide assistance to the technician or administrator responsible for repairing the client system.

First, someone must physically install a new hard disk drive into the client's system. Then, critical software and the backed-up data must be re-installed on the system. Without SMART Reaction, the network administrator would have to sit at the client's system and install the operating system, drivers and applications and then copy the backed-up data from a remote server. With SMART Reaction, this software and data restoration can be performed remotely and unattended.

To get the user back on-line, the network administrator can simply invoke the SMART Reaction server application and schedule a convenient time to Restore the failed client. Working in tandem with IBM Wake On LAN technology and LANClient Control Manager (LCCM) software, the Restore operation can take place at any time, even after the system has been powered off. SMART Reaction can automatically restore the user's system to its original state, including the data present at the time of the S.M.A.R.T. Alert as well as any data generated while waiting for the replacement hard disk drive.

### **Critical Data Mirroring**

SMART Reaction can also help you protect your most critical data all of the time, not just when a hard disk drive issues a Predictive Failure alert. The software's data-mirroring capabilities can be used full-time to create continually refreshed copies of selected data on a file server.

This redundant storage helps ensure that any critical data is available in two places—on the client and on a server. Such data is protected even if the client system is stolen or experiences an unpredictable failure.

Obviously, due to server space and network traffic constraints, you may not want to constantly mirror data from every client — you can select only the data that is most important to your business. But SMART Reaction is capable of mirroring up to 64 client directories, including their subdirectories, at a time. And you can program how often data is mirrored to achieve an optimum balance of data protection and system performance.

### **Intel LANDesk Client Manager**

The LANDesk Client Manager is a DMI compliant management application that supplies a user-friendly DMI management interface and component instrumentation. This application provides self-help tools, including a PC health meter, local alerting of potential problems, and hardware inventories. It automatically polls hardware to detect failure conditions and proactively alerts the user of potential problems. When the computer is connected to a network with LANDesk Workgroup Manager, hardware information and alerts can be retrieved across the network.

---

### Advanced Configuration and Power Interfaces (ACPI)

Advanced Configuration and Power Interfaces (ACPI) will provide a standard means to integrate power management features throughout a system, including hardware, operating systems, and application software. With such integration and power management, the system can automatically turn off and on peripherals such as CD-ROMs, network cards, hard disk drives and printers as well as consumer devices connected to the PC, including VCRs, TVs, phones, and stereos. ACPI technology will also enable peripherals to activate and deactivate the PC. Other ACPI specification points of emphasis include the following:

- ACPI specifies a register-level interface to core power management functions and a descriptive interface for additional hardware features.
- ACPI provides a generic system event mechanism for Plug and Play, in addition to an operating system-independent interface for configuration control.
- ACPI leverages Plug and Play BIOS data structures while providing a processor architecture independent implementation-compatible with both Windows 95 and Windows NT.
- ACPI represents the foundation of the Microsoft OnNow initiative. OnNow represents a system-wide approach to system and device power control. OnNow is a term for a PC that is always on but appears off and responds to user or other requests.

---

### Wake on LAN

- Enhances remote management by enabling file updating and asset tracking on powered-off computers.
- Permits remote system setup, updates and asset tracking to occur after hours and on weekends so daily LAN traffic is kept to a minimum and users are not interrupted.
- Helps increase productivity of LAN administrators and computer users.
- Available on all current IBM IntelliStation E Pro models.

Wake on LAN is a technology that enables you to remotely manage the clients in your network even if they have been turned off. With the need to provide consistent and timely updates, such a feature brings new levels of control, simplicity and savings to LAN-based networks.

IBM IntelliStation E Pro offers many features designed to help reduce your total cost of doing business. Working with Intel through the AMA, IBM has devised a number of ways to integrate system management software with intelligent hardware. Wake on LAN, LANClient Control Manager (LCCM), IBM Netfinity Manager and Intel LANDesk Client Manager are system management tools that work together to attack your computing costs by allowing you to automate time-consuming, tedious PC management tasks and schedule these tasks for a time that is the least disruptive to users. Wake on LAN turns on the networked computers, and then your choice of these network management tools handles remote management operations and asset tracking. As long as the computers in the network are Wake on LAN-enabled and electricity is available, Wake on LAN can turn on any or all of the PCs in your network so that LCCM, IBM Netfinity Manager or LANDesk can perform the management tasks you've defined.

### Wake on LAN components

Wake on LAN requires the following components:

- A Wake on LAN-enabled Token-Ring or Ethernet LAN adapter card

These adapters are either preinstalled, integrated on the system board, or can be installed on current IBM IntelliStation E Pro computers. Support for both Token-Ring and Ethernet gives you a choice of network types, while allowing you to change from one type to the other by simply changing adapter cards.

- Wake on LAN capability built in

In IBM IntelliStations that have a Wake on LAN-enabled LAN adapter card integrated or installed, the LAN adapter interfaces are as follows.

- Network interface to decode the wake-up frame. This is how the LAN adapter determines whether the wake-up frame is addressed to the client.
- Auxiliary power interface for auxiliary adapter power source. A wire runs from the client's power supply to the adapter card. This wire supplies 5 volts of power, which the adapter card needs to turn on the client. Power is available while the client is plugged into an electrical outlet that is receiving power.
- Wake-up signal interface. The adapter uses this interface to notify the client that it has received a wake-up frame.
- System bus interface. This interface is for reading and writing control information that is specific to the wake-up function.

- Software to trigger the wake-up frame

Remote network management software is required to send a special wake-up frame to the Wake on LAN-enabled LAN adapter.

### How Wake on LAN works

The following sequence of events occurs when Wake on LAN turns on your computer:

1. Remote network management software, such as LANClient Control Manager or IBM Netfinity Manager, sends a wake-up frame to the computer. The wake-up frame is based on industry-standard Magic Packet specifications. See "Definition of the Wake-up Frame" for a description of the wake-up frame's contents.
2. The Wake on LAN-enabled adapter in the computer receives the wake-up frame and analyzes it to determine whether the frame contains the client's media access control (MAC) address.
3. If the frame contains the computer's MAC address and if CMOS is enabled, the computer turns on, just as if you turned it on using the On/Off switch.
4. The remote network management software performs the tasks that it has been programmed to perform.

### Definition of the Wake-up Frame

The wake-up frame contains a unique data field not normally expected in typical traffic on a LAN. When a Wake on LAN-enabled adapter on a turned-off computer decodes this data field, a wake-up signal is generated. This wake-up signal causes the computer to power on.

The key to the wake-up frame is the MAC address of the target computer, which is repeated 16 times. This pattern of 16 addresses in the data field is not expected to occur in any normal LAN frame other than the specific wake-up frame.

The destination address can be either a specific address or a broadcast address. If the destination address is a specific address, the wake-up frame is sent only to the computer at that address. However, since the computer is powered off and no longer transmitting, some protocols remove this computer's MAC address from routing tables and internal caches at other nodes. In this case, wake-up frames addressed directly to the target computer are discarded because nodes and routers do not know where to send them.

The solution to this problem is to use a broadcast address. A directed broadcast has a valid network address and a broadcast host address. Network routers and nodes forward directed broadcasts to the

## Chapter 6. IBM System Management Tools

appropriate network, where it is seen as a MAC-level broadcast and detected by the powered off computer.

### Give your IntelliStations a wake-up call

IBM is committed to providing you highly manageable computers so your company can reclaim excessive resources applied to IT management. Central to this commitment is the AMA-working together to integrate system management software with intelligent hardware, IBM and Intel have made Wake on LAN an industry standard that's changing the way companies manage their PCs. The alliance is already yielding dividends for customers, with the incorporation of IBM Wake on LAN functionality into Intel's 10/100 and 10BaseT Ethernet adapters and LANDesk software. The remote setup and management capabilities of the IBM IntelliStation E Pro mean that you can greatly reduce the need for technicians to visit individual systems to perform management tasks, keeping your IS group and the users they support more productive.

---

### IBM LANClient Control Manager version 2.0 (LCCM)

- IBM LANClient Control Manager (LCCM) version 2.0 is a server-based application that simplifies the setup, configuration, rollout and ongoing lower-level management of networked IBM computers.
- LCCM incorporates a "push" rather than a "pull" approach, so that network administrators can gain control of a computer over a network to perform tasks that would normally require their physical presence at the computer. It can significantly reduce the costs of deploying and maintaining computers by reducing the number of visits to each machine.
- LCCM is a preboot application, which allows administrators to remotely update a system's BIOS, change CMOS settings, execute commands such as FDISK or FORMAT, or install a new operating system.
- LCCM v2.0 adds support for clients using the industry-standard DHCP/PXE protocol, which allows identification of specific systems over one or more routers. LCCM continues to support the Remote Program Load (RPL) protocol as an alternative management preboot agent.
- LCCM v2.0 can retrieve PC information recorded using an Asset ID-compatible device. You can use Asset ID to indicate the necessary software image for end users, before the computer is even unpacked. Later, after the compute is plugged in, LCCM can deliver the correct software automatically.
- LCCM is licensed for use at no additional charge for IBM IntelliStation E Pro systems. It is available for downloading from the Web at

<http://www.pc.ibm.com/us/intellistation/benefit/lccm.html>

LCCM v2.0 is a server-based software tool that enables remote and unattended configuration, deployment, redeployment and ongoing lower-level management of IBM PCs. Since LCCM gains control of a PC before it boots its local operating system, many of the lower-level tasks that previously required a visit to each client can now be performed over the network. Using LCCM, a network administrator can:

- Remotely identify a client and gather important vital product data such as serial number, machine type model, system memory, hard disk drive capacity and BIOS level.
- Capture information about end users and their software requirements that has been entered through the use of a handheld Asset ID unit.
- Prompt users (if present) for specific information about their name, department, location, etc. and capture this information into the client hardware information.
- Export captured client information to other tools for inclusion in higher level, workgroup and enterprise-wide systems management offerings.
- Remotely install via image copy or unattended installation an operating environment such as Windows 95 or Windows NT.
- Schedule client configurations or updates to occur once or periodically.

- Manage hundreds of clients from a single server and configure up to 32 simultaneously (assuming available bandwidth).
- Modify a system's CMOS settings (e.g., change boot sequences, enable/disable onboard components, restore passwords, etc.)
- Update or flash a system's BIOS (e.g., use a newer or older level of BIOS for enterprise-wide consistency or change the BIOS to match the local language).
- Assign or change the administrator password on one or more client workstations to protect the BIOS settings against unauthorized end-user changes.
- Power-on client systems by sending a Magic Packet to specific Wake on LAN-enabled systems or docking stations.
- Schedule events to take place unattended on a specific date and at a specified time as a onetime event, or on a recurring basis (e.g., to execute complete or partial system backups and virus scans, or simply to power-on a client at specific intervals).

When combined with the other robust management features of IBM PCs, such as Wake on LAN, LCCM helps make system deployment and configuration as simple as plug-in-and-go. Once the systems are plugged into a power supply and network, the rest of the client setup can be performed remotely from a network console. Using LCCM, you can schedule a convenient time to power the systems up, flash their BIOS to ensure consistency across your organization, download the appropriate software image for each user, and then power the systems down.

LCCM is also useful throughout a system's life cycle for performing preboot management functions, such as formatting a hard disk drive over a network. This software complements popular postboot client management software tools such as Tivoli TME 10, Microsoft's System Management Server, Intel LANDesk Client Manager, and Computer Associates' TNG Unicenter.

LCCM is made possible, in part, by the IBM/Intel Advanced Manageability Alliance (AMA). The AMA builds on industry-standard technology to create new, more effective solutions for customers, such as Wake on LAN. LCCM v2.0 is industry-standard-based, incorporating support for DHCP and the Preboot eXecution Environment (PXE) defined in the 1997 NetPC Guideline and preliminary Lean Client specifications, as well as the Remote Program Load (RPL) boot protocol used by the industry since 1986.

LCCM works with IBM systems shipped as early as February 1996 that are equipped with a supported IBM Token-Ring or Ethernet Wake on LAN network interface adapter.

### System Deployment

LCCM can significantly reduce the time and resources required to deploy or redeploy IBM PCs, especially when installation of a custom software image is needed.

First, LCCM needs to gain control of the client. This can occur automatically the first time the user powers the system on, or the network administrator can power the system remotely using Wake on LAN. LCCM can generate the Magic Packet(s) needed to power one or more PCs over the network. The Magic Packet identifies each specific PC through the unique MAC address assigned to every network interface device.

LCCM can broadcast a Magic Packet on local area networks made up of hubs, bridges, and switches. LCCM can also wake a client on the other side of a router if the administrator includes the subnet address of the router. LCCM wraps the subnet address with the Magic Packet so that it can travel across router(s) to the local domain where the client resides before the packet is broadcast on the LAN.

As the IBM PC powers on for the first time on the network, it will query the network before booting from its local hard disk drive. LCCM's Scan (discovery) feature will recognize that a new system has been added

## Chapter 6. IBM System Management Tools

to the network and respond with a signal that allows the network to gain control of the client and prevents the local operating system from loading.

LCCM will then query the client for vital product data through its Systems Management BIOS and Wired for Management/DMI features. LCCM creates a client profile as part of an Individual Client Details record and database with this information (e.g., machine type and serial number, disk, memory size, graphics/video chipset, MAC address, BIOS level and more.)

If the PC is equipped with Asset ID, as are select models of IBM client system PCs and IntelliStations, LCCM can also recover any information that has been recorded about the user. Asset ID allows an administrator using a radio-frequency handheld unit to record information to a system EEPROM without even opening the system's packing carton.

Otherwise, LCCM assigns a default name to the client during the scan, and can optionally prompt the end user to enter personal information such as his location, department and phone number, etc.. If a user is not present, this request will automatically time-out. The data collected is entered automatically into the Individual Client Details record.

### Flashing the CMOS or BIOS

The LCCM administrator can use the information gathered from the client to review its CMOS settings and BIOS level. In some cases, these may need to be changed to ensure consistency across the enterprise or to conform to corporate policies.

Since LCCM gains control of the system before the local operating system was booted, LCCM allows administrators to remotely perform low-level maintenance tasks, like flashing the BIOS, that need to occur during the preboot state. The only alternatives are to involve the end user or send a technician to each client. LCCM is complementary to postboot management tools, which need a local operating system running, such as DMI browsers or software change management programs.

### Installing Software

Next, the network administrator uses the information that LCCM has gathered about the client to determine the end user's software requirements, including operating system and applications. (When Asset ID is used, this step can be simplified by recording the end user's software profile to the system EEPROM.)

The software can come from one of two sources: a compressed software "image" that includes a copy of all of the software needed by the local client, or from installation files located on a file server. In either case, the software can be downloaded to the client without intervention by the user or the administrator.

### LCCM New Client Scenario

1. LCCM Administrator starts scanning the network for new PCs
2. 2 PCs found. LCCM displays PC serial #, captures and associates vital product data, etc.
3. LCCM creates Individual Client Details notebook for new clients
4. Administrator assigns clients to software profiles
  - Administrator examines level of BIOS
  - Elects to update BIOS and distribute a different image to each PC—one used by Marketing, one by Accounting, using Hybrid RPL
  - Schedules the update to occur on Saturday at 7:00 am and to use Wake on LAN to turn on the PC Saturday morning, 7:00 am
5. Server awakens the new client PCs with Wake on LAN PC uses alternate boot sequence to boot to server, processes job, sends message to server when done

### 6. LCCM acknowledges PC and tells system to reboot locally-DONE

Perhaps the most convenient feature of LCCM is a scheduling feature that allows an administrator to perform the above tasks at the most convenient time, when they will have the least impact on user productivity and network traffic. When used with Wake on LAN, LCCM can perform its routine even if the client was initially in a powered-off state.

## Low-level Management

LCCM operates by establishing LAN communications between the IBM client and the managing server before loading its operating system from a local hard disk drive. In this way, low-level maintenance tasks like formatting a hard drive, changing the BIOS, or reinstalling an operating system, can be performed without end-user involvement, even if the client operating system is unable to boot. Using LCCM, routines like FORMAT and FDISK can now be performed over a network, eliminating the need for an administrator or technician to visit the client.

LCCM's scheduling feature helps to ensure that low-level management tasks do not interfere with user productivity, because they can be performed at a time when both users and network support staff are home asleep.

### LCCM v2.0 enhancements over LCCM v1.

LCCM v1.X used remote program load (RPL), a non-routable protocol, while LCCM v2.0 uses DHCP and Preboot eXecution Environment (PXE) extension, which is a routable protocol. The protocol was changed for v2.0 because many customers have routers on the same floor as well as throughout their organization, so RPL restricted the usefulness of LCCM.

The RPL process also required LCCM to have a list of supported network adapters and a range of their MAC addresses in a network.lst file and their associated device drivers, which were downloaded to the client to be managed along with the Universal Configuration Agent (UCA). LCCM v2.0 does not have this restriction because it supplies the Universal Network Device Interface (UNDI) services needed by the network interface card generating the DHCP/PXE frame.

Because of the change from RPL to DHCP, LCCM v2.0 needs to be installed on a Windows NT Server configured with DHCP services. This means v2.0 is a replacement for v1.X and not a simple upgrade. Client Profile information from v1.X must be saved and then restored to v2.0.

Before LCCM, users or network support personnel needed to be physically present at each client to perform tasks such as installing a custom software configuration or reformatting a hard drive. By incorporating a "push" instead of a "pull" approach, a network administrator can perform these time-consuming tasks remotely. When combined with other advanced manageability features such as Wake on LAN and Asset ID, LCCM makes setting up IBM PCs much easier.

LCCM can save customers and IBM remarketers significant costs by reducing the time and personnel required to deploy and manage PCs. LCCM is a key component in the IBM strategy to help customers regain control over their technology so they can better manage their business, and their budget.

---

# Chapter 7. System Compatibility

This chapter discusses some of the hardware, software, and BIOS compatibility issues for the computer. Refer to &comp. for a list of compatible hardware and software options.

---

## Hardware Compatibility

This section discusses hardware, software, and BIOS compatibility issues that must be considered when designing application programs.

Many of the interfaces are the same as those used by the IBM Personal Computer AT. In most cases, the command and status organization of these interfaces is maintained.

The functional interfaces are compatible with the following interfaces:

- Intel 8259 interrupt controllers (edge-triggered mode)
- National Semiconductor NS16450 and NS16550A serial communication controllers
- Motorola MC146818 Time of Day Clock command and status (CMOS reorganized)
- Intel 8254 timer, driven from a 1.193 MHz clock (channels 0, 1, and 2)
- Intel 8237 DMA controller, except for the Command and Request registers and the Rotate and Mask functions; the Mode register is partially supported
- Intel 8272 or 82077 diskette drive controllers
- Intel 8042 keyboard controller at addresses hex 0060 and hex 0064
- All video standards using VGA, EGA, CGA, MDA, and Hercules modes
- Parallel printer ports (Parallel 1, Parallel 2, and Parallel 3) in compatibility mode

Use the above information to develop application programs. Whenever possible, use the BIOS as an interface to hardware to provide maximum compatibility and portability of applications among systems.



## Hardware Interrupts

Hardware interrupts are level sensitive for PCI interrupts and edge sensitive for ISA interrupts. The interrupt controller clears its in-service register bit when the interrupt routine sends an End-of-Interrupt (EOI) command to the controller. The EOI command is sent regardless of whether the incoming interrupt request to the controller is active or inactive.

The interrupt-in-progress latch is readable at an I/O-address bit position. This latch is read during the interrupt service routine and might be reset by the read operation or it might require an explicit reset.

**Note:** For performance and latency considerations, designers might want to limit the number of devices sharing an interrupt level.

With level-sensitive interrupts, the interrupt controller requires that the interrupt request be inactive at the time the EOI command is sent; otherwise, a new interrupt request will be detected. To avoid this, a level-sensitive interrupt handler must clear the interrupt condition (usually by a read or write operation to an I/O port on the device causing the interrupt). After processing the interrupt, the interrupt handler:

1. Clears the interrupt
2. Waits one I/O delay
3. Sends the EOI
4. Waits one I/O delay
5. Enables the interrupt through the Set Interrupt Enable Flag command

Hardware interrupt IRQ9 is defined as the replacement interrupt level for the cascade level IRQ2. Program interrupt sharing is implemented on IRQ2, interrupt hex 0A. The following processing occurs to maintain compatibility with the IRQ2 used by IBM Personal Computer products:

1. A device drives the interrupt request active on IRQ2 of the channel.
2. This interrupt request is mapped in hardware to IRQ9 input on the second interrupt controller.
3. When the interrupt occurs, the system microprocessor passes control to the IRQ9 (interrupt hex 71) interrupt handler.
4. This interrupt handler performs an EOI command to the second interrupt controller and passes control to the IRQ2 (interrupt hex 0A) interrupt handler.
5. This IRQ2 interrupt handler, when handling the interrupt, causes the device to reset the interrupt request before performing an EOI command to the master interrupt controller that finishes servicing the IRQ2 request.

### Diskette Drives and Controller

The following figures show the reading, writing, and formatting capabilities of each type of diskette drive.

Diskette Drive Type	250/500 KB Mode	300/500 KB Mode	1 MB Mode
Single sided (48 Tracks Per Inch (TPI))	RWF	—	—
Double sided (48 TPI)	RWF	RWF	—
High capacity (1.2 MB)	RWF	RWF	RWF

Diskette Drive Type	720 KB Mode	1.44 MB Mode
1.44 MB drive	RWF	RWF

#### Notes:

1. Do not use either a 250/500 KB or 300/500 KB diskette drive for 5.25-inch diskettes that are designed for the 1.2MB mode.
2. Low-density 5.25-inch diskettes that are written to or formatted by a high-capacity 1.2 MB diskette drive can be reliably read only by another 1.2 MB diskette drive.

#### Copy Protection

The following methods of copy protection might not work in systems using the 3.5-inch 1.44 MB diskette drive.

- Bypassing BIOS routines
  - Data transfer rate: BIOS selects the proper data transfer rate for the media being used.
  - Diskette parameter table: Copy protection, which creates its own diskette parameter table, might not work in these drives.
- Diskette drive controls
  - Rotational speed: The time between two events in a diskette drive is a function of the controller.
  - Access time: Diskette BIOS routines must set the track-to-track access time for the different types of media that are used in the drives.
  - 'Diskette change' signal: Copy protection might not be able to reset this signal.
- Write-current control: Copy protection that uses write-current control does not work, because the controller selects the proper write current for the media that is being used.

## Hard Disk Drives and Controller

Reading from and writing to the hard disk is initiated in the same way as in IBM Personal Computer products; however, new functions are supported.

---

## Software Compatibility

To maintain software compatibility, the interrupt polling mechanism that is used by IBM Personal Computer products is retained. Software that interfaces with the reset port for the IBM Personal Computer positive-edge interrupt sharing (hex address 02Fx or 06Fx, where x is the interrupt level) does not create interference.

## Software Interrupts

With the advent of software interrupt sharing, software interrupt routines must daisy chain interrupts. Each routine must check the function value, and if it is not in the range of function calls for that routine, it must transfer control to the next routine in the chain. Because software interrupts are initially pointed to address 0:0 before daisy chaining, check for this case. If the next routine is pointed to address 0:0 and the function call is out of range, the appropriate action is to set the carry flag and do a RET 2 to indicate an error condition.

## Machine-Sensitive Programs

Programs can select machine-specific features, but they must first identify the machine and model type. IBM has defined methods for uniquely determining the specific machine type. The machine model byte can be found through Interrupt 15H, Return System Configuration Parameters function (AH)=C0H).

## Appendix A. Connector Pin Assignments

The following figures show the pin assignments for various system board connectors.

### Memory Connectors

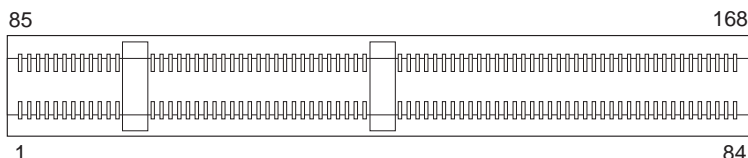

Figure 27 (Page 1 of 3). System Memory Connector Pin Assignments

Pin	x64 Non-Parity	x72 ECC	Pin	x64 Non-Parity	x72 ECC
1	VSS	VSS	85	VSS	VSS
2	DQ0	DQ0	86	DQ32	DQ32
3	DQ1	DQ1	87	DQ33	DQ33
4	DQ2	DQ2	88	DQ34	DQ34
5	DQ3	DQ3	89	DQ35	DQ35
6	VCC	VCC	90	VCC	VCC
7	DQ4	DQ4	91	DQ36	DQ36
8	DQ5	DQ5	92	DQ37	DQ37
9	DQ6	DQ6	93	DQ38	DQ38
10	DQ7	DQ7	94	DQ39	DQ39
11	DQ8	DQ8	95	DQ40	DQ40
12	VSS	VSS	96	VSS	VSS
13	DQ9	DQ9	97	DQ41	DQ41
14	DQ10	DQ10	98	DQ42	DQ42
15	DQ11	DQ11	99	DQ43	DQ43
16	DQ12	DQ12	100	DQ44	DQ44
17	DQ13	DQ13	101	DQ45	DQ45
18	VCC	VCC	102	VCC	VCC
19	DQ14	DQ14	103	DQ46	DQ46
20	DQ15	DQ15	104	DQ47	DQ47
21	NC	CB0	105	NC	CB4
22	NC	CB1	106	NC	CB5
23	VSS	VSS	107	VSS	VSS
24	NC	NC	108	NC	NC
25	NC	NC	109	NC	NC
26	VCC	VCC	110	VCC	VCC
27	/WE	/WE0	111	/CAS	/CAS
28	DQMB0	DQMB0	112	DQMB4	DQMB4
29	DQMB1	DQMB1	113	DQMB5	DQMB5
30	/S0	/S0	114	NC	/S1
31	DU	NC	115	/RAS	/RAS

*Figure 27 (Page 2 of 3). System Memory Connector Pin Assignments*

Pin	x64 Non-Parity	x72 ECC	Pin	x64 Non-Parity	x72 ECC
32	VSS	VSS	116	VSS	VSS
33	A0	A0	117	A1	A1
34	A2	A2	118	A3	A3
35	A4	A4	119	A5	A5
36	A6	A6	120	A7	A7
37	A8	A8	121	A9	A9
38	A10/AP	A10/AP	122	BA0	BA0
39	NC	BA1	123	NC	A11
40	VCC	VCC	124	VCC	VCC
41	VCC	VCC	125	CK1	CK1
42	CK0	CK0	126	A12	A12
43	VSS	VSS	127	VSS	VSS
44	DU	NC	128	CKE0	CKE0
45	/S2	/S2	129	NC	/S3
46	DQMB2	DQMB2	130	DQMB6	DQMB6
47	DQMB3	DQMB3	131	DQMB7	DQMB7
48	DU	NC	132	A13	A13
49	VCC	VCC	133	VCC	VCC
50	NC	NC	134	NC	NC
51	NC	NC	135	NC	NC
52	NC	CB2	136	NC	CB6
53	NC	CB3	137	NC	CB7
54	VSS	VSS	138	VSS	VSS
55	DQ16	DQ16	139	DQ48	DQ48
56	DQ17	DQ17	140	DQ49	DQ49
57	DQ18	DQ18	141	DQ50	DQ50
58	DQ19	DQ19	142	DQ51	DQ51
59	VCC	VCC	143	VCC	VCC
60	DQ20	DQ20	144	DQ52	DQ52
61	NC	NC	145	NC	NC
62	NC	NC	146	NC	NC
63	NC	CKE1	147	NC	NC
64	VSS	VSS	148	VSS	VSS
65	DQ21	DQ21	149	DQ53	DQ53
66	DQ22	DQ22	150	DQ54	DQ54
67	DQ23	DQ23	151	DQ55	DQ55
68	VSS	VSS	152	VSS	VSS
69	DQ24	DQ24	153	DQ56	DQ56
70	DQ25	DQ25	154	DQ57	DQ57
71	DQ26	DQ26	155	DQ58	DQ58
72	DQ27	DQ27	156	DQ59	DQ59
73	VCC	VCC	157	VCC	VCC
74	DQ28	DQ28	158	DQ60	DQ60

## Appendix A. Connector Pin Assignments

*Figure 27 (Page 3 of 3). System Memory Connector Pin Assignments*

Pin	x64 Non-Parity	x72 ECC	Pin	x64 Non-Parity	x72 ECC
75	DQ29	DQ29	159	DQ61	DQ61
76	DQ30	DQ30	160	DQ62	DQ62
77	DQ31	DQ31	161	DQ63	DQ63
78	VSS	VSS	162	VSS	VSS
79	CK2	CK2	163	CK3	CK3
80	NC	NC	164	NC	NC
81	NC	NC	165	SA0	SA0
82	SDA	SDA	166	SA1	SA1
83	SCL	SCL	167	SA2	SA2
84	VCC	VCC	168	VCC	VCC

## ISA Connectors

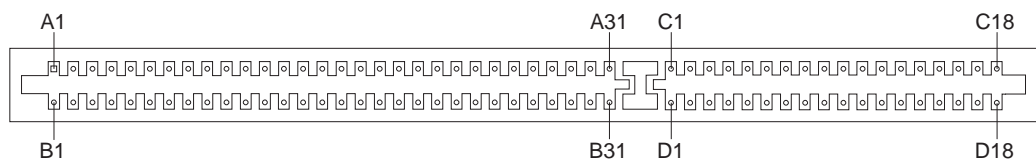

**Note:** The ISA connectors are on the riser card.

*Figure 28 (Page 1 of 2). ISA Connector Pin Assignments*

Pin	Signal	I/O	Pin	Signal	I/O
B1	Ground	NA	A1	IOCHCK#	I
B2	RESET DRV	O	A2	SD7	I/O
B3	+5 V dc	NA	A3	SD6	I/O
B4	IRQ2	I	A4	SD5	I/O
B5	-5 V dc	NA	A5	SD4	I/O
B6	DRQ2	I	A6	SD3	I/O
B7	-12 V dc	NA	A7	SD2	I/O
B8	OWS#	I	A8	SD1	I/O
B9	+12 V dc	NA	A9	SD0	I/O
B10	Ground	NA	A10	IOCHRDY	I
B11	SMEMW#	O	A11	AEN	O
B12	SMEMR#	O	A12	SA19	I/O
B13	IOW#	I/O	A13	SA18	I/O
B14	IOR#	I/O	A14	SA17	I/O
B15	DACK3#	O	A15	SA16	I/O
B16	DRQ3	I	A16	SA15	I/O
B17	DACK1#	O	A17	SA14	I/O
B18	DRQ1	I	A18	SA13	I/O
B19	REFRESH#	I/O	A19	SA12	I/O
B20	CLK	O	A20	SA11	I/O
B21	IRQ7	I	A21	SA10	I/O

*Figure 28 (Page 2 of 2). ISA Connector Pin Assignments*

Pin	Signal	I/O	Pin	Signal	I/O
B22	IRQ6	I	A22	SA9	I/O
B23	IRQ5	I	A23	SA8	I/O
B24	IRQ4	I	A24	SA7	I/O
B25	IRQ3	I	A25	SA6	I/O
B26	DACK2#	O	A26	SA5	I/O
B27	TC	O	A27	SA4	I/O
B28	BALE	O	A28	SA3	I/O
B29	+5 V dc	NA	A29	SA2	I/O
B30	OSC	O	A30	SA1	I/O
B31	Ground	NA	A31	SA0	I/O
D1	MEMCS16#	I	C1	SBHE#	I/O
D2	IOCS16#	I	C2	LA23	I/O
D3	IRQ10	I	C3	LA22	I/O
D4	IRQ11	I	C4	LA21	I/O
D5	IRQ12	I	C5	LA20	I/O
D6	IRQ15	I	C6	LA19	I/O
D7	IRQ14	I	C7	LA18	I/O
D8	DACK0#	O	C8	LA17	I/O
D9	DRQ0	I	C9	MEMR#	I/O
D10	DACK5#	O	C10	MEMW#	I/O
D11	DRQ5	I	C11	SD8	I/O
D12	DACK6#	O	C12	SD9	I/O
D13	DRQ6	I	C13	SD10	I/O
D14	DACK7#	O	C14	SD11	I/O
D15	DRQ7	I	C15	SD12	I/O
D16	+5 V dc	NA	C16	SD13	I/O
D17	MASTER#	I	C17	SD14	I/O
D18	Ground	NA	C18	SD15	I/O

**PCI Connectors**

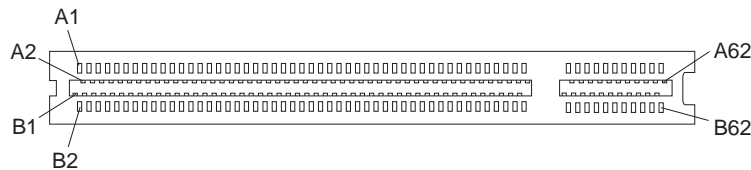

*Figure 29. PCI Bus Connector*

**Note:** The PCI connectors are on the riser card.

*Figure 30 (Page 1 of 3). PCI Connector Pin Assignments*

Pin	Signal	I/O	Pin	Signal	I/O
A1	TRST#	O	B1	-12 V dc	NA

## Appendix A. Connector Pin Assignments

*Figure 30 (Page 2 of 3). PCI Connector Pin Assignments*

Pin	Signal	I/O	Pin	Signal	I/O
A2	+12 V dc	NA	B2	TCK	O
A3	TMS	O	B3	Ground	NA
A4	TDI	O	B4	TDO	I
A5	+5 V dc	NA	B5	+5 V dc	NA
A6	INTA#	I	B6	+5 V dc	NA
A7	INTC#	I	B7	INTB#	I
A8	+5 V dc	NA	B8	INTD#	I
A9	Reserved	NA	B9	PRSNT1#	I
A10	+5 V dc (I/O)	NA	B10	Reserved	NA
A11	Reserved	NA	B11	PRSNT2	I
A12	Ground	NA	B12	Ground	NA
A13	Ground	NA	B13	Ground	NA
A14	Reserved	NA	B14	Reserved	NA
A15	RST#	O	B15	Ground	NA
A16	+5 V dc (I/O)	NA	B16	CLK	O
A17	GNT#	O	B17	Ground	NA
A18	Ground	NA	B18	REQ#	I
A19	Reserved	NA	B19	+5 V dc (I/O)	NA
A20	Address/Data 30	I/O	B20	Address/Data 31	I/O
A21	+3.3 V dc	NA	B21	Address/Data 29	I/O
A22	Address/Data 28	I/O	B22	Ground	NA
A23	Address/Data 26	I/O	B23	Address/Data 27	I/O
A24	Ground	I/O	B24	Address/Data 25	NA
A25	Address/Data 24	I/O	B25	+3.3 V dc	NA
A26	IDSEL	O	B26	C/BE 3#	I/O
A27	+3.3 V dc	NA	B27	Address/Data 23	I/O
A28	Address/Data 22	I/O	B28	Ground	NA
A29	Address/Data 20	I/O	B29	Address/Data 21	I/O
A30	Ground	I/O	B30	Address/Data 19	NA
A31	Address/Data 18	I/O	B31	+3.3 V dc	NA
A32	Address/Data 16	I/O	B32	Address/Data 17	I/O
A33	+3.3 V dc	NA	B33	C/BE 2#	I/O
A34	FRAME#	I/O	B34	Ground	NA
A35	Ground	NA	B35	IRDY#	I/O
A36	TRDY#	I/O	B36	+3.3 V dc	NA
A37	Ground	NA	B37	DEVSEL#	I/O
A38	STOP#	I/O	B38	Ground	NA
A39	+3.3 V dc	NA	B39	LOCK#	I/O
A40	SDONE	I/O	B40	PERR#	I/O
A41	SBO#	I/O	B41	+3.3 V dc	NA
A42	Ground	NA	B42	SERR#	I/O
A43	+3.3 V dc	NA	B43	+3.3 V dc	NA
A44	C/BE(1)#	I/O	B44	C/BE 1#	I/O



*Figure 30 (Page 3 of 3). PCI Connector Pin Assignments*

Pin	Signal	I/O	Pin	Signal	I/O
A45	Address/Data 14	I/O	B45	Address/Data 14	I/O
A46	Ground	NA	B46	Ground	NA
A47	Address/Data 12	I/O	B47	Address/Data 12	I/O
A48	Address/Data 10	I/O	B48	Address/Data 10	I/O
A49	Ground	NA	B49	Ground	NA
A50	Key	NA	B50	Key	NA
A51	Key	NA	B51	Key	NA
A52	Address/Data 8	I/O	B52	Address/Data 8	I/O
A53	Address/Data 7	I/O	B53	Address/Data 7	I/O
A54	+3.3 V dc	NA	B54	+3.3 V dc	NA
A55	Address/Data 5	I/O	B55	Address/Data 5	I/O
A56	Address/Data 3	I/O	B56	Address/Data 3	I/O
A57	Ground	NA	B57	Ground	NA
A58	Address/Data 1	I/O	B58	Address/Data 1	I/O
A59	+5 V dc (I/O)	NA	B59	+5 V dc (I/O)	NA
A60	ACK64#	I/O	B60	ACK64#	I/O
A61	+5 V dc	NA	B61	+5 V dc	NA
A62	+5 V dc	NA	B62	+5 V dc	NA

## IDE Connectors

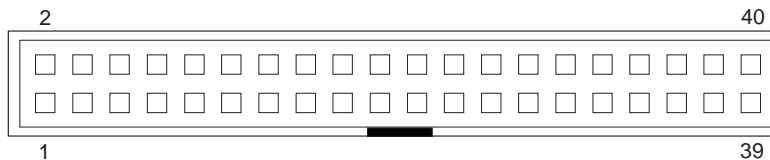

**Note:** The IDE connectors are on the riser card.

*Figure 31 (Page 1 of 2). IDE Connector Pin Assignments*

Pin	Signal	I/O	Pin	Signal	I/O
1	NC	O	21	NC	NA
2	Ground	NA	22	Ground	NA
3	Data bus bit 7	I/O	23	I/O write	O
4	Data bus bit 8	I/O	24	Ground	NA
5	Data bus bit 6	I/O	25	I/O read	O
6	Data bus bit 9	I/O	26	Ground	NA
7	Data bus bit 5	I/O	27	I/O channel ready	I
8	Data bus bit 10	I/O	28	ALE	O
9	Data bus bit 4	I/O	29	NC	NA
10	Data bus bit 11	I/O	30	Ground	NA
11	Data bus bit 3	I/O	31	IRQ	I
12	Data bus bit 12	I/O	32	CS16#	I
13	Data bus bit 2	I/O	33	SA1	O

## Appendix A. Connector Pin Assignments

*Figure 31 (Page 2 of 2). IDE Connector Pin Assignments*

Pin	Signal	I/O	Pin	Signal	I/O
14	Data bus bit 13	I/O	34	PDIAG#	I
15	Data bus bit 1	I/O	35	SA0	O
16	Data bus bit 14	I/O	36	SA2	O
17	Data bus bit 0	I/O	37	CS0#	O
18	Data bus bit 15	I/O	38	CS1	O
19	Ground	NA	39	Active#	I
20	Key (Reserved)	NA	40	Ground	NA

### Diskette Drive Connector

**Note:** The diskette drive connector is on the riser card.

*Figure 32. Diskette Drive Connector Pin Assignments*

Pin	Signal	I/O	Pin	Signal	I/O
1	Drive 2 installed #	I	2	High density select	O
3	Not connected	NA	4	Not connected	NA
5	Ground	NA	6	Data rate 0	NA
7	Ground	NA	8	Index#	I
9	Reserved	NA	10	Motor enable 0#	O
11	Ground	NA	12	Drive select 1#	O
13	Ground	NA	14	Drive select 0#	O
15	Ground	NA	16	Motor enable 1#	O
17	MSEN1	I	18	Direction in#	O
19	Ground	NA	20	Step#	O
21	Ground	NA	22	Write data#	O
23	Ground	NA	24	Write enable#	O
25	Ground	NA	26	Track0#	I
27	MSEN0	I	28	Write protect#	I
29	Ground	NA	30	Read data#	I
31	Ground	NA	32	Head 1 select#	O
33	Data rate 1	NA	34	Diskette change#	I

### Power Supply Connector

**Note:** The power supply connector is on the riser card.

*Figure 33 (Page 1 of 2). Power Supply Connector Pin Assignments*

Pin	Signal Name	Pin	Signal Name
1	+3.3 V	11	+3.3 V
2	+3.3 V	12	-12 V
3	Ground	13	Ground
4	+5 V	14	ON/OFF

*Figure 33 (Page 2 of 2). Power Supply Connector Pin Assignments*

Pin	Signal Name	Pin	Signal Name
5	Ground	15	Ground
6	+5 V	16	Ground
7	Ground	17	Ground
8	PWR GOOD	18	-5 V
9	+5 V AUX	19	+5 V
10	+12 V	20	+5 V

## Modem/Ring Wakeup and Wake on LAN Connectors

**Note:** The modem/ring wakeup and Wake on LAN connectors are on the riser card.

*Figure 34. J13 Modem/Ring Wakeup Connector Pin Assignments*

Pin	Description
1	Internal Modem
2	Ground

*Figure 35. J22 Wake on LAN Connector Pin Assignments*

Pin	Description
1	+5v AUX
2	Ground
3	Internal Wake on LAN

## Alert on LAN Connector

*Figure 36. J12 Alert on LAN Connector Pin Assignments*

Pin	Description
1	SDA, SMBus data
2	SCL, SMBus clock
3	Tamper detect

## RFID Connector (Asset ID)

*Figure 37. J5 Asset ID Connector Pin Assignments*

Pin	Description
1	Antenna 1
2	Blank (Key)
3	Ground
4	Antenna 2

## Appendix A. Connector Pin Assignments

### Fan Connector

Figure 38. J14 Front Fan Connector Pin Assignments

Pin	Description
1	Fan ground
2	Fan +12V
3	Fan -SPI

The LM80 System Management chip thermally controls the front fan. If the temperature of the system is lower than the programmed threshold, then the fan will be turned off. The LM80 and System Management Software monitors the fan speed. The LM80 does not control Disk Fan A and B.

### USB Port Connectors

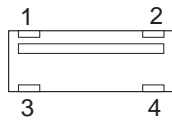

Figure 39. USB Port Connector Pin Assignments

Pin	Signal
1	VCC
2	-Data
3	+Data
4	Ground

### Mouse and Keyboard Port Connectors

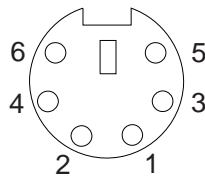

Figure 40. Mouse and Keyboard Port Connector Pin Assignments

Pin	Signal	I/O	Pin	Signal	I/O
1	Data	I/O	2	Reserved	NA
3	Ground	NA	4	+5 V dc	NA
5	Clock	I/O	6	Reserved	I/O

## Serial Port Connectors

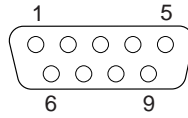

Figure 41. Serial Port Connectors Pin Assignments

Pin	Signal	I/O	Pin	Signal	I/O
1	Data carrier detect	I	2	Receive data#	I
3	Transmit data#	O	4	Data terminal read	O
5	Ground	NA	6	Data set ready	I
7	Request to send	O	8	Clear to send	I
9	Ring indicator	I			

## Parallel Port Connector

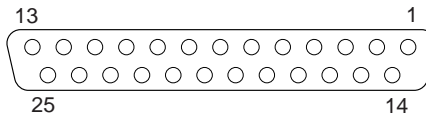
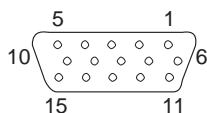

Figure 42. Parallel Port Connector Pin Assignments

Pin	Signal	I/O	Pin	Signal	I/O
1	STROBE#	I/O	2	Data bit 0	I/O
3	Data bit 1	I/O	4	Data bit 2	I/O
5	Data bit 3	I/O	6	Data bit 4	I/O
7	Data bit 5	I/O	8	Data bit 6	I/O
9	Data bit 7	I/O	10	ACK#	I
11	BUSY	I	12	PE	I
13	SLCT	I	14	AUTO FD XT#	O
15	ERROR#	I	16	INIT#	O
17	SLCT IN#	O	18	Ground	NA
19	Ground	NA	20	Ground	NA
21	Ground	NA	22	Ground	NA
23	Ground	NA	24	Ground	NA
25	Ground	NA			

### Monitor Port Connector



**Note:** Some models might have a 15-pin monitor connector on the system board. This connector is disabled and cannot be used.

*Figure 43. Monitor Connector Pin Assignments*

Pin	Signal	I/O	Pin	Signal	I/O
1	Red	O	2	Green	O
3	Blue	O	4	Monitor ID 2 - Not used	I
5	Ground	NA	6	Red ground	NA
7	Green ground	NA	8	Blue ground	NA
9	+5 V, used by DDC2B	NA	10	Ground	NA
11	Monitor ID 0 - Not used	I	12	DDC2B serial data	I/O
13	Horizontal sync	O	14	Vertical sync	O
15	DDC2B clock	I/O			

### Ethernet Connector

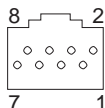

*Figure 44. Ethernet Connector*

The external interface for the Ethernet port is an 8-pin, RJ-45 connector.

*Figure 45. Pin Assignments for the Ethernet Connector*

Pin	Signal Name	I/O
1	TxD+	O
2	TxD-	O
3	RxD+	I
4	Ground	NA
5	Ground	NA
6	RxD-	I
7	Ground	NA
8	Ground	NA

## Appendix B. System Address Maps

### System Memory Map

The first 640 KB of system board RAM is mapped starting at address hex 0000000. A 256-byte area and a 1 KB area of this RAM are reserved for BIOS data areas. Memory can be mapped differently if POST detects an error.

*Figure 46. System Memory Map*

Address Range (decimal)	Address Range (hex)	Size	Description
0 K – 512 K	00000–7FFFF	512 KB	Conventional
512 K – 639 K	80000–9FBFF	127 KB	Extended conventional
639 K – 640 K	9FC00–9FFFF	1 KB	Extended BIOS data
640 K – 800 K	A0000–C7FFF	160 KB	Video memory and BIOS
800 K – 896 K	C8000–DFFFF	96 KB	PCI/ISA space, available to adapter ROMs
896 K – 928 K	E0000–E7FFF	32 KB	POST/BIOS(sys ROM, shadowed in maintenance)
928 K – 992 K	F0000–FFFFF	64 KB	POST/BIOS (sys ROM, shadowed in maintenance)
1024 K – 262144 K	100000–10000000	255 MB	Extended

### Input/Output Address Map

The following figure lists resource assignments for the I/O address map. Any addresses that are not shown are reserved.

*Figure 47 (Page 1 of 3). I/O Address Map*

Address (Hex)	Size	Description
0000–000F	16 bytes	DMA 1
0020–0021	2 bytes	Interrupt controller 1
002E–002F	2 bytes	I/O controller configuration registers
0040–0043	4 bytes	Counter/timer 1
0048–004B	4 bytes	Counter/timer 2
0060	1 byte	Keyboard controller byte - reset IRQ
0061	1 byte	NMI, speaker control
0064	1 byte	Keyboard controller, CMD/STAT byte
0070, bit 7	1 bit	Enable NMI
0070, bits 6:0	1 bit	Real time clock, address
0071	1 byte	Real time clock, data
0078	1 byte	Reserved - system board configuration
0079	1 byte	Reserved - system board configuration
0080–008F	16 bytes	DMA page registers
00A0–00A1	2 bytes	Interrupt controller 2
00B2–00B3	2 bytes	APM control

## Appendix B. System Address Maps

*Figure 47 (Page 2 of 3). I/O Address Map*

Address (Hex)	Size	Description
00C0–00DE	31 bytes	DMA 2
00F0	1 byte	Reset numeric error
0170–0177	8 bytes	Secondary IDE channel
01F0–01F7	8 bytes	Primary IDE channel
0200–0207	8 bytes	Available
0220–022F	16 bytes	Available
0240–024F	16 bytes	Available
0278–027F	8 bytes	LPT2
02E8–02EF	8 bytes	COM4/video
02F8–02FF	8 bytes	COM2
0300–0301	2 bytes	Available
0330–0331	2 bytes	Available
0332–0333	2 bytes	Available
0334–0335	2 bytes	Available
0376	1 byte	Secondary IDE channel command port
0377	1 byte	Diskette channel 2 command
0377, bit 7	1 bit	Diskette change, channel 2
0377, bits 6:0	7 bits	Secondary IDE channel status port
0378–037F	8 bytes	LPT1
0388–038D	6 bytes	Available
03B4–03B5	2 bytes	Video
03BA	1 byte	Video
03BC–03BF	4 bytes	LPT3
03C0–03CA	11 bytes	Video
03CC	1 byte	Video
03CE–03CF	2 bytes	Video
03-D4–03-D5	2 bytes	Video
03-DA	1 byte	Video
03E8–03EF	8 bytes	COM3
03F0–03F5	6 bytes	Diskette channel 1
03F6	1 byte	Primary IDE channel command port
03F7 (Write)	1 byte	Diskette channel 1 command
03F7, bit 7	1 bit	Diskette disk change channel
03F7, bits 6:0	7 bits	Primary IDE channel status port
03F8–03FF	8 bytes	COM1
04D0–04D1	2 bytes	Edge/level triggered PIC
0530–0537	8 bytes	Windows sound system
0604–060B	8 bytes	Windows sound system (if present)
LPT $n$ + 400h	8 bytes	ECP port, LPT $n$ base address + hex 400
0CF8–0CFB	4 bytes	PCI configuration address register
0CF9	1 byte	Turbo and reset control register
0CFC–0CFF	4 bytes	PCI configuration data register
0E80–0E87	8 bytes	Windows sound system (if present)



*Figure 47 (Page 3 of 3). I/O Address Map*

Address (Hex)	Size	Description
0F40–0F47	8 bytes	Windows sound system (if present)
0F86–0F87	2 bytes	Available
7000–700D	14 bytes	SMBus I/O space registers
8000–8037	56 bytes	Power management I/O space registers
FF00–FF07	8 bytes	IDE bus master register
FFA0–FFA7	8 bytes	Primary bus master IDE registers
FFA8–FFAF	8 bytes	Secondary bus master IDE registers

## DMA I/O Address Map

The following figure lists resource assignments for the DMA address map. Any addresses that are not shown are reserved.

*Figure 48 (Page 1 of 2). DMA I/O Address Map*

Address (Hex)	Description	Bits	Byte Pointer
0000	Channel 0, Memory Address register	00–15	Yes
0001	Channel 0, Transfer Count register	00–15	Yes
0002	Channel 1, Memory Address register	00–15	Yes
0003	Channel 1, Transfer Count register	00–15	Yes
0004	Channel 2, Memory Address register	00–15	Yes
0005	Channel 2, Transfer Count register	00–15	Yes
0006	Channel 3, Memory Address register	00–15	Yes
0007	Channel 3, Transfer Count register	00–15	Yes
0008	Channels 0–3, Read Status/Write Command register	00–07	
0009	Channels 0–3, Write Request register	00–02	
000A	Channels 0–3, Write Single Mask register bits	00–02	
000B	Channels 0–3, Mode register (write)	00–07	
000C	Channels 0–3, Clear byte pointer (write)	N/A	
000D	Channels 0–3, Master clear (write)/temp (read)	00–07	
000E	Channels 0–3, Clear Mask register (write)	00–03	
000F	Channels 0–3, Write All Mask register bits	00–03	
0081	Channel 2, Page Table Address register <sup>3</sup>	00–07	
0082	Channel 3, Page Table Address register <sup>3</sup>	00–07	
0083	Channel 1, Page Table Address register <sup>3</sup>	00–07	
0087	Channel 0, Page Table Address register <sup>3</sup>	00–07	
0089	Channel 6, Page Table Address register <sup>3</sup>	00–07	
008A	Channel 7, Page Table Address register <sup>3</sup>	00–07	
008B	Channel 5, Page Table Address register <sup>3</sup>	00–07	
008F	Channel 4, Page Table Address/Refresh register	00–07	
00C0	Channel 4, Memory Address register	00–15	Yes
00C2	Channel 4, Transfer Count register	00–15	Yes
00C4	Channel 5, Memory Address register	00–15	Yes
00C6	Channel 5, Transfer Count register	00–15	Yes

## Appendix B. System Address Maps

Figure 48 (Page 2 of 2). DMA I/O Address Map

Address (Hex)	Description	Bits	Byte Pointer
00C8	Channel 6, Memory Address register	00–15	Yes
00CA	Channel 6, Transfer Count register	00–15	Yes
00CC	Channel 7, Memory Address register	00–15	Yes
00CE	Channel 7, Transfer Count register	00–15	Yes
00D0	Channels 4–7, Read Status/Write Command register	00–07	
00D2	Channels 4–7, Write Request register	00–02	
00D4	Channels 4–7, Write Single Mask register bit	00–02	
00D6	Channels 4–7, Mode register (write)	00–07	
00D8	Channels 4–7, Clear byte pointer (write)	N/A	
00DA	Channels 4–7, Master clear (write)/temp (read)	00–07	
00DC	Channels 4–7, Clear Mask register (write)	00–03	
00DE	Channels 4–7, Write All Mask register bits	00–03	
00DF	Channels 5–7, 8- or 16-bit mode select	00–07	

## PCI Configuration Space Map

Bus Number (hex)	Device Number (hex)	Function Number (hex)	Description
00	00	00	Intel 84440BX (Host bridge)
00	01	00	Intel 84440BX
00	02	00	Intel 82371AB PCI/ISA bus
00	02	01	Intel 82371AB IDE bus master
00	02	02	Intel 82371AB USB
00	02	03	Intel 82371AB power management
01	00	00	S3 TRIO AGP controller
00	03	00	Ethernet Controller

<sup>3</sup> Upper byte of memory address register.

## Appendix C. IRQ and DMA Channel Assignments

The following figures list the interrupt request (IRQ) and direct memory access (DMA) channel assignments.

<i>Figure 49. IRQ Channel Assignments</i>	
<b>IRQ</b>	<b>System Resource</b>
NMI	I/O channel check
0	Reserved (interval timer)
1	Reserved (keyboard)
2	Reserved (cascade interrupt from slave)
3	COM2 <sup>4</sup>
4	COM1 <sup>4</sup>
5	LPT2/Audio (if present)
6	Diskette controller
7	LPT1 <sup>4</sup>
8	Real-time clock
9	Available to user
10	Available to user
11	Windows sound system (if present)
12	Mouse port
13	Reserved (math coprocessor)
14	Primary IDE (if present)
15	Secondary IDE (if present)

<i>Figure 50. DMA Channel Assignments</i>		
<b>DMA Channel</b>	<b>Data Width</b>	<b>System Resource</b>
0	8- or 16- bits	Open
1	8- or 16- bits	Parallel port
2	8- or 16- bits	Diskette drive
3	8- or 16- bits	Parallel port (for ECP or EPP)
4	–	Reserved (cascade channel)
5	16 bits	Open
6	16 bits	Open
7	16 bits	Open

<sup>4</sup> Default, can be changed to another IRQ.

---

## Appendix D. Error Codes

A complete list of POST error codes is provided in the *IntelliStation E Pro User Guide*.

---

### POST Error Codes

POST error messages appear when POST finds problems with the hardware during power-on or when a change in the hardware configuration is found. POST error messages are 3-, 4-, 5-, 8-, or 12-character alphanumeric messages.

---

### Beep Codes

A complete list of beep codes is provided in the *IntelliStation E Pro User Guide*.

## Appendix E. Notices and Trademarks

References in this publication to IBM products, programs, or services do not imply that IBM intends to make these available in all countries in which IBM operates. Any reference to an IBM product, program, or service is not intended to state or imply that only that IBM product, program, or service may be used. Subject to IBM's valid intellectual property or other legally protectable rights, any functionally equivalent product, program, or service may be used instead of the IBM product, program, or service. The evaluation and verification of operation in conjunction with other products, except those expressly designated by IBM, are the responsibility of the user.

IBM may have patents or pending patent applications covering subject matter in this document. The furnishing of this document does not give you any license to these patents. You can send license inquiries, in writing, to:

IBM Director of Licensing  
 IBM Corporation  
 500 Columbus Avenue  
 Thornwood, NY 10594  
 U.S.A.

### Year 2000 Readiness and Instructions

A product is Year 2000 Ready if the product, when used in accordance with its associated documentation, is capable of correctly processing, providing and/or receiving date data within and between the 20th and 21st centuries, provided all other products (for example, software, hardware, and firmware) used with the product properly exchange date data with it.

This IBM PC hardware product has been designed to process four-digit date information correctly within and between the 20th and 21st centuries. If your IBM computer is on when the century changes, you should turn it off and then back on again once, or restart the operating system, to ensure that the internal clock resets itself for the new century.

This IBM PC product cannot prevent errors that might occur if software you use or exchange data with is not ready for the Year 2000. IBM software that comes with this product is Year 2000 Ready. However, software from other companies might come with this IBM PC product. IBM cannot take responsibility for the readiness of that software. You should contact the software developers directly if you wish to verify readiness, understand limitations, or look for any software updates.

To learn more about IBM PC products and the Year 2000, visit our Web site at <http://www.pc.ibm.com/year2000>. The information and tools there can help you with your Year 2000 transition plan, especially if you have multiple IBM PCs. IBM encourages you to check periodically for updated information.

Any references in this publication to non-IBM Web sites are provided for convenience only and do not in any manner serve as an endorsement of those Web sites. The materials at those Web sites are not part of the materials for this IBM product and use of those Web sites is at your own risk.

The following terms are trademarks of the IBM Corporation in the United States or other countries or both:

Alert on LAN	Asset ID	AT
IBM	IntelliStation	LANClient Control Manager
NetFinity	NetFinity Manager	SMART Reaction
SystemCare	Wake on LAN	

## Appendix E. Notices and Trademarks

Intel, LANDesk, MMX, and Pentium are trademarks or registered trademarks of Intel Corporation.

Microsoft, Windows, OnNow, and Windows NT are trademarks or registered trademarks of Microsoft Corporation.

Other company, product, and service names may be trademarks or service marks of others.

---

## References

- *82439HX PCISet System Controller (TXC)*  
Source: Intel Corporation; available at <http://www.intel.com/design/pcisets/datashts>
- *82371SB PCI ISA IDE Xcelerator (PIIX3)*  
Source: Intel Corporation; available at <http://www.intel.com/design/pcisets/datashts>
- *Advanced Power Management (APM) BIOS Interface Specification 1.2/*  
Source: Intel Corporation
- *AT Attachment Interface with Extensions*  
Source: American National Standard of Accredited Standards Committee
- *Extended Capabilities Port: Specification Kit*  
Source: Microsoft Corporation
- *Intel Microprocessor and Peripheral Component Literature*  
Source: Intel Corporation
- *PCI BIOS Specification 2.0*  
Source: PCI Special Interest Group
- *PCI Local Bus Specification 2.1*  
Source: PCI Special Interest Group
- *Plug and Play BIOS Specification 1.1*  
Source: Microsoft Corporation; available at <http://www.microsoft.com/hwdev>
- *Plug and Play BIOS Specification, Errata and Clarifications 1.0*  
Source: Microsoft Corporation
- *Universal Serial Bus Specifications*  
Source: <http://www.usb.org>
- *Video Electronics Standards Association 1.2*  
Source: <http://www.vesa.org>
- *AT24RF08A- PCID Specification*  
Source: IBM/Atmel
- *Asset Information Area Programming Specification Version 0.10*  
Source: IBM Personal Computer Company, prepared by Mike Steinmetz

---

## Index

### A

address map  
  DMA 63  
  I/O 61  
  system memory 61  
advanced power management 27  
Alert on LAN 3  
APM 27  
Asset ID 3  
audio 11

### B

beep codes 66  
BIOS 26  
BIOS data areas 61  
bus  
  IDE 7  
  ISA 8, 15  
  PCI 7, 15  
bypassing BIOS 48

### C

chip set 5, 12  
clock, real-time 14  
CMOS RAM 14  
compatibility  
  hardware 46  
  software 49  
component maximum current 24  
configuration/setup utility program 27  
connector  
  alert 57  
  Asset ID 57  
  DIMM 50  
  diskette drive 56  
  Ethernet 60  
  fan 58  
  IDE 55  
  ISA bus 52  
  keyboard/mouse ports 58  
  modem/ring wakeup 57  
  monitor 60  
  parallel port 59  
  PCI 53  
  power supply 56  
  RFID 57  
  serial ports 59  
  USB 58  
  Wake on LAN 57

controller  
  diskette drive 12, 48  
  I/O 12  
  keyboard/mouse 13  
  parallel 12  
  serial 12  
copy protection 48

### D

diagnostic programs 27  
DIMM options 6  
diskette drive  
  change signal 48  
  compatibility 48  
  controller 12  
  write current 48  
  write protect switch 18  
DMA (direct memory access) channel assignments 65

### E

environment, operating 21  
error codes, POST 66  
ethernet port 13

### F

fan connector 58  
fault, overvoltage 25  
flash  
  EEPROM 15  
  update 27  
frequency, input power 23

### H

hard disk drive  
  compatibility 49  
  controller 49  
hardware  
  compatibility 46  
  features 1  
  interrupts 47

### I

I/O  
  address map 61  
  controller 12  
  features 20  
IBM System Management Tools 28



IDE interface 7  
 information, related viii  
 input power  
   frequency 23  
   requirements 23  
   voltage 23  
 interrupt request assignments 65  
 ISA  
   bus 8  
   connectors 15

## J

jumper  
   configuration 18  
   locations (system board) 16

## L

L2 cache 6  
 level-sensitive interrupts 47  
 load currents 24

## M

machine-sensitive programs 49  
 memory  
   DIMM options  
   error in 61  
   map, system 61  
   RAM 61  
   SDRAM  
   system  
   system memory map 61  
 messages, POST error 66  
 microprocessor  
   features 5  
   switch settings 16  
 modes, power management 27

## N

network enablement 4  
 noise level 21

## O

operating system support 4  
 ordering publications viii  
 outputs, power supply 24  
 overvoltage fault 25

## P

parallel port 12  
 password enable/disable switch 17

## PCI

  bus 7  
   connectors 15  
 Pentium II microprocessor with MMX technology 5  
 Plug and Play 26  
 polling mechanism 49  
 port  
   ethernet 13, 60  
   keyboard/mouse 13  
   parallel 12  
   serial 12  
 POST 26, 61  
 POST error codes 66  
 power  
   consumption 27  
   description 23  
   for components 24  
   load currents 24  
   management modes 27  
   output protection 25  
   outputs 24  
 protection, power supply 25  
 publications, related viii

## R

RAM (random access memory) 61  
 references 69  
 related information viii  
 reserved areas vii  
 riser card 15

## S

SDRAM (synchronous dynamic random access memory) 6  
 serial port 12  
 short circuit 25  
 software  
   compatibility 49  
   interrupts 49  
   software features 3  
   specifications 21  
   specifications, mechanical 21  
   switches, system board 16  
 system  
   memory maps 61  
   overview 1  
   specifications 21

## T

token ring port 13

## Index

### U

universal serial bus  
  connectors 58  
  port 8  
  technology 8

### V

video  
  adapters 9  
  subsystem 9  
voltage  
  input power 23  
  output power 23

### W

Wake on LAN 3  
Wake Up on Ring 3  
write current, diskette 48  
write-protect switch, diskette drive 18





Printed in U.S.A.

+++EDF010E DOCNUM tag required with COVER tag. (Page 72 File: D4BG1TIM SCRIPT)  
DSMMOM397I '.EDF#CV' WAS IMBEDDED AT LINE 210 OF '.EDF#BCV7'  
DSMMOM397I '.EDF#BCV7' WAS IMBEDDED AT LINE 680 OF '.EDF#END'  
DSMMOM397I '.EDF#END' WAS IMBEDDED AT LINE 188 OF 'BOOKPROF'  
DSMBEG323I STARTING PASS 2 OF 3.

+++EDF010E DOCNUM tag required with COVER tag. (Page 72 File: D4BG1TIM SCRIPT)  
DSMMOM397I '.EDF#CV' WAS IMBEDDED AT LINE 210 OF '.EDF#BCV7'  
DSMMOM397I '.EDF#BCV7' WAS IMBEDDED AT LINE 680 OF '.EDF#END'  
DSMMOM397I '.EDF#END' WAS IMBEDDED AT LINE 188 OF 'BOOKPROF'  
DSMBEG323I STARTING PASS 3 OF 3.

+++EDF010E DOCNUM tag required with COVER tag. (Page 74 File: D4BG1TIM SCRIPT)  
DSMMOM397I '.EDF#CV' WAS IMBEDDED AT LINE 210 OF '.EDF#BCV7'  
DSMMOM397I '.EDF#BCV7' WAS IMBEDDED AT LINE 680 OF '.EDF#END'  
DSMMOM397I '.EDF#END' WAS IMBEDDED AT LINE 188 OF 'BOOKPROF'