

IBM® Netfinity® User's  
Reference



# ServeRAID™ -4H Ultra 160 SCSI Controller



IBM® Netfinity® User's  
Reference



# ServeRAID™ -4H Ultra 160 SCSI Controller

**NOTE:** Before using this information and the product it supports, be sure to read the general information under “Appendix. Product warranties and notices” on page 155.

**First Edition (April 2000)**

**© Copyright International Business Machines Corporation 2000. All rights reserved.**

US Government Users Restricted Rights – Use, duplication or disclosure restricted by GSA ADP Schedule Contract with IBM Corp.

---

# Contents

<b>Safety Information</b> . . . . .	vii
<b>Preface</b> . . . . .	xi
How this book is organized . . . . .	xi
Notices used in this book . . . . .	xii
Related publications . . . . .	xii
<b>Chapter 1. Getting started</b> . . . . .	1
Option package contents . . . . .	1
Understanding RAID technology . . . . .	1
Stripe-unit size . . . . .	2
Supported RAID levels . . . . .	2
Selecting a RAID level and performance tuning . . . . .	10
Drive state descriptions . . . . .	10
<b>Chapter 2. Installing and configuring ServeRAID controllers</b> . . . . .	13
Obtaining ServeRAID updates . . . . .	13
Downloadable files from the World Wide Web . . . . .	14
Step 1: Installing and cabling a ServeRAID controller . . . . .	15
Controller features . . . . .	15
Connector locations . . . . .	15
Using a ServeRAID controller in a server with Hot-plug PCI features . . . . .	17
Installing the ServeRAID controller . . . . .	17
Connecting external devices . . . . .	21
Step 2: Updating BIOS and firmware code . . . . .	21
Step 3: Configuring ServeRAID controllers . . . . .	22
Using the ServeRAID Manager program . . . . .	22
Step 4: Installing device drivers . . . . .	33
Installing device drivers while installing the operating system . . . . .	34
Installing or updating device drivers after installing the operating system . . . . .	42
Step 5: Installing the ServeRAID Manager program and other utilities . . . . .	48
Installing the ServeRAID Manager program . . . . .	49
Installing the IPSSSEND and IPSMON command-line programs . . . . .	53
Step 6: Starting the ServeRAID Manager program . . . . .	56
Starting the ServeRAID Manager program in Windows 2000 and Windows NT . . . . .	56
Starting the ServeRAID Manager program in NetWare . . . . .	57
Starting the ServeRAID Manager program in OS/2 . . . . .	57
Starting the ServeRAID Manager program in OpenServer, UnixWare, and Linux . . . . .	58
<b>Chapter 3. Configuring two ServeRAID controllers in a failover environment (Windows NT 4.0 and Windows 2000 only)</b> . . . . .	61
Hardware requirements . . . . .	61
Installation guidelines and restrictions . . . . .	61
Preparing the controllers . . . . .	62
Connecting the expansion enclosures . . . . .	65
Configuring ServeRAID arrays and logical drives . . . . .	66
Completing the failover environment installation . . . . .	67
<b>Chapter 4. Introduction to IBM ServeRAID Cluster Solution</b> . . . . .	69
<b>Chapter 5. Preparing to install or change a cluster solution</b> . . . . .	73

Terms and definitions . . . . .	73
ServeRAID considerations . . . . .	74
Hardware considerations . . . . .	74
Controller considerations . . . . .	74
Array or logical drive considerations . . . . .	74
<b>Chapter 6. Updating the ServeRAID BIOS, firmware, and software code</b>	<b>77</b>
<b>Chapter 7. Configuring ServeRAID controllers for clustering</b> . . . . .	<b>79</b>
Configuring the controller for Microsoft Cluster Service using Windows NT 4.0 or Windows 2000 . . . . .	79
Configuring the controller for Vinca High Availability for Novell IntranetWare or Novell High Availability Server . . . . .	79
Configuring a controller for clustering . . . . .	80
Configuring ServeRAID arrays and a logical drive . . . . .	82
<b>Chapter 8. Installing the Microsoft Cluster Service software on Windows NT 4.0</b> . . . . .	<b>85</b>
Installing the Microsoft Cluster Service . . . . .	85
Creating a ServeRAID disk resource on a Windows NT 4.0 ServeRAID cluster	88
Deleting and re-creating a ServeRAID logical drive resource . . . . .	89
Uninstalling MSCS on ServeRAID servers . . . . .	89
Updating ServeRAID software in an MSCS cluster environment . . . . .	90
Step 1: Upgrading the IBM ServeRAID Manager program . . . . .	90
Step 2: Upgrading the IBM ServeRAID Microsoft Windows NT Cluster Solution. . . . .	90
Step 3: Upgrading the IBM ServeRAID Windows NT device driver . . . . .	91
Step 4: Upgrading the IBM ServeRAID BIOS and firmware. . . . .	91
Step 5: Upgrading the software for the other server in the cluster . . . . .	91
<b>Chapter 9. Installing the Microsoft Cluster Service software on Windows 2000</b> . . . . .	<b>93</b>
Installing the ServeRAID Manager program . . . . .	93
Installing the Microsoft Cluster Service . . . . .	93
Creating a ServeRAID disk resource on a Windows 2000 ServeRAID cluster	96
Deleting and re-creating a ServeRAID logical drive resource . . . . .	98
Upgrading the IBM ServeRAID Cluster Solution from Microsoft Windows NT 4.0 to Windows 2000 . . . . .	98
Uninstalling MSCS on ServeRAID servers . . . . .	99
<b>Chapter 10. Monitoring and updating an IBM ServeRAID Cluster Solution</b>	<b>101</b>
Checking the ownership of a physical drive . . . . .	101
Adding logical drives to a cluster . . . . .	102
Validating a cluster . . . . .	103
Viewing merge group numbers and other cluster information . . . . .	105
<b>Chapter 11. Using utility programs</b> . . . . .	<b>107</b>
Using the ServeRAID Mini-Configuration program . . . . .	107
Viewing the controller status . . . . .	107
Viewing the configuration. . . . .	108
Using the advanced configuration functions . . . . .	108
Using the IPSSSEND command-line program. . . . .	110
FlashCopy function (for Windows NT and Windows 2000 only) . . . . .	110
Server roll-out functions . . . . .	116
Error-recovery functions . . . . .	118
Problem-isolation and debug functions . . . . .	119

RAID Configuration functions . . . . .	122
Using the IPSPMON command-line program (NetWare only) . . . . .	123
<b>Chapter 12. Solving ServeRAID problems</b> . . . . .	125
ServeRAID Manager fails to start (Windows NT and Windows 2000 only) . . . . .	125
ServeRAID controller messages . . . . .	125
ServeRAID startup (POST) messages . . . . .	130
ServeRAID ISPR, BCS, and ECS POST error codes . . . . .	131
Rebuilding a defunct drive . . . . .	136
Steps for recovering from defunct drives . . . . .	136
Rebuilding a hot-swap drive. . . . .	136
Recovering from an incomplete format of a physical drive. . . . .	137
Solving problems in a failover environment . . . . .	138
Recovering from a failure in a failover environment . . . . .	138
Replacing a controller of a failover pair in non-hot-plug PCI slot . . . . .	138
Replacing a controller of a failover pair in hot-plug PCI slot . . . . .	139
Recovering from a power failure during a failover. . . . .	139
Troubleshooting an IBM ServeRAID Cluster Solution . . . . .	139
Recovering from a failed ServeRAID server . . . . .	140
Recovering from a failed ServeRAID controller. . . . .	140
Recovering from a failover in a Microsoft Cluster Service server . . . . .	143
Recovering from a failed server in a ServeRAID cluster . . . . .	143
Troubleshooting ServeRAID subsystems in a cluster environment. . . . .	144
<b>Chapter 13. Getting help, service, and information</b> . . . . .	147
Service support . . . . .	148
Before you call for service . . . . .	148
Getting customer support and service . . . . .	149
Using the World Wide Web . . . . .	149
Using electronic support services. . . . .	149
Getting information by fax . . . . .	150
Getting help online . . . . .	150
Getting help by telephone . . . . .	150
Getting help around the world . . . . .	151
Purchasing additional services. . . . .	152
Enhanced PC support line . . . . .	152
900-number operating system and hardware support line . . . . .	152
Network and server support line . . . . .	152
Ordering support line services . . . . .	153
Warranty and repair services . . . . .	153
Ordering publications . . . . .	154
<b>Appendix. Product warranties and notices</b> . . . . .	155
Warranty Statements . . . . .	155
IBM Statement of Limited Warranty for United States, Puerto Rico, and Canada (Part 1 - General Terms) . . . . .	155
IBM Statement of Warranty Worldwide except Canada, Puerto Rico, Turkey, United States (Part 1 – General Terms) . . . . .	158
Part 2 - Worldwide Country-Unique Terms . . . . .	160
Notices . . . . .	164
Edition Notice . . . . .	164
Non-IBM Web sites . . . . .	165
Year 2000 readiness and instructions . . . . .	165
Trademarks. . . . .	165
Important notes . . . . .	166
Electronic emission notices . . . . .	167

Federal Communications Commission (FCC) Statement . . . . .	167
Industry Canada Class A emission compliance statement . . . . .	167
Australia and New Zealand Class A statement . . . . .	167
United Kingdom telecommunications safety requirement . . . . .	167
European community directive conformance statement. . . . .	168
Taiwan electrical emission statement . . . . .	168
Japanese Voluntary Control Council for Interference (VCCI) statement	168
<b>Index . . . . .</b>	<b>169</b>



## Safety Information

Before installing this product, read the Safety Information book.

مج، يجب قراءة دات السلامة

Antes de instalar este produto, leia o Manual de Informações sobre Segurança.

安装本产品前请先阅读《安全信息》手册。

Prije instalacije ovog proizvoda pročitajte priručnik sa sigurnosnim uputama.

Před instalací tohoto produktu si přečtěte příručku bezpečnostních instrukcí.

Læs hæftet med sikkerhedsforskrifter, før du installerer dette produkt.

Lue Safety Information -kirjanen, ennen kuin asennat tämän tuotteen.

Avant de procéder à l'installation de ce produit, lisez le manuel Safety Information.

Vor Beginn der Installation die Broschüre mit Sicherheitshinweisen lesen.

Πριν εγκαταστήσετε αυτό το προϊόν, διαβάστε το εγχειρίδιο Safety Information.

לפני שתתקינו מוצר זה, קראו את הוראות הבטיחות.

Przed zainstalowaniem tego produktu należy przeczytać broszurę Informacje Dotyczące Bezpieczeństwa.

Prima di installare questo prodotto, leggere l'opuscolo contenente le informazioni sulla sicurezza.

本製品を導入する前に、安全情報資料を御読みください。

이 제품을 설치하기 전에, 안전 정보 책자를 읽어보십시오.

Пред да го инсталирате овој производ прочитајте ја книгата со безбедносни информации.

Lees voordat u dit product installeert eerst het boekje met veiligheidsvoorschriften.

Les heftet om sikkerhetsinformasjon (Safety Information) før du installerer dette produktet.

Prije instalacije ovog proizvoda pročitajte priručnik sa sigurnosnim uputama.

Antes de instalar este produto, leia o folheto Informações sobre Segurança.

Перед установкой продукта прочтите брошюру по технике безопасности (Safety Information).

Pred inštaláciou tohto produktu si pre ítajte Informa nú brožúrku o bezpe nosti.

Preden namestite ta izdelek, preberite knjižico Varnostne informacije.

Antes de instalar este producto, lea la Información de Seguridad.

Läs säkerhetsinformationen innan du installerar den här produkten.

在安裝本產品之前，也請先閱讀「安全性資訊」小冊子。

Installálás el tt olvassa el a Biztonsági el írások kézikönyvét !

#### Statement 1:



#### DANGER

**Electrical current from power, telephone, and communication cables is hazardous. To avoid a shock hazard:**

- **Do not connect or disconnect any cables or perform installation, maintenance, or reconfiguration of this product during an electrical storm.**
- **Connect all power cords to a properly wired and grounded electrical outlet.**
- **Connect to properly wired outlets any equipment that will be attached to this product.**
- **When possible, use one hand only to connect or disconnect signal cables.**
- **Never turn on any equipment when there is evidence of fire, water, or structural damage.**
- **Disconnect the attached power cords, telecommunications systems, networks, and modems before you open the device covers, unless instructed otherwise in the installation and configuration procedures.**
- **Connect and disconnect cables as described in the following table when installing, moving, or opening covers on this product or attached devices.**

##### To connect:

1. Turn everything OFF.
2. First, attach all cables to devices.
3. Attach signal cables to connectors.
4. Attach power cords to outlet.
5. Turn device ON.

##### To disconnect:

1. Turn everything OFF.
2. First, remove power cords from outlet.
3. Remove signal cables from connectors.
4. Remove all cables from devices.

**Statement 2:**

**CAUTION:**



When replacing the lithium battery, use only IBM Part Number 38L3386 or an equivalent type battery recommended by the manufacturer. If your system has a module containing a lithium battery, replace it only with the same module type made by the same manufacturer. The battery contains lithium and can explode if not properly used, handled, or disposed of.

**Do not:**

- Throw or immerse into water.
- Heat to more than 100 C (212 F)
- Repair or disassemble

Dispose of the battery as required by local ordinances or regulations.

**Statement 5:**



**CAUTION:**

The power control button on the device and the power switch on the power supply do not turn off the electrical current supplied to the device. The device also might have more than one power cord. To remove all electrical current from the device, ensure that all power cords are disconnected from the power source.

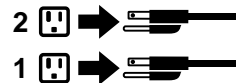



---

## Preface

This book provides information for configuring an IBM® Netfinity® ServeRAID™ controller, installing device drivers, and installing and using the ServeRAID utility programs.

**Note:** The IBM ServeRAID product can be either a controller on an adapter, such as the one in this option package, or a controller on the system board of your server. For consistency in this manual, the ServeRAID product is referred to as a ServeRAID controller, unless it is specifically noted otherwise.

To install device drivers and utility programs for an IBM ServeRAID controller that comes as a standard feature on an IBM Netfinity or PC Server system board, see the installation instructions and CDs provided with your server for instructions.

---

## How this book is organized

“Chapter 1. Getting started” on page 1 contains introductory information about the IBM ServeRAID-4H controller and general information about RAID technology.

“Chapter 2. Installing and configuring ServeRAID controllers” on page 13 explains the ServeRAID installation and configuration process. You can refer to the information in this chapter when configuring one or more devices attached to a ServeRAID controller.

“Chapter 3. Configuring two ServeRAID controllers in a failover environment (Windows NT 4.0 and Windows 2000 only)” on page 61 contains instructions for configuring two ServeRAID controllers in a failover environment.

“Chapter 4. Introduction to IBM ServeRAID Cluster Solution” on page 69 through “Chapter 10. Monitoring and updating an IBM ServeRAID Cluster Solution” on page 101 contains information for installing and configuring ServeRAID controllers in a clustering environment.

“Chapter 11. Using utility programs” on page 107 contains instructions for using the Mini-Configuration, IPSEND, and IPSMON programs. You can use these operating-system specific programs to maintain and monitor your ServeRAID subsystem.

“Chapter 12. Solving ServeRAID problems” on page 125 describes the ServeRAID POST error codes and startup messages. This chapter also includes some basic information for rebuilding a defunct drive.

“Chapter 13. Getting help, service, and information” on page 147 provides information about accessing the IBM HelpCenter and World Wide Web sites to obtain future code and information updates for the ServeRAID controller.

“Appendix. Product warranties and notices” on page 155 contains warranty information, product notices, and trademarks.

---

## Notices used in this book

This book contains notices to highlight information as follows:

- **Notes:** These notices provide important tips, guidance, or advice.
- **Attention:** These notices indicate possible damage to programs, devices, or data. An attention notice is placed just before the instruction or situation in which damage could occur.
- **Caution:** These notices indicate situations that can be potentially hazardous to you. A caution notice is placed just before descriptions of potentially hazardous procedure steps or situations.

---

## Related publications

The following books are available on the *IBM ServeRAID Support* CD in the /BOOKS directory:

- *IBM Netfinity ServeRAID-4H Ultra160 SCSI Controller User's Reference* (4SRAIDUR.PDF)
- *IBM Netfinity ServeRAID-3H, ServeRAID-3HB, and ServeRAID-3L Ultra2 SCSI Controllers Installation and User's Guide* (3SRAIDUG.PDF)

The following booklets are extracted from the *IBM Netfinity ServeRAID-4H Ultra160 SCSI Controller User's Reference* and are available on the *IBM ServeRAID Support* CD in the /BOOKS directory:

- *IBM ServeRAID-4H Ultra160 SCSI Controller Installation Guide* (4INSTALL.PDF)
- *Configuring IBM ServeRAID Controllers for Failover* (4FAILCFG.PDF)
- *Installing the IBM ServeRAID Cluster Solution* (4CLUSTER.PDF)
- *Understanding IBM ServeRAID Technology* (4TECHNOL.PDF)

**Note:** Use Adobe Acrobat Reader to view these files. The *IBM ServeRAID Support* CD has the Acrobat Readers for Microsoft Windows, IBM OS/2, and Linux in the /BOOKS directory.

If you are installing the IBM ServeRAID Cluster Solution, you might need to refer to the *IBM Shared Disk Clustering Hardware Reference*. This book provides general information about planning and configuring a shared-disk cluster using IBM Netfinity and PC Server products. It contains illustrations, descriptions, and parts listings for various high-availability, shared-disk cluster examples.

**Note:** You can obtain this publication from the IBM Support Web site. See "Downloadable files from the World Wide Web" on page 14 for additional information.

---

## Chapter 1. Getting started

This book provides information needed to install and configure an IBM ServeRAID-4H Ultra160 SCSI controller. This high-performance, redundant array of independent disk (RAID) controllers are ideally suited for data-storage environments that require superior performance, flexibility, and reliable data storage. (See “Controller features” on page 15 for more information.)

You also can use the configuration and reference information in this book to configure the IBM ServeRAID controllers provided on some IBM Netfinity and PC Server system boards.

---

### Option package contents

In addition to this book, the ServeRAID option package contains:

- IBM Netfinity ServeRAID-4H Ultra160 SCSI controller  
**Attention:** Do not open the static-protective bag containing the controller until you are instructed to do so.
- IBM ServeRAID Support Package:
  - *IBM ServeRAID Support CD*
  - *IBM ServeRAID Device Drivers* diskette
  - *IBM ServeRAID Device Drivers for SCO Operating Systems - UnixWare HBA and OpenServer BTLT* diskette

See “Obtaining ServeRAID updates” on page 13 and “Step 4: Installing device drivers” on page 33 for more detailed information.

Contact your place of purchase if any items are missing or damaged.

---

### Understanding RAID technology

RAID is the technology of grouping several physical drives in a computer into an *array* that you can define as one or more logical drives. Each *logical* drive appears to the operating system as a single drive. This grouping technique greatly enhances logical-drive capacity and performance beyond the physical limitations of a single physical drive.

When you group multiple physical drives into a logical drive, the ServeRAID controller can transfer data in parallel from the multiple drives in the array. This parallel transfer yields data-transfer rates that are many times higher than with nonarrayed drives. This increased speed makes the system better able to meet the *throughput* (the amount of data processed in a given amount of time) or productivity needs of the multiple-user network environment.

The ability to respond to multiple data requests provides not only an increase in throughput, but also a decrease in response time. The combination of parallel transfers and simultaneous responses to multiple requests allows disk arrays to provide a high level of performance in network environments.

## Stripe-unit size

With RAID technology, data is *striped* across an array of physical drives. This data-distribution scheme complements the way the operating system requests data.

The granularity at which data is stored on one drive of the array before subsequent data is stored on the next drive of the array is called the *stripe-unit size*.

You can control the stripe-unit size and maximize the performance of your ServeRAID controller by setting a stripe-unit size to a value that is close to the size of the system I/O requests. You can set the stripe-unit size to 8 KB, 16 KB, 32 KB, or 64 KB. For example, performance in transaction-based environments, which typically involve large blocks of data, might be optimal when the stripe-unit size is set to 32 KB or 64 KB. However, performance in file and print environments, which typically involve multiple small blocks of data, might be optimal when the stripe-unit size is set to 8 KB or 16 KB.

The collection of stripe units, from the first drive of the array to the last drive of the array, is called a *stripe*.

The ServeRAID-4H controller supports 16 physical drives in an array if the stripe-unit size is set to 32 KB or 64 KB.

## Supported RAID levels

Disk arrays are used to improve performance and reliability. The amount of improvement depends on the application programs that you run on the server and the RAID levels that you assign to the logical drives.

The ServeRAID controllers support RAID level-0, 1, 1E, 5, 5E, 00, 10, 1E0, and 50.

### Understanding RAID level-0

RAID level-0 stripes the data across all the drives in the array. This offers substantial speed enhancement, but provides no data redundancy. RAID level-0 provides the largest storage capacity of the RAID levels that are offered, because no room is taken for redundant data or data-parity storage.

RAID level-0 requires a minimum of one drive and, depending upon the level of firmware and the stripe-unit size, supports a maximum of 8 or 16 drives.

The following illustration shows an example of a RAID level-0 logical drive.

Start with two physical drives.

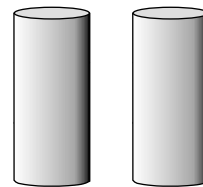



Create an array using the two physical drives.

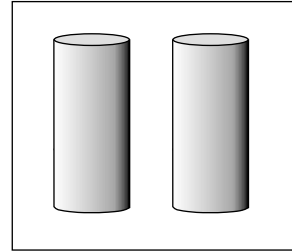

Then, create a logical drive within that array.

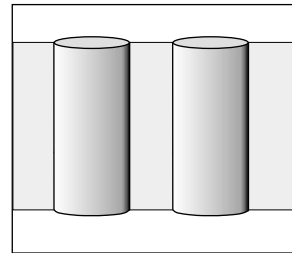

The data is striped across the drives, creating blocks.

Notice that the data is striped across all the drives in the array, but no redundant data is stored.

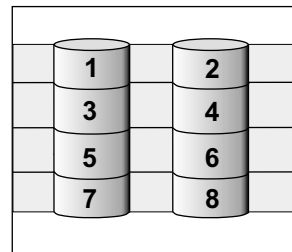

A physical drive failure within the array results in loss of data in the logical drive assigned RAID level-0, but only in that logical drive. If you have logical drives assigned RAID level-1, 1E, 5, or 5E in the same array, they will not lose data.

**Note:** If you have an array that contains only one physical drive, you can assign only RAID level-0 to the logical drive in that array.

When you replace a failed drive, the ServeRAID controller can rebuild all the RAID level-1E and RAID level-5E logical drives automatically onto the replacement physical drive. However, any data stored in a failed RAID level-0 logical drive is lost.

Although the risk of data loss is present, you might want to assign RAID level-0 to one of the logical drives to take advantage of the speed this RAID level offers. You can use this logical drive to store data that you back up each day and for which safety is not of primary importance, that is, data that you can re-create easily. You also might want to use a RAID level-0 logical drive when you require maximum capacity.

### Understanding RAID level-1

RAID level-1 provides 100% data redundancy and requires only two physical drives. With RAID level-1, the first half of a stripe is the original data; the second half of a stripe is a *mirror* (that is, a copy) of the data, but written to the other drive in the RAID level-1 array.

Because the data is mirrored, the capacity of the logical drive when assigned RAID level-1 is 50% of the array capacity.

The following illustration shows an example of a RAID level-1 logical drive.

Start with two physical drives.

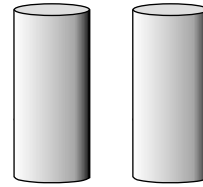

Create an array using the two physical drives.

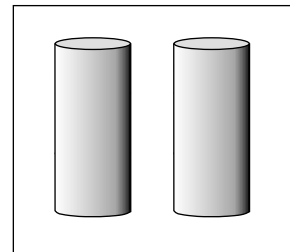

Then, create a logical drive within that array.

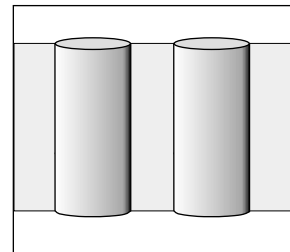

The data is striped across the drives, creating blocks.

Notice that the data on the drive on the right is a copy of the drive on the left.

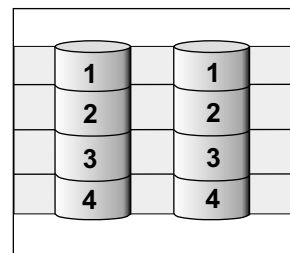

With RAID level-1, if one of the physical drives fails, the ServeRAID controller switches read and write requests to the remaining functional drive in the RAID level-1 array.

### Understanding RAID level-1 Enhanced

If you have three or more physical drives in the array, you cannot select RAID level-1; you can select RAID level-1 Enhanced (RAID level-1E).

RAID level-1E combines mirroring with data striping. This RAID level stripes data and copies of the data across all of the drives in the array. As with the standard RAID level-1, the data is mirrored, and the capacity of the logical drive is 50 percent of the array capacity of the grouping of physical drives in the array.

RAID level-1E requires a minimum of 3 drives and, depending upon the level of firmware and the stripe-unit size, supports a maximum of 8 or 16 drives.

The following illustration is an example of a RAID level-1E logical drive.

Start with three physical drives.

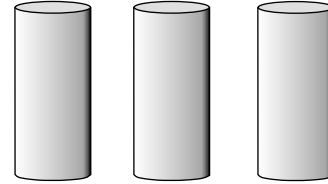

Create an array using the physical drives.

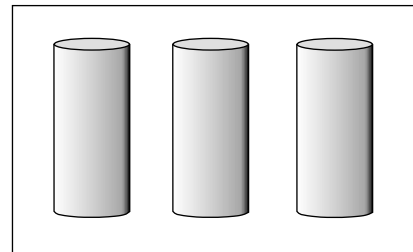

Then, create a logical drive within that array.

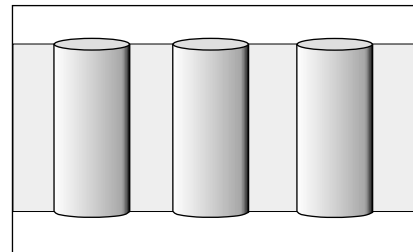

The data is striped across the drives, creating blocks.

Notice that the stripe labeled \* is the data stripe and the stripe labeled \*\* is the copy of the preceding data stripe. Also notice that each block on the mirror stripe is shifted one drive.

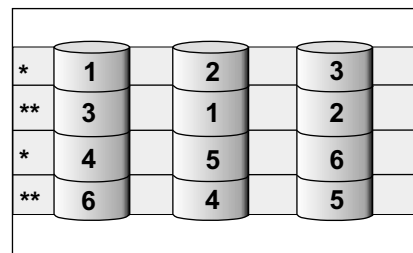

With RAID level-1E, if one of the physical drives fails, the ServeRAID controller switches read and write requests to the remaining functional drives in the RAID level-1E array.

### Understanding RAID level-5

RAID level-5 requires a minimum of three physical drives. This RAID level stripes data and parity across all drives in the array. When you assign RAID level-5 to an array, the capacity of the array is reduced by the capacity of one drive (for data-parity storage).

RAID level-5 offers both data protection and increased throughput. RAID level-5 gives you higher capacity than RAID level-1, but RAID level-1 offers better performance.

RAID level-5 requires a minimum of 3 drives and, depending upon the level of firmware and the stripe-unit size, supports a maximum of 8 or 16 drives.

The following illustration is an example of a RAID level-5 logical drive.

Start with four physical drives.

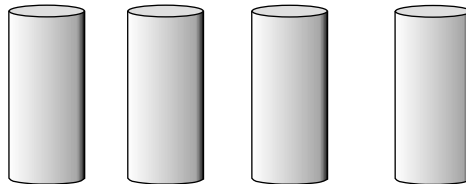

Create an array using three of the physical drives, leaving the fourth as a hot-spare drive.

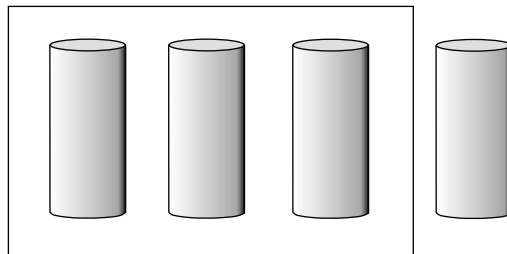

Then, create a logical drive within that array.

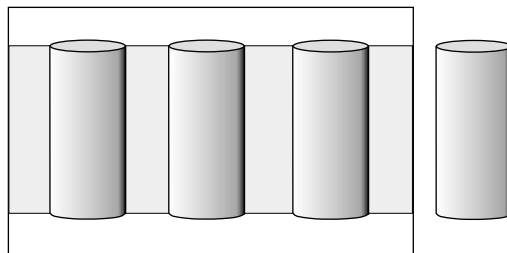

The data is striped across the drives, creating blocks.

Notice that the storage of the data parity (denoted by **\***) also is striped, and it shifts from drive to drive.

A parity block (**\***) contains a representation of the data from the other blocks in the same stripe. For example, the parity block in the first stripe contains data representation of blocks 1 and 2.

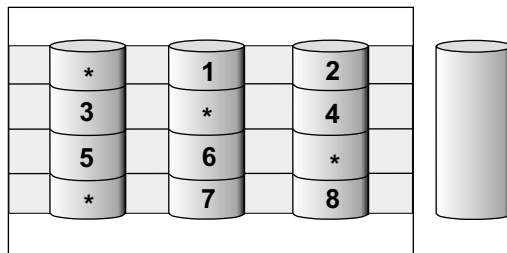

If a physical drive fails in the array, the ServeRAID controller switches read and write requests to the remaining functional drive in the RAID level-5 array, which is a hot-spare drive.

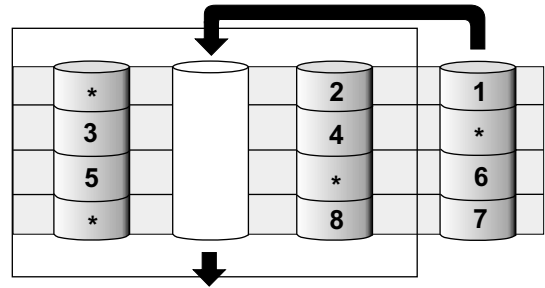

## Understanding RAID level-5 Enhanced

RAID level-5 Enhanced (RAID level-5E) requires a minimum of four physical drives. RAID level-5E is also firmware-specific. You can think of RAID level-5E as “RAID level-5 with a built-in spare drive.”

Reading from and writing to four disk drives is more efficient than three disk drives and an idle hot spare and therefore improves performance. Additionally, the spare drive is actually part of the RAID level-5E array, as shown in the following example. With such a configuration, you cannot share the spare drive with other arrays. If you want a spare drive for any other array, you must have another spare drive for those arrays.

Like RAID level-5, this RAID level stripes data and parity across all of the drives in the array. When an array is assigned RAID level-5E, the capacity of the logical drive is reduced by the capacity of two physical drives in the array (that is, one for parity and one for the spare).

RAID level-5E offers both data protection and increased throughput, in addition to the built-in spare drive.

**Note:** For RAID level-5E, you can have only one logical drive in an array. When using RAID level-5E, you can have a maximum of seven logical drives on the controller.

RAID level-5E requires a minimum of 4 drives and, depending upon the level of firmware and the stripe-unit size, supports a maximum of 8 or 16 drives.

The following illustration is an example of a RAID level-5E logical drive.

Start with four physical drives.

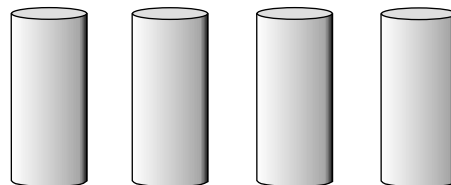

Create an array using all four physical drives.

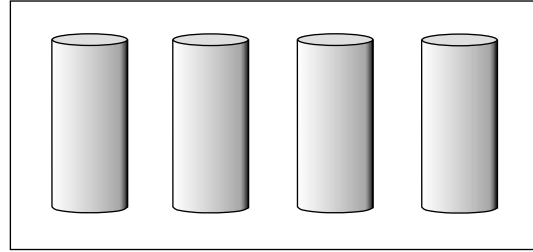

Then, create a logical drive (labeled as 1) within the array.

Notice that the distributed spare drive is the free space (labeled as 2) shown below the logical drive.

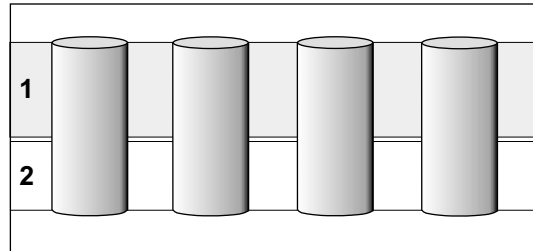

The data is striped across the drives, creating blocks in the logical drive.

The storage of the data parity (denoted by \*) is striped, and it shifts from drive to drive as it does in RAID level-5.

Notice that the spare drive is **not** striped.

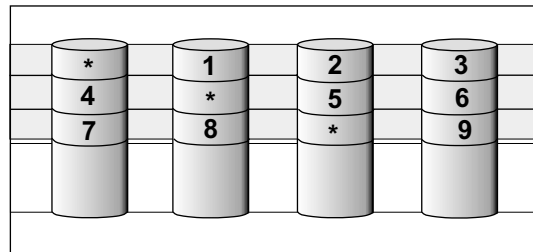

If a physical drive fails in the array, the data from the failed drive is compressed into the distributed spare drive. The logical drive remains RAID level-5E.

When you replace the failed drive, the data for the logical drive decompresses and returns to the original striping scheme.

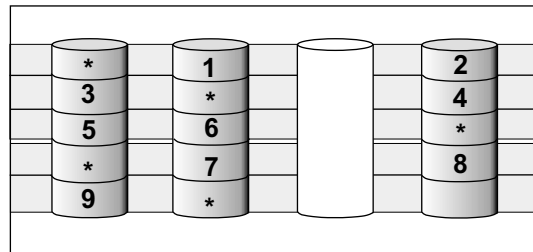

**Note:** The ServeRAID Manager program Express configuration does not default to RAID level-5E. If you have four physical drives, Express configuration defaults to RAID level-5 with a hot-spare drive.

### Understanding RAID level-x0

RAID level-x0 refers to RAID levels-00, 10, 1E0, and 50. RAID level-x0 includes more physical drives in an array. The benefits of doing so are larger logical drives, increased performance, and increased reliability. RAID levels-0, 1, 1E, 5, and 5E cannot use more than 16 physical drives in an array. However, RAID levels-00, 10, 1E0, and 50 include more physical drives by managing an array of arrays, or a *spanned array*. The operating system uses the spanned array logical drive the same as a regular array logical drive.

**Note:** RAID level-x0 is only available on the IBM ServeRAID-4H Ultra160 SCSI controller.

RAID level-x0 requires a minimum of 2 drives and supports a maximum of 60 drives.

The following illustration is an example of a RAID level-10 logical drive.

Start with six physical drives.

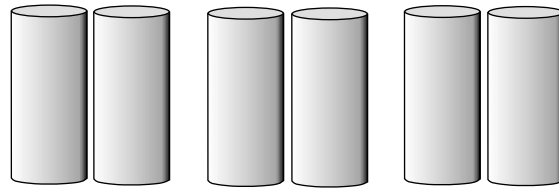

Create three arrays (labeled A, B, and C), each array using two physical drives.

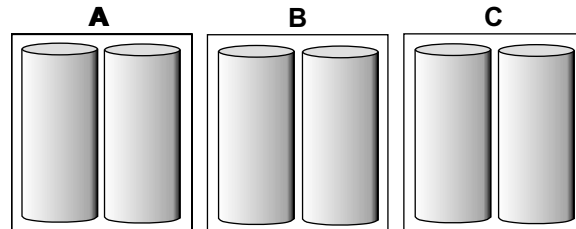

Then, create a *spanned* array (labeled as 1) that spans the three arrays.

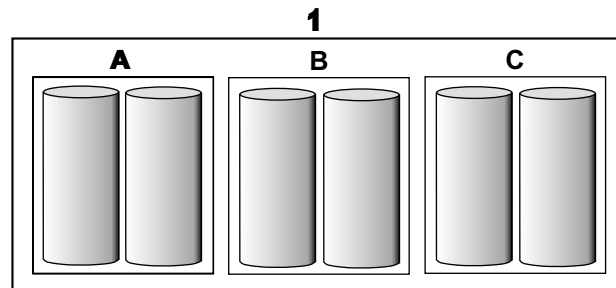

A sub-logical drive is created within *each* array (A, B, and C). Then, the data is striped across the physical drives in the array, creating blocks.

Notice that, in each array, the data on the drive on the right is a copy of the drive on the left. This is because the sub-logical drives (A, B, and C) are RAID level-1 in a RAID level-10 implementation (see the following table).

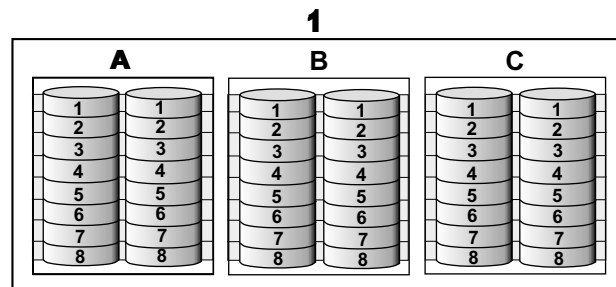

Then, create a logical drive within the spanned array (1). The data is striped across this logical drive, creating blocks. Notice that none of these blocks are redundant. This is because the logical drive (1) is RAID level-0 in a RAID level-x0 implementation (see the following table).

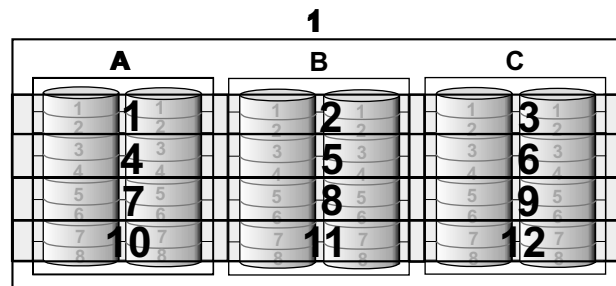

RAID level	means the sub-logical drive is	and the spanned array logical drive is
00	RAID level-0	RAID level-0
10	RAID level-1	RAID level-0
1E0	RAID level-1E	RAID level-0
50	RAID level-5	RAID level-0

With RAID level-10, 1E0, and 50, if one of the physical drives fails in a sub-logical drive, the ServeRAID controller switches read and write requests to the remaining functional drives in the sub-logical drive. With RAID level-00, a physical drive failure within the sub-logical drive results in loss of data.

## Selecting a RAID level and performance tuning

When selecting a RAID level for your system, consider the following:

RAID level	Data Redundancy	Hard Disk Drive Capacity Utilization	Read Performance	Write Performance	Built-in Spare Drive
RAID level-0	No	100%	Excellent	Excellent	No
RAID level-1	Yes	50%	Very good	Very good	No
RAID level-1E	Yes	50%	Very good	Very good	No
RAID level-5	Yes	67% to 94%	Excellent	Good	No
RAID level-5E	Yes	50% to 88%	Excellent	Good	Yes
RAID level-00	No	100%	Excellent	Excellent	No
RAID level-10	Yes	50%	Very good	Very good	No
RAID level-1E0	Yes	50%	Very good	Very good	No
RAID level-50	Yes	67% to 94%	Excellent	Good	No

## Drive state descriptions

This section provides descriptions of the physical and logical drive states.

### Physical drive state descriptions

The following table provides descriptions of the valid physical drive states.

Drive State	Meaning
Defunct	A physical drive in the online, hot-spare, or rebuild state has become defunct. It does not respond to commands, which means that the ServeRAID controller cannot communicate properly with the drive.  If a physical drive has become defunct, refer to "Rebuilding a defunct drive" on page 136.
Hot spare	A hot-spare drive is a physical drive that is defined for automatic use when a similar drive fails.
Online	The drive is online. It is functioning properly and is part of an array.
Rebuilding	The drive is being rebuilt.  For more information on rebuilding a drive, refer to "Rebuilding a defunct drive" on page 136.

1. Disk utilization, read, and write performance depend on the number of drives in the array. Generally, the more drives in the array, the better your performance.



Drive State	Meaning
Ready	The ServeRAID controller recognizes a ready drive as being available for definition.
Standby Hot Spare	A standby hot spare is a hot-spare drive that the ServeRAID controller has spun down. If an online drive becomes defunct and no suitable hot-spare drive is available, a standby hot-spare drive of the appropriate size automatically spins up, and enters the rebuild state.

## Logical drive state descriptions

The following table provides descriptions of the valid logical drive states.

Drive State	Meaning
Blocked	<p>During a rebuild operation, the ServeRAID controller sets the state of any RAID level-0 logical drives associated with a failed array to the blocked state; then, it reconstructs the data that was stored in RAID level-1, RAID level-1E, RAID level-5 and RAID level-5E logical drives.</p> <p>After the rebuild operation completes, you can unblock the RAID level-0 logical drives, and access them once again. However, the logical drive might contain damaged data. You must either re-create, reinstall, or restore the data from the most recent backup disk or tape to the RAID level-0 logical drive.</p>
Critical Migrating	A logical drive in the critical state that is undergoing a logical drive migration (LDM).
Critical System	The ServeRAID controller uses this reserved state during a logical drive migration (LDM) when the logical drive is in the critical state.
Critical	<p>A RAID level-1, RAID level-1E, RAID level-5, or RAID level-5E logical drive that contains a defunct physical drive is in the critical state. A critical logical drive is accessible, despite a physical drive failure.</p> <p><b>Attention:</b> If the state of the logical drive is critical, refer to “Rebuilding a defunct drive” on page 136.</p>
Migrating	The logical drive is undergoing a logical drive migration; that is, a change in RAID levels, a change in logical drive size, an increase in free space, or a RAID level-5E compression or decompression.
Offline	<p>The logical drive is offline and not accessible. This state occurs when one of the following is true.</p> <ul style="list-style-type: none"> <li>• One or more physical drives in a RAID level-0 logical drive are defunct.</li> <li>• Two or more physical drives in a RAID level-1, RAID level-1E, or RAID level-5 logical drive are defunct.</li> <li>• Three or more drives in a RAID level-5E logical drive are defunct.</li> </ul> <p>If any of these are true, refer to “Rebuilding a defunct drive” on page 136.</p>
Okay	The logical drive is okay. It is in a good, functional state.
System	The ServeRAID controller uses this reserved state during logical drive migration (LDM).



---

## Chapter 2. Installing and configuring ServeRAID controllers

The following are the steps in the ServeRAID installation process:

- Step 1. Install and cable the ServeRAID controller
- Step 2. Update BIOS and firmware
- Step 3. Configure the ServeRAID controller
- Step 4. Install ServeRAID device drivers while installing the operating system
- Step 5. Install the ServeRAID Manager program
- Step 6. Start the ServeRAID Manager program

The ServeRAID installation process is now complete.

---

### Obtaining ServeRAID updates

IBM periodically makes updated versions of the ServeRAID firmware, device drivers, and utility programs available from the IBM Support page on the World Wide Web. In addition to the updated device drivers and utility programs, there is a command-line program available from the World Wide Web.

**Note:** If you need to update any ServeRAID software, you must update *all* ServeRAID software at the same time to ensure compatibility with all of the levels of the software. This includes:

- BIOS/firmware
- Device drivers
- ServeRAID Manager program
- Command-line programs.

You can download the most current versions of the ServeRAID device drivers and utility programs or a copy of the *IBM ServeRAID Command-Line Programs* diskette from the World Wide Web (see “Downloadable files from the World Wide Web” on page 14).

Refer to the README file on your diskette or CD for installation instructions.

If you do not have access to the World Wide Web, contact your place of purchase, your IBM reseller, or your IBM marketing representative for replacement CDs or diskettes.

The *IBM ServeRAID Support* CD contains the following:

- ServeRAID Manager program. Use this program to configure arrays and logical drives using ServeRAID controllers. This program is available in the following directory:

`d:/PROGRAMS/operatingsystem/MANAGER`

where *d* is the CD-ROM drive and *operatingsystem* is the specific operating system you are using in the ServeRAID installation.

- Device drivers. These files are available in the following directory:

`d:/PROGRAMS/operatingsystem/DRIVER`

where *d* is the CD-ROM drive and *operatingsystem* is the specific operating system you are using in the ServeRAID installation.

- Command-line programs. These command-line programs are available in the following directory:

*d*:/PROGRAMS/*operatingsystem*/CMDLINE

where *d* is the CD-ROM drive and *operatingsystem* is the specific operating system you are using in the ServeRAID installation.

- ServeRAID files needed to install Microsoft Cluster Service (MSCS) when using Microsoft® Windows® NT® or Windows 2000 and an IBM ServeRAID-4H Ultra160 SCSI controller. These files are available in the following directory:

*d*:/PROGRAMS/WINNT/CLUSTER

where *d* is the CD-ROM drive.

The *IBM ServeRAID Device Drivers* diskette contains the following:

- Device drivers for Microsoft Windows NT, Windows 2000, IBM OS/2®, Novell NetWare, and Red Hat Linux 6.1
- DOS CD-ROM drive device drivers

The *IBM ServeRAID Device Drivers for SCO Operating Systems - UnixWare HBA and OpenServer BTL D* diskette contains the following:

- Device drivers for SCO OpenServer 5.0.5
- Device drivers for SCO UnixWare 7.1

## Downloadable files from the World Wide Web

You can download new and updated files for the IBM ServeRAID and Clustering products from the IBM Support Web site:

<http://www.ibm.com/pc/support/>

To access ServeRAID and Clustering support, follow these steps:

1. Click **Servers** on the IBM Support page. The IBM Netfinity and PC Server Support page appears.
2. Select **ServeRAID** or **Clustering** from the **Family** list box. The ServeRAID or Clustering Support page appears.
3. On this page, you can select from the following categories in the left margin:

### Downloadable files

Download the latest versions of Clustering software, the ServeRAID Manager program, BIOS/firmware, device driver updates, and other important information.

### Hints and tips

Obtain useful information for the IBM Clustering and for ServeRAID products and troubleshooting potential problems.

### Online publications

Download the installation and user's guides, references, redbooks, and other IBM publications.

You can also review information on parts, products, and software.

---

## Step 1: Installing and cabling a ServeRAID controller

This section provides installation and cabling instructions for the ServeRAID-4H controller as well as basic information about the standard features of this controller.

If you are using a ServeRAID controller on an IBM Netfinity or PC Server system board, you will not need the information in this section. Continue with “Step 2: Updating BIOS and firmware code” on page 21.

### Controller features

Standard features of the ServeRAID controller are as follows.

Feature	ServeRAID-4H
Arrays (max.)	8
Battery-backup cache	Yes
Cache memory	128 MB
Hard disk drives (max.)	60
Logical drives (max.)	8
Microprocessor	266 MHz
SCSI channels	4
SCSI transfer speed (max.)	160 MB per sec.
Supported RAID levels	0, 1, 5, Enhanced-1 (1E), and Enhanced-5 (5E), 00, 10, 1E0, 50
System PCI data bus	64 bit at 33 MHz

### Connector locations

This section provides illustrations of the SCSI channel connectors and cable connectors for the ServeRAID-4H controller.

The light-emitting diodes (LEDs) on the controllers indicate activity on the SCSI channels and provide diagnostic information for trained service technicians.

#### ServeRAID-4H controller

The ServeRAID-4H controller has four independent SCSI channel connectors: Channel 1, Channel 2, Channel 3, and Channel 4. Each of these SCSI channels supports up to 15 physical devices.

**Note:** The battery-backup cache protects the data being stored in the ServeRAID cache memory during a power outage or failure when using the write-back mode.

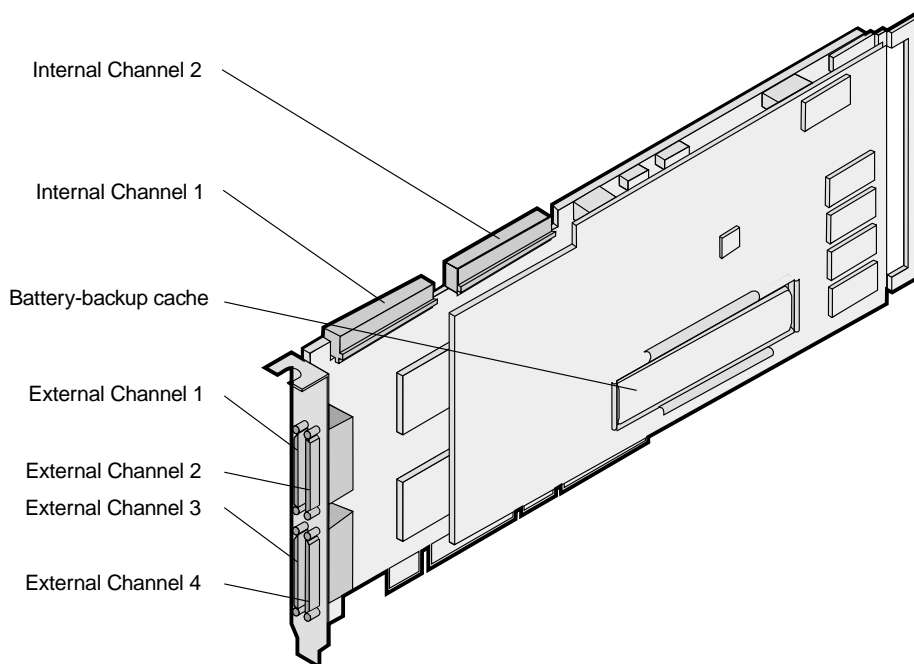

Figure 1. ServeRAID-4H controller

You can attach internal SCSI devices to the Channel 1 and Channel 2 connectors. You can attach external SCSI devices to the Channel 1, Channel 2, Channel 3, and Channel 4 connectors.

**CAUTION:**

**The ServeRAID-4H controller uses a lithium battery.**

**Statement 2:**

**CAUTION:**



**When replacing the lithium battery, use only IBM Part Number 38L3386 or an equivalent type battery recommended by the manufacturer. If your system has a module containing a lithium battery, replace it only with the same module type made by the same manufacturer. The battery contains lithium and can explode if not properly used, handled, or disposed of.**

**Do not:**

- **Throw or immerse into water.**
- **Heat to more than 100 C (212 F)**
- **Repair or disassemble**

**Dispose of the battery as required by local ordinances or regulations.**

## Using a ServeRAID controller in a server with Hot-plug PCI features

Some IBM Netfinity servers support Hot-plug (Active) PCI features. You can use these features to install or remove PCI controllers without turning off the server. The ServeRAID-4H controller supports Hot-plug PCI functions on Windows NT 4.0, Windows 2000, and NetWare. The following table summarizes which operating systems support these features:

Feature	Windows NT 4.0	Windows 2000	NetWare 4.x	NetWare 5.x
Hot add	Yes	Yes	No	Yes
Hot remove	No	Yes	Yes	Yes
Hot replace	Yes	No	No	No

You can use the hot-add feature to expand capacity in a server by adding a controller. Use the hot-remove feature to remove a controller from a running server. If a controller fails, use the hot-replace feature to replace a controller with an identical controller.

### Using Windows NT 4.0 with Hot-plug PCI features

To use Hot-plug PCI with Windows NT 4.0 and a ServeRAID-4H controller, you must install the IBM Netfinity Hot Plug for Windows NT 4.0 Package, version 4.1 or later. This package is available from the IBM Support Web site; select downloadable files for the IBM Netfinity server you are using. See “Downloadable files from the World Wide Web” on page 14 for additional information.

**Note:** Be sure to read the instructions and restrictions for this software program.

Also, when installing the ServeRAID Manager program, you must choose to install the IBM ServeRAID Hot Replace Wizard.

To perform a hot-replace operation, start the IBM ServeRAID Hot Replace Wizard. You can start this program from within either the IBM Netfinity Hot Plug for Windows NT 4.0 program or the ServeRAID Manager program. You can use the ServeRAID Manager program to start the wizard either on the server with the failed controller, or across the network from a remote installation of the ServeRAID Manager.

**Note:** It is useful to start the IBM ServeRAID Hot Replace Wizard from a remote installation when the server with the failed controller does not have a monitor.

**Attention:** Do *not* attempt a hot-replace operation on Windows 2000 or NetWare by hot- removing a failed controller; then, hot-adding a new controller. Loss of data can occur. If a controller fails on these operating systems, you *must* shut down the server to replace the controller.

## Installing the ServeRAID controller

During the installation, you might need a small, flat-blade screwdriver and the documentation that comes with your server.

To install the ServeRAID-4H controller:

1. Review “Safety Information” on page vii and the Safety Information book provided with your Netfinity server.

**Note:** Some IBM Netfinity servers support Hot-plug PCI features, which allow you to install or remove PCI controllers without turning off the server. If your Netfinity model provides Hot-plug PCI support and you are using Windows NT, Windows 2000, or NetWare 5.x, you do not need to turn off your server to install this controller. This operation is referred to as a hot-add operation. Review the following information before performing this operation on a ServeRAID-4H and your server:

- Information that is provided with your server to determine if your model supports these features.
  - Documentation that is provided with your operating system for using these features.
  - Refer to “Using a ServeRAID controller in a server with Hot-plug PCI features” on page 17.
  - If you intend to perform a hot-add operation using Windows NT 4.0, use the documentation that is provided with the IBM Netfinity Hot Plug for Windows NT 4.0 package.
2. If your server model does not support Hot-plug PCI, turn off the server and disconnect all power cords and cables from the server.
  3. Remove the server cover and locate an empty PCI expansion slot for the controller. Choose a slot that is farthest from other installed components, such as the microprocessor. If necessary, see your server documentation for more detailed information about the expansion slots.

**Note:** For Netfinity 3000 servers, the ServeRAID controllers are supported only when installed in PCI slot 3. *Do not* install these controllers in PCI slots 1 or 2. Before you can install a ServeRAID controller in a Netfinity 3000, you must first remove the standard SCSI controller that comes in PCI slot 3. You can install and use the standard SCSI controller in PCI slots 1 or 2, but devices attached to the standard SCSI controller will no longer provide startup (boot) support.

4. Remove the expansion-slot cover, if applicable.
5. Touch the static-protective package containing the controller to an unpainted metal expansion-slot cover on the server. This drains any static electricity from the package and from your body.
6. Remove the controller from the static-protective package, holding the controller by the edges. Do not touch any exposed components on the controller.
7. Insert the controller in the PCI expansion slot. Press the controller firmly into the slot so that it is fully seated.



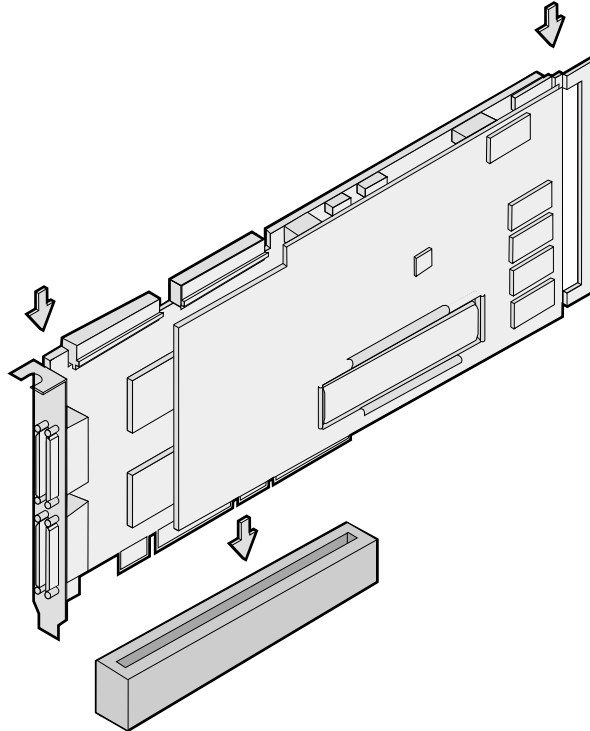

Figure 2. Inserting a ServeRAID-4H controller into the PCI expansion slot

8. Secure the controller by either tightening the expansion-slot screw on the top of the controller or closing the latch, depending on your server.
9. Connect the SCSI cables to the controller. If you intend to attach external devices only, go to step 13 on page 20. Otherwise, continue with step 10
10. Connect one end of a 68-pin ANSI standard cable (separately purchased or already in your server) to the internal channel connector on the ServeRAID controller.

**Note:** See “Connector locations” on page 15 for the channel connector locations.

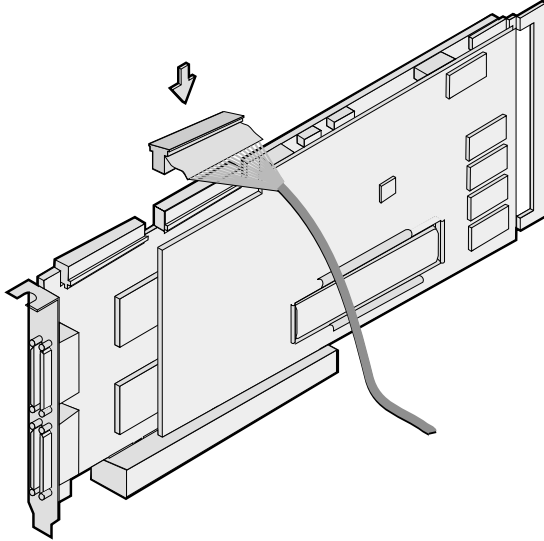

Figure 3. Connecting a ServeRAID-4H controller internal channel connector

11. Connect the other end of the SCSI cable to the Active PCI backplane or to a SCSI device in the server. (See your server documentation or the system label inside the server cover for the location of the SCSI connector on the backplane.)

**Note:** When the ServeRAID controller and a SCSI CD-ROM drive are connected to the same SCSI bus (cable), you must enable the ServeRAID startable (boot) CD feature before the controller can start from a CD. See “Setting the Bootable CD-ROM feature” on page 109 for more information.

12. If you have physical drives to install, install them now. See your server documentation for drive installation instructions.

**Notes:**

- a. The ServeRAID controllers use SCSI ID 7.
  - b. (NetWare only) Removable-media devices (such as a CD-ROM drive) connected to the same ServeRAID controller must each have unique SCSI IDs, even when they are connected to different channels. For example, if you have a CD-ROM drive on Channel 1 set to SCSI ID 6, you must not have another CD-ROM drive on Channel 2 or Channel 3 of the same ServeRAID controller set to SCSI ID 6.
13. Install the server cover.
  14. If you disconnected the cables and power cords in step 2 on page 18, reconnect the cables and cords. See your server documentation if you need detailed instructions.
  15. If you want to attach an external SCSI device to the ServeRAID controller, continue with “Connecting external devices” on page 21. Otherwise, go to “Step 2: Updating BIOS and firmware code” on page 21.

## Connecting external devices

**Note:** The ServeRAID-4H controller does not support configurations that use both the internal and external connectors on the same channel *concurrently*. For example, you cannot use both external Channel 1 and internal Channel 1. To attach SCSI devices to an external channel connector on the ServeRAID controller:

1. Connect one end of a 68-pin very high density connector interface (VHDCI) SCSI cable to an external channel connector on the ServeRAID controller.

**Note:** See “Connector locations” on page 15 for the channel connector locations.

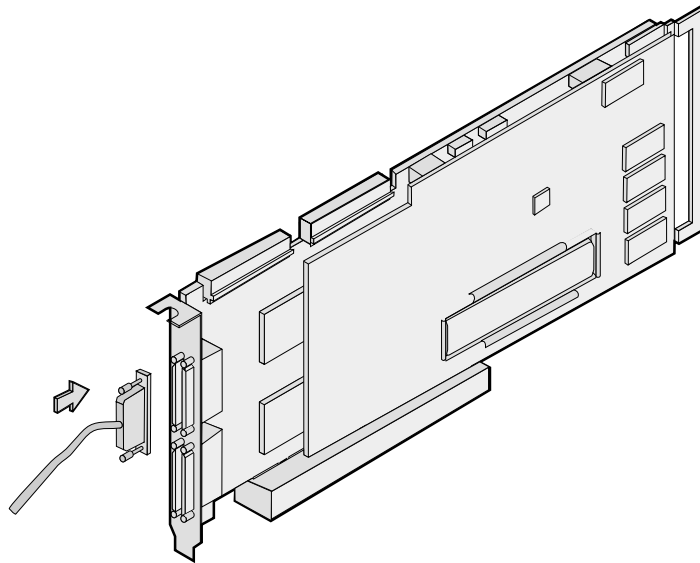

Figure 4. Connecting a ServeRAID-4H controller external channel connector

2. Connect the other end of the SCSI cable to the external SCSI device.
3. Continue with “Step 2: Updating BIOS and firmware code”.

---

## Step 2: Updating BIOS and firmware code

Before configuring the ServeRAID controller, you must have the latest BIOS and firmware code installed on your server.

1. Insert the *IBM ServeRAID Support CD* into the server CD-ROM drive.
2. Turn on the server. The FlashMan program automatically starts.

FlashMan is an easy to use program that simplifies the updating of BIOS and firmware code on ServeRAID controllers. FlashMan automatically scans and identifies each ServeRAID controller in your system. After scanning completes and if an update is required, a report screen opens with the following information:

- Controller types found
- Controller slot number, if known
- Firmware version
- BIOS version
- Update status. If a controller has outdated BIOS or firmware, FlashMan marks the controller as a candidate for update.

If the BIOS and firmware code do not require updating, FlashMan automatically exits and the ServeRAID Manager program opens. Continue with “Step 3: Configuring ServeRAID controllers”.

If the BIOS and firmware code require updating, FlashMan asks if you want to update. You decide whether to update your controllers, but you must update all the controllers or none (that is, you cannot selectively update).

3. Click **Update**. FlashMan displays a progress indicator as it updates the controllers. If FlashMan detects an error, it displays the error message and saves the error message to a file on the disk.  
If you do not want to update your ServeRAID controllers, click **Cancel**.
4. When all updates are complete, scroll through the Features window. This window reports the changes that FlashMan applied to your ServeRAID controllers.
5. Leaving the *IBM ServeRAID Support* CD in the CD-ROM drive, shut down and restart the server.

**Note:** If you update the ServeRAID BIOS/firmware code after the initial configuration, you must clear the ServeRAID logs. You can do this with the ServeRAID Manager installed on your server:

1. Start the ServeRAID Manager.
2. In the Main Tree, click the Local system icon.
3. Click **Actions** → **Clear all controller event logs**.
4. Click **Yes** to confirm the action.

If you do not use the ServeRAID Manager installed on your server, you can use the IPSSSEND utility program for your operating system. Type the following at a command prompt:

```
ipssend eraseevent n soft  
ipssend eraseevent n hard  
ipssend eraseevent n device
```

where *n* is the number of ServeRAID controllers installed in the server (1 - 7). For example, if *n* is 1, the ServeRAID logs for the first (or only) ServeRAID controller are cleared.

---

## Step 3: Configuring ServeRAID controllers

This section provides information about starting and using the ServeRAID Manager program. You can use the ServeRAID Manager program to configure your ServeRAID controllers, view the ServeRAID configuration and associated devices, create arrays and logical drives, delete an array, dynamically increase the logical-drive size, change RAID levels, and much more.

The information in this section is an overview of the ServeRAID Manager program and its capabilities. For instructions on specific processes using the ServeRAID Manager program, refer to the ServeRAID Manager online help.

### Using the ServeRAID Manager program

When you start the ServeRAID Manager program from the startable *IBM ServeRAID Support* CD, you can configure your ServeRAID controller *before* you install your operating system. In startable-CD mode, you can also change specific

ServeRAID controller settings after you have configured the ServeRAID controller and installed the operating system. Refer to “Using Information mode” on page 33 for additional information.

The ServeRAID Manager program runs in two modes: *Configuration* mode and *Information* mode.

In Configuration mode, you can create disk arrays, create logical drives, and define your hot-spare drives. When this mode is active, a limited set of functions is available from the menu and tool bars. See “Using Configuration mode” on page 25 for more information.

In Information mode, you can view and modify the existing device and configuration information for your ServeRAID subsystem. When this mode is active, you can use the functions available from the menu and tool bars to customize settings for your ServeRAID controllers. See “Using Information mode” on page 33 for more information.

To start the ServeRAID Manager program, do the following:

1. Insert the *IBM ServeRAID Support* CD (or the CD that contains the ServeRAID Manager program that came with your system) into the CD-ROM drive; then, turn on the server.

One of the following windows will open:

- If the ServeRAID Manager program detects unconfigured ServeRAID controllers, the program starts in Configuration mode and a window similar to the following opens.

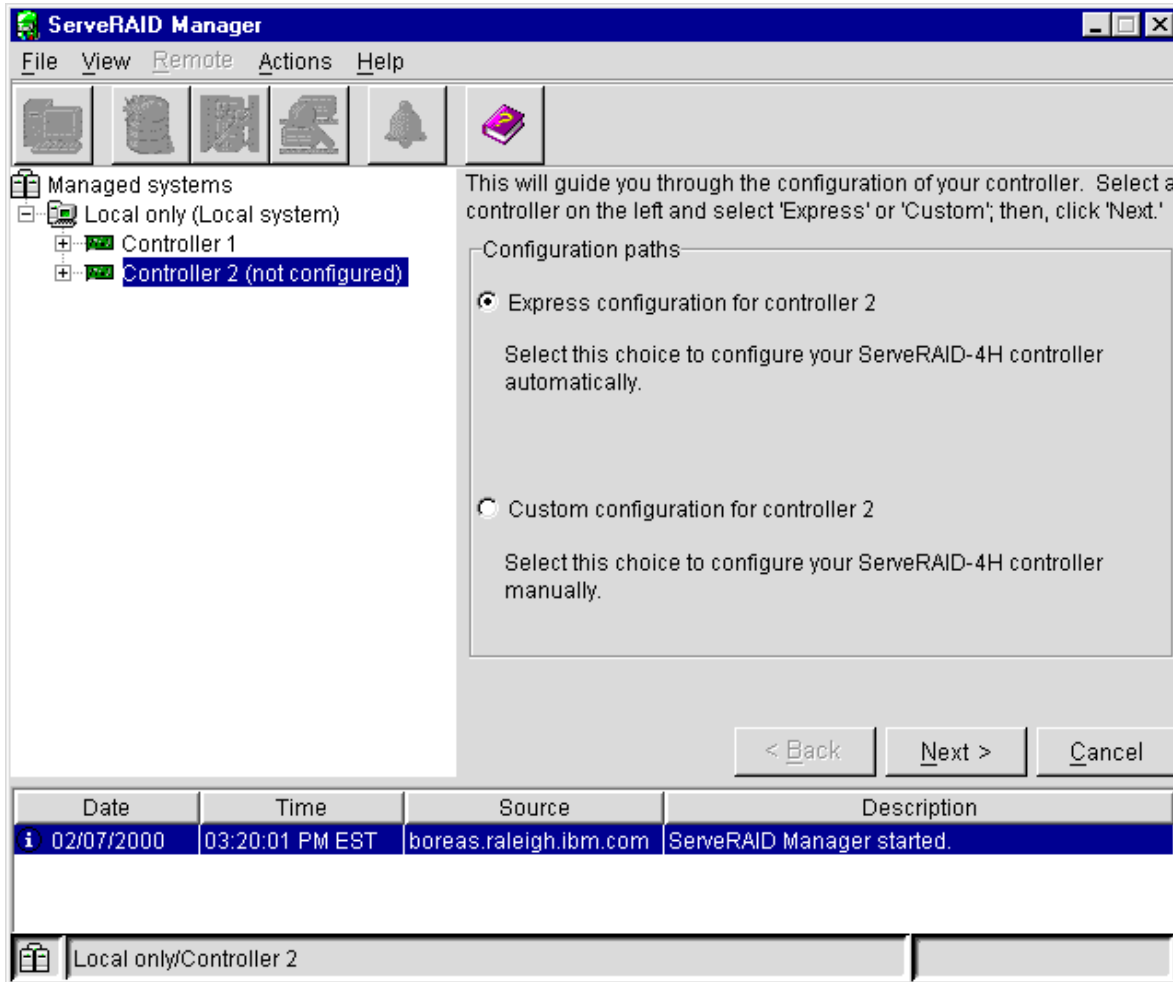

Figure 5. Configuration mode window

Follow the instructions in the right panel to create logical drives on your ServeRAID controller. If you do not want to configure your ServeRAID controller, click **Cancel**. This will switch the program from Configuration mode to Information mode.

- If the ServeRAID Manager program detects that all ServeRAID controllers in the server are configured, the program starts in Information mode and a window similar to the following opens.

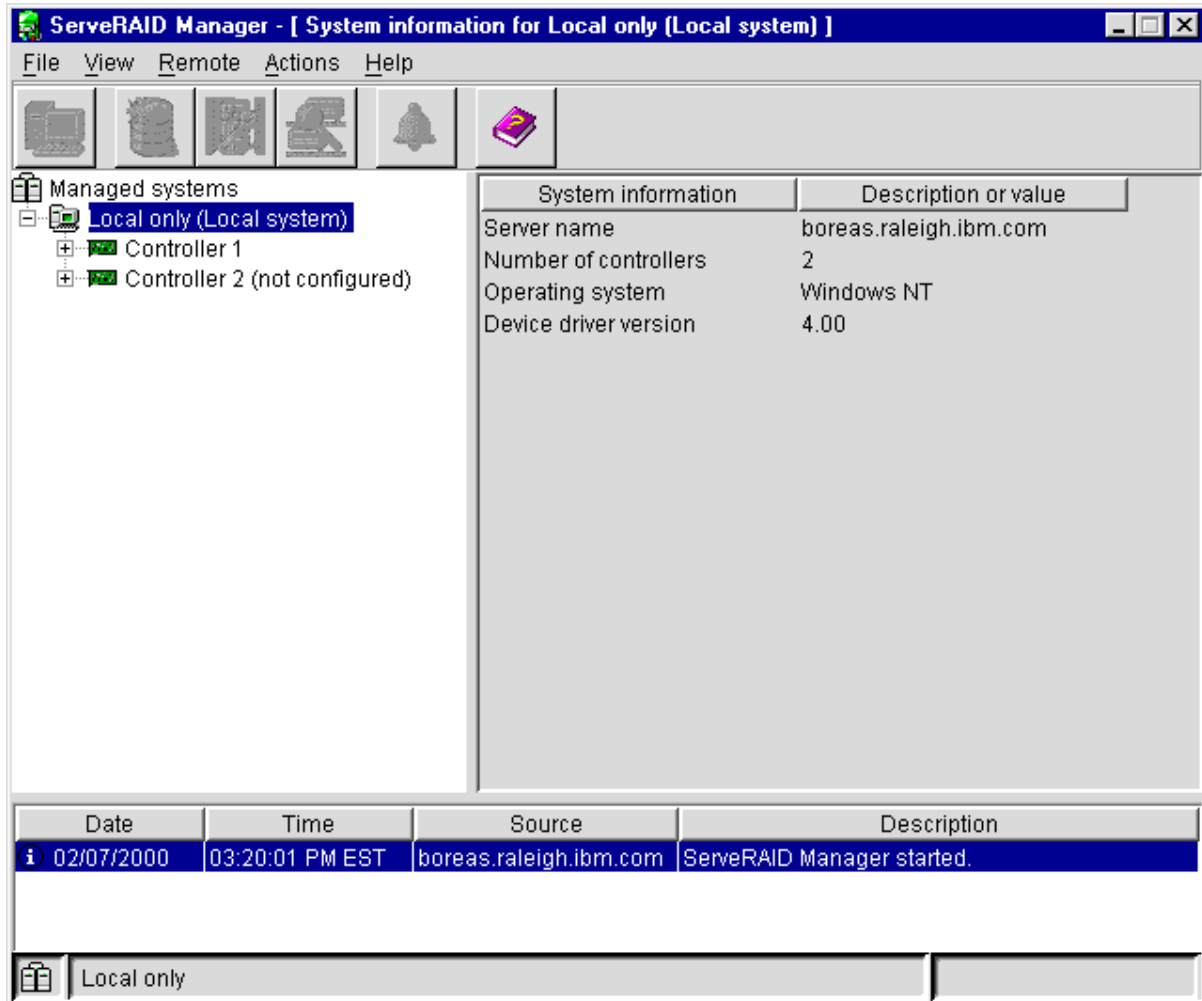



Figure 6. Information mode window



Click  on the tool bar to switch from Information mode to Configuration mode.

2. Continue with one of the following:
  - “Using Configuration mode”.
  - “Using Information mode” on page 33.

### Using Configuration mode

You can use Configuration mode to create up to eight independent disk arrays for each ServeRAID controller. Configuration mode provides two configuration options Express configuration and Custom configuration (see Figure 5 on page 24). You can also use Custom configuration to create spanned arrays and configure the logical drive to RAID level-x0. For more information about RAID level-x0, refer to “Understanding RAID level-x0” on page 8.

**Attention:** The new controller stripe-unit size is set at the factory to 8 KB. If you need to change this setting, you must change the stripe-unit size before you store data in the logical drives. After you store data in the logical drives, you cannot change the stripe-unit size without destroying data in the logical drives. To change the stripe-unit size, do the following:

1. In the Main Tree, click the new controller.
2. Click **Actions** → **Change stripe-unit size**.
3. Click the new stripe-unit size for your installation on the menu.

**Using Express configuration:** To use Express configuration:

**Note:** If the Express configuration mode or Custom configuration mode radio



buttons do not display on the right panel, click  on the tool bar.

1. In the Main Tree, click the ServeRAID controller that you want to configure.
2. If it is not already selected, click the **Express configuration** radio button.
3. Click **Next**. The Configuration summary window opens.
4. Review the information that displays in Configuration summary window.

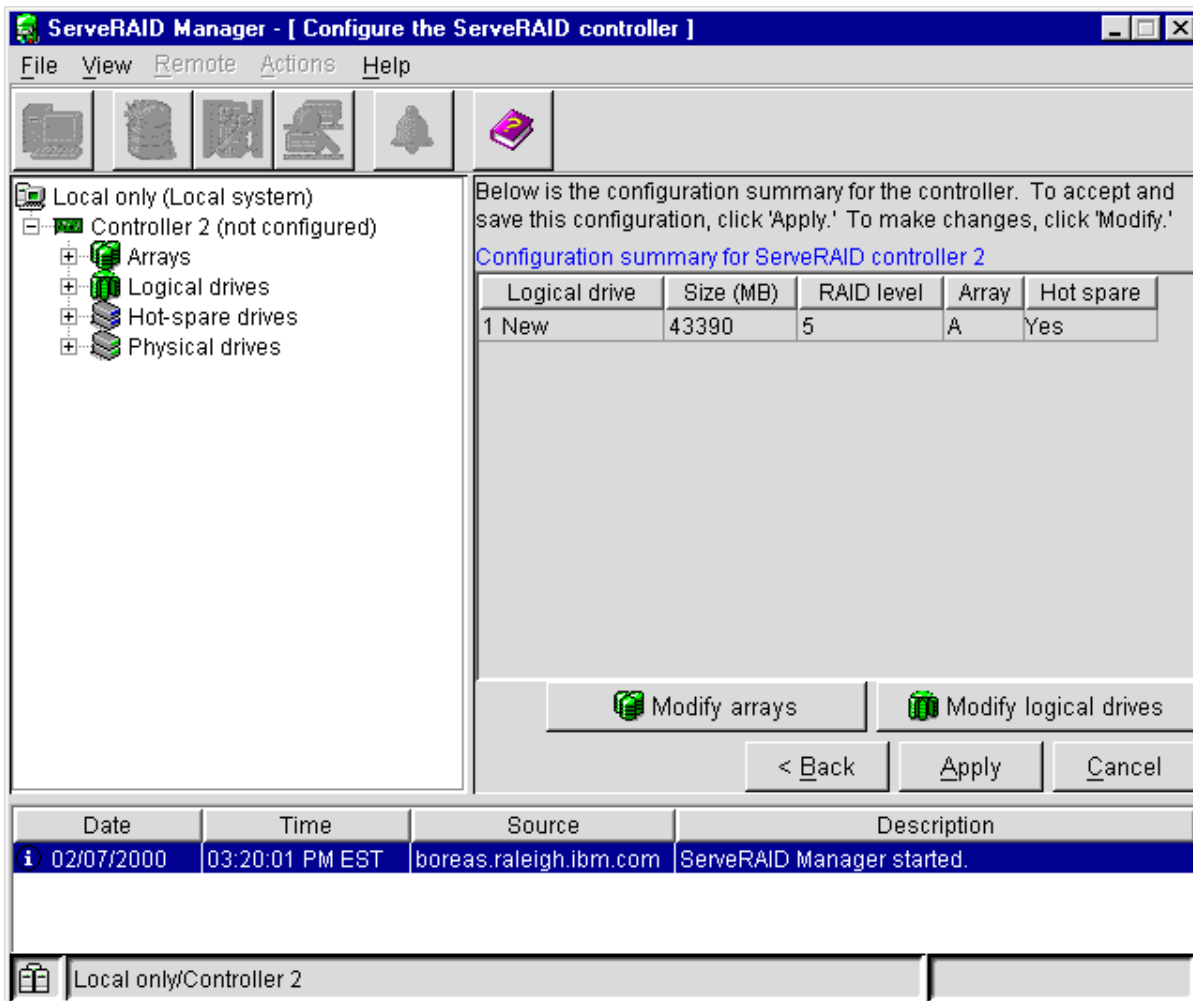

Figure 7. Configuration summary window



**Notes:**

- a. Some operating systems have size limitations for logical drives. Before you save the configuration, verify that the size of the logical drive is appropriate for your operating system. See your operating-system documentation for more detailed information.
- b. To change the configuration, click **Modify arrays** or **Modify logical drives**.
5. Click **Apply** to accept and save the configuration. The configuration is saved in the ServeRAID controller and in the physical drives.
6. If you have multiple controllers, for each controller repeat steps 1 on page 26 through step 5.
7. When you have completed configuration, you can change to Information mode and change controller settings. See “Using Information mode” on page 33 for more information. If you do not want to change any settings, exit the ServeRAID Manager program and remove the CD from the CD-ROM drive.
8. Restart the server.
9. Continue with “Step 4: Installing device drivers” on page 33 to install the ServeRAID device driver while installing your operating system.

**Note:** If you are configuring your startup (boot) ServeRAID controller, you *must* install the device driver while installing the operating system.

**Using Custom configuration:** To use Custom configuration:

**Note:** If the Express configuration mode or Custom configuration mode radio

buttons do not display on the right panel, click  on the tool bar.

1. In the Main Tree, click the ServeRAID controller that you want to configure.
2. Click the **Custom configuration** radio button.
3. Click **Next**. The Create arrays window opens:

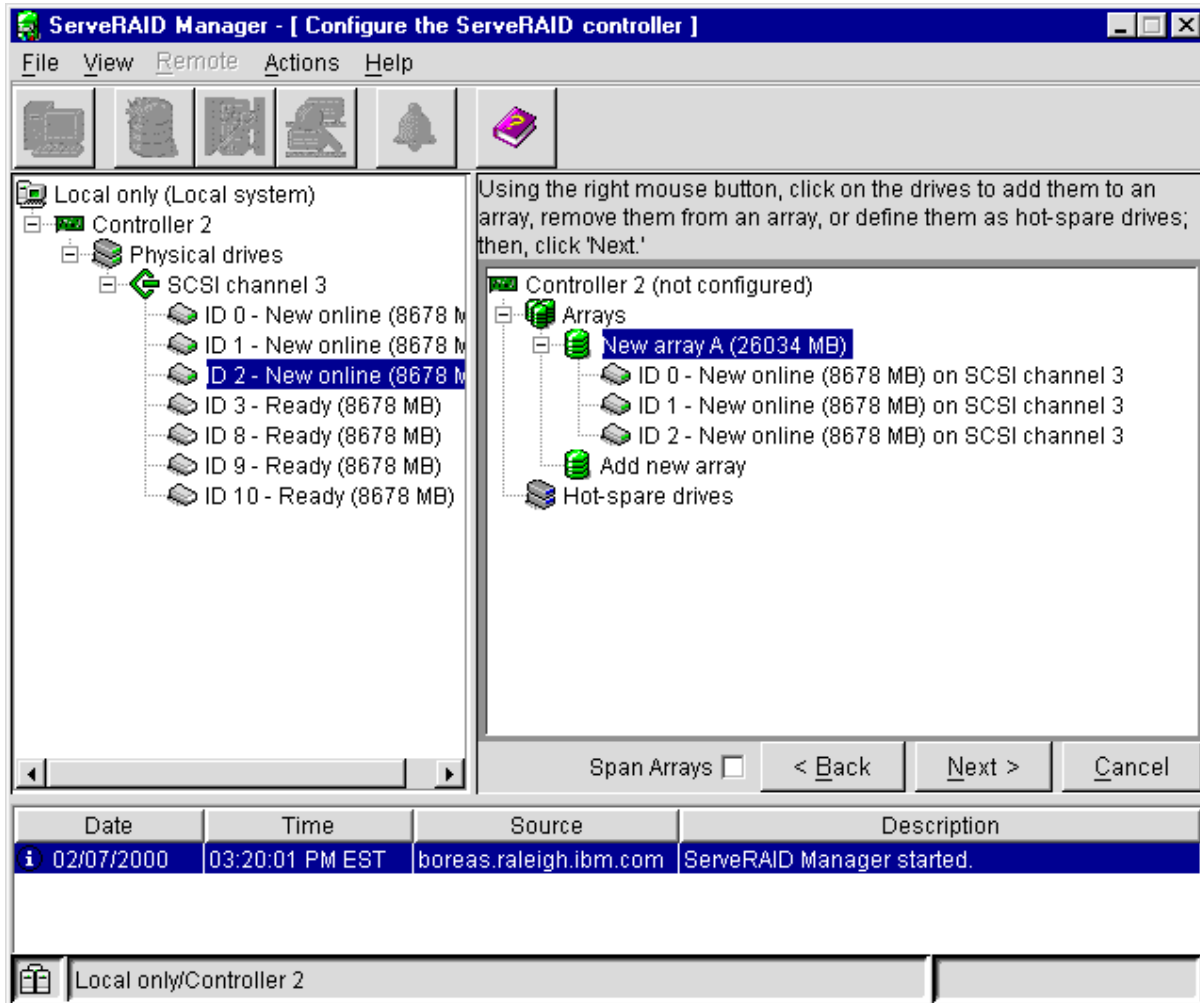

Figure 8. Create arrays window

4. Using the right mouse button, click the drive or SCSI channel icons in the Main Tree to select the drives that you want to add to your arrays, delete from your arrays, or define as hot-spare drives; then, select a choice from the pop-up list. If you want to create a spanned array, click the **Span Arrays** box.
5. After you select the ready drives for your arrays and define your hot-spare drives, click **Next**. If you are not creating spanned arrays, the Create logical drives window opens. Continue with step 8 on page 30.  
If you are creating spanned arrays, the Create spanned arrays window opens.

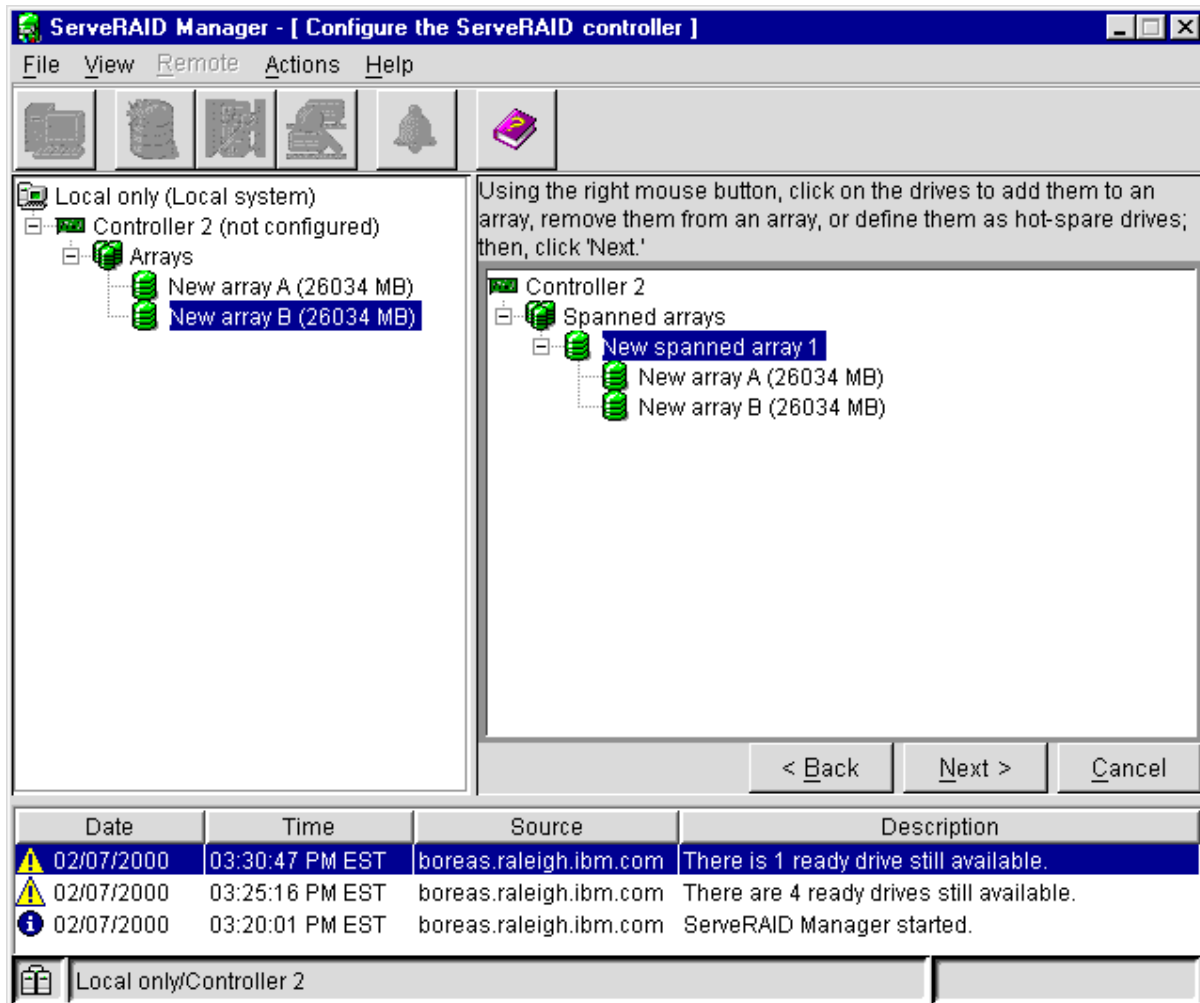

Figure 9. Create spanned arrays window

6. Using the right mouse button, click the array icons in the Main Tree to select the arrays that you want to add or delete to your spanned arrays; then, select a choice from the pop-up list.
7. After you select the arrays for your spanned arrays, click **Next**. The Create logical drives window opens.

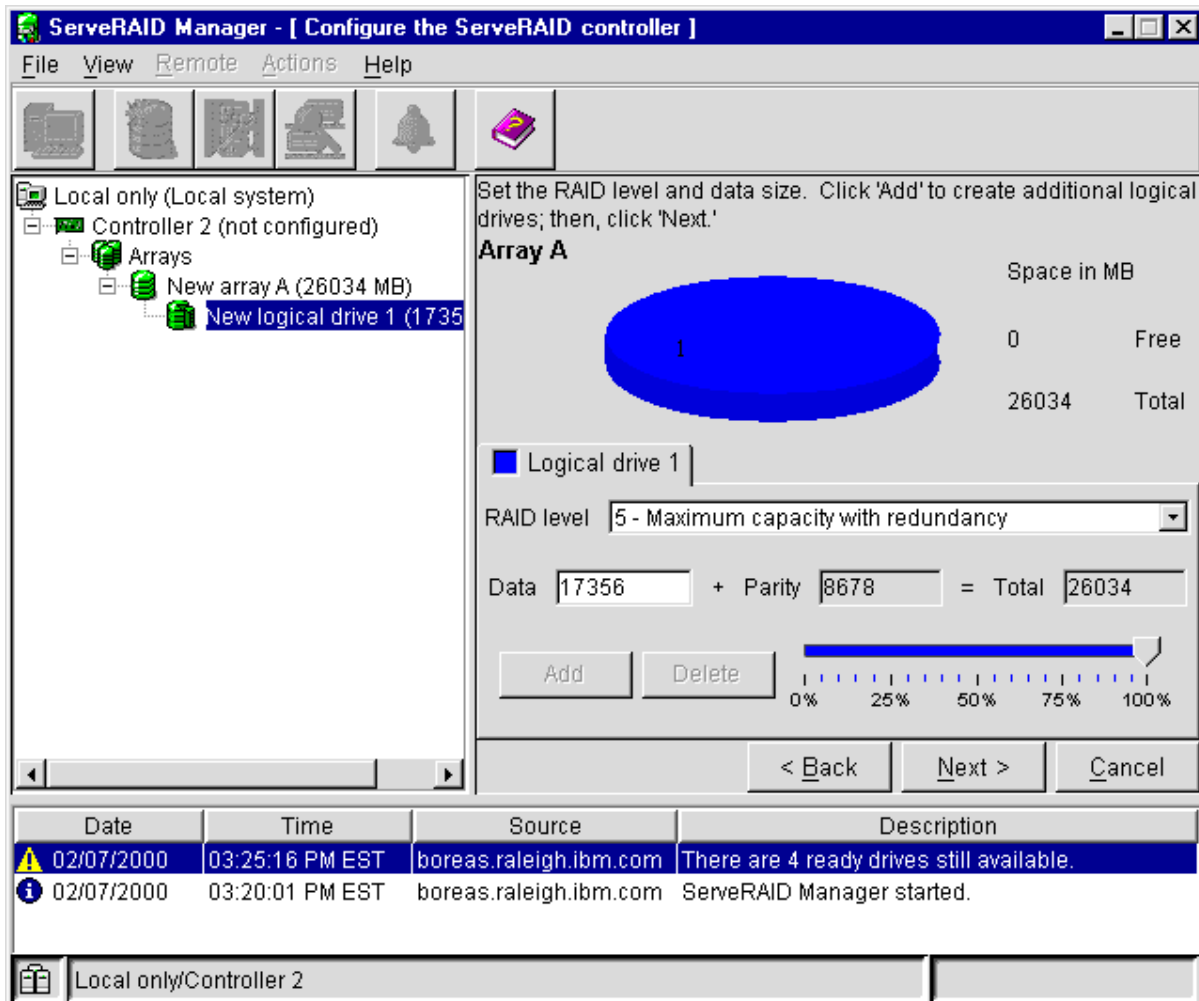

Figure 10. Create logical drives window

8. When creating your logical drives, you might change your mind about the arrays you created. If so, you can:
  - Remove a specific drive from a newly defined array or delete an entire newly defined array. To do this, click **Back**; then, using the right mouse button, click the specific drive or Array icon in the Main Panel on the right. Select **Remove from new array** or **Delete new array**.
  - Remove a specific hot-spare drive or all newly defined hot-spare drives. To do this, click **Back**; then, using the right mouse button, click the Hot-spare drive icon in the Main Panel on the right, and then select **Remove new hot-spare drive** or **Remove all new hot-spare drives**.
9. Select a RAID level for the logical drive from the RAID pull-down menu in the Main Panel. (Refer to “Supported RAID levels” on page 2.)
10. If you do not want to use the maximum size for the logical drive, move the sliding bar in the Main Panel from right to left to allot data and parity space for the logical drive, or type in the size in the data field.

**Notes:**

- a. You can define from one to eight logical drives.

- b. Some operating systems have size limitations for logical drives. Before you save the configuration, verify that the size of the logical drive is appropriate for your operating system. See your operating-system documentation for more detailed information.
  - c. Typically, the first logical drive defined on the first ServeRAID controller found by system BIOS during startup will be your startup (boot) drive.
11. If free space is available and you want to define another logical drive, click **Add** in the Main Panel.

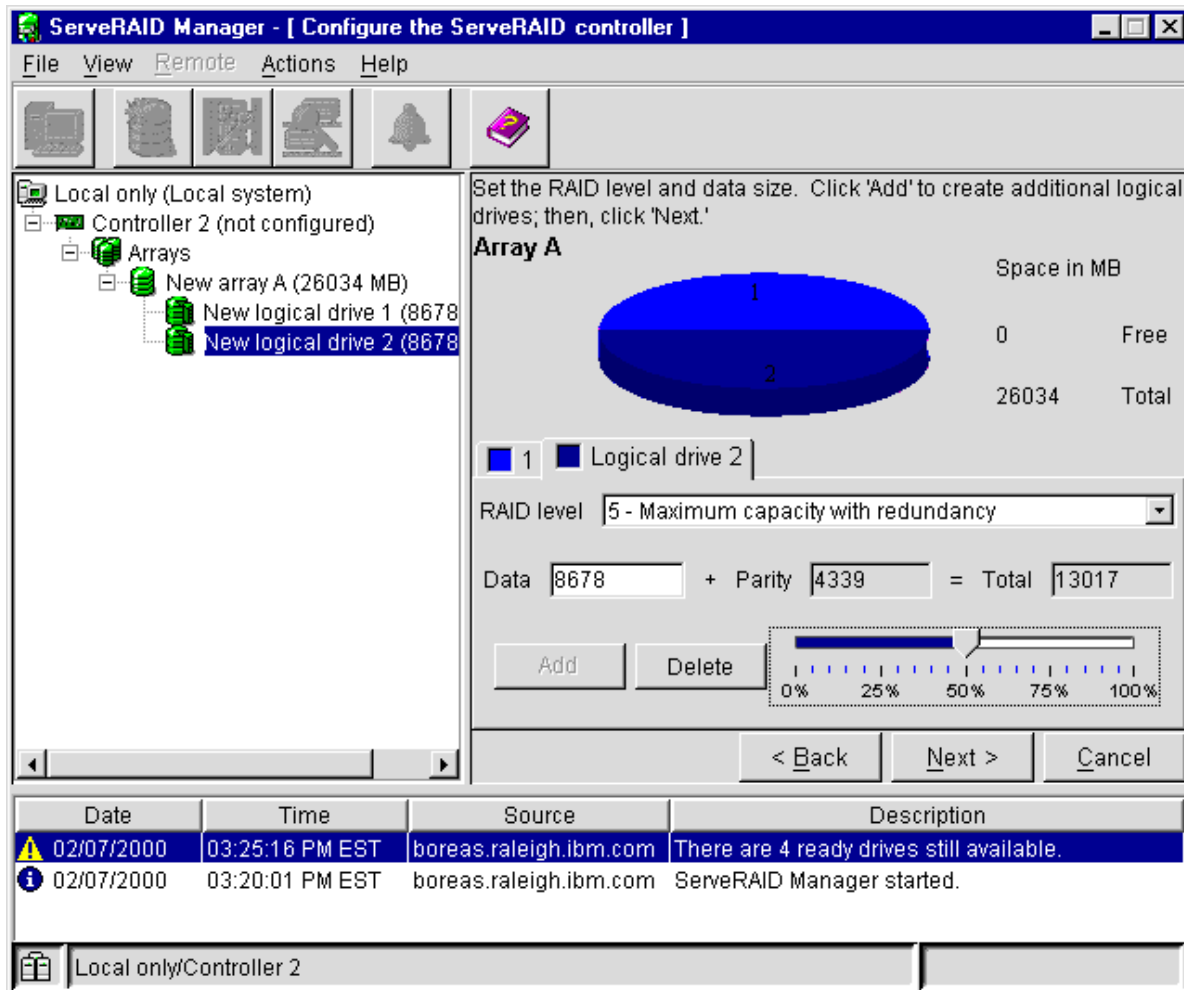

Figure 11. Adding another logical drive

12. Repeat steps 9 on page 30 through 11 on page 31 for each logical drive that you want to define in this array; then, continue with step 13.
13. If you are defining multiple arrays, click the next New array tree node; then, repeat steps 9 on page 30 through 12. When you are finished, go to step 14.
14. Click **Next**. The Configuration summary window opens.
15. Review the information that displays in the Configuration summary window.

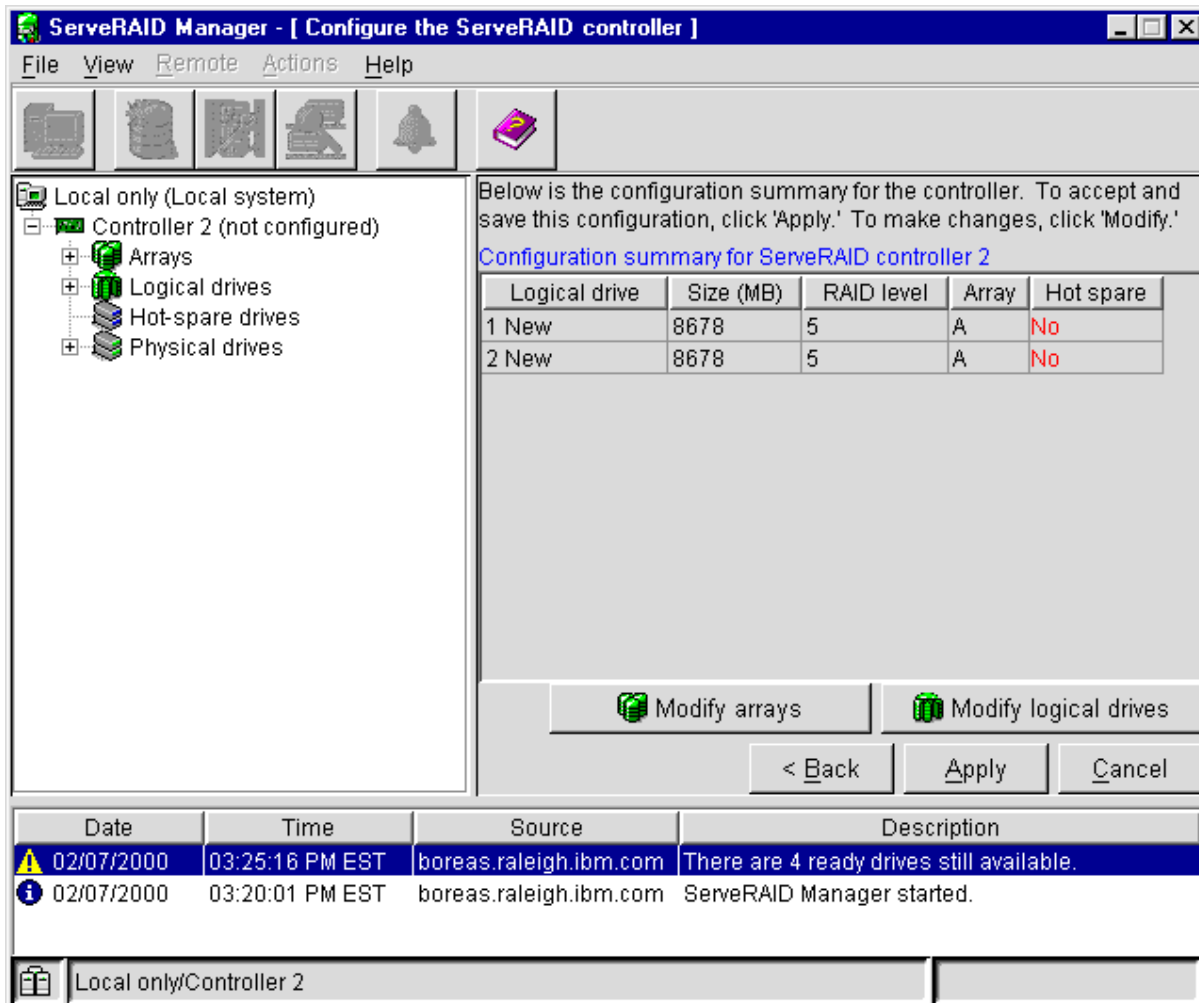

Figure 12. Configuration summary window

**Note:** To change the configuration, click **Modify arrays** or **Modify logical drives**.

- Click **Apply** to accept and save the configuration. The configuration is saved in the ServeRAID controller and on the physical drives.
- If you have multiple controllers, for each controller repeat steps 1 on page 27 through step 16.
- When you have completed configuration, you can change to Information mode and change controller settings. See “Using Information mode” on page 33 for more information. If you do not want to change any settings, exit the ServeRAID Manager program and remove the CD from the CD-ROM drive.
- Restart the server.
- Continue with “Step 4: Installing device drivers” on page 33 to install the ServeRAID device driver while installing your operating system.

**Note:** If you are configuring your startup (boot) ServeRAID controller, you *must* install the device driver while installing the operating system.

## Using Information mode

You can use Information mode to view the configuration information of ServeRAID controllers, arrays, logical drives, hot-spare drives, and physical drives that make up your ServeRAID subsystem (see Figure 6 on page 25). You also can use this mode to change some of the ServeRAID controller settings. These settings include:

- Write-cache mode

**Note:** (NetWare 5.0 only) If you are preparing to install Novell NetWare 5.0 from the startable *Novell NetWare 5.0* CD, set the write-cache mode *only* to write-through mode.

- Controller and partner names
- SCSI initiator IDs
- Merge group numbers
- Read-ahead cache mode
- Stripe-unit size
- Unattended mode
- BIOS compatibility mapping
- Rebuild rate
- SCSI transfer speed

Click an item in the Main Tree and select the Actions menu to display available actions for that item.

**Viewing the device and configuration information:** To view the current settings:

1. Click the plus (+) box next to the object in the Main Tree to expand that portion of the tree.
2. Click the icon for the server, ServeRAID controller, array, logical drive, hot-spare drive, or physical drive to view its current settings.

Detailed information about the selected device will display in the Main Panel on the right.

---

## Step 4: Installing device drivers

This section contains information about the device drivers available for the ServeRAID controllers. These device drivers are provided with the IBM ServeRAID controllers on the following:

- *IBM ServeRAID Support* CD
- *IBM ServeRAID Device Drivers* diskette
- *IBM ServeRAID Device Drivers for SCO Operating Systems - UnixWare HBA and OpenServer BTL* diskette

If you are installing files for an IBM ServeRAID controller that comes as a standard feature on your IBM Netfinity or PC Server system board, use the installation instructions and CDs provided with your server to install these files.

This section provides instructions for installing the device drivers for Windows NT, Windows 2000, NetWare, Linux, OS/2, OpenServer, and UnixWare.

## Installing device drivers while installing the operating system

This section provides instructions for installing the device drivers while installing the operating system.

<b>When using:</b>	<b>Go to:</b>
Windows 2000	"Installing device drivers for Windows 2000".
Windows NT	"Installing device drivers for Windows NT 4.0".
NetWare	"Installing device drivers for NetWare" on page 35.
Linux	"Installing device drivers for Red Hat Linux 6.1(or later)" on page 35.
OS/2	"Installing device drivers for OS/2" on page 36.
OpenServer	"Installing device drivers for OpenServer" on page 38.
UnixWare	"Installing device drivers for UnixWare" on page 39.

### Installing device drivers for Windows 2000

You must install the ServeRAID device driver on the *Windows 2000* CD while installing Windows 2000. The Windows 2000 installation program does not allow you to upgrade a device driver that ships on the *Windows 2000* CD. After installing Windows 2000, you *must* update the ServeRAID device driver to the latest version, which is on the *IBM ServeRAID Support* CD and the *IBM ServeRAID Device Drivers* diskette. Refer to "Installing device drivers after installing Windows 2000" on page 42.

### Installing device drivers for Windows NT 4.0

To install the ServeRAID device driver while installing Windows NT 4.0:

1. Insert one of the following:
  - The Windows NT startup (boot) diskette into the diskette drive
  - The startable Windows NT CD into the CD-ROM drive;

then, restart the server.

**Note:** If you are installing on an IBM Netfinity server that supports Hot-plug PCI under Windows NT 4.0, select the IBM ServeRAID Hot Replace Wizard to enable the hot-replace operation.

2. When the message  
Setup is inspecting your computer's hardware  
configuration...  
  
appears, press the F6 key.
3. After loading some files, Windows displays a screen where you can manually specify a controller. When this screen appears, press the S key to specify additional devices.
4. When prompted in the next window, select **Other** from the list.
5. When prompted to insert the Manufacturer-supplied hardware support disk, insert the *IBM ServeRAID Device Drivers* diskette into the diskette drive; then, press Enter.
6. If you are installing Windows NT 4.0, select **IBM ServeRAID Controller (NT 4.0)**; then, press Enter. A message similar to the following will appear:  
Setup is loading files (IBM ServeRAID Controller (NT 4.0))...
7. When prompted, press Enter to continue.
8. Use the instructions provided in the Windows NT manual to complete the normal installation process.
9. After you complete the installation, be sure to install the latest Service Pack.



## Installing device drivers for NetWare

To install the ServeRAID device driver while installing NetWare 4.x or 5.x:

1. Use the instructions provided in the NetWare manual to begin the installation.
2. When the Choose the Server Drivers - Disk Driver prompt appears during the install process, insert the *IBM ServeRAID Device Drivers* diskette.
3. Click **Select additional or modify selected Disk/LAN drivers**.
4. If IPSRAID appears, select **Deselect a selected driver**.
5. Click **Select an additional driver**; then, press the Ins (Insert) key to add an unlisted new device driver.
6. Press F3 to specify a path; then,
  - For NetWare 4.x, type:  
`a:\netware4`  
  
where *a* is the diskette drive letter.
  - For NetWare 5.x, type:  
`a:\netware5`  
  
where *a* is the diskette drive letter.
7. Click **IPSRAID.HAM** from the list of device drivers that appears in the window; then, press Enter.

**Note:** The IPSRAID.HAM and support files will be copied to the system volume.

8. Click **OK** to overwrite the existing files.
9. Follow the instructions in the NetWare manual to complete the installation.

## Installing device drivers for Red Hat Linux 6.1(or later)

This section provides instructions for installing the ServeRAID device driver (version 1.0) from diskette. Before you can install the device drivers, you must create the Red Hat device driver diskette (see "Creating the Red Hat Linux device driver diskette" on page 35).

1. Insert the *Red Hat 6.1 Installation* CD into the CD-ROM drive.
2. Turn on or restart the server.
3. At the command prompt, type:  
`linux dd`  
  
and any other options for your installation; then, press Enter.
4. Follow the prompts to complete the installation.

**Creating the Red Hat Linux device driver diskette:** This section provides instructions for creating the Red Hat device driver diskette on the following operating systems: Windows 95, Windows 98, Windows NT 4.0, Windows 2000, OS/2, and Linux.

*Creating the diskette on Windows 95, Windows 98, Windows NT 4.0, or Windows 2000:* To create the Red Hat Linux device driver diskette on Windows 95, Windows 98, Windows NT 4.0, or Windows 2000, do the following:

1. Insert the *IBM ServeRAID Support* CD into the CD-ROM drive.
2. At a DOS prompt, type the following:  
`d:\tools\dsk4w32 images\redhatdd.img a:`

where *d* is the drive letter of the CD-ROM drive and *a* is the drive letter of the diskette drive.

3. Press Enter.
4. Remove the *IBM ServeRAID Support* CD from the CD-ROM drive.

*Creating the diskette on OS/2 Warp®:* To create the Red Hat Linux device driver diskette on OS/2 Warp, do the following:

1. Insert the *IBM ServeRAID Support* CD into the CD-ROM drive.
2. At a DOS prompt, type the following:

```
d:\tools\dsk4wrp images\redhatdd.img a:
```

where *d* is the drive letter of the CD-ROM drive and *a* is the drive letter of the diskette drive.

3. Press Enter.
4. Remove the *IBM ServeRAID Support* CD from the CD-ROM drive.

*Creating the diskette on Linux:* To create the Red Hat Linux device driver diskette on Linux, do the following:

1. Insert the *IBM ServeRAID Support* CD into the CD-ROM drive.
2. Type:

```
mount -t iso9660 /dev/cdromdevicefile /mnt
```

where *cdromdevicefile* is the specific device file for the CD-ROM block device. Typically this is */dev/cdrom*.

3. Type: `dd if=/mnt/images/redhatdd.img of=/dev/diskettedevicefile bs=32k`

where *diskettedevicefile* is the specific device file for the diskette block device. Typically this is */dev/fd0*.

4. Unmount the CD-ROM:  
`umount /mnt`
5. Remove the *IBM ServeRAID Support* CD from the CD-ROM drive.

## Installing device drivers for OS/2

You can use the following instructions to install the ServeRAID device driver files while installing OS/2 Warp Server.

**Note:** When starting the OS/2 Diskette 1 in Drive A after the logo screen appears and the Please Wait messages, you might receive the following message:

```
* Initializing Raid SCSI Subsystem.  
* Unable to allocate IRQ resources.  
* RMCreat Device Adapter failure.  
* RMCreat Device (disk) failure.  
* RMCreat Device (disk) failure.  
* RMCreat Device (disk) failure.  
* RMCreat Device (disk) failure.
```

If you receive these messages, disregard them during installation. The installation will complete successfully. After the installation completes, install an updated RESOURCE.SYS file that is available from the OS/2 Device Driver Pak On-Line Web site at the following address:

<http://service.software.ibm.com/os2ddpak/index.htm>

At this Web site, follow these steps to obtain the updated RESOURCE.SYS file:

1. Scroll down to the bottom and click **Yes, I agree. Show the Device Category list.**
2. Scroll down and select **OS/2 Component Updates** from the list.
3. Select **OS/2 Base Device Driver Updates.**
4. Select **RESOURCE.SYS update; pre-requisite for updated IBM RAID Driver.**
5. Follow the instructions at the Web site for installing the RESOURCE.SYS update after you have installed OS/2.

To install the ServeRAID files while installing OS/2:

1. Make a copy of the *OS/2 Warp Diskette 1* and label it *Copy of OS/2 Diskette 1*.
2. Copy the IPSRAID.ADD file from the OS2 directory on the *IBM ServeRAID Device Drivers* diskette to the *Copy of OS/2 Diskette 1*.

If there is not enough space, delete files not needed in your installation (such as proprietary CD-ROM or SCSI device drivers). Make sure you remove all entries referring to any device drivers you delete from the CONFIG.SYS file.

#### Important

If you have more than one or SCSI adapter in your system, make sure that the BASEDEV statement for the adapter or controller controlling the startup (boot) device appears first in the CONFIG.SYS file before the BASEDEV statements for other or SCSI adapters.

3. Edit the CONFIG.SYS file on the *Copy of OS/2 Diskette 1* to add the following lines:  
BASEDEV=IPSRAID.ADD  
SET COPYFROMFLOPPY=1
4. Install OS/2, but when you are prompted to insert Diskette 1, use the updated *Copy of OS/2 Diskette 1*.
5. After you complete the OS/2 installation, insert the *IBM ServeRAID Device Drivers* diskette.
6. From an OS/2 window, type:  
*a*:  
  
where *a* is the drive letter for the diskette drive that contains the ServeRAID diskette.
7. Press Enter; then, type:  
ddinstal
8. Press Enter. The OS/2 Device Driver Installation window opens.
9. In the **Source** field type *a*: (where *a* is the letter of the diskette drive where the *IBM ServeRAID Device Drivers* diskette is located). In the **Destination** field, type the full path where you want the device driver files to be copied.
10. Click **Install**. The program copies the IPSRAID.ADD ServeRAID device driver to the OS/2 subdirectory on your hard disk.
11. Edit the CONFIG.SYS file and verify that there is only one copy of the line BASEDEV=IPSRAID.ADD.

**Notes:**

- a. If you have more than one ServeRAID or SCSI adapter in your system, make sure that the BASEDEV statement for the adapter or controller controlling the startup (boot) device appears first in the CONFIG.SYS file before the BASEDEV statements for other ServeRAID or SCSI adapters.
  - b. After you install any service packs, check the path for the IPSRAID.ADD device driver and verify that the correct device driver is installed.
12. Restart the server.

**Installing device drivers for OpenServer**

Before you begin the installation, review the following information:

- You must install logical drives as Bus Number 0 when using the MKDEV program, regardless of the channel that the physical drives are on.
- You must install a nondisk device, such as a CD-ROM or tape drive, as Bus Number 1, 2, 3, or 4 relative to the channel to which it is attached. Internal Channel 1 is Bus Number 1, internal Channel 2 is Bus Number 2, external Channel 1 is Bus Number 1, external Channel 2 is Bus Number 2, external Channel 3 is Bus Number 3, and external Channel 4 is Bus Number 4.

To configure the default nondisk devices during the initial installation:

1. Redefine the default tape drive in the initial boot string. For example, to install the boot-time loadable driver IPSRAID BTLD and redefine the tape drive, go to the B00T prompt and type:

```
link Stp=ips(0, 1, 2, 0)
```

The numbers in parentheses represent the host adapter number, the bus number, the SCSI ID, and the LUN respectively.

2. When prompted for the location of the installation CD, change the bus number and SCSI ID, as required.

**Adding IPSRAID BTLD at startup time:** To install the ServeRAID device driver for OpenServer 5.x.5:

1. At the B00T prompt, type:

```
link
```

2. Press Enter; then, when prompted for the name of the package, type:

```
ipsraid
```

3. Press Enter.

4. After the kernel loads but before it runs, the link program prompts you to insert the *IBM ServeRAID Device Drivers for SCO Operating Systems - UnixWare HBA and OpenServer BTLD* diskette.

While the installation program copies the files, one or both of the following messages might appear:

- Extracting BTLD distribution for ipsraid... /etc/uadmin  
getdev b ips: No such device (error 19)
- dynamic linker: dlvr\_audit: Cannot open /dev/zero for file  
/lib/libprot.so.1

You can ignore the first message; if the second message appears, however, you must press Enter when prompted to continue the installation.

5. Keep the *IBM ServeRAID Device Drivers for SCO Operating Systems - UnixWare HBA and OpenServer BTLD* diskette available. You will need it to configure the device driver into the link kit.

For additional information about adding a boot-time loadable driver at boot time, refer to “Using Boot-Time Loadable Drivers” in the *SCO OpenServer Handbook*.

### **Installing device drivers for UnixWare**

The instructions that you use for installing the ServeRAID files when using UnixWare depend on the number of IDE and SCSI disk-storage adapters and controllers installed in the system. If all of the direct-access-storage devices (DASD) in the system are attached to a single disk-storage adapter or controller (such as the ServeRAID controller), you can skip the instructions in this section and go directly to “Installing the files while installing UnixWare” on page 41.

***Attaching devices to multiple disk-storage adapters or controllers:*** If you are attaching devices to multiple disk-storage adapters or controllers (including IDE and SCSI controllers integrated on the system board), use the following instructions. If you are not using multiple disk-storage adapters and controllers go to “Installing the files while installing UnixWare” on page 41.

- If you are installing UnixWare on a drive attached to a ServeRAID controller, follow the instructions in “Installing UnixWare on a ServeRAID drive”.
- If you are installing UnixWare on a drive attached to a non-ServeRAID adapter or controller and you intend to store only data on the drives attached to your ServeRAID controllers, follow the instructions in “Installing UnixWare on a non-ServeRAID drive” on page 40.

***Installing UnixWare on a ServeRAID drive:*** Use the following instructions if you are using multiple disk-storage adapters or controllers and you are installing UnixWare on a drive attached to a ServeRAID controller. If you not using multiple disk-storage adapters and controllers, go to “Installing the files while installing UnixWare” on page 41.

1. Install all ServeRAID controllers that you intend to use in your system.
2. Using the ServeRAID Manager program, create all of your arrays and define all of your logical drives.
3. Make a list of all of the ServeRAID controllers, including the order and slot number, installed in the system. To do this:
  - a. Turn on the server.
  - b. If the ServeRAID Mini-Configuration prompt appears, press Ctrl+I. When a system contains more than one ServeRAID controller, a selection window appears.
  - c. The menu lists the ServeRAID controllers in order. Select the first ServeRAID controller from the menu.
  - d. Select **Advanced Functions** from the Main Menu.
  - e. Select **View Controller and PCI Information** from the Advanced Functions menu.
  - f. Record the slot number for the ServeRAID controller; then, press Esc three times to return to the controller-selection window.
  - g. Repeat step 3c through step 3f until you record the slot number for each ServeRAID controller that appears on the selection screen.
4. Turn off the system; then, remove all ServeRAID controllers except the first one on your list.

**Note:** If one of the ServeRAID controllers that you need to remove is on the system board, you must do one of the following:

- If the CD-ROM drive that you are using to install your operating system is attached to the integrated ServeRAID controller, disconnect or remove all disk drives attached to the integrated controller.
  - If only disk drives are attached to the integrated controller, disconnect the SCSI cable from the ServeRAID connector on the system board. See the label inside the server cover for the location of the ServeRAID connector.
5. Remove all other non-ServeRAID IDE and SCSI disk-storage adapters or controllers.

**Note:** If one of the disk-storage controllers that you need to remove is on the system board, you must do one of the following:

- If the CD-ROM drive that you are using to install your operating system is attached to the integrated disk-storage controller, disconnect or remove all disk drives attached to the integrated controller.
  - If only disk drives are attached to the integrated controller, disconnect the cable for the integrated controller from the IDE or SCSI connector on the system board. See the label inside the server cover for the location of the IDE or SCSI controller connector.
6. Follow the instructions in “Installing the files while installing UnixWare” on page 41; then, return here and continue with step 7.
  7. Turn off the system.
  8. Install any non-ServeRAID disk-storage adapters or controllers in the server; then, attach the drives to the disk-storage adapters and controllers.
  9. Install the second ServeRAID controller from the list you created in step 3f on page 39; then, attach the drives to the ServeRAID controller.
  10. Turn on the system and allow UnixWare to detect the new disk-storage adapters and controllers.
  11. Turn off the system.
  12. Repeat steps 9 on page 40 through 11 on page 40 until all ServeRAID adapters, ServeRAID controllers, and drives are installed.
  13. You can now partition and format the logical drives attached to the additional ServeRAID adapters and controllers. See the information provided with UnixWare for more instructions.

*Installing UnixWare on a non-ServeRAID drive:* Use the instructions in this section if you are using multiple disk-storage adapters or controllers, you are installing UnixWare on a drive attached to a non-ServeRAID adapter or controller, and you intend to store only data on the drives attached to your ServeRAID adapters and controllers.

1. Install all ServeRAID controllers that you intend to use in your system.
2. Using the ServeRAID Manager program, create all of your arrays and define all of your logical drives.
3. Make a list of all of the ServeRAID controllers, including the order and slot numbers, installed in the system. To do this:
  - a. Turn on the server.
  - b. When the ServeRAID Mini-Configuration prompt appears, press Ctrl+I. When a system contains more than one ServeRAID controller, a selection screen appears.
  - c. The menu lists the ServeRAID controllers in order. Select the first ServeRAID controller from the menu.

- d. Select **Advanced Functions** from the Main Menu.
  - e. Select **View Controller and PCI Information** from the Advanced Functions menu.
  - f. Record the slot number for the ServeRAID controller; then, press Esc three times to return to the controller-selection screen.
  - g. Repeat step 3c on page 40 through step 3f until you record the slot number for each ServeRAID controller that appears on the selection screen.
4. Turn off the system; then, remove all ServeRAID, IDE, and SCSI disk-storage adapters and controllers except the one attached to the drive where you intend to install UnixWare.

**Note:** If one of the disk-storage or ServeRAID controllers that you need to remove is on the system board, do one of the following:

- If the CD-ROM drive that you are using to install your operating system is attached to the integrated controller, disconnect or remove all disk drives attached to the integrated controller.
  - If only disk drives are attached to the integrated controller, disconnect the SCSI or IDE cable for the integrated controller from the connector on the system board. See the label inside the server cover for the location of the SCSI and IDE cable connectors.
5. Follow the instructions in “Installing the files while installing UnixWare”; then, return here and continue with step 6.
  6. Turn off the system.
  7. Install any non-ServeRAID disk-storage adapters or controllers in the server; then, attach the drives to the disk-storage adapters and controllers.
  8. Install the first ServeRAID controller from the list you created in step 3f; then, attach the drives to the ServeRAID controller.
  9. Turn on the system and allow UnixWare to detect the new disk-storage adapters and controllers.
  10. Turn off the system.
  11. Repeat steps 8 on page 41 through 10 on page 41 until all ServeRAID adapters, ServeRAID controllers, and drives are installed.
  12. You can now partition and format the logical drives attached to the ServeRAID adapters and controllers. See the information provided with UnixWare for more instructions.

**Installing the files while installing UnixWare:** To install the ServeRAID files while installing UnixWare 7.1:

1. Use the instructions provided with UnixWare to begin the installation.
2. When a message appears asking if you want to install any HBA diskettes, insert the *IBM ServeRAID Device Drivers for SCO Operating Systems - UnixWare HBA and OpenServer BTL D* diskette; then, select **Install HBA diskette**.
3. Use the instructions provided in the UnixWare manual to complete the normal installation process.

## Installing or updating device drivers after installing the operating system

This section provides instructions for installing the device drivers after you have installed the operating system. You can also use these instructions to update a device driver.

<b>When using:</b>	<b>Go to:</b>
Windows 2000	"Installing device drivers after installing Windows 2000"
Windows NT	"Installing device drivers after installing Windows NT 4.0" on page 43.
NetWare	"Installing device drivers after installing NetWare 4.x or 5.x" on page 43.
Linux	"Updating device drivers for Red Hat Linux 6.1 (or later)" on page 44.
OS/2	"Installing device drivers after installing OS/2" on page 46.
OpenServer	"Adding IPSRAID BTLD after installing OpenServer" on page 47.
UnixWare	"Installing device drivers after installing UnixWare" on page 47.

### Installing device drivers after installing Windows 2000

To install the ServeRAID device driver after installing Windows 2000:

1. Insert the *IBM ServeRAID Support* CD into the CD-ROM drive.
2. From the Start Menu, click **Programs** → **Administrative Tools** → **Computer Management**. The Computer Management windows opens.
3. In the left tree, click **System Tools**; then, click **Device Manager**.
4. In the right tree, click the SCSI adapters and RAID controllers to display all the controllers in the server.
5. Using the right-mouse button, click the first ServeRAID controller in the tree; then, click **Properties**. The Properties windows opens.
6. Click the **Driver** tab; then, click **Upgrade**. The Update Device Driver Wizard opens.
7. Click **Next**.
8. Verify that **Search for a suitable driver for my device (recommended)** is checked; then, click **Next**.
9. Uncheck **Floppy disk drives**, **CD-ROM drives**, and **Microsoft Windows Update**.
10. Verify that **Specify a location** is checked; then, click **Next**.
11. In the **Copy manufacturer's files from** field, type:
  - If you are installing from diskette, type:  
`a:\win2k`  
  
where *a* is the diskette drive letter.
  - If you are installing from CD, type:  
`z:\programs\winnt\driver\win2k`  
  
where *z* is the CD-ROM drive letter.
12. Click **OK**.
13. Click **Next**; then, click **Finish**.
14. Click **Close**.
15. After the device driver installs, remove the diskette or the CD from drive and restart the server.



## Installing device drivers after installing Windows NT 4.0

To install the ServeRAID device driver after installing Windows NT 4.0:

1. Insert the *IBM ServeRAID Device Drivers* diskette into the diskette drive or insert the *IBM ServeRAID Support* CD into the CD-ROM drive.
2. From the Start Menu, click **Settings**; then, click **Control Panel**.
3. Select SCSI Adapter; then, click the **Drivers** tab.
4. Click **Add**; then, click **Have Disk**.
5. In the **Copy manufacturer's files from** field:
  - If you are installing from diskette, type:  
`a:\nt4_0`  
  
where *a* is the diskette drive letter.
  - If you are installing from CD, type:  
`z:\programs\winnt\driver\nt4_0`  
  
where *z* is the CD-ROM drive letter.
6. Click **OK**; then in the next dialog box, click **OK** again.
7. After the device driver installs, remove the diskette or the CD from the drive and restart the server.

## Installing device drivers after installing NetWare 4.x or 5.x

**Note:** If the device driver and operating system is already installed, do the following before starting this procedure:

1. Type:  
`Unload IPSRAID`
2. Press Enter; then, go to step 1 on page 43 in the following instructions.

To install the files after installing NetWare 4.x or 5.x, do the following:

1. From the system console, start the NetWare installation utility program:
  - For NetWare 4.x, type:  
`load install`
  - For NetWare 5.x, type:  
`load nwconfig`
2. Press Enter.
3. Insert the *IBM ServeRAID Device Drivers* diskette into the diskette drive or insert the *IBM ServeRAID Support* CD into the CD-ROM drive.
4. Click **Driver options** from the Installation Options list.
5. Click **Configure disk and storage** from the Driver Options window.
6. Select **Select an additional driver** from the Additional Drivers Actions window.
7. When the next window opens, press the Ins key to install an unlisted driver.
8. When the next window opens, press the F3 key to specify a different path.
9. In the **Specify a directory path** field:
  - For NetWare 4.x: If you are installing from diskette, type:  
`a:\netware4`  
  
where *a* is the diskette drive letter.
  - For NetWare 4.x: If you are installing from CD-ROM, type:  
`d:\programs\netware\driver\netware4`

where *d* is the CD-ROM drive letter.

- For NetWare 5.x: If you are installing from diskette, type:  
`a:\netware5`

where *a* is the diskette drive letter.

- For NetWare 5.x: If you are installing from CD-ROM, type:  
`d:\programs\netware\driver\netware5`

where *d* is the CD-ROM drive letter.

10. When prompted to select a device driver to install, select IPSRAID.HAM.
11. Click **Yes** when prompted to copy the IPSRAID.HAM driver.
12. When the prompt appears to specify the server boot path, type:

`c:\nwserver`

**Notes:**

- a. This instruction assumes that you installed NetWare in its default directory. If you did not install NetWare in the NWSERVER directory on drive C, modify step 12 on page 44 accordingly.
  - b. If any of the files you are installing already exist on the server, NetWare will prompt you to save the older files. Although it is not necessary to save the older files, it might be useful to do so.
13. After the installation program copies all files, you can edit parameters (such as the ServeRAID slot number) from the Driver IPSRAID Parameter Actions window.
  14. After you edit the parameters, click **Save Parameters and load driver** to load the ServeRAID device driver.

**Note:** If the device driver is not installed already and the operating system is installed, an error message stating that the device driver failed to load should appear after you complete the previous step. If that happens, do the following:

- a. Press Esc to exit from the installation screens.
  - b. Shut down the server.
  - c. Restart the server by typing the following at the system prompt:  
`server`
  - d. The server automatically loads and installs the device driver.
15. Press Esc to exit from the installation screens.

**Note:** If you want NetWare to load the ServeRAID device driver automatically during startup, you must add the appropriate LOAD command (for example, `load ipsraid.ham slot=1`) to the NetWare startup command file (usually `C:\NWSERVER\STARTUP.NCF`).

### Updating device drivers for Red Hat Linux 6.1 (or later)

This section provides instructions for updating the ServeRAID device drivers from CD-ROM, diskette, and the World Wide Web. You can update the device drivers if Linux is already installed or when updating previous device drivers.

**Updating device drivers after installing Linux:** Before proceeding, you must already have installed Red Hat 6.1 Linux distribution on your server. This set of instructions assumes the following:

- You already have a Red Hat 6.1 Linux operating system installed.

- You want to add a ServeRAID controller to your server.

*Updating device drivers from CD-ROM:* To update device drivers from CD-ROM after installing Linux, do the following:

1. Insert the *IBM ServeRAID Support* CD into the CD-ROM drive.

2. Type:

```
mount -t iso9660 /dev/cdromdevicefile /mnt
```

where *cdromdevicefile* is the specific device file for the CD-ROM block device. Typically this is */dev/cdrom*.

3. To unpack the device driver, type:

```
tar -zxvf /mnt/programs/linux/driver/ips-400.tgz -C /tmp
```

4. To apply the patch, type:

```
cd /usr/src
patch -p0 < /tmp/kernel-2.2.13-4.00-patch
```

5. Unmount the CD-ROM:

```
umount /mnt
```

6. Reconfigure and recompile your kernel.

**Note:** See the Linux Kernel-HOWTO for more information on configuring and recompiling your kernel.

*Updating device drivers from diskette:* To update device drivers from diskette after installing Linux, do the following:

1. Insert the *IBM ServeRAID Device Drivers* diskette into the diskette drive.

2. Type:

```
mount -t msdos -o conv=auto /dev/diskettedevicefile /mnt
```

where *diskettedevicefile* is the specific device file for the diskette block device. Typically this is */dev/fd0*.

3. To unpack the device driver, type:

```
tar -zxvf /mnt/linux/ips-400.tgz -C /tmp
```

4. To apply the patch, type:

```
cd /usr/src
patch -p0 < /tmp/kernel-2.2.13-4.00-patch
```

5. Unmount the diskette drive:

```
umount /mnt
```

6. Reconfigure and recompile your kernel.

**Note:** See the Linux Kernel-HOWTO for more information on configuring and recompiling your kernel.

*Updating device drivers from the World Wide Web:* To update device drivers downloaded from the World Wide Web after installing Linux, do the following:

1. Download the file *ips-400.tgz* that is available from the IBM Developer Web site at the following address:

<http://www.developer.ibm.com/welcome/netfinity/serveraid.html>

2. To unpack the device driver, type:

```
tar -zxvf ips-400.tgz -C /tmp
```

3. To apply the patch, type:

```
cd /usr/src
patch -p0 < /tmp/kernel-2.2.13-4.00-patch
```

4. Reconfigure and recompile your kernel.

**Note:** See the Linux Kernel-HOWTO for more information on configuring and recompiling your kernel.

### Installing device drivers after installing OS/2

You can use the following instructions to install the ServeRAID device driver files after installing OS/2 Warp Server.

To install the ServeRAID files after installing OS/2:

1. After you complete the OS/2 installation, insert the *IBM ServeRAID Device Drivers* diskette.
2. From an OS/2 window, type:

*a*:

where *a* is the letter for the diskette drive that contains the ServeRAID diskette.

3. Press Enter; then, type:

```
ddinstal
```

4. Press Enter. The OS/2 Device Driver Installation window opens and prompts you for the source and destination drives. The source directory shows where to insert the *IBM ServeRAID Device Drivers* diskette. The destination directory shows where the program will copy the device driver files.
5. Click **Install**.
  - The program copies the following ServeRAID device driver statement to your CONFIG.SYS file: BASEDEV=IPSRAID.ADD
  - The program copies the IPSRAID.ADD ServeRAID device driver to the OS/2 subdirectory on your hard disk.
6. Edit the CONFIG.SYS file and verify that there is only one copy of the line BASEDEV=IPSRAID.ADD.

#### Notes:

- a. If you have more than one ServeRAID or SCSI adapter in your server, make sure that the BASEDEV statement for the adapter or controller controlling the startup (boot) device appears first in the CONFIG.SYS file before the BASEDEV statements for other ServeRAID or SCSI adapters.
  - b. After you install any service packs, check the path for the IPSRAID.ADD device driver and verify that the correct device driver is installed.
7. Restart the server.

**Note:** When booting OS/2 after installing the new ServeRAID device driver, you might receive the following messages:

```
* Initializing Raid SCSI Subsystem.
* Unable to allocate IRQ resources.
* RMCreat Device Adapter failure.
* RMCreat Device (disk) failure.
* RMCreat Device (disk) failure.
* RMCreat Device (disk) failure.
* RMCreat Device (disk) failure.
```

If you receive these messages, install an updated RESOURCE.SYS file that is available from the OS/2 Device Driver Pak *On-Line* Web site at the following address:

<http://service.software.ibm.com/os2ddpak/index.htm>

At this Web site, follow these steps to obtain the updated RESOURCE.SYS file:

- Scroll down to the bottom and click **Yes, I agree. Show the Device Category list.**
- Scroll down and click **OS/2 Component Updates** from the list.
- Click **OS/2 Base Device Driver Updates.**
- Click **RESOURCE.SYS update; pre-requisite for updated IBM RAID Driver.**
- Follow the instructions at the Web site for installing the RESOURCE.SYS update after you have installed OS/2.

### **Adding IPSRAID BTLD after installing OpenServer**

1. Start the server in system maintenance mode, and log in as ROOT.
2. Type:  
`installpkg`
3. Press Enter; then, select the diskette drive in which you will insert your installation diskette.
4. When prompted, insert the *IBM ServeRAID Device Drivers for SCO Operating Systems - UnixWare HBA and OpenServer BTLD* diskette.
5. When prompted for the name of the package, type:  
`ipsraid`
6. Press Enter; then, relink the kernel (as described in “Relinking the kernel” in the *SCO OpenServer Handbook*) by typing the following command:  
`cd /etc/conf/cf.d`
7. Press Enter; then type:  
`./link_unix`
8. Press Enter.
9. After the kernel rebuilds, the following message appears:  
The UNIX kernel has been rebuilt.  
Do you want this kernel to boot by default?  
To continue, type y  
The system backs up the old kernel by moving /unix to /unix.old.
10. When the system asks for the kernel environment to be rebuilt, type y  
The system will respond with a message.
11. Remove the *IBM ServeRAID Device Drivers for SCO Operating Systems - UnixWare HBA and OpenServer BTLD* diskette from the diskette drive.
12. Shut down the server; then, restart the server.

### **Installing device drivers after installing UnixWare**

Use the following instructions to install the ServeRAID files after you install UnixWare, or use these instructions to update a previously installed ServeRAID file with a newer version. You can use the UnixWare Pkgadd or the UnixWare SCOAdmin utility program to install the files.

#### ***Installing an HBA diskette file using Pkgadd:***

1. Insert the *IBM ServeRAID Device Drivers for SCO Operating Systems - UnixWare HBA and OpenServer BTLD* diskette into the diskette drive.
2. Type:

```
pkgadd -d /dev/dsk/f0t
```

3. Press Enter.
4. When the message Insert diskette into Floppy Drive 1 appears, press Enter.
5. When the message Installation of IBM ServeRAID SCSI IHV HBA (ips) was successful appears, type:  
q
6. Press Enter.
7. After the device driver is installed, shut down and restart the server.

***Installing an HBA diskette file using SCOAdmin:***

1. Insert the *IBM ServeRAID Device Drivers for SCO Operating Systems - UnixWare HBA and OpenServer BTL D* diskette into the diskette drive.
2. Start the SCOAdmin utility program by typing SCOADMIN at the system prompt.
3. Click **Software\_Management**.
4. Click **Application Installer**.
5. Click the **Install From** tab.
6. Click **Disk\_A**.
7. Click **Update View** if nothing appears in the window.
8. When the icon labeled **ips** appears in the window, click **Install**.
9. After the device driver is installed, remove the diskette from the diskette drive; then, shut down and restart the server.

---

## **Step 5: Installing the ServeRAID Manager program and other utilities**

The ServeRAID Manager program provides a graphical interface that you can use to monitor ServeRAID configuration changes being performed on your server while your server is fully operational. You can create an array, delete an array, create a logical drive, change the RAID level, dynamically increase the logical drive size, rebuild an array, configure your ServeRAID controllers in a failover environment, configure a cluster, and perform other ServeRAID configuration functions.

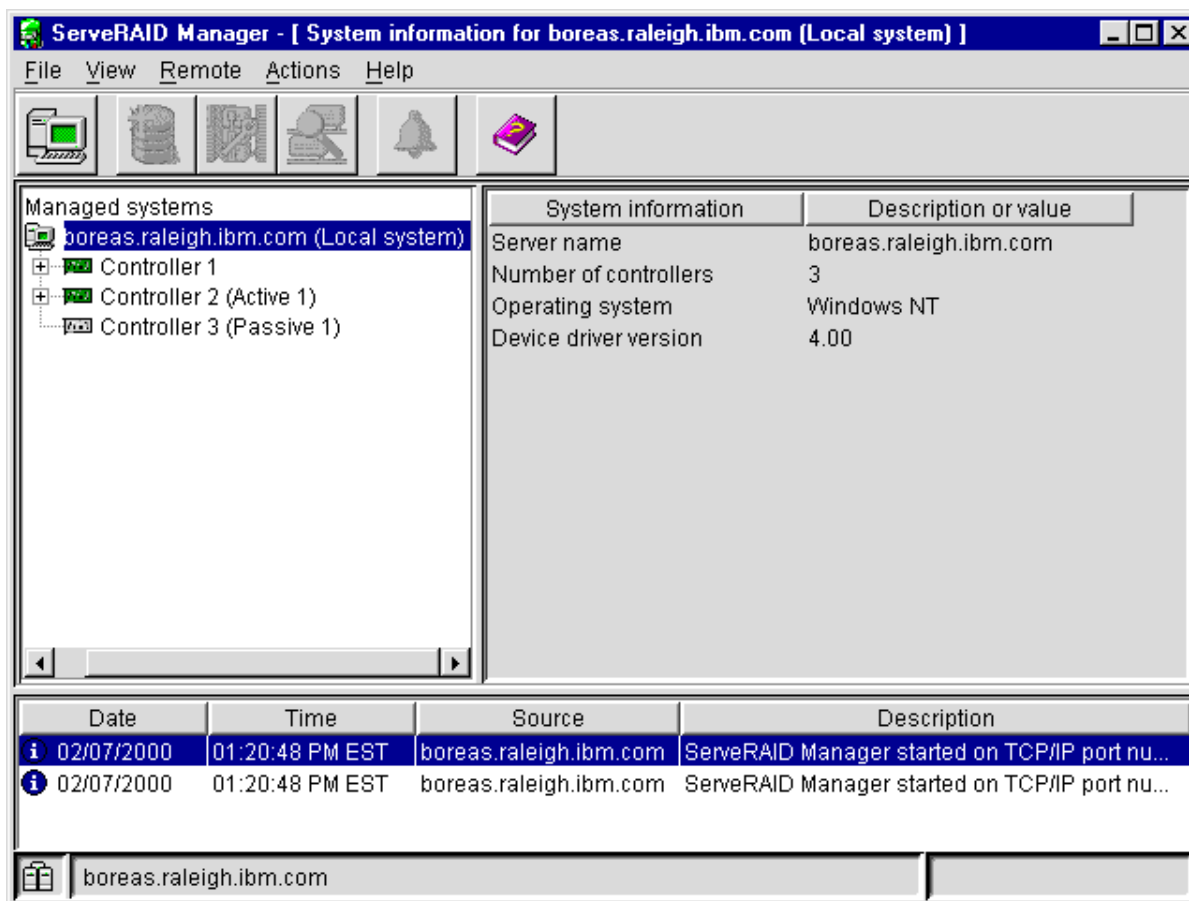

Figure 13. ServeRAID Manager installed on a server

## Installing the ServeRAID Manager program

This section provides instructions for installing the ServeRAID Manager program.

When using:	Go to:
Windows 2000	"Installing on Windows 2000, Windows NT 4.0, Windows 98, or Windows 95" on page 50.
Windows NT 4.0	"Installing on Windows 2000, Windows NT 4.0, Windows 98, or Windows 95" on page 50.
Windows 98	"Installing on Windows 2000, Windows NT 4.0, Windows 98, or Windows 95" on page 50.
Windows 95	"Installing on Windows 2000, Windows NT 4.0, Windows 98, or Windows 95" on page 50.
NetWare	"Installing on NetWare" on page 50.
Linux	"Installing on Red Hat Linux 6.1 (or later)" on page 51.
OS/2	"Installing on OS/2" on page 51.
OpenServer	"Installing on OpenServer" on page 52.
UnixWare	"Installing on UnixWare" on page 52.

To use the ServeRAID Manager program, see the ServeRAID Manager online help.

## Installing on Windows 2000, Windows NT 4.0, Windows 98, or Windows 95

**Note:** This version of the ServeRAID Manager program supports up to 12 ServeRAID controllers when using Microsoft NT 4.0 or Windows 2000.

To install the ServeRAID Manager program for Windows NT 4.0 or Windows 2000, do the following:

1. Insert the *IBM ServeRAID Support* CD into the CD-ROM drive.
2. The installation program starts. Follow the instructions on the screen to install the program.

**Note:** If you are installing on an IBM Netfinity server that supports Hot-plug PCI under Windows NT 4.0, select the IBM ServeRAID Hot Replace Wizard to enable the hot-replace operation.

## Installing on NetWare

### Notes:

1. To install the NetWare version of the ServeRAID Manager program, you must install from a Microsoft Windows client that is connected to the NetWare system.
2. ServeRAID does not support NetWare versions older than 4.2.
3. ServeRAID Manager supports only NetWare 5.x and later. Use the command line utilities IPSEND and IPSPMON for NetWare 4.x.
4. This version of the ServeRAID Manager program supports up to 8 ServeRAID controllers when using NetWare.

### Important

To install the ServeRAID Manager program, you must have a network drive mapped to the root directory of the SYS partition.

Before you install the ServeRAID Manager program, be sure you have the following installed on your NetWare 5.x system:

- Install the latest Support Pack before installing the Novell JVM for NetWare. Download the latest Support Pack from the following address:  
<http://support.novell.com/misc/patlst.htm#nw>
- Use the Novell Java Virtual Machine version 1.1.7 or later. Versions older than 1.1.7 are not compatible with the ServeRAID Manager program. To check your JVM version, load Java and type at the NetWare command prompt:  
JAVA -VERSION

Download the latest JVM from the following address:

<http://developer.novell.com/ndk/download.htm>

To install the ServeRAID Manager program for Novell NetWare, do the following:

1. On a Microsoft Windows client that is connected to the NetWare system, map a network drive to the root directory of your NetWare SYS partition.
2. Insert the *IBM ServeRAID Support* CD into the CD-ROM drive of the Windows client. The installation program starts.
3. When prompted, choose the NetWare 5.x operating system.
4. When prompted for the installation directory, provide only the drive letter to the NetWare SYS partition that you mapped in step 3.



5. Follow the instructions on the screen to install the program.

## Installing on Red Hat Linux 6.1 (or later)

### Notes:

1. The ServeRAID Manager program comes with the IBM Java Runtime Environment (JRE).
2. This version of the ServeRAID Manager program supports up to 8 ServeRAID controllers when using Linux.

To install the ServeRAID Manager program for Red Hat Linux 6.1 (or later), do the following.

1. Insert the *IBM ServeRAID Support* CD into the CD-ROM drive.
2. Some operating systems will automount the CD. For those that do not, type:

```
mount -r /dev/cdromdevicefile /mountpoint
```

where *mountpoint* is the mount point to use (typically /mnt), and *cdromdevicefile* is the specific device file for the CD-ROM block device (typically /dev/cdrom).

3. Press Enter; then, type:

```
rpm --install /mnt/programs/linux/manager/RaidMan-4.00-1.386.rpm
```

where *mnt* is the mount point of the device file used in step 2.

4. Press Enter.
5. When the installation is complete, type:

```
umount /mnt
```

where *mnt* is the mount point of the device file used in step 2.

**Note:** For operating systems that automount the CD, you must first close the window displaying the files on the CD.

6. Press Enter. You can now remove the CD from the CD-ROM drive.

## Installing on OS/2

**Note:** This version of the ServeRAID Manager program supports up to 8 ServeRAID controllers when using OS/2.

To install the ServeRAID Manager program for OS/2, do the following:

1. Insert the *IBM ServeRAID Support* CD into the CD-ROM drive.
2. Open an OS/2 command window.
3. Type the following:

```
d:
```

where *d* is the CD-ROM drive letter.

4. Press Enter; then, type:  

```
cd \programs\os2\manager
```
5. Press Enter; then, type:  

```
install
```
6. Press Enter.

7. The installation program starts. Follow the instructions on the screen to install the program. On the final installation panel, be sure to specify the location where you want to install the ServeRAID Manager program.

## Installing on OpenServer

**Note:** This version of the ServeRAID Manager program supports up to 8 ServeRAID controllers when using OpenServer.

To install or remove the ServeRAID Manager package, you *must* have root privileges.

**Note:** If ServeRAID Manager is installed on your system, you must remove this version before upgrading. All customization files (such as Managed system tree nodes, Notification list) are saved and used in the upgrade.

To remove the ServeRAID Manager program from OpenServer, type the following command:

```
pkgrm RaidMan
```

To install the ServeRAID Manager program for OpenServer, do the following.

**Note:** The ServeRAID Manager requires that you install the SCO OpenServer JDK (or JRE). You can download the JDK and JRE from the SCO Web site:

<http://www.sco.com/java/>

1. Insert the *IBM ServeRAID Support* CD into the CD-ROM drive.
2. Mount the CD-ROM by typing:

```
cd /
```

Then, press Enter.

```
mkdir cdrom
```

Then, press Enter.

```
mount -r -f HS,lower /dev/cd0 /cdrom
```

Then, press Enter.

3. Then, type (all on the same line):

```
pkgadd -a /cdrom/programs/openserv/manager/RaidMan.adm -d  
/cdrom/programs/openserv/manager/RaidMan.ds
```

4. Press Enter.
5. When the installation is complete, type:

```
umount /cdrom
```

6. Press Enter. You can now remove the CD from the CD-ROM drive.

## Installing on UnixWare

### Notes:

1. To use the ServeRAID Manager program with UnixWare, you must have either the Java Runtime Environment (JRE) or the Java Development Kit (JDK) installed on your server.
2. To install or remove the ServeRAID Manager package you must have root privileges.
3. If the ServeRAID Manager program is already installed on your server, you must remove this version before upgrading. All customization files (such as Managed system tree nodes, Notification list) are saved and used in the upgrade. To remove the ServeRAID Manager program from UnixWare, type the following command:

```
pkgm RaidMan
```

4. This version of the ServeRAID Manager program supports up to 8 ServeRAID controllers when using UnixWare.

To install the ServeRAID Manager program for UnixWare, do the following:

1. Insert the *IBM ServeRAID Support* CD into the CD-ROM drive.
2. Type the following:

```
mount -r -F cdfs /dev/cdrom/cdromdevicefile /mnt
```

where *cdromdevicefile* is the specific device file for the CD-ROM block device. Look in the */dev/cdrom* directory to determine what *cdromdevicefile* is on your server, for example, *c0b0t010*.

3. Press Enter; then type:

```
pkgadd -d /mnt/programs/unixware/manager/RaidMan.ds
```

4. Press Enter.

5. When the installation is complete, type:

```
umount /mnt
```

6. Press Enter. You can now remove the CD from the CD-ROM drive.

## Installing the IPSSSEND and IPSMON command-line programs

IPSSSEND and IPSMON are advanced command-line programs that you can use to manage your ServeRAID controllers. These utility programs are provided on the *IBM ServeRAID Command-Line Programs* diskette and the *IBM ServeRAID Support* CD.

**Note:** IPSSSEND for OS/2 is on the *IBM ServeRAID Support* CD only.

You can use the IPSSSEND program to view the configuration of a ServeRAID controller, initialize logical drives, synchronize logical drives. For Windows NT and Windows 2000 you can also use FlashCopy and configuration cloning for server roll out.

You can use the IPSSSEND program with the following operating systems:

- Microsoft Windows NT
- Microsoft Windows 2000
- Novell NetWare 4.x and 5.x
- IBM OS/2 Warp Server
- Red Hat Linux 6.1 or later
- SCO OpenServer 5.0.5
- SCO UnixWare 7.1 or later.

You can use the IPSMON program with Novell NetWare 4.x and 5.x. You can use the IPSMON program to monitor a ServeRAID controller for defunct drives, Predictive Failure Analysis<sup>®</sup> (PFA) warnings, Rebuild operations, FlashCopy operations, synchronizations, logical-drive migrations, and RAID level-5E compressions. This program can log a message to the monitor, to a file, or to both the monitor and a file whenever activities occur.

**Note:** Refer to “Using the IPSSSEND command-line program” on page 110 for information about using the IPSSSEND program.

## Installing IPSSSEND for Windows 2000, Windows NT 4.0, NetWare, or OS/2

To install these programs for Windows NT, Windows 2000, NetWare, or OS/2:

1. Start the server.
2. After the operating system starts, insert the *IBM ServeRAID Support* CD into the CD-ROM drive.
3. If you are using NetWare, go to step 5. If you are using Windows NT, Windows 2000 or OS/2, create an IPSADM directory on your hard disk. To do this, go to the operating system command prompt and type:

```
md c:\ipsadm
```

where *c* is the drive letter of the drive where Windows NT, Windows 2000, or OS/2 is installed.

4. Press Enter.
5. Copy the IPSSSEND.EXE file to your hard disk drive by typing one of the following at the command prompt:

- For Windows NT, type:

```
copy z:\programs\winnt\cmdline\nt4_0\ipssend.exe c:\ipsadm
```

- For Windows 2000, type:

```
copy z:\programs\winnt\cmdline\win2k\ipssend.exe c:\ipsadm
```

- For NetWare, from a DOS prompt type:

```
copy z:\programs\netware\cmdline\ipssend.nlm c:\nwserver
```

- For OS/2, type:

```
copy z:\programs\os2\cmdline\ipssend.exe c:\ipsadm
```

### Notes:

- a. Where *z* is the drive letter for the CD-ROM drive that contains the *IBM ServeRAID Support* CD and *c* is the drive letter where Windows NT, Windows 2000, NetWare, or OS/2 is installed.
  - b. These instructions assume that you installed NetWare in the NWSERVER directory.
6. Press Enter. Remove the CD from the CD-ROM drive.

## Installing IPSSSEND for Linux

To install these programs for Red Hat Linux 6.1 (or later):

1. Start the server.
2. After the operating system starts, insert the *IBM ServeRAID Support* CD into the CD-ROM drive.
3. Mount the CD by typing the following at the console:

```
mount -t iso9660 -o ro /dev/cd0 /mnt
```

### Notes:

- a. where */dev/cd0* is the specific device file for the CD-ROM block device. If you have more than one CD-ROM, you must replace */dev/cd0* with the specific name of the CD-ROM you want to use.
  - b. If you currently have another device mounted on */mnt*, you must create a new directory and substitute its name for */mnt* in these instructions.
4. Press Enter; then, type:

```
cp /mnt/programs/linux/cmdline/ipssend /usr/bin
```
  5. Press Enter; then, type:

```
chmod 700 /usr/bin/ipssend
```

6. Press Enter; then, unmount the CD-ROM by typing the following:  
`umount /mnt`
7. Press Enter. Remove the CD from the CD-ROM drive.

### Installing IPSSSEND for OpenServer

To install these programs for OpenServer 5.0.5:

1. Start the server.
2. After the operating system starts, insert the *IBM ServeRAID Support* CD into the CD-ROM drive.
3. Mount the CD by typing the following at the console:  
`mount -f IS09660 -o ro,lower /dev/cd0 /mnt`

#### Notes:

- a. where `/dev/cd0` is the specific device file for the CD-ROM block device. If you have more than one CD-ROM, you must replace `/dev/cd0` with the specific name of the CD-ROM you want to use.
  - b. If you currently have another device mounted on `/mnt`, you must create a new directory and substitute its name for `/mnt` in these instructions.
4. Press Enter; then, type:  
`cp /mnt/programs/openserv/cmdline/ipssend /usr/bin`
  5. Press Enter; then, type:  
`chmod 700 /usr/bin/ipssend`
  6. Press Enter; then, unmount the CD-ROM by typing the following:  
`umount /mnt`
  7. Press Enter. Remove the CD from the CD-ROM drive.

### Installing IPSSSEND for UnixWare

To install these programs for UnixWare 7.1:

1. Start the server.
2. After the operating system starts, insert the *IBM ServeRAID Support* CD into the CD-ROM drive.
3. Mount the CD by typing the following at the console:  
`mount -F cdfs -r /dev/cdrom/cdromdevicefile /mnt`

#### Notes:

- a. where `cdromdevicefile` is the specific device file for the CD-ROM block device. Look in the `/dev/cdrom` directory to determine what `cdromdevicefile` is on your server, for example, `c0b0t010`.
  - b. If you currently have another device mounted on `/mnt`, you must create a new directory and substitute its name for `/mnt` in these instructions.
4. Press Enter; then, type:  
`cp /mnt/programs/unixware/cmdline/ipssend /usr/bin`
  5. Press Enter; then, type:  
`chmod 700 /usr/bin/ipssend`
  6. Press Enter; then, unmount the CD-ROM by typing the following:  
`umount /mnt`
  7. Press Enter. Remove the CD from the CD-ROM drive.

## Installing IPSMON for NetWare

To install the IPSMON program for NetWare:

1. Start the server.
2. After the operating system starts, insert the *IBM ServeRAID Support* CD into the CD-ROM drive.
3. Copy the IPSMON.EXE file to your hard disk drive by typing on the DOS command prompt:

```
copy z:\programs\netware\cmdline\ipsmon.nlm c:\nwserver
```

where *z* is the drive letter for the CD-ROM drive and *c* is the drive letter of the drive where NetWare is installed.

**Note:** These instructions assume that you installed NetWare in the NWSERVER directory.

4. Press Enter. Remove the CD from the CD-ROM drive.

---

## Step 6: Starting the ServeRAID Manager program

After you have configured your ServeRAID controller, installed the device drivers, installed the operating system, and installed the ServeRAID Manager program on your system, you can administer and monitor your ServeRAID controllers, as well as modify the ServeRAID controller configuration.

### Starting the ServeRAID Manager program in Windows 2000 and Windows NT

To start the ServeRAID Manager program in Windows NT and Windows 2000:

1. Click **Start** in the lower-left corner of the screen.
2. Click **Programs** → **ServeRAID Manager** → **ServeRAID Manager**. The Control panel window opens. The program starts in Information mode and a window similar to the following opens.

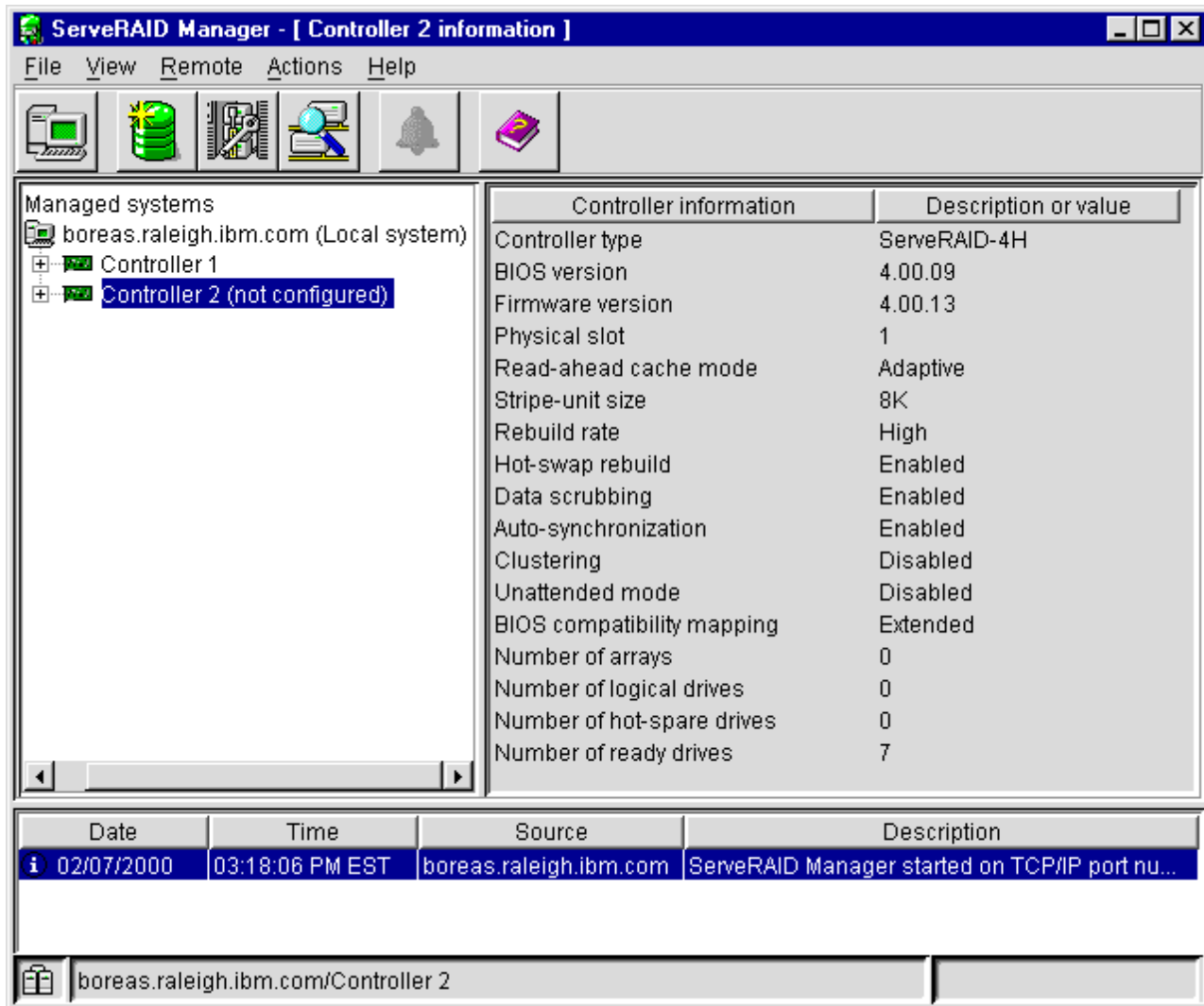

Figure 14. Information mode window

## Starting the ServeRAID Manager program in NetWare

To start the ServeRAID Manager program in NetWare:

1. From the NetWare console, type:  
LOAD RAIDMAN
2. Press Enter.

The program starts in Information mode and a window similar to the previous window opens.

## Starting the ServeRAID Manager program in OS/2

To start the ServeRAID Manager program in OS/2:

1. Change to the directory where you installed the ServeRAID Manager program by typing the following:  
cd \RaidMan
2. Press Enter.

3. Type the following:

```
RaidMan
```

4. Press Enter.

The program starts in Information mode and a window similar to the previous window opens.

## Starting the ServeRAID Manager program in OpenServer, UnixWare, and Linux

Use these procedures to start the ServeRAID Manager program in OpenServer, UnixWare, and Linux. You can start the ServeRAID Manager program either as a graphical user interface or as an agent.

### Notes:

1. Because these programs share the TCP/IP port number, do *not* start the ServeRAID Manager graphical user interface and ServeRAID Manager agent at the same time.
2. Ensure that you have superuser privileges before starting these procedures.

### Starting the ServeRAID Manager graphical user interface

The ServeRAID Manager graphical user interface starts an easy-to-use interface for managing and configuring ServeRAID controllers. Use the ServeRAID Manager graphical user interface to configure and setup the ServeRAID Manager Notification list and Security list. To start the ServeRAID Manager graphical user interface:

1. Change to the directory where you installed the ServeRAID Manager program by typing:

<b>For Openserver</b>	<code>cd /opt/RaidMan</code>
<b>For UnixWare</b>	<code>cd /opt/RaidMan</code>
<b>For Linux</b>	<code>cd /usr/RaidMan</code>

2. Press Enter.
3. Type the following:

```
sh RaidMan.sh
```
4. Press Enter.

The program starts in Information mode and a window similar to the previous window opens.

### Starting the ServeRAID Manager agent

The ServeRAID Manager agent is a monitoring agent for ServeRAID controllers that uses less memory than the ServeRAID Manager graphical user interface. None of the managing actions or the configuration actions are available.

**Note:** If the system administrator chose during installation to start the agent as a background service, the agent is already running. To determine if the agent is running, type:

```
ps -aef | grep RaidAgnt | grep -v grep
```

If you receive output from this command, the agent is running.

To start the ServeRAID Manager agent:

1. Change to the directory where you installed the ServeRAID Manager program by typing:



- ```
cd /opt/RaidMan
```
2. Press Enter.
  3. Type the following:  

```
sh RaidAgnr.sh
```
  4. Press Enter.



---

## Chapter 3. Configuring two ServeRAID controllers in a failover environment (Windows NT 4.0 and Windows 2000 only)

You can configure two ServeRAID controllers in a failover environment when using Windows NT 4.0 or Windows 2000. The latest version of the ServeRAID device drivers includes *fault tolerant* technology. With fault tolerance, you can pair two controllers and connect them to the same enclosure in order to provide access to the disk, even after a controller fails.

---

### Hardware requirements

**Important**

To perform fault tolerance, you must use only matched pairs of controllers. The controllers must be identical, including the level of BIOS and firmware on the controllers.

You can use the following pairs for fault tolerance:

- Two ServeRAID-4H
- Two ServeRAID-3HB
- Two ServeRAID-3H
- Two ServeRAID-3L
- Two ServeRAID-II

**Note:** If your system has a ServeRAID controller built-in on the system board, you cannot use the built-in controller in the fault-tolerant pair.

In order to perform fault tolerance with ServeRAID controllers, you must use one of the following enclosures:

- IBM PC Server Enterprise Expansion Enclosure (3518), using IBM SCSI-2 Fast/Wide Enhanced Repeater Adapter
- IBM Netfinity Rack Drawer Enclosure (3519), using IBM SCSI-2 Fast/ Wide Enhanced Repeater Adapter
- IBM Netfinity EXP10 Rack Storage Enclosure, using Netfinity EXP10 3m External Auto-Sensing Cable
- IBM Netfinity EXP15 Rack Enclosure
- IBM Netfinity EXP200 Rack Enclosure.

---

### Installation guidelines and restrictions

**Important**

If any of the following restrictions and guidelines are not met, failover is disabled for the controller pair and an error explaining the problem is logged in the system event log. To verify that the configuration is OK, start the ServeRAID Manager program on the Windows NT or Windows 2000 server. The Main Tree of the ServeRAID Manager displays controller pairs that are configured for failover correctly.

In order to perform fault tolerance with ServeRAID, you must adhere to the following guidelines and restrictions.

- The stripe-unit size and firmware level must be the same on both controllers.
- A fault-tolerant pair cannot be part of a Microsoft Cluster Service shared cluster.
- All logical drives on the controller must be configured as write through.

**Note:** If you have the battery backup option, it will be disabled when you create a fault-tolerant pair. The write-cache mode will automatically be changed from write-back mode to write-through mode.

- The controllers must be configured in an active-passive mode, where all logical drives are defined on only one controller of the pair.

**Note:** If both controllers have logical drives configured, the controllers will not be configured as a fault-tolerant pair.

- Do not create hot-spare drives when creating a fault-tolerant pair. Hot-spare drives are not supported in a failover environment except within a logical drive with a RAID level-5E.
- A fault-tolerant pair must not contain any ready physical drives. All physical drives must be configured in arrays.
- All logical drives must have unique shared merge-group numbers.
- When using multiple fault-tolerant pairs in a system, each set of controllers must have a unique set of controller names and partner names.
- You cannot hot-add a backup controller to a system.
- You cannot disable an on-board ServeRAID controller, even if the controller is not used.

---

## Preparing the controllers

**Note:** The cables to the drives *must not* be attached when you start the server.

1. Insert the *IBM ServeRAID Support CD* (or the configuration CD that was included with your server) into the CD-ROM drive; then, turn on the server. The ServeRAID Manager program starts.

**Note:** If the ServeRAID Manager program opens in Configuration mode, a window similar to the following opens. Click **Cancel** to go to Information mode and continue to the next step.

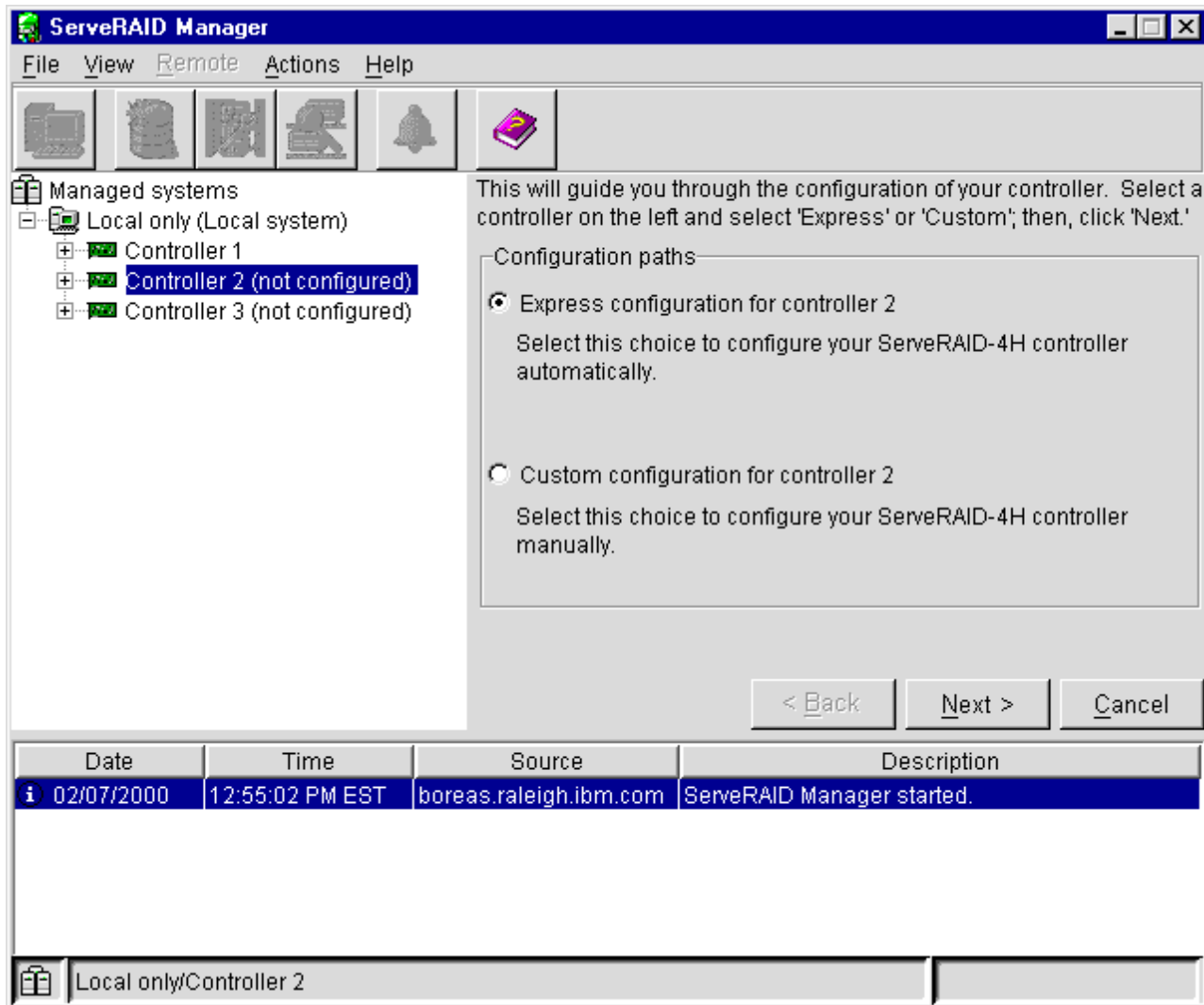

Figure 15. Configuration mode window

2. In the Main Tree, click the first ServeRAID controller that you want to configure.

**Important**

The ServeRAID controller should be initialized only one time, when the controller is first installed. Initializing the controller removes all configuration information from NVRAM. This information includes the SCSI IDs, the Controller host ID and the Cluster partner host ID, and the array information. This point is especially important if the Windows NT or Windows 2000 system startup drive is attached to the IBM ServeRAID controller. If the initialization occurs after the startup drive array has been created, the array information will be removed and the system will no longer start in Windows NT or Windows 2000.

If you already have logical drives defined that you want to keep, go to step 6 on page 64. The steps before step 6 on page 64 will cause loss of data by deleting all logical drives already defined.

3. Click **Actions** → **Restore to factory default settings**.
4. If a confirmation window opens, click **Yes**. When the operation is complete, a message displays at the bottom of the window indicating the restore to factory default settings was successful.

5. Repeat step 2 on page 63 through step 4 on page 63 for the second ServeRAID controller.
6. In the Main Tree, click the first ServeRAID controller that you want to configure.
7. Click  on the tool bar. The Configure controller for clustering window opens.

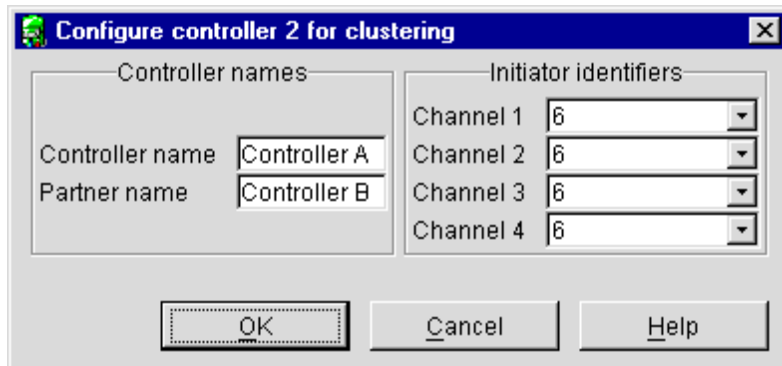

Figure 16. Configure controller for clustering window

8. Fill in the following information.

**Notes:**

- a. The controller name and partner name are case sensitive.
- b. If your configuration will contain multiple ServeRAID controllers pairs, each controller name must be unique.

**Controller name**

Enter a name to identify the first controller, for example, Controller A.

**Partner name**

Enter a name that you will use to identify the second controller, for example, Controller B.

**SCSI initiator IDs**

The system presets these IDs to 7. Set each ID to 6 for shared channels.

**Note:** The ServeRAID Manager program does not permit you to enter numbers other than 6 and 7.

9. Click **OK**.
10. In the Main Tree, click the second ServeRAID controller that you want to configure.
11. Click  on the tool bar. The Configure controller for clustering window opens.

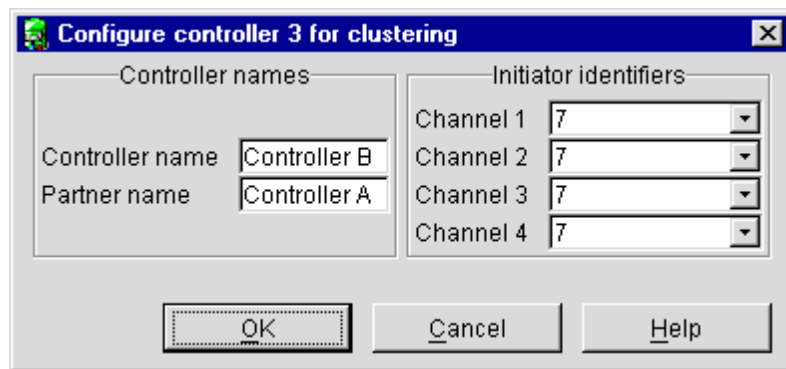

Figure 17. Configure controller for clustering window

12. Fill in the following information.

**Notes:**

- a. The controller name and partner name are case sensitive.
- b. If your configuration will contain multiple ServeRAID controllers pairs, each controller name must be unique.

**Controller name**

This is the same name as the partner name in step 8 on page 64. For example, Controller B.

**Partner name**

This is the same name as the controller name in step 8 on page 64. For example, Controller A.

**SCSI initiator IDs**

The system presets these IDs to 7. When configuring the second controller, do *not* change these values.

**Note:** The ServeRAID Manager program does not permit you to enter numbers other than 6 and 7.

13. Click **OK**.

---

## Connecting the expansion enclosures

After you configure the controllers, you must connect the expansion enclosures to the ServeRAID controllers.

1. Connect the expansion enclosure to each of the ServeRAID controllers.

**Important**

When connecting the cables, you must connect the same channel connectors on both ServeRAID controllers to the same expansion enclosure. For example, if you connect the cable from Channel 1 on the first ServeRAID controller to the first expansion enclosure, then you must connect the cable from Channel 1 on the second ServeRAID controller to the first expansion enclosure.

2. Restart the server with the *IBM ServeRAID Support CD* (or the configuration CD that came with your server) in the CD-ROM drive.

---

## Configuring ServeRAID arrays and logical drives

To configure arrays and a logical drive, do the following.

**Note:** You can create only one logical drive for each array in a failover environment.

1.



Click  on the tool bar. The Configuration mode window opens (see Figure 15 on page 63).

2. In the Main Tree, click the first ServeRAID controller that you want to configure.
3. Click the **Custom configuration** radio button.
4. Click **Next**. The Create arrays window opens.
5. Using the right mouse button, click the ready drive or SCSI channel icons in the Main Tree to select the drives that you want to add to your arrays or delete from your arrays; then, select a choice from the pop-up list.

**Notes:**

- a. You must use all the ready drives when creating your arrays (that is, all ready drives in the Main Tree must be online).
  - b. Hot-spare drives are not supported in a failover environment except within a logical drive with a RAID level-5E.
6. After you select the ready drives for your arrays, click **Next**. The Create logical drives window opens.

**Note:** If you change your mind, you can remove a specific drive from a newly defined array or delete an entire newly defined array. To do this:

- a. Click **Back**.
  - b. Using the right mouse button, click the specific drive or Array icon in the Main Panel on the right.
  - c. Click **Remove from new array** or **Delete new array**.
7. Select a RAID level for each of the logical drives from the RAID pull-down menu in the Main Panel.

**Note:** If you have four or more ready drives in an array, the recommended RAID level is RAID level-5E.

8. Create only one logical drive for each array.

**Note:** Typically, the first logical drive defined on the first ServeRAID controller found by system BIOS during startup will be your startup (boot) drive.

9. If you have created multiple arrays in step 5 on page 66, click on another array in the Main Tree and go back to step 7 on page 66 to configure it. After configuring all of your arrays, continue with step 10 on page 66.
10. Click **Next**. The Configuration summary window opens.
11. Review the information that displays on the Configuration summary window. Click **Apply** to accept and save the configuration.

**Note:** To change the configuration, click **Modify arrays** or **Modify logical drives**.



12. Click **Yes** to continue working with your ServeRAID configuration. After creating the arrays and logical drives, you must assign merge group numbers to the shared logical drives.
13. In the Main Tree, click the ServeRAID controller that contains the logical drives.
14. Click  on the tool bar. The Configure controller for clustering window opens.

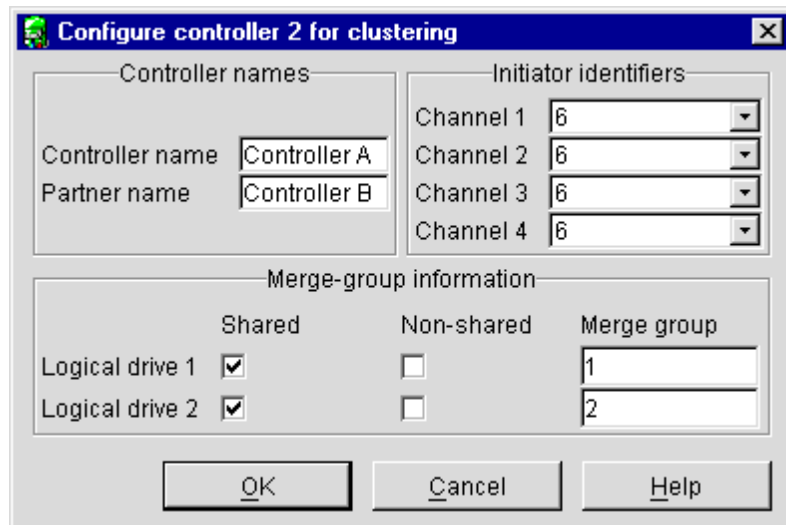

Figure 18. Configure controller for clustering window

15. Click the **Shared** check boxes for all the logical drives.
16. Do *not* change the merge group number from the default provided.
17. Record the controller name, partner name, and merge group numbers and store them in a safe place. You will need this information to recover the configuration if the ServeRAID controller should fail.

**Note:** You can save this information to a file by using the ServeRAID Manager program:

- a. In the Main Tree, click the server.
  - b. Click **Actions** → **Save printable configuration**.
18. Click **OK**.
  19. To exit the ServeRAID Manager program, click **File** → **Exit**.

---

## Completing the failover environment installation

To complete the installation of the failover environment, install the appropriate ServeRAID device drivers while installing Windows NT or Windows 2000. Refer to the following:

- The documentation that came with the Windows NT or Windows 2000 software.
- “Step 4: Installing device drivers” on page 33.

When you start the ServeRAID Manager installed on the server, the ServeRAID Manager Main Tree displays a successful failover controller pairing, similar to the following window.

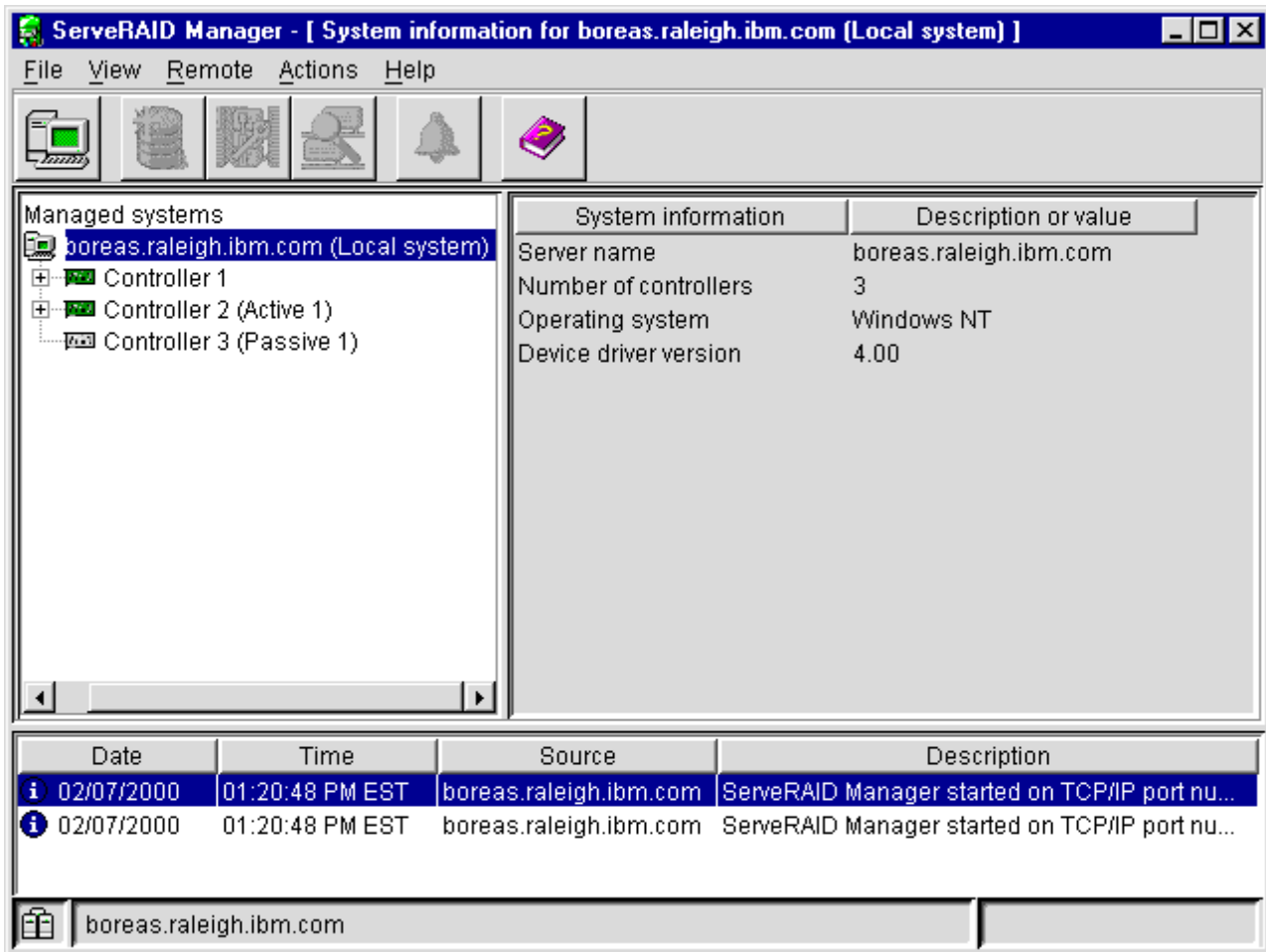

Figure 19. Information mode window showing a failover controller pairing

Before testing your failover environment, allow the auto-synchronization process to complete. If you test failover on a physical drive during the auto-synchronization process, failover succeeds, but the drive is blocked. Then, you must use the ServeRAID Manager to unblock the drive. To verify that auto-synchronization is complete, check the progress indicator that displays in the status bar of the ServeRAID Manager window.

For troubleshooting in a failover environment, refer to “Solving problems in a failover environment” on page 138.

---

## Chapter 4. Introduction to IBM ServeRAID Cluster Solution

A *cluster* is a type of parallel or distributed system that consists of interconnected computers that are used as a single, unified computing resource. In other words, a group of computers linked together in such a way that they share and manage a set of resources that can support a number of users at the same time.

This *high-availability clustering solution* is based on a two-server cluster, where both servers can access the same storage devices, but only one server at a time controls the storage devices shared by both servers. If one of the two running server fails, the surviving server automatically assumes control of the shared resources managed by the failed server while still controlling its own resources at the same time. The failed server can then be repaired offline without the loss of time or work efficiency because the shared data and applications earlier managed by the failed server are still online to the clients.

When the failed server is operational again, it can be placed back into the cluster; the resources are reallocated between the two servers and the cluster resumes normal operations.

A *controller* is a device that coordinates and controls the operation of one or more input and output devices, such as workstations, and synchronizes the operation of such devices with the operation of a system as a whole.

IBM ServeRAID Cluster Solution, as discussed in this book, uses the IBM ServeRAID-4H Ultra160 SCSI controller. IBM ServeRAID Cluster Solution also uses IBM expansion enclosures, such as the following:

- IBM Enterprise Expansion Enclosure (Model 3518)
- IBM PC Server 3519 Rack Expansion Enclosure
- IBM Netfinity EXP15 Rack Expansion Enclosure
- IBM Netfinity EXP10 Rack Expansion Enclosure
- IBM Netfinity EXP200 Rack Expansion Enclosure
- IBM Netfinity EXP300 Rack Expansion Enclosure

You can install IBM ServeRAID Cluster Solution by using one of the following software applications:

- Microsoft Cluster Service, which is part of Windows NT Server Enterprise Edition
- Microsoft Cluster Service using Windows 2000, which is part of Windows 2000 Advanced Server Edition or Windows 2000 Datacenter Server Edition
- Vinca High Availability for Novell IntranetWare, which is part of the IBM Netfinity Cluster Pack by Vinca
- Novell High Availability Server 1.0

The following figures show an example of a simple high-availability clustering solution. The first figure shows a high-level view of a cluster; the second figure shows a more detailed view of a cluster.

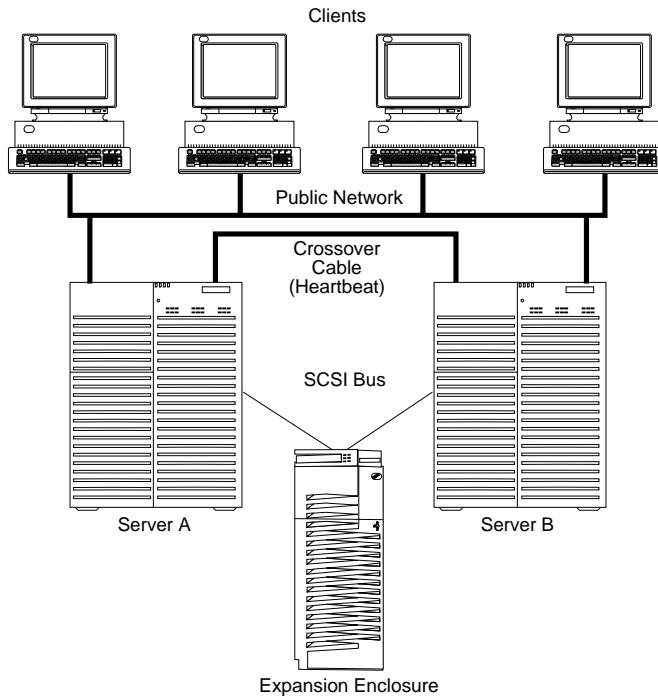

Figure 20. A high-level view of a cluster

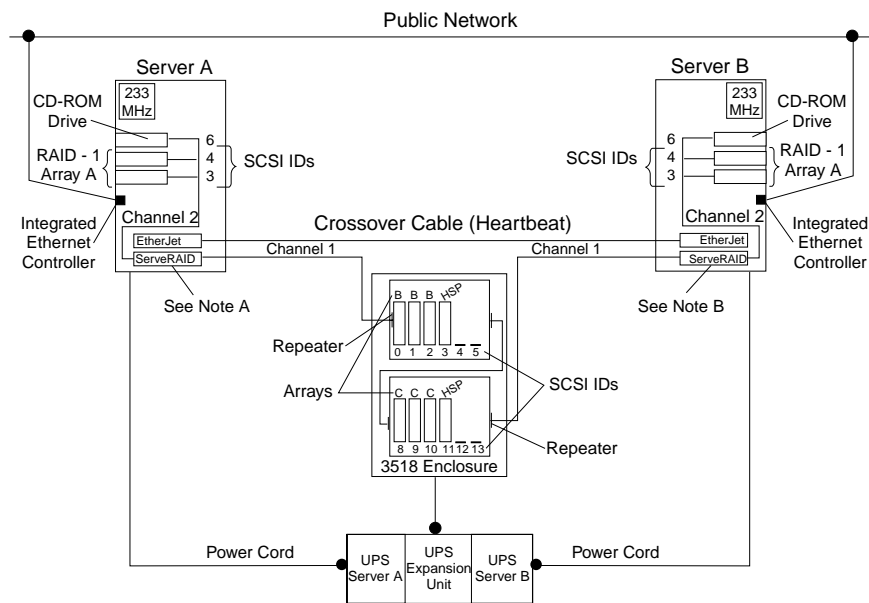

Figure 21. A detailed view of a cluster

**Note A: Server A**

- Shared Channel 1 - SCSI ID 6
- Non-shared Channel 2 - SCSI ID 6
- Non-shared Channel 3 - SCSI ID 7

**Note B: Server B**

- Shared Channel 1 - SCSI ID 7
- Non-shared Channel 2 - SCSI ID 7

The solution you use for your installation depends on your own specific requirements. For more information about requirements and types of installations, refer to the *IBM Shared Disk Clustering Hardware Reference*. You can obtain this publication from the IBM Support Web site. See “Downloadable files from the World Wide Web” on page 14 for additional information.



---

## Chapter 5. Preparing to install or change a cluster solution

**Note:** If you are going to upgrade an existing high-availability cluster solution and are already familiar with the concepts of a cluster, go to “Chapter 6. Updating the ServeRAID BIOS, firmware, and software code” on page 77. If you are setting up your first high-availability cluster solution, continue reading this section.

Before you begin installing and setting up a high-availability cluster solution, it is important to familiarize yourself with the following terms and definitions that are used in this manual, as well as some considerations concerning the ServeRAID controller.

**Note:** The following terms and definitions are for the Microsoft Cluster Service using Windows NT or Windows 2000. For similar terms and definitions for the Novell IntranetWare Cluster Solution using Novell NetWare, refer to the *Vinca High Availability for NetWare* manual.

---

### Terms and definitions

The following terms are used in this manual:

**Failover** is the process of relocating the cluster resources from a failed server to the surviving server. The resource-monitor program responsible for the resource detects the failure. If a resource failure occurs, the resource-monitor program notifies the Cluster Service, which triggers the actions that are defined in the failover policy for that resource. A failover can occur automatically, such as when an application or a server fails, or it can occur manually, such as when a system administrator moves all applications onto one server and then brings the other server down for scheduled maintenance. Failover generally consists of three components:

- Failure detection
- Resource relocation
- Application restart.

**Failback** is a special case of failover and is the process of moving back some or all groups of resources to the preferred owner after a failover has occurred. The *preferred owner* is the server in the cluster on which you prefer each group of resources to run. If the preferred owner fails, its resources are transferred to the other server. When the preferred owner is repaired and comes back online, and **allow failback** is enabled in the Microsoft Cluster Administration program, the resources are automatically transferred back to that server.

**Resource Group** is dependent resources that can be grouped together. Some resources need other resources to run successfully and are known as *resource dependencies*. When one resource is listed as a dependency for another resource, the two resources must be placed in the same group. If all resources are ultimately dependent on one resource (for example, one physical disk resource), all resources must be in the same group. Therefore, all resources in a cluster might need to be in the same group.

Also, any cluster operation performed on a group is performed on all resources that are in that group. For example, if a resource must be moved from Server A to Server B, all resources that are in the same group as the resource will be moved also.

---

## ServeRAID considerations

It is important to understand the following ServeRAID considerations before you set up your high-availability cluster solution.

**Note:** The following ServeRAID considerations are for the Microsoft Cluster Solution using Windows NT and Windows 2000. For similar considerations for the Novell IntranetWare Cluster Solution, refer to the *Vinca High Availability for NetWare* manual.

## Hardware considerations

- The SCSI-2 Fast/Wide Enhanced Repeater Card is required for configurations using the IBM Enterprise Expansion Enclosure (Model 3518) or the IBM Model 3519 Rack Expansion Enclosure. The previous version of the SCSI-2 Fast/Wide Repeater is not supported in these configurations. For information on the latest version of the SCSI Fast/Wide Enhanced Repeater Card, contact your IBM reseller or marketing representative.
- Do not connect nondisk devices, such as CD-ROM drives, to shared channels. These devices will be accessible to both servers, and conflicts might arise.
- You must cable the SCSI channels in a controller pair so that the controllers share the same channels.
- You must connect all disks that will be shared to the shared channels. This includes hot-spare drives, as well as data drives.
- All shared physical drives must be part of a logical drive or defined as a hot spare to one or the other servers. You must remove all other physical drives from the shared disk enclosure to ensure proper operation.

## Controller considerations

- Each ServeRAID controller must have a unique controller name assigned.
- Do not attempt to change the controller name on both ServeRAID controllers in a pair at the same time. Doing so can cause a problem, such as a server *lock-up*.
- Each ServeRAID controller, and controller pair, must have a different SCSI initiator ID assigned to the shared channels. For example, set one server, Server A, to ID 6, and set the other server, Server B, to ID 7. The setup instructions describe this in more detail.
- You must set the stripe-unit size of each ServeRAID controller in a pair to the same value (8 KB, 16 KB, 32 KB, or 64 KB).
- You *cannot* share hot-spare drives between controllers in a cluster pairing. If you want hot-spare protection, *each* ServeRAID controller must have a hot-spare drive defined. You *must* connect hot-spare drives *only* to shared channels. This is in case the hot-spare drive replaces a failed shared drive. Both servers must be able to access the drive in case a failover occurs *after* the shared drive fails.
- Physical drives that are configured by one controller in the pair must appear as ready drives to the other controller in the pair. Be sure to verify this consideration when you add drives. Restart both servers, or scan for new devices using the ServeRAID Manager program on both servers, to make sure the added physical drives appear as ready drives on both servers before creating logical drives.

## Array or logical drive considerations

- The ServeRAID controller does not allow the failover of RAID level-5 logical drives that are in a critical state; that is, a drive in a RAID level-5 array that has



failed. For this reason, do not use RAID level-5 for the quorum drive. You must configure the quorum drive as a RAID level-1 logical drive.

**Note:** Define hot-spare drives in your array to minimize the time that logical drives remain in critical state.

- Every logical drive that is shared by the two servers *must* have its cache policy set to write-through mode to ensure that data integrity is maintained. Logical drives that are not shared between the two servers can be configured for write-back mode for improved performance.
- Create only *one* logical drive for each array.
- You must assign merge group numbers in the range 1– 8 to each logical drive that will be shared. Merge group numbers must be unique for each shared logical drive in the cluster. You must assign merge group numbers 206 or 207 to the non-shared logical drives.
- If you are starting (booting) the operating system from a shared controller, define the first logical drive as the startup drive and assign a merge group number for a non-shared drive, for example, 206 for Server A.
- The total number of logical drives per controller must be eight or less before or after a failover. If you exceed this number, a failover will not complete.
- Logical drives that are currently undergoing Logical Drive Migration (LDM) operations will not failover. However, all other logical drives will failover if necessary.
- If a failover occurs while a critical RAID level-1 logical drive is rebuilding to a spare disk, the Rebuild operation automatically starts a few seconds after the failover is completed.
- The cluster support software will initiate a synchronization of RAID level-1 and RAID level-5 logical drives immediately after a failover. If a drive fails before this synchronization is complete, logical drive access is placed in the blocked state and is no longer accessible.
- When a logical drive spans across multiple SCSI channels and a failure within the drive subsystem occurs that is unique to a channel (for example, a disconnected cable), the entire physical array will be identified as failed even though access from the surviving server can occur. Therefore, you might want to consider, if you have small arrays, not spanning across multiple channels.

Use the **Validate cluster** feature in the ServeRAID Manager program to verify your cluster is properly configured.

**Note:** If you must initialize your cluster configuration from the controller, you must manually reset the following settings because backup configurations do not save these settings:

- SCSI initiator IDs
- Host name
- Partner name.



---

## Chapter 6. Updating the ServeRAID BIOS, firmware, and software code

Before beginning the cluster installation, be sure to read “ServeRAID considerations” on page 74.

Use the following CD and diskette (version 4.0 or later), together as a set, with the IBM ServeRAID Cluster Solution:

- *IBM ServeRAID Support CD*
- *IBM ServeRAID Device Drivers* diskette

**Note:** If you are using the latest version of the *IBM ServeRAID Support CD*, the BIOS/firmware code is automatically verified when you start the server with the CD in the CD-ROM drive. If the BIOS/firmware code needs updating, you will be prompted to do so.

When you update any RAID software, you must update *all* RAID software at the same time to ensure compatibility with all of the levels of the software. This includes:

- BIOS/firmware
- Device drivers
- ServeRAID Manager
- IBM ServeRAID Cluster Solution software

Ensure that the ServeRAID controllers have the latest IBM ServeRAID software installed; you must have version 4.0, or later, as a minimum. You can obtain this software from the IBM Support Web site. See “Downloadable files from the World Wide Web” on page 14 for additional information. If you are using Microsoft Cluster Service, be sure that you use a version of the ServeRAID software that has been certified by Microsoft for Windows NT and Windows 2000 compatibility, as noted on the IBM Support Web site.

For instructions on how to determine the versions of the software on your ServeRAID controller, refer to the documentation that was included with your server or your controller.

**Note:** If you are using Windows 2000, check the Windows 2000 Hardware Compatibility List (HCL) included on the *Windows 2000 Advanced Server CD* or the IBM Server Proven List on the IBM Support Web site to determine if your server devices are supported by the Windows 2000 operating system. If not, contact the device manufacturer to receive a device driver for Windows 2000.



---

## Chapter 7. Configuring ServeRAID controllers for clustering

To install the IBM ServeRAID Cluster Solution, you must first install the BIOS and firmware. Refer to “Chapter 6. Updating the ServeRAID BIOS, firmware, and software code” on page 77. Then, you must configure the ServeRAID controller, define logical drives, and set up merge group numbers for your servers.

- If you are installing the IBM ServeRAID Cluster Solution using Microsoft Cluster Service, refer to “Configuring the controller for Microsoft Cluster Service using Windows NT 4.0 or Windows 2000”.
- If you are installing the IBM ServeRAID Cluster Solution using Vinca and Novell IntranetWare, refer to “Configuring the controller for Vinca High Availability for Novell IntranetWare or Novell High Availability Server”.

---

### Configuring the controller for Microsoft Cluster Service using Windows NT 4.0 or Windows 2000

If you are installing the IBM ServeRAID Cluster Solution by using Microsoft Cluster Service on Windows NT 4.0 or Windows 2000, follow these steps:

1. If necessary, perform any operating system shutdown procedure on *both* servers that you are going to use in the cluster.
2. Turn off *both* servers.
3. If you have not done so, connect any shared external drive enclosures to both servers; then, turn on the enclosures.
4. Follow the procedure “Configuring a controller for clustering” on page 80 for each shared controller in Server A.
5. Continue with the procedure “Configuring ServeRAID arrays and a logical drive” on page 82 for Server A.
6. Follow the procedure “Configuring a controller for clustering” on page 80 for each shared controller in Server B.
7. Remove the *IBM ServeRAID Support* CD from the CD-ROM drive.
8. Restart Server A and Server B.
9. If you are installing the IBM ServeRAID Cluster Solution using Microsoft Cluster Service using Windows NT 4.0, continue to “Chapter 8. Installing the Microsoft Cluster Service software on Windows NT 4.0” on page 85.

If you are installing the IBM ServeRAID Cluster Solution using Microsoft Cluster Service using Windows 2000, continue to “Chapter 9. Installing the Microsoft Cluster Service software on Windows 2000” on page 93.

**Note:** After you have completed installing the IBM ServeRAID Cluster Solution, use the **Validate cluster** feature in the ServeRAID Manager program to verify the cluster configuration. See “Validating a cluster” on page 103 for more information.

---

### Configuring the controller for Vinca High Availability for Novell IntranetWare or Novell High Availability Server

If you are installing the IBM ServeRAID Cluster Solution by using Vinca High Availability for Novell IntranetWare or Novell High Availability Server, following these steps:

1. If necessary, perform any operating system shutdown procedure on *both* servers that you are going to use in the cluster.
2. Turn off *both* servers.
3. If you have not done so, connect any shared external drive enclosures to both servers; then, turn on the enclosures.
4. Follow the procedure “Configuring a controller for clustering” for each shared controller in Server A.
5. Continue with the procedure “Configuring ServeRAID arrays and a logical drive” on page 82 for Server A.

**Note:** In a typical Novell environment, create the logical drives on the server that will maintain primary ownership. For example, create one RAID level-5 logical drive on Server A and one RAID level-5 logical drive on Server B.

6. Follow the procedure “Configuring a controller for clustering” for each shared controller in Server B.
7. Continue with the procedure “Configuring ServeRAID arrays and a logical drive” on page 82 for Server B.

**Note:** If you define an online drive or hot-spare drive for Server A, you cannot use that drive when creating arrays or hot-spare drives on Server B.

8. Restart Server A and Server B.
9. Install Novell NetWare on your servers. For installation information, refer to the documentation that comes with your Novell NetWare software package.
10. Install the Vinca IntranetWare software on your servers. For installation information, refer to the documentation that comes with Vinca High Availability for NetWare and IBM ServeRAID II SCSI Controller.

---

## Configuring a controller for clustering

To configure a controller, do the following.

**Note:** For complete information on using the ServeRAID Manager program, refer to the ServeRAID Manager online help.

1. Insert the *IBM ServeRAID Support* CD (or the configuration CD that was included with your server) into the CD-ROM drive; then, turn on the server. The ServeRAID Manager program starts.

**Note:** If the ServeRAID Manager program opens in Configuration mode, a window similar to the following opens. Click **Cancel** to go to Information mode and continue to the next step.

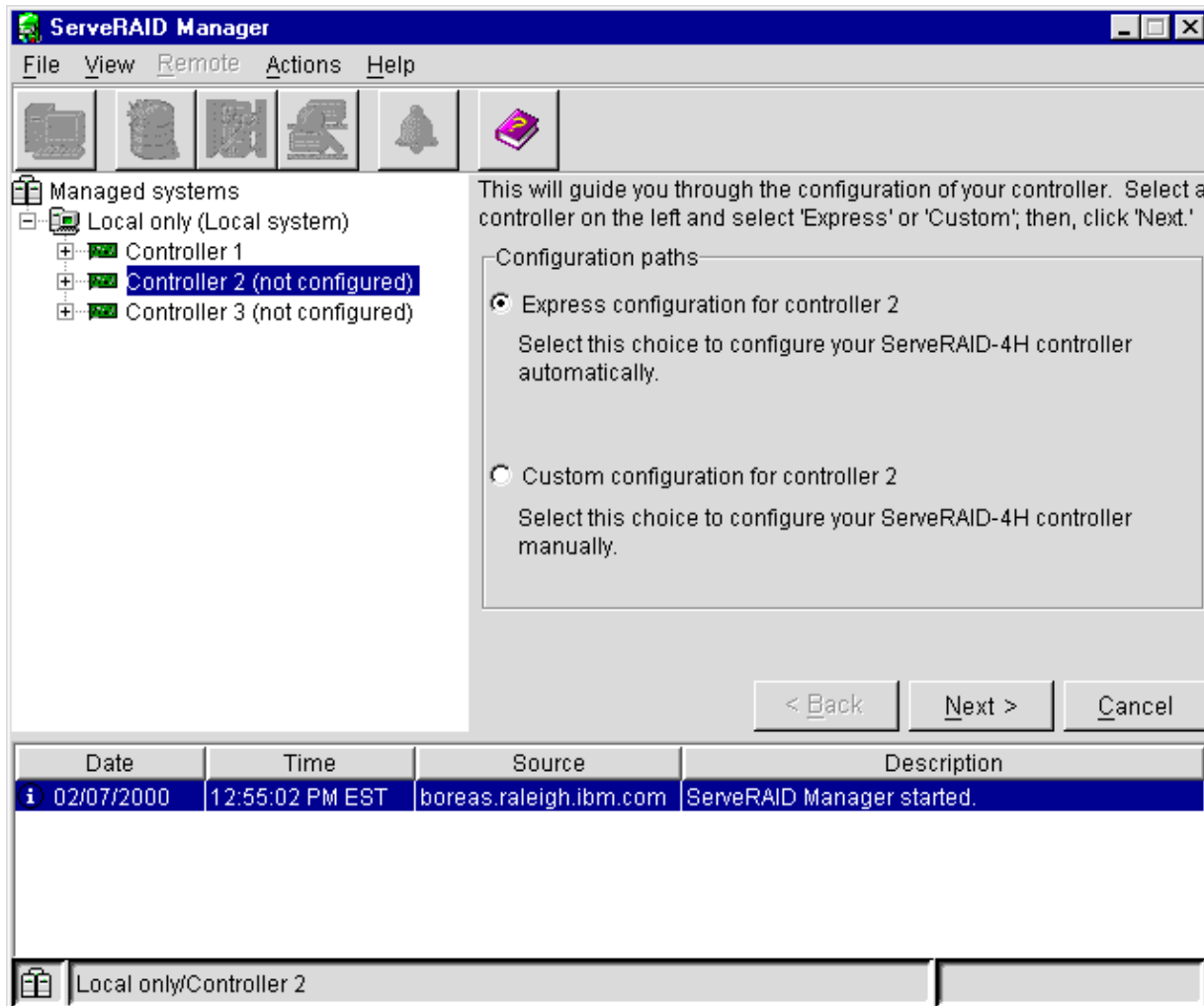

Figure 22. Configuration mode window

2. In the Main Tree, click the ServeRAID controller that you want to configure.

**Important**

The ServeRAID controller should be initialized only one time, when the controller is first installed. Initializing the controller removes all configuration information from NVRAM. This information includes the SCSI IDs, the Controller host ID and the Cluster partner host ID, and the array information. This point is especially important if the Windows NT or Windows 2000 system startup drive is attached to the IBM ServeRAID controller. If the initialization occurs after the startup drive array has been created, the array information will be removed and the system will no longer start in Windows NT or Windows 2000.

If you already have logical drives defined that you want to keep, go to step 6 on page 82. Completing step 1 on page 80 through step 5 will cause loss of data by deleting all logical drives already defined.

3. Click **Actions** → **Restore to factory default settings**.
4. If a confirmation window opens, click **Yes**. When the operation is complete, a message displays at the bottom of the window indicating that the restore to factory default settings was successful.
5. In the Main Tree, click the ServeRAID controller that you are configuring.

6. Click  on the tool bar. The Configure for clustering window opens.

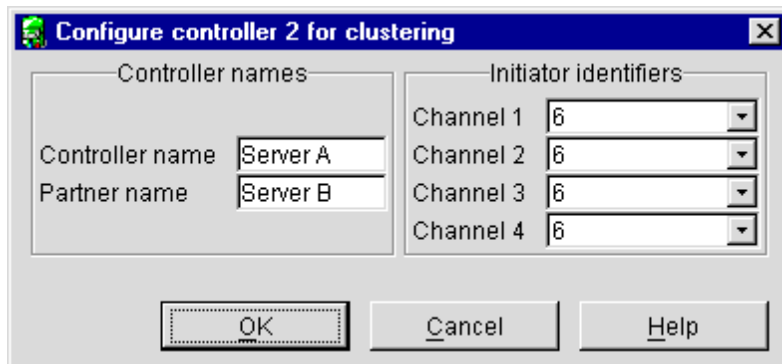

Figure 23. Configure for clustering window

7. Fill in the following information.

**Notes:**

- a. The controller name and partner name are case sensitive.
- b. If your configuration will contain multiple ServeRAID controllers pairs, each controller name must be unique.

**Controller name**

Enter a name to identify the first controller, for example, Server A.

**Partner name**

Enter a name that you will use to identify the second controller, for example, Server B.

**SCSI initiator IDs**

The system presets these IDs to 7. For Server B, do *not* change these values. For Server A, set each ID to 6 for shared channels.

**Note:** The ServeRAID Manager program does not permit you to enter numbers other than 6 and 7.

8. Click **OK**. The controller is now configured for clustering.

---

## Configuring ServeRAID arrays and a logical drive

**Important**

- **You must create only one logical drive for each array when defining shared logical drives for use in a cluster.**
- Hot-spare and standby hot-spare drives must be defined only on a shared channel, and each controller must have its own hot-spare or standby hot-spare drive defined. This means that you must not define the same hot-spare or standby hot-spare drive on both controllers in the pair.

To configure arrays and a logical drive, do the following.

- 1.

Click  on the tool bar. The Configuration mode window opens.



2. In the Main Tree, click the ServeRAID controller that you want to configure.
3. Click the **Custom configuration** radio button.
4. Click **Next**. The Create arrays window opens.
5. Using the right mouse button, click the ready drive or SCSI channel icons in the Main Tree to select the drives that you want to add to your arrays or delete from your arrays; then, select a choice from the pop-up list.

**Notes:**

- a. You must use all the ready drives when creating your arrays (that is, all ready drives in the Main Tree must be online).
  - b. Within the same array, you must have two or more physical drives for RAID level-1 and three or more physical drives for RAID level-5.
  - c. For Windows NT and Windows 2000, you must create at least one logical drive, the quorum drive, as RAID level-1 to store the quorum resource information. This drive can be used to store programs and data.
  - d. For improved reliability, do not create arrays that span channels.
  - e. Hot-spare drives are *not* shared between controllers in a cluster pairing. If you want hot-spare protection, *each* ServeRAID controller must have a hot-spare drive defined.
  - f. You *must* connect hot-spare drives *only* to shared channels. This is in case the hot-spare drive replaces a failed shared drive. Both servers must be able to access the hot-spare drive in case a failover occurs *after* the shared drive fails.
6. After you select the ready drives for your arrays, click **Next**. The Create logical drives window opens.

**Note:** If you change your mind, you can remove a specific drive from a newly defined array or delete an entire newly defined array. To do this:

- a. Click **Back**.
  - b. Using the right mouse button, click the specific drive or Array icon in the Main Panel on the right.
  - c. Click **Remove from new array** or **Delete new array**.
7. Select a RAID level for the logical drive from the RAID pull-down menu in the Main Panel.

**Note:** If you have four or more ready drives in an array, the recommended RAID level is RAID level-5E.

8. Click **Next**. The Configuration summary window opens.
9. Review the information that displays on the Configuration summary window. Click **Apply** to accept and save the configuration.

**Notes:**

- a. To change the configuration, click **Modify arrays** or **Modify logical drives**.
  - b. For Windows NT and Windows 2000 clusters, define all shared logical drives on Server A.
10. Click **Yes** to continue working with your ServeRAID configuration. After creating the arrays and logical drives, you must assign merge group numbers to the shared logical drives.

**Note:** A merge group number uniquely identifies each logical drive, even when the logical drive moves between servers.

11. In the Main Tree, click the ServeRAID controller that contains the logical drives.

**Notes:**

- a. Valid merge group numbers for non-shared logical drives are 206 and 207. For example, set all non-shared drives on Server A to merge group number 206 and all non-shared drives on Server B to merge group number 207.
- b. The merge group number must be unique for each logical drive that is shared by the controller pair. For example, if you have a logical drive with a merge group number 1 on Server A, you cannot assign the same group number to a logical drive on Server B. Valid merge group numbers for shared logical drives are in the range 1-8.

12. Click  on the tool bar. The Configure for clustering window opens.

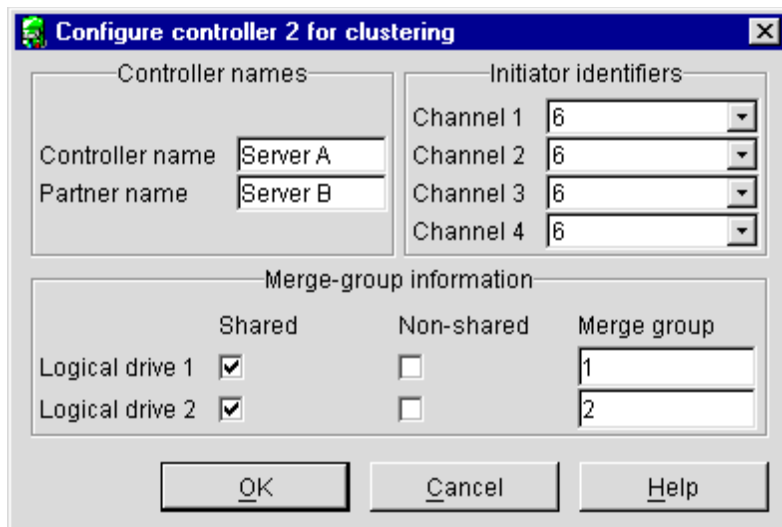

Figure 24. Configure for clustering window

13. Click the **Shared** check boxes for all the logical drives.
14. Do not change the merge group number from the default that is provided.
15. Record the controller name, partner name, and merge group numbers and store them in a safe place. You will need this information to recover the configuration if the ServeRAID controller should fail.

**Note:** You can save this information to a file by using the ServeRAID Manager program:

- a. In the Main Tree, click the server.
  - b. Click **Actions** → **Save printable configuration**.
16. Click **OK**.
  17. To exit the ServeRAID Manager program, click **File** → **Exit**.
  18. Remove the *IBM ServeRAID Support* CD from the CD-ROM drive.
  19. Shut down the server.

---

## Chapter 8. Installing the Microsoft Cluster Service software on Windows NT 4.0

After configuring the ServeRAID controller, defining logical drives, and setting up merge group numbers, install Microsoft Cluster Service (MSCS) on Windows NT 4.0.

### Important

Before beginning the procedure, consider the following:

- Read “ServeRAID considerations” on page 74, which contains important information on ServeRAID considerations.
- Read “Configuring the controller for Microsoft Cluster Service using Windows NT 4.0 or Windows 2000” on page 79 for configuring Server A and Server B for the high-availability cluster solution.
- Ensure that you are using the *IBM ServeRAID Device Driver* diskette (version 4.0, or later) during the installation of the Microsoft Windows NT Server Enterprise Edition.

---

### Installing the Microsoft Cluster Service

To install the Microsoft Cluster Service, complete the following procedure:

1. If you do not have Microsoft Windows NT Server Enterprise Edition installed already, install it with Service Pack 3 (or later) on both servers, but do not install the Microsoft Cluster Service software. When the system prompts you, deselect the option to install MSCS; it will be installed later in this procedure.  
For information on installing Windows NT Server Enterprise Edition, refer to documentation that is included with it. When you are finished, return here and continue with this procedure.
2. Use the ServeRAID Manager program to do the following:
  - Scan for new drives.
  - Check to see if synchronization of all RAID level-5 logical drives is completed. If logical drives are currently being synchronized, a progress indicator appears in the lower right corner of the ServeRAID Manager program showing the progress of the synchronization.
3. On Server A, run the utility IPSHAHTO.EXE from the *IBM ServeRAID Windows NT Cluster Solutions Diskette* or the *IBM ServeRAID Support CD*.
  - If you are using the diskette, type the following command from a Windows NT command line:  
`a:\support\ipshahto`  
where *a* is the diskette drive letter.
  - If you are using the CD, type the following command from a Windows NT command line:  
`d:\programs\winnt\cluster\support\ipshahto`  
where *d* is the CD-ROM drive letter.

Running the program makes all the shared logical drives available for access by Server A.
4. Using the Windows NT Disk Administrator, format all shared logical drives as NTFS (NT File System), assign volume labels, and specify drive letters for each.

**Notes:**

- a. It is helpful if part of the volume label that you assign contains the drive letter that you assigned to the drive, such as DRIVE E.
  - b. If you want to use the disk in a cluster, create only one partition on the disk. Make the partition the full size of disk and format the partition to NTFS.
5. On Server B, run the same utility, IPSHAHTO.EXE, to make all shared logical drives available for access by Server B.

**Note:** Use the volume label as a guide to make sure you assign the same letters on Server B as you assigned on Server A.

6. Using the Windows NT Disk Administrator, assign the same drive letters that you assigned to each drive on Server A.
7. Run IPSHAHTO.EXE from Server A again, so that control of all shared logical drives returns to Server A.
8. Install the Microsoft Cluster Service (MSCS) software.

**Note:** The directory name and path where the MSCS software is installed must be the same on both servers.

To start the installation, do the following.

**Important**

You must use the *localquorum* option when installing the Microsoft Cluster Service (MSCS) software with ServeRAID controllers.

- a. Insert the *Windows NT Server Enterprise Edition Component CD* into the CD-ROM drive on Server A, type the following command at the command line and press Enter.

```
\MSCS\CLUSTER\I386\SETUP /localquorum
```

**Note:** You *must* type the parameter **localquorum** in lowercase.

- b. Install the Microsoft Cluster Service software following the instructions in the documentation that is included with the MSCS software.  
Server A will restart when the installation is completed.
9. To make Server B *join* the cluster, do the following.

**Note:** The directory name and path where the MSCS software is installed must be the same on both servers.

- a. Insert the *Windows NT Server Enterprise Edition Component CD* into the CD-ROM drive on Server B. Type the following command (from either a command line or Add/Remove Programs in the Control panel) and press Enter:

```
\MSCS\CLUSTER\I386\SETUP
```

- b. Install the Microsoft Cluster Service software following the instructions in the documentation that is included with the MSCS software.  
Server B will restart when the installation is completed.
10. Make Server A the preferred owner of the cluster group by doing the following:
- a. Run the Microsoft Cluster Administrator program that is included with the MSCS software. Refer to the documentation that is included with the MSCS software for instructions.
  - b. Select the **Cluster Group**.
  - c. Click **File** → **Properties** to display the properties window.

- d. Click **Modify** next to the Preferred Owner text box.
  - e. Select **Server A** and move it to the right side, into the Preferred Owners panel.
  - f. Click **OK**. Server A appears in the Preferred Owner text box.
  - g. Make sure that the cluster group has failover enabled. For instructions on how to do this, refer to the documentation that is included with the Microsoft Cluster Services software.
  - h. Close the connection to the cluster and open it again to ensure that the connection is through Server A.
11. Install the IBM ServeRAID Windows NT Cluster Solution program by doing the following:
- a. On Server A, run the utility SETUP.EXE program from the *IBM ServeRAID Windows NT Cluster Solution* diskette or *IBM ServeRAID Support CD* and follow the instructions that appear on the screen.
    - If you are using the diskette, type the following command from a Windows NT command line:  
`a:\setup`  
  
 where *a* is the diskette drive letter.
    - If you are using the CD, type the following command from a Windows NT command line:  
`d:\programs\winnt\cluster\setup`  
  
 where *d* is the CD-ROM drive letter.
  - b. When the program has completed, run the SETUP.EXE program on Server B.  
  
 After the utility has been installed on both servers, all shared ServeRAID groups and disk resources will be automatically created by the IBM ServeRAID Cluster Solution setup program and then brought online. Server A is the current owner of these groups.
12. Move the quorum resource from *localquorum* to a ServeRAID disk resource by doing the following:
- a. On Server A, run the Microsoft Cluster Administrator program and click the cluster name to select the cluster you are using.
  - b. Verify that the same server (for example, Server A) owns the ServeRAID disk resources and the localquorum resource and that the quorum resource is moved to a RAID level-1 logical drive.
  - c. Using the right mouse button, click the cluster name to open the cluster.
  - d. Select **Properties**; then, select the **Quorum tab**.
  - e. In the **Quorum Resource** field, select a ServeRAID shared disk.
  - f. Click **OK**.  
  
 Refer to the *Microsoft Cluster Solution Administrator's Guide* for more information.
13. Install Service Pack 4 or later.
- Note:** If you installed Service Pack 4 or later previously, you must reinstall it now.

You can now move the shared disk resources manually using the Microsoft Cluster Administrator program or automatically during failover.

---

## Creating a ServeRAID disk resource on a Windows NT 4.0 ServeRAID cluster

You can use a ServeRAID logical disk that has not already been designated as a cluster resource, or you can create a new array and logical disk on Server A, using the ServeRAID Manager program. For more information about creating new arrays and logical drives, refer to “Step 3: Configuring ServeRAID controllers” on page 22.

**Note:** Be sure to assign a unique shared merge group number to the new shared logical drive.

### Important

Before creating the ServeRAID logical cluster resource, you must assign a permanent (sticky) drive letter to the shared logical drive on both servers.

When configuring a cluster, you must assign a permanent drive letter because the two servers must have the same drive letters on each shared logical drive. If you do not assign permanent drive letters, Windows NT might assign different drive letters on each server. You must assign a permanent drive letter to ensure Windows NT assigns the same drive letter to the partition on both servers.

1. On Server A, do the following:
  - a. Click **Start** in the lower-left corner of the screen; then, click **Programs** → **Tools** → **Administrative Tools** → **Disk Administrator**. The Disk Administrator window opens.
  - b. Click the partition that you want to assign a permanent drive letter.
  - c. Click **Tools** → **Assign Drive Letter**. The Assign drive letter window opens.
  - d. In the Assign drive letter pull-down menu, click the drive letter for the partition.
  - e. Click **OK**. Windows NT permanently assigns the selected drive letter to that partition, even if you add new partitions or rearrange your controllers.
  - f. To exit the Disk Administrator, click **Partition** → **Exit**.
2. On Server B, do the following:
  - a. Using the ServeRAID Manager program, scan for new or removed ready drives.
  - b. Using the IPSHAHTO.EXE program, move the newly defined logical drive.
  - c. Using the Windows NT Disk Administrator program, assign the same permanent (sticky) drive letter as in step 1.

Perform the following operation on the cluster server that currently owns the shared logical disk drive. The cluster server that owns the logical disk drives is the server on which you last ran the IPSHAHTO.EXE program.

1. On the server owning the newly created logical drive, run Cluster Administration program and open a connection to the installed cluster.
2. To create the ServeRAID disk resource in an existing group, ensure that the cluster server that owns the shared logical disk drive is the owner of that group. If the cluster server is not the owner of the group, use **Move Group** to make this cluster server the owner of the group where you will create the ServeRAID disk resource. Then, create the ServeRAID disk resource.
3. Bring the new ServeRAID disk group online. If you create a new ServeRAID group, the cluster server that owns the shared logical disk drive will be the owner of this group by default.
4. Create a ServeRAID disk resource as part of the new group.

5. Bring the ServeRAID disk group online.

---

## Deleting and re-creating a ServeRAID logical drive resource

This section describes how to delete and re-create a ServeRAID logical drive resource without deleting a ServeRAID logical drive.

To delete a resource or resource group:

1. If the resource or resource group is not currently owned by the cluster server from which you will delete the group, move the resource or resource group to that cluster server.

**Note:** The cluster service must be running on both systems.

2. To delete the resource, run the Microsoft Cluster Administration program from the cluster server that currently owns the resource or resource group.

**Note:** You can also run the Microsoft Cluster Administration program from a remote administration system.

Use the normal MSCS procedure for deleting a resource or a group. Refer to the documentation that is included with the MSCS package for instructions.

To create a resource:

1. If the group that will own the resource you are creating is not currently owned by the cluster server on which you want to create the resource, move the group to the cluster server.
2. To create the resource, run the Microsoft Cluster Administration program from the cluster server that currently owns the resource group.

Create a new ServeRAID logical disk. Refer to "Creating a ServeRAID disk resource on a Windows NT 4.0 ServeRAID cluster" on page 88.

---

## Uninstalling MSCS on ServeRAID servers

**Note:** *Do not* use the uninstallation procedure if you are upgrading MSCS on ServeRAID servers. To upgrade MSCS on ServeRAID servers, follow the instructions in "Updating ServeRAID software in an MSCS cluster environment" on page 90.

To uninstall MSCS on ServeRAID servers, you must perform the following procedure on all servers in your cluster:

1. Select one of the cluster servers from which to uninstall MSCS.
2. Click **Start** in the lower-left corner of the screen; then, click **Settings** → **Control Panel**. The Windows NT control panel window opens.
3. Double-click **Services**. The Services window opens.
4. Select **Cluster Service** from the list of services; then, click **Stop**.
5. Click **Close** to exit the Services window. For more information, refer to the documentation that is included with the cluster services.
6. In the Windows NT control panel, double-click **Add/Remove Programs**.
7. Select **Microsoft Cluster Service** from the list of installed components; then, click **Add/Remove**.

**Note:** Ignore the warnings regarding the removal of IBM ServeRAID Logical Disks.

8. Follow the on-screen prompts by clicking **OK** or **Yes**.
9. After the uninstallation of MSCS is complete, restart the server when prompted.
10. After the server has restarted, click **Start**; then, click **Settings** → **Control Panel**.
11. Double-click **Add/Remove Programs**.
12. Select **IBM ServeRAID Windows NT Cluster Solution** from the list of installed components; then, click **Add/Remove**.
13. Repeat step 1 on page 89 through step 12 on page 90 for the other server in the cluster.

---

## Updating ServeRAID software in an MSCS cluster environment

**Note:** If you are upgrading your ServeRAID software after downloading it from the IBM Support Web site, perform this procedure. If you are installing your software using the *IBM ServeRAID Support CD*, refer to “Chapter 2. Installing and configuring ServeRAID controllers” on page 13 for instructions.

### Important

This upgrade procedure allows the cluster to remain online at all times. To upgrade the cluster, perform the following steps on one server at a time. When all steps are completed for Server A and both servers are reported in the Microsoft Cluster Administrator program as *up* and all resources are *online*, repeat the steps for Server B.

**Note:** Use these instructions on a cluster running Microsoft Cluster Service (MSCS) Release 1.00 and IBM ServeRAID Cluster Solution.

### Step 1: Upgrading the IBM ServeRAID Manager program

To upgrade the ServeRAID Manager program, run the SETUP.EXE program on the *IBM ServeRAID Support CD*.

### Step 2: Upgrading the IBM ServeRAID Microsoft Windows NT Cluster Solution

To upgrade the IBM ServeRAID Microsoft Windows NT Cluster Solution, do the following on each server in the cluster:

1. Start the Microsoft Cluster Administrator program on the server you want to upgrade and move all resources and groups to the other server (its cluster partner).
2. Insert the *IBM ServeRAID Support CD* into the CD-ROM drive; then, type the following command and press Enter.

```
d:\programs\winnt\cluster\setup.exe
```

where *d* is the CD-ROM drive.

3. Follow the instructions that appear on the screen.



### Step 3: Upgrading the IBM ServeRAID Windows NT device driver

To upgrade the IBM ServeRAID Windows NT device driver on a server in the cluster, do the following:

1. Insert the *IBM ServeRAID Support* CD, version 4.0 or later into the CD-ROM drive.
2. Click **Start** in the lower-left corner of the screen; then, click **Settings** → **Control Panel**. The Windows NT control panel window opens.
3. Double-click **SCSI-Adapters**.
4. Click the **Drivers** tab.
5. Click **Add**.
6. Click **Have Disk**.
7. For the path, type:  
`d:\programs\winnt\driver\nt4_0`  
  
where *d* is the CD-ROM drive.
8. Click **OK**.
9. Click **OK** when the IBM ServeRAID controller is highlighted.
10. Shut down and restart the server from the CD.

### Step 4: Upgrading the IBM ServeRAID BIOS and firmware

To upgrade the IBM ServeRAID BIOS and firmware on a server in the cluster, do the following:

1. Start the server from the *IBM ServeRAID Support* CD, version 4.0 or later, if the server was not previously started in step 10 on page 91 of the procedure “Step 3: Upgrading the IBM ServeRAID Windows NT device driver”.
2. Flash the BIOS and download the firmware by clicking **Update** when prompted. If no update is required, the ServeRAID Manager program starts.
3. When the download is complete, remove the CD from the CD-ROM drive and press Ctrl+Alt+Del to restart (reboot) the server.
4. Allow the server to rejoin the cluster and when the server is reported in the Microsoft Cluster Administrator program as “Up” and all resources are online, the upgrade for this server is complete.

### Step 5: Upgrading the software for the other server in the cluster

To upgrade the software for the *other* server in the cluster, do the following:

1. Ensure that Server A is online in the cluster.
2. For Server B, repeat “Step 1: Upgrading the IBM ServeRAID Manager program” on page 90 through “Step 4: Upgrading the IBM ServeRAID BIOS and firmware”.

You have completed the steps necessary for upgrading the IBM ServeRAID Cluster Solution.



---

## Chapter 9. Installing the Microsoft Cluster Service software on Windows 2000

After configuring the ServeRAID controller, defining logical drives, and setting up merge group numbers, install Microsoft Cluster Service (MSCS) on Windows 2000.

**Note:** Do not configure Microsoft Cluster Service during the installation of Windows 2000 on any cluster node. You will configure MSCS later.

### Important

Before beginning the procedure, consider the following:

- Read “ServeRAID considerations” on page 74, which contains important information on ServeRAID considerations.
- Read “Configuring the controller for Microsoft Cluster Service using Windows NT 4.0 or Windows 2000” on page 79 for configuring Server A and Server B for the high-availability cluster solution.
- Ensure that you are using the *IBM ServeRAID Device Drivers* diskette (version 4.0; or later) during the installation of Windows 2000 Advanced Server Edition or Windows 2000 Datacenter Server Edition.

---

### Installing the ServeRAID Manager program

Before installing MSCS, you must install the ServeRAID Manager program:

1. If the server is not running, turn on the server.
2. Log on to Windows 2000.
3. Insert the *IBM ServeRAID Support* CD (or the configuration CD that was included with your server) into the CD-ROM drive of Server A. The ServeRAID Manager setup program starts.
4. Click **Next**.
5. Click **Yes** to the Software License Agreement.
6. When prompted to select an operating systems, select Windows 95/98/NT; then, click **Next**.
7. When prompted to install Windows NT Service, select Yes; then, click **Next**.
8. Select the Destination Folder.
9. Click **Next**.
10. After setup completes copying the files, click **Finish**.

---

### Installing the Microsoft Cluster Service

To install the Microsoft Cluster Service, complete the following procedure:

1. Use the ServeRAID Manager program to do the following:
  - Scan for new drives.
  - Check to see if synchronization of all RAID level-5 logical drives is completed. If logical drives are currently being synchronized, a progress indicator appears in the lower right corner of the ServeRAID Manager program showing the progress of the synchronization.
2. On Server A, run the utility IPSHAHTO.EXE from the *IBM ServeRAID Windows NT Cluster Solutions Diskette* or the *IBM ServeRAID Support* CD.
  - If you are using the diskette, type the following command from a Windows 2000 command line:

`a:\support\ipshahto`

where *a* is the diskette drive letter.

- If you are using the CD, type the following command from a Windows 2000 command line:

`d:\programs\winnt\cluster\support\ipshahto`

where *d* is the CD-ROM drive letter.

Running the program makes all the shared logical drives available for access by Server A.

3. Click **Start** → **Settings** → **Control Panel**. The Control Panel window opens.
4. Double-click **Computer Management**. The Computer Management window opens.
5. On the left side of the window, click to expand the **Storage** icon; then, click **Disk Management**. The Disk Signature and Upgrade Wizard window opens.
6. To assign disk signatures for the shared disks, click **Next**.
7. Microsoft Cluster Service using Windows 2000 requires you to set shared logical drives to Basic Disk. To do this, click **Cancel** in the Upgrade Disks panel of the window.
8. Format all shared logical drives to NTFS (NT File System), assign volume labels, and specify drive letters for each.

**Notes:**

- a. It is helpful if part of the volume label that you assign contains the drive letter that you assigned to the drive, such as DRIVE E.
- b. If you want to use the disk in a cluster, create only one partition on the disk. Make the partition the full size of disk and format the partition to NTFS.
- c. Make sure that all shared logical drives are the type Basic Disk. If they are marked Dynamic Disk, change them to Basic Disk by doing the following:
  - 1) With the right-mouse button, click the Disk icon at the bottom of the Disk Management window (see Figure 25 on page 95).
  - 2) Click **Revert to Basic Disk**.

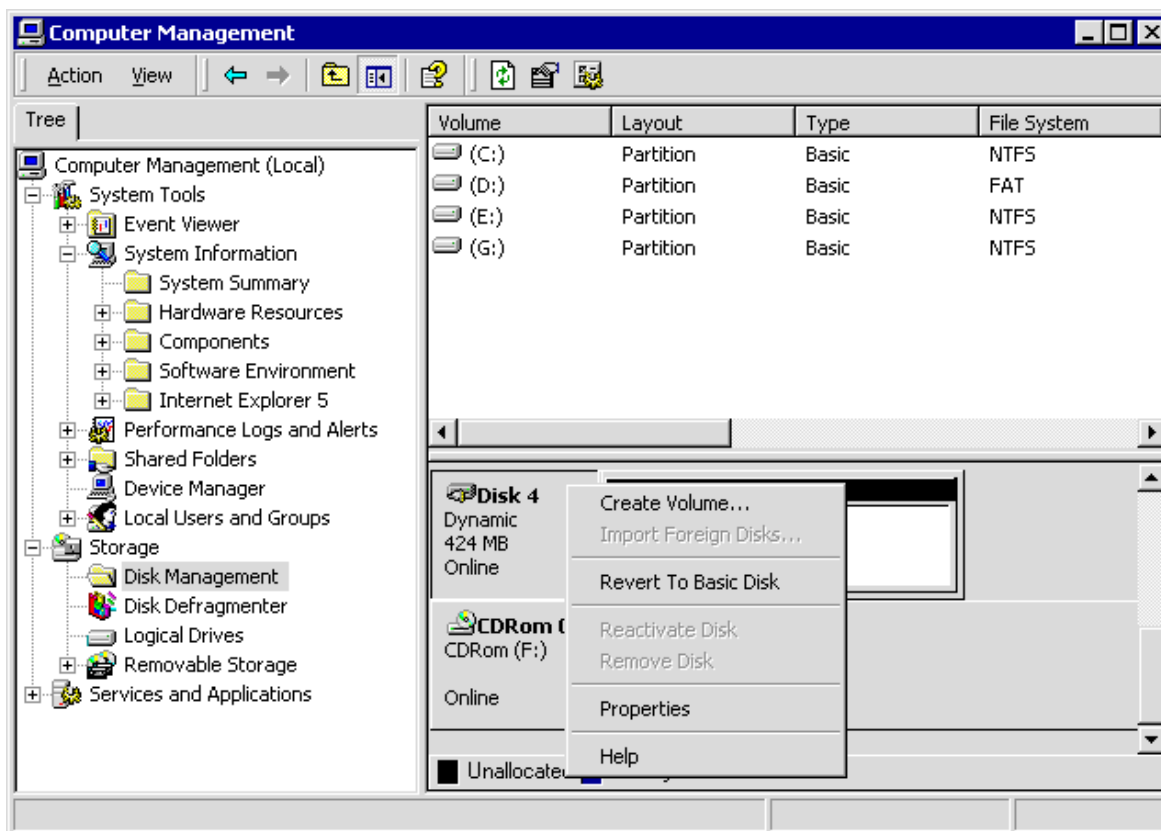

Figure 25. Changing a shared logical drive to Basic Disk

9. On Server B, run the same utility, IPSHAHTO.EXE, to make all shared logical drives available for access by Server B.

**Note:** Use the volume label as a guide to make sure you assign the same letters on Server B as you assigned on Server A.

10. Using the Windows 2000 Disk Management Snap-in Computer Management program, assign the same drive letters that you assigned to each drive on Server A.
11. Run IPSHAHTO.EXE from Server A again, so that control of all shared logical drives returns to Server A.
12. Using the Windows 2000 Disk Management Snap-in Computer Management program on Server A, verify that the shared logical drives display with the correct size, volume label, and drive letter.

**Note:** The drive letters for the shared disks must be the same on each server in the cluster.

13. If you have not selected the Clustering Service option for Server A and Server B in the Windows Components window during the Windows 2000 Advanced Server or Datacenter Server installation, do the following:
  - a. From the *Windows 2000 Advanced Server* CD, select **Install Add-On Components**.
  - b. Click the Cluster Service box; then, click **Next**.
14. After copying some files, the Windows Component Wizard opens the Cluster Service Configuration Wizard. Click **Cancel**.

15. Insert the *IBM ServeRAID Windows NT Cluster Solution* diskette or *IBM ServeRAID Support CD* into the Server A diskette or CD-ROM drive; then, type the following command and press Enter:
  - If you are installing from diskette, type the following command from a Windows 2000 command line and press Enter:  
`a:\setup`  
  
where *a* is the diskette drive letter.
  - If you are installing from CD, type the following command from a Windows 2000 command line and press Enter:  
`d:\programs\winnt\cluster\setup`  
  
where *d* is the CD-ROM drive letter.
16. Follow the instructions that appear on the screen. During this process, the SETUP.EXE program copies ServeRAID cluster files.
17. When prompted, start the IBM ServeRAID Cluster Configuration Wizard (MSCSCFG.EXE). Doing so starts the Microsoft Cluster Service Configuration Wizard.  
  
**Note:** Refer to Microsoft cluster documentation for instructions on configuring the Microsoft Cluster Service.
18. The Microsoft Cluster Service Configuration Wizard does not prompt you to select a quorum drive. After the Microsoft Cluster Service Configuration Wizard completes, the IBM ServeRAID Cluster Configuration Wizard applies ServeRAID-specific configurations to the cluster. Then, the wizard prompts you to select a shared ServeRAID logical drive on which to set quorum.  
  
**Note:** It is recommended that you place the quorum resources on RAID level-1.
19. Repeat step 13 on page 95 through step 17 on page 96 for Server B. The cluster installation is complete and the cluster is ready for use.

---

## Creating a ServeRAID disk resource on a Windows 2000 ServeRAID cluster

You can use a ServeRAID logical disk that has not already been designated as a cluster resource, or you can create a new array and logical disk on Server A, using the ServeRAID Manager program. For more information about creating new arrays and logical drives, refer to “Chapter 2. Installing and configuring ServeRAID controllers” on page 13.

**Note:** Be sure to assign a unique shared merge group number to the new shared logical drive.

### Important

Before creating the ServeRAID logical cluster resource, you must assign a permanent (sticky) drive letter to the shared logical drive on both servers.

When configuring a cluster, you must assign a permanent drive letter because the two servers must have the same drive letters on each shared logical drive. If you do not assign permanent drive letters, Windows 2000 might assign different drive letters on each server. You must assign a permanent drive letter to ensure Windows 2000 assigns the same drive letter to the partition on both servers.

1. On Server A, do the following:
  - a. Using the right-mouse button on the desktop, click **My Computer**; then, click **Manage**. The Computer Management window opens.
  - b. Double-click **Storage**.
  - c. Click **Disk Management**. The Write Signature and Upgrade Disk Wizard opens.
  - d. Using the right-mouse button, click **Disk Management** → **Rescan Disks**.
  - e. On each of the new disks, do the following:
    - 1) Using the right-mouse button, click on a new disk; then, click **Write Signature**. The Write Signature Wizard opens. Follow and complete the wizard.
    - 2) Make sure that all shared logical drives are the type Basic Disk. If they are marked Dynamic Disk, change them to Basic Disk by doing the following:
      - a) With the right-mouse button, click the Disk icon at the bottom of the Disk Management window.
      - b) Click **Revert to Basic Disk**.
    - 3) Create one partition on the disk (the full size of disk), assign a drive letter, and format the partition to NTFS.

**Note:** To help recognize the drive on the cluster partner server, assign a descriptive volume label that includes the drive letter.

2. On Server B, do the following:
  - a. Using the ServeRAID Manager program, scan for new or removed ready drives on all ServeRAID controllers.
  - b. To move the newly defined logical drive to Server B, start the IPSHAHTO.EXE program by typing:
 

```
%systemroot%\cluster\ipshahto.exe
```

where *%systemroot%* is expanded by the operating system to the root directory of the operating system on Server B.
  - c. To create a new ServeRAID disk resource and group for each newly defined logical drive on Server B, start the MSCSCFG.EXE program by typing:
 

```
%systemroot%\cluster\mscscfg.exe
```

where *%systemroot%* is expanded by the operating system to the root directory of the operating system on Server B.

To create a new ServeRAID disk resource and group for the ServeRAID logical drive, do the following on the cluster server that currently owns the shared logical drive.

**Note:** The cluster server that owns the shared logical drives is the server on which you last ran the IPSHAHTO.EXE program.

Start the MSCSCFG.EXE program by typing:

```
%systemroot%\cluster\mscscfg.exe
```

where *%systemroot%* is expanded by the operating system to the root directory of the operating system on the server.

---

## Deleting and re-creating a ServeRAID logical drive resource

This section describes how to delete and re-create a ServeRAID logical drive resource without deleting a ServeRAID logical drive.

To delete a resource or resource group:

1. To delete the resource, run the Microsoft Cluster Administration program from the cluster server that currently owns the ServeRAID resource or resource group.

**Notes:**

- a. The cluster service must be running on both servers.
  - b. You can also run the Microsoft Cluster Administration program from a remote administration system.
2. Use the normal MSCS procedure for deleting a resource or a group. Refer to the documentation that is included with the MSCS package for instructions.
  3. After deleting the ServeRAID resource, shut down and restart the cluster server from which the resource was deleted.

**Note:** Restarting one cluster server will *not* bring down the entire cluster.

To create the new ServeRAID disk resource and group for the ServeRAID logical drive, start the MSCSCFG.EXE program by typing:

```
%systemroot%\cluster\mscscfg.exe
```

where *%systemroot%* is expanded by the operating system to the root directory of the operating system on Server B.

---

## Upgrading the IBM ServeRAID Cluster Solution from Microsoft Windows NT 4.0 to Windows 2000

To upgrade from Windows NT 4.0 with Service Pack 5 (or later) to Windows 2000 Advanced Server, do the following.

**Note:** Before upgrading from Windows NT 4.0 Enterprise Edition, make sure you have updated Windows NT 4.0 Enterprise Edition with the latest Service Pack on both Server A and Server B.

1. On the server you want to upgrade, click **Start** → **Programs** → **Administrative Tool** → **Cluster Administrator**.
2. Move all cluster resources and groups to the other cluster node (that is, the server that is *not* running the Cluster Administrator program).
3. Insert the *IBM ServeRAID Support* CD (version 4.0 or later) into the CD-ROM drive; then, type the following command and press Enter:

```
d:\programs\winnt\cluster\setup.exe
```

where *d* is the CD-ROM drive.

4. When prompted "You are currently running Windows NT 4.0. Is this upgrade to "IBM ServeRAID NT Cluster Solution" being done as procedure to upgrade cluster to run Windows 2000?", click **Yes**.
5. The IBM ServeRAID Windows NT Solution Setup program copies the necessary Windows 2000 files; then, prompts you to upgrade the server to Windows 2000.



**Note:** Completing this step means you can not use this server as a Windows cluster node anymore.

6. Insert the *Microsoft Windows 2000 Advanced Server CD* or the *Microsoft Windows 2000 Datacenter Server CD* into the CD-ROM drive.
7. Run the Windows 2000 Advanced Server Setup program or the Windows 2000 Datacenter Server Setup program to upgrade this node to Windows 2000. After successfully upgrading the server, it joins the cluster.
8. Repeat step 1 on page 98 through step 7 on page 99 for the other server in the cluster.

---

## Uninstalling MSCS on ServeRAID servers

To uninstall MSCS on a ServeRAID server using Windows 2000 Advanced Server, do the following:

1. On the server you want to remove from the cluster, click **Start** → **Programs** → **Administrative Tools** → **Cluster Administrator**.
2. Move all cluster resources and groups to the other cluster server (that is, the server that is *not* running the Cluster Administrator program).
3. In the tree view, click the server from which you want to remove MSCS.
4. Using the right-mouse button, click **Evict Node**.
5. Click **Start** → **Settings** → **Control Panel**. The Control Panel window opens.
6. Double-click **Add/Remove Programs**. The Add/Remove Programs window opens.
7. In the left panel of the window, click **Add/Remove Windows Components**. The Windows Components Wizard opens.
8. Deselect **Cluster Service** in the Components list; then, click **Next**.
9. After uninstalling the Microsoft Cluster Service completes, the Windows Component Wizard prompts you to restart the server.
10. After the server restarts, click **Start** → **Settings** → **Control Panel**. The Control Panel window opens.
11. Double-click **Add/Remove Programs**. The Add/Remove Programs window opens.
12. Select IBM ServeRAID NT Cluster Solution from the list of installed components.
13. To uninstall the IBM ServeRAID Windows NT Cluster Solution, click **Change/Remove**.



## Chapter 10. Monitoring and updating an IBM ServeRAID Cluster Solution

You can use the ServeRAID Manager program to check the ownership of a physical drive on another server or to add or remove a logical drive in the cluster. The ServeRAID Manager program supports three features for cluster functions:

- Validate cluster
- Configure for clustering
- View shared drives.

**Note:** Make sure that you installed the ServeRAID Manager program on your server. If you need to install it, refer to “Installing the ServeRAID Manager program” on page 49 for instructions.

### Checking the ownership of a physical drive

A physical drive that is owned (and configured) on Server B will appear in the ready or defunct state on Server A. To determine if a ready drive is owned by the other server, do the following:

1. In the Main Tree, click the controller that contains the ready drives. A window similar to the following opens.

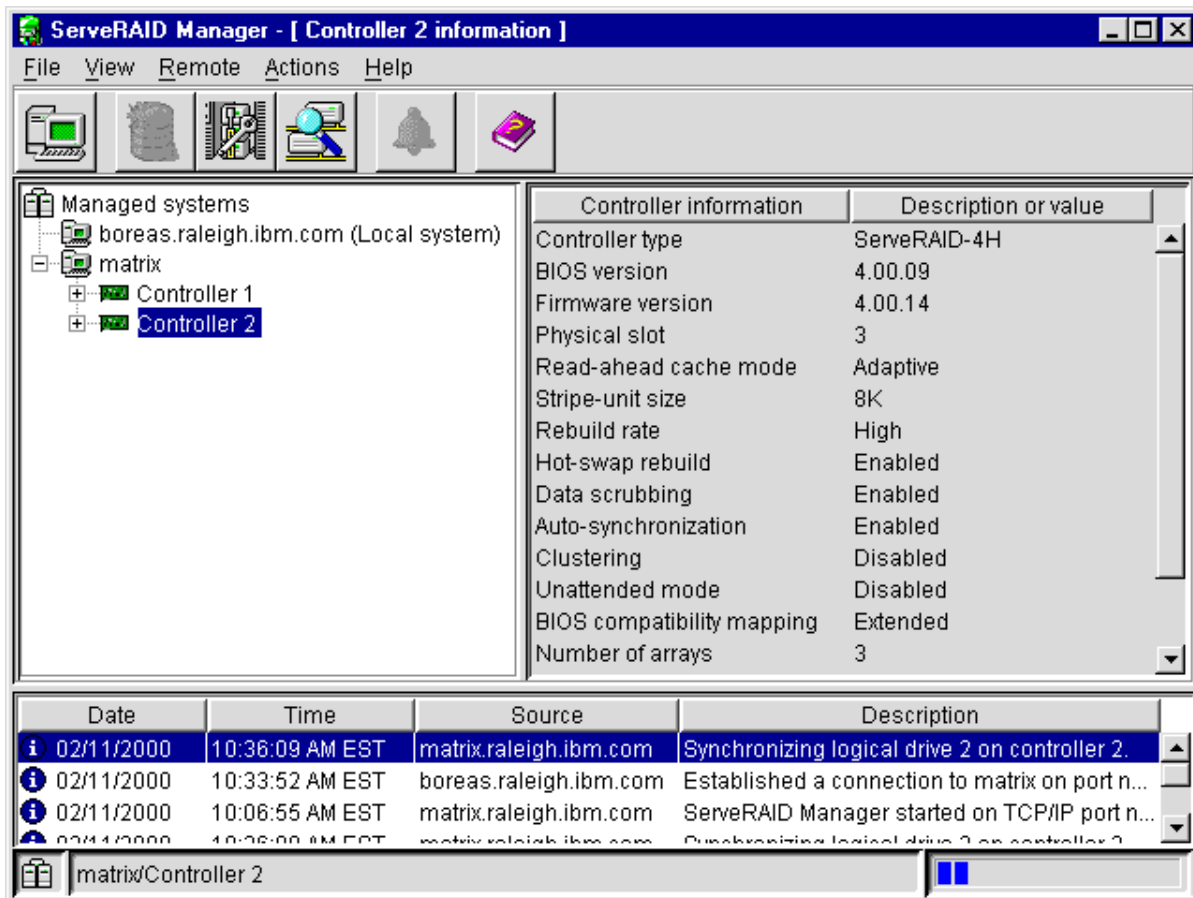

Figure 26. Information mode window

2. Click **Actions** → **Clustering actions**.
3. Click **View shared drives**. The View shared drives window opens.
4. Click **Enable view shared drives**.
5. Select the SCSI channel and SCSI ID of a physical drive on a shared channel.
6. Click **OK**. Physical drives that are available for use are labeled **Ready** in the Main Tree. If the physical drive is not available for use (that is, it is owned by the other server), the drive is labeled **Reserved** in the Main Tree.

**Important**

Hot-spare drives owned by the other server are not labeled **Reserved**. Be sure you do not inadvertently use a hot-spare drive in *both* servers.

---

## Adding logical drives to a cluster

If you want to add logical drives to a cluster, do the following:

1. Install the hard disk drives in the server or shared expansion enclosure. For installation information, refer to the documentation that is included with the hard disk drive and the server.

**Attention**

Physical drives that are configured by one controller in the pair must appear as ready drives to the other controller in the pair. Be sure to verify this status when you add drives *after* the servers are started. Before creating logical drives, restart both servers, or scan for new drives using the ServeRAID Manager program on both servers, to make sure the added physical drives appear as ready drives on both servers. For more information, see “ServeRAID considerations” on page 74.

2. Using the ServeRAID Manager program, configure the physical drives for the ServeRAID controller. Refer to “Step 3: Configuring ServeRAID controllers” on page 22 for instructions.

**Note:** If the drives will be shared, define only one logical drive per array.

3. In the Main Tree, click the controller for the cluster.

4. Click  on the tool bar. A window similar to the following opens.

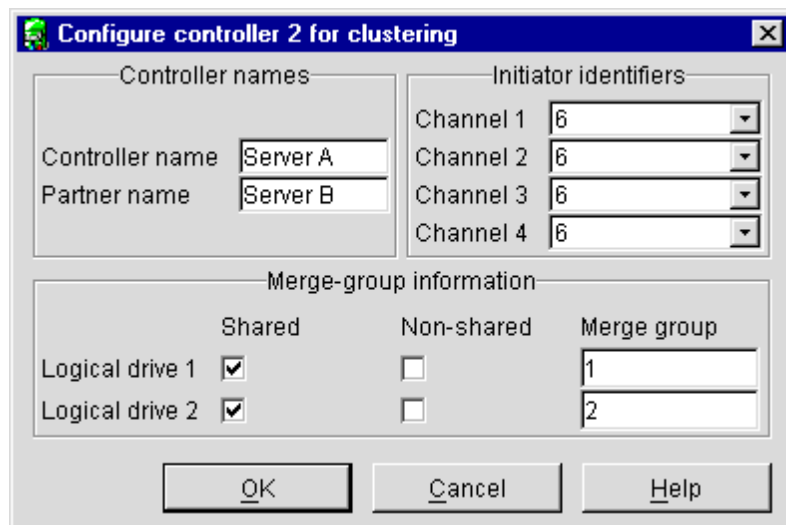

Figure 27. Configure for clustering window

5. Click **Shared** or **Non-shared** for the logical drive you have just defined.
6. Select the merge group number you want to use for the logical drive you just defined.
7. Click **OK**.
8. If you are using Windows NT 4.0, continue with “Creating a ServeRAID disk resource on a Windows NT 4.0 ServeRAID cluster” on page 88.  
If you are using Windows 2000, continue with “Creating a ServeRAID disk resource on a Windows 2000 ServeRAID cluster” on page 96.

---

## Validating a cluster

Use this feature to determine if your cluster is configured correctly.

**Note:** You must have the ServeRAID Manager program installed on all servers in the cluster for this feature to work.

To validate a cluster, do the following:

1. In the Main Tree, click a server in the cluster.
2. Click **Actions** → **Validate cluster**. A window similar to the following opens.

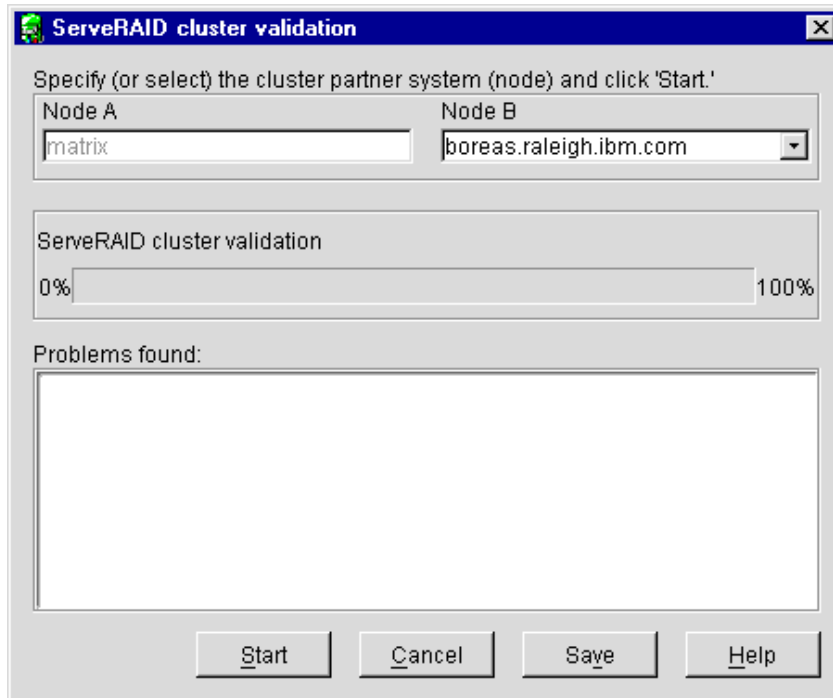

Figure 28. ServeRAID cluster validation window

The server you selected in step 1 on page 103 is listed in the Node A box.

**Note:** You cannot change the Node A system in the Cluster validation window. To select a different system, click **Cancel** to return to the Main Tree.

3. From the Node B pull-down menu, select your second server.

**Note:** The Node B system defaults to the first system in the Main Tree other than the Node A system. If there are no remote systems in the Main Tree, click **Cancel** to return to the Main Tree and add a remote system. You can also type in the Node B name.

4. Click **Start**. The ServeRAID Manager program scans both systems to verify the ServeRAID cluster configuration. The progress indicator reports the progress of the validation.
5. If you want to stop the validation before it completes, click **Cancel**. Otherwise, if the ServeRAID Manager program finds problems with the ServeRAID cluster configuration, it reports the problems in the **Problems found** message field. If there are no problems with the ServeRAID cluster configuration, the message field reports only the cluster pairings found.
6. To view the problem report events in an easy-to-read window, double-click an event in the **Problems found** message field.
7. To save the contents of the **Problems found** message field, click **Save**. A Save as window opens. Specify the file name for the message field log and click **OK**.
8. Click **Done** to exit the Cluster validation window. If the ServeRAID cluster configuration has problems, fix the problems; then, use **Validate cluster** again.

---

## Viewing merge group numbers and other cluster information

To view the merge group numbers and other cluster information, do the following:

1. In the Main Tree, click the controller you are using for the cluster.

2. Click  on the tool bar. A window similar to the following opens.

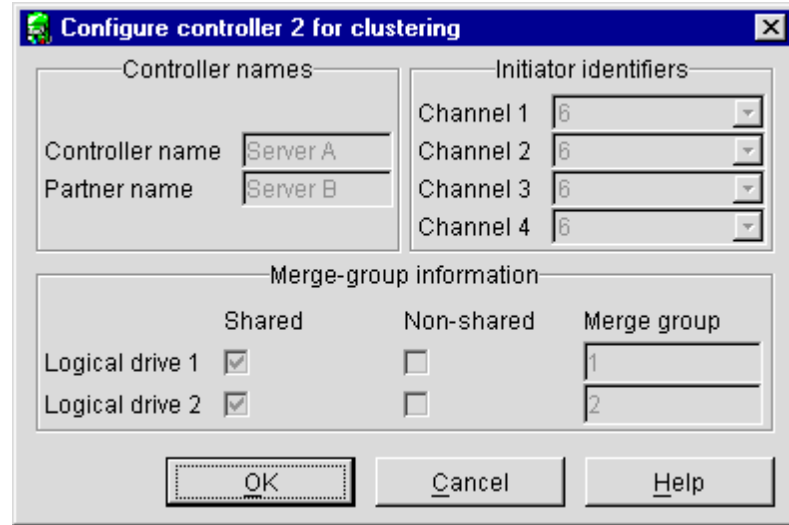

Figure 29. Configure controller for clustering window

**Note:** In this case, you can view this information only. You cannot change the information.





---

## Chapter 11. Using utility programs

This chapter provides the information that is needed to start and use the ServeRAID Mini-Configuration program, and the IPSSSEND and IPSMON command-line programs.

---

### Using the ServeRAID Mini-Configuration program

The ServeRAID Mini-Configuration program provides a quick way to display the current settings for the ServeRAID controller. You also can use this program to perform a limited set of the configuration functions without using the *IBM ServeRAID Support CD*.

To access the Mini-Configuration program:

1. Turn on the server. If the server already is running, shut down the operating system and restart the server.
2. When the ServeRAID Mini-Configuration prompt appears, press Ctrl+I.
3. If your server contains more than one ServeRAID controller, a selection screen will appear. To continue:
  - a. Use the Up Arrow (↑) or Down Arrow (↓) key to select a controller.
  - b. Press Enter.

If your server contains only one ServeRAID controller, or after you select a ServeRAID controller, the Main Menu appears.

Descriptions of the choices available from the Main Menu of the Mini-Configuration program are as follows:

- **View Controller Status** shows the current status of the ServeRAID controller. (See “Viewing the controller status” for more information.)
  - **View Configuration** shows the current configuration information for the ServeRAID controller. (See “Viewing the configuration” on page 108 for more information.)
  - **Advanced Functions** is used to initialize the configuration, import configuration from drives, configure BIOS settings, and view the controller and PCI information. (See “Using the advanced configuration functions” on page 108 for more information.)
4. Use the Up Arrow (↑) or Down Arrow (↓) key to highlight your choice; then, press Enter.
  5. Follow the instructions that appear on the screen.
  6. Click **Exit**; then, press Enter.

### Viewing the controller status

When you select **View Controller Status** from the Main Menu, the following information appears on the screen:

- All physical drives and their states
- **Unattended** shows the current state of the Unattended mode.
  - When this option is set to **Off**, you can choose the recovery method when a ServeRAID controller startup error occurs.
  - When this option is set to **On**, the ServeRAID controller chooses the recovery method when a startup error occurs.
- **Read Ahead** shows the current state of the read-ahead cache mode.

- **BootCD** shows the current state of the Bootable CD-ROM function. (Refer to “Setting the Bootable CD-ROM feature” on page 109.)
- **CompMode** shows the current BIOS compatibility mode. **On** indicates 8 gigabyte (GB) Extended; **Off** indicated 2 gigabyte (GB) Limited.
- **Clustered** shows the current state for clustering.
- **BBWC** shows the cache size of the battery-backup write cache, if it is installed (8 = 8 MB or 32 = 32 MB) or **No** if there is a no battery-backup write cache installed.
- **Boot Blk** shows the version number of the startable microcode (or firmware) loaded for the ServeRAID controller.
- **Code Blk** shows the current version number of the microcode (or firmware) loaded for the ServeRAID controller.
- **Rebuild Rate** shows the current speed setting for rebuilds: High, Medium, or Low.
- **Number of Defunct drives** shows the current number of defunct physical drives.
- **Number of Offline drives** shows the current number of offline logical drives.
- **Number of Critical drives** shows the current number of critical logical drives.
- **Config. Updates** shows the number of times that the configuration has been changed since it has been initialized. When you initialize the configuration, the Config. Update resets to zero.
- **Bad Stripe, Locked Stripe, or Blocked Drive** identifies the logical drives that are affected.
  - **Bad Stripe Drives** indicates logical drives that have inaccessible areas.
  - **Locked Stripe Drives** is a reserved field.
  - **Blocked Drives** indicates the logical drives that are blocked. You must unblock a blocked drive before you can use it. See “Logical drive state descriptions” on page 11 for more information.

## Viewing the configuration

You can select **View Configuration** from the Main Menu to display the number of each logical drive, and to display the size, RAID level, state, stripe-unit size, write policy, read-ahead status, and creation date for each logical drive.

## Using the advanced configuration functions

You can select the **Advanced Functions** to restore the controller configuration to factory default settings, copy the configuration to the controller from the connected physical drives, configure BIOS settings, and view the controller and PCI information.

When you select the **Advanced Functions** from the Main Menu, the following choices appear on the screen.

**Attention:** Be careful when making selections from this menu. If you change the configuration, you might lose data.

- **Restore to Factory Default Settings** is used to reset the configuration. When you reset the configuration, you will not have access to any data stored on the logical drives attached to the selected ServeRAID controller.

This choice deletes the existing configuration information, sets all functional physical drives attached to the controller to the ready state, and deletes all logical drives defined for the controller.

This choice *does not* change any of the ServeRAID controller settings (such as the stripe-unit size, rebuild rate, and so on) from their current values.

- **Copy the Configuration from Drives to Controller** reads the most common configuration from the drives in the server and copies it to the ServeRAID controller.
- **Configure BIOS Settings** is used to modify the BIOS settings, such as the Bootable CD-ROM setting, for the ServeRAID controller. (See “Setting the Bootable CD-ROM feature” for more information.)

**Note:** The Multiple Controller mode for extra BIOS has two settings: **Erase** and **Shrink**. When this parameter is set to **Erase**, redundant copies of the ServeRAID BIOS are erased. When this parameter is set to **Shrink**, the redundant copies of the ServeRAID BIOS are removed from memory but stored in the controller for future use. When multiple ServeRAID controllers are installed, you need only one active copy of ServeRAID BIOS. However, to ensure that you have a copy of the ServeRAID BIOS available if your active copy becomes defective or unavailable, leave the Multiple Controller parameter set to **Shrink**.

- **View Controller and PCI Information** shows the ServeRAID controller hardware and PCI register information.
- **Exit** is used to exit from the Mini-Configuration program.

### Setting the Bootable CD-ROM feature

When you attach a CD-ROM drive to the ServeRAID controller and set the Bootable CD-ROM feature to **Yes**, the ServeRAID controller will attempt to start a CD that has a startable (bootable) startup partition, if no other controller in the server is currently using INT13 extensions. Only one controller in the server can support the INT13 extensions.

To enable the Bootable CD-ROM feature:

1. Select **Advanced Functions** from the Main Menu of the Mini-Configuration program.
2. Select **Configure BIOS Settings** from the Advanced Functions menu.
3. Use the Up Arrow (↑) and Down Arrow (↓) keys to highlight **BIOS Support for Bootable CD-ROM** then press Enter to change **No** to **Yes**.
4. Ensure that the screen has **Yes** next to **BIOS Support for Reading Partition Tables**. If not, use the Up Arrow (↑) and Down Arrow (↓) keys to highlight **BIOS Support for Reading Partition Tables**; then, press Enter to change **No** to **Yes**.

**Note:** You must perform this next step to save the new settings.

5. Highlight **Save Configuration to the ServeRAID Controller** then, press Enter. The program displays an Okay message and then returns you to the Main Menu of the Mini-Configuration program.
6. Press Ctrl+Alt+Del to restart the server.

---

## Using the IPSSEND command-line program

The IPSSEND command-line program provides a quick way to do the following for the ServeRAID controller:

- Backup copies of data (see “FlashCopy function (for Windows NT and Windows 2000 only)”)
- Copy ServeRAID controller configurations from one server to another (see “Server roll-out functions” on page 116)
- Recover from a failed physical drive and rebuild an affected logical drive (see “Error-recovery functions” on page 118)
- Isolate problems and debug their cause (see “Problem-isolation and debug functions” on page 119)
- Display or modify a limited set of configuration settings (see “RAID Configuration functions” on page 122).

**Note:** If you do not have the IPSSEND program installed, refer to “Installing the IPSSEND and IPSMON command-line programs” on page 53.

When you run IPSSEND with no parameters, a list of available functions and their specific parameters appears. The available functions and their parameters are described in the sections that follow.

To run the IPSSEND program with no parameters:

- If you are using Windows NT 4.0, Windows 2000, or OS/2:
  1. Type:  
`c:\ipsadm\ipssend`  
where *c* is the drive letter of the drive where Windows NT 4.0, Windows 2000, or OS/2 is installed.
  2. Press **Enter**.
- If you are using NetWare:
  1. From the console, type:  
`load ipssend`
  2. Press **Enter**.
- If you are using Linux, OpenServer, or UnixWare:
  1. Type:  
`/usr/bin/ipssend`
  2. Press **Enter**.
- If you are using DOS:
  1. Insert the startable IPSSEND diskette into diskette drive A; then type:  
`a:\ipssend`  
  
where *a* is the drive letter of the diskette drive.
  2. Press **Enter**.

### FlashCopy function (for Windows NT and Windows 2000 only)

FlashCopy creates a quick backup copy of data from a source drive to a target drive at the instant you issue the command. Any changes made to the source drive after you issue the command are not reflected on the target drive.

You can use the backup copy for tasks such as tape backup and multiserver rollout (for example, drive cloning). FlashCopy sets up a link between the source and

target partitions, and then creates a snapshot-like backup of the source data on the target partition. The target partition is available instantly for read access.

**Note:** To create the backup copy, the following must be true:

- The size of the target partition must be equal to or larger than that of the source partition.
- The partition type must be the same on the source and target partitions.

When issuing the FlashCopy function, you must specify either the **FlashCopy backup** or **FlashCopy nobackup** functions to create a backup.

The **FlashCopy backup** function sets up a link between the source and target drives. This link creates a backup of the source data on the target drive. After the link is set up, a background copy operation is immediately initiated to copy all the data from the source drive to the target drive. After the background copy operation completes, the link between the source and target drives is dissolved.

The **FlashCopy nobackup** function also sets up a link between the source and target drives. Unlike the **FlashCopy backup** function, after the **FlashCopy nobackup** link is set up, *no* background copy operation immediately takes place. The background copy operation waits until the data on the source logical drive changes. When a change to the data on the source drive occurs, the backup of the source logical drive data gets copied to the target logical drive. Then, the new data gets written to the source logical drive. This **FlashCopy nobackup** link exists until you dissolve the link by issuing a **FlashCopy stop**.

**Note:** You have instant read access to the target partition after a **FlashCopy backup** or **FlashCopy nobackup** is issued.

#### **Important**

Before using FlashCopy, consider the following:

- Normal I/O functions can be performed on the source partition while the **FlashCopy** operation is in progress. If you are performing a FlashCopy **backup**, do not write to the target partition until the FlashCopy **backup** process is complete.  
If you are performing a FlashCopy **nobackup**, do not write to the target partition *at all*.
- You can have up to four FlashCopy relationships active at a time.
- The source and target drives must be on the same controller.
- There is no limit on source and target partition size.
- When FlashCopy completes, the data on the target partition will be an exact image of the data on the source partition at the time FlashCopy was issued.
- The target partition must be at least the same size as the source partition. For optimal space usage, the FlashCopy target partition should be the same size as the source partition.
- You can use the **noprompt** option to run some FlashCopy functions without receiving any interactive prompts.
- Both the source and target drives must be either spanned arrays or non-spanned arrays.
- If the source and target drives are spanned arrays, they must have the same number of sub-arrays.
- If the source and target drives are part of a spanned array, there can be only one partition for each logical drive on that spanned array.

The following information shows you how to use the **FlashCopy** function.

## flashcopy map

Use the **flashcopy map** function to correlate how the ServeRAID logical drives map to the operating-system drive partitions.

Supported operating systems: Windows NT, Windows 2000

Command: **ipssend flashcopy controller map**

where:

- *controller* is the ServeRAID controller number (1–12)

For example, if you type `ipssend flashcopy 2 map`, the following results appear on the screen:

Found 2 IBM ServeRAID Controller(s).

| Partition Number | Partition Letter | Partition Size | Logical Drive | Array Letter | Available for FlashCopy |
|------------------|------------------|----------------|---------------|--------------|-------------------------|
| 1                | H:               | 100            | 1             | A            | No (note 1)             |
| 2                | I:               | 100            | 2             | A            | No (note 1)             |
| 3                | J:               | 50             | 2             | A            | Yes                     |
| None             | None             | -              | 3             | B            | No (note 5)             |
| None             | None             | -              | 4             | B            | No (note 5)             |

### Note 1:

This partition is currently in an active FlashCopy link. See the table below for details. Use the STOP command to break this link. Once the link is broken, you can reissue the FLASHCOPY BACKUP or FLASHCOPY NOBACKUP command.

### Note 5:

There is no partition defined on this logical drive.

If a partition is available for FlashCopy, the report states **Yes** and there are no notes for that partition. If a partition is *not* available for FlashCopy, the report states **No** with one of the following explanatory notes:

### Note 1

This partition is currently in an active **FlashCopy** link. See the table below for details. Use the **stop** function to break this link. After the link is broken, you can reissue the FlashCopy **backup** or FlashCopy **nobackup** functions.

### Note 2

One or more of the following is true for this partition:

- The partition is the boot partition.
- The partition has open files.
- The partition has a memory-paging file.

You can override these requirements by using the **force** option. See the **FlashCopy backup** and **FlashCopy nobackup** functions for more details.

**Note 3**

One or more of the following is true for this partition:

- The partition is in the blocked state.
- The partition is not in the okay or critical state.
- The partition is currently synchronizing, rebuilding, or migrating.

**Note 4**

FlashCopy can support up to four active links only.

**Note 5**

There is no partition defined on this logical drive.

**flashcopy backup**

Use the **flashcopy backup** function to create a quick snapshot impression of source partitions on corresponding target partitions. Once the snapshot is created, the source partitions are ready for immediate use. When the process completes, each target partition will contain a copy of its source partition data that existed at the exact time you issued the **flashcopy backup** function. A link between each source partition and target partition will exist until all the data is copied. Once all the source data is copied to the target partition (determined by the **ipssend getstatus** function), the link is automatically broken, and you can use the **flashcopy delete** and **flashcopy import** functions to move a logical drive to another server.

You can use the **flashcopy map** function to determine the partition numbers and if they are available for the **flashcopy backup** process.

**Notes:**

1. Only one **flashcopy backup** (involving up to four source and target partitions) can be active on a controller at a time. If a **flashcopy backup** is in progress, you cannot issue another **flashcopy backup** or **flashcopy nobackup** until the previous **flashcopy backup** process is completed or until the backup links are broken. You can use the **flashcopy stop** function to break the links between the source and target partitions.
2. For **flashcopy backup** to function properly, each target partition must have the same partition type as its source partition.
3. Do not attempt to write to the target partitions until the backup process is completed.

Supported operating systems: Windows NT, Windows 2000

Command: **ipssend flashcopy controller backup** [*source target*]  
*options*

**Note:** The symbols [ ] above mean that the parameters are repeatable. The maximum number of repetitions is 4.

where:

- *controller* is the ServeRAID controller number (1–12)
- *source* is the source partition number

**Note:** Use the **flashcopy map** function to correlate the ServeRAID logical drive number to the operating system drive partition number.

- *target* is the target partition number

**Note:** Use the **flashcopy map** function to correlate the ServeRAID logical drive number to the operating system drive partition number.

- *options* is an optional parameter that includes the following:
  - POLL displays the progress of the **backup** function.
  - FORCE creates a **flashcopy** of a source partition that is the boot partition, contains open files, or contains a memory paging file.

**Note:** Using the FORCE option will not guarantee file consistency between the source and target partitions.

- NOPROMPT overrides the user prompt.

### **flashcopy nobackup**

Use the **flashcopy nobackup** function to create a quick snapshot impression of the source partition data on its target partition. Once the snapshot is created, the source partitions are ready for immediate use. Each target partition will contain a snapshot of its source partition data that existed at the exact time you issued the command. A link between each source partition and its target partition will exist until you issue the **flashcopy stop** function. Once you issue the **flashcopy stop** function, each target partition contents are no longer valid. The **flashcopy nobackup** function is useful if you want a snapshot of your data to perform a tape backup.

You can use the **flashcopy map** function to determine the partition numbers and if they are available for the **flashcopy nobackup** function process.

#### **Notes:**

1. Only one **flashcopy nobackup** link (involving up to four source and target partitions) can exist on a ServeRAID controller. If a **flashcopy nobackup** function is invoked, you cannot issue another **flashcopy backup** or **flashcopy nobackup** function until existing nobackup links are broken. You can use the **flashcopy stop** function to break the links between the source and target partitions.
2. For the **flashcopy nobackup** function to operate properly, each target partition must have the same partition type as its source partition.
3. Do not attempt to write to the target partition until the nobackup link is broken.

Supported operating systems: Windows NT, Windows 2000

Command: **ipssend flashcopy controller nobackup** [*source target*] *options*

**Note:** The symbols [ ] above mean that the parameters are repeatable. The maximum number of repetitions is 4.



where:

- *controller* is the ServeRAID controller number (1–12)
- *source* is the source partition number

**Note:** Use the **flashcopy map** function to correlate the ServeRAID logical drive number to the operating system drive partition number.

- *target* is the target partition number

**Note:** Use the **flashcopy map** function to correlate the ServeRAID logical drive number to the operating system drive partition number.

- *options* is an optional parameter that includes the following:
  - FORCE creates a **flashcopy** of a source partition that is the boot partition, contains open files, or contains a memory paging file.

**Note:** Using the FORCE option will not guarantee file consistency between the source and target partitions.

- NOPROMPT overrides the user prompt.

#### **flashcopy stop all**

Use the **flashcopy stop** function to break the link between the source partitions and target partitions. Once you issue the **flashcopy stop** function, the target partition contents are no longer valid. After you issue the **flashcopy stop** function, reformat your target partition.

Supported operating systems: Windows NT, Windows 2000

Command: **ipssend flashcopy controller stop all [noprompt]**

where:

- *controller* is the ServeRAID controller number (1–12)
- **noprompt** is an optional parameter to override the user-prompt.

#### **flashcopy delete**

Use the **flashcopy delete** function to delete an array. This is useful when you have used the **flashcopy backup** function and you want to move the target array to another server. After you delete the array, you can move the drives to the other server; then, you can issue the **flashcopy import** function to add the array to the existing configuration of the other server.

You can use the ServeRAID Manager program to identify the array you want to delete. This program can blink the LEDs for the drives that belong to the specific array.

#### **Important**

If your target logical drive is configured with write-back cache enabled, wait 10 minutes after the **flashcopy backup** completes before issuing a **flashcopy delete** function. This ensures that all data has been moved from the controller cache to the logical drive.

Supported operating systems: Windows NT, Windows 2000

**Note:** The **flashcopy delete** function is not available in a cluster configuration.

Command: **ipssend flashcopy controller delete arrayID**  
[noprompt]

where:

- *controller* is the ServeRAID controller number (1–12)
- *arrayID* is the Array ID (A–H)

**Note:** If the array is a spanned array, *arrayID* is the array ID (1–8).

- **noprompt** is an optional parameter to override the user-prompt.

### flashcopy import

Use the **flashcopy import** function to merge logical drive information from new physical drives when they are added to the server. You can use this function to incorporate a target array after a **flashcopy backup** function is completed.

#### Notes:

1. The stripe-unit size of the logical drives being imported must be the same as the stripe-unit size of the logical drives on the new controller.
2. The number of physical drives you add must be equal to the number of physical drives that were in the original defined logical drive.
3. The physical drives must be added while the server is powered on.
4. When a logical drive is imported, all partitions from that logical drive are also imported automatically. You cannot import a single partition selectively.
5. You must manually assign drive letters after the import completes.

Supported operating systems: Windows NT, Windows 2000

**Note:** The **flashcopy import** function is not available in a cluster configuration.

Command: **ipssend flashcopy controller import options**

where:

- *controller* is the ServeRAID controller number (1–12)
- *options* is one of the following:
  - ALL to specify all logical drives
  - *n* to specify a valid logical drive number (1–8)

## Server roll-out functions

The IPSSEND server roll-out functions include the following:

**autosync** Use the **autosync** function to synchronize a new logical drive. Use this function only on RAID level-5 logical drives. This function starts a background synchronization so you can use the logical drive immediately.

Supported operating systems: Windows NT, Windows 2000, OS/2, NetWare, Linux, OpenServer, UnixWare and DOS

Command: **ipssend autosync controller logicaldrive** [noprompt]

where:

- *controller* is the ServeRAID controller number (1–12)
- *logicaldrive* is the logical drive number (1–8)
- **noprompt** is an optional parameter that overrides the user prompt

### **backup**

Use the **backup** function to save a ServeRAID controller configuration and BIOS settings to a diskette or to a physical drive. The ServeRAID controller configuration must be valid.

Supported operating systems: Windows NT, Windows 2000, OS/2, NetWare, Linux, OpenServer, UnixWare and DOS

Command: **ipssend backup controller filename [noprompt]**

where:

- *controller* is the ServeRAID controller number (1–12)
- *filename* is the path and file name where the configuration is to be written
- **noprompt** is an optional parameter that overrides the user prompt.

### **copyld**

Use the **copyld** function to copy a source logical drive to a target logical drive. The size of the target logical drive must be greater than or equal to the size of the source logical drive.

Supported operating system: DOS

Command: **ipssend copyld controller source target [noprompt]**

where:

- *controller* is the ServeRAID controller number (1–12)
- *source* is the source logical drive number
- *target* is the target logical drive number
- **noprompt** is an optional parameter that overrides the user prompt.

### **init**

Use the **init** function to initialize the first 0.5 MB of a logical drive. This process will erase the partition tables and all data on the disk.

Supported operating systems: Windows NT, Windows 2000, OS/2, NetWare, Linux, OpenServer, UnixWare, and DOS

Command: **ipssend init controller drivenum [noprompt]**

where:

- *controller* is the ServeRAID controller number (1–12)
- *drivenum* is the logical drive number (1–8)
- **noprompt** is an optional parameter that overrides the user prompt.

### **restore**

Use the **restore** function to load a configuration from a file stored on a diskette or a hard disk. The configuration must be a valid configuration file from the backup option in IPSEND. This operation overwrites the existing configuration information and BIOS settings stored for the ServeRAID controller.

Supported operating systems: Windows NT, Windows 2000, OS/2, NetWare, Linux, OpenServer, UnixWare, and DOS

Command: **ipssend restore controller filename [noprompt]**

where:

- *controller* is the ServeRAID controller number (1–12)

- *filename* is the path and file name where the configuration is to be written
- **noprompt** is an optional parameter that overrides the user prompt.

### **synch**

Use the **synch** function to synchronize the parity information on redundant logical drives. If the parity information is inconsistent, the IPSSSEND program will repair it automatically.

Supported operating systems: Windows NT, Windows 2000, OS/2, NetWare, Linux, OpenServer, UnixWare, and DOS

Command: **ipssend synch controller drive drivenum**

where:

- *controller* is the ServeRAID controller number (1–12)
- *drive* indicates the number of logical drives:
  - DRIVE is a single logical drive
  - GROUP is a Merge Group
- *drivenum* specifies the *scope* item:
  - If DRIVE, specifies the logical drive number (1–8)
  - If GROUP, specifies the Merge Group number

## **Error-recovery functions**

The IPSSSEND error-recovery functions include the following:

### **getstatus**

Use the **getstatus** function to display the current logical-drive status for the most recent rebuild, synchronization, or logical-drive migration. The status includes such information as the remaining size of the logical drive, the percentage completed for the function in process, and information about the most recently completed logical-drive function.

Supported operating systems: Windows NT, Windows 2000, OS/2, NetWare, Linux, OpenServer, UnixWare, and DOS

Command: **ipssend getstatus controller**

where:

*controller* is the ServeRAID controller number (1–12)

### **rebuild**

Use the **rebuild** function to rebuild a designated disk drive. This function is valid for disk arrays that contain one or more logical drives that are in the critical state. Progress is indicated during the rebuild operation, but you can also use the **getstatus** function to obtain progress information about the rebuild.

Supported operating systems: Windows NT, Windows 2000, OS/2, NetWare, Linux, OpenServer, UnixWare, and DOS

Command: **ipssend rebuild controller dch dsid nch nsid**

where:

- *controller* is the ServeRAID controller number (1–12)
- *dch* is the channel number for the defunct drive (1–4)
- *dsid* is the SCSI ID for the defunct drive (0–15)
- *nch* is the channel number for the new drive (1–4)
- *nsid* is the SCSI ID for the new drive (0–15)

### **setstate**

Use the **setstate** function to change the state of a physical device from its current state to a new state.

**Attention:** You must be very careful when you use this function. For example, you might lose data if you reset a defunct device to online without first performing a rebuild operation.

Supported operating systems: Windows NT, Windows 2000, OS/2, NetWare, Linux, OpenServer, UnixWare, and DOS

Command: **ipssend setstate** *controller channel sid nstate*

where:

- *controller* is the ServeRAID controller number (1–12)
- *channel* is the channel number for the drive (1–4)
- *sid* is the SCSI ID for the drive (0–15)
- *nstate* is the new state for the drive. Valid states are:
  - EMP for Empty
  - RDY for Ready
  - HSP for Hot spare
  - SHS for Standby hot spare
  - DDD for Defunct disk drive
  - DHS for Defunct hot spare
  - RBL for Rebuild
  - SBY for Standby
  - ONL for Online.

#### **unblock**

Use the **unblock** function to gain access to a blocked logical drive. RAID level-0 logical drives become blocked if they are in an array that contains RAID level-1 or level-5 logical drives and the array is being rebuilt. Because the RAID level-0 logical drives cannot be rebuilt, the data stored on the RAID level-0 logical drives is damaged and should not be accessed. After you issue the **unblock** function, you must re-create or restore the data previously stored on the RAID level-0 logical drives.

Supported operating systems: Windows NT, Windows 2000, OS/2, NetWare, Linux, OpenServer, UnixWare, and DOS

Command: **ipssend unblock** *controller drivenum*

where:

- *controller* is the ServeRAID controller number (1–12)
- *drivenum* is the logical drive number (1–8)

## **Problem-isolation and debug functions**

The IPSSEND problem-isolation and debug functions include the following:

#### **certify**

Use the **certify** function to verify the media of a physical drive. When the program finds a media error, it reassigns the sectors. A summary of reassignments and PFA errors appears upon completion of the verification.

Supported operating system: DOS

Command: **ipssend certify** *controller channel sid*

where:

- *controller* is the ServeRAID controller number (1–12)
- *channel* is the channel number for the device (1, 2, 3, or 4)
- *sid* is the SCSI ID for the device (0–15)

#### **eraseevent**

Use the **eraseevent** function to clear all logged entries in the

designated event log. See **getevent** help for information about the contents of the device event log and the controller soft and hard event logs.

Supported operating systems: Windows NT, Windows 2000, OS/2, NetWare, Linux, OpenServer, UnixWare, and DOS

Command: **ipssend eraseevent controller options**

where:

- *controller* is the ServeRAID controller number (1–12)
- *options* is the designated event log:
  - DEVICE for the device event log
  - SOFT for the ServeRAID controller soft event log
  - HARD for the ServeRAID controller hard event log

### **getbst**

Use the **getbst** function to display the number of bad stripes in the bad stripe table for each logical drive.

Supported operating systems: Windows NT, Windows 2000, OS/2, NetWare, Linux, OpenServer, Unixware, and DOS

Command: **ipssend getbst controller**

where:

*controller* is the ServeRAID controller number (1–12)

### **format**

Use the **format** function to perform a low-level format of a physical drive.

#### **Attention:**

1. When you issue this function, all data on the disk will be lost.
2. After a **format** function is issued, do not stop it. If a format process is stopped for any reason, the hard disk that was being formatted will not respond to any functions except the **format** function. Thus, the ServeRAID controller will not be able to recognize functions anymore. To recover the drive, refer to “Recovering from an incomplete format of a physical drive” on page 137.

Supported operating system: DOS

Command: **ipssend format controller channel sid**

where:

- *controller* is the ServeRAID controller number (1–12)
- *channel* is the channel number for the device (1, 2, 3, or 4)
- *sid* is the SCSI ID for the device (0–15)

### **getevent**

Use the **getevent** function to display information about various unexpected events. IBM uses the soft and hard event logs for development and debugging purposes only. The device event log contains event counters for each attached physical device. These counters include:

- Parity: An unexpected event occurred while data was being transferred on the SCSI bus. This usually indicates a problem with the SCSI cable, connectors, or terminators.
- Soft: A SCSI device detected a check-condition event.

- **Hard:** The SCSI controller detected an unexpected event. The controller is the most likely cause.
- **Misc:** The ServeRAID controller detected an event that was most likely caused by the device.

The device event log also provides Predictive Failure Analysis (PFA) alerts, which indicate that the device has signaled the ServeRAID controller that it might fail in the near future.

Supported operating systems: Windows NT, Windows 2000, OS/2, NetWare, Linux, OpenServer, UnixWare, and DOS

Command: **ipssend getevent** *controller options*

where:

- *controller* is the ServeRAID controller number (1–12)
- *options* is the designated event log:
  - DEVICE for the device event log
  - SOFT for the ServeRAID controller soft event log
  - HARD for the ServeRAID controller hard event log

#### **selftest**

The **selftest** function is used to direct a controller or a device to perform its self-test.

Supported operating systems: DOS

Command: **ipssend selftest** *controller options*

where:

- *controller* is the ServeRAID controller number (1–12)
- *options* is the designated self-test:
  - AD for the ServeRAID controller self-test
  - PD *channel sid* for the device self-test

**Note:** *channel* represents the drive channel (1–4), and *sid* is the SCSI ID for the device (0–15).

#### **startdely**

Use the **startdely** function to set the number of drives in a group to start up simultaneously and to set the delay in seconds between the startup of these groups of drives.

Supported operating systems: DOS

Command: **ipssend startdely** *controller options*

where:

- *controller* is the ServeRAID controller number (1–12)
- *options* is one of the following:
  - ? displays the concurrent drive startup count and the delay time.
  - A number (1–16) that specifies the new concurrent drive startup count.
  - A number (1–16) that specifies the new concurrent drive startup count and a number (3–15) that specifies the startup delay time, in seconds.

## RAID Configuration functions

The IPSSEND RAID configuration functions include the following:

**devinfo** Use the **devinfo** function to retrieve information (such as size and state) about a specific device.

Supported operating systems: Windows NT, Windows 2000, OS/2, NetWare, Linux, OpenServer, UnixWare, and DOS

Command: **ipssend devinfo controller channel sid**

where:

- *controller* is the ServeRAID controller number (1–12)
- *channel* is the channel number for the device (1, 2, 3, or 4)
- *sid* is the SCSI ID for the device (0–15)

**drivever** Use the **drivever** function to display the vendor ID, microcode version, and serial number of a SCSI device. The IPSSEND program retrieves this information directly from the device.

Supported operating systems: Windows NT, Windows 2000, OS/2, NetWare, Linux, OpenServer, UnixWare, and DOS

Command: **ipssend drivever controller channel sid**

where:

- *controller* is the ServeRAID controller number (1–12)
- *channel* is the channel number for the device (1, 2, 3, or 4)
- *sid* is the SCSI ID for the device (0–15)

**getconfig** Use the **getconfig** function to display the ServeRAID controller configuration information. This includes information about the firmware version; initiator ID and rebuild rate; logical-drive status, RAID level, and size; and physical device type, SCSI ID, and PFA error.

Supported operating systems: Windows NT, Windows 2000, OS/2, NetWare, Linux, OpenServer, UnixWare, and DOS

Command: **ipssend getconfig controller options**

where:

- *controller* is the ServeRAID controller number (1–12)
- *options* is one of the following:
  - AD for the controller information
  - LD for the logical drive information
  - PD for the physical device information
  - AL for all information. This is the default option.

**hsrebuild** Use the **hsrebuild** function to turn on the ServeRAID controller hot-swap rebuild feature or display the current status of the hot-swap rebuild feature.

Supported operating systems: Windows NT, Windows 2000, OS/2, NetWare, Linux, OpenServer, UnixWare, and DOS

Command: **ipssend hsrebuild controller options**

where:

- *controller* is the ServeRAID controller number (1–12)
- *options* is one of the following:
  - ON enables the hot-swap feature
  - ? displays the status of the hot-swap rebuild feature.



- readahead** Use the **readahead** function to enable, disable, or set the adaptive mode for the read-ahead feature of the ServeRAID controller.  
Supported operating systems: Windows NT and DOS  
Command: **ipssend readahead controller options**  
where:  
• *controller* is the ServeRAID controller number (1–12)  
• *options* is one of the following:  
– ON enables the read-ahead feature  
– OFF disables the read-ahead feature  
– ADAPTIVE indicates that the controller will determine the best mode to use at any given time.  
– ? displays the current read-ahead feature mode being used.
- stripesize** Use the **stripesize** function to set the size of the ServeRAID controller stripe to 8 KB, 16 KB, 32 KB, or 64 KB.  
Supported operating systems: DOS  
Command: **ipssend stripesize controller options**  
where:  
• *controller* is the ServeRAID controller number (1–12)  
• *options* is one of the following:  
– 8 to set the stripe-unit size to 8 KB  
– 16 to set the stripe-unit size to 16 KB  
– 32 to set the stripe-unit size to 32 KB  
– 64 to set the stripe-unit size to 64 KB  
– ? to display the current stripe-unit size being used.
- unattended** Use the **unattended** function to enable or disable the unattended feature of the ServeRAID controllers.  
Supported operating systems: Windows NT, Windows 2000, OS/2, NetWare, Linux, OpenServer, Unixware, and DOS  
Command: **ipssend unattended controller options**  
where:  
• *controller* is the ServeRAID controller number (1–12)  
• *options* is one of the following:  
– ON to enable the feature  
– OFF to disable the feature  
– ? to display the current setting of this feature.

---

## Using the IPSMON command-line program (NetWare only)

The IPSMON command-line program provides a quick way to monitor ServeRAID controllers for specific conditions. The IPSMON program is available for Novell NetWare only.

To run the IPSMON program:

1. From the console, type:  
    load ipsmon
2. Press Enter.

When you start IPSMON, it immediately begins polling all ServeRAID controllers for specific conditions. If a condition being monitored is found, this program logs a message to the screen, to a file, or to both the screen and a file.

**Note:** IPSMON continuously polls the ServeRAID controllers until you type `unload ipsmon` at the system console.

Supported operating systems: NetWare

Command: `ipsmon options`

where:

- *options* is one of the following optional parameters:
  - `-F:filename` to specify the name of the file in which to record messages. The default file name is IPSMON.LOG.
  - `-S` to display messages on the standard output (usually the monitor)
  - `-?` to obtain a current list of valid parameters

**Note:** If you start this program without any command-line parameters, the IPSMON program will log the messages to the IPSMON.LOG file, and the messages will not appear on the screen.

During operation, IPSMON logs various messages. Each message contains an alert code and a location specifier.

- The alert code begins with the message type and number; for example, INF, WRN, or CRT (followed by the message number).
- The location specifier comes after the alert code:
  - A** followed by the controller number
  - SID** followed by the SCSI ID (if required)
  - C** followed by the channel number (if required)

For example, a message of CRTxxx:A2C3SID04 signifies that a Critical condition (CRTxxx) was found on Controller 2 (A2), Channel 3 (C3), SCSI ID 4 (SID04).

The IPSMON program can log the following messages, based on the required condition.

**Information Messages:**

```
<Date and Time> INF000:A1C-SID-- no errors detected
<Date and Time> INF001:A1C-SID-- rebuild started
<Date and Time> INF002:A1C-SID-- rebuild completed
<Date and Time> INF003:A1C-SID-- synchronization started
<Date and Time> INF004:A1C-SID-- synchronization completed
<Date and Time> INF005:A1C-SID-- migration started
<Date and Time> INF006:A1C-SID-- migration completed
```

**Warning Messages:**

```
<Date and Time> WRN001:A2C3SID12 PFA Error detected
```

**Critical Messages:**

```
<Date and Time> CRT001:A3C2SID04 dead drive detected
<Date and Time> CRT002:A1C-SID-- not responding to commands
```

---

## Chapter 12. Solving ServeRAID problems

This section describes the ServeRAID text and numeric messages that might appear during startup. This section also includes some basic information about rebuilding a defunct drive.

In addition to the information provided in this section, you might want to use the ServeRAID IPSSSEND program to help isolate ServeRAID problems. See “Using the IPSSSEND command-line program” on page 110 and “Problem-isolation and debug functions” on page 119 for information about using the IPSSSEND program.

---

### ServeRAID Manager fails to start (Windows NT and Windows 2000 only)

If you start a server with the *IBM ServeRAID Support* CD in the CD-ROM drive and the ServeRAID Manager does not start, you must reduce the number of FAT partitions with assigned drive letters on the server.

For the startable (boot) *IBM ServeRAID Support* CD to work on a server that has Windows NT or Windows 2000 installed on it, the server cannot have more than 22 FAT partitions with assigned drive letters.

---

### ServeRAID controller messages

This section lists the ServeRAID messages that might appear during system startup.

The ServeRAID controllers provide a Device Event Log that collects statistics on the number and types of events that occur on a selected physical drive. After correcting a problem with the disk array, clear the log so that you can identify any subsequent errors quickly. For information about clearing the event log, see “**eraseevent**” on page 119.

All physical drives contain unique identifiers, such as the drive serial number and manufacturer. During configuration, the ServeRAID controller stores this information.

Following are messages associated with the ServeRAID subsystem in alphabetical order.

| Message                             | Explanation                                                                                                                                                                                                  | Action                                                                                                   |
|-------------------------------------|--------------------------------------------------------------------------------------------------------------------------------------------------------------------------------------------------------------|----------------------------------------------------------------------------------------------------------|
| A new drive was installed.          | When the ServeRAID controller detects a new drive that is not part of the current configuration, the following message appears:<br><br>x new Ready drives found where x is the number of Ready drives found. | This is an information message. No action is required.                                                   |
| Auto rearrange.                     | Auto rearrange is enabled or disabled.                                                                                                                                                                       | This is an information message. No action is required.                                                   |
| Battery-backup cache not responding | BIOS code detected a bad or failed battery-backup cache.                                                                                                                                                     | Press F9 to remove the battery-backup cache from the configuration, or press F10 to exit without change. |

| Message                          | Explanation                                                                                                                                                                                                                                                                                                       | Action                                                                                                                                                                                                                                                                                                                                                                                                                                                                                                                                                                                                                                                                                                                                                                                                                                                                                                                                                                                                                                                                                                                                                                                                                                                                                                                                                                                                                                                                                                                                                                                                                                                                                                                                                                                                                                                                                                                                                                                                                                                 |
|----------------------------------|-------------------------------------------------------------------------------------------------------------------------------------------------------------------------------------------------------------------------------------------------------------------------------------------------------------------|--------------------------------------------------------------------------------------------------------------------------------------------------------------------------------------------------------------------------------------------------------------------------------------------------------------------------------------------------------------------------------------------------------------------------------------------------------------------------------------------------------------------------------------------------------------------------------------------------------------------------------------------------------------------------------------------------------------------------------------------------------------------------------------------------------------------------------------------------------------------------------------------------------------------------------------------------------------------------------------------------------------------------------------------------------------------------------------------------------------------------------------------------------------------------------------------------------------------------------------------------------------------------------------------------------------------------------------------------------------------------------------------------------------------------------------------------------------------------------------------------------------------------------------------------------------------------------------------------------------------------------------------------------------------------------------------------------------------------------------------------------------------------------------------------------------------------------------------------------------------------------------------------------------------------------------------------------------------------------------------------------------------------------------------------------|
| Battery-backup cache replacement | The ServeRAID controller detects that the battery-backup cache is defective.                                                                                                                                                                                                                                      | Press F8 if you replaced the battery-backup cache, or press F10 if you have not replaced the battery-backup cache.                                                                                                                                                                                                                                                                                                                                                                                                                                                                                                                                                                                                                                                                                                                                                                                                                                                                                                                                                                                                                                                                                                                                                                                                                                                                                                                                                                                                                                                                                                                                                                                                                                                                                                                                                                                                                                                                                                                                     |
| Configured drives are missing.   | <p>When the ServeRAID controller detects that a previously configured drive is missing, the following message appears:</p> <p>x Online drives not responding where x is the number of drives not responding.</p> <p>Example of a possible message:<br/>Online Drive on Channel 3 SCSI ID 3 is not responding.</p> | <p>Press one of the following keys:</p> <p><b>F2</b> Detailed description. Press this key for a detailed description of the problem, such as the example message above.</p> <p><b>F4</b> Retry. Press this key after correcting a problem. For example, press F4 after you turn on the external storage enclosure that contains the physical drive.</p> <p><b>F5</b> Change the configuration and set the drives to defunct. Press this key to accept the new state that the ServeRAID controller will assign to the drive. For example, the ServeRAID controller will assign the drive a state of defunct or empty.</p> <p>You can also press F5 when you must remove a drive. RAID level-1 and RAID level-5 logical drives are present, and performance in a degraded mode is acceptable. The ServeRAID controller will assign the drive a state of defunct, but the server can complete startup. However, the array will remain in Critical mode and the potential for data loss will exist until you replace and rebuild the defunct drive. To prevent the loss of data, replace and rebuild the defunct drive in a timely manner.</p> <p><b>Note:</b> A physical drive in the defunct state does not necessarily mean that you need to replace the drive. Before you replace the drive, ensure that:</p> <ol style="list-style-type: none"> <li>1. All cables are connected properly to the backplane and to the physical drive. Also, ensure that all cables inside the server are connected properly.</li> <li>2. The hot-swap drive trays are seated properly in the drive bay.</li> <li>3. If you are certain the physical drive is not defective, try rebuilding the drive if you have not already done so. See "Rebuilding a defunct drive" on page 136 for more information.</li> </ol> <p>After you perform these steps, if the physical drive does not function properly, replace the drive.</p> <p><b>F10</b> Continue starting without changing the configuration. Press this key to continue without change to the configuration.</p> |

| Message                                                                           | Explanation                                                                                                                                                                                                                                                                                                                                                                                                                                                                       | Action                                                                                                                                                                                                                                                                                                                                                                                                                                                                                                                                                                                                                                                                                                                                                                                                                                                                                                                                                                                                                                                                                                                                                                                                                                                                                                                                                                                                                                                                                                                                                                                                                                                                                                                                                                                                                                                                                                                  |
|-----------------------------------------------------------------------------------|-----------------------------------------------------------------------------------------------------------------------------------------------------------------------------------------------------------------------------------------------------------------------------------------------------------------------------------------------------------------------------------------------------------------------------------------------------------------------------------|-------------------------------------------------------------------------------------------------------------------------------------------------------------------------------------------------------------------------------------------------------------------------------------------------------------------------------------------------------------------------------------------------------------------------------------------------------------------------------------------------------------------------------------------------------------------------------------------------------------------------------------------------------------------------------------------------------------------------------------------------------------------------------------------------------------------------------------------------------------------------------------------------------------------------------------------------------------------------------------------------------------------------------------------------------------------------------------------------------------------------------------------------------------------------------------------------------------------------------------------------------------------------------------------------------------------------------------------------------------------------------------------------------------------------------------------------------------------------------------------------------------------------------------------------------------------------------------------------------------------------------------------------------------------------------------------------------------------------------------------------------------------------------------------------------------------------------------------------------------------------------------------------------------------------|
| <p>Configured drives are not in the configured location.</p>                      | <p>When the ServeRAID controller detects that a previously configured drive is present, but the drive is in a new location, the following message appears:</p> <p>x Online drive has been rearranged where x is the number of drives that have been rearranged.</p> <p>For example:</p> <p>Examples of possible messages are:</p> <p>Online Drive on Channel 3 SCSI ID 4 moved to Channel 3 SCSI ID 3</p> <p>Online Drive on Channel 3 SCSI ID 3 moved to Channel 3 SCSI ID 4</p> | <p>Press one of the following keys:</p> <p><b>F2</b> Detailed description. Press this key for a detailed description of the problem, such as the example messages above.</p> <p><b>F4</b> Retry. Press this key after correcting a problem. For example, press F4 after you move the physical drive to its previously assigned location.</p> <p><b>F5</b> Change the configuration and set the drive to defunct. Press this key to accept the new state that the ServeRAID controller will assign to the drive. For example, the ServeRAID controller will assign the drive a state of defunct or empty.</p> <p><b>Note:</b> A physical drive in the defunct state does not necessarily mean that you need to replace the drive. Before you replace the drive, ensure that:</p> <ol style="list-style-type: none"> <li>1. All cables are connected properly to the backplane and to the physical drive. Also, ensure that all cables inside the server are connected properly.</li> <li>2. The hot-swap drive trays are seated properly in the drive bay.</li> <li>3. If you have not already attempted to rebuild the drive, try rebuilding it. See "Rebuilding a defunct drive" on page 136 for more information.</li> </ol> <p>After you perform these steps, if the physical drive does not function properly, replace the drive.</p> <p><b>F6</b> Change the configuration and accept the rearrangement. Press this key to change the configuration to match the current drive location.</p> <p>You might remove the hot-swap drives from the server for security or maintenance reasons. If you replace the drives but install them in different drive bays, you can press F6 to accept the new locations, and the ServeRAID controller will update the configuration.</p> <p><b>F10</b> Continue startup without changing the configuration. Press this key to continue without change to the configuration.</p> |
| <p>Controller is not responding to commands. No logical drives are installed.</p> | <p>The ServeRAID controller is not operational.</p>                                                                                                                                                                                                                                                                                                                                                                                                                               | <p>Have the system serviced.</p>                                                                                                                                                                                                                                                                                                                                                                                                                                                                                                                                                                                                                                                                                                                                                                                                                                                                                                                                                                                                                                                                                                                                                                                                                                                                                                                                                                                                                                                                                                                                                                                                                                                                                                                                                                                                                                                                                        |
| <p>Error: Cannot disable this controller BIOS.</p>                                | <p>The ServeRAID controller was unable to prevent an extra copy of its BIOS code from being stored on the server. This condition occurs when the server contains multiple ServeRAID controllers.</p>                                                                                                                                                                                                                                                                              | <p>Have the system serviced.</p>                                                                                                                                                                                                                                                                                                                                                                                                                                                                                                                                                                                                                                                                                                                                                                                                                                                                                                                                                                                                                                                                                                                                                                                                                                                                                                                                                                                                                                                                                                                                                                                                                                                                                                                                                                                                                                                                                        |

| <b>Message</b>        | <b>Explanation</b>                                 | <b>Action</b>                                                                                                                        |
|-----------------------|----------------------------------------------------|--------------------------------------------------------------------------------------------------------------------------------------|
| Installation stopped. | The server cannot access the ServeRAID controller. | This is a follow-on message to a preceding message. Follow the Action instructions for the preceding message to resolve the problem. |

| Message                                                                        | Explanation                                                                                                                                                                                                                                                                                                                                                                                                          | Action                                                                                                                                                                                                                                                                                                                                                                                                                                                                                                                                                                                                                                                                                                                                                                                                                                                                                                                                                                                                                                                                                                                                                                                                                                                                                                                                                                                                                                                                                                                                                                                                                                                                                                                                                                                                                                                                                                                                                                                                                                                                                                                                                                                                                                                                                                                                                                                                                                                                                                                                                                                                       |
|--------------------------------------------------------------------------------|----------------------------------------------------------------------------------------------------------------------------------------------------------------------------------------------------------------------------------------------------------------------------------------------------------------------------------------------------------------------------------------------------------------------|--------------------------------------------------------------------------------------------------------------------------------------------------------------------------------------------------------------------------------------------------------------------------------------------------------------------------------------------------------------------------------------------------------------------------------------------------------------------------------------------------------------------------------------------------------------------------------------------------------------------------------------------------------------------------------------------------------------------------------------------------------------------------------------------------------------------------------------------------------------------------------------------------------------------------------------------------------------------------------------------------------------------------------------------------------------------------------------------------------------------------------------------------------------------------------------------------------------------------------------------------------------------------------------------------------------------------------------------------------------------------------------------------------------------------------------------------------------------------------------------------------------------------------------------------------------------------------------------------------------------------------------------------------------------------------------------------------------------------------------------------------------------------------------------------------------------------------------------------------------------------------------------------------------------------------------------------------------------------------------------------------------------------------------------------------------------------------------------------------------------------------------------------------------------------------------------------------------------------------------------------------------------------------------------------------------------------------------------------------------------------------------------------------------------------------------------------------------------------------------------------------------------------------------------------------------------------------------------------------------|
| <p>New controller installed in a configured server or drives are imported.</p> | <p>When the ServeRAID controller detects that the identifiers of the drives do not match the controller configuration information, the following message appears:</p> <p>x Online drive(s) found with mismatch configuration</p> <p>Examples of possible messages:<br/>           Configuration mismatch Channel 1 SCSI ID 0 with Host ID<br/>           Configuration mismatch Channel 2 SCSI ID 0 with Host ID</p> | <p>Press one of the following keys:</p> <p><b>F2</b> Detailed description. Press this key for a detailed description of the problem, such as the example messages above.</p> <p><b>F4</b> Retry. Press this key after correcting the problem. For example, press F4 after you move the physical drive to its previously assigned location, or after you install the original physical drives back in the server.</p> <p><b>F5</b> Change the configuration and set the drive to defunct. Press this key to accept the new state that the ServeRAID controller will assign to the drive. For example, the ServeRAID controller will assign the drive a state of defunct or empty.<br/> <b>Note:</b> A physical drive in the defunct state does not necessarily mean that you need to replace the drive. Before you replace the drive, ensure that:</p> <ol style="list-style-type: none"> <li>1. All cables are connected properly to the backplane or system board, and to the physical drive. Also, ensure that all cables inside the server are connected properly.</li> <li>2. The hot-swap drive trays are seated properly in the drive bay.</li> <li>3. If you have not already attempted to rebuild the drive, try rebuilding it. See “Rebuilding a defunct drive” on page 136 for more information.</li> </ol> <p>After you perform these steps, if the physical drive does not function properly, replace the drive.</p> <p><b>F7</b> Import configuration information from drive. Press this key to restart the server. Press this key to import the configuration information from the drive and to update the configuration information for the ServeRAID controller. This choice is useful when you replace the ServeRAID controller in an existing ServeRAID subsystem.</p> <p>You also might press F7 if you replace a whole set of drives with drives that were configured in another server with a ServeRAID controller.<br/> <b>Note:</b> When you install drives in a server that has no logical drives defined, the F7 choice will not appear. The ServeRAID controller does not contain any logical drives in its factory configuration. Therefore, F7 will not appear. In this case, do the following:</p> <ol style="list-style-type: none"> <li>1. Restart the server and press Ctrl+I to enter the Mini-Configuration program (see “Using the ServeRAID Mini-Configuration program” on page 107).</li> <li>2. Select <b>Advanced Functions</b>.</li> <li>3. Select <b>Copy the Configuration from Drives to the Controller</b> and follow the instructions on the screen.</li> </ol> |

| Message                                                                             | Explanation                                                                                                                                                       | Action                                                                                                                                                                                                                                                                                                                                                                                                                                                                                                                                                                                                                                                                                                        |
|-------------------------------------------------------------------------------------|-------------------------------------------------------------------------------------------------------------------------------------------------------------------|---------------------------------------------------------------------------------------------------------------------------------------------------------------------------------------------------------------------------------------------------------------------------------------------------------------------------------------------------------------------------------------------------------------------------------------------------------------------------------------------------------------------------------------------------------------------------------------------------------------------------------------------------------------------------------------------------------------|
| Recoverable configuration error                                                     | The configuration data stored in NVRAM does not match the configuration data stored in the EEPROM.                                                                | <ol style="list-style-type: none"> <li>1. Press Ctrl+I to access the ServeRAID Mini-Configuration menu. (See “Using the ServeRAID Mini-Configuration program” on page 107 for instructions.)</li> <li>2. Select <b>Advanced Functions</b> from the Main Menu.</li> <li>3. Then, select <b>Copy the Configuration from Drives to the Controller</b>. (See “Using the advanced configuration functions” on page 108 for more information.)</li> </ol>                                                                                                                                                                                                                                                           |
| Unrecoverable configuration error                                                   | The configuration data stored in NVRAM does not match the configuration data stored in the EEPROM.                                                                | <ol style="list-style-type: none"> <li>1. Press Ctrl+I to access the ServeRAID Mini-Configuration menu. (See “Using the ServeRAID Mini-Configuration program” on page 107 for instructions.)</li> <li>2. Select <b>Advanced Functions</b> from the Main Menu.</li> <li>3. Then, select <b>Restore to the Factory Default Settings</b>. (See “Using the advanced configuration functions” on page 108 for more information.)</li> </ol> <p><b>Note:</b> Restoring to factory default settings sets all online drives in array to ready. You must import the configuration from the drives or diskette. Otherwise, you must create a new array, install the operating system, and restore data from backup.</p> |
| WARNING: <b>n</b> logical drives are critical; <b>n</b> logical drives are offline. | One or more physical drives have failed.                                                                                                                          | Replace the defunct drives as soon as possible to prevent data loss.                                                                                                                                                                                                                                                                                                                                                                                                                                                                                                                                                                                                                                          |
| Your server has an error due to a Blocked Logical Drive.                            | One or more logical drives are blocked. A blocked logical drive cannot be accessed. See “Logical drive state descriptions” on page 11 for additional information. | Press F4 to unblock the logical drive, or press F5 to continue without unblocking.                                                                                                                                                                                                                                                                                                                                                                                                                                                                                                                                                                                                                            |

## ServeRAID startup (POST) messages

During power-on self-test (POST), the ServeRAID controller compares the stored configuration information to the configuration that is actually present. If a discrepancy exists, one or more status messages appear after POST completes, but before the operating system loads.

### Notes:

1. When the ServeRAID controller requires your input, a list of function keys will appear below the message.
2. Where the Action information tells you to start the IBM ServeRAID configuration program, insert the *IBM ServeRAID Support* CD into the CD-ROM drive; then, restart the server. The Action column also provides general information about the message.
3. Where *sid* or *ch* appears in these messages, *sid* is the SCSI ID for the device, and *ch* is the channel to which the device is attached.
4. Where *m* or *n* appears in these messages, a number will appear in the actual message.



## ServeRAID ISPR, BCS, and ECS POST error codes

After the ServeRAID POST completes, register information appears on the screen in hexadecimal format, as follows:

Hardware: ISPR=aaaa BCS=bb ECS=cc

ISPR displays the four-digit Interrupt Status Report Register code, BCS displays the Basic Configuration Status Register code, and ECS displays the Extended Configuration Status Register code.

For example:

Controller 1 Slot 5, Status:Not responding properly - Error Code=0B0  
Controller 2 Slot 4, Logical Drive=0, Other=0, Firmware=2.88.10, Status=0k  
Controller 3 Slot 3, Logical Drive=0, Other=0, Firmware=3.60.13, Status=0k  
Controller 4 Slot 2, Logical Drive=1, Other=1, Firmware=1.00.09, Status=0k

If no errors occur:

ISPR (*aaaa*) = EF10

BCS (*bb*) = 0F or 09

ECS (*cc*) = 00

If an error occurs, refer to: "ISPR (Interrupt Status Port Register) codes" for the ISPR error codes and "Basic and Extended Configuration Status Register Codes" on page 132 for the BCS and ECS error codes.

### ISPR (Interrupt Status Port Register) codes

| Code         | Explanation                                                                   | Action                                                                                                                                                                                                                                                                     |
|--------------|-------------------------------------------------------------------------------|----------------------------------------------------------------------------------------------------------------------------------------------------------------------------------------------------------------------------------------------------------------------------|
| 1xxx to 7xxx | The POST detected an internal error.                                          | Have the system serviced.                                                                                                                                                                                                                                                  |
| 2601 to 260B | The POST detected an error with the ServeRAID subsystem.                      | Have the system serviced.                                                                                                                                                                                                                                                  |
| 2610         | The POST detected an error with the ServeRAID controller hardware.            | Have the system serviced.                                                                                                                                                                                                                                                  |
| 2620         | The POST detected that a ServeRAID configuration or hard disk error occurred. | Start the <i>IBM ServeRAID Support CD</i> and view the existing device and configuration information for your ServeRAID subsystem. If you cannot locate and correct the configuration problem or the failing device, or if the problem persists, have the system serviced. |
| 8xxx to Bxxx | The POST detected an error with the SCSI interface.                           | Verify that the SCSI cables are correctly connected and the SCSI termination is set properly for each installed SCSI device.<br><br>If you cannot locate and correct the SCSI problem, or if the problem persists, have the system serviced.                               |

## Basic and Extended Configuration Status Register Codes

| BCS                      | ECS                      | Explanation and possible recovery action                                                                                                                                                                                                                                      |
|--------------------------|--------------------------|-------------------------------------------------------------------------------------------------------------------------------------------------------------------------------------------------------------------------------------------------------------------------------|
| <b>Code not in table</b> | <b>Code not in table</b> | <p><b>Explanation:</b>The ServeRAID controller is not functioning properly.</p> <p><b>Action:</b>Have the system serviced.</p>                                                                                                                                                |
| <b>00</b>                | <b>01</b>                | <p><b>Explanation:</b>Invalid flash configuration.</p> <p><b>Action:</b>Start the <i>IBM ServeRAID Support CD</i> and follow the instructions that appear on the screen.</p> <p>If no instructions appear or if the problem persists, have the system serviced.</p>           |
| <b>00</b>                | <b>02</b>                | <p><b>Explanation:</b>Invalid NVRAM configuration.</p> <p><b>Action:</b>Start the <i>IBM ServeRAID Support CD</i> and follow the instructions that appear on the screen.</p> <p>If no instructions appear or if the problem persists, have the system serviced.</p>           |
| <b>00</b>                | <b>03</b>                | <p><b>Explanation:</b>Invalid flash and NVRAM configuration.</p> <p><b>Action:</b>Start the <i>IBM ServeRAID Support CD</i> and follow the instructions that appear on the screen.</p> <p>If no instructions appear or if the problem persists, have the system serviced.</p> |
| <b>01</b>                | <b>08</b>                | <p><b>Explanation:</b>No configuration was found in drives, or Online/Rebuild drives are not responding.</p> <p><b>Action:</b>Press F4, F5, F7, or F10.</p>                                                                                                                   |
| <b>01</b>                | <b>18</b>                | <p><b>Explanation:</b>No configuration was found in drives, or Online/Rebuild and Hot-Spare/Standby Hot-Spare drives are not responding.</p> <p><b>Action:</b>Press F4, F5, F7, or F10.</p>                                                                                   |
| <b>01</b>                | <b>28</b>                | <p><b>Explanation:</b>No configuration was found in drives, or Online/Rebuild and Ready/Standby drives are not responding.</p> <p><b>Action:</b>Press F4, F5, F7, or F10.</p>                                                                                                 |
| <b>01</b>                | <b>38</b>                | <p><b>Explanation:</b>No configuration was found in drives, or Online/Rebuild, Hot-Spare/Standby Hot-Spare, and Ready/Standby drives are not responding.</p> <p><b>Action:</b>Press F4, F5, F7, or F10.</p>                                                                   |
| <b>01</b>                | <b>48</b>                | <p><b>Explanation:</b>No configuration was found in drives, or Online/Rebuild drives are not responding and unidentified drives were found.</p> <p><b>Action:</b>Press F4, F5, F7, or F10.</p>                                                                                |
| <b>01</b>                | <b>58</b>                | <p><b>Explanation:</b>No configuration was found in drives, or Online/Rebuild and Hot-Spare/Standby Hot-Spare drives are not responding and unidentified drives were found.</p> <p><b>Action:</b>Press F4, F5, F7, or F10.</p>                                                |
| <b>01</b>                | <b>68</b>                | <p><b>Explanation:</b>No configuration was found in drives, or Online/Rebuild and Ready/Standby drives are not responding and unidentified drives were found.</p> <p><b>Action:</b>Press F4, F5, F7, or F10.</p>                                                              |
| <b>01</b>                | <b>78</b>                | <p><b>Explanation:</b>No configuration was found in drives, or Online/Rebuild, Hot-Spare/Standby Hot-Spare, and Ready/Standby drives are not responding and unidentified drives were found.</p> <p><b>Action:</b>Press F4, F5, F7, or F10.</p>                                |

| BCS | ECS | Explanation and possible recovery action                                                                                                                                                                                                                                                                                                                                                                                                                                                                                                                                                                                                                                            |
|-----|-----|-------------------------------------------------------------------------------------------------------------------------------------------------------------------------------------------------------------------------------------------------------------------------------------------------------------------------------------------------------------------------------------------------------------------------------------------------------------------------------------------------------------------------------------------------------------------------------------------------------------------------------------------------------------------------------------|
| 03  | 88  | <p><b>Explanation:</b>A drive was imported from another system and it has valid configuration, and Online/Rebuild drives are not responding.</p> <p><b>Action:</b>Press F4, F5, F7, or F10.</p>                                                                                                                                                                                                                                                                                                                                                                                                                                                                                     |
| 03  | 98  | <p><b>Explanation:</b>A drive was imported from another system and it has valid configuration, and Online/Rebuild and Hot Spare/Standby Hot-Spare drives are not responding.</p> <p><b>Action:</b>Press F4, F5, F7, or F10.</p>                                                                                                                                                                                                                                                                                                                                                                                                                                                     |
| 03  | A8  | <p><b>Explanation:</b>A drive was imported from another system and it has valid configuration, and Online/Rebuild and Ready/Standby drives are not responding.</p> <p><b>Action:</b>Press F4, F5, F7, or F10.</p>                                                                                                                                                                                                                                                                                                                                                                                                                                                                   |
| 03  | B8  | <p><b>Explanation:</b>A drive was imported from another system and it has valid configuration, and Online/Rebuild, Hot-Spare/Standby Hot-Spare, and Ready/Standby drives are not responding.</p> <p><b>Action:</b>Press F4, F5, F7, or F10.</p>                                                                                                                                                                                                                                                                                                                                                                                                                                     |
| 03  | C8  | <p><b>Explanation:</b>A drive was imported from another system and it has valid configuration, and Online/Rebuild drives are not responding and unidentified drives were found.</p> <p><b>Action:</b>Press F4, F5, F7, or F10.</p>                                                                                                                                                                                                                                                                                                                                                                                                                                                  |
| 03  | D8  | <p><b>Explanation:</b>A drive was imported from another system and it has valid configuration, and Online/Rebuild and Hot-Spare/Standby Hot-Spare drives are not responding and unidentified drives were found.</p> <p><b>Action:</b>Press F4, F5, F7, or F10.</p>                                                                                                                                                                                                                                                                                                                                                                                                                  |
| 03  | E8  | <p><b>Explanation:</b>A drive was imported from another system and it has valid configuration, and Online/Rebuild and Ready/Standby drives are not responding and unidentified drives were found.</p> <p><b>Action:</b>Press F4, F5, F7, or F10.</p>                                                                                                                                                                                                                                                                                                                                                                                                                                |
| 03  | F8  | <p><b>Explanation:</b>A drive was imported from another system and it has valid configuration, and Online/Rebuild, Hot-Spare/Standby Hot-Spare, and Ready/Standby drives are not responding and unidentified drives were found.</p> <p><b>Action:</b>Press F4, F5, F7, or F10.</p>                                                                                                                                                                                                                                                                                                                                                                                                  |
| 07  | 00  | <p><b>Explanation:</b>The specified drive is not responding:<br/>(Channel: sid) (x : y)</p> <p>where x is the channel and y is the ID of the drive that is not responding.</p> <p><b>Action:</b> Press F4 or F10. When you warm-start the server, if a "Configuration change error" displays, select F4. Do <i>not</i> select F10. If you do select F10, contact the IBM Personal Computer HelpCenter.</p> <p>To correct the problem:</p> <ol style="list-style-type: none"> <li>1. Download and install the latest version of IBM ServeRAID software. See "Obtaining ServeRAID updates" on page 13 for more information.</li> <li>2. Replace the failed physical drive.</li> </ol> |
| 07  | 08  | <p><b>Explanation:</b>Online/Rebuild drives are not responding.</p> <p><b>Action:</b>Press F4, F5, or F10.</p>                                                                                                                                                                                                                                                                                                                                                                                                                                                                                                                                                                      |
| 07  | 0C  | <p><b>Explanation:</b>Online/Rebuild drives are not responding, and a drive was found at the incorrect SCSI ID.</p> <p><b>Action:</b>Press F4, F5, F6, or F10.</p>                                                                                                                                                                                                                                                                                                                                                                                                                                                                                                                  |

| <b>BCS</b> | <b>ECS</b> | <b>Explanation and possible recovery action</b>                                                                                                                                                                                           |
|------------|------------|-------------------------------------------------------------------------------------------------------------------------------------------------------------------------------------------------------------------------------------------|
| 07         | 18         | <b>Explanation:</b> Online/Rebuild and Hot-Spare/Standby Hot-Spare drives are not responding.<br><b>Action:</b> Press F4, F5, or F10.                                                                                                     |
| 07         | 1C         | <b>Explanation:</b> Online/Rebuild and Hot Spare/Standby Hot-Spare drives are not responding, and a drive was found at the incorrect SCSI ID.<br><b>Action:</b> Press F4, F5, F6, or F10.                                                 |
| 07         | 28         | <b>Explanation:</b> Online/Rebuild and Ready/Standby drives are not responding.<br><b>Action:</b> Press F4, F5, or F10.                                                                                                                   |
| 07         | 2C         | <b>Explanation:</b> Online/Rebuild and Ready/Standby drives are not responding, and a drive was found at the incorrect SCSI ID.<br><b>Action:</b> Press F4, F5, F6, or F10.                                                               |
| 07         | 38         | <b>Explanation:</b> Online/Rebuild, Ready/Standby, and Hot-Spare/Standby Hot-Spare drives are not responding.<br><b>Action:</b> Press F4, F5, or F10.                                                                                     |
| 07         | 3C         | <b>Explanation:</b> Online/Rebuild, Ready/Standby, and Hot-Spare/Standby Hot-Spare drives are not responding, and a drive was found at the incorrect SCSI ID.<br><b>Action:</b> Press F4, F5, F6, or F10.                                 |
| 07         | 48         | <b>Explanation:</b> Online/Rebuild drives are not responding, and unidentified drives were found.<br><b>Action:</b> Press F4, F5, or F10.                                                                                                 |
| 07         | 4C         | <b>Explanation:</b> Online/Rebuild drives are not responding, and a drive was found at the incorrect SCSI ID, and unidentified drives were found.<br><b>Action:</b> Press F4, F5, F6, or F10.                                             |
| 07         | 58         | <b>Explanation:</b> Online/Rebuild and Hot Spare/Standby Hot-Spare drives are not responding, and unidentified drives were found.<br><b>Action:</b> Press F4, F5, or F10.                                                                 |
| 07         | 5C         | <b>Explanation:</b> Online/Rebuild and Hot Spare/Standby Hot-Spare drives are not responding, a drive was found at the incorrect SCSI ID, and unidentified drives were found.<br><b>Action:</b> Press F4, F5, F6, or F10.                 |
| 07         | 68         | <b>Explanation:</b> Online/Rebuild and Ready/Standby drives are not responding, and unidentified drives were found.<br><b>Action:</b> Press F4, F5, or F10.                                                                               |
| 07         | 6C         | <b>Explanation:</b> Online/Rebuild and Ready/Standby drives are not responding, a drive was found at the incorrect SCSI ID, and unidentified drives were found.<br><b>Action:</b> Press F4, F5, F6, or F10.                               |
| 07         | 78         | <b>Explanation:</b> Online/Rebuild, Ready/Standby, and Hot-Spare/Standby Hot-Spare drives are not responding, and unidentified drives were found.<br><b>Action:</b> Press F4, F5, or F10.                                                 |
| 07         | 7C         | <b>Explanation:</b> Online/Rebuild, Ready/Standby, and Hot-Spare/Standby Hot-Spare drives are not responding, a drive was found at the incorrect SCSI ID, and unidentified drives were found.<br><b>Action:</b> Press F4, F5, F6, or F10. |

| <b>BCS</b> | <b>ECS</b> | <b>Explanation and possible recovery action</b>                                                                                      |
|------------|------------|--------------------------------------------------------------------------------------------------------------------------------------|
| <b>09</b>  | <b>00</b>  | <b>Explanation:</b> No error occurred.<br><b>Action:</b> No action is required.                                                      |
| <b>09</b>  | <b>10</b>  | <b>Explanation:</b> Hot-Spare/Standby Hot-Spare drives are not responding.<br><b>Action:</b> Press F4, F5, or F10.                   |
| <b>09</b>  | <b>20</b>  | <b>Explanation:</b> Ready/Standby drives are not responding.<br><b>Action:</b> Press F4, F5, or F10.                                 |
| <b>09</b>  | <b>30</b>  | <b>Explanation:</b> Hot-Spare/Standby Hot-Spare and Ready/Standby drives are not responding.<br><b>Action:</b> Press F4, F5, or F10. |
| <b>0F</b>  | <b>00</b>  | <b>Explanation:</b> No error occurred.<br><b>Action:</b> No action is required.                                                      |
| <b>0F</b>  | <b>10</b>  | <b>Explanation:</b> Hot-Spare/Standby Hot-Spare drives are not responding.<br><b>Action:</b> Press F4, F5, or F10.                   |
| <b>0F</b>  | <b>20</b>  | <b>Explanation:</b> Ready/Standby drives are not responding.<br><b>Action:</b> Press F4, F5, or F10.                                 |
| <b>0F</b>  | <b>30</b>  | <b>Explanation:</b> Hot-Spare/Standby Hot-Spare and Ready/Standby drives are not responding.<br><b>Action:</b> Press F4, F5, or F10. |

---

## Rebuilding a defunct drive

A physical drive is defunct when there is a loss of communication between the controller and the physical drive. This can be caused by any of the following:

- An improperly connected cable, physical drive, or controller
- Loss of power to a drive
- An improperly assembled SCSI channel in an unsupported configuration
- A defective cable, backplane, physical drive, or controller
- Connecting unsupported SCSI devices (such as tape drives) to the same SCSI channel used for an array.

In each case, after the communication problem is resolved, a rebuild operation is required to reconstruct the data for the device in its disk array. The ServeRAID controllers can reconstruct RAID level-1 and RAID level-5 logical drives, but they cannot reconstruct data stored in RAID level-0 logical drives because RAID level-0 is not redundant.

To prevent data-integrity problems, the ServeRAID controllers set the RAID level-0 logical drives in the effected array to blocked during the rebuild operation for RAID level-1 or RAID level-5. After the rebuild operation completes, you can unblock the RAID level-0 logical drives, and access them once again. Remember, however, that the RAID level-0 logical drives might contain damaged data.

**Note:** For logical drives in an IBM ServeRAID Cluster Solution:

- Because shared logical drives can have *only* one logical drive for each array, blocking a RAID level-0 logical drive during a Rebuild operation does *not* apply to shared logical drives.
- Because non-shared logical drives can have *more* than one logical drive for each array, blocking a RAID level-0 logical drive during a Rebuild operation *does* apply to non-shared logical drives.

## Steps for recovering from defunct drives

If the defunct drives are not part of an array, contact your IBM service representative.

If the defunct drives are part of an array, do the following:

- If more than one physical drive in an array is defunct, contact your IBM service representative.
- If a rebuild operation is in progress, wait until the rebuild is complete.
- If a rebuild is not in progress and only one physical drive in the array is defunct, do the following:
  1. Verify the cables, physical drives, and controllers are installed properly.
  2. Attempt to rebuild the defunct physical drive by performing a Hot-Swap Rebuild. Refer to “Rebuilding a hot-swap drive” for instructions.
  3. If the Hot-Swap Rebuild fails, contact your IBM service representative.

## Rebuilding a hot-swap drive

A Hot-Swap Rebuild refers to a Rebuild operation that is started by the ServeRAID controller when it detects that a drive that is part of an array and in the defunct state has been removed and reinserted on the SCSI cable or backplane. The reinsertion of the physical drive, whether it is the same drive or a new drive, will trigger the ServeRAID controller to start the rebuild operation. During the rebuild

operation, the drive being rebuilt is in the rebuild state, and the logical drive remains critical until the rebuild operation has been successfully completed.

On IBM servers, when a hot-spare drive is available, the Rebuild operation begins automatically without the need to replace the failed drive. If more than one drive fails, the Rebuild operation begins rebuilding the *first* failed drive to the hot-spare drive. If you do not know which drive failed first, the rebuild operation can corrupt your data.

To start a Hot-Swap Rebuild, do the following:

1. Reseat the ServeRAID controller and SCSI cables.
2. Without removing the drive completely, gently remove the physical drive from the server, using the handle of the hot-swap tray. If necessary, refer to the documentation that comes with your server on removing a physical drive.
3. Wait 20 seconds to allow the physical drive to completely spin down.

**Note:** When power is removed from a hot-swap drive, the drive immediately parks the heads, locks the actuator in the “landing zone”, and begins spinning down. However, the spinning down of the disk might require up to 20 seconds after power is removed. Do not move the drive while it is spinning down. Moving the drive while it is spinning down might damage the drive.

4. If you are certain there is nothing wrong with the physical drive you removed, gently reinstall the drive into the server. Make sure the drive is completely installed in the backplane connector.

**Note:** It is possible to rebuild a defunct physical drive to an online physical drive that is defective.

Otherwise, replace the physical drive with a new drive that is the same size (or larger) and continue with the Rebuild operation.

---

## Recovering from an incomplete format of a physical drive

During formatting of a physical drive, if the format process is stopped by a system reset, system shut down, power outage, or by some other means, the physical drive becomes inoperable.

To enable the physical drive to communicate with the ServeRAID controller again, do the following:

1. Note the channel of the ServeRAID controller to which the physical drive is connected.
2. Note the SCSI ID of the physical drive.
3. Use the **ipssend format** function to restart the format of the physical drive. The syntax is: **ipssend format** *controller channel sid*

where:

- *controller* is the ServeRAID controller number (1–12)
- *channel* is the channel number for the device (1, 2, 3, or 4)
- *sid* is the SCSI ID for the device (0–15)

After the **format** is complete, the ServeRAID controller will be able to recognize the drive again.

---

## Solving problems in a failover environment

Use these procedures to recover from problems in a failover environment.

### Recovering from a failure in a failover environment

In a failover environment, when the ServeRAID device driver is unable to send a command to the active controller and the active controller does not respond to a reset command, the device driver attempts to failover to the passive controller.

**Note:** Loose cables or defective physical drives will not cause a failover to occur.

### Replacing a controller of a failover pair in non-hot-plug PCI slot

If a failed controller is not in a hot-plug PCI slot, do the following to replace it:

1. Shut down the server.
2. Replace the failed controller.

**Note:** Do not attach the SCSI cables to the new controller.

3. Insert the *IBM ServeRAID Support CD* (or the configuration CD that was included with your server) into the CD-ROM drive; then, turn on the server. The ServeRAID Manager program starts.
4. Initialize the new controller. In the Main Tree, click the first ServeRAID controller that you want to configure.
5. Click **Actions** → **Restore to factory default settings**.
6. If a confirmation window opens, click **Yes**. When the operation is complete, a message displays at the bottom of the window indicating the restore to factory default settings was successful.
7. Configure the new controller for failover. Click  on the tool bar. The Configure controller for clustering window opens.

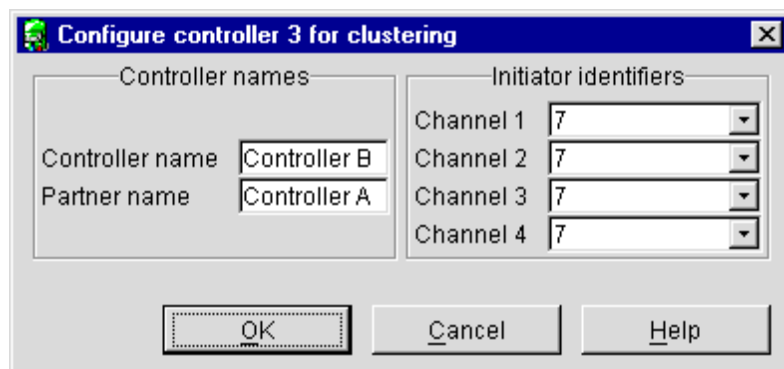

Figure 30. Configure controller for clustering window

8. Fill in the controller name, partner name, and SCSI initiator IDs that you used for the controller you are replacing.
9. Click **OK**.
10. Shut down the server.



11. Connect the expansion enclosure to each of the ServeRAID controllers.

**Important**

When connecting the cables, you must connect the same channel connectors on both ServeRAID controllers to the same expansion enclosure. For example, if you connect the cable from Channel 1 on the first ServeRAID controller to the first expansion enclosure, then you must connect the cable from Channel 1 on the second ServeRAID controller to the first expansion enclosure.

12. Remove the *IBM ServeRAID Support* CD (or the configuration CD that was included with your server) from the CD-ROM drive; then, turn on the server.
13. Start the ServeRAID Manager that is installed on the server and confirm that the ServeRAID controllers are in a failover pairing (see Figure 19 on page 68).

## Replacing a controller of a failover pair in hot-plug PCI slot

If the failed controller is in a hot-plug slot, refer to the documentation that comes with the server for instructions for replacing the controller.

## Recovering from a power failure during a failover

If a power failure occurs during a failover, it is possible the two controllers in the active-passive pair might have the following problems:

- Some logical drives are configured on one controller and some logical drives are configured on the other controller.
- A logical drive does not appear on either controller.

To recover from a power failure, do the following:

1. Run **ipssend merge** for every merge group number configured on the controller that you want to be active in the pair.
2. Run **ipssend unmerge** for every merge group number configured on the controller that you want to be passive in the pair.
3. Shut down and restart the server. Windows NT and Windows 2000 pairs the controllers again.

---

## Troubleshooting an IBM ServeRAID Cluster Solution

There is the possibility that one of the servers, one of the ServeRAID controllers, or one of the hard disk drives in a cluster might fail. This chapter presents procedures you can take to recover from these potential problems. If you still have problems after following these procedures, contact your IBM service representative for further information. Also, you can find hints and tips to help you solve problems on the IBM Support Web site. See "Downloadable files from the World Wide Web" on page 14 for additional information.

## Recovering from a failed ServeRAID server

When replacing a failed server in a high-availability configuration, you might not need to replace the ServeRAID controller. However, if you replace your ServeRAID controller, you must reconfigure the controller after you have installed your new server.

### Important

The following procedure requires specific configuration settings for the ServeRAID controller. If the server and controller that are being replaced are functional, you can obtain these settings from the controller. However, if the controller or the server is not functional, you will need a record of these settings, such as one that was created when the controller was previously configured. If you are replacing your ServeRAID controller with your server, you *must* have correct configuration information to complete this procedure.

Use the following procedure to recover from a failed server:

1. Shut down the failed server.
2. Remove all hard disk drives from the array in the failed server.

As you remove your hard disk drives, be sure to note the bay in which each drive was installed. If you are replacing your failed server with an identical server, you can reinstall the drives in an identical configuration and get your server up and running quickly.
3. If the ServeRAID controller is functional, remove it from the failed server. As you remove the controller from the failed server, be sure to note the following:
  - Which SCSI cables are connected to the SCSI channel connectors on the controller.
  - Which PCI slot has the controller installed.
4. Install the hard disk drives in the new server.

For information on how to install a hard disk drive, see the documentation that comes with your server. If you are replacing the failed server with an identical server, install each hard disk drive in the same bay as the one it was removed from in the failed server.
5. If the ServeRAID controller in the failed server is *not functional*, or you are not sure, continue with “Recovering from a failed ServeRAID controller”. Otherwise, perform the following steps with the functional ServeRAID controller:
  - a. Install the controller in the new server.
  - b. Reinstall the cables as they were in the failed server.
  - c. Start the server.

## Recovering from a failed ServeRAID controller

You must have the following configuration information to configure your new ServeRAID controller:

- SCSI initiator IDs

The SCSI initiator IDs for a non-shared SCSI channel are set to 7 by default. For shared SCSI channels, the initiator IDs must be 7 or 6 and must be different from the SCSI initiator IDs for the corresponding SCSI channels of the cluster partner controller. Therefore, if you can obtain the SCSI initiator IDs for the corresponding cluster partner system, you know the correct SCSI initiator IDs for this system. For example, if the cluster partner system-shared SCSI initiator IDs were set to 7, the controller you are replacing would need to have its SCSI initiator IDs set to 6.

- Controller and partner name

You can also determine the proper settings for the controller name and partner name of the controller being replaced by reading the settings from the cluster partner system.

- Stripe-unit size

The stripe-unit size *must* be the same on both controllers in a high-availability cluster.

- Unattended mode setting

This setting is configured automatically as Enabled when a controller is set up for clustering.

If the ServeRAID controller you are replacing *is* functional, you can obtain the above configuration information by starting your server with the *IBM ServeRAID Support CD* in the CD-ROM drive and using the ServeRAID Manager program. For additional information, refer to the ServeRAID Manager online help.

**Note:** The configuration information is also available in the printable configuration file you might have saved when configuring the ServeRAID controllers for clustering.

If the ServeRAID controller is *not* functional, you will need to refer to a record of the settings that was made when the controller was previously configured. If you do not have a record of the configuration information, refer to “Obtaining the current configuration information” for information that might help you to assign the proper values.

### Obtaining the current configuration information

To obtain the SCSI initiator IDs, controller name, partner name, and stripe-unit size from the corresponding cluster partner controller, do the following:

1. Start the cluster partner system with the *IBM ServeRAID Support CD* in the CD-ROM drive. The ServeRAID Manager program starts.
2. In the Main Tree, click the cluster partner controller.

3. Click  on the tool bar. The Configure controller for clustering window opens.

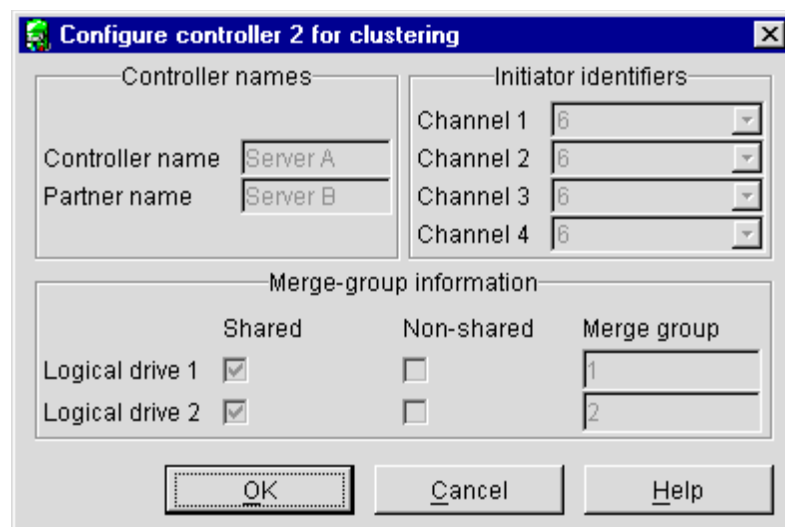

Figure 31. Configure controller for clustering window

- Note the settings in the fields.

### Replacing a ServeRAID controller

Use the following procedure to replace a failed ServeRAID controller in your high-availability configuration:

- Shut down the server.
- Note which SCSI cables are connected to the SCSI channel connectors on the controller.
- Note which PCI slot has the controller installed.
- Remove the failing ServeRAID controller.

For instructions on how to remove and install the ServeRAID controller, see “Step 1: Installing and cabling a ServeRAID controller” on page 15.

- Install the new ServeRAID controller. Be sure to install the controller in the same PCI slot from which you removed the failed ServeRAID controller.

#### Important

- Do *not* reconnect the SCSI channel cables to the controller at this time.
- You must ensure that you have the same level of ServeRAID BIOS and firmware on both controllers in the cluster.

The software is available on the IBM Support Web site. See “Downloadable files from the World Wide Web” on page 14 for additional information.

- Start the system with the *IBM ServeRAID Support CD* (version 4.0, or later) in the CD-ROM drive. The ServeRAID Manager program starts.
- In the Main Tree, click the new controller.
- Click **Actions** → **Restore to factory default settings**. The ServeRAID Manager program initializes the controller configuration.
- With the new controller still selected in the Main Tree, click  on the tool bar. The Configure controller for clustering window opens.

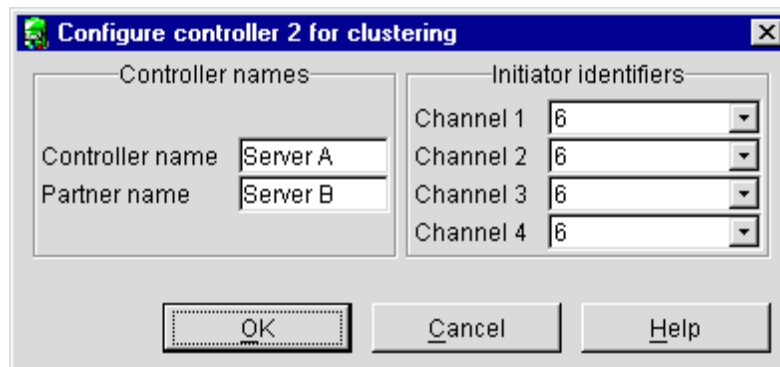

Figure 32. Configure controller for clustering window

- Using the settings that were assigned to the previous ServeRAID controller (that is, the controller you are replacing), fill in each of the following fields:
  - SCSI initiator IDs
  - Controller name
  - Partner name
- Click **OK**. The new controller stripe-unit size setting defaults to 8 KB. If you need to change this setting to match the partner controller, go to step 12 on page 143. Otherwise, go to step 15 on page 143.

12. In the Main Tree, click the new controller.
13. Click **Actions** → **Change stripe-unit size**.
14. Click the new stripe-unit size for your installation.
15. Shut down and turn off the server.
16. Reconnect the SCSI channel cables to the controller.

**Note:** Be sure to connect the cables to the correct SCSI channels as noted in step 2 on page 142.

17. If the ServeRAID controller being replaced attaches to any of the following:
  - The server startup disk array
  - Other non-shared disk arrays
  - Shared arrays which have not failed-over to the other server,

start the system with the *IBM ServeRAID Support* CD (version 4.0, or later) in the CD-ROM drive. The ServeRAID Manager program starts.

If the ServeRAID controller being replaced does not attach to any of these items, go to step 21

18. In the Main Tree, click the new controller.
19. Click **Actions** → **Copy configuration from drives**.
20. Click the merge group number for the non-shared logical drives (that is, 206 or 207).

**Note:** The last number in the merge group number is the shared SCSI initiator ID. That is, if the merge group number is 206, the SCSI initiator ID is 6.

21. Remove the *IBM ServeRAID Support* CD from the CD-ROM drive.
22. Restart your server.

**Note:** If the controller you replaced is the startup controller, the system will now start the operating system properly.

## Recovering from a failover in a Microsoft Cluster Service server

After a failover occurs in a Microsoft Cluster Services server, the red drive lights in the IBM Netfinity EXP10 or IBM Netfinity EXP15 enclosures might turn on for physical drives that are online. There is no hardware problem; the lights turn off within an hour.

## Recovering from a failed server in a ServeRAID cluster

Contact IBM technical support for assistance.

## Troubleshooting ServeRAID subsystems in a cluster environment

Following is a series of common problems and solutions that can help you troubleshoot your IBM ServeRAID Cluster Solution.

| Problem                                                                      | Action                                                                                                                                                                                                                                                                                                                                                                                                                                                                                                                                                                                                                                                                                                                                                                                                                                                                                                                                                                                                                                                                                                                                                                                                                                                                                                                                                                                                                                                                                                                                                                                                                                                                                                                                                                                                                                                                                                                                                                                                                                                                                                                                                 |
|------------------------------------------------------------------------------|--------------------------------------------------------------------------------------------------------------------------------------------------------------------------------------------------------------------------------------------------------------------------------------------------------------------------------------------------------------------------------------------------------------------------------------------------------------------------------------------------------------------------------------------------------------------------------------------------------------------------------------------------------------------------------------------------------------------------------------------------------------------------------------------------------------------------------------------------------------------------------------------------------------------------------------------------------------------------------------------------------------------------------------------------------------------------------------------------------------------------------------------------------------------------------------------------------------------------------------------------------------------------------------------------------------------------------------------------------------------------------------------------------------------------------------------------------------------------------------------------------------------------------------------------------------------------------------------------------------------------------------------------------------------------------------------------------------------------------------------------------------------------------------------------------------------------------------------------------------------------------------------------------------------------------------------------------------------------------------------------------------------------------------------------------------------------------------------------------------------------------------------------------|
| <p>The ServeRAID Manager program shows physical drives in defunct state.</p> | <ol style="list-style-type: none"> <li>1. Enable the <b>View shared drives</b> feature in the ServeRAID Manager program. Doing so displays a drive as reserved, instead of defunct, in the following situations: <ul style="list-style-type: none"> <li>• A drive has been moved.</li> <li>• A drive has failed-over to the other server in the cluster.</li> </ul> <p><b>Note:</b> It is normal for drives in the above situations to display as defunct if you have not enabled the <b>View shared drives</b> feature. In this case, the drives shown in the defunct state are not really defective.</p> </li> <li>2. Check RAID level-1 and RAID level-5 arrays to make sure they are not in critical state. If they are in critical state, replace the failed drive and perform a rebuild operation.</li> </ol>                                                                                                                                                                                                                                                                                                                                                                                                                                                                                                                                                                                                                                                                                                                                                                                                                                                                                                                                                                                                                                                                                                                                                                                                                                                                                                                                    |
| <p>ServeRAID shared logical drives do not failover properly.</p>             | <ol style="list-style-type: none"> <li>1. Ensure that the resource type of each ServeRAID controller shared disk resource is <i>IBM ServeRAID logical disk</i>.<br/>If the resource type is shown as <i>physical drive</i>, the <b>localquorum</b> option was not specified properly when MSCS was installed.<br/>To correct this problem, you must reinstall the high-availability cluster solution using Microsoft Windows NT. Refer to “Chapter 2. Installing and configuring ServeRAID controllers” on page 13 for instructions.</li> <li>2. Ensure that shared SCSI buses on the ServeRAID controller pair are connected in a way that corresponding SCSI channels are connected. For example, SCSI channel 1 on the controller in the first cluster server is connected to SCSI channel 1 on the controller in the second cluster server, channel 2 is connected to channel 2, and so forth.</li> <li>3. Ensure that physical SCSI drives that contain logical drives are all connected to shared SCSI channels.</li> <li>4. Ensure that there are no more than eight shared logical drives defined per pair of ServeRAID controllers.</li> <li>5. Make sure each shared logical drive has a unique merge group number assigned. Shared merge group numbers <i>must</i> be in the range 1–8.</li> <li>6. Make sure each ServeRAID controller has been assigned a unique controller name and that each ServeRAID controller has its partner name assigned properly to correspond to the ServeRAID controller in the other cluster server that is attached to the shared SCSI buses.</li> <li>7. Check for loose shared SCSI bus cables.</li> <li>8. Ensure that SCSI repeater cards in Model 3518 or 3519 expansion enclosures are at the latest revision level. Refer to the <i>IBM Shared Disk Clustering Hardware Reference</i> for more information. See “Related publications” on page xii for information about this publication.</li> <li>9. Ensure that physical drives that are expected to be moved or to failover show up as ready or reserved state on the server that is attempting to take over control of these drives.</li> </ol> |

| Problem                                                                                                                                                                                                                                                                                                                                                                                                                                                                                                                                                                                                                                                                                                                          | Action                                                                                                                                                                                                                                                                                                                                                                                                                                                                                                                                                                                                                                                                                                                                                                                                                                                                                                                                                                                                                                                                                                                                                                                                                                                                                                                        |
|----------------------------------------------------------------------------------------------------------------------------------------------------------------------------------------------------------------------------------------------------------------------------------------------------------------------------------------------------------------------------------------------------------------------------------------------------------------------------------------------------------------------------------------------------------------------------------------------------------------------------------------------------------------------------------------------------------------------------------|-------------------------------------------------------------------------------------------------------------------------------------------------------------------------------------------------------------------------------------------------------------------------------------------------------------------------------------------------------------------------------------------------------------------------------------------------------------------------------------------------------------------------------------------------------------------------------------------------------------------------------------------------------------------------------------------------------------------------------------------------------------------------------------------------------------------------------------------------------------------------------------------------------------------------------------------------------------------------------------------------------------------------------------------------------------------------------------------------------------------------------------------------------------------------------------------------------------------------------------------------------------------------------------------------------------------------------|
| <p>RAID level-5 logical drives cannot be accessed by the operating system after a failover.</p>                                                                                                                                                                                                                                                                                                                                                                                                                                                                                                                                                                                                                                  | <p>Use the ServeRAID Manager program to check the state of the logical drive to ensure that it is not blocked. Using this program, select the logical drive and look for Blocked state <b>Yes</b>. If the logical drive is blocked, make sure all physical drives that are part of the logical drive are in the online state. If all physical drives are <i>not</i> in the online state, a drive might have failed during one of the following situations:</p> <ul style="list-style-type: none"> <li>• A failover</li> <li>• A resynchronization process after a failover</li> </ul> <p>Data integrity cannot be guaranteed in this case and the logical drive has been blocked to prevent the possibility of incorrect data being read from the logical drive.</p> <p>Unblock, reinitialize, and synchronize the logical drive and restore the data from a backup source. Depending on the type of data contained on the logical drive and the availability of a recent backup copy, you can do one of the following:</p> <ul style="list-style-type: none"> <li>• Unblock the drive and continue normal operation.</li> <li>• Replace and rebuild one or more defunct drives.</li> </ul> <p>However, if you do not reinitialize, synchronize, and restore the drive, be aware that some data could be lost or damaged.</p> |
| <p>If one of the cluster servers fails and the surviving server takes over the cluster resources, occasionally one or more of the IP address resources will stay in the online pending state for several minutes after moving over to the surviving server. After this, the resource will go to the Failed state and the following error message will be displayed in the surviving server system log (as viewed with the Event Viewer).</p> <p>For example, the Windows NT Event Log Message:</p> <pre>Date:    ???    Event ID:   1069 Time:    ???    Source:     ClusSvc User:    N/A    Type:       Error Computer: ???    Category:   (4)</pre> <p>Description:<br/>Cluster resource 'ip address resource name' failed</p> | <p>Do the following:</p> <ol style="list-style-type: none"> <li>1. Using the right mouse button, click the IP resource in the Cluster Administrator.</li> <li>2. From the <b>General</b> tab, select <b>Properties</b>.</li> <li>3. Check the box labeled <b>Run this resource in a separate Resource Monitor</b>. A message appears stating that the resource must be restarted for the change to take effect.</li> </ol>                                                                                                                                                                                                                                                                                                                                                                                                                                                                                                                                                                                                                                                                                                                                                                                                                                                                                                    |

| Problem                                                                                                                                                                                                                                                                                                                                                                                                                                                                                                                                                                                                                                                                                                                                                                                                                        | Action                                                                                                                                                                                                                                                                                                                                                                                                                                                                                                                                                                                                |
|--------------------------------------------------------------------------------------------------------------------------------------------------------------------------------------------------------------------------------------------------------------------------------------------------------------------------------------------------------------------------------------------------------------------------------------------------------------------------------------------------------------------------------------------------------------------------------------------------------------------------------------------------------------------------------------------------------------------------------------------------------------------------------------------------------------------------------|-------------------------------------------------------------------------------------------------------------------------------------------------------------------------------------------------------------------------------------------------------------------------------------------------------------------------------------------------------------------------------------------------------------------------------------------------------------------------------------------------------------------------------------------------------------------------------------------------------|
| <p>After one of the cluster servers has been shut down normally and the surviving server takes over the cluster resources, occasionally one or more of the IBM ServeRAID logical drive resources will stay in the online-pending state for several minutes, after moving over to the surviving server (when viewed with the Cluster Administrator). After this, the resource will go to the Failed state and the following error message will be displayed in the surviving server system log (as viewed with the Event Viewer).</p> <p>For example, the Windows NT Event Log Message:</p> <pre>Date:    ???    Event ID:    1069 Time:    ???    Source:    ClusSvc User:    N/A    Type:    Error Computer: ???    Category:    (4)</pre> <p>Description:<br/>Cluster resource 'IBM ServeRAID Logical Disk name' failed.</p> | <p>No action is necessary to bring the resource online after the failover. MSCS will bring this resource online on the surviving server within about four minutes.</p>                                                                                                                                                                                                                                                                                                                                                                                                                                |
| <p>You cannot reinstall the ServeRAID Windows NT Cluster Solution. If a previous version of IBM ServeRAID Cluster Solution has been uninstalled, when attempting to reinstall the IBM ServeRAID Windows NT Cluster solution, a message incorrectly appears prompting you to perform an upgrade.</p>                                                                                                                                                                                                                                                                                                                                                                                                                                                                                                                            | <p>You must delete the <i>C3E76E53-F841-11D0-BFA1-08005AB8ED05</i> registry key. To delete the registry key, do the following:</p> <ol style="list-style-type: none"> <li>1. From the <b>Start</b> menu, click <b>Run</b>.</li> <li>2. Type: REGEDIT and click <b>OK</b>. The Registry Editor window opens.</li> <li>3. Select <b>HKEY_CLASSES_ROOT\CLSID</b> and delete <i>C3E76E53-F841-11D0-BFA1-08005AB8ED05</i>.</li> <li>4. Reinstall the ServeRAID Windows NT Cluster Solution. Refer to "Chapter 7. Configuring ServeRAID controllers for clustering" on page 79 for instructions.</li> </ol> |
| <p>When running the IPSHAHTO program on a server, the following error message appears:<br/>Warning: CONFIG_SYNC with 0xA0 command FAILED on COntröller #</p> <p>and either of the following occurs:</p> <ul style="list-style-type: none"> <li>• One or more hot-spare or standby hot-spare drives are defined on controller pairs.</li> <li>• Ready drives are not part of any logical drive configuration on a controller pair in a cluster.</li> </ul>                                                                                                                                                                                                                                                                                                                                                                      | <p>If all shared drive resources moved successfully when you ran the IPSHAHTO program, it is safe to ignore the error message and no further action is required.</p> <p>However, if shared drive resources <i>failed</i> to move when you ran the IPSHAHTO program, remove all ready drives that are not part of any logical drive configuration on a controller pair in a cluster.</p>                                                                                                                                                                                                               |
| <p>Array identifiers and logical drive numbers might change during a failover condition.</p>                                                                                                                                                                                                                                                                                                                                                                                                                                                                                                                                                                                                                                                                                                                                   | <p>By design, the array identifiers and logical drive numbers might change during a failover condition. Consistency between the merge group numbers and Windows NT or Windows 2000 permanent (sticky) drive letters is maintained, while the ordering process during a failover condition is controlled by the Microsoft Cluster Service software and the available array identifiers on the surviving server.</p>                                                                                                                                                                                    |



---

## Chapter 13. Getting help, service, and information

If you need help, service, technical assistance, or just want more information about IBM products, you will find a wide variety of sources available from IBM to assist you.

For example, IBM maintains pages on the World Wide Web where you can get information about IBM products and services, find the latest technical information, and download device drivers and updates. Some of these pages are:

|                                                                                                                         |                                        |
|-------------------------------------------------------------------------------------------------------------------------|----------------------------------------|
| <a href="http://www.ibm.com">http://www.ibm.com</a>                                                                     | Main IBM home page                     |
| <a href="http://www.ibm.com/pc">http://www.ibm.com/pc</a>                                                               | IBM Personal Computing                 |
| <a href="http://www.ibm.com/pc/support">http://www.ibm.com/pc/support</a>                                               | IBM Personal Computing Support         |
| <a href="http://www.ibm.com/pc/us/ibmpc">http://www.ibm.com/pc/us/ibmpc</a>                                             | IBM Commercial Desktop PCs (U.S.)      |
| <a href="http://www.ibm.com/pc/us/intellistation">http://www.ibm.com/pc/us/intellistation</a>                           | IBM IntelliStation Workstations (U.S.) |
| <a href="http://www.ibm.com/pc/us/accessories">http://www.ibm.com/pc/us/accessories</a>                                 | Options by IBM (U.S.)                  |
| <a href="http://www.ibm.com/pc/us/netfinity">http://www.ibm.com/pc/us/netfinity</a>                                     | IBM Netfinity Servers (U.S.)           |
| <a href="http://www.ibm.com/pc/us/server/sguide">http://www.ibm.com/pc/us/server/sguide</a>                             | IBM ServerGuide (U.S.)                 |
| <a href="http://www.ibm.com/pc/us/netfinity/system_management">http://www.ibm.com/pc/us/netfinity/system_management</a> | IBM Systems Management (U.S.)          |
| <a href="http://www.ibm.com/software/os/warp-server">http://www.ibm.com/software/os/warp-server</a>                     | IBM OS/2 Warp Server                   |
| <a href="http://www.ibm.com/pc/techconnect">http://www.ibm.com/pc/techconnect</a>                                       | IBM TechConnect                        |

You can select a country-specific Web site from these pages.

You might also want to visit the Web pages of other companies for information about other operating systems, software, and accessories. The following are some other Web sites you might find helpful:

<http://www.lotus.com>

<http://www.tivoli.com>

<http://www.microsoft.com>

<http://www.novell.com>

<http://www.sco.com>

<http://www.adaptec.com>

<http://www.apcc.com>

<http://www.norton.com>

Help is also available from bulletin boards and online services, as well as by fax and telephone. This section provides information about these sources.

Services available and telephone numbers listed are subject to change without notice.

---

## Service support

With the original purchase of an IBM hardware product, you have access to extensive support coverage. During the IBM hardware product warranty period, you may call the IBM Personal Computer HelpCenter (1-800-772-2227 in the U.S.) for hardware product assistance covered under the terms of the IBM hardware warranty. See "Getting help by telephone" on page 150 for HelpCenter telephone numbers in other countries.

The following services are available during the warranty period:

- Problem determination - Trained personnel are available to assist you with determining if you have a hardware problem and deciding what action is necessary to fix the problem.
- IBM hardware repair - If the problem is determined to be caused by IBM hardware under warranty, trained service personnel are available to provide the applicable level of service.
- Engineering change management - Occasionally, there might be changes that are required after a product has been sold. IBM or your reseller, if authorized by IBM, will make Engineering Changes (ECs) available that apply to your hardware.

Be sure to retain your proof of purchase to obtain warranty service.

Please have the following information ready when you call:

- Machine Type and Model
- Serial numbers of your IBM hardware products
- Description of the problem
- Exact wording of any error messages
- Hardware and software configuration information

If possible, be at your computer when you call.

The following items are not covered:

- Replacement or use of non-IBM parts or nonwarranted IBM parts

**Note:** All warranted parts contain a 7-character identification in the format IBM FRU XXXXXXX.

- Identification of software problem sources
- Configuration of BIOS as part of an installation or upgrade
- Changes, modifications, or upgrades to device drivers
- Installation and maintenance of network operating systems (NOS)
- Installation and maintenance of application programs

Refer to your IBM hardware warranty for a full explanation of IBM's warranty terms.

---

## Before you call for service

Many computer problems can be solved without outside assistance, by using the online help or by looking in the online or printed documentation that comes with your computer or software. Also, be sure to read the information in any README files that come with your software.

Most computers, operating systems, and application programs come with documentation that contains troubleshooting procedures and explanations of error

messages. The documentation that comes with your computer also contains information about the diagnostic tests you can perform.

If you receive a POST error code when you turn on your computer, refer to the POST error-message charts in your hardware documentation. If you do not receive a POST error code, but suspect a hardware problem, refer to the troubleshooting information in your hardware documentation or run the diagnostic tests.

If you suspect a software problem, consult the documentation (including README files) for the operating system or application program.

---

## Getting customer support and service

Purchasing an IBM PC hardware product entitles you to standard help and support during the warranty period. If you need additional support and services, a wide variety of extended services are available for purchase that address almost any need.

## Using the World Wide Web

On the World Wide Web, the IBM Personal Computing Web site has up-to-date information about IBM Personal Computer products and support. The address for the IBM Personal Computing home page is:

<http://www.ibm.com/pc>

You can find support information for your IBM products, including supported options, on the IBM Personal Computing Support page at:

<http://www.ibm.com/pc/support>

If you select Profile from the support page, you can create a customized support page that is specific to your hardware, complete with Frequently Asked Questions, Parts Information, Technical Hints and Tips, and Downloadable Files. You will have the information you need, all in one place. In addition, you can choose to receive e-mail notifications whenever new information becomes available about your registered products. You also can access online support forums, which are community sites monitored by IBM support staff.

For information about specific Personal Computer products, visit the following pages:

<http://www.ibm.com/pc/us/intellistation>

<http://www.ibm.com/pc/us/ibmpc>

<http://www.ibm.com/pc/us/netfinity>

<http://www.ibm.com/pc/us/thinkpad>

<http://www.ibm.com/pc/us/accessories>

[http://www.direct.ibm.com/content/home/en\\_US/aptiva](http://www.direct.ibm.com/content/home/en_US/aptiva)

You can select a country-specific Web site from these pages.

## Using electronic support services

If you have a modem, you can get help from several popular services. Online information services provide assistance through question-and-answer message areas, live chat rooms, searchable databases, and more.

Technical information is available on a wide range of topics, such as:

- Hardware setup and configuration
- Preinstalled software
- Windows, OS/2, and DOS
- Networking
- Communications
- Multimedia

In addition, the latest device driver updates are available.

Commercial online services, such as America Online (AOL), contain information about IBM products. (For AOL, use the keyword **IBM**.)

## Getting information by fax

If you have a touch-tone telephone and access to a fax machine, in the U.S. and Canada you can receive by fax marketing and technical information on many topics, including hardware, operating systems, and local area networks (LANs). You can call the IBM Automated Fax System 24 hours a day, 7 days a week. Follow the recorded instructions, and the requested information will be sent to your fax machine.

In the U.S. and Canada, to access the IBM Automated Fax System, call 1-800-426-3395.

## Getting help online

Online Housecall is a remote communication tool that allows an IBM technical-support representative to access your PC by modem. Many problems can be remotely diagnosed and corrected quickly and easily. In addition to a modem, a remote-access application program is required. This service is not available for servers. There might be a charge for this service, depending on the request.

For more information about configuring your PC for Online Housecall:

- In the U.S., call 1-800-772-2227.
- In Canada, call 1-800-565-3344.
- In all other countries, contact your IBM reseller or IBM marketing representative.

## Getting help by telephone

During the warranty period, you can get help and information by telephone through the IBM PC HelpCenter. Expert technical-support representatives are available to assist you with questions you might have on the following:

- Setting up your computer and IBM monitor
- Installing and setting up IBM options purchased from IBM or an IBM reseller
- 30-day, preinstalled-operating-system support
- Arranging for service (on-site or carry-in)
- Arranging for overnight shipment of customer-replaceable parts

In addition, if you purchased an IBM PC Server or IBM Netfinity Server, you are eligible for IBM Start Up Support for 90 days after installation. This service provides assistance for:

- Setting up your network operating system
- Installing and configuring interface cards
- Installing and configuring network adapters

Please have the following information ready when you call:

- Machine Type and Model
- Serial numbers of your computer, monitor, and other components, or your proof of purchase
- Description of the problem
- Exact wording of any error messages
- Hardware and software configuration information for your system

If possible, be at your computer when you call.

In the U.S. and Canada, these services are available 24 hours a day, 7 days a week. In the U.K., these services are available Monday through Friday, from 9:00 a.m. to 6:00 p.m.<sup>3</sup>

| Country                |                        | Telephone number |
|------------------------|------------------------|------------------|
| Austria                | Österreich             | 1-546 585 075    |
| Belgium - Dutch        | Belgie                 | 02-717-2504      |
| Belgium - French       | Belgique               | 02-717-2503      |
| Canada                 | Canada                 | 1-800-565-3344   |
| Denmark                | Danmark                | 03-525-6905      |
| Finland                | Suomi                  | 9-22-931805      |
| France                 | France                 | 01-69-32-40-03   |
| Germany                | Deutschland            | 069-6654-9003    |
| Ireland                | Ireland                | 01-815-9207      |
| Italy                  | Italia                 | 02-4827-5003     |
| Luxembourg             | Luxembourg             | 298-977-5060     |
| Netherlands            | Nederland              | 020-504-0531     |
| Norway                 | Norge                  | 2-305-3203       |
| Portugal               | Portugal               | 01-791-5147      |
| Spain                  | España                 | 091-662-4270     |
| Sweden                 | Sverige                | 08-632-0063      |
| Switzerland - German   | Schweiz                | 01-212-1810      |
| Switzerland - French   | Suisse                 | 022-310-0418     |
| Switzerland - Italian  | Svizzera               | 091-971-0523     |
| United Kingdom         | United Kingdom         | 01475-555555     |
| U.S.A. and Puerto Rico | U.S.A. and Puerto Rico | 1-800-772-2227   |

In all other countries, contact your IBM reseller or IBM marketing representative.

## Getting help around the world

If you travel with your computer or need to move it to another country, you can register for International Warranty Service. When you register with the International Warranty Service Office, you will receive an International Warranty Service Certificate that is honored virtually worldwide, wherever IBM or IBM resellers sell and service IBM PC products.

---

<sup>3</sup> Response time will vary depending on the number and complexity of incoming calls.

For more information or to register for International Warranty Service:

- In the U.S. or Canada, call 1-800-497-7426.
- In Europe, call 44-1475-893638 (Greenock, U.K.).
- In Australia and New Zealand, call 61-2-9354-4171.

In all other countries, contact your IBM reseller or IBM marketing representative.

---

## Purchasing additional services

During and after the warranty period, you can purchase additional services, such as support for IBM and non-IBM hardware, operating systems, and application programs; network setup and configuration; upgraded or extended hardware repair services; and custom installations. Service availability and name might vary by country.

## Enhanced PC support line

Enhanced PC Support is available for desktop and mobile IBM computers that are not connected to a network. Technical support is provided for IBM computers and IBM or non-IBM options, operating systems, and application programs on the Supported Products list.

This service includes technical support for:

- Installing and configuring your out-of-warranty IBM computer
- Installing and configuring non-IBM options in IBM computers
- Using IBM operating systems in IBM and non-IBM computers
- Using application programs and games
- Tuning performance
- Installing device drivers remotely
- Setting up and using multimedia devices
- Identifying system problems
- Interpreting documentation

You can purchase this service on a per-call basis, as a multiple-incident package, or as an annual contract with a 10-incident limit. For more information about purchasing Enhanced PC Support, see “Ordering support line services” on page 153.

## 900-number operating system and hardware support line

In the U.S., if you prefer to obtain technical support on a pay-as-you-go basis, you can use the 900-number support line. The 900-number support line provides support for IBM PC products that are out of the warranty period.

To access this support, call 1-900-555-CLUB (2582). You will be notified of the charge per minute.

## Network and server support line

Network and Server Support is available for simple or complex networks made up of IBM servers and workstations using major network operating systems. In addition, many popular non-IBM adapters and network interface cards are supported.

This service includes all of the features of the Enhanced PC Support Line, plus:

- Installing and configuring client workstations and servers
- Identifying system problems and correcting problems on the client or the server

- Using IBM and non-IBM network operating systems
- Interpreting documentation

You can purchase this service on a per-call basis, as a multiple-incident package, or as an annual contract with a 10-incident limit. For more information about purchasing Network and Server Support, see “Ordering support line services”.

## Ordering support line services

Enhanced PC Support Line and Network and Server Support Line services are available for products on the Supported Products list. To receive a Supported Products list:

- In the U.S.:
  1. Call 1-800-426-3395.
  2. Select document number 11683 for Network and Server support.
  3. Select document number 11682 for Enhanced PC support.
- In Canada, contact IBM Direct at 1-800-465-7999, or:
  1. Call 1-800-465-3299.
  2. Select the HelpWare catalog.
- In all other countries, contact your IBM reseller or IBM marketing representative.

For more information or to purchase these services:

- In the U.S., call 1-800-772-2227.
- In Canada, call 1-800-465-7999.
- In all other countries, contact your HelpCenter.

## Warranty and repair services

You can upgrade your standard hardware warranty service or extend the service beyond the warranty period.

Warranty upgrades in the U.S. include:

- Carry-in service to on-site service  
If your warranty provides carry-in repair service, you can upgrade to on-site repair service, either standard or premium. The standard upgrade provides a trained servicer within the next business day (9 a.m. to 5 p.m., local time, Monday through Friday). The premium upgrade provides 4-hour average response, 24 hours a day, 7 days a week.
- On-site service to premium on-site service  
If your warranty provides for on-site service, you can upgrade to premium on-site service (4-hour average on-site response, 24 hours a day, 7 days a week).

You also can extend your warranty. Warranty and Repair Services offers a variety of post-warranty maintenance options, including ThinkPad EasyServ Maintenance Agreements. Availability of the services varies by product.

For more information about warranty upgrades and extensions:

- In the U.S., call 1-800-426-4968.
- In Canada, call 1-800-465-7999.
- In all other countries, contact your IBM reseller or IBM marketing representative.

---

## Ordering publications

Additional publications are available for purchase from IBM. For a list of publications available in your country:

- In the U.S., Canada, and Puerto Rico, call 1-800-879-2755.
- In other countries, contact your IBM reseller or IBM marketing representative.



---

## Appendix. Product warranties and notices

This chapter contains warranty and emission notices. It also contains trademarks and general-information notices.

---

### Warranty Statements

The warranty statements consist of two parts: Part 1 and Part 2. Part 1 varies by country. Part 2 is the same for all countries. Be sure to read both the Part 1 that applies to your country and Part 2.

- **United States, Puerto Rico, and Canada (Z125-4753-05 11/97)**  
("Part 1 - General Terms")
- **Worldwide except Canada, Puerto Rico, Turkey, and United States (Z125-5697-01 11/97)**  
("Part 1 - General Terms" on page 158)
- **Worldwide Country-Unique Terms**  
("Part 2 - Worldwide Country-Unique Terms" on page 160)

### IBM Statement of Limited Warranty for United States, Puerto Rico, and Canada (Part 1 - General Terms)

This Statement of Limited Warranty includes Part 1 - General Terms and Part 2 - Country-unique Terms. **The terms of Part 2 may replace or modify those of Part 1.**The warranties provided by IBM in this Statement of Limited Warranty apply only to Machines you purchase for your use, and not for resale, from IBM or your reseller. The term "Machine" means an IBM machine, its features, conversions, upgrades, elements, or accessories, or any combination of them. The term "Machine" does not include any software programs, whether pre-loaded with the Machine, installed subsequently or otherwise. Unless IBM specifies otherwise, the following warranties apply only in the country where you acquire the Machine. Nothing in this Statement of Warranty affects any statutory rights of consumers that cannot be waived or limited by contract. If you have any questions, contact IBM or your reseller.

#### Machine - IBM ServeRAID-4H Ultra160 SCSI Controller

#### Warranty Period\* - Three Years

\*Contact your place of purchase for warranty service information. Some IBM Machines are eligible for On-site warranty service depending on the country where service is performed.

**The IBM Warranty for Machines** IBM warrants that each Machine 1) is free from defects in materials and workmanship and 2) conforms to IBM's Official Published Specifications. The warranty period for a Machine is a specified, fixed period commencing on its Date of Installation. The date on your sales receipt is the Date of Installation, unless IBM or your reseller informs you otherwise.

During the warranty period IBM or your reseller, if approved by IBM to provide warranty service, will provide repair and exchange service for the Machine, without charge, under the type of service designated for the Machine and will manage and install engineering changes that apply to the Machine.

If a Machine does not function as warranted during the warranty period, and IBM or your reseller are unable to either 1) make it do so or 2) replace it with one that is at least functionally equivalent, you may return it to your place of purchase and your money will be refunded. The replacement may not be new, but will be in good working order.

**Extent of Warranty** The warranty does not cover the repair or exchange of a Machine resulting from misuse, accident, modification, unsuitable physical or operating environment, improper maintenance by you, or failure caused by a product for which IBM is not responsible. The warranty is voided by removal or alteration of Machine or parts identification labels.

**THESE WARRANTIES ARE YOUR EXCLUSIVE WARRANTIES AND REPLACE ALL OTHER WARRANTIES OR CONDITIONS, EXPRESS OR IMPLIED, INCLUDING, BUT NOT LIMITED TO, THE IMPLIED WARRANTIES OR CONDITIONS OF MERCHANTABILITY AND FITNESS FOR A PARTICULAR PURPOSE. THESE WARRANTIES GIVE YOU SPECIFIC LEGAL RIGHTS AND YOU MAY ALSO HAVE OTHER RIGHTS WHICH VARY FROM JURISDICTION TO JURISDICTION. SOME JURISDICTIONS DO NOT ALLOW THE EXCLUSION OR LIMITATION OF EXPRESS OR IMPLIED WARRANTIES, SO THE ABOVE EXCLUSION OR LIMITATION MAY NOT APPLY TO YOU. IN THAT EVENT, SUCH WARRANTIES ARE LIMITED IN DURATION TO THE WARRANTY PERIOD. NO WARRANTIES APPLY AFTER THAT PERIOD.**

**Items Not Covered by Warranty** IBM does not warrant uninterrupted or error-free operation of a Machine.

Unless specified otherwise, IBM provides non-IBM machines **WITHOUT WARRANTIES OF ANY KIND.**

Any technical or other support provided for a Machine under warranty, such as assistance via telephone with "how-to" questions and those regarding Machine set-up and installation, will be provided **WITHOUT WARRANTIES OF ANY KIND.**

**Warranty Service** To obtain warranty service for the Machine, contact your reseller or IBM. In the United States, call IBM at 1-800-772-2227. In Canada, call IBM at 1-800-565-3344. You may be required to present proof of purchase.

IBM or your reseller provides certain types of repair and exchange service, either at your location or at a service center, to keep Machines in, or restore them to, conformance with their Specifications. IBM or your reseller will inform you of the available types of service for a Machine based on its country of installation. IBM may repair the failing Machine or exchange it at its discretion.

When warranty service involves the exchange of a Machine or part, the item IBM or your reseller replaces becomes its property and the replacement becomes yours. You represent that all removed items are genuine and unaltered. The replacement may not be new, but will be in good working order and at least functionally equivalent to the item replaced. The replacement assumes the warranty service status of the replaced item.

Any feature, conversion, or upgrade IBM or your reseller services must be installed on a Machine which is 1) for certain Machines, the designated, serial-numbered Machine and 2) at an engineering-change level compatible with the feature, conversion, or upgrade. Many features, conversions, or upgrades involve the

removal of parts and their return to IBM. A part that replaces a removed part will assume the warranty service status of the removed part.

Before IBM or your reseller exchanges a Machine or part, you agree to remove all features, parts, options, alterations, and attachments not under warranty service.

You also agree to

1. ensure that the Machine is free of any legal obligations or restrictions that prevent its exchange;
2. obtain authorization from the owner to have IBM or your reseller service a Machine that you do not own; and
3. where applicable, before service is provided
  - a. follow the problem determination, problem analysis, and service request procedures that IBM or your reseller provides,
  - b. secure all programs, data, and funds contained in a Machine,
  - c. provide IBM or your reseller with sufficient, free, and safe access to your facilities to permit them to fulfill their obligations, and
  - d. inform IBM or your reseller of changes in a Machine's location.

IBM is responsible for loss of, or damage to, your Machine while it is 1) in IBM's possession or 2) in transit in those cases where IBM is responsible for the transportation charges.

Neither IBM nor your reseller is responsible for any of your confidential, proprietary or personal information contained in a Machine which you return to IBM or your reseller for any reason. You should remove all such information from the Machine prior to its return.

**Production Status** Each IBM Machine is manufactured from new parts, or new and used parts. In some cases, the Machine may not be new and may have been previously installed. Regardless of the Machine's production status, IBM's appropriate warranty terms apply.

**Limitation of Liability** Circumstances may arise where, because of a default on IBM's part or other liability, you are entitled to recover damages from IBM. In each such instance, regardless of the basis on which you are entitled to claim damages from IBM (including fundamental breach, negligence, misrepresentation, or other contract or tort claim), IBM is liable for no more than

1. damages for bodily injury (including death) and damage to real property and tangible personal property; and
2. the amount of any other actual direct damages, up to the greater of U.S. \$100,000 (or equivalent in local currency) or the charges (if recurring, 12 months' charges apply) for the Machine that is the subject of the claim.

This limit also applies to IBM's suppliers and your reseller. It is the maximum for which IBM, its suppliers, and your reseller are collectively responsible.

**UNDER NO CIRCUMSTANCES IS IBM LIABLE FOR ANY OF THE FOLLOWING: 1) THIRD-PARTY CLAIMS AGAINST YOU FOR DAMAGES (OTHER THAN THOSE UNDER THE FIRST ITEM LISTED ABOVE); 2) LOSS OF, OR DAMAGE TO, YOUR RECORDS OR DATA; OR 3) SPECIAL, INCIDENTAL, OR INDIRECT DAMAGES OR FOR ANY ECONOMIC CONSEQUENTIAL DAMAGES (INCLUDING LOST PROFITS OR SAVINGS), EVEN IF IBM, ITS SUPPLIERS OR YOUR RESELLER IS INFORMED OF THEIR POSSIBILITY. SOME**

**JURISDICTIONS DO NOT ALLOW THE EXCLUSION OR LIMITATION OF INCIDENTAL OR CONSEQUENTIAL DAMAGES, SO THE ABOVE LIMITATION OR EXCLUSION MAY NOT APPLY TO YOU.**

## **IBM Statement of Warranty Worldwide except Canada, Puerto Rico, Turkey, United States (Part 1 – General Terms)**

This Statement of Warranty includes Part 1 - General Terms and Part 2 - Country-unique Terms. ***The terms of Part 2 may replace or modify those of Part 1.*** The warranties provided by IBM in this Statement of Warranty apply only to Machines you purchase for your use, and not for resale, from IBM or your reseller. The term "Machine" means an IBM machine, its features, conversions, upgrades, elements, or accessories, or any combination of them. The term "Machine" does not include any software programs, whether pre-loaded with the Machine, installed subsequently or otherwise. Unless IBM specifies otherwise, the following warranties apply only in the country where you acquire the Machine. Nothing in this Statement of Warranty affects any statutory rights of consumers that cannot be waived or limited by contract. If you have any questions, contact IBM or your reseller.

### **Machine - IBM ServeRAID-4H Ultra160 SCSI Controller**

#### **Warranty Period\* - Three Years**

\*Contact your place of purchase for warranty service information. Some IBM Machines are eligible for On-site warranty service depending on the country where service is performed.

**The IBM Warranty for Machines** IBM warrants that each Machine 1) is free from defects in materials and workmanship and 2) conforms to IBM's Official Published Specifications. The warranty period for a Machine is a specified, fixed period commencing on its Date of Installation. The date on your sales receipt is the Date of Installation, unless IBM or your reseller informs you otherwise.

During the warranty period IBM or your reseller, if approved by IBM to provide warranty service, will provide repair and exchange service for the Machine, without charge, under the type of service designated for the Machine and will manage and install engineering changes that apply to the Machine.

If a Machine does not function as warranted during the warranty period, and IBM or your reseller are unable to either 1) make it do so or 2) replace it with one that is at least functionally equivalent, you may return it to your place of purchase and your money will be refunded. The replacement may not be new, but will be in good working order.

**Extent of Warranty** The warranty does not cover the repair or exchange of a Machine resulting from misuse, accident, modification, unsuitable physical or operating environment, improper maintenance by you, or failure caused by a product for which IBM is not responsible. The warranty is voided by removal or alteration of Machine or parts identification labels.

**THESE WARRANTIES ARE YOUR EXCLUSIVE WARRANTIES AND REPLACE ALL OTHER WARRANTIES OR CONDITIONS, EXPRESS OR IMPLIED, INCLUDING, BUT NOT LIMITED TO, THE IMPLIED WARRANTIES OR CONDITIONS OF MERCHANTABILITY AND FITNESS FOR A PARTICULAR PURPOSE. THESE WARRANTIES GIVE YOU SPECIFIC LEGAL RIGHTS AND YOU MAY ALSO HAVE OTHER RIGHTS WHICH VARY FROM JURISDICTION TO**

**JURISDICTION. SOME JURISDICTIONS DO NOT ALLOW THE EXCLUSION OR LIMITATION OF EXPRESS OR IMPLIED WARRANTIES, SO THE ABOVE EXCLUSION OR LIMITATION MAY NOT APPLY TO YOU. IN THAT EVENT, SUCH WARRANTIES ARE LIMITED IN DURATION TO THE WARRANTY PERIOD. NO WARRANTIES APPLY AFTER THAT PERIOD.**

**Items Not Covered by Warranty** IBM does not warrant uninterrupted or error-free operation of a Machine.

Unless specified otherwise, IBM provides non-IBM machines **WITHOUT WARRANTIES OF ANY KIND.**

Any technical or other support provided for a Machine under warranty, such as assistance via telephone with "how-to" questions and those regarding Machine set-up and installation, will be provided **WITHOUT WARRANTIES OF ANY KIND.**

**Warranty Service** To obtain warranty service for the Machine, contact your reseller or IBM. You may be required to present proof of purchase.

IBM or your reseller provides certain types of repair and exchange service, either at your location or at a service center, to keep Machines in, or restore them to, conformance with their Specifications. IBM or your reseller will inform you of the available types of service for a Machine based on its country of installation. IBM may repair the failing Machine or exchange it at its discretion.

When warranty service involves the exchange of a Machine or part, the item IBM or your reseller replaces becomes its property and the replacement becomes yours. You represent that all removed items are genuine and unaltered. The replacement may not be new, but will be in good working order and at least functionally equivalent to the item replaced. The replacement assumes the warranty service status of the replaced item.

Any feature, conversion, or upgrade IBM or your reseller services must be installed on a Machine which is 1) for certain Machines, the designated, serial-numbered Machine and 2) at an engineering-change level compatible with the feature, conversion, or upgrade. Many features, conversions, or upgrades involve the removal of parts and their return to IBM. A part that replaces a removed part will assume the warranty service status of the removed part.

Before IBM or your reseller exchanges a Machine or part, you agree to remove all features, parts, options, alterations, and attachments not under warranty service.

You also agree to

1. ensure that the Machine is free of any legal obligations or restrictions that prevent its exchange;
2. obtain authorization from the owner to have IBM or your reseller service a Machine that you do not own; and
3. where applicable, before service is provided
  - a. follow the problem determination, problem analysis, and service request procedures that IBM or your reseller provides,
  - b. secure all programs, data, and funds contained in a Machine,
  - c. provide IBM or your reseller with sufficient, free, and safe access to your facilities to permit them to fulfill their obligations, and
  - d. inform IBM or your reseller of changes in a Machine's location.

IBM is responsible for loss of, or damage to, your Machine while it is 1) in IBM's possession or 2) in transit in those cases where IBM is responsible for the transportation charges.

Neither IBM nor your reseller is responsible for any of your confidential, proprietary or personal information contained in a Machine which you return to IBM or your reseller for any reason. You should remove all such information from the Machine prior to its return.

**Production Status** Each IBM Machine is manufactured from new parts, or new and used parts. In some cases, the Machine may not be new and may have been previously installed. Regardless of the Machine's production status, IBM's appropriate warranty terms apply.

**Limitation of Liability** Circumstances may arise where, because of a default on IBM's part or other liability, you are entitled to recover damages from IBM. In each such instance, regardless of the basis on which you are entitled to claim damages from IBM (including fundamental breach, negligence, misrepresentation, or other contract or tort claim), IBM is liable for no more than

1. damages for bodily injury (including death) and damage to real property and tangible personal property; and
2. the amount of any other actual direct damages, up to the greater of U.S. \$100,000 (or equivalent in local currency) or the charges (if recurring, 12 months' charges apply) for the Machine that is the subject of the claim.

This limit also applies to IBM's suppliers and your reseller. It is the maximum for which IBM, its suppliers, and your reseller are collectively responsible.

**UNDER NO CIRCUMSTANCES IS IBM LIABLE FOR ANY OF THE FOLLOWING: 1) THIRD-PARTY CLAIMS AGAINST YOU FOR DAMAGES (OTHER THAN THOSE UNDER THE FIRST ITEM LISTED ABOVE); 2) LOSS OF, OR DAMAGE TO, YOUR RECORDS OR DATA; OR 3) SPECIAL, INCIDENTAL, OR INDIRECT DAMAGES OR FOR ANY ECONOMIC CONSEQUENTIAL DAMAGES (INCLUDING LOST PROFITS OR SAVINGS), EVEN IF IBM, ITS SUPPLIERS OR YOUR RESELLER IS INFORMED OF THEIR POSSIBILITY. SOME JURISDICTIONS DO NOT ALLOW THE EXCLUSION OR LIMITATION OF INCIDENTAL OR CONSEQUENTIAL DAMAGES, SO THE ABOVE LIMITATION OR EXCLUSION MAY NOT APPLY TO YOU.**

## Part 2 - Worldwide Country-Unique Terms

### ASIA PACIFIC

**AUSTRALIA: The IBM Warranty for Machines:** The following paragraph is added to this Section: The warranties specified in this Section are in addition to any rights you may have under the Trade Practices Act 1974 or other legislation and are only limited to the extent permitted by the applicable legislation.

**Extent of Warranty:** The following replaces the first and second sentences of this Section: The warranty does not cover the repair or exchange of a Machine resulting from misuse, accident, modification, unsuitable physical or operating environment, operation in other than the Specified Operating Environment, improper maintenance by you, or failure caused by a product for which IBM is not responsible.

**Limitation of Liability:** The following is added to this Section: Where IBM is in breach of a condition or warranty implied by the Trade Practices Act 1974, IBM's liability is limited to the repair or replacement of the goods or the supply of

equivalent goods. Where that condition or warranty relates to right to sell, quiet possession or clear title, or the goods are of a kind ordinarily acquired for personal, domestic or household use or consumption, then none of the limitations in this paragraph apply.

**PEOPLE'S REPUBLIC OF CHINA: Governing Law:** The following is added to this Statement: The laws of the State of New York govern this Statement.

**INDIA: Limitation of Liability:** The following replaces items 1 and 2 of this Section:

1. liability for bodily injury (including death) or damage to real property and tangible personal property will be limited to that caused by IBM's negligence;
2. as to any other actual damage arising in any situation involving nonperformance by IBM pursuant to, or in any way related to the subject of this Statement of Warranty, IBM's liability will be limited to the charge paid by you for the individual Machine that is the subject of the claim.

**NEW ZEALAND: The IBM Warranty for Machines:** The following paragraph is added to this Section: The warranties specified in this Section are in addition to any rights you may have under the Consumer Guarantees Act 1993 or other legislation which cannot be excluded or limited. The Consumer Guarantees Act 1993 will not apply in respect of any goods which IBM provides, if you require the goods for the purposes of a business as defined in that Act.

**Limitation of Liability:** The following is added to this Section: Where Machines are not acquired for the purposes of a business as defined in the Consumer Guarantees Act 1993, the limitations in this Section are subject to the limitations in that Act.

### **EUROPE, MIDDLE EAST, AFRICA (EMEA)**

**The following terms apply to all EMEA countries.**

The terms of this Statement of Warranty apply to Machines purchased from an IBM reseller. If you purchased this Machine from IBM, the terms and conditions of the applicable IBM agreement prevail over this warranty statement.

#### **Warranty Service**

If you purchased an IBM Machine in Austria, Belgium, Denmark, Estonia, Finland, France, Germany, Greece, Iceland, Ireland, Italy, Latvia, Lithuania, Luxembourg, Netherlands, Norway, Portugal, Spain, Sweden, Switzerland or United Kingdom, you may obtain warranty service for that Machine in any of those countries from either (1) an IBM reseller approved to perform warranty service or (2) from IBM.

If you purchased an IBM Personal Computer Machine in Albania, Armenia, Belarus, Bosnia and Herzegovina, Bulgaria, Croatia, Czech Republic, Georgia, Hungary, Kazakhstan, Kirghizia, Federal Republic of Yugoslavia, Former Yugoslav Republic of Macedonia (FYROM), Moldova, Poland, Romania, Russia, Slovak Republic, Slovenia, or Ukraine, you may obtain warranty service for that Machine in any of those countries from either (1) an IBM reseller approved to perform warranty service or (2) from IBM.

The applicable laws, Country-unique terms and competent court for this Statement are those of the country in which the warranty service is being provided. However, the laws of Austria govern this Statement if the warranty service is provided in

Albania, Armenia, Belarus, Bosnia and Herzegovina, Bulgaria, Croatia, Czech Republic, Federal Republic of Yugoslavia, Georgia, Hungary, Kazakhstan, Kirghizia, Former Yugoslav Republic of Macedonia (FYROM), Moldova, Poland, Romania, Russia, Slovak Republic, Slovenia, and Ukraine.

**The following terms apply to the country specified:**

**EGYPT: Limitation of Liability:** The following replaces item 2 in this Section: 2. as to any other actual direct damages, IBM's liability will be limited to the total amount you paid for the Machine that is the subject of the claim.

Applicability of suppliers and resellers (unchanged).

**FRANCE: Limitation of Liability:** The following replaces the second sentence of the first paragraph of this Section: In such instances, regardless of the basis on which you are entitled to claim damages from IBM, IBM is liable for no more than: (items 1 and 2 unchanged).

**GERMANY: The IBM Warranty for Machines:** The following replaces the first sentence of the first paragraph of this Section: The warranty for an IBM Machine covers the functionality of the Machine for its normal use and the Machine's conformity to its Specifications.

The following paragraphs are added to this Section: The minimum warranty period for Machines is six months.

In case IBM or your reseller are unable to repair an IBM Machine, you can alternatively ask for a partial refund as far as justified by the reduced value of the unrepaired Machine or ask for a cancellation of the respective agreement for such Machine and get your money refunded.

**Extent of Warranty:** The second paragraph does not apply.

**Warranty Service:** The following is added to this Section: During the warranty period, transportation for delivery of the failing Machine to IBM will be at IBM's expense.

**Production Status:** The following paragraph replaces this Section: Each Machine is newly manufactured. It may incorporate in addition to new parts, re-used parts as well.

**Limitation of Liability:** The following is added to this Section: The limitations and exclusions specified in the Statement of Warranty will not apply to damages caused by IBM with fraud or gross negligence and for express warranty.

In item 2, replace "U.S. \$100,000" with "1.000.000 DEM."

The following sentence is added to the end of the first paragraph of item 2: IBM's liability under this item is limited to the violation of essential contractual terms in cases of ordinary negligence.

**IRELAND: Extent of Warranty:** The following is added to this Section: Except as expressly provided in these terms and conditions, all statutory conditions, including all warranties implied, but without prejudice to the generality of the foregoing all warranties implied by the Sale of Goods Act 1893 or the Sale of Goods and Supply of Services Act 1980 are hereby excluded.



**Limitation of Liability:** The following replaces items one and two of the first paragraph of this Section: 1. death or personal injury or physical damage to your real property solely caused by IBM's negligence; and 2. the amount of any other actual direct damages, up to the greater of Irish Pounds 75,000 or 125 percent of the charges (if recurring, the 12 months' charges apply) for the Machine that is the subject of the claim or which otherwise gives rise to the claim.

Applicability of suppliers and resellers (unchanged).

The following paragraph is added at the end of this Section: IBM's entire liability and your sole remedy, whether in contract or in tort, in respect of any default shall be limited to damages.

**ITALY: Limitation of Liability:** The following replaces the second sentence in the first paragraph: In each such instance unless otherwise provided by mandatory law, IBM is liable for no more than: (item 1 unchanged) 2) as to any other actual damage arising in all situations involving non-performance by IBM pursuant to, or in any way related to the subject matter of this Statement of Warranty, IBM's liability, will be limited to the total amount you paid for the Machine that is the subject of the claim.

Applicability of suppliers and resellers (unchanged).

The following replaces the second paragraph of this Section: Unless otherwise provided by mandatory law, IBM and your reseller are not liable for any of the following: (items 1 and 2 unchanged) 3) indirect damages, even if IBM or your reseller is informed of their possibility.

**SOUTH AFRICA, NAMIBIA, BOTSWANA, LESOTHO AND SWAZILAND:**

**Limitation of Liability:** The following is added to this Section: IBM's entire liability to you for actual damages arising in all situations involving nonperformance by IBM in respect of the subject matter of this Statement of Warranty will be limited to the charge paid by you for the individual Machine that is the subject of your claim from IBM.

**TURKIYE: Production Status:** The following replaces this Section: IBM fulfills customer orders for IBM Machines as newly manufactured in accordance with IBM's production standards.

**UNITED KINGDOM: Limitation of Liability:** The following replaces items 1 and 2 of the first paragraph of this Section: 1. death or personal injury or physical damage to your real property solely caused by IBM's negligence; 2. the amount of any other actual direct damages or loss, up to the greater of Pounds Sterling 150,000 or 125 percent of the charges (if recurring, the 12 months' charges apply) for the Machine that is the subject of the claim or which otherwise gives rise to the claim.

The following item is added to this paragraph: 3. breach of IBM's obligations implied by Section 12 of the Sale of Goods Act 1979 or Section 2 of the Supply of Goods and Services Act 1982.

Applicability of suppliers and resellers (unchanged).

The following is added to the end of this Section: IBM's entire liability and your sole remedy, whether in contract or in tort, in respect of any default will be limited to damages.

**NORTH AMERICA**

**CANADA: Warranty Service:** The following is added to this section: To obtain warranty service from IBM, call **1-800-565-3344**.

**UNITED STATES OF AMERICA: Warranty Service:** The following is added to this section: To obtain warranty service from IBM, call **1-800-772-2227**.

---

## Notices

References in this publication to IBM products, programs, or services do not imply that IBM intends to make these available in all countries in which IBM operates. Any reference to an IBM product, program, or service is not intended to state or imply that only that IBM product, program, or service may be used. Subject to IBM's valid intellectual property or other legally protectable rights, any functionally equivalent product, program, or service may be used instead of the IBM product, program, or service. The evaluation and verification of operation in conjunction with other products, except those expressly designated by IBM, are the responsibility of the user.

IBM may have patents or pending patent applications covering subject matter in this document. The furnishing of this document does not give you any license to these patents. You can send license inquiries, in writing, to:

IBM Director of Licensing  
IBM Corporation  
North Castle Drive  
Armonk, NY 10504-1785  
U.S.A.

This section contains trademarks, electronic emission notices, and other important information.

Any references in this publication to non-IBM Web sites are provided for convenience only and do not in any manner serve as an endorsement of those Web sites. The materials at those Web sites are not part of the materials for this IBM product and use of those Web sites is at your own risk.

## Edition Notice

INTERNATIONAL BUSINESS MACHINES CORPORATION PROVIDES THIS PUBLICATION "AS IS" WITHOUT WARRANTY OF ANY KIND, EITHER EXPRESS OR IMPLIED, INCLUDING, BUT NOT LIMITED TO, THE IMPLIED WARRANTIES OF MERCHANTABILITY OR FITNESS FOR A PARTICULAR PURPOSE. Some jurisdictions do not allow disclaimer of express or implied warranties in certain transactions, therefore, this statement may not apply to you.

This publication could include technical inaccuracies or typographical errors. Changes are periodically made to the information herein; these changes will be incorporated in new editions of the publication. IBM may make improvements and/or changes in the product(s) and/or the program(s) described in this publication at any time.

This publication was developed for products and services offered in the United States of America and the United Kingdom. It is possible that this publication may contain reference to, or information about, IBM products (machines and programs), programming, or services that are not announced in your country. Such references or information must not be construed to mean that IBM intends to announce such IBM products, programming, or services in your country.

Requests for technical information about IBM products should be made to your IBM reseller or IBM marketing representative. No part of this publication may be reproduced or distributed in any form or by any means without prior permission in writing from the International Business Machines Corporation.

**© COPYRIGHT INTERNATIONAL BUSINESS MACHINES CORPORATION, 2000.  
All rights reserved.**

Note to U.S. Government Users — Documentation related to restricted rights — Use, duplication or disclosure is subject to restrictions set forth in GSA ADP Schedule Contract with IBM Corp.

## **Non-IBM Web sites**

Any references in this information to non-IBM Web sites are provided for convenience only and do not in any manner serve as an endorsement of those Web sites. The materials at those Web sites are not part of the materials for this IBM product and use of those Web sites is at your own risk.

## **Year 2000 readiness and instructions**

This is a Year 2000 Readiness Disclosure.

A product is Year 2000 Ready if the product, when used in accordance with its associated documentation, is capable of correctly processing, providing and/or receiving date data within and between the 20th and 21st centuries, provided all other products (for example, software, hardware, and firmware) used with the product properly exchange date data with it.

This IBM PC hardware product has been designed to process four-digit date information correctly within and between the 20th and 21st centuries. If your IBM computer is on when the century changes, you should turn it off and then back on again once, or restart the operating system, to ensure that the internal clock resets itself for the new century.

This IBM PC product cannot prevent errors that might occur if software you use or exchange data with is not ready for the Year 2000. IBM software that comes with this product is Year 2000 Ready. However, software from other companies might come with this IBM PC product. IBM cannot take responsibility for the readiness of that software. You should contact the software developers directly if you wish to verify readiness, understand limitations, or look for any software updates.

To learn more about IBM PC products and the Year 2000, visit our Web site at <http://www.ibm.com/pc/year2000>. The information and tools there can help you with your Year 2000 transition plan, especially if you have multiple IBM PCs. IBM encourages you to check periodically for updated information.

## **Trademarks**

The following terms are trademarks of the IBM Corporation in the United States or other countries or both:

|              |                             |
|--------------|-----------------------------|
| Alert on LAN | OS/2 Warp                   |
| Aptiva       | PC Server                   |
| Chipkill     | PC 300                      |
| DB2          | Predictive Failure Analysis |
| EtherJet     | ServeRAID                   |

HelpCenter  
HelpWare  
IBM  
IntelliStation  
Netfinity  
Netfinity Advanced System Management  
Netfinity Manager  
OS/2

ServerGuide  
ServerProven  
SurePath  
TechConnect  
ThinkPad  
Update Connector  
ValuePoint  
Wake on LAN

Lotus and Domino are trademarks of Lotus Development Corporation in the United States, other countries, or both.

Tivoli and NetView are trademarks of Tivoli Systems Inc. in the United States, other countries, or both.

Intel, MMX, LANDesk, Pentium, Pentium II Xeon, and Pentium III Xeon are trademarks or registered trademarks of Intel Corporation in the United States, other countries, or both.

Microsoft, Windows, and Windows NT are trademarks or registered trademarks of Microsoft Corporation.

UNIX is a registered trademark in the United States and other countries and is licensed exclusively through The Open Group.

Java and all Java-based trademarks and logos are trademarks or registered trademarks of Sun Microsystems, Inc. in the United States, other countries, or both.

Other company, product, and service names may be trademarks or service marks of others.

## Important notes

Processor speeds indicate the internal clock speed of the microprocessor; other factors also affect application performance.

When referring to hard disk drive capacity, MB stands for 1 000 000 bytes and GB stands for 1 000 000 000 bytes. Total user-accessible capacity may vary depending on operating environments.

Maximum internal hard disk drive capacities assume the replacement of any standard hard disk drives and population of all hard disk drive bays with the largest currently supported drives available from IBM.

Unless otherwise stated, IBM makes no representations or warranties with respect to non-IBM products. Support (if any) for the non-IBM products is provided by the third party, not IBM.

Some software may differ from its retail version (if available), and may not include user manuals or all program functionality.

---

## Electronic emission notices

### Federal Communications Commission (FCC) Statement

#### *Federal Communications Commission (FCC) Class A Statement*

**Note:** This equipment has been tested and found to comply with the limits for a Class A digital device, pursuant to Part 15 of the FCC Rules. These limits are designed to provide reasonable protection against harmful interference when the equipment is operated in a commercial environment. This equipment generates, uses, and can radiate radio frequency energy and, if not installed and used in accordance with the instruction manual, may cause harmful interference to radio communications. Operation of this equipment in a residential area is likely to cause harmful interference, in which case the user will be required to correct the interference at his own expense.

Properly shielded and grounded cables and connectors must be used in order to meet FCC emission limits. IBM is not responsible for any radio or television interference caused by using other than recommended cables and connectors or by unauthorized changes or modifications to this equipment. Unauthorized changes or modifications could void the user's authority to operate the equipment.

This device complies with Part 15 of the FCC Rules. Operation is subject to the following two conditions: (1) this device may not cause harmful interference, and (2) this device must accept any interference received, including interference that may cause undesired operation.

### Industry Canada Class A emission compliance statement

#### *Canadian Department of Communications Compliance Statement*

This digital apparatus does not exceed the Class A limits for radio noise emissions from digital apparatus as set out in the interference-causing equipment standard entitled *Digital Apparatus*, ICES-003 of the Department of Communications.

#### *Avis de conformité aux normes du ministère des Communications du Canada*

Cet appareil numérique respecte les limites de bruits radioélectriques applicables aux appareils numériques de Classe A prescrites dans la norme sur le matériel brouiller : *Appareils Numériques*, NMB-003 édictée par le ministre des Communications.

### Australia and New Zealand Class A statement

**Attention:** This is a Class A product. In a domestic environment this product may cause radio interference in which case the user may be required to take adequate measures.

### United Kingdom telecommunications safety requirement

#### **Notice to Customers**

This apparatus is approved under approval number NS/G/1234/J/100003 for indirect connection to public telecommunication systems in the United Kingdom.

## European community directive conformance statement

This product is in conformity with the protection requirements of EC Council Directive 89/336/EEC on the approximation of the laws of the Member States relating to electro-magnetic compatibility.

**Attention:** This is a Class A product. In a domestic environment this product may cause radio interference in which case the user may be required to take adequate measures.

## Taiwan electrical emission statement

警告使用者：  
這是甲類的資訊產品，在居住的環境中使用時，可能會造成射頻干擾，在這種情況下，使用者會被要求採取某些適當的對策。

## Japanese Voluntary Control Council for Interference (VCCI) statement

この装置は、情報処理装置等電波障害自主規制協議会（VCCI）の基準に基づくクラスA情報技術装置です。この装置を家庭環境で使用すると電波妨害を引き起こすことがあります。この場合には使用者が適切な対策を講ずるよう要求されることがあります。

---

# Index

## A

- active-passive mode 62
- Active PCI 17, 18
  - see Hot-plug PCI 17
- adapter xi
  - see also controller xi
- adaptive read-ahead cache mode 123
- Adobe Acrobat Reader xii
- array
  - cluster 82, 83
  - creating 28
    - cluster 83
  - delete 115
  - failover 62, 66
- arrays 1
- auto-synchronization
  - failover 68
- autosync (IPSSSEND) 116

## B

- backup (IPSSSEND) 113, 117
- battery-backup cache 15
  - failover 62
- BCS error codes 131
- BIOS
  - compatibility mode 33
  - failover 61
  - FlashMan 21
  - saving settings 117
  - updates 13
  - updating 21
    - cluster 77
- blocked
  - logical drive 11
  - physical drive
    - failover 68
- built-in spare drive 7

## C

- cables
  - cluster 74
  - failover 62
  - SCSI
    - problems 120
- cache memory 15
- CDs
  - IBM ServeRAID Support 13
  - Microsoft Windows 2000 34
  - Microsoft Windows 2000 Advanced Server 77
  - Microsoft Windows 2000 Datacenter Server 99
  - Microsoft Windows NT Server Enterprise Edition Component 86
  - Novell NetWare 5.0 33
- certify (IPSSSEND) 119
- Class A electronic emission notice 167
- cluster 69

- cluster 69 (*continued*)
  - array 82, 83
  - BIOS
    - updating 77
  - cables 74
  - CD-ROM 74
  - configuration
    - initializing 75
  - controller
    - initializing 81
    - name 105, 141
    - replacing 142
  - controller name 74
  - creating
    - partition 94
    - ServeRAID disk resource 88, 96
  - detailed view (illus.) 70
  - error messages 144
  - failback 73
  - failed controller 140
  - failed server 140, 143
  - failover 73, 143
  - firmware
    - updating 77
  - high-level view (illus.) 70
  - hot-spare drive 74
  - hot-spare physical drive 74, 82, 83
    - ownership 102
  - logical drive 82, 83
    - adding 102
    - Basic Disk 94, 97
    - deleting 89, 98
    - maximum 75
    - merge group number 83, 84
    - migration 75
    - non-shared 75, 136
    - re-creating 89, 98
    - rebuilding 75
    - shared 75, 83, 136
  - merge group number 75
    - viewing 105, 141
  - NVRAM 81
  - partner name
    - viewing 105, 141
  - physical drive
    - ownership 101
  - problems 139
  - quorum drive 74, 83
  - RAID level-1 83
  - RAID level-5 83
  - RAID level-5E 83
  - SCSI initiator ID 74
    - viewing 105, 141
  - shared channel 82, 83
  - standby hot-spare physical drive 82
  - stripe-unit size 74
  - synchronization 75

- cluster 69 (*continued*)
  - updating
    - other server 91
    - ServeRAID 90, 91
  - validating 75, 79, 103
  - write back 75
  - write through 75
- command-line programs 14
- configuration
  - displaying 122
  - initializing
    - cluster 75
  - loading from file 117
  - saving 67, 84, 117
  - summary window 26, 31
- configuration mode 23
  - (illus.) 24
  - custom 27
  - express 26
  - using 25
- configuration program
  - see ServeRAID Manager 22
- contents
  - options box 1
  - package 1
- controller xi, 69
  - configuring 22
    - cluster 80
    - Microsoft Cluster Service 79
    - Novell High Availability Server 79
  - connector locations 15
  - failed
    - cluster 140
  - failover 61, 62
    - recovering from power failure 139
    - replacing in hot-plug PCI slot 139
    - replacing in non-hot-plug PCI slot 138
  - features 15
  - initializing
    - cluster 81
    - failover 63
  - installing 17
    - NetWare 20
  - messages 125
  - monitoring 123
  - name 33
    - cluster 74
  - onboard 62
  - problems 121
  - replacing 142
  - self-test 121
  - shared
    - starting 75
  - startup
    - device drivers 27, 32
- controller name
  - failover 62
- copyld (IPSSSEND) 117
- critical
  - logical drive 11
  - migrating logical drive 11

- critical (*continued*)
  - system logical drive 11
- custom configuration 27

## D

- data loss 17, 120, 136
  - RAID level-0 3
  - RAID level-00 10
- debugging 120
- defunct drive
  - recovering 136
- defunct physical drive 10
- delete (IPSSSEND) 115
- device
  - retrieve information 122
    - microcode version 122
    - serial number 122
    - vendor ID 122
- device drivers 13, 14
  - installing 33
    - after operating system 42
    - Linux 35
    - NetWare 35, 43
    - OpenServer 38, 47
    - OS/2 36, 46
    - UnixWare 39, 47
    - Windows 2000 34, 42
    - Windows NT 4.0 34, 43
    - with operating system 34
  - startup controller 27, 32
- updates 13
- updating 42
  - Linux 44
  - NetWare 43
  - OpenServer 47
  - OS/2 46
  - UnixWare 47
  - Windows 2000 42
  - Windows NT 4.0 43
- devices
  - Windows 2000
    - Hardware Compatibility List 77
    - IBM Server Proven List 77
- devinfo (IPSSSEND) 122
- diskette
  - IBM ServeRAID Command-Line Programs 13
  - IBM ServeRAID Device Drivers 14
  - IBM ServeRAID Device Drivers for SCO Operating Systems - UnixWare HBA and OpenServer
    - BTLD 14
  - IBM ServeRAID Windows NT Cluster Solutions 85, 93
  - see also CDs 13
- DOS, starting IPSSSEND 110
- download
  - see updates 13
- drive cloning 110
- drive letter
  - permanent 88, 96
- drivever (IPSSSEND) 122



## E

- ECS error codes 131
- electronic emission Class A notice 167
- enclosure
  - cluster 69
  - failover 61, 65
- eraseevent (IPSSSEND) 119
- error codes
  - BCS 131
  - ECS 131
  - ISPR 131
- error messages
  - cluster 144
- example
  - RAID level-0 2
  - RAID level-1 4
  - RAID level-10 9
  - RAID level-1E 5
  - RAID level-5 6
  - RAID level-5E 7
  - spanned array 9
- express configuration 26

## F

- failback
  - cluster 73
- failover 61
  - (illus.) 68
  - active-passive mode 62
  - array 62, 66
  - auto-synchronization 68
  - battery-backup cache 62
  - BIOS 61
  - blocked physical drive 68
  - cables 62
  - cluster 73, 143
  - controller 61, 62
    - initializing 63
    - replacing in hot-plug PCI slot 139
    - replacing in non-hot-plug PCI slot 138
  - controller name 62
  - enclosure 61, 65
  - failure 138
  - fault tolerant 61
  - firmware 61
  - hot add 62
  - hot-spare physical drive 62
  - logical drive 66
  - merge group number 62
  - Microsoft Cluster Service 61
  - NVRAM 63
  - partner name 62
  - ready drive 62
  - recovering from power failure 139
  - stripe-unit size 61
  - write-cache mode 62
  - write through 61
- fault tolerant
  - see failover 61
- FCC Class A notice 167

- firmware
  - failover 61
  - FlashMan 21
  - updates 13
  - updating 21
    - cluster 77
- FlashCopy 110
  - autosync 116
  - backup 111, 113, 117
  - copyId 117
  - delete 115
  - import 116
  - init 117
  - map 111
  - nobackup 111, 114
  - restore 117
  - stop all 115
  - synch 118
- FlashMan 21
- format (IPSSSEND) 120, 137

## G

- getbst (IPSSSEND) 120
- getConfig (IPSSSEND) 122
- getevent (IPSSSEND) 120
- getStatus (IPSSSEND) 118

## H

- high-availability cluster solution 69
- hot add 17
  - failover 62
  - NetWare 17
  - Windows 2000 17
- Hot-plug PCI 17
- hot remove 17
  - NetWare 17
  - Windows 2000 17
- hot replace 17
  - ServeRAID Active PCI Hot Replace Wizard 17
- hot-spare physical drive 10
  - cluster 74, 82
    - ownership 102
  - creating 28
  - failover 62
- hot-swap drive
  - rebuilding 136
- hot-swap rebuild feature
  - displaying status 122
  - turning on 122
- hsrebuild (IPSSSEND) 122

## I

- IBM
  - ServeRAID
    - Cluster Solution xii, 14
    - Support CD xii, 13, 14
    - Support Web site 14
    - clustering support 14

- IBM (*continued*)
  - ServeRAID support 14
    - using 14
- import (IPSSSEND) 116
- important notes 166
- information mode 23
  - (illus.) 25
  - using 33
- init (IPSSSEND) 117
- initializing
  - logical drive 117
- installation steps 13
- installing
  - IPSMON
    - NetWare 56
  - IPSSSEND
    - Linux 54
    - NetWare 54
    - OpenServer 55
    - OS/2 54
    - UnixWare 55
    - Windows 2000 54
    - Windows NT 4.0 54
- IPSMON
  - installing 53
    - NetWare 56
  - starting 123
  - using 123
- IPSSSEND
  - certify 119
  - devinfo 122
  - drivever 122
  - eraseevent 119
  - FlashCopy 110
    - autosync 116
    - backup 111, 113, 117
    - copyld 117
    - delete 115
    - import 116
    - init 117
    - map 111
    - nobackup 111, 114
    - restore 117
    - stop all 115
    - synch 118
  - format 120, 137
  - getbst 120
  - getconfig 122
  - getevent 120
  - getstatus 118
  - hsrebuild 122
  - installing 53
    - Linux 54
    - NetWare 54
    - OpenServer 55
    - OS/2 54
    - UnixWare 55
    - Windows 2000 54
    - Windows NT 4.0 54
  - logs
    - clearing 22, 119

- IPSSSEND (*continued*)
  - readahead 123
  - rebuild 118
  - selftest 121
  - setstate 118
  - startdely 121
  - starting 110
  - stripesize 123
  - unattended 123
  - unblock 119
  - using 110
- ISPR error codes 131

## J

- Java
  - Novell 50
  - SCO 52

## L

- LEDs 15
- Linux
  - device drivers 35, 44
  - installing
    - IPSSSEND 54
    - ServeRAID Manager 51
  - Red Hat 35
  - starting
    - IPSSSEND 110
    - ServeRAID Manager 58
    - ServeRAID Manager agent 58
- logical drive 1
  - adding
    - cluster 102
  - blocked 119
  - cluster 82, 83
    - blocked 136
    - deleting 89, 98
    - re-creating 89, 98
  - copying 117
  - creating 30
    - cluster 83
  - critical 118
  - failover 66
  - initializing 117
  - map 111
  - maximum
    - cluster 75
  - migration
    - cluster 75
    - status 118
  - non-shared 75
    - merge group number 84
  - rebuild 118
    - status 118
  - rebuilding
    - cluster 75
  - shared 75, 83
    - disk signatures 94
    - drive letter 95
    - merge group number 83, 84

- logical drive 1 *(continued)*
  - states 11
  - status 118
  - stripe
    - bad 120
  - synchronization
    - RAID level-5 85, 93
    - status 118
  - synchronizing 118
  - volume label 95

## M

- map (IPSSSEND) 111
- merge group number 33
  - cluster 75
  - failover 62
  - logical drive
    - non-shared 84
    - shared 83, 84, 88, 96
- messages
  - controller 125
  - POST 130
  - startup 130
- Microsoft Cluster Service
  - certified 77
  - configuring 93
  - configuring controllers 79
  - failover 61
  - IBM ServeRAID Support CD 14
  - installing
    - ServeRAID Manager 93
    - Windows NT 4.0 85
  - ServeRAID files 14
  - uninstalling 89, 99
  - updating
    - other server 91
    - ServeRAID 90, 91
- migrating logical drive 11
- Mini-configuration program 107
  - Advanced Functions 108
  - Configure BIOS Settings 109
  - Copy the Configuration from Drives to Controller 109
  - Restore to Factory Default Settings 108
  - Setting the Bootable CD-ROM feature 109
  - View Configuration 108
  - View Controller and PCI Information 109
  - View Controller Status 107
- multiserver rollout 110

## N

- NetWare
  - Active PCI 17
  - device drivers 35, 43
  - Hot-plug PCI 17
  - installing
    - controller 20
    - IPSMON 56
    - IPSSSEND 54
    - ServeRAID Manager 50

- NetWare *(continued)*
  - IPSMON 123
  - starting
    - IPSSSEND 110
    - ServeRAID Manager 57
    - web site 50
    - write-cache mode 33
  - nobackup (IPSSSEND) 114
  - non-shared logical drive 84
  - notices
    - Non-IBM Web sites 165
- Novell
  - High Availability Server 79
    - configuring controllers 79
  - Java Virtual Machine 50
  - Vinca High Availability for Novell 79
  - web site 50
- NVRAM
  - cluster 81
  - failover 63

## O

- offline logical drive 11
- okay logical drive 11
- online physical drive 10
- OpenServer
  - device drivers 38, 47
  - installing
    - IPSSSEND 55
    - ServeRAID Manager 52
  - Java Development Kit 52
  - Java Runtime Environment 52
  - starting
    - IPSSSEND 110
    - ServeRAID Manager 58
    - ServeRAID Manager agent 58
- OS/2
  - device drivers 36, 46
  - installing
    - IPSSSEND 54
    - ServeRAID Manager 51
  - IPSSSEND 53
  - starting
    - IPSSSEND 110
    - ServeRAID Manager 57

## P

- package contents 1
- partition
  - cluster 94
  - problems 125
- partition table
  - erasing 117
- partner name 33
  - failover 62
- performance tuning 10
- physical drive
  - cluster
    - ownership 101

- physical drive *(continued)*
  - data loss 120
  - defunct 136
  - delaying 121
  - failure
    - RAID level-0 3
    - RAID level-1 4
    - RAID level-1E 5
    - RAID level-5 7
    - RAID level-5E 8
    - RAID level-x0 10
  - formatting 120
    - recovering from incomplete 137
  - rebuilding 136
  - starting 121
  - states 10
    - changing 118
  - verify media 119
- POST messages 130
- power outage 15
- Predictive Failure Analysis 119, 120
- problems
  - cluster 139
    - controller, replacing 142
    - error messages 144
    - failed controller 140
    - failed server 140, 143
    - failover 143
  - controller 121
  - error codes
    - BCS 131
    - ECS 131
    - ISPR 131
  - failover 138
    - recovering from power failure 139
    - replacing controller in hot-plug PCI slot 139
    - replacing controller in non-hot-plug PCI slot 138
  - messages
    - controller 125
    - POST 130
  - rebuilding defunct drive 136
  - rebuilding hot-swap drives 136
  - recovering from defunct drives 136
  - recovering from incomplete format 137
  - SCSI bus 120
  - SCSI device 120
  - ServeRAID Manager 125
  - solving 125
- program
  - command-line 14
  - FlashMan 21
  - IPSMON 123
    - installing 53
  - IPSSEND 110
    - installing 53
  - Mini-configuration 107
  - ServeRAID Manager 22
  - updates 13
- publications xii

## Q

- quorum drive 74, 83, 87, 96
  - RAID level-1 87

## R

- RAID
  - level
    - performance tuning 10
    - selecting 10
  - level-0 2
    - blocked 119, 136
    - supported number of drives 2
  - level-00 8
    - see RAID level-x0 8
  - level-1 3
    - cluster 83
    - quorum drive 87, 96
    - supported number of drives 5
    - synchronization 75
  - level-1 Enhanced
    - see RAID level-1E 4
  - level-10 8
    - see RAID level-x0 8
  - level-1E 4
  - level-1E0 8
    - see RAID level-x0 8
  - level-5 5
    - cluster 83
    - logical drive 116
    - supported number of drives 6
    - synchronization 85, 93
  - level-5 Enhanced
    - see RAID level-5E 7
  - level-50 8
    - see RAID level-x0 8
  - level-5E 7
    - cluster 83
    - supported number of drives 7
  - level-x0 8
    - supported number of drives 8
  - technology 1
  - read-ahead cache mode 33, 123
  - readahead (IPSSEND) 123
  - README 13
  - ready drive
    - failover 62
  - ready physical drive 11
  - rebuild
    - defunct drive 136
    - physical drive 10
    - rate 33
  - rebuild (IPSSEND) 118
  - Red Hat Linux 35
  - restore (IPSSEND) 117

## S

- scan for new drives 85, 93
- SCO
  - web site 52

## SCSI

- channel 15, 83
- channels
  - shared 82
- initiator ID 33
  - cluster 74
- transfer speed 33
- self-test
  - controller 121
- selftest (IPSSSEND) 121
- ServeRAID
  - Active PCI Hot Replace Wizard 17
  - installation steps 13
  - logs
    - clearing 22
  - Manager 13
    - Active PCI 17
    - Active PCI Hot Replace Wizard 17
    - agent 58
    - configuration mode 23, 24, 25
    - information mode 23, 25, 33
    - installing 49, 50, 51, 52, 93
    - logs 22
    - starting 56, 57, 58
    - using 22
    - validate cluster 75
  - ServeRAID Manager
    - agent
      - starting 58
  - setstate (IPSSSEND) 118
  - shared channel 83
  - shared logical drive 83, 84, 88, 96
    - disk signatures 94
  - software
    - IBM Netfinity Hot Plug for Windows NT 4.0 17
  - spanned array 8, 111
    - creating 28
    - logical drive 10
  - standby hot-spare physical drive 11
    - cluster 82
  - startdely (IPSSSEND) 121
  - startup messages 125, 130
  - stop all (IPSSSEND) 115
  - stripe 2
    - bad 120
  - stripe-unit size 2, 26, 33
    - cluster 74
    - failover 61
    - performance tuning 2
    - ServeRAID-4H 2
    - setting 123
    - stripe 2
  - stripesize (IPSSSEND) 123
  - sub-logical drive 10
  - synch (IPSSSEND) 118
  - synchronization 85, 93
  - synchronize 116
  - system logical drive 11

## T

- tape backup 110, 113
- trademarks 165, 166

## U

- unattended (IPSSSEND) 123
- unattended mode 33, 123
- unlock (IPSSSEND) 119
- United States electronic emission Class A notice 167
- United States FCC Class A notice 167
- UnixWare
  - device drivers 39, 47
  - installing
    - IPSSSEND 55
    - ServeRAID Manager 52
  - starting
    - IPSSSEND 110
    - ServeRAID Manager 58
    - ServeRAID Manager agent 58
- updates 14
  - BIOS 13
  - command-line programs 13
  - device drivers 13
  - firmware 13
  - IBM Support page 13
  - ServeRAID Manager 13
- updating
  - BIOS 91
  - device drivers 91
  - firmware 91
  - other server 91
  - ServeRAID
    - Cluster Solution 90
    - Manager 90
    - software 90
- upgrading
  - IBM ServeRAID Cluster Solution 98

## V

- validate cluster 75, 79, 103
- volume label 95

## W

- web sites
  - IBM Support 14
  - Novell NetWare 50
  - SCO 52
- Windows 2000
  - Active PCI 17
  - Advanced Server CD 77
  - device drivers 34, 42
  - failover 61
  - FlashCopy 110
  - Hardware Compatibility List 77
  - Hot-plug PCI 17
  - IBM Server Proven List 77
  - installing
    - IPSSSEND 54
    - ServeRAID Manager 50
  - Microsoft Cluster Service 93
  - problems
    - ServeRAID Manager 125
  - starting
    - IPSSSEND 110

- Windows 2000 *(continued)*
  - ServeRAID Manager 56
- Windows 95
  - installing ServeRAID Manager 50
- Windows 98
  - installing ServeRAID Manager 50
- Windows NT 4.0
  - Active PCI 17
  - device drivers 34, 43
  - failover 61
  - FlashCopy 110
  - Hot-plug PCI 17
  - IBM Netfinity Hot Plug for Windows NT 4.0
    - package 17
  - installing
    - IPSSSEND 54
    - Microsoft Cluster Service 85
    - ServeRAID Manager 50
  - problems
    - ServeRAID Manager 125
  - starting
    - IPSSSEND 110
    - ServeRAID Manager 56
- write back
  - cluster 75
- write-back mode 15, 115
- write-cache mode 33
  - failover 62
  - NetWare 33
- write through
  - cluster 75
  - failover 61
  - mode 33
    - NetWare 33

## Y

- year 2000 readiness and instructions 165





Part Number: 00N9132



Printed in the United States of America  
on recycled paper containing 10%  
recovered post-consumer fiber.

SC00-N913-20



00N9132

