

IBM® IntelliStation® R Pro



User's Guide

Note

Before using this information and the product it supports, be sure to read the general information in Appendix B, "Warranties and notices," on page 117.

First Edition (April 2001)

© Copyright International Business Machines Corporation 2001. All rights reserved.

US Government Users Restricted Rights – Use, duplication or disclosure restricted by GSA ADP Schedule Contract with IBM Corp.

Contents

Safety information	vii
Chapter 1.Introducing the IntelliStation R Pro	1
Inventory checklist	1
IntelliStation R Pro features and specifications	2
Notices used in this book	3
Software CDs	3
What your IntelliStation R Pro offers	4
Computer controls and indicators	5
Front view	5
Rear view	6
Chapter 2.Arranging your workspace	7
Selecting a location for your computer	7
Comfort	7
Glare and lighting	7
Air circulation	8
Electrical outlets and cable lengths	8
Chapter 3.Operating your computer	9
Installing the operating system	9
Installing and uninstalling the audio adapter device drivers	9
Installing the device drivers for Windows NT 4.0 and Windows 2000	9
Uninstalling the device drivers for Windows NT 4.0 and Windows 2000	10
Turning on your computer	10
Turning off your computer	11
Using video features	12
Video device driver	12
Changing monitor settings	12
Using audio features	13
Line out	13
Line in	13
Mic in	13
MIDI/Joystick	13
Speaker out	13
CD-audio in (ATAPI)	13
CD-audio in (JST)	14
Chapter 4.Configuring your computer	15
Using the Configuration/Setup Utility program	15
Starting the Configuration/Setup Utility program	15
Choices available from the Configuration/Setup main menu	16
Using passwords	20
Using the SCSISelect utility program	22
Starting the SCSISelect utility program	22
Choices available from the SCSISelect menu	22
Using the PXE boot agent utility program	23
Chapter 5.Installing Options	25
Major components of the R Pro computer	25
System board	26
System board options connectors	26
System board LEDs	28
Before you begin	29

System reliability considerations	29
Working inside a computer with the power on	29
Handling static-sensitive devices	30
Safety information	31
Removing the cover	38
Working with adapters	39
Adapter considerations	40
Removing an adapter	40
Installing an adapter	41
Hard disk drives	44
Hard disk drives jumper settings	44
Preinstallation steps	44
Installing or replacing a hard disk drive	45
Memory	46
Installing memory modules	46
Microprocessor	48
Installing the microprocessor	49
Fan assembly replacement	52
Installing the cover	53
I/O connector locations and ports	54
Input/Output ports	54
Working with cables	64
Cabling the RS-485 ports	64
Cable management	65
Chapter 6. Solving Problems	67
Diagnostic tools overview	67
POST	69
POST beep code descriptions	70
POST beep codes	71
POST error messages	73
Event/error logs	81
Small computer system interface messages	81
Diagnostic programs and error messages	82
Text messages	83
Starting the diagnostic programs	84
Viewing the test log	85
Diagnostic error message tables	86
Recovering BIOS	93
Identifying problems using status LEDs	95
Light Path Diagnostics	95
Troubleshooting charts	99
Troubleshooting the audio adapter	103
Troubleshooting the video adapter	103
Troubleshooting an Ethernet controller	104
Ethernet controller messages	106
Replacing the battery	109
Getting information, help, and service	110
Getting information	110
Getting help and service	111
Purchasing additional services	114
Appendix A. Computer records	115
Serial numbers and keys	115

Appendix B. Warranties and notices	117
Warranty Information	117
Warranty Period	117
IBM Statement of Limited Warranty	117
Notices	125
Edition notice	126
Processing date data	126
Trademarks	126
Important notes	127
Electronic emission notices	127
Federal Communications Commission (FCC) Statement	127
Industry Canada Class A emission compliance statement	128
Australia and New Zealand Class A statement	128
United Kingdom telecommunications safety requirement	128
European Union EMC Directive conformance statement	128
Taiwan electrical emission statement	128
Japanese Voluntary Control Council for Interference (VCCI) statement	129
Power cords	129
Index	131

Safety information

Before installing this product, read the Safety Information book.

مجب، يجب قراءة دات السلامة

Antes de instalar este produto, leia o Manual de Informações sobre Segurança.

安装本产品前请先阅读《安全信息》手册。

Prije instalacije ovog proizvoda pročitajte priručnik sa sigurnosnim uputama.

Před instalací tohoto produktu si přečtěte příručku bezpečnostních instrukcí.

Læs hæftet med sikkerhedsforskrifter, før du installerer dette produkt.

Lue Safety Information -kirjanen, ennen kuin asennat tämän tuotteen.

Avant de procéder à l'installation de ce produit, lisez le manuel Safety Information.

Vor Beginn der Installation die Broschüre mit Sicherheitshinweisen lesen.

Πριν εγκαταστήσετε αυτό το προϊόν, διαβάστε το εγχειρίδιο Safety Information.

לפני שתתקינו מוצר זה, קראו את הוראות הבטיחות.

Przed zainstalowaniem tego produktu należy przeczytać broszurę Informacje Dotyczące Bezpieczeństwa.

Prima di installare questo prodotto, leggere l'opuscolo contenente le informazioni sulla sicurezza.

本製品を導入する前に、安全情報資料を御読みください。

이 제품을 설치하기 전에, 안전 정보 책자를 읽어보십시오.

Пред да го инсталирате овој производ прочитајте ја книгата со безбедносни информации.

Lees voordat u dit product installeert eerst het boekje met veiligheidsvoorschriften.

Les heftet om sikkerhetsinformasjon (Safety Information) før du installerer dette produktet.

Prije instalacije ovog proizvoda pročitajte priručnik sa sigurnosnim uputama.

Antes de instalar este produto, leia o folheto Informações sobre Segurança.

Перед установкой продукта прочтите брошюру по технике безопасности (Safety Information).

Pred inštaláciou tohto produktu si prečítajte Informáciu brožúrku o bezpečosti.

Preden namestite ta izdelek, preberite knjižico Varnostne informacije.

Antes de instalar este producto, lea la Información de Seguridad.

Läs säkerhetsinformationen innan du installerar den här produkten.

在安裝本產品之前，也請先閱讀「安全性資訊」小冊子。

Installálás el tt olvassa el a Biztonsági el írások kézikönyvét !

Statement 1



Danger

Electrical current from power, telephone, and communication cables is hazardous.

To avoid a shock hazard:

- **Do not connect or disconnect any cables or perform installation, maintenance, or reconfiguration of this product during an electrical storm.**
- **Connect all power cords to a properly wired and grounded electrical outlet.**
- **Connect to properly wired outlets any equipment that will be attached to this product.**
- **When possible, use one hand only to connect or disconnect signal cables.**
- **Never turn on any equipment when there is evidence of fire, water, or structural damage.**
- **Disconnect the attached power cords, telecommunications systems, networks, and modems before you open the device covers, unless instructed otherwise in the installation and configuration procedures.**
- **Connect and disconnect cables as described in the following table when installing, moving, or opening covers on this product or attached devices.**

To connect:

1. Turn everything OFF.
2. First, attach all cables to devices.
3. Attach signal cables to connectors.
4. Attach power cords to outlet.
5. Turn device ON.

To disconnect:

1. Turn everything OFF.
2. First, remove power cords from outlet.
3. Remove signal cables from connectors.
4. Remove all cables from devices.

Statement 2

CAUTION:



When replacing the lithium battery, use only IBM Part Number 33F8354 or an equivalent type battery recommended by the manufacturer. If your system has a module containing a lithium battery, replace it only with the same module type made by the same manufacturer. The battery contains lithium and can explode if not properly used, handled, or disposed of.

Do not:

- Throw or immerse into water.
- Heat to more than 100 C (212 F)
- Repair or disassemble

Dispose of the battery as required by local ordinances or regulations.

Statement 3



CAUTION:

When laser products (such as CD-ROMs, DVD drives, fiber optic devices, or transmitters) are installed, note the following:

- Do not remove the covers. Removing the covers of the laser product could result in exposure to hazardous laser radiation. There are no serviceable parts inside the device.
- Use of controls or adjustments or performance of procedures other than those specified herein might result in hazardous radiation exposure.



Danger

Some laser products contain an embedded Class 3A or Class 3B laser diode. Note the following. Laser radiation when open. Do not stare into the beam, do not view directly with optical instruments, and avoid direct exposure to the beam.

Statement 4

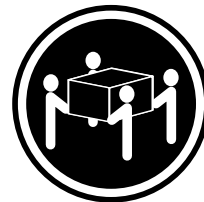
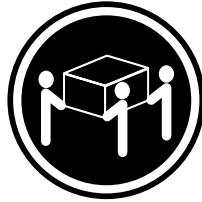
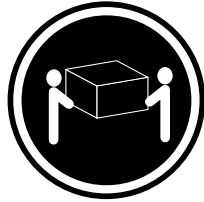

≥18 kg (39.7 lbs)

≥32 kg (70.5 lbs)

≥55 kg (121.2 lbs)

CAUTION:
Use safe practices when lifting.

Statement 5



CAUTION:
The power control button on the device and the power switch on the power supply do not turn off the electrical current supplied to the device. The device also might have more than one power cord. To remove all electrical current from the device, ensure that all power cords are disconnected from the power source.

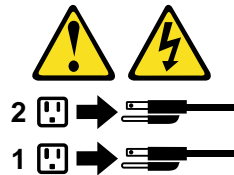

Statement 8



CAUTION:

Never remove the cover on a power supply or any part that has the following label attached.



Hazardous voltage, current, and energy levels are present inside any component that has this label attached. There are no serviceable parts inside these components. If you suspect a problem with one of these parts, contact a service technician.

Chapter 1. Introducing the IntelliStation R Pro

Thank you for selecting an IBM® IntelliStation® R Pro Professional Workstation. Your computer incorporates many of the latest advances in computing technology and is easy to expand and upgrade as your needs change.

If you have access to the World Wide Web, you can obtain up-to-date information about your IntelliStation R Pro model and other IBM computer products at the following World Wide Web address:

<http://www.ibm.com/pc/us/intellistation/>

Your computer model and serial numbers are located on labels on the top of the machine behind the bezel on the right. You will need these numbers when you register your computer with IBM and to record the numbers in Appendix A, "Computer records," on page 115.

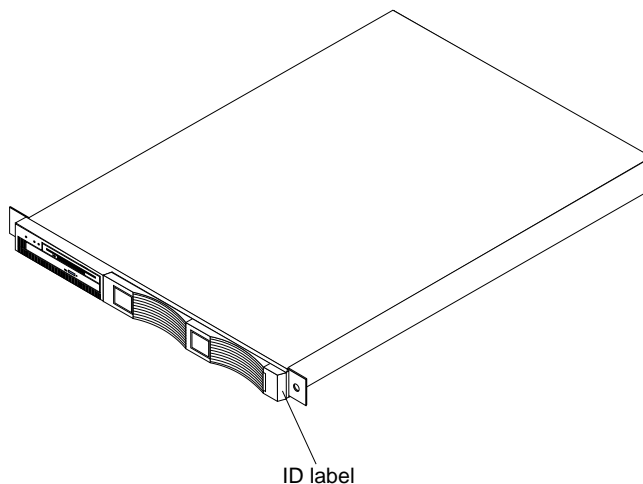

Inventory checklist

Be sure to take an inventory of items as you unpack them to ensure that you have all of the components. If any items are missing or damaged, contact your place of purchase. The following is a list of items shipped with your IBM IntelliStation R Pro computer:

- One mouse (three-button)
- One keyboard
- One power cord (9 ft cord with IEC connector)
- One power cord (9 ft line cord)
- One KVM cable
- One compact disc with device drivers
- One Matrox video card accessory kit
- Velocro/cable tie package
- Rack mounting instructions
- This User's Guide

IntelliStation R Pro features and specifications

The following table provides a summary of the features and specifications for the R Pro Types 8654-55X, 8654-56X, 8654-57X, and 8654-58X . Some features and specifications might not apply (depending on the machine type).

<p>Microprocessor:</p> <ul style="list-style-type: none"> Intel® Pentium® III microprocessor with MMX™ technology and SIMD extensions 256 KB Level-2 cache Supports up to two microprocessors <p>Memory:</p> <ul style="list-style-type: none"> Standard: 256 MB Maximum: 4 GB Type: 133 MHz, ECC, SDRAM, Registered DIMMs Slots: 4 dual inline <p>Drives standard: (depending on your model)</p> <ul style="list-style-type: none"> Diskette: 1.44 MB CD-ROM: 24X IDE IDE hard disk drive (IDE model only) SCSI hard disk drive (SCSI model only) <p>Expansion bays:</p> <ul style="list-style-type: none"> Two 3.5-inch slim high bays for LVD SCSI hard disk drives <p>PCI expansion slots:</p> <ul style="list-style-type: none"> Two 33 MHz/64-bit <p>Power supply:</p> <ul style="list-style-type: none"> One 200 watt (115-230 Vac) <p>Video:</p> <ul style="list-style-type: none"> Matrox G200/TV Tuner Adapter <p>Audio:</p> <ul style="list-style-type: none"> IBM PCI audio adapter 	<p>Size</p> <ul style="list-style-type: none"> Height 43.69 mm (1.72") Depth: 653.29 mm (25.72") Width: 439.93 mm (17.32") Weight: approximately 12.7 kg (28lb) when fully configured <p>Integrated functions:</p> <ul style="list-style-type: none"> Advanced System Management processor One Ultra160 SCSI controller Two 10BASE-T/100BASE-TX Intel Ethernet controllers Two Universal Serial Bus (USB) ports Two RS-485 Advanced System Management processor ports (one In, one Out) One serial port Two console ports (one In, one Out) <p>Acoustical noise emissions:</p> <ul style="list-style-type: none"> Sound power, idling: 6.3 bel maximum Sound power, operating: 6.3 bel maximum 	<p>Environment:</p> <ul style="list-style-type: none"> Air temperature: <ul style="list-style-type: none"> Computer on: 10° to 35° C (50.0° to 95.0° F). Altitude: 0 to 914 m (2998.7 ft.) Computer on: 10° to 32° C (50.0° to 89.6° F). Altitude: 914 m (2998.7 ft.) to 2133 m (6998.0 ft.) Computer off: 10° to 43° C (50.0° to 109.4° F). Maximum altitude: 2133 m (6998.0 ft.) Humidity: <ul style="list-style-type: none"> Computer on: 8% to 80% Computer off: 8% to 80% <p>Heat output:</p> <p>Approximate heat output in British Thermal Units (BTU) per hour</p> <ul style="list-style-type: none"> Minimum configuration: 273 BTU (80 watts) Maximum configuration: 751 BTU (220 watts) <p>Electrical input:</p> <ul style="list-style-type: none"> Sine-wave input (50-60 Hz) required Input voltage low range: <ul style="list-style-type: none"> Minimum: 100 V ac Maximum: 127 V ac Input voltage high range: <ul style="list-style-type: none"> Minimum: 200 V ac Maximum: 240 V ac Input kilovolt-amperes (kVA) approximately: <ul style="list-style-type: none"> Minimum: 0.08 kVA Maximum: 0.22 kVA
---	--	--

Table 1. Features and Specifications.

Notices used in this book

This information product contains notices that relate to a specific topic.

The following is a list of the notices and their definitions as used in this book:

- **Notes:** These notices provide important tips, guidance, or advice.
- **Important:** These notices provide information or advice that might help you avoid inconvenient or problem situations.
- **Attention:** These notices indicate possible damage to programs, devices, or data. An attention notice is placed just before the instruction or situation in which damage could occur.
- **Caution:** These notices indicate situations that can be potentially hazardous to you. A caution notice is placed just before the description of potentially hazardous procedure step or situation.
- **Danger:** These notices indicate situations that can be potentially lethal or extremely hazardous to you. A danger notice is placed just before the description of potentially lethal or extremely hazardous procedure step or situation.

Software CDs

The *IBM IntelliStation R Pro Device Drivers CD* that comes with your computer contains device drivers for system specific hardware. Use this CD to install the Microsoft® Windows NT® Workstation device driver. The CD also contains the audio device driver, in case you need to install or reinstall the device driver in the future.

In addition, the CD that comes in the Matrox video card accessory kit contains Windows NT and Windows 2000 device drivers and utilities for the Matrox video card.

What your IntelliStation R Pro offers

The unique design of your computer takes advantage of advancements in symmetric multiprocessing (SMP), data storage, and memory management. Your computer combines:

- **Impressive performance using an innovative approach to SMP**

Your computer supports up to two Pentium III microprocessors. Your computer comes with one microprocessor installed; you can install an additional microprocessor to enhance performance and provide SMP capability.

- **Large system memory**

The memory bus in your computer supports up to 4 gigabytes (GB) of system memory. The memory controller provides error correcting code (ECC) support for up to four industry standard PC133, 3.3 V, 168-pin, 8-byte, registered, synchronous-dynamic-random access memory (SDRAM) dual inline memory modules (DIMMs).

- **System-management capabilities**

Your computer comes with an Advanced System Management Processor on the system board. The Advanced System Management Processor provides system monitoring, event recording, and dial-out alert capability.

Note: The Advanced System Management Processor is sometimes referred to as the service processor.

Refer to the documentation provided with your systems-management software for more information.

- **Integrated network environment support**

Your computer comes with two Ethernet controllers on the system board. Each Ethernet controller has an interface for connecting to 10-Mbps or 100-Mbps networks. The computer automatically selects between 10BASE-T and 100BASE-TX. Each controller provides full-duplex (FDX) capability, which allows simultaneous transmission and reception of data on the Ethernet local area network (LAN).

Computer controls and indicators

This section identifies the controls and indicators on the front and the back of your computer.

Front view

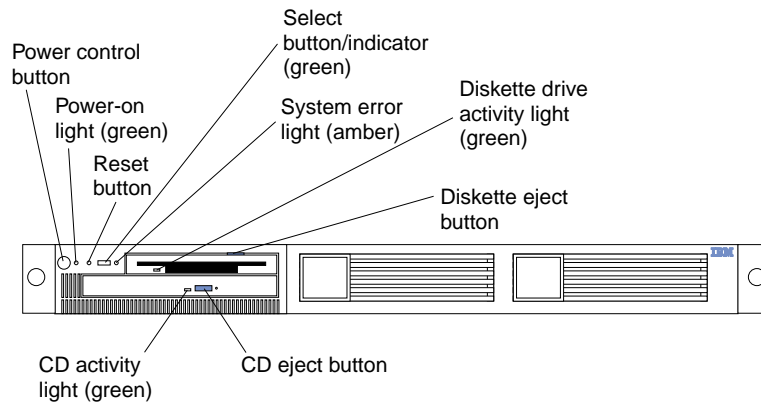

CD drive activity light: When this light is on, it indicates that the CD-ROM drive is in use.

CD eject button: Press this button to release a CD from the drive.

Diskette drive activity light: When this LED is on, it indicates that the diskette drive is in use.

Diskette-eject button: Press this button to release a diskette from the drive.

Power-control button: Press this button to manually turn the computer on or off.

Power-on light: This green LED lights and stays on when you turn on your computer and blinks when the computer is in stand-by mode.

Reset button: Press this button to reset the computer and run the power-on self-test (POST). You might need to use a pen or the end of a straightened paper clip to press the button.

Select button/indicator: Reserved. This light stays on. Pressing this button will not affect the light.

System-error light: This amber LED lights when a system error occurs. An LED on the Light Path Diagnostic panel on the system board will also be on to further isolate the error.

Rear view

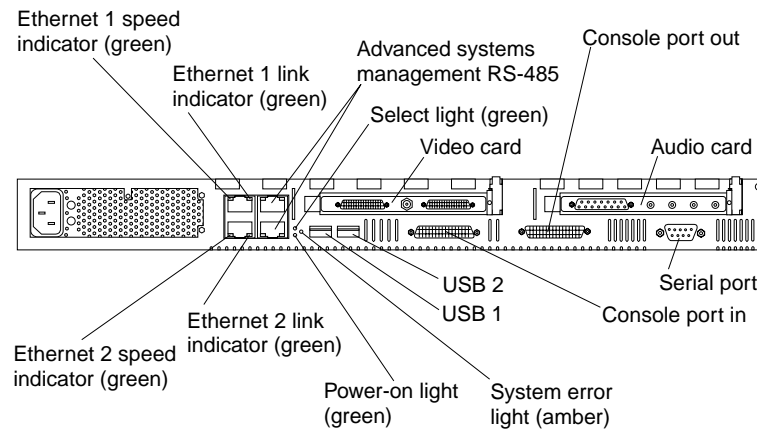

Advanced system management: The RS-485 ports are used for creating a system management bus between several computers.

Console port in: Reserved.

Console port out: This port is used to connect the computer to a keyboard and pointing device.

Ethernet 1 link indicator: This green LED lights when there is an active link connection on the 10BASE-T or 100BASE-TX interface for Ethernet port 1.

Ethernet 2 link indicator: This green LED lights when there is an active link connection on the 10BASE-T or 100BASE-TX interface for Ethernet port 2.

Ethernet 1 speed indicator: This green LED lights when the speed of the Ethernet LAN that is connected to Ethernet port 1 is 100 Mbps.

Ethernet 2 speed indicator: This green LED lights when the speed of the Ethernet LAN connected to Ethernet port 2 is 100 Mbps.

Power-on light: This green LED lights and stays on when you turn on your computer and will blink when the computer is in standby mode. This light duplicates the power on light on the front of the computer.

Select light: Reserved.

Serial port: Signal cables for modems or other serial devices connect here to the 9-pin serial port connector.

System-error light: This amber LED lights when a system error occurs. An LED on the Light Path Diagnostic panel on the system board will also be on to further isolate the error. This light duplicates the system error light on the front of the computer.

USB 2: Universal Serial Bus 2.

USB 1: Universal Serial Bus 1.

Chapter 2. Arranging your workspace

To get the most from your computer, arrange both the equipment you use and your work area to suit your needs and the kind of work you do. Your comfort is of foremost importance, but light sources, air circulation, and the location of electrical outlets can also affect the way you arrange your workspace.

Selecting a location for your computer

Ensure that you have an adequate number of properly grounded electrical outlets for the computer, monitor, and any other devices. Select a location for the computer where it will remain dry. Leave about 127 mm (5 in.) of space around the computer for proper air circulation. For information on arranging your computer and ease-of-use, see the following sections.

Comfort

Although no single working position is ideal for everyone, here are a few guidelines to help you find a position that suits you best.

Sitting in the same position for a long time can cause fatigue. A good chair can make a big difference. The backrest and seat should adjust independently and provide good support. The seat should have a curved front to relieve pressure on the thighs. Adjust the seat so that your thighs are parallel to the floor and your feet are either flat on the floor or on a footrest.

When using the keyboard, keep your forearms parallel to the floor and your wrists in a neutral, comfortable position. Try to keep a light touch on the keyboard and your hands and fingers relaxed. You can change the angle of the keyboard for maximum comfort by adjusting the position of the keyboard feet.

Adjust the monitor so the top of the screen is at, or slightly below, eye level. Place the monitor at a comfortable viewing distance, usually 51 to 61 cm (20 to 24 in.), and position it so you can view it without having to twist your body. Also position other equipment you use regularly, such as the telephone or mouse, within easy reach.

Glare and lighting

Position the monitor to minimize glare and reflections from overhead lights, windows, and other light sources. Even reflected light from shiny surfaces can cause annoying reflections on your monitor screen. Place the monitor at right angles to windows and other light sources, when possible. Reduce overhead lighting, if necessary, by turning off lights or using lower wattage bulbs. If you install the monitor near a window, use curtains or blinds to block the sunlight. You might have to adjust the Brightness and Contrast controls on the monitor as the room lighting changes throughout the day.

Where it is impossible to avoid reflections or to adjust the lighting, an antiglare filter placed over the screen might be helpful. However, these filters might affect the clarity of the image on the screen; try them only after you have tried all other methods of reducing glare.

Dust buildup compounds problems that are associated with glare. Remember to clean your monitor screen periodically using a soft cloth that is moistened with a nonabrasive liquid glass cleaner.

Air circulation

Your computer and monitor produce heat. Your computer has one or more fans that pull in fresh air and force out hot air. The monitor lets hot air escape through vents. Blocking the air vents can cause overheating, which might result in a malfunction or damage. Place the computer and monitor so that nothing blocks the air vents; usually, 15 cm (6 inches) of air space is sufficient. Also, make sure that the vented air is not blowing on someone else.

Electrical outlets and cable lengths

The location of electrical outlets and the length of power cords and cables that connect to the monitor, printer, and other devices might determine the final placement of your computer.

When arranging your workspace:

- Avoid the use of extension cords. When possible, plug the computer power cords directly into electrical outlets.
- Keep power cords and cables neatly routed away from walkways and other areas where they might get kicked accidentally.

For more information about power cords, refer to the power cord information in this on-line publication.

Chapter 3. Operating your computer

This chapter provides information to help you in the day-to-day use of your computer.

Installing the operating system

Before you can use your computer, you must install an operating system. To install Microsoft Windows NT Workstation, use the Microsoft CDs in conjunction with the *IBM IntelliStation R Pro Device Drivers* CD that came with your computer. To install Windows® 2000 Professional, go to <http://www.ibm.com/pc/support> for the device driver and installation instructions.

At the web site, do the following:

1. Click **Workstations** (for IntelliStation products).
2. Select an IntelliStation family from the **Family** drop-down list.
3. Select a machine type from the **Machine Type** drop-down list.
4. Select a model from the **Model** drop-down list.
5. From the left panel, click **Hints and tips**.
6. Select a category from the **Hints and tips by category** drop-down list.
7. A list of documents are displayed based on your choices.

Installing and uninstalling the audio adapter device drivers

To install and uninstall the audio adapter device drivers for Microsoft Windows NT Workstation or Windows 2000 Professional, use the instructions in the following sections.

Installing the device drivers for Windows NT 4.0 and Windows 2000

To install the device drivers, do the following:

1. Turn on your computer.
2. Click the Windows **Start** button and select **Run**.
3. Insert the *IBM IntelliStation R Pro Device Drivers* CD into the CD-ROM drive.
4. Assuming your CD-ROM drive is D, type the following in the **Run** dialog box.
D:\audio\NT40\Setup.exe
5. The Welcome window displays and prompts you to exit all Windows programs before you run the installation program. Click **Next**.
6. When the ESS Solo-1 Installation window displays, select **Install**; then, click **Next**.
7. The Setup Complete window displays and informs you that setup has finished copying files to your computer. Select **Yes, I want to restart my computer now** to restart your computer so that the new driver can take effect.

Uninstalling the device drivers for Windows NT 4.0 and Windows 2000

To uninstall the device drivers, do the following:

1. Follow steps 1 through 5 in the section "Installing the device drivers for Windows NT 4.0 and Windows 2000" on page 9.
2. When the ESS Solo-1 Installation window displays, select **Uninstall Drivers**; then, click **Next**.
3. The Setup Complete window displays. If you want the device driver removed immediately, select **Yes, I want to restart my computer now**; then, click **Finish** to complete the uninstall.

Turning on your computer

After you plug one end of the computer power cord into the power supply connector on the rear of the computer, and the other end of the power cord into an electrical outlet, you can start the computer as follows:

- Press the power control button on the front of the computer to start the computer.
- If the computer is turned on and a power failure occurs, the computer starts automatically when the power is restored.

If the POST detects a problem when you turn on your computer, you will hear repeating beeps. If this occurs, see Chapter 6, "Solving Problems," on page 67 for more information.

If your computer is properly connected and configured to load a startup image from the network, a request is sent and a startup image is loaded into your computer. If the request is unsuccessful or there is no network connection, the operating system and application programs are loaded from the hard disk drive.

Your computer can "wake up" and be started remotely over a network, if it has a properly configured network connection.

Turning off your computer

You can turn off your computer as follows:

- Press the power control button on the front of the computer. This starts an orderly shutdown of the operating system, if this feature is supported by your operating system, and places the computer in standby mode.

Note: After turning off the computer, wait at least five seconds before you press the power control button to turn on the computer again.

- Press and hold the power control button for more than four seconds to cause an immediate shutdown of the computer and place the computer in standby mode. You can use this feature if the operating system stops functioning.

- If you cannot use the power control button to turn off your computer, disconnect the computer power cords from the electrical outlets.

Note: After disconnecting the power cords, wait approximately 15 seconds for your computer to stop running.

Statement 5



CAUTION:

The power control button on the device and the power switch on the power supply do not turn off the electrical current supplied to the device. The device also might have more than one power cord. To remove all electrical current from the device, ensure that all power cords are disconnected from the power source.

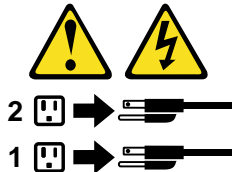

Using video features

Your computer has a graphics adapter that uses a standard video protocol for displaying text and graphic images on a monitor screen. The adapter supports a variety of video modes. Video modes are different combinations of resolution, refresh rate, and color defined by a video standard for displaying text or graphics.

Video device driver

To take full advantage of the graphics (video) adapter in your computer, some operating systems and application programs require custom software, known as video device drivers. These device drivers provide support for greater speed, higher resolution, more available colors, and flicker-free images.

The device driver for the graphics adapter and the instructions for installing the device driver are provided with the documentation that comes with the adapter. Use the device driver installation instructions to install or reinstall the device driver.

Changing monitor settings

To get the best possible image on your screen and to reduce flicker, you might need to reset the resolution and refresh rate of your monitor. You can view and change monitor settings through your operating system.

Attention: Before you change any monitor settings, be sure to review the information that comes with your monitor. Using a resolution or refresh rate that is not supported by your monitor might cause the screen to become unreadable and could damage the monitor. The information that comes with your monitor usually includes the resolutions and refresh rates that the monitor supports. If you need additional information, contact the manufacturer of the monitor.

To minimize screen flicker and jitter, set your monitor for the highest noninterlaced refresh rate that the monitor supports. If your monitor complies with the VESA display data channel (DDC) standard, it is probably already set to the highest refresh rate that the monitor and video controller can support. If you are not sure if your monitor is DDC-compliant, see the documentation provided with the monitor.

Using audio features

Your computer has an integrated audio controller that supports SoundBlaster® applications and is compatible with the Microsoft Windows Sound System®. Your computer has seven audio connectors. Using the audio controller, you can record sound and music. If you connect external speakers to the Line out connector, you can play sound with multimedia applications.

The audio connectors in your computer are 3.5 mm (1/8-in.) mini-jacks. A description of the connectors follows.

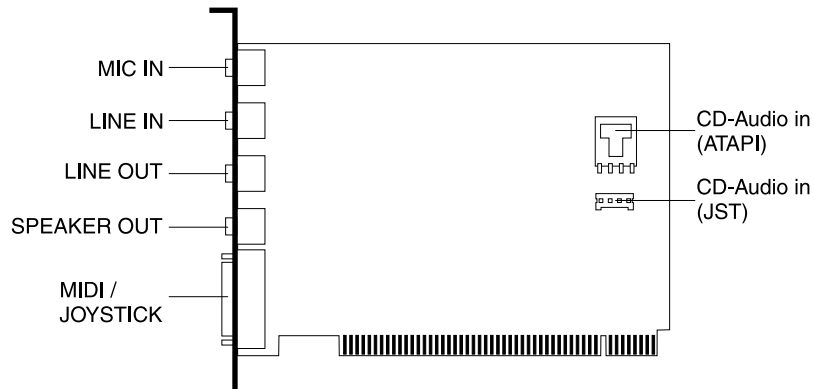

Line out

This connector is used to send audio signals from the computer to external devices, such as powered speakers with built-in amplifiers, headphones, multimedia keyboards, or the audio Line in jack on a stereo system.

Line in

This connector is used to accept audio signals from external devices, such as line output from a stereo, television, or a musical instrument, into the computer sound system.

Mic in

This connector is used to connect a microphone to your computer when you want to record voice or other sounds on the hard disk (mono input for microphone). This connector and a microphone can also be used by speech recognition software.

Note: If you experience interference or speaker feedback while recording, try reducing the microphone recording volume (gain).

MIDI/Joystick

The musical instrument digital interface (MIDI) connector allows your computer to interact with musical instruments and other musical equipment.

Speaker out

This connector is used to connect headphones or speakers to your computer.

CD-audio in (ATAPI)

This connector is used to accept audio signals from a CD-ROM drive (stereo input).

CD-audio in (JST)

This connector is used to accept audio signals from a CD-ROM drive (stereo input).

Chapter 4. Configuring your computer

The following configuration programs are provided with your computer:

- **Configuration/Setup Utility**

The Configuration/Setup Utility program is part of the *basic input/output system (BIOS)* code that comes with your computer. You can use this program to configure serial port assignments, change interrupt request (IRQ) settings, change the drive startup sequence, set the date and time, and set passwords.

- **SCSISelect Utility**

With the built-in SCSISelect Utility program, you can configure the devices that are attached to the integrated SCSI controller. Use this program to change default values, resolve configuration conflicts, and perform a low-level format on a SCSI hard disk drive.

- **PXE Boot Agent Utility**

The Preboot eXecution Environment (PXE) Boot Agent Utility program is part of the *basic input/output system (BIOS)* code that comes with your computer. You can use this program to change network boot protocols and boot order, to select OS wake up support, and to set menu wait times.

Using the Configuration/Setup Utility program

This section provides the instructions needed to start the Configuration/Setup Utility program and descriptions of the menu choices available.

Starting the Configuration/Setup Utility program

To start the Configuration/Setup Utility program:

1. Turn on the computer and watch the monitor screen.
2. When the message **Press F1 for Configuration/Setup** appears, press F1.

Note: If you have set both levels of passwords (user and administrator), you must enter the administrator password to access the full Configuration/Setup menu.

3. Follow the instructions that appear on the screen.

Choices available from the Configuration/Setup main menu

From the Configuration/Setup Utility main menu, you can select settings that you want to change. The Configuration/Setup Utility main menu is similar to the following:

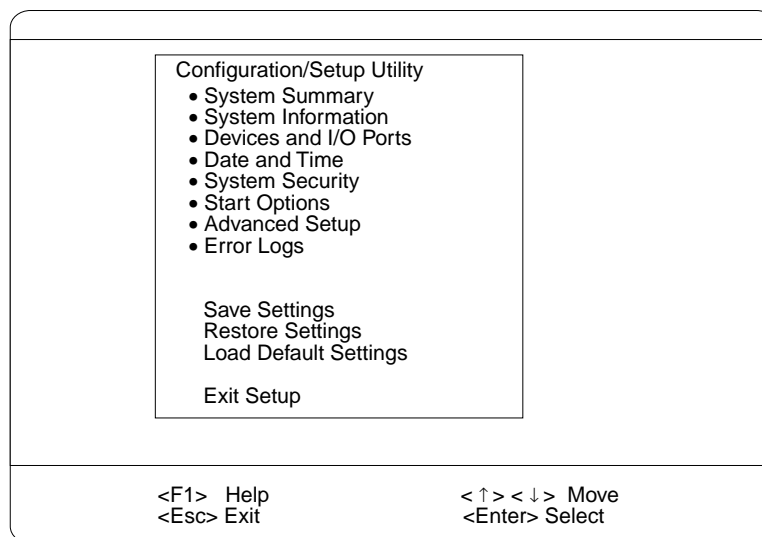

Notes:

1. You can press F1 to display Help information for a selected menu item.
2. The choices on some menus might differ slightly, depending on the BIOS version on your computer.

Descriptions of the choices available from the main menu are as follows:

- **System Summary**

Select this choice to display configuration information. This includes the type and speed of the microprocessors and the amount of memory installed.

Changes that you make to configuration settings appear on this summary screen. You cannot edit the fields.

This choice displays on both the full and limited Configuration/Setup Utility menus.

- **System Information**

Select this choice to view information about your computer. Changes that you make on other menus might display on this summary screen. You cannot edit any of the fields. The System Information choice appears only on the full Configuration/Setup Utility main menu.

- **Product Data**

Select this choice to view system information, such as the machine type and model, the computer serial number, and the revision level or issue ROM date of the BIOS stored in the flash electronically erasable programmable ROM (EEPROM).

- **System Card Data**

Select this choice to view vital product data (VPD) for some computer components.

- **Devices and I/O Ports**

Select this choice to view or change the assignments for devices and input/output ports. This choice appears only on the full Configuration/Setup Utility main menu.

This choice also allows you to enable or disable the integrated SCSI, and Ethernet controllers.

- The default setting is Enable for all the controllers. If you select Disable, the system will not configure the disabled device and the operating system will not find the device. (This is equivalent to unplugging the device.)
- If the on-board SCSI controller is disabled and no other storage-device controller is installed, operating system startup cannot occur.

Select **System Service Processor Settings** to view the interrupt-request setting (IRQ) used by the Advanced System Management Processor (system service processor). You can then use the arrow keys to select a new IRQ setting for the Advanced System Management Processor from the list of available choices.

- **Date and Time**

Select this choice to set the system date and time and to change the system time sent to the Advanced System Management Processor (service processor) when the computer is started. This choice appears only on the full Configuration/Setup Utility main menu.

The system time is in a 24-hour format: hour:minute:second.

You can set a time delta to be added or subtracted from the system time that is sent to the service processor (Advanced System Management Processor) each time the computer is started. Use the number keys to enter the hours and minutes and + or – to add or subtract from the system time. If you want the system clock time to be the same as the Advanced System Management Processor clock time, leave the value set at its default of 0.

- **System Security**

Select this choice to set passwords or a system owner's name. This choice appears only on the full Configuration/Setup Utility main menu.

You can implement two levels of password protection:

- **Power-on Password**

Select this choice to set or change a power-on password. See "Using passwords" on page 20 for more information.

- **Administrator Password**

Select this choice to set or change an administrator password.

Attention: If you set an administrator password and then forget it, you cannot override or remove it. You must replace the system board.

The administrator password provides access to all the choices on the Configuration/Setup Utility main menu. You can set, change, or delete both the administrator and power-on passwords, and allow a startup password to be changed by the user.

See "Using passwords" on page 20 for more information.

- **Start Options**

Select this choice to view or change the start options. This choice appears only on the full Configuration/Setup Utility main menu. Start options take effect when you start your computer.

You can select keyboard operating characteristics, such as the keyboard speed. You also can specify whether the keyboard number lock starts on or off. You also can enable the computer to run without a diskette drive, monitor, or keyboard.

The computer uses a startup sequence to determine the device from which the operating system loads. For example, you can define a startup sequence that checks for a startable diskette in the diskette drive, then checks the hard disk drive in bay 1, and then checks a network adapter.

If the **Boot Fail Count** choice is enabled, you must restart the system three times to restore the system BIOS default settings. If this choice is disabled, the system BIOS defaults can only be restored from the Configuration/Setup Utility main menu.

You can enable a virus-detection test that checks for changes in the master boot record at startup.

- **Advanced Setup**

Select this choice to change the values for advanced hardware features, such as cache control and PCI configuration. This choice appears only on the full Configuration/Setup Utility main menu.

A warning message appears above the choices on this menu to alert you that the system might malfunction if these options are configured incorrectly. Follow the instructions on the screen carefully.

- **Processor Serial Number Access**

Select this choice to identify if the microprocessor serial number in the microprocessor is readable.

- **System Partition Visibility**

Select this choice to identify if the System Partition is visible. To make the System Partition visible, set this value to **Visible**. To make the System Partition invisible, set this value to **Hidden**.

- **Core Chipset Control**

Select this choice to modify settings that control features of the core chip set on the system board.

Attention: Do not make changes here unless directed to do so by an IBM authorized service representative.

- **Cache Control**

Select this choice to enable or disable the microprocessor cache. In addition, you can set the microprocessor cache mode to write-back (WB) or write-through (WT). Selecting write-back mode will provide the maximum system performance.

— **PCI Slot/Device Information**

Select this choice to view and identify system resources used by PCI devices. PCI devices automatically communicate with the computer configuration information. This usually results in automatic configuration of a PCI device.

Attention: You must use the menu selections to save custom settings for the PCI Slot/Device Information choice. The save, restore, and load default settings choices on the main menu of the Configuration/Setup Utility do not save the PCI Slot/Device Information settings.

PCI Device Control allows you to enable or disable the PCI slots from this menu.

The default setting is Enable for all the PCI slots. If you select Disable, the system will not configure the disabled device and the operating system will not see the device. (This is equivalent to unplugging the device.)

— **Memory Settings**

Select this choice to manually disable or enable a bank of memory.

If a memory error is detected during POST or memory configuration, the computer can automatically disable the failing memory bank and continue operating with reduced memory capacity. If this occurs, manually enable the memory bank after the problem is corrected. Select **Memory Settings** from the Advanced Setup menu; then, use the arrow keys to highlight the bank that you want to enable. Use the arrow keys to select **Enable**.

• **Error Logs**

Select this choice to view or clear error logs.

— Select **POST Error Log** to view the three most recent error codes and messages that the system generated during POST.

Select **Clear error logs** from the POST Error Log menu to clear the error log.

— Select **System Event/Error Log** to view the system event/error log. The system event/error log contains all the system error and warning messages that the system generates. You can use the arrow keys to move between pages in the system event/error log.

Select **Clear error logs** from the System Event/Error Log menu to clear the error or event log.

• **Save Settings**

Select this choice to save your customized settings.

• **Restore Settings**

Select this choice to delete your changes and restore the previous settings.

• **Load Default Settings**

Select this choice to cancel your changes and restore the factory settings.

• **Exit Setup**

If you have made any changes, the program will prompt you to save the changes or exit without saving the changes.

Using passwords

The **System Security** choice appears only on the full Configuration/Setup Utility menu. After you select this choice, you can implement two levels of password protection: power-on password and administrator password.

Power-on password

After you set a power-on password, you can enable the unattended-start mode. This locks the keyboard and mouse, but enables the system to start the operating system. The keyboard and mouse remain locked until you enter the correct password.

You can use any combination of up to seven characters (A–Z, a–z, 0–9, and blanks) for your power-on password. Keep a record of your password in a secure place. If you forget the power-on password, you can regain access to the computer through one of the following methods:

- If an administrator password is set, enter the administrator password at the power-on prompt. Start the Configuration/Setup Utility program and change the power-on password.
- Change the position of the password override jumper as described in “Setting the password override switch”.
- Remove the battery and then install the battery.

Setting the password override switch: The following illustration shows the location of the password override switch, switch 8 of switch block 1, on the system board.

Note: The illustrations in this document might differ slightly from your hardware.

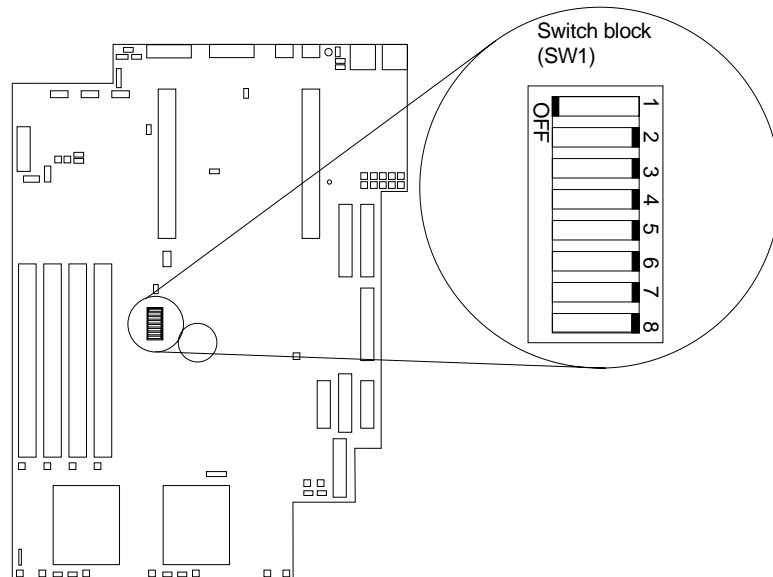

To set the password override switch:

1. Review the “Safety information” on page 31.
2. Turn off the computer and peripheral devices and disconnect all external cables and power cords; then, remove the cover. See “Removing the cover” on page 38.
3. Toggle switch 8 on switch block 1 on the system board. This clears the power-on password for one boot cycle.

Note: This means that you can now start or power-up the computer one time without having to use the power-on password. But if you do not use the Configuration/Setup Utility program to change or delete the password, the next time you start the computer, the original power-on password will be reinstated.

4. Connect the computer to a power source, keyboard, monitor, and mouse.
5. Turn on the computer.

Note: You can now start the Configuration/Setup Utility program and either delete the old or set a new power-on password.

Administrator password

Select this choice to set an administrator password. The administrator password provides access to all choices on the Configuration/Setup Utility main menu. You can set, change, or delete both the administrator and power-on passwords, and enable a user to change the power-on password.

Attention: If you set an administrator password then forget it, you cannot override or remove it. You must replace the system board.

The following table provides a summary of the password features.

Type of password	Results
Power-on password	<ul style="list-style-type: none">• Enter the password to complete the system startup.• All choices are available on the Configuration/Setup Utility main menu.
Administrator password	<ul style="list-style-type: none">• No password is required to start the system.• Enter the password to access the Configuration/Setup Utility program.• All choices are available on the Configuration/Setup Utility main menu.
Administrator <i>and</i> power-on password	<ul style="list-style-type: none">• You can enter either password to complete the system startup.• The administrator password provides access to all choices on the Configuration/Setup Utility main menu. You can set, change, or delete both the administrator and power-on passwords, and allow a power-on password to be changed by the user.• The power-on password provides access to a limited set of choices on the Configuration/Setup Utility main menu. This limited access might include changing or deleting the power-on password.

Table 2. Power-on and administrator password features.

Using the SCSISelect utility program

SCSISelect is a built-in, menu-driven configuration utility program that you can use to:

- View the default SCSI IDs
- Locate and correct configuration conflicts
- Perform a low-level format on a SCSI hard disk

The following sections provide the instructions needed to start the SCSISelect Utility and descriptions of the menu choices available.

Starting the SCSISelect utility program

To start the SCSISelect utility program:

1. Turn on the computer.
2. When the <<< Press <CTRL><A> for SCSISelect™ Utility! >>> prompt appears, press Ctrl+A.

Note: If an administrator password has been set, a prompt appears asking you to enter the password to start the SCSISelect Utility program.

3. Use the arrow keys to select a choice from the menu.
 - Press Esc to return to the previous menu.
 - Press the F5 key to switch between color and monochrome modes (if your monitor permits).
4. Follow the instructions on the screen to change the settings of the selected items; then, press Enter.

Choices available from the SCSISelect menu

The following choices appear on the SCSISelect Utility menu:

- **Configure/View Host Adapter Settings**

Select this choice to view or change the SCSI controller settings. To reset the SCSI controller to its default values, press F6; then, follow the instructions that appear on the screen.

You can view or change the following controller settings:

- **Host Adapter SCSI ID**

Select this choice to view the SCSI controller ID, normally 7.

- **SCSI Parity Checking**

Select this choice to view the assigned value of *Enabled*.

- **Host Adapter SCSI Termination**

Select this choice to view the assigned value of *Enabled*.

- **Boot Device Options**

Select this choice to configure startable device parameters. Before you can make updates, you must know the ID of the device for which you want to configure parameters.

— **SCSI Device Configuration**

Select this choice to configure SCSI device parameters. Before you can make updates, you must know the ID of the device for which you want to configure parameters.

Note: The Maximum Sync Transfer Rate represents the transfer rate for Ultra SCSI devices.

- The transfer rate for Ultra3 SCSI LVD devices is 160.0
- The transfer rate for Ultra2 SCSI LVD devices is 80.0
- The transfer rate for Fast SCSI devices is 20.0

— **Advanced Configuration Options**

Select this choice to view or change the settings for advanced configuration options.

• **SCSI Disk Utilities**

Select this choice to view the SCSI IDs that are assigned to each device or to format a SCSI device.

To use the utility program, select a drive from the list. Read the screens carefully before making a selection.

Note: If you press Ctrl+A before the selected drives are ready, an Unexpected SCSI Command Failure screen might appear. Restart the computer and watch the SCSISelect messages as each drive spins up. After the drive that you want to view or format spins up, press Ctrl+A.

Using the PXE boot agent utility program

The PXE boot agent is a built-in, menu-driven configuration utility program that you can use to:

- Change network startup (boot) protocols
- Change startup (boot) order
- Select whether or not to display setup prompt
- Set menu wait time
- Select OS wake up support

Starting the PXE boot agent utility program

The following sections provide the instructions needed to start the PXE Boot Agent Utility and descriptions of the menu choices available.

To start the PXE Boot Agent Utility program:

1. Turn on the computer.
2. When the Initializing Intel (R) Boot Agent Version X.X.XX PXE 2.0 Build XXX (WfM 2.0) prompt appears, press Ctrl+S.
Note: By default, you will have two seconds after the prompt appears on the screen to press Ctrl+S.
3. Use the arrow keys or press Enter to select a choice from the menu.
 - Press Esc to return to the previous menu.
 - Press the F4 key to exit.
4. Follow the instructions on the screen to change the settings of the selected items; then, press Enter.

Choices available from the PXE boot agent utility

The following choices appear on the PXE boot agent utility menu:

- **Network Boot Protocol**

PXE is the default value for this menu item.

Note: Do not change this value. There are no other network boot protocols supported.

- **Boot Order**

Select this choice to change the order in which boot devices are queried.

- Try local drives first, then network (Default)
- Try network only
- Try local drives only
- Try network first, then local drives

- **Show setup prompt**

Select this choice to either display the PXE setup prompt or disable it. Disable is the default setting.

When this choice is enabled, **Press Ctrl+S to enter the setup menu** will appear on the screen under the initializing prompt.

- **Setup time wait menu**

Select this choice to set the amount of time (in seconds) that the system will pause during initialization for a Ctrl+S input.

- 2 seconds (Default)
- 3 seconds
- 5 seconds
- 8 seconds

- **Legacy OS wake up support**

Select this choice to allow/disallow a non-Windows operating system to use the adapter remote wake up capability.

- Disabled (Default)
- Enabled

Chapter 5. Installing Options

This chapter provides instructions to help you add options to your computer. Some option-removal instructions are provided, in case you need to remove one option to install another. For a list of supported options for your computer, go to <http://www.ibm.com/pc/support> on the World Wide Web.

Major components of the R Pro computer

The following illustration shows the locations of major components in your computer.

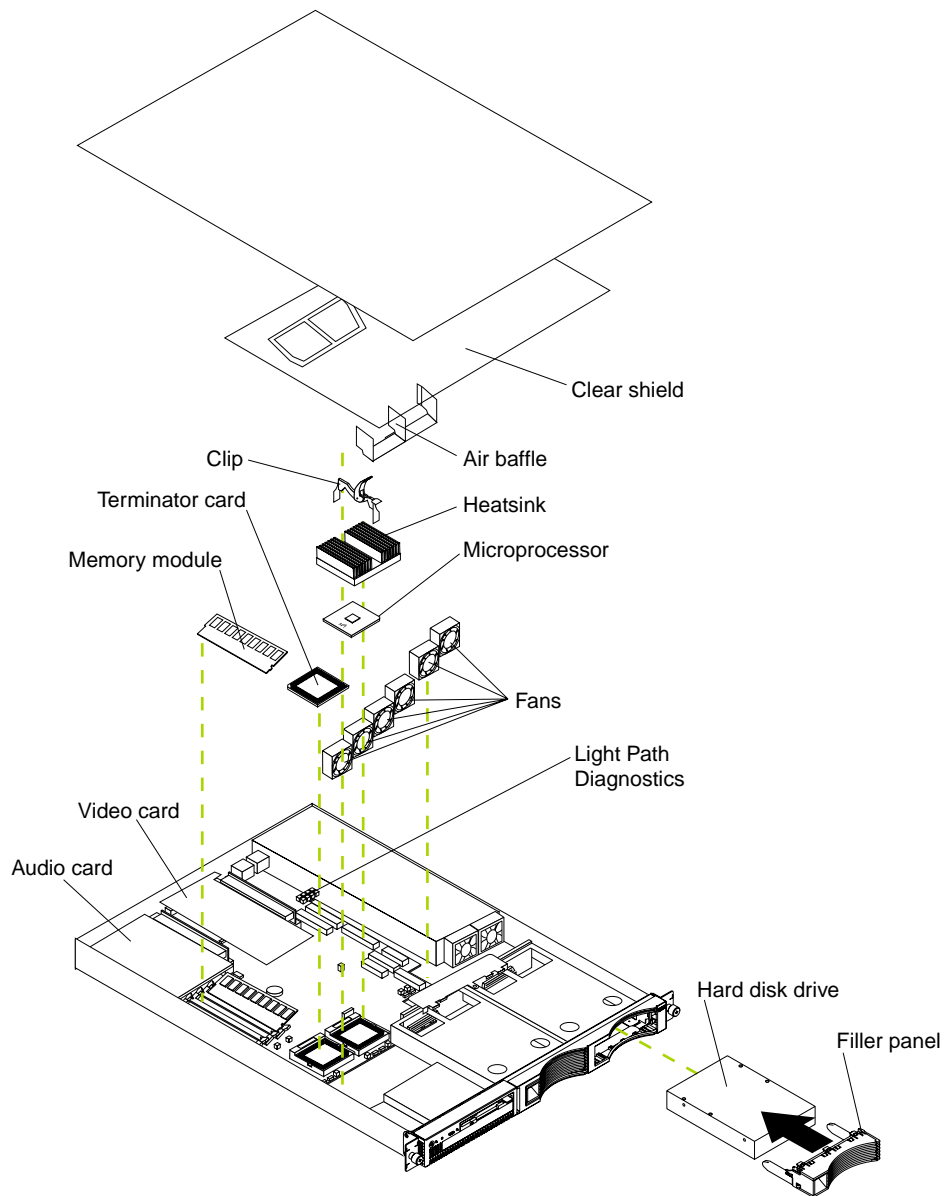

System board

The illustrations in the following sections show the components on the system board.

System board options connectors

The following illustration identifies the connectors on the system board.

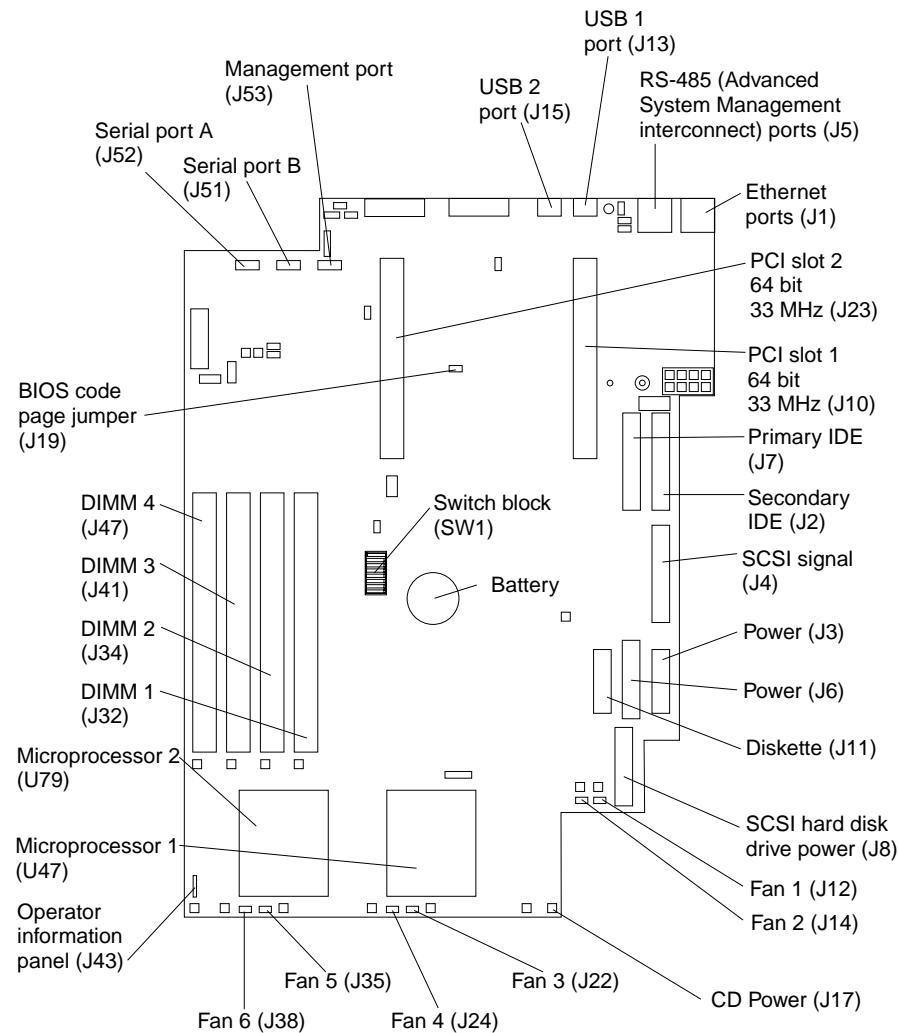

System board jumper blocks

Any jumper blocks on the system board that are not shown in the illustration are reserved. For normal operation of the system, no jumpers should be installed on any of the jumper blocks. See "Recovering BIOS" on page 93 for information about the Flash ROM page-swap jumper.

System board switch block

The switch block contains microswitches 1-8. As pictured in this illustration, switch 1 is at the top of the switch block and switch 8 is at the bottom. For more information about this switch block see “Setting the password override switch” on page 20.

The following table describes the function for each switch.

Table 3. Switches 1-8.

Switch number	Switch description
1	Reserved.
2	Reserved.
3	Reserved.
4	Reserved.
5	Reserved. The default setting is Off (disabled).
6	Reserved. The default setting is Off.
7	Reserved. The default setting is Off.
8	Bypass power-on password. When toggled to the opposite position, bypasses the power-on password, if one is set. Refer to “Setting the password override switch” on page 20.

System board LEDs

The following illustration identifies the LEDs on the system board.

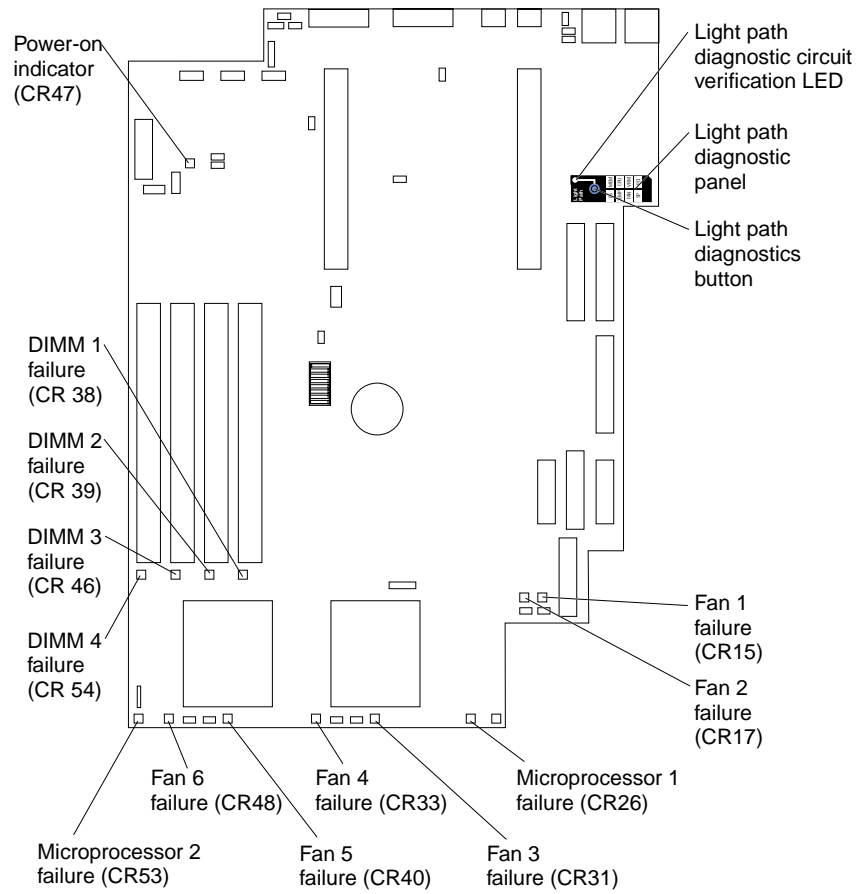

Before you begin

Before you begin to install options in your computer, read the following information:

- Become familiar with the safety and handling guidelines specified under “Handling static-sensitive devices” on page 30, and read the safety statements in “Safety information” on page 31. These guidelines help you work safely while working with your computer or options.
- Make sure that you have an adequate number of properly grounded electrical outlets for your computer, monitor, and any other options that you intend to install.
- Back up all important data before you make changes to disk drives.
- Have a small, flat-blade screwdriver available.
- For a list of supported options for your computer, refer to <http://www.ibm.com/pc/us/compat> on the World Wide Web.
- For your convenience during setup and service you might want to have a separate location where you can temporarily connect the computer to a power source (using a separate power cord), keyboard, monitor, and mouse (using a separate device breakout cable).

System reliability considerations

To help ensure proper cooling and system reliability, make sure:

- Each of the drive bays has a filler panel installed.
- The cover is in place during normal operations, or is removed for no longer than 30 minutes while the computer is operating.
- There is space around the computer to allow the computer cooling system to work properly. Leave about 127 mm (5 in). of space around the front and rear of the computer.
- Cables for optional adapters are routed according to the instructions provided with the adapters.
- A failed fan is replaced within 48 hours.

Working inside a computer with the power on

Your computer is designed to operate safely while turned on with the cover removed. Follow these guidelines when you work on the inside of a computer that is turned on:

- Avoid loose-fitting clothing on your forearms. Button long-sleeved shirts before working inside the computer; do not wear cuff links while you are working inside the computer.
- Do not allow your necktie or scarf to hang inside the computer.
- Remove jewelry, such as bracelets, rings, necklaces, and loose-fitting wrist watches.
- Remove items from your shirt pocket (such as pens or pencils) that could fall into the computer as you lean over it.
- Take care to avoid dropping any metallic objects, such as paper clips, hair pins, or screws, into the computer.

Handling static-sensitive devices

Attention: Static electricity can damage electronic devices and your system. To avoid damage, keep static-sensitive devices in their static-protective packaging until you are ready to install them.

To reduce the possibility of electrostatic discharge, observe the following precautions:

- Limit your movement. Movement can cause static electricity to build up around you.
- Handle the device carefully, holding it by its edges or its frame.
- Do not touch solder joints, pins, or exposed printed circuitry.
- Do not leave the device where others can handle and possibly damage the device.
- While the device is still in its static-protective package, touch it to an unpainted metal part of the system unit for at least two seconds. (This drains static electricity from the package and from your body).
- Remove the device from its package and install it directly into your system unit without setting it down. If it is necessary to set the device down, place it on its static-protective package. (If your device is an adapter, place it component side up). Do not place the device on your system unit cover or on a metal table.
- Take additional care when handling devices during cold weather because heating reduces indoor humidity and increases static electricity.

Safety information

Before installing this product, read the following safety information.

مج، يجب قراءة دات السلامة

Antes de instalar este produto, leia o Manual de Informações sobre Segurança.

安装本产品前请先阅读《安全信息》手册。

Prije instalacije ovog proizvoda pročitajte priručnik sa sigurnosnim uputama.

Před instalací tohoto produktu si přečtěte příručku bezpečnostních instrukcí.

Læs hæftet med sikkerhedsforskrifter, før du installerer dette produkt.

Lue Safety Information -kirjanen, ennen kuin asennat tämän tuotteen.

Avant de procéder à l'installation de ce produit, lisez le manuel Safety Information.

Vor Beginn der Installation die Broschüre mit Sicherheitshinweisen lesen.

Πριν εγκαταστήσετε αυτό το προϊόν, διαβάστε το εγχειρίδιο Safety Information.

לפני שתתקינו מוצר זה, קראו את הוראות הבטיחות.

Przed zainstalowaniem tego produktu należy przeczytać broszurę Informacje Dotyczące Bezpieczeństwa.

Prima di installare questo prodotto, leggere l'opuscolo contenente le informazioni sulla sicurezza.

本製品を導入する前に、安全情報資料を御読みください。

이 제품을 설치하기 전에, 안전 정보 책자를 읽어보십시오.

Пред да го инсталирате овој производ прочитајте ја книгата со безбедносни информации.

Lees voordat u dit product installeert eerst het boekje met veiligheidsvoorschriften.

Les heftet om sikkerhetsinformasjon (Safety Information) før du installerer dette produktet.

Antes de instalar este produto, leia o folheto Informações sobre Segurança.

Перед установкой продукта прочтите брошюру по технике безопасности (Safety Information).

Pred inštaláciou tohto produktu si pre ítajte Informa nú brožúrku o bezpe nosti.

Preden namestite ta izdelek, preberite knjižico Varnostne informacije.

Antes de instalar este producto, lea la Información de Seguridad.

Läs säkerhetsinformationen innan du installerar den här produkten.

在安裝本產品之前，也請先閱讀「安全性資訊」小冊子。

Installálás el tt olvassa el a Biztonsági el írások kézikönyvét !

Statement 1



DANGER

Electrical current from power, telephone, and communication cables is hazardous. To avoid a shock hazard:

- **Do not connect or disconnect any cables or perform installation, maintenance, or reconfiguration of this product during an electrical storm.**
- **Connect all power cords to a properly wired and grounded electrical outlet.**
- **Connect to properly wired outlets any equipment that will be attached to this product.**
- **When possible, use one hand only to connect or disconnect signal cables.**
- **Never turn on any equipment when there is evidence of fire, water, or structural damage.**
- **Disconnect the attached power cords, telecommunications systems, networks, and modems before you open the device covers, unless instructed otherwise in the installation and configuration procedures.**

To connect:

1. Turn everything OFF.
2. First, attach all cables to devices.
3. Attach signal cables to connectors.
4. Attach power cords to outlet.
5. Turn device ON.

To disconnect:

1. Turn everything OFF.
2. First, remove power cords from outlet.
3. Remove signal cables from connectors.
4. Remove all cables from devices.

Statement 2

CAUTION:



When replacing the lithium battery, use only IBM Part Number 33F8354 or an equivalent type battery recommended by the manufacturer. If your system has a module containing a lithium battery, replace it only with the same module type made by the same manufacturer. The battery contains lithium and can explode if not properly used, handled, or disposed of.

Do not:

- **Throw or immerse into water.**
- **Heat to more than 100 C (212 F)**
- **Repair or disassemble**

Dispose of the battery as required by local ordinances or regulations.

Statement 3



CAUTION:

When laser products (such as CD-ROMs, DVD drives, fiber optic devices, or transmitters) are installed, note the following:

- Do not remove the covers. Removing the covers of the laser product could result in exposure to hazardous laser radiation. There are no serviceable parts inside the device.
- Use of controls or adjustments or performance of procedures other than those specified herein might result in hazardous radiation exposure.



DANGER

Some laser products contain an embedded Class 3A or Class 3B laser diode. Note the following. Laser radiation when open. Do not stare into the beam, do not view directly with optical instruments, and avoid direct exposure to the beam.



Class 1 Laser Product
Laser Klasse 1
Laser Klass 1
Luokan 1 Laserlaite
Appareil À Laser de Classe 1

Statement 4

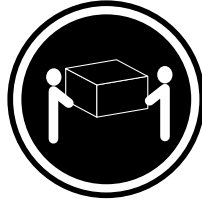

≥18 kg (37 lbs)

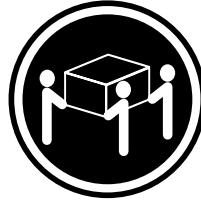

≥32 kg (70.5 lbs)

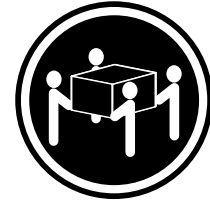

≥55 kg (121.2 lbs)

CAUTION:

Use safe practices when lifting.

Statement 5

CAUTION:



The power control button on the device and the power switch on the power supply do not turn off the electrical current supplied to the device. The device also might have more than one power cord. To remove all electrical current from the device, ensure that all power cords are disconnected from the power source.



Statement 8



CAUTION:

Never remove the cover on a power supply or any part that has the following label attached.



Hazardous voltage, current, and energy levels are present inside any component that has this label attached. There are no serviceable parts inside these components. If you suspect a problem with one of these parts, contact a service technician.

Removing the cover

The following information describes how to remove the cover.

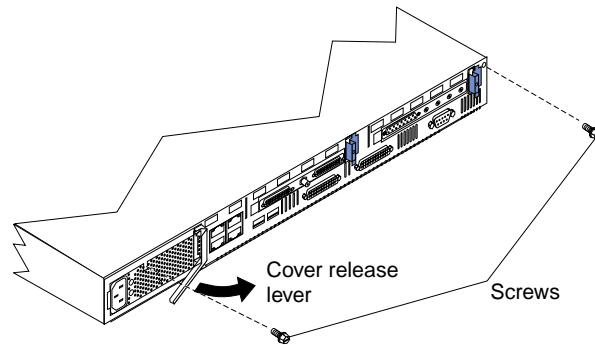

Complete the following steps to remove the computer cover:

1. Review the “Safety information” on page 31 and “Working inside a computer with the power on” on page 29.
2. Turn off the computer and all attached devices and disconnect all external cables and power cords.
3. Remove the computer from the rack.
4. Remove the two screws from the rear of the computer.
5. Pull out on the cover release lever at the back of the computer, to release the cover.
6. Slide the cover back, then up and off the computer.

Attention: For proper cooling and airflow, replace the cover before turning on the computer. Operating the computer for extended periods of time (over 30 minutes) with the cover removed might damage computer components.

7. Remove the clear shield that covers the inside of the computer.

Note: It is not necessary to remove the shield when you are installing memory modules or installing an adapter in the PCI slots.

Working with adapters

Your computer comes with two peripheral component interconnect (PCI) adapter slots on the system board with riser cards installed in them.

Attention: Your computer also comes with an integrated video controller on the system board. However, since the video adapter has already been preinstall in a PCI slot, the computer BIOS automatically disabled the integrated video controller. This allows the video adapter in the PCI slot to control the video functions for your monitor.

The following illustration shows the location of the 33 MHz PCI expansion slots on the system board.

Note: The illustrations in this document might differ slightly from your hardware.

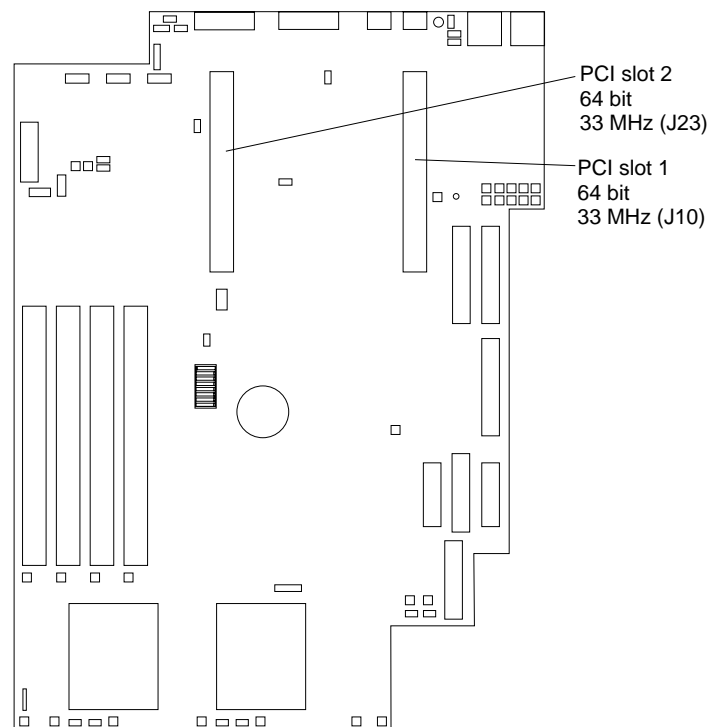

Adapter considerations

If you ever need to install an adapter, be sure to review the following:

- Locate the documentation that comes with the adapter and follow those instructions in addition to the instructions in this chapter. If you need to change the switch settings or jumper settings on your adapter, follow the instructions that come with the adapter.
- You can install 32-bit or 64-bit full-length or half-length adapters in the expansion slots. Full-length adapters are installed in slot 1; half-length adapters are installed in either slot 1 or 2.
- Your computer supports 5.0V and universal PCI adapters; it does not support 3.3V only adapters.
- Your computer uses a rotational interrupt technique to configure PCI adapters. Because of this technique, you can install PCI adapters that currently do not support sharing of PCI interrupts.
- PCI slots 1 and 2 and the integrated SCSI controller are on PCI bus B; the system board and all other integrated devices are on PCI bus A.

Note: PCI bus A = bus 0; PCI bus B = bus 1.

- The system scans PCI slots 1 and 2 to assign system resources. By default the system starts (boots) devices in the following order: System SCSI devices, then PCI devices.

Note: To change the boot precedence, start the Configuration/Setup Utility, select **Start Options** from the main menu; then, select the **PCI SCSI adapter boot option**.

Removing an adapter

Complete the following steps to remove an adapter:

Attention: When you handle static-sensitive devices, take precautions to avoid damage from static electricity. For details on handling these devices, refer to “Handling static-sensitive devices” on page 30.

1. Review the “Safety information” on page 31
2. Turn off the computer and peripheral devices.
3. Remove all external cables from the computer; then, remove the computer from the rack and remove the cover. For more information, see “Removing the cover” on page 38 for instructions.
4. Remove the expansion slot clip that holds the expansion slot cover in place by sliding it upward and off the frame of the computer.
5. Remove the adapter according to the notes below:

Notes:

- a. For the audio adapter:
 - 1) Disconnect the audio cable that connects to the video adapter.
 - 2) Slide the adapter horizontally to disconnect it from the riser-card.
- b. For the video adapter, you must remove the adapter with the riser-card still attached to the adapter. To do this, complete the following steps:
 - 1) Lift up on the riser-card and remove it from the connector on the computer.
 - 2) Remove the audio adapter cable from the video adapter.
 - 3) Remove the adapter from the riser-card.

6. Replace the riser-card in the connector on the computer.
7. To install another adapter, see the next section.

Installing an adapter

Complete the following steps to install an adapter:

Attention: When you handle static-sensitive devices, take precautions to avoid damage from static electricity. For details on handling these devices, refer to “Handling static-sensitive devices” on page 30.

1. Review the “Safety information” on page 31.
2. Turn off the computer and peripheral devices.
3. Remove all external cables from the computer; then, remove the computer from the rack and remove the cover as shown. For more information, see “Removing the cover” on page 38 for instructions.

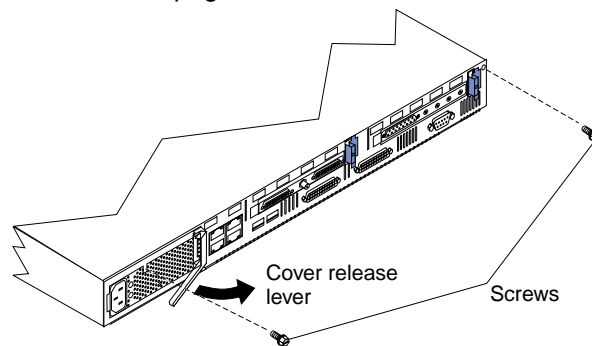

4. Remove the expansion slot clip that holds the expansion slot cover in place by sliding it upward and off the frame of the computer.

Note: The illustrations in this document might differ slightly from your hardware.

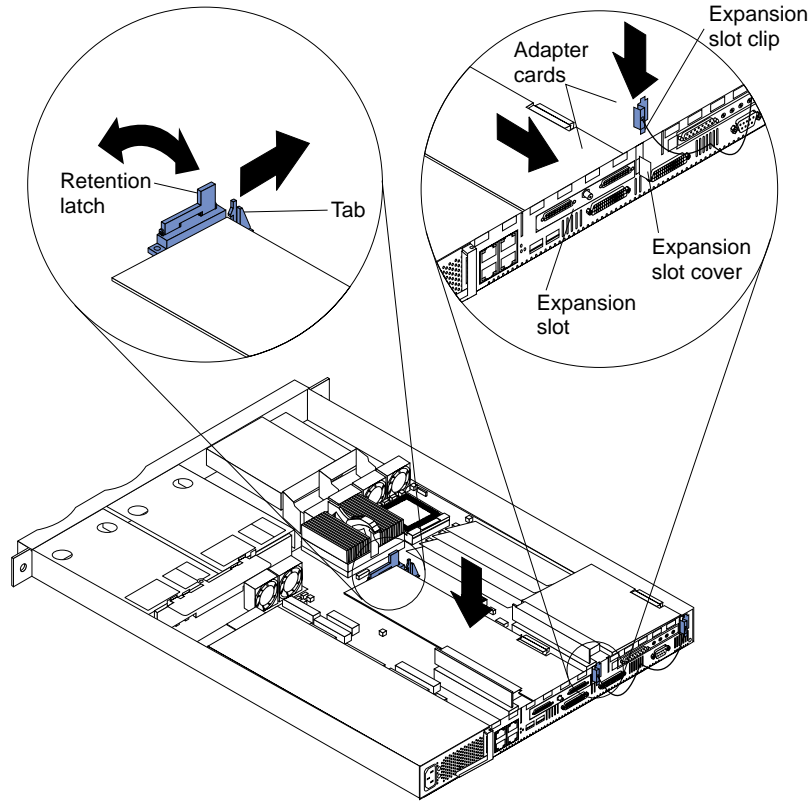

5. Remove the expansion-slot cover.
6. Refer to the documentation that comes with your adapter for any cabling instructions.

Attention: You should route adapter cables before you install the adapter.

7. Set any jumpers or switches as described by the adapter manufacturer.

8. Install the adapter:

Note: When installing an adapter in PCI slot 2, skip steps a and d.

- a. Open the adapter retention latch by pushing the blue tab to release it. Then push the latch up to the full open position.
- b. Carefully grasp the adapter by its top edge or upper corners, and align it with the connector on the PCI riser-card.
- c. Press the adapter *firmly* into the riser-card connector.

Attention: When you install an adapter, be sure the adapter is correctly seated in the riser-card connector before you turn on the computer. Improperly seated adapters might cause damage to the system board, the riser-card, or the adapter.

- d. Push down on the blue adapter retention latch until it clicks into place, securing the adapter.
- e. Replace the expansion slot clip by sliding it down until it latches into place and holds the adapter securely.

9. Connect the internal cables to the adapter.

Attention: Route cables so that they do not block the flow of air from the fans.

10. Replace the cover on the computer; then, reinstall the computer in the rack and connect all external cables. For more information see “Installing the cover” on page 53 for instructions.

11. Turn on the computer.

Hard disk drives

Your computer supports two, 26 mm (1 inch) slim 3.5-inch low voltage differential (LVD) hard disk drives. Your computer comes with one non-hot-swap hard disk drive preinstalled. The hard disk drives are non-hot-swappable.

Hard disk drives jumper settings

If you purchased the IDE model of the R Pro, the IDE drive installed in your computer is factory set to Master (drive 0). If you install a second IDE drive, you must set it to Subordinate (drive 1). Refer to the documentation that comes with the drive to determine the jumper setting for Subordinate mode.

If you purchased the SCSI model of the R Pro, the SCSI drive installed in your computer is factory set for SCSI ID 6. SCSI ID 7 is reserved for the SCSI controller. If you install a second SCSI drive, you must set it to a SCSI ID other than 6 or 7. Refer to the documentation that comes with the drive to find out how to set a unique ID before you install a new SCSI drive.

Preinstallation steps

Before you install a hard disk drive, review the following:

- To maintain proper system cooling, do not operate the computer for more than two minutes without either a drive or a filler panel installed in each bay.
- Review the “Safety information” on page 31 and “Handling static-sensitive devices” on page 30.
- Check the instructions that come with the drive for more information about installing your drive.
- If you are installing a SCSI drive, set its ID to 1, 2, 3, 4, or 5.

Installing or replacing a hard disk drive

Refer to the following illustration to install a hard disk drive.

Note: The illustrations in this document might differ slightly from your hardware.

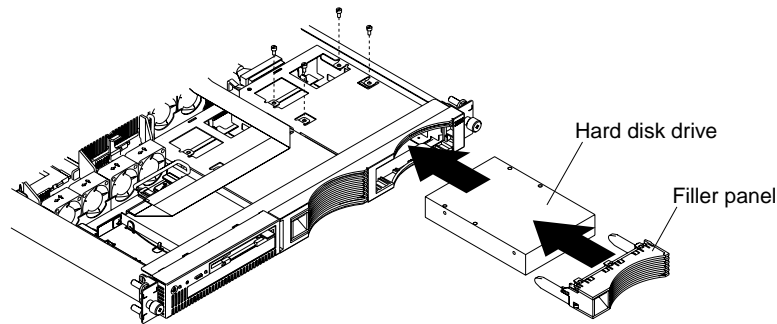

Attention: When you handle electrostatic discharge (ESD) sensitive devices, take precautions to avoid damage from static electricity. For details on handling these devices, refer to “Handling static-sensitive devices” on page 30.

Complete the following steps to install or replace a hard disk drive:

1. Review the “Safety information” on page 31.
2. Turn off the computer and peripheral devices and disconnect all external cables and power cords.
3. Remove all external cables from the computer; then, remove the computer from the rack and remove the cover. For more information on removing the cover, see “Removing the cover” on page 38.
4. Pull the fans located behind the drive bay of the hard disk drive that you want to install or replace out of the way so you can work. Disconnect the power and signal cables to the hard disk drive if you are replacing a hard disk drive.
5. Remove the filler panel or defective hard disk drive from the hard disk drive bay.
6. Install the new hard disk drive in the drive bay:
 - a. Slide the drive into the bay with the screw holes facing up and align the screw holes in the hard disk drive with the screw holes in the computer chassis.
 - b. Use a screwdriver to drive the screw into the hard disk drive and secure it to the computer chassis.

Note: You might need to hold the hard disk drive up and in place to align the hard disk drive with the screw holes in the chassis.
 - c. Replace the cover. See “Installing the cover” on page 53.
 - d. Connect the signal and power cables to the rear of the hard disk drive. Be sure to keep the signal cable and power cable clear of the air path of the fan behind the drive bay.
7. Reconnect the external cables and power cords; then, turn on the computer.
8. Check the hard disk drive status indicators to verify that the hard disk drives are operating properly. (See “Computer controls and indicators” on page 5 for the location of the status indicators.)

Note: The green light flashes rapidly (three flashes per second), the controller is identifying the drive.

Memory

Adding memory to your computer is an easy way to improve system performance. You can increase the amount of memory in your computer by installing options called *memory-module kits*. Each kit contains one industry-standard, dual-inline memory module (DIMM). Your computer uses a noninterleaved memory configuration, which allows you to add, remove, or replace one DIMM at a time. In an interleaved system you would have to add, remove, or replace memory in sets.

Your computer comes with a dual inline memory module (DIMM) installed on the system board in DIMM slot 1.

Note: Install additional DIMMs in the following order: DIMM connector 2, then 3, then 4. (See the following illustration for memory connector locations).

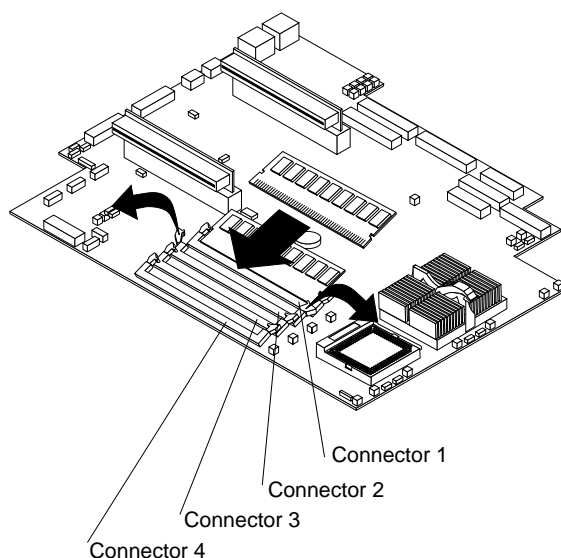

Installing memory modules

Complete the following steps to install a DIMM:

Attention: When you handle static-sensitive devices, take precautions to avoid damage from static electricity. For details on handling these devices, refer to “Handling static-sensitive devices” on page 30.

1. Review the “Safety information” on page 31.
2. Turn off the computer and peripheral devices.
3. Remove all external cables from the computer; then, remove the computer from the rack and remove the cover. For more information, see “Removing the cover” on page 38 for instructions.
4. If necessary, remove the PCI card from slot 2 for easier access to the DIMM connectors.
5. Touch the static-protective package containing the DIMM to any unpainted metal surface on the computer. Then, remove the DIMM from the package.

Attention: To avoid breaking the retaining clips or damaging the DIMM connectors, handle the clips gently.

6. Install the DIMM in the connector.

Attention: To prevent damage to the DIMM connectors, do not force the memory module into the connector.

- a. Turn the DIMM so that the index slots align correctly with the connector.
Note: The DIMM has two index slots, one in the center and the other on the left half of the DIMM connector edge.
- b. Insert the DIMM into the connector by pressing on both corners of the DIMM at the same time. Be sure to press straight into the connector.
- c. When installing a memory module, be sure that no gap exists between the DIMM and the retaining clips. If a gap does exist between the memory module and the retaining clips, remove the DIMM; then, reinsert the DIMM properly.

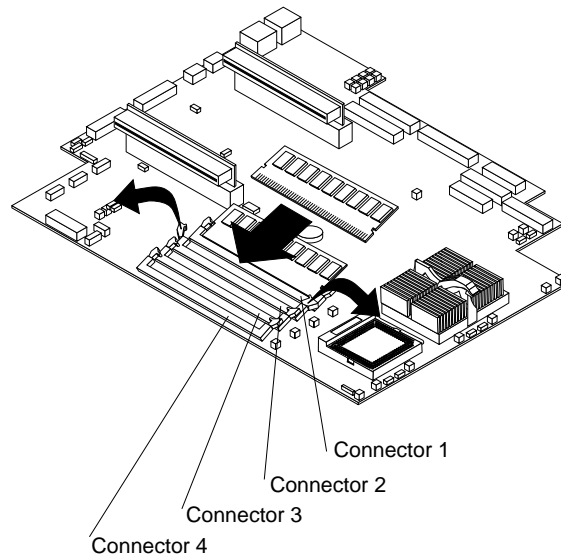

Note: If you have other options to install, install them now.

7. Replace the cover on the computer; then, reinstall the computer in the rack and connect all external cables. For more information, see “Installing the cover” on page 53 for instructions.
8. Turn on the computer.

Attention: When you restart the computer, the system displays a message indicating that the memory configuration has changed.

- If you installed additional memory, start the Configuration/Setup Utility program and select Save Settings.
- If you just replaced a failed DIMM, you must start the Configuration/Setup Utility program, select Advanced Setup, select Memory Settings, highlight the connector or bank of connectors that you want to enable, then select Enable.
- In some memory configurations, the 3-3-3 beep code might sound during POST followed by a blank display screen. If this occurs and the Boot Fail Count feature in the Start Options of the Configuration/Setup Utility is set to Enabled (its default setting), you must restart the computer three times to force the system BIOS to reset the memory connector or bank of connectors from Disabled to Enabled.

Microprocessor

Your computer comes with one or two microprocessors installed on the system board. If you have two, or had one and you installed a second microprocessor, your computer can operate as a symmetric multiprocessing (SMP) computer. With SMP, certain operating systems and application programs can distribute the processing load between the microprocessors. This enhances performance for database and point-of-sale applications, integrated manufacturing solutions, and other applications.

Notes:

1. Before you install a new microprocessor, review the documentation that comes with the microprocessor, so that you can determine whether you need to update the computer basic input/output system (BIOS). The latest level of BIOS for your computer is available through the World Wide Web. Refer to "Getting information, help, and service" on page 110 for the appropriate World Wide Web addresses.
2. Obtain an SMP-capable operating system (optional). For a list of supported operating systems, see <http://www.ibm.com/pc/us/compat/> on the World Wide Web.
3. If your computer comes with one microprocessor, it is installed in microprocessor connector 1, which is the microprocessor connector closer to the DIMM connectors. This is the startup (boot) microprocessor. If you install a second microprocessor in microprocessor connector 2, the two processors will share the system load after the system has started.

Attention: To avoid damage and ensure proper computer operation, install microprocessors that are the same type, have the same cache size, and have the same clock speed. Microprocessor internal clock frequencies and external clock frequencies must be identical. See the ServerProven list at <http://www.ibm.com/pc/compat> for a list of microprocessors for use with your computer.

Note: If you need to replace an existing microprocessor, call for service.

Installing the microprocessor

Complete the following steps to install an additional microprocessor:

Attention: When you handle static-sensitive devices, take precautions to avoid damage from static electricity. For details on handling these devices, refer to “Handling static-sensitive devices” on page 30.

1. Review the “Safety information” on page 31.
2. Turn off the computer and peripheral devices.
3. Remove all external cables from the computer; then, remove the computer from the rack and remove the cover. For more information, see “Removing the cover” on page 38 for instructions.
4. Remove the clear shield from the computer and store it in a safe place.
5. Lift up the microprocessor release lever and remove the terminator card from the microprocessor connector. (After you remove the new microprocessor from the static-protective package, place the terminator card in the bag and store it in a safe place. You will need to install the terminator card again, if you ever remove the microprocessor and do not replace the microprocessor).

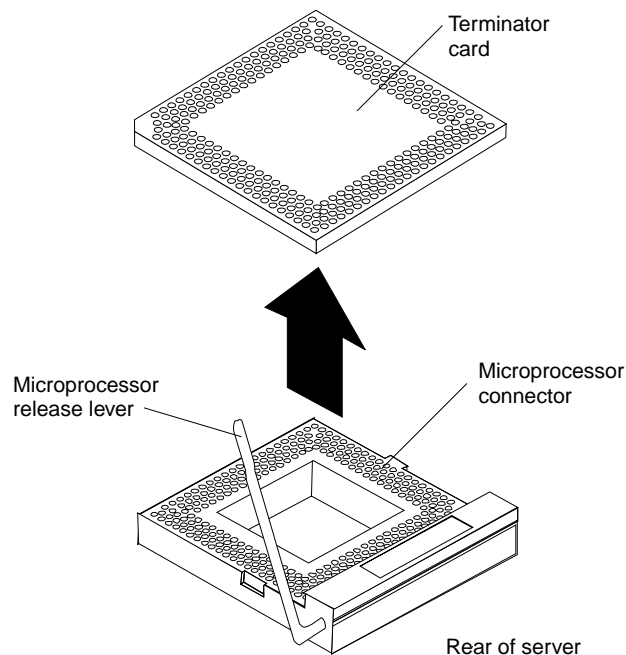

6. Install the microprocessor:
 - a. Touch the static-protective package containing the new microprocessor to any *unpainted* metal surface on the computer; then, remove the microprocessor from the package.

- b. Orient the microprocessor over the microprocessor connector as shown in the following illustration. Carefully press the microprocessor into the connector.

Note: To avoid bending the pins on the microprocessor, do not use excessive force when pressing it into the connector.

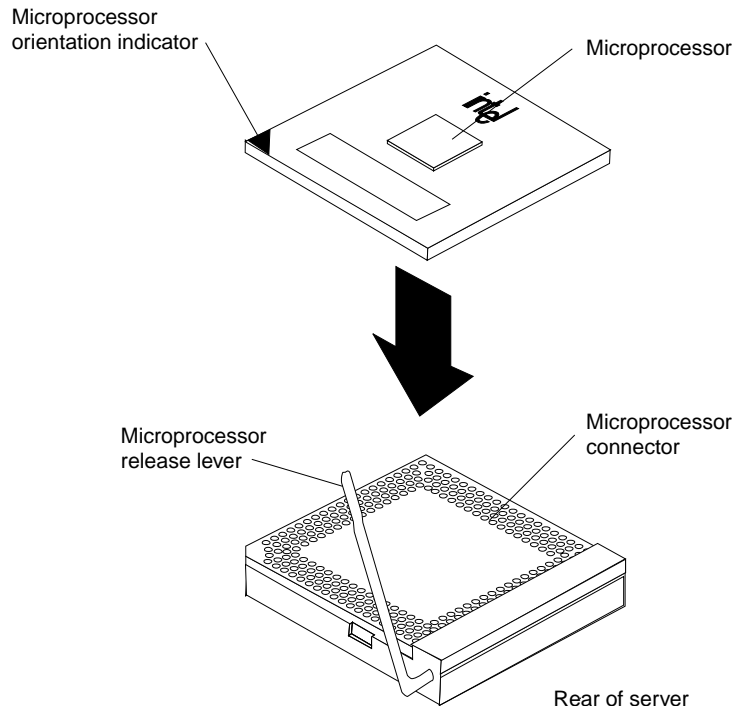

7. Push the microprocessor release lever down to lock the microprocessor in place.
8. Install the heat sink on the microprocessor:

- a. Peel the plastic protective strip off the bottom of the heat sink. Make sure the square of thermal material is still on the bottom of the heat sink.
- b. Align and place the heat sink on top of the microprocessor.

Note: Locate the slot in the channel of the heat sink. Orientate the heat sink so the slot will be at the rear of the computer as shown in the following illustration.

- c. Align and place the clip over the heat sink; then, snap the clip into place over the heat sink with the heat sink release lever in the up position.

Note: If you remove the microprocessor later, remember to install the terminator card in the appropriate microprocessor connector.

- d. Press the heat sink release lever down into the locked position, once the clip is in place.

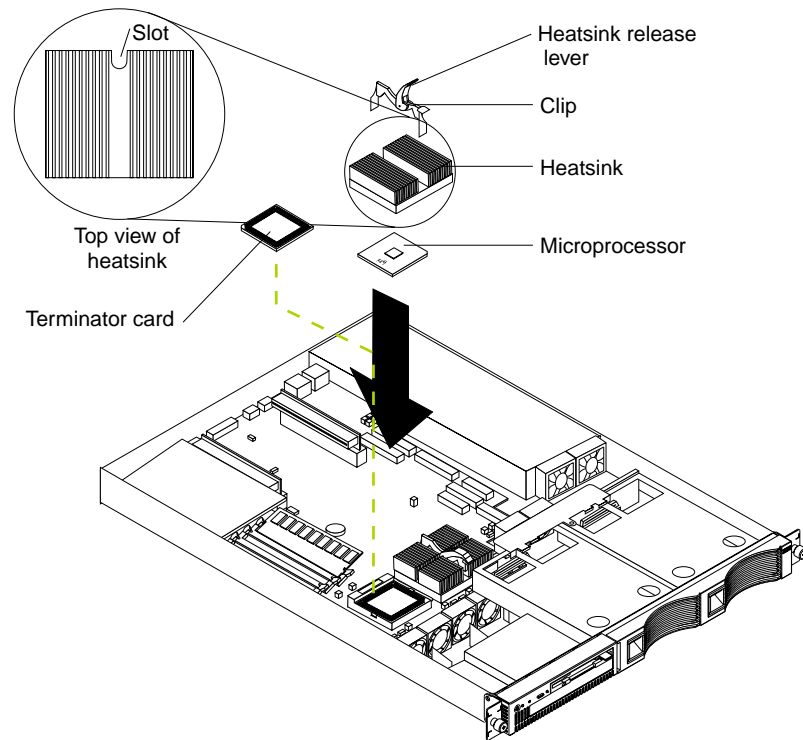

9. Replace the clear shield.

Note: If you need to replace an existing microprocessor, call for service.

10. Replace the cover on the computer; then, reinstall the computer in the rack and connect all external cables. For more information, see "Installing the cover" on page 53 for instructions.

11. Start the computer and run the Configuration/Setup Utility program.

Fan assembly replacement

Your computer comes with six replaceable fans.

Attention: Replace a fan that has failed within 48 hours to help ensure proper cooling.

The following illustration shows the replacement of a fan.

Note: The illustrations in this document might differ slightly from your hardware.

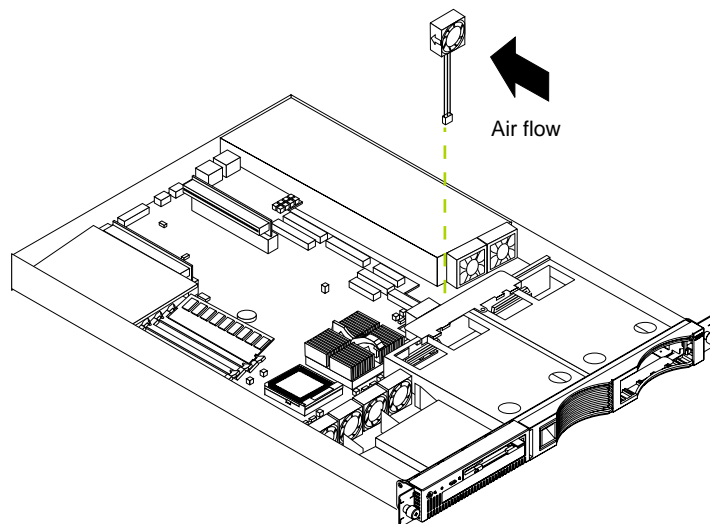

Complete the following steps to replace the fan assembly:

1. Review the "Safety information" on page 31.
2. Turn off the computer and peripheral devices.
3. Remove all external cables from the computer; then, remove the computer from the rack and remove the cover. For more information, see "Removing the cover" on page 38 for instructions.
4. Determine which fan to replace by checking the LED at each fan; a lit LED indicates the fan to replace.

Note: The fan LEDs are illuminated by the light path diagnostic circuit, and will remain lit for up to 12 hours after the AC power has been removed from the computer.

5. Remove the fan from the computer:
 - a. Disconnect the fan cable from the system board.
 - b. Lift the fan away from the computer.
6. Orient the fan so that the air flow arrow on the side of the fan is facing or pointing toward the rear of the computer.

Note: Proper air flow is from the front to the rear of the computer.

7. Push the replacement fan assembly into the computer until it clicks into place.
8. Connect the fan cable to the system board.
9. Replace the cover on the computer; then, reinstall the computer in the rack and connect all external cables. For more information, see "Installing the cover" on page 53 for instructions.

10. Start up the computer, the system error light will either remain on or turn off. If the system error light remains on, you will have to turn off the computer to perform further troubleshooting.

Installing the cover

The following information describes the cover installation procedure.

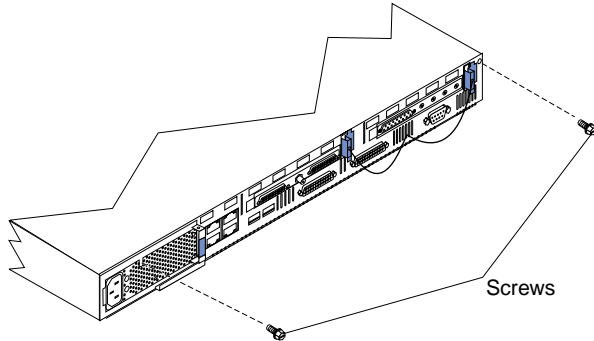

Complete the following to install the computer cover:

1. Clear any cables that might impede the replacement of the clear shield or the cover.
2. Install the clear shield, if it was removed.
Attention: Before sliding the cover forward, make sure that all of the tabs on the cover will engage the ledge at the front of the computer properly. If all the tabs do not engage the ledge properly, it will be extremely difficult to remove the cover later.
3. Install the cover by placing it into position and sliding it forward. Make sure the cover engages the tabs at the front and rear of the computer.
4. Install the screws and secure the cover as shown.
5. Reinstall the computer in the rack.
6. Reconnect the power cord and all external cables to the computer, then plug the power cords into electrical outlets.

I/O connector locations and ports

The following illustration shows the input/output connectors (ports) and the expansion slots on the rear of the computer. For pin assignments and other details about these connectors, see “Input/Output ports”.

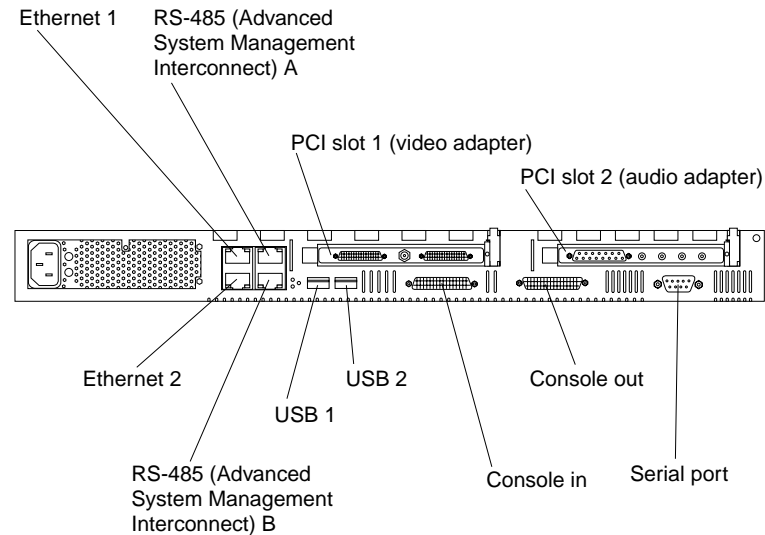

Input/Output ports

This section provides information about the input/output (I/O) ports on your computer. These ports include the following:

- Console ports
- Serial port
- Universal Serial Bus (USB) ports
- Ethernet ports
- Advanced System Management (ASM) ports
- Audio ports
- Video ports

Console ports

There are two console ports on the rear of your computer labeled IN and OUT. Use only the OUT port to connect the computer to the console (mouse and keyboard).

Device breakout cable

A keyboard and mouse or pointing device are connected to your computer through the device breakout cable. The keyboard and mouse cables have icons of a keyboard and a mouse on their respective cable connectors for easy identification.

Note: Do not use the monitor connector on this device breakout cable. Instead, use the monitor connector cables that comes with the video adapter. The part numbers for these cables are P/N 15912-01 and P/N 15941-00.

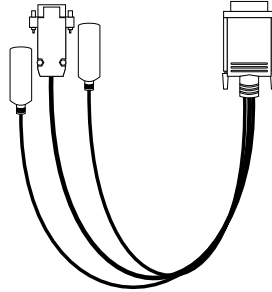

Keyboard connector: There is one keyboard connector on the end of the device breakout cable. This connector is identified by the keyboard icon.

Note: If you attach a standard (non-USB) keyboard to the keyboard connector, the USB ports and devices will be disabled during the power-on self-test (POST).

The following table shows the pin-number assignments for the keyboard connector on the end of the cable.

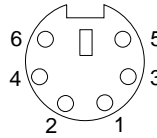

Table 4. Keyboard-connector (6-pin female) number assignments .

Pin	I/O	Signal
1	I/O	Data
2	N/A	Reserved
3	N/A	Ground
4	N/A	+5 V dc
5	I/O	Keyboard clock
6	N/A	Reserved

Auxiliary-device (pointing device) connector: On the end of the device breakout cable, there is one auxiliary-device connector that supports a mouse or other pointing device. This connector is identified by the mouse icon.

The following table shows the pin-number assignments for the auxiliary-device connector on the end of the cable.

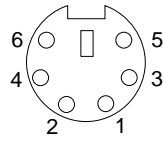

Table 5. Auxiliary or pointing-device-connector (6 pin female) number assignments .

Pin	Signal
1	Data
2	Not connected
3	Ground
4	+5 V dc
5	Clock
6	Not connected

Using the computer as a remote console

If you plan to install the computer in a rack away from the end-user workspace, you must purchase a third-party KVM Extender System to provide communication between the keyboard, mouse, and monitor.

Refer to the KVM Extender System documentation for instructions on installation and setup.

Serial port

Your computer has one standard serial port. Some application programs require specific ports, and some modems function properly only at certain communication port addresses. You might need to use the Configuration/Setup Utility program to change communication port address assignments to prevent or resolve address conflicts. This serial port is also manually configurable from inside of the computer. The following table lists the function of each of the connectors that you can use to manually configure the serial port. You will also need to refer to the figure in "System board options connectors" on page 26.

Table 6. Serial port connectors on the system board.

Connectors	Port	Description
J52	Serial A/Systems Management Port	Default connection. Used by OS and Advanced System Management Processor. Modem can be connected so that the system can dial out during problems.
J51	Serial Port B	Used by OS only.
J53	Management Port	Used by Advanced System Management Processor to utilize modem dial up functions.

Viewing or changing the serial-port assignments: To view or change the serial-port assignments:

1. Restart the computer and watch the monitor screen.
2. When the message Press F1 for Configuration/Setup appears, press F1.
3. From the main menu, select **Devices and I/O Ports**; then, press Enter.
Note: The Devices and I/O Ports choice appears only on the full configuration menu. If you set two levels of passwords, you must enter the administrator password to access the full configuration menu.
4. Select the serial port; then, use the arrow keys to advance through the settings available.
5. Select **Save Settings**; then select **Exit Setup** to exit from the Configuration/Setup Utility main menu.

Serial-port connector: The following table shows the pin-number assignments for the 9-pin, male D-shell serial-port connector on the rear of your computer. These pin-number assignments conform to the industry standard.

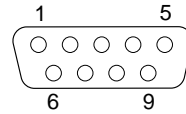

Table 7. Serial-port connectors pin-number assignments.

Pin	Signal	Pin	Signal
1	Data carrier detect	6	Data set ready
2	Receive data	7	Request to send
3	Transmit data	8	Clear to send
4	Data terminal ready	9	Ring indicator
5	Signal ground		

Universal Serial Bus ports

Your computer has two Universal Serial Bus (USB) ports, which configure automatically. USB is an emerging serial interface standard for telephony and multimedia devices. It uses Plug and Play technology to determine the type of device attached to the connector.

Notes:

1. If you attach a standard (non-USB) keyboard to the keyboard connector, the USB ports and devices will be disabled during the power-on self-test (POST).
2. If you install a USB keyboard that has a mouse port, the USB keyboard emulates a mouse and you will not be able to disable the mouse settings in the Configuration/Setup Utility program.

USB cables and hubs: You need a 4-pin cable to connect devices to USB 1 or USB 2. If you plan to attach more than two USB devices, you must use a hub to connect the devices. The hub provides multiple connectors for attaching additional external USB devices.

USB technology provides up to 12 megabits-per-second (Mbps) speed with a maximum of 127 external devices and a maximum signal distance of five meters (16 ft) per segment.

USB-port connectors: Each USB port has an external connector on the rear of the computer for attaching USB compatible devices.

The following table shows the pin-number assignments for the USB-port connectors on the rear of your computer.

Table 8. USB-port connector pin-number assignments.

Pin	Signal
1	VCC
2	-Data
3	+Data
4	Ground

Ethernet ports

Your computer comes with two integrated Ethernet controllers. These controllers provide an interface for connecting to 10-Mbps or 100-Mbps networks and provide full-duplex (FDX) capability, which enables simultaneous transmission and reception of data on the Ethernet local area network (LAN).

To access the Ethernet ports, connect a Category 3, 4 or 5 unshielded twisted-pair (UTP) cable to the RJ-45 connector on the rear of your computer.

Note: The 100BASE-TX Fast Ethernet standard requires that the cabling in the network be Category 5 or higher.

Configuring the Ethernet controllers: When you connect your computer to the network, the Ethernet controllers automatically detect the data-transfer rate (10Mbps or 100Mbps) on the network and then set the controllers to operate at the appropriate rate. In addition, if the Ethernet ports that your computer is connected to support auto-negotiation, the Ethernet controllers set the appropriate duplex state. That is, the Ethernet controllers adjust to the network data rate, whether the data rate is standard Ethernet (10BASE-T), Fast Ethernet (100BASE-TX), half duplex (HDX), or full duplex (FDX). The controllers support half-duplex (HDX) and full-duplex (FDX) modes at both speeds.

The Ethernet controllers are PCI Plug and Play devices. You do not need to set any jumpers or configure the controllers for your operating system before you use the Ethernet controllers. However, you must install a device driver to enable the operating system to address the Ethernet controllers.

Failover for redundant Ethernet: There are two Ethernet ports on your computer. You can configure your computer to failover from one port to another port or to an optional NIC adapter. The IBM 10/100 Ethernet Adapter or the IBM 10/100 Etherjet PCI family of adapters are optional redundant network interface cards (NIC adapter) that you can install in your computer. If you install this NIC adapter and connect it to the same logical segment as the primary Ethernet controller, you can configure the computer to support a *failover* function. You can configure either one of the integrated Ethernet controllers or the NIC adapter as the primary Ethernet controller. In failover mode, if the primary Ethernet controller detects a link failure, all Ethernet traffic associated with it is switched to the redundant (secondary) controller. This switching occurs without any user intervention. When the primary link is restored to an operational state, the Ethernet traffic switches back to the primary Ethernet controller.

High Performance Ethernet Modes: Your Ethernet controllers support optional modes, such as teaming, priority packets, and virtual LANs, which provide higher performance and throughput for your computer.

Teaming Mode: Your Ethernet controllers provide options, called *teaming options*. These options increase throughput and fault tolerance when running with Windows NT 4.0 and Windows 2000.

- **Adapter fault tolerance (AFT)** provides automatic redundancy for your adapter. If the primary adapter fails, the secondary adapter takes over. Adapter fault tolerance supports from 2 to 4 adapters per team.
- **Adaptive load balancing (ALB)** enables you to balance the transmission data flow among 2 to 4 adapters. ALB also includes the AFT option. You can use ALB with any 100BASE-TX switch.
- **Cisco Fast EtherChannel (FEC)** creates a team of 2 to 4 adapters to increase transmission and reception throughput. FEC also includes the AFT option. You can only use FEC with a switch that has FEC capability.

Teaming requires you to install both integrated Ethernet controllers. For additional information about the teaming modes, refer to the documentation that comes with these additional adapters.

Priority Packet Mode: Priority Packet is a traffic-prioritization utility that enables you to set up filters to process high-priority traffic before normal traffic. You can send information from critical nodes or applications with an indicated priority. Because you set this priority at the host or entry point of the network, the network devices can base forwarding decisions on priority information defined in the packet.

Priority Packet information is available on the IBM Networking Web site at:
<http://www.ibm.com/networking/support>

Priority Packet prioritizes traffic based on priority filters. These are parameters you assign to outgoing (transmit) packets. Using the Priority Filter Wizard, you can set up predefined or custom priority filters based on a node (MAC) address, Ethernet type, or by various properties of the protocol and port. Priority Packet provides two different methods for prioritizing traffic: IEEE 802.1p tagging and High Priority Queue.

IEEE 802.1p is a new IEEE standard for tagging, or adding additional bytes of information to packets with different priority levels. Packets are tagged with 4 additional bytes, which increase the packet size and indicate a priority level. When you send these packets out on the network, the higher priority packets are transferred first. Priority packet tagging (also known as Traffic Class Expediting) allows the adapter to work with other elements of the network (such as switches and routers) to deliver priority packets first. You can assign specific priority levels from 0 (low) to 7 (high).

You can assign values to packets based on their priority when you use the IEEE 802.1p standard for packet tagging. This method requires a network infrastructure that supports packet tagging. The routing devices receiving and transferring these packets on your network must support 802.1p for tagging to be effective.

After you set up the priority filter in Priority Packet, you must launch PROSet[®] and select **802.1p/802.1Q Tagging** on the Advanced tab.

Note: IEEE 802.1p tagging increases the size of the packets it tags. Some hubs and switches will not recognize the larger packets and will drop them. Check your hub or switch documentation to see if they support 802.1p. (You can configure the switch to strip the tags from the packets and send it on to the next destination as normal traffic). If these devices do not support 802.1p or if you are not sure, use High Priority Queue (HPQ) to prioritize network traffic.

The requirements for effectively using IEEE 802.1p tagging are:

- The other devices receiving and routing 802.1p tagged packets must support 802.1p.

- The adapters on these devices must support 802.1p. The Ethernet controller in your computer, all IBM Netfinity 10/100 Ethernet Security Adapters, and IBM 10/100 Ethernet Server Adapters support 802.1p.
- The adapter cannot be assigned to an adapter team.
- If you are setting up VLANs and packet tagging on the same adapter, 802.1p/802.1Q Tagging must be enabled on the PROSet Advanced tab.

If your network infrastructure devices do not support IEEE 802.1p or you are not sure, you can still define filters and send packets as high priority. While High Priority Queue (HPQ) does not provide the precise priority levels of 802.1p tagging, it does assign traffic as either high or low priority and sends high priority packets first. Therefore, if there are multiple applications on a system sending packets, the packets from the application with a filter are sent out first. HPQ does not change network routing, nor does it add any information to the packets.

To assign HPQ, you can specify it using Priority Packet when you create or assign a filter.

To effectively use HPQ, the adapter cannot be assigned to an adapter team.

Virtual LAN Mode: A virtual LAN (VLAN) is a logical grouping of network devices put together as a LAN, regardless of their physical grouping or collision domains. Using VLANs increases network performance and improves network security.

VLANs offer you the ability to group users and devices together into logical work-groups. This can simplify network administration when connecting clients to computers that are geographically dispersed across the building, campus, or enterprise network.

Normally, VLANs are configured at the switch and any computer can be a member of one VLAN per installed network adapter. Your Ethernet controller supersedes this by communicating directly with the switch, allowing multiple VLANs on a single network adapter (up to 64 VLANs).

To set up VLAN membership, your Ethernet controller must be attached to a switch that has VLAN capability. You also need to use Windows 2000 or Windows NT 4.0 with Service Pack 5.0 or later.

Notes:

1. Windows NT versions prior to 4.0 do not support VLANs.
2. VLANs require NT 4.0 with Service Pack 5.0 and the NDIS driver hotfix from Microsoft.

To join a VLAN from Windows NT 4.0 and Windows 2000:

Note: To add or remove a VLAN in Windows 2000, you must use PROSet. Do not use Network and Dial-up Connections dialog boxes to enable and disable VLANs because the VLAN driver might not be enabled or disabled correctly. Once a VLAN has been disabled in Windows 2000, you cannot re-enable the VLAN. Instead, you must restart the computer to re-enable the connection.

1. Create a VLAN on the switch. Use the parameters you assign there to join the VLAN from the computer. Refer to your switch documentation for more information.
2. Double-click the **Network icon** in the **Control Panel** window.
3. On the **Adapters** tab, select the adapter you want to be on the VLAN and select **Properties**.
4. In the PROSet window, select the adapter that you want to be on a VLAN and right-click on it.
5. Select **Add VLAN**.
6. Enter the VLAN ID and VLAN name. The VLAN ID must match the VLAN ID of the switch. The ID range is from 1 to 4094. The VLAN name is for information only and does not need to match the name on the switch.
7. Repeat steps 3 through 5 for each VLAN you want the computer to join. Click on the plus sign (+) next to the selected adapter to view the VLANs you added.
8. Click **OK**.

Ethernet port connector: The following table shows the pin-number assignments for the RJ-45 connector. These assignments apply to both 10BASE-T and 100BASE-TX devices.

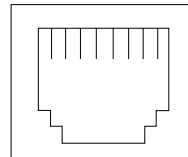

Table 9. Ethernet RJ-45 connector pin-number assignments..

Pin	Signal	Pin	Signal
1	Transmit data+	5	Not connected
2	Transmit data-	6	Receive data -
3	Receive data+	7	Not connected
4	Not connected	8	Not connected

Advanced System Management ports

There are two kinds of Advanced System Management ports: Management port (Serial port A) and RS-485 ports.

Management Port (Serial port A)

This port uses a standard D-shell serial-port connector, labeled A on the rear of the computer. You can attach a dedicated modem to the D-shell connector on the rear of your computer to communicate with the integrated Advanced System Management Processor. For more information about the serial port, see "Serial port" on page 57.

RS-485 ports

The RS-485 ports on the rear of your computer enables you to connect the Advanced System Management Processors of several rack-mounted computers so that they can communicate with each other in half-duplex mode.

Audio ports

The audio adapter ports are standard ports. Your computer has an integrated audio controller. Using the audio controller, you can record sound and music. You can also play sound with multimedia applications. The following illustration shows the location of the audio adapter connectors and ports.

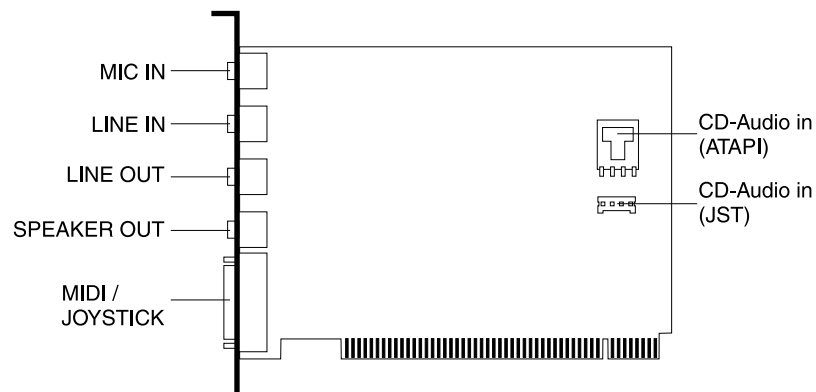

Video ports

Refer to the video adapter documentation that shipped with your computer for information on the input/output connector locations and ports.

Working with cables

The following illustration shows the location of the connectors on the back of your computer.

The ASM connectors on the back of the computer are referred to in this book as RS-485 (A) and RS-485 (B).

Note: The illustrations in this document might differ slightly from your hardware.

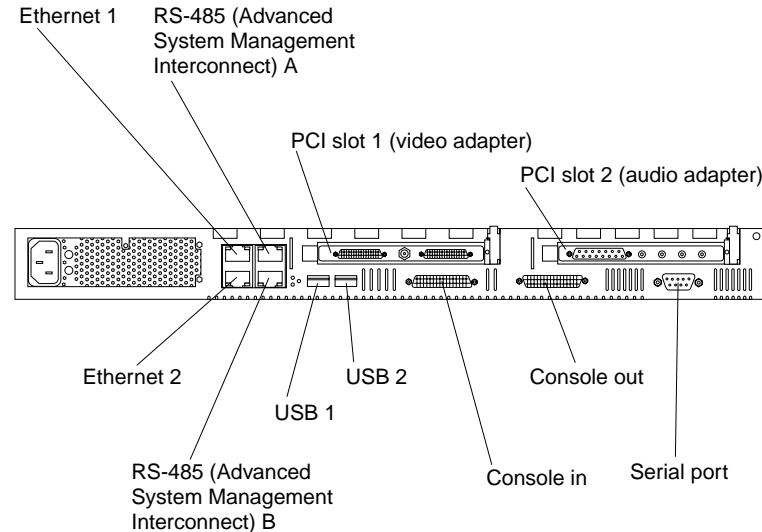

Cabling the RS-485 ports

You can use the RS-485 connectors to create an Advanced System Management (ASM) bus between several R Pro computers or other model computers.

Before you begin, review the following:

Important: The Advanced System Management bus is designed to support up to 12 units or computers. However, when using the Advanced System Management PCI adapter, the bus uses the PCI adapter as another unit. In this case, you can connect a maximum of 11 units or computers together.

- You can hot-swap the cables in the Advanced System Management (ASM) bus.
- You can connect up to 12 units together if you are using serial (management) port A as your Advanced System Management port.
- When connecting an R Pro computer to another computer type, you must install an Advanced System Management adapter in PCI slot 1 or use the serial port as your Advanced System Management port.
- Use standard cables with RJ-14 connectors.

Note: For more information about the Advanced System Management PCI adapter refer to the documentation that came with the adapter.

Connecting the ASM bus

The computers in the Advanced System Management (ASM) bus are referenced by their assigned addresses and not their position in the rack.

Complete the following steps to connect the ASM bus:

1. Turn off the computers.

2. Locate the RS-485 ports on the rear of the computers and several cables with RJ-14 connectors on both ends.
3. Starting at the top computer in the ASM bus, connect one end of the cable into the RS-485 (B) port and the other end of the cable into the RS-485 (A) port of the next computer.
4. Continue connecting the computers together in this manner until you reach the second to last computer in the ASM bus.
5. Connect a cable from the RS-485 (B) port of the second to last computer to the RS-485 (B) port of the last computer. Refer to the following illustration to see how to connect the ASM bus.

Note: The illustrations in this document might differ slightly from your hardware.

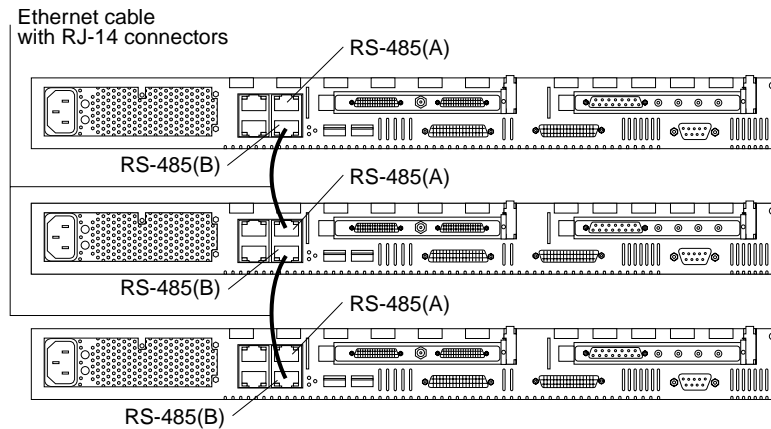

6. Turn on the computers.

Cable management

Use the cable ties and hook-and-loop straps that are supplied with your computer to secure the cables.

Note: Do not secure cables too tightly. Over tightening can cause internal damage to cables.

Chapter 6. Solving Problems

This section provides basic troubleshooting information to help you resolve some common problems that might occur with your computer.

If you cannot locate and correct the problem using the information in this section, refer to “Getting information, help, and service” on page 110 for more information.

Diagnostic tools overview

The following tools are available to help you identify and resolve hardware-related problems:

- **POST beep codes, error messages, and error logs**

The power-on self-test (POST) generates beep codes and messages to indicate successful test completion or the detection of a problem. See “POST” on page 69 for more information.

- **Diagnostic programs and error messages**

The computer diagnostic programs are stored in upgradable read-only memory (ROM) on the system board. These programs are the primary method of testing the major components of your computer. See “Diagnostic programs and error messages” on page 82 for more information.

- **Light Path Diagnostics**

You can use the Light Path Diagnostics™ to quickly identify system errors.

- **Troubleshooting charts**

These charts list problem symptoms, along with suggested steps to correct the problems. See the “Troubleshooting charts” on page 99 for more information.

- **Customized support page**

You can create a customized support page that is specific to your hardware, complete with Frequently Asked Questions, Parts Information, Technical Hints and Tips, and Downloadable files. In addition, you can choose to receive electronic mail (e-mail) notifications whenever new information becomes available about your registered products.

After you register and profile your IBM products, you can diagnose problems using the IBM Online Assistant and you can participate in the IBM discussion forum. For more detailed information about registering and creating a customized profile for your IBM products, visit the following addresses on the Web:

- <http://www.ibm.com/pc/register>
- <http://www.ibm.com/pc/support>

Computer Support

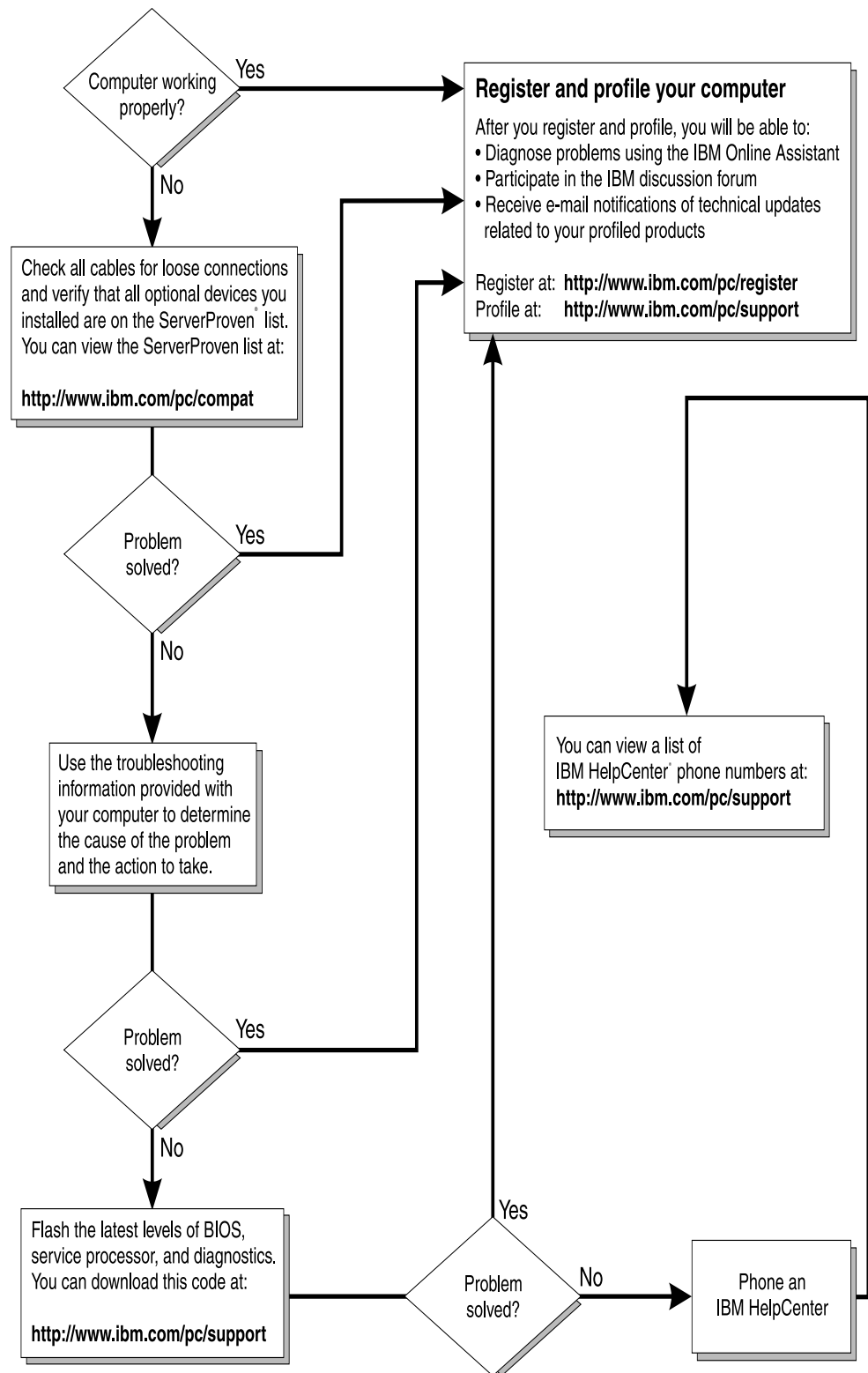

POST

When you turn on the computer, it performs a series of tests to check the operation of computer components and some of the options installed on the computer. This series of tests is called the power-on self-test or POST.

If POST finishes without detecting any problems, a single beep sounds and the first screen of your operating system or application program appears.

If POST detects a problem, more than one beep sounds and an error message appears on your screen. See “POST beep code descriptions” on page 70 and “POST error messages” on page 73 for more information.

Notes:

1. If you have a power-on password set, you must type the password and press Enter, when prompted, before POST will continue.
2. A single problem might cause several error messages. When this occurs, work to correct the cause of the first error message. After you correct the cause of the first error message, the other error messages usually will not occur the next time you run the test.

POST beep code descriptions

Beep codes are sounded in a series of beeps. For example, a 1-2-4 beep code sounds like one beep, a pause, two consecutive beeps, another pause, and four more consecutive beeps.

The possible types of beep codes that your computer might emit include the following:

No beeps

If no beep occurs after your computer completes POST, call for service.

Continuous beep

Your startup (boot) microprocessor has failed, or your system board or speaker subsystem might contain a failing component. If the system continues through POST with no errors, call for service. If no video appears, the startup processor has failed. Replace the startup processor.

One short beep

One beep indicates that your computer successfully completed POST. POST detected no configuration or functional errors. One beep also occurs after your computer completes POST if you enter an incorrect power-on password.

Two short beeps

POST encountered an error. The Configuration/Setup Utility program will display additional information; follow the instructions that appear on the screen. See "POST error messages" on page 73 for descriptions of the text messages that might appear.

Three short beeps

A system memory error has occurred. This combination occurs only if the video Basic Input/Output System (BIOS) cannot display the error message. Replace the failing memory module.

Repeating short beeps

The system board might contain a failing component, your keyboard might be defective, or a key on the keyboard might be stuck. Ensure that:

1. Nothing is resting on the keyboard and pressing a key.
2. No key is stuck.
3. The keyboard cable is connected correctly to the keyboard and to the correct connector on the computer.

Running the diagnostic tests can isolate the computer component that failed, but you must have your system serviced. If the error message remains, call for service.

Note: If you just connected a new mouse or other pointing device, turn off the computer and disconnect that device. Wait at least 5 seconds; then, turn on the computer. If the error message goes away, replace the device.

One long and one short beep

POST encountered an error on a video adapter. If you are using the integrated video controller, call for service. If you are using an optional video adapter, replace the failing video adapter.

One long and two short beeps

A video I/O adapter ROM is not readable, or the video subsystem is defective. If you hear this beep combination twice, both the system board and an optional video adapter have failed the test. This beep combination might also indicate that the system board contains a failing component.

One long and three short beeps

The system-board video subsystem has not detected a monitor connection to the computer. Ensure that the monitor is connected to the computer. If the problem persists, replace the monitor.

Two long and two short beeps

POST does not support the optional video adapter. This beep combination occurs when you install a video adapter that is incompatible with your computer. Replace the optional video adapter with one that the computer supports or use the integrated video controller.

POST beep codes

Beep code	Description	Action
1-1-2	Microprocessor register test has failed.	Call for service.
1-1-3	CMOS write/read test has failed.	
1-1-4	BIOS ROM checksum has failed.	
1-2-1	Programmable Interval Timer test has failed.	
1-2-2	DMA initialization has failed.	
1-2-3	DMA page register write/read test has failed.	
1-4-3	Interrupt vector loading test has failed.	
2-1-1	Secondary DMA register test has failed.	
2-1-2	Primary DMA register test has failed.	
2-1-3	Primary interrupt mask register test has failed.	
2-1-4	Secondary interrupt mask register test has failed.	
2-2-1	Interrupt vector loading has failed.	
2-2-2	Keyboard controller test has failed.	
2-2-3	CMOS power failure and checksum checks have failed.	
2-2-4	CMOS configuration information validation has failed.	
2-3-2	Screen memory test has failed.	
2-3-3	Screen retrace tests have failed.	
2-3-4	Search for video ROM has failed.	
2-4-1	Screen test indicates the screen is operable.	
3-1-1	Timer tick interrupt test has failed.	
3-1-2	Interval timer channel 2 test has failed.	
3-1-3	RAM test has failed above address hex 0FFFF.	
3-1-4	Time-of-Day clock test has failed.	
3-2-1	Serial port test has failed.	
3-2-2	Parallel port test has failed.	
3-2-4	Comparison of CMOS memory size against actual has failed.	
3-3-2	I2C bus has failed.	

Table 10. POST beep codes.

2-3-1	Screen initialization has failed.	Turn off the computer and then restart the computer. If the problem persists, call for service.
1-2-4	RAM refresh verification has failed.	Reseat the memory modules or install a memory module. If the problem persists, call for service.
1-3-1	First 64 Kb RAM test has failed.	
1-3-2	First 64 Kb RAM parity test has failed.	
3-3-1	A memory size mismatch has occurred.	
3-3-3	Attention: In some memory configurations, the 3-3-3 beep code might sound during POST followed by a blank display screen. If this occurs and the Boot Fail Count feature in the Start Options of the Configuration/Setup Utility is set to Enabled (its default setting), you must restart the computer three times to force the system BIOS to reset the memory connector or bank of connectors from Disabled to Enabled.	

Table 10. POST beep codes.

POST error messages

The following tables provide information about the POST error messages that can appear during startup.

POST message	Description
062	<p>The computer failed to boot on three consecutive attempts.</p> <p>All caches are disabled. Repeatedly turning the computer on and then off or resetting the computer might cause this problem.</p> <p>Action: Start the Configuration/Setup Utility program and verify that all settings are correct. Use the Cache Control selection in the Advanced Setup menu of the Configuration/Setup Utility program to enable the caches.</p> <p>If the problem persists, call for service. When the problem is corrected, be sure to enable the caches.</p>
101 102 106	<p>An error occurred during the system board and microprocessor test.</p> <p>Action: Call for service.</p>
114	<p>An adapter read-only memory (ROM) error occurred.</p> <p>Action: Remove the options. If you can start the computer without the options installed, reinstall each option one at a time and retest after each is reinstalled. When an option fails, replace it.</p> <p>If you cannot isolate and correct the problem, call for service.</p>
129	<p>An error was detected in the L1 cache of one of the microprocessors.</p> <p>Action:</p> <ol style="list-style-type: none"> 1. If you just installed a microprocessor, verify that the microprocessor is installed and seated correctly. 2. If the problem persists, call for service.
151	<p>A real-time clock (RTC) error occurred.</p> <p>Action: Call for service.</p>
161	<p>The real-time clock battery has failed.</p> <p>Action: Replace the battery yourself or call for service.</p> <p>You can use the computer until you replace the battery. However, you must run the Configuration/Setup Utility program and set the time and date and other custom settings each time you turn on the computer.</p>
162	<p>A change in device configuration occurred. This error occurs under one or more of the following conditions:</p> <ul style="list-style-type: none"> • A new device has been installed. • A device has been moved to a different location or cable connection. • A device has been removed or disconnected from a cable. • A device is failing and is no longer recognized by the computer as being installed. • An external device is not turned on. • An invalid checksum is detected in the battery-backed memory. <p>Action: Verify that all external devices are turned on. You must turn on external devices before turning on the computer.</p> <p>If you did not add, remove, or change the location of a device, a device is probably failing. Running the Diagnostic program might isolate the failing device.</p> <p>If you cannot isolate and correct the problem, call for service.</p>

Table 11. POST error messages.

POST message	Description
163	<p>The time of day has not been set.</p> <p>Action: Set the correct date and time. If the date and time are set correctly and saved, but the 163 error message reappears, call for service.</p> <p>You can use the computer until the system is serviced, but any application programs that use the date and time will be affected.</p>
164	<p>A change in the memory configuration occurred. This message might appear after you add or remove memory.</p> <p>Note: The computer can be used with decreased memory capacity.</p> <p>Action: 1. If POST error message 289 also occurred, follow the instructions for that error message first.</p> <p>2. If you just installed or removed memory, run the Configuration/Setup Utility program; then, exit, saving the new configuration settings.</p> <p>If the message appears again, shut down the computer, reseal the memory modules, and restart the computer.</p> <p>If the problem persists, call for service.</p>
175	<p>A vital product data (VPD) error occurred.</p> <p>Action: Call for service.</p>
176 177 178	<p>A security hardware error occurred.</p> <p>Action: Check for indications that someone has tampered with the computer. If no one has tampered with the computer, call for service.</p>
184	<p>The power-on password information stored in your computer has been removed.</p> <p>Action: From the Configuration/Setup Utility program main menu, select System Security. Then, follow the instructions on the screen.</p> <p>If this information cannot be restored, call for service.</p>
185	<p>A power failure damaged the stored information about the drive-startup sequence.</p> <p>Action: From the Configuration/Setup Utility program main menu, select Start Options; then, follow the instructions on the screen.</p> <p>If this information cannot be restored, call for service.</p>
186	<p>A system board or hardware error occurred.</p> <p>Action: Call for service.</p>
187	<p>The VPD serial number is not set.</p> <p>Action: The system serial number is set in the VPD EEPROM at the time of manufacturing. If the system board has been replaced, the system serial number will be invalid and should be set. From the main menu of the Configuration/Setup Utility program, select System Information, then select Product Data. If the problem persists, call for service.</p>
188	<p>A vital product data (VPD) error occurred.</p> <p>Action: Call for service.</p>
189	<p>An attempt has been made to access the computer with invalid passwords. After three incorrect attempts, the computer locks up; that is, the logon data fields are no longer available to the user.</p>

Table 11. POST error messages.

POST message	Description
201	<p>An error occurred during the memory controller test. This error can be caused by:</p> <ul style="list-style-type: none"> • Incorrectly installed memory • A failing memory module • A system board problem <p>Action: 1. If you just installed memory, verify that the new memory is correct for your computer. Also verify that the memory is installed and seated correctly. 2. If the problem persists, call for service.</p>
229	<p>An error was detected in the L2 cache of one of the microprocessors.</p> <p>Action: 1. If you just installed a microprocessor, verify that the microprocessor is installed and seated correctly. 2. If the problem persists, call for service.</p>
289	<p>An error occurred during POST memory tests and a failing DIMM was disabled.</p> <p>Note: You can use the computer with decreased memory.</p> <p>Action: 1. If you just installed memory, verify that the new memory is correct for your computer. Also verify that the memory is installed and seated correctly. Start the Configuration/Setup Utility program and select Memory Settings from the Advanced Setup menu to enable the DIMM. 2. If the problem remains, replace the failing DIMM.</p> <p>If the problem persists, call for service.</p>
301 303	<p>An error occurred during the keyboard and keyboard controller test. These error messages also might be accompanied by continuous beeping.</p> <p>Action: Ensure that:</p> <ol style="list-style-type: none"> 1. Nothing is resting on the keyboard and pressing a key. 2. No key is stuck. 3. The keyboard cable is connected correctly to the keyboard and to the correct connector on the computer. <p>Running the diagnostic tests can isolate the computer component that failed, but you must have your system serviced. If the error message remains, call for service.</p> <p>Note: If you just connected a new mouse or other pointing device, turn off the computer and disconnect that device. Wait at least 5 seconds; then, turn on the computer. If the error message goes away, replace the device.</p>
602	<p>Invalid diskette boot record</p> <p>Action: 1. Replace the diskette. 2. If the problem persists, make sure that the diskette drive cables are correctly and securely connected. 3. If the problem remains, replace the diskette drive.</p> <p>If the problem persists, call for service.</p>
604	<p>An error occurred during a diskette drive test.</p> <p>Action: 1. Verify that the Configuration/Setup Utility program correctly reflects the type of diskette drive that you have installed. 2. Run the diagnostic tests. If the diagnostic tests fail, call for service.</p>
662	<p>A diskette drive configuration error occurred.</p> <p>Action: If you removed a diskette drive, make sure that the diskette drive setting is correct in the Configuration/Setup Utility program. If the setting is not correct, change it.</p> <p>If the problem persists, call for service.</p>

Table 11. POST error messages.

POST message	Description
962	<p>A parallel port configuration error occurred.</p> <p>Action: If you changed a hardware option, make sure that the parallel port setting is correct in the Configuration/Setup Utility program. If the setting is not correct, change it.</p> <p>If the problem persists, call for service.</p>
11xx	<p>An error occurred during the system-board serial port test.</p> <p>Action: If you have a modem, serial printer, or other serial device attached to your computer, verify that the serial cable is connected correctly. If it is, use the following procedure:</p> <ol style="list-style-type: none"> 1. Turn off the computer. 2. Disconnect the serial cable from the serial port. 3. Wait five seconds; then, turn on the computer. <p>If the POST error message does not reappear, either the serial cable or the device is probably failing. See the documentation that comes with the serial device for additional testing information.</p> <p>If the POST error message reappears, call for service.</p>
1162	<p>The serial port configuration conflicts with another device in the system.</p> <p>Action:</p> <ol style="list-style-type: none"> 1. Make sure the IRQ and I/O port assignments needed by the serial port are available. 2. If all interrupts are being used by adapters, you might need to remove an adapter to make an interrupt available to the serial port, or force other adapters to share an interrupt.
1600	<p>The Advanced System Management processor is not functioning.</p> <p>Action:</p> <ol style="list-style-type: none"> 1. Verify that the jumpers for the system-management processor are set correctly. 2. Disconnect the computer from all electrical sources, wait for 30 seconds, reconnect the computer to the electrical sources, and restart the computer. <p>If the problem persists, call for service.</p>
1601	<p>An Advanced System Management Flash update is needed.</p> <p>Action: Download and install the latest Advanced System Management flash update.</p>
1800	<p>A PCI adapter has requested a hardware interrupt that is not available.</p> <p>Action:</p> <ol style="list-style-type: none"> 1. Make sure that the PCI adapter and all other adapters are set correctly in the Configuration/Setup Utility program. If the interrupt resource settings are not correct, change the settings. 2. If all interrupts are being used by other adapters, you might need to remove an adapter to make an interrupt available to the PCI adapter, or force other adapters to share an interrupt.

Table 11. POST error messages.

POST message	Description
1962	<p>No valid startup devices were found. The system cannot find the startup drive or operating system.</p> <p>Action: Be sure that the drive you want to start from is in the startup sequence.</p> <ol style="list-style-type: none"> 1. Select Start Options from the Configuration/Setup Utility program main menu. If you are unable to set the startup sequence, call for service. 2. Check the list of startup devices in the Startup device data fields. Is the drive you want to start from in the startup sequence? <ul style="list-style-type: none"> Yes Exit from this screen; then, select Exit Setup to exit the Configuration/Setup menu. Go to step 3.. No Follow the instructions on the screen to add the drive; then, save the changes and exit the Configuration/Setup menu. Restart the computer. 3. Is an operating system installed? <ul style="list-style-type: none"> Yes Turn off the computer. Go to step 4.. No Install the operating system in your computer; then, follow your operating system instructions to shut down and restart the computer. 4. During computer startup, watch for messages indicating a hardware problem. <p>If the same error message appears, call for service.</p>
2400	<p>An error occurred during the testing of the video controller on the system board. This error can be caused by a failing monitor, a failing system board, or a failing video adapter (if one is installed).</p> <p>Action: Verify that the monitor is connected correctly to the video connector. If the monitor is connected correctly, call for service.</p>
2462	<p>A video memory configuration error occurred.</p> <p>Action: Make sure that the monitor cables are correctly and securely connected to the computer.</p> <p>If the problem persists, call for service.</p>
5962	<p>An IDE CD-ROM configuration error occurred.</p> <p>Action: Check the signal and power cable connections to the CD-ROM drive.</p> <p>If the problem persists, call for service.</p>
8603	<p>An error occurred during the mouse (pointing device) controller test. The addition or removal of a mouse, or a failing system board can cause this error.</p> <p>Note: This error also can occur if electrical power was lost for a very brief period and then restored. In this case, turn off the computer for at least 5 seconds; then, turn it back on.</p> <p>Action: Ensure that the keyboard and mouse (pointing device) are attached to the correct connectors. If they are connected correctly, use the following procedure:</p> <ol style="list-style-type: none"> 1. Turn off the computer. 2. Disconnect the mouse from the computer. 3. Turn on the computer. <p>If the POST error message does not reappear, the mouse is probably failing. See the documentation that comes with the mouse for additional testing information. If the problem remains, replace the mouse or pointing device.</p> <p>If the POST error message reappears, run the diagnostic tests to isolate the problem. If the diagnostic tests do not find a problem and the POST error message remains, call for service.</p>
00012000	<p>Processor machine check.</p> <p>Action: 1. Update the system BIOS.</p> <p>2. If the problem persists, replace the microprocessor.</p>

Table 11. POST error messages.

POST message	Description
00019501	<p>Processor 1 is not functioning.</p> <p>Action: Replace microprocessor 1.</p> <p>If the problem persists, call for service.</p>
00019502	<p>Processor 2 is not functioning.</p> <p>Action: Replace microprocessor 2.</p> <p>If the problem persists, call for service.</p>
00019701	<p>Processor 1 failed the built-in self test.</p> <p>Action: Replace microprocessor 1.</p> <p>If the problem persists, call for service.</p>
00019702	<p>Processor 2 failed the built-in self-test.</p> <p>Action: Replace microprocessor 2.</p> <p>If the problem persists, call for service.</p>
00180100	<p>A PCI adapter has requested memory resources that are not available</p> <p>Action:</p> <ol style="list-style-type: none"> 1. Make sure that the PCI adapter and all other adapters are set correctly in the Configuration/Setup Utility program. If the memory resource settings are not correct, change the settings. 2. If all memory resources are being used, you might need to remove an adapter to make memory available to the PCI adapter. Disabling the adapter BIOS on the adapter might correct the error. Refer to the documentation provided with the adapter.
00180200	<p>A PCI adapter has requested an I/O address that is not available, or the PCI adapter might be defective.</p> <p>Action:</p> <ol style="list-style-type: none"> 1. Make sure that the I/O address for the PCI adapter and all other adapters are set correctly in the Configuration/Setup Utility program. 2. If the I/O port resource settings are correct, the PCI adapter might be defective. Call for service.
00180300	<p>A PCI adapter has requested a memory address that is not available, or the PCI adapter might be defective.</p> <p>Action:</p> <ol style="list-style-type: none"> 1. Make sure that the memory address for all other adapters are set correctly in the Configuration/Setup Utility program. If the memory resource settings are not correct, change the settings. 2. If the memory resource settings are correct, the PCI adapter might be defective. Call for service.
00180400	<p>A PCI adapter has requested a memory address that is not available.</p> <p>Action: If all memory addresses are being used, you might need to remove an adapter to make memory address space available to the PCI adapter. Disabling the adapter BIOS on the adapter might correct the error. Refer to the documentation provided with the adapter.</p>
00180500	<p>A PCI adapter ROM error occurred.</p> <p>Action: Remove the PCI adapters. If you can start the computer without the adapters, reinstall each adapter one at a time and retest after each is reinstalled. When an adapter fails, replace it.</p> <p>If you cannot isolate and correct the problem, call for service.</p>

Table 11. POST error messages.

POST message	Description
00180600	<p>A PCI-to-PCI bridge error occurred. More than one PCI bus tried to access memory below 1 MB.</p> <p>Action: Remove the PCI adapter that has the PCI bridge. If you can start the computer without the adapter, reinstall and retest the adapter. If the adapter fails, replace it.</p> <p>If you cannot isolate and correct the problem, call for service.</p>
00180700	<p>xxxxyyyy Planar PCI device does not respond or disabled by user. (Where xxxx is the PCI vendor ID and yyyy is the PCI device ID.)</p> <p>Action: Start the Configuration/Setup Utility program, select Devices and I/O Ports, and make sure that the device is enabled. If the problem persists, call for service.</p>
00180800	<p>An unsupported PCI device is installed.</p> <p>Action: Remove the PCI adapters. If you can start the computer without the adapters, reinstall each adapter one at a time and retest after each is reinstalled. When an adapter fails, replace it.</p> <p>If the problem persists, call for service.</p>
00181000	<p>PCI error.</p> <p>Action: Remove the PCI adapters. If you can start the computer without the adapters, reinstall each adapter one at a time and retest after each is reinstalled. When an adapter fails, replace it.</p> <p>If the problem persists, call for service.</p>
01295085	<p>The ECC checking hardware test failed.</p> <p>Action: Call for service.</p>
01298001	<p>No update data is available for processor 1.</p> <p>Action: Update the system BIOS to a level that supports the microprocessors installed in the computer.</p>
01298002	<p>No update data is available for processor 2.</p> <p>Action: Update the system BIOS to a level that supports the microprocessors installed in the computer.</p>
01298101	<p>The update data for processor 1 is incorrect.</p> <p>Action: Update the system BIOS to a level that supports the microprocessors installed in the computer.</p>
01298102	<p>The update data for processor 2 is incorrect.</p> <p>Action: Update the system BIOS to a level that supports the microprocessors installed in the computer.</p>
01298200	<p>Microprocessor speed mismatch</p> <p>Action: The microprocessors installed do not run at the same speed; install microprocessors with identical speeds.</p>
I9990301	<p>A hard disk drive error occurred.</p> <p>Action: Call for service.</p>
I9990305	<p>POST could not find an operating system.</p> <p>Action: Install an operating system. If you have already installed the operating system, check the drive startup sequence. If the drive sequence is correct, run the diagnostic tests to verify that the hard disk drive is functioning correctly. If there is a problem with the hard disk drive (such as a bad sector), you might need to reinstall the operating system.</p> <p>If you cannot reinstall the operating system, call for service.</p>

Table 11. POST error messages.

POST message	Description
I9990650	AC power has been restored. Action: No action is required. This message appears each time AC power is restored to the computer after an AC power loss.
Other Numbers	POST found an error. Action: Follow the instructions on the screen.

Table 11. POST error messages.

Event/error logs

The POST error log contains the three most recent error codes and messages that the system generated during POST. The System Event/Error log contains all the messages issued during POST and all the system status messages from the Advanced System Management Processor.

To view the contents of this error log, start the Configuration/Setup Utility program; then, select **Event/Error Logs** from the main menu.

Small computer system interface messages

The following table lists actions to take if you receive a SCSI error message.

Note: If your computer does not have a hard disk drive, ignore any message that indicates that the BIOS is not installed.

You will get these messages only when running the SCSISelect Utility.

Table 12. SCSI messages.

SCSI Messages	Description
All	<p>One or more of the following might be causing the problem.</p> <ul style="list-style-type: none">• A failing SCSI device (adapter, drive, controller)• An improper SCSI configuration• Duplicate SCSI IDs in the same SCSI chain• An improperly installed SCSI terminator• A defective SCSI terminator• An improperly installed cable• A defective cable <p>Action:</p> <p>Verify that:</p> <ul style="list-style-type: none">• The external SCSI devices are turned on. External SCSI devices must be turned on <i>before</i> the computer.• The cables for all external SCSI devices are connected correctly.• The last device in each SCSI chain is terminated properly.• The SCSI devices are configured correctly. <p>If the above items are correct, run the diagnostic programs to obtain additional information about the failing device. If the error remains or recurs, call for service.</p>

Diagnostic programs and error messages

The computer diagnostic programs are stored in upgradable read-only memory (ROM) on the system board. These programs are the primary method of testing the major components of your computer.

Diagnostic error messages indicate that a problem exists; they are not intended to be used to identify a failing part. Troubleshooting and servicing of complex problems that are indicated by error messages should be performed by trained service personnel.

Sometimes the first error to occur causes additional errors. In this case, the computer displays more than one error message. Always follow the suggested action instructions for the *first* error message that appears.

The following sections contain the error codes that might appear in the detailed test log and summary log when running the diagnostic programs.

The error code format is as follows:

fff-ttt-iii-date-cc-text message

where:

- fff** is the three-digit function code that indicates the function being tested when the error occurred. For example, function code 089 is for the microprocessor.
- ttt** is the three-digit failure code that indicates the exact test failure that was encountered. (These codes are for trained service personnel and are described in the *Hardware Maintenance Manual*.)
- iii** is the three-digit device ID. (These codes are for trained service personnel and are described in the *Hardware Maintenance Manual*.)
- date** is the date that the diagnostic test was run and the error recorded.
- cc** is the check digit that is used to verify the validity of the information.
- text message** is the diagnostic message that indicates the reason for the problem.

Text messages

The diagnostic text message format is as follows:

Function Name: Result (test specific string)

where:

Function Name	is the name of the function being tested when the error occurred. This corresponds to the function code (fff) given in the previous list.
Result	can be one of the following:
Passed	This result occurs when the diagnostic test completes without any errors.
Failed	This result occurs when the diagnostic test discovers an error.
User Aborted	This result occurs when you stop the diagnostic test before it is complete.
Not Applicable	This result occurs when you specify a diagnostic test for a device that is not present.
Aborted	This result occurs when the test could not proceed because of the system configuration.
Warning	This result occurs when a possible problem is reported during the diagnostic test, such as when a device that is to be tested is not installed.
Test Specific String	This is additional information that you can use to analyze the problem.

Starting the diagnostic programs

You can press F1 while running the diagnostic programs to obtain Help information. You also can press F1 from within a help screen to obtain online documentation from which you can select different categories. To exit Help and return to where you left off, press Esc.

To start the diagnostic programs:

1. Turn on the computer and watch the screen.
2. When the message F2 for Diagnostics appears, press F2.
3. Type in the appropriate password; then, press **Enter**.
4. Select either **Extended** or **Basic** from the top of the screen.
5. When the Diagnostic Programs screen appears, select the test you want to run from the list that appears; then, follow the instructions on the screen.

Notes:

- a. If the computer stops during testing and you cannot continue, restart the computer and try running the diagnostic programs again. If the problem persists, call for service.
- b. The keyboard and mouse (pointing device) tests assume that a keyboard and mouse are attached to the computer.
- c. If you run the diagnostic programs with no mouse attached to your computer, you will not be able to navigate between test categories using the **Next Cat** and **Prev Cat** buttons. All other functions provided by mouse-selectable buttons are also available using the function keys.
- d. You can test the USB keyboard by using the regular keyboard test. The regular mouse test can test a USB mouse. Also, you can run the USB hub test only if there are no USB devices attached.
- e. You can view computer configuration information (such as system configuration, memory contents, interrupt request (IRQ) use, direct memory access (DMA) use, device drivers, and so on) by selecting **Hardware Info** from the top of the screen.

When the tests have completed, you can view the Test Log by selecting **Utility** from the top of the screen.

If the hardware is functioning correctly but the problem persists during normal computer operations, a software error might be the cause. If you suspect a software problem, refer to the information that comes with the software package.

Viewing the test log

The test log will not contain any information until after the diagnostic program has run.

Note: If you already are running the diagnostic programs, begin with step 3.

To view the test log:

1. Turn on the computer and watch the screen.
If the computer is on, shut down your operating system and restart the computer.
2. When the message `F2 for Diagnostics` appears, press F2.
If a power-on password is set, the computer prompts you for it. Type in the appropriate password; then, press Enter.
3. When the Diagnostic Programs screen appears, select **Utility** from the top of the screen.
4. Select **View Test Log** from the list that appears; then, follow the instructions on the screen.

The system maintains the test-log data while the computer is powered on. When you turn off the power to the computer, the test log is cleared.

Diagnostic error message tables

The following tables provide descriptions of the error messages that might appear when you run the diagnostic programs.

Attention: If diagnostic error messages appear that are not listed in the following tables, make sure that your computer has the latest levels of BIOS, and diagnostics microcode installed.

Code	Function	Result	Text message	Action
001	Core system	Failed	Processor board, ECC Test	Call for service.
			System board	
005	Video port		Processor and system boards	
011	Serial port		Integrated serial port	
014	Parallel port		Integrated parallel port	
015	USB interface	Aborted	Can NOT test USB interface while it is in use. Note: If you have a USB keyboard or mouse attached, you cannot run the diagnostic program for the USB interface.	<ol style="list-style-type: none"> 1. Turn off the computer. 2. Replace the USB keyboard and mouse with a standard keyboard and mouse. 3. Turn on the computer. 4. Run the diagnostic test again.
		Failed	System board	Call for service.
020	PCI interface	Failed	System board	Call for service.
030	SCSI interface	Failed	SCSI adapter in slot <i>n</i> failed register/counter/ power test (where <i>n</i> is the slot number of the failing adapter)	Refer to the information provided with the adapter for instructions. If the problem persists, call for service.
			SCSI controller on system board failed register/counter/power test	Call for service.
075	Power supply	Failed	Voltage sensed by the system is out of range	Call for service.

Table 13. Diagnostic error messages.

Code	Function	Result	Text message	Action
089	Microprocessor	Failed	Invalid microprocessor in slot xyz or BIOS setup problem (where xyz identifies the microprocessor that is causing the error message)	<ol style="list-style-type: none"> 1. Check the system error log for the related error messages. 2. If your computer does not have the latest level BIOS installed, update the BIOS. 3. If the problem remains, replace the xyz microprocessor and run the test again.
			Processor in socket id xyz is installed but not functioning (where xyz identifies the microprocessor that is causing the error message)	
			Microprocessor in socket id xyz (where xyz identifies the microprocessor that is causing the error message)	<ol style="list-style-type: none"> 1. Reseat the microprocessor. 2. If the problem remains, replace the microprocessor.
			Processor in socket id xyz is defective (where xyz identifies the microprocessor that is causing the error message)	<p>Replace the microprocessor.</p> <p>If the problem persists, call for service.</p>
			Test setup error: Application microprocessor not installed or BIOS setup problem	<ol style="list-style-type: none"> 1. Verify that the Application microprocessor is installed and seated correctly. 2. If your computer does not have the latest level BIOS installed, update the BIOS. 3. If the problem remains, replace the application microprocessor and run the test again. <p>If the problem persists, call for service.</p>

Table 13. Diagnostic error messages.

Code	Function	Result	Text message	Action
	Microprocessor	Failed	VRM corresponding to Microprocessor in socket xyz is defective (where xyz identifies the microprocessor whose VRM is causing the error message)	Replace the VRM. If the problem remains, call for service.
			VRM corresponding to Microprocessor in socket id xyz is not installed (where xyz identifies the microprocessor whose VRM is causing the error message)	Install a VRM. If the problem persists, call for service.
175	System thermal	Failed	Fan # <i>n</i> (where <i>n</i> is the number of the failing fan)	Replace the indicated fan.
			Temperature sensed on processor board is out of range	Call for service.
180	Status display	Failed	Any failure message	Call for service.
201	System memory	Failed	DIMMs in location DIMM <i>n</i> (where <i>n</i> is the number of the socket that contains the failing DIMM)	1. Reseat the failing DIMM. 2. If the problem remains, replace the DIMM. If the problem persists, call for service.
			Test setup error: Corrupt BIOS in ROM	If your computer does not have the latest level BIOS installed, update the BIOS to the latest level. If the problem persists, call for service.
			Test setup error: Corrupt DMI BIOS, information in BIOS is not as expected	

Table 13. Diagnostic error messages.

Code	Function	Result	Text message	Action
202	System cache	Aborted	Test setup error: BIOS cannot access VPD information	If your computer does not have the latest level BIOS installed, update the BIOS to the latest level and run the diagnostic program again. If the problem persists, call for service.
			Test setup error: Corrupt DMI BIOS. Information in BIOS is not as expected	
			Test setup error: No L2 cache detected on microprocessor socket id xyz or BIOS setup problem (where xyz identifies the microprocessor that is causing the error message)	1. If your computer does not have the latest level BIOS installed, update the BIOS to the latest level 2. Run the diagnostic program again. 3. If the problem remains, replace the failing processor. If the problem persists, call for service.
			Test setup error: Unknown hardware problem associated with microprocessor in socket id xyz. (where xyz identifies the microprocessor that is causing the error message)	
	Failed	Microprocessor in socket ID xyz (where xyz identifies the microprocessor that is causing the error message)	1. Reseat the identified microprocessor. 2. If the problem remains, replace the microprocessor. If the problem persists, call for service.	
		Warning	Test setup error: Cache is disabled. Use system setup to enable before retrying the test	Use the Cache Control choice from the Advanced Setup menu to enable the cache. If the problem persists, call for service.
206	Diskette drive	Failed	Internal diskette drive bay	Call for service.
215	CD-ROM	Failed	On system board.	Call for service.
		Aborted	The CD-ROM drive is not present.	Verify that the cables are properly connected to the CD-ROM. If the problem persists, call for service.
217	Hard disk drive	Failed	BIOS drive # <i>n</i> (where <i>n</i> is the drive bay number)	Call for service.

Table 13. Diagnostic error messages.

Code	Function	Result	Text message	Action
264	Magnetic tape drive	Aborted	Test setup error: No tape drive found	<p>Check the cable and power connections to the drive.</p> <p>Refer to the information that is provided with the tape drive.</p> <p>If the problem persists, call for service.</p>
		Failed	The load/mount test failed for device <i>n</i> on adapter <i>m</i> (where <i>n</i> is the number of the device and <i>m</i> is the adapter number)	<p>Refer to the information provided with the tape drive.</p> <p>If the problem persists, call for service.</p> <p>Note: The push button test is applicable only to SCSI tape drives that have a push button.</p>
			The Self-diagnostic failed for device <i>n</i> on adapter <i>m</i> . (where <i>n</i> is the number of the device and <i>m</i> is the adapter number)	
			The unload/eject test failed for device <i>n</i> on adapter <i>m</i> (where <i>n</i> is the number of the device and <i>m</i> is the adapter number)	
			The unload/eject push button test failed for device <i>n</i> on adapter <i>m</i> (where <i>n</i> is the number of the device and <i>m</i> is the adapter number)	
			The Read/Write Self-diagnostic failed for device <i>n</i> on adapter <i>m</i> (where <i>n</i> is the number of the device and <i>m</i> is the adapter number)	
	Insert a new tape cartridge; then, run the diagnostic test again.			
	Refer to the information that is provided with the tape drive.			
	If the problem persists, call for service.			
301	Keyboard	Failed	On system board keyboard test failed	<ol style="list-style-type: none"> 1. Verify that the keyboard cable is connected. 2. If the problem remains, replace the keyboard cable. <p>If the problem persists, call for service.</p>

Table 13. Diagnostic error messages.

Code	Function	Result	Text message	Action
302	Mouse	Failed	On system board pointing device test failed.	Replace the pointing device. If the problem persists, call for service.
305	Video monitor		Any message	Refer to the information that came with the monitor.
405	Ethernet	Failed	In PCI slot <i>n</i> (where <i>n</i> is the PCI slot number in which the failing Ethernet adapter is installed)	Replace the Ethernet adapter in slot <i>n</i> . If the problem persists, call for service.
			On system board	Call for service.

Table 13. Diagnostic error messages.

Code	Function	Result	Text message	Action
415	Analog/digital modem	Not applicable	No modem was detected	<ol style="list-style-type: none"> 1. Verify that the modem is properly attached to the computer. 2. If the problem remains, replace the modem. <p>If the problem persists, call for service.</p>
			PCI modem detected but not enabled	<ol style="list-style-type: none"> 1. Change the configuration to enable the modem. 2. If the problem remains, replace the modem. <p>If the problem persists, call for service.</p>
		Failed	Modem reset failed	<p>Replace the modem.</p> <p>If the problem persists, call for service.</p>
			No dialtone detected	<ol style="list-style-type: none"> 1. Make sure that the phone line attached to the modem has a dial tone. (Connect a phone to the line and listen, if necessary.) If there is no tone, have the phone line serviced. 2. If the problem remains, replace the modem. <p>If the problem persists, call for service.</p>

Table 13. Diagnostic error messages.

Recovering BIOS

If the BIOS becomes corrupted, such as from a power failure during a flash update, you can recover the BIOS using the BIOS code page jumper and a BIOS flash diskette.

Note: You can obtain a BIOS flash diskette from one of the following sources:

- Download a BIOS flash diskette from the World Wide Web. Go to <http://www.pc.ibm.com/support/>, select IBM Server Support, and make the selections for your computer.
- Contact your IBM service representative.

To recover the BIOS:

1. Review the “Safety information” on page 31.
2. Turn off the computer and peripheral devices and disconnect all external cables and power cords; then, remove the cover.
3. Locate the BIOS code page jumper (**J19**) on the system board.

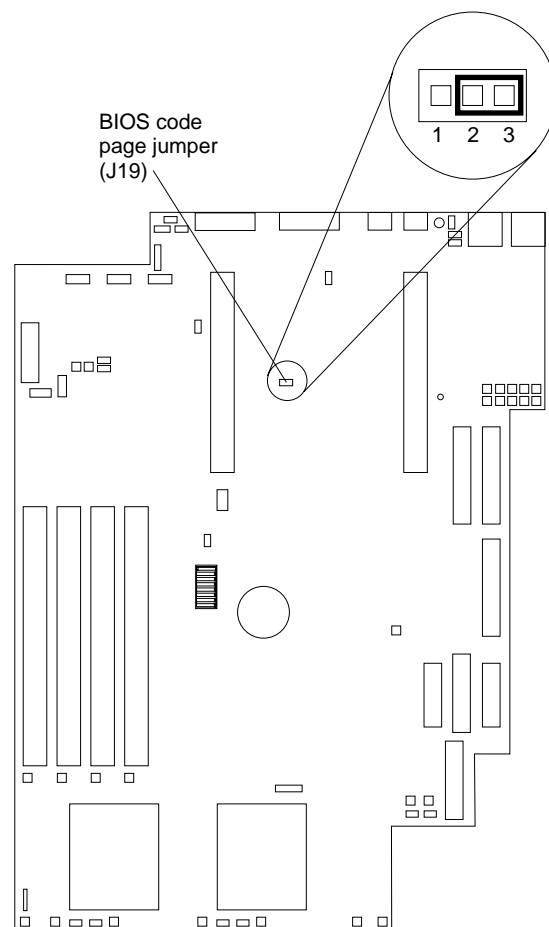

4. Place a jumper on pins 1 and 2 to enable BIOS back page.

Note: Before continuing, refer to “Working inside a computer with the power on” on page 29.

5. Reconnect all external cables and power cords and turn on the peripheral devices.
6. Insert the BIOS Flash Diskette in the diskette drive.

7. Restart the computer. The system begins the power-on self-test (POST) and BIOS flash.
8. Select **1 - Update POST/BIOS** from the menu that contains various flash (update) options.
9. When prompted as to whether you want to save the current code to a diskette, select **N**.
10. When prompted to choose a language, select a language (from 0 to 7) and press **Enter** to accept your choice.
11. Do not reboot your system at this time.
12. Remove the BIOS Flash Diskette from the diskette drive.
13. Turn the computer off.
14. Move the jumper on **J19** to pins 2 and 3 to return to normal startup mode.
15. Restart the computer. The system should start up normally.
16. Replace the cover.

Identifying problems using status LEDs

If the System Error light in the operator information panel on the front of the computer is on, one or more LEDs inside the computer may be on. Use the Light Path Diagnostics panel to identify the type of error that occurred.

For LED locations see “System board LEDs” on page 28.

Light Path Diagnostics

You can use the Light Path Diagnostics in your computer to quickly identify the type of system error that occurred. The Light Path Diagnostics panel is located on the system board, just behind PCI adapter slot 1. When you press on the Light Path Diagnostics button, the LED on the top-right corner of the panel illuminates. This shows that the diagnostic circuitry is working correctly.

Your computer is designed so that any illuminated LEDs re-illuminate without AC power after you remove the cover. This feature helps you isolate the problem if an error causes the computer to shut down. See “Light Path Diagnostics table” on page 97.

Important: You have up to 12 hours to use the Light Path Diagnostic LED’s after AC power has been removed from the computer. After 12 hours, you must power the computer up again to be able to use the Light Path Diagnostic LED’s to help locate system errors.

To view the LEDs on the system board:

1. Review the “Safety information” on page 31.
2. Turn off the computer and peripheral devices.
3. Remove all external cables from the computer; then, remove the computer from the rack and remove the cover. For more information see “Removing the cover” on page 38 for instructions.
4. Press and hold the Light Path Diagnostics (blue) button on the diagnostics panel. The LEDs will illuminate while the switch is pressed.

Note: You can illuminate the LEDs for a maximum of two minutes. After that time, the circuit that powers the LEDs is exhausted.
5. Replace the cover on the computer; then, reinstall the computer in the rack and connect all external cables. For more information see “Installing the cover” on page 53 for instructions.

Light Path Diagnostics panel

The following illustration shows the LEDs on the diagnostics panel on the system board. See “Light Path Diagnostics table” on page 97 for information on identifying problems using these LEDs.

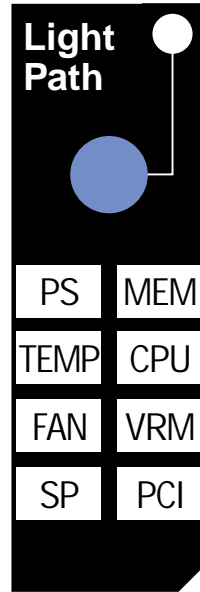

Light Path Diagnostics table

The System Error LED on the operator information panel is lit when certain system errors occur. If the System Error LED on your computer is lit, use the following table to help determine the cause of the error and the action you should take.

Lit LED on diagnostics panel	Cause	Action
None	An error has occurred and can not be isolated, or the Advanced System Management Processor has failed.	An error has occurred that is not represented by a Light Path Diagnostics LED. Check the system error log for more information about the error.
PS	Power supply has failed.	Have the system serviced.
TEMP	The system temperature has exceeded a threshold level.	<ol style="list-style-type: none"> 1. Check to see if a fan has failed. If it has, replace the fan. 2. Make sure the room temperature is not too hot. (See "IntelliStation R Pro features and specifications" on page 2.) <p>If the problem persists, have the system serviced.</p>
FAN	A fan has failed or is operating too slowly. Note: A failing fan can also cause the TEMP LED to be on.	Check the LEDs on the fans and replace the indicated fan.
SP	The service processor has failed.	<p>Remove AC power from the computer and then restart the computer.</p> <p>If the problem persists have the system serviced.</p>
MEM	A memory error occurred.	<ol style="list-style-type: none"> 1. Check the DIMM failure LEDs on the system board. 2. Replace the DIMM indicated by the lit DIMM failure LED.
CPU	One of the microprocessors has failed.	<ol style="list-style-type: none"> 1. Check the microprocessor failure LEDs on the system board. 2. If a microprocessor failure LED is on, make sure the microprocessor is installed correctly (see "Installing the microprocessor" on page 49). 3. If the problem persists, replace the microprocessor. <p>If the problem persists, have the system serviced.</p>
VRM	One of the VRMs on the system board has failed.	<p>Remove AC power from the computer and then restart the computer.</p> <p>If the problem persists have the system serviced.</p>

Table 14. Light Path Diagnostics.

Lit LED on diagnostics panel	Cause	Action
PCI	An error occurred on a PCI bus. The system board caused the error.	<ol style="list-style-type: none"> 1. Check the error log for additional information. 2. If you cannot isolate the failing adapter from the information in the error log, try to determine the failing adapter by removing one adapter at a time from PCI bus B (PCI slots 1 and 2) and restarting the computer after each adapter is removed. <p>If the problem persists, have the system serviced.</p>

Table 14. Light Path Diagnostics.

Troubleshooting charts

You can use the troubleshooting charts in this section to find solutions to problems that have definite symptoms.

Attention: If diagnostic error messages appear that are not listed in the following tables, make sure that your computer has the latest levels of BIOS and diagnostics microcode installed.

See “Starting the diagnostic programs” on page 84 to test the computer. If you have run the diagnostic test programs or if running the tests does not reveal the problem, call for service.

Look for the symptom in the left column of the chart. Instructions and probable solutions to the problem are in the right column. If you have just added new software or a new option and your computer is not working, do the following before using the troubleshooting charts:

- Remove the software or device that you just added.
- Run the diagnostic tests to determine if your computer is running correctly.
- Reinstall the new software or new device.

Device	Suggested action
CD-ROM drive	Verify that:
CD-ROM drive is not recognized.	<ol style="list-style-type: none"> 1. The primary IDE channel is enabled in the Configuration/Setup Utility program. 2. All cables and jumpers are installed correctly. 3. The correct device driver is installed for the CD-ROM drive.
Diskette drive	If there is a diskette in the drive, verify that:
Diskette drive in-use light stays on, or the system bypasses the diskette drive.	<ol style="list-style-type: none"> 1. The diskette drive is enabled in the Configuration/Setup Utility program. 2. The diskette is good and not damaged. (Try another diskette if you have one.) 3. The diskette contains the necessary files to start the computer. 4. Your software program is OK. <p>If the diskette drive in-use light stays on, or the system continues to bypass the diskette drive, call for service.</p>
Expansion enclosure problems	Verify that:
The SCSI expansion enclosure used to work, but does not work now.	<ol style="list-style-type: none"> 1. The cables for all external SCSI options are connected correctly. 2. The last option in each SCSI chain, or the end of the SCSI cable, is terminated correctly. 3. Any external SCSI option is turned on. You must turn on an external SCSI option before turning on the computer. <p>For more information, see your SCSI and expansion enclosure documentation.</p>
General problems	Call for service.
Problems such as broken cover locks or indicator lights not working.	

Table 15. Troubleshooting charts.

Device	Suggested action
Intermittent problems	Verify that:
A problem occurs only occasionally and is difficult to detect.	<ol style="list-style-type: none"> 1. All cables and cords are connected securely to the rear of the computer and attached options. 2. When the computer is turned on, air is flowing from the rear of the computer at the fan grill. If there is no air flow, the fan is not working. This causes the computer to overheat and shut down. 3. Ensure that the SCSI bus and devices are configured correctly and that the last external device in each SCSI chain is terminated correctly. <p>If the items above are correct, call for service.</p>
Keyboard, mouse, or pointing-device problems.	<ol style="list-style-type: none"> 1. Make sure that the computer and the monitor are turned on. 2. Try using another keyboard.
All or some keys on the keyboard do not work.	If the items above are correct, call for service.
The mouse or pointing device does not work.	<ol style="list-style-type: none"> 1. Verify that the mouse or pointing-device cable is securely connected and the device drivers are installed correctly. 2. Try using another mouse or pointing device. <p>If the problem remains, call for service.</p>
Memory problems	Verify that:
The amount of memory displayed is less than the amount of memory installed.	<ol style="list-style-type: none"> 1. The memory modules are seated properly. 2. You have installed the correct type of memory. 3. If you changed the memory, you updated the memory configuration with the Configuration/Setup Utility program. 4. All banks of memory on the DIMMs are enabled. The computer might have automatically disabled a DIMM bank when it detected a problem or a DIMM bank could have been manually disabled. <p>Look in the POST error log for error message 289:</p> <ul style="list-style-type: none"> • If the DIMM was disabled by a system-management interrupt (SMI), replace the DIMM. • If the DIMM was disabled by the user or by POST: <ol style="list-style-type: none"> 1. Start the Configuration/Setup Utility program. 2. Enable the DIMM. 3. Save the configuration and restart the computer. • If you continue to get this error, replace the DIMM. <p>If the problem persists, call for service.</p>
Microprocessor problems	The startup (boot) microprocessor is not working properly.
The computer emits a continuous tone during POST.	Verify that the startup microprocessor is seated properly. If it is, replace the startup microprocessor. If the problem remains, call for service.
Monitor problems	Some IBM monitors have their own self-tests. If you suspect a problem with your monitor, refer to the information that comes with the monitor for adjusting and testing instructions.
Testing the monitor.	If you still cannot find the problem, call for service.

Table 15. Troubleshooting charts.

Device	Suggested action
The screen is blank.	Verify that: <ol style="list-style-type: none"> 1. The computer power cord is plugged into the computer and a working electrical outlet. 2. The monitor cables are connected properly. 3. The monitor is turned on and the Brightness and Contrast controls are adjusted correctly. <p>Attention: In some memory configurations, the 3-3-3 beep code might sound during POST followed by a blank display screen. If this occurs and the Boot Fail Count feature in the Start Options of the Configuration/Setup Utility is set to Enabled (its default setting), you must restart the computer three times to force the system BIOS to reset the memory connector or bank of connectors from Disabled to Enabled.</p> <p>If the items above are correct and the screen remains blank, call for service.</p>
Only the cursor appears.	Call for service.
The monitor works when you turn on the computer, but goes blank when you start some application programs.	Verify that: <ol style="list-style-type: none"> 1. The primary monitor cable is connected to the C2T device breakout cable. 2. You installed the necessary device drivers for the applications. <p>If the items above are correct and the screen remains blank, call for service.</p>
Wavy, unreadable, rolling, distorted screen, or screen jitter.	<p>If the monitor self-tests show the monitor is OK, consider the location of the monitor. Magnetic fields around other devices (such as transformers, appliances, fluorescent lights, and other monitors) can cause screen jitter or wavy, unreadable, rolling, or distorted screen images. If this happens, turn off the monitor. (Moving a color monitor while it is turned on might cause screen discoloration.) Then move the device and the monitor at least 305 mm (12 in.) apart. Turn on the monitor.</p> <p>Notes:</p> <ol style="list-style-type: none"> 1. To prevent diskette drive read/write errors, be sure the distance between monitors and diskette drives is at least 76 mm (3 in.). 2. Non-IBM monitor cables might cause unpredictable problems. 3. An enhanced monitor cable with additional shielding is available for the 9521 and 9527 monitors. For information about the enhanced monitor cable, see your IBM reseller or IBM marketing representative. <p>If the problem remains, call for service.</p>
Wrong characters appear on the screen.	<p>If the wrong language is displayed, update the BIOS with the correct language.</p> <p>If the problem remains, call for service.</p>
Option problems	Verify that:
An IBM option that was just installed does not work.	<ol style="list-style-type: none"> 1. The option is designed for the computer. Refer to the "Computer Support" flowchart for information about obtaining ServerProven™ compatibility information from the World Wide Web. 2. You followed the installation instructions that came with the option. 3. The option is installed correctly. 4. You have not loosened any other installed options or cables. 5. You updated the configuration information in the Configuration/Setup Utility program. Whenever memory or an option is changed, you must update the configuration. <p>If the problem remains, call for service.</p>

Table 15. Troubleshooting charts.

Device	Suggested action
An IBM option that used to work does not work now.	<p>Verify that all of the option hardware and cable connections are secure.</p> <p>If the option comes with its own test instructions, use those instructions to test the option.</p> <p>If the failing option is a SCSI option, verify that:</p> <ol style="list-style-type: none"> 1. The cables for all external SCSI options are connected correctly. 2. The last option in each SCSI chain, or the end of the SCSI cable, is terminated correctly. 3. Any external SCSI option is turned on. You must turn on an external SCSI option before turning on the computer. <p>If the problem remains, call for service.</p>
Power problems	<p>Verify that:</p> <ol style="list-style-type: none"> 1. The power cables are properly connected to the computer. 2. The electrical outlet functions properly. 3. The type of memory installed is correct. 4. If you just installed an option, remove it, and restart the computer. If the computer now powers on, you might have installed more options than the power supply supports. <p>If the problem remains, call for service.</p>
Serial port problems	<p>Verify that:</p> <ol style="list-style-type: none"> 1. Each port is assigned a unique address by the Configuration/Setup Utility program and none of the serial ports are disabled. <ul style="list-style-type: none"> Note: The Management connector is the same as a serial port connector, but it is used only by the integrated Advanced System Management Processor, and is not available for use by the operating system. This port does not appear in the Configuration/Setup Utility program menus; it can be configured using the systems-management software. 2. The serial-port adapter, if you installed one, is seated properly. <p>If the problem still exists, call for service.</p>
A serial device does not work. For more information about the serial port see "Serial port" on page 57.	<p>Verify that:</p> <ol style="list-style-type: none"> 1. The device is compatible with the computer. 2. The serial port is enabled and is assigned a unique address. 3. Make sure that the device is not connected to the management port C. <ul style="list-style-type: none"> Note: The management C connector is the same as a serial port connector, but it is used only by the integrated Advanced System Management Processor and is not available for use by the operating system. This port does not appear in the Configuration/Setup Utility program menus; it can be configured using the systems-management software. <p>If the problem still exists, call for service.</p>

Table 15. Troubleshooting charts.

Device	Suggested action
Software problem	To determine if problems are caused by the software, verify that:
Suspected software problem.	<ol style="list-style-type: none"> 1. Your computer has the minimum memory requirements needed to use the software. For memory requirements, refer to the information that comes with the software. Note: If you have just installed an adapter or memory, you might have a memory address conflict. 2. The software is designed to operate on your computer. 3. Other software works on your computer. 4. The software that you are using works on another system. <p>If you received any error messages when using the software program, refer to the information that comes with the software for a description of the messages and solutions to the problem.</p> <p>If the items above are correct and the problem remains, contact your place of purchase.</p>
Universal Serial Bus (USB) port problems	Verify that:
A USB device does not work.	<ol style="list-style-type: none"> 1. You are not trying to use a USB device during POST if you have a standard (non-USB) keyboard attached to the keyboard port. Note: If a standard (non-USB) keyboard is attached to the keyboard port, then the USB is disabled and no USB device will work during POST. 2. The correct USB device driver is installed. 3. Your operating system supports USB devices. <p>If the problem still exists, call for service.</p>

Table 15. Troubleshooting charts.

Troubleshooting the audio adapter

This section provides troubleshooting information for problems that might occur with your computer audio adapter. If your audio adapter does not function properly after the software installation, check the following:

- Ensure that the internal audio cable is securely connected from the Audio Out connector on the video adapter to the CD-Audio In connector on the audio adapter.
- Ensure that the speaker cables are connected properly to either the Line Out or Speaker Out connector on the audio adapter.
- Ensure that the powered speakers are on. Powered speakers are required.
- Check the Windows volume control setting.
- Verify that an audio signal is being supplied to the audio adapter.
- Verify that the audio driver installation was completed properly.
- If the problem persists, call for service.

Troubleshooting the video adapter

For troubleshooting information on the video adapter, refer to the video documentation that shipped with your computer.

Troubleshooting an Ethernet controller

This section provides troubleshooting information for problems that might occur with an 10/100 Mbps Ethernet controller.

Network connection problems

If an Ethernet controller cannot connect to the network, check the following:

- Make sure that the cable is installed correctly.

The network cable must be securely attached at all connections. If the cable is attached but the problem persists, try a different cable.

If you set the Ethernet controller to operate at 100 Mbps, you must use Category 5 cabling.

If you directly connect two workstations (without a hub), or if you are not using a hub with X ports, use a crossover cable.

Note: To determine whether a hub has an X port, check the port label. If the label contains an X, the hub has an X port.

- Determine if the hub supports auto-negotiation. If not, try configuring the integrated Ethernet controller manually to match the speed and duplex mode of the hub.
- Make sure that you are using the correct device drivers, supplied with your computer.
- Check for operating system-specific causes for the problem.
- Make sure that the device drivers on the client and computer are using the same protocol.
- Test the Ethernet controller.

How you test the Ethernet controller depends on which operating system you are using (see the Ethernet controller device driver README file).

Ethernet controller troubleshooting chart

You can use the following troubleshooting chart to find solutions to 10/100 Mbps Ethernet controller problems that have definite symptoms.

Ethernet controller problem	Suggested Action
The computer stops running when loading device drivers.	<p>The PCI BIOS interrupt settings are incorrect.</p> <p>Check the following:</p> <ul style="list-style-type: none"> • Determine if the interrupt (IRQ) setting assigned to the Ethernet controller is also assigned to another device in the Configuration/Setup Utility program. <p>Although interrupt sharing is allowed for PCI devices, some devices do not function well when they share an interrupt with a dissimilar PCI device. Try changing the IRQ assigned to the Ethernet controller or the other device.</p> <ul style="list-style-type: none"> • Make sure that you are using the most recent device driver available from the World Wide Web. • Run the network diagnostic program. <p>If the problem remains, call for service.</p>
Data is incorrect or sporadic.	<p>Check the following:</p> <ul style="list-style-type: none"> • Make sure that you are using Category 5 cabling when operating the computer at 100 Mbps. • Make sure that the cables do not run close to noise-inducing sources like fluorescent lights.
The Ethernet controller stopped working when another adapter was added to the computer.	<p>Check the following:</p> <ul style="list-style-type: none"> • Make sure that the cable is connected to the Ethernet controller. • Make sure that your PCI system BIOS is current. • Reseat the adapter. • Determine if the interrupt (IRQ) setting assigned to the Ethernet adapter is also assigned to another device in the Configuration/Setup Utility program. <p>Although interrupt sharing is allowed for PCI devices, some devices do not function well when they share an interrupt with a dissimilar PCI device. Try changing the IRQ assigned to the Ethernet adapter or the other device.</p> <p>If the problem remains, call for service.</p>
The Ethernet controller stopped working without apparent cause.	<p>Check the following:</p> <ul style="list-style-type: none"> • Run diagnostics for the Ethernet controller. • Try a different connector on the hub. • Reinstall the device drivers. Refer to your operating-system documentation. <p>If the problem remains, call for service.</p>

Table 16. Ethernet troubleshooting chart.

Ethernet controller messages

The integrated Ethernet controllers might display messages from the following device drivers:

- NDIS Adapter for level 4.0 (Windows NT)

NDIS 4.0 (Windows NT) driver messages

This section contains the error messages for the NDIS 4.0 drivers. The explanation and recommended action are included with each message.

Error code (hex)	Description
0x00	Explanation: The driver could not register the specified interrupt. Action: Using the Configuration/Setup utility, make sure that a PCI interrupt is assigned to your Ethernet card, and that Ethernet is enabled.
0x01	Explanation: One of the PCI cards did not get the required resources. Action: Using the Configuration/Setup utility, make sure that a PCI interrupt is assigned to your Ethernet card, and that Ethernet is enabled.
0x02	Explanation: Bad node address (multicast address). Action: Make sure the locally administered address is valid, if one is specified. The address can not be a multicast address.
0x03	Explanation: Failed self-test. Action: Make sure a cable is attached to the Ethernet connector. If the problem persists, call for service.
0x0D	Explanation: Could not allocate enough memory for transmit queues. Action: <ol style="list-style-type: none"> 1. From the Windows NT desktop, select Start -> Control Panel -> Networks -> Adapters. 2. Select your IBM Ethernet adapter from the list. 3. Select Properties -> Advanced. 4. Lower the resource values that apply to the transmit queue.
0x0E	Explanation: Could not allocate enough memory for receive queue. Action: <ol style="list-style-type: none"> 1. From the Windows NT desktop, select Start -> Control Panel -> Networks -> Adapters. 2. Select your IBM Ethernet adapter from the list. 3. Select Properties -> Advanced. 4. Lower the resource values that apply to the receive queue.
0x0F	Explanation: Could not allocate enough memory for other structures. Action: <ol style="list-style-type: none"> 1. From the Windows NT desktop, select Start -> Control Panel -> Networks -> Adapters. 2. Select your IBM Ethernet adapter from the list. 3. Select Properties -> Advanced. 4. Lower the value for the resource named in the message.
0x10	Explanation: Did not find any Ethernet controllers. Action: Using the Configuration/Setup utility, make sure that Ethernet is enabled.
0x11	Explanation: Multiple Ethernet controllers found, but none matched the required ID. Action: Using the Configuration/Setup utility, make sure that Ethernet is enabled.
0x13	Explanation: Did not find any Ethernet controllers that matched the required subven/subdev. Action: Using the Configuration/Setup utility, make sure that Ethernet is enabled.
0x16	Explanation: Single adapter found but multiple instances tried to load. Action: Using the Configuration/Setup utility, make sure that Ethernet is enabled, and that the slot containing the IBM Netfinity 10/100 Ethernet Adapter or the IBM 10/100 Etherjet PCI adapter is enabled.
0x17	Explanation: Slot parameter not specified in the registry. Action: Remove the adapter driver and reinstall it. If the problem persists, call for service.

Table 17. NDIS (Windows NT or Windows 2000) driver messages for the Ethernet controller.

Error code (hex)	Description
All other 4-character hexadecimal codes	Action: Call for service.

Table 17. NDIS (Windows NT or Windows 2000) driver messages for the Ethernet controller.

Ethernet teaming messages:

Event ID	Type	Description
01	Error	Explanation: Team Name and physical adapter name are the same. This is an invalid configuration. Action: Reconfigure the adapter team by double-clicking the PROSet icon in the control panel.
02	Error	Explanation: Unable to allocate required resources. Action: Free some memory resources and restart.
03	Error	Explanation: Unable to read required registry parameters. Action: Reconfigure the adapter team by double-clicking the PROSet icon in the control panel.
04	Error	Explanation: Unable to bind to physical adapter. Action: Reconfigure the adapter team by double-clicking the PROSet icon in the control panel.
05	Error	Explanation: Unable to initialize an adapter team. Action: Reconfigure the adapter team by double-clicking the PROSet icon in the control panel.
06	Informational	Explanation: Team <i>nn</i> . Primary adapter is initialized. Action: None.
07	Informational	Explanation: Team <i>nn</i> . Secondary adapter is initialized. Action: None.
08	Informational	Explanation: Team <i>nn</i> . Virtual adapter or Team is initialized. Action: None.
09	Informational	Explanation: Team <i>nn</i> . Primary adapter is switching over. Action: None.
10	Warning	Explanation: Team <i>nn</i> . Adapter link down. Action: Make sure the adapter is functioning properly.
11	Informational	Explanation: Team <i>nn</i> . Secondary adapter took over. Action: None.
12	Warning	Explanation: Team <i>nn</i> . Secondary adapter is deactivated from the Team. Action: Make sure the secondary adapter is functioning properly and that the adapter cable is securely connected to the LAN.
13	Informational	Explanation: Team <i>nn</i> . Secondary adapter has rejoined the Team. Action: None.
14	Informational	Explanation: Team <i>nn</i> . Secondary adapter link is up. Action: None.
15	Error	Explanation: Team <i>nn</i> . The last adapter has lost its link. Network connection has been lost. Action: Shut down the computer and replace the adapters; then, restart the computer to reestablish the connection.
16	Informational	Explanation: Team <i>nn</i> . An adapter has re-established the link. Network connection has been restored. Action: None.
17	Informational	Explanation: Team <i>nn</i> . Preferred primary adapter has been detected. Action: None.
18	Informational	Explanation: Team <i>nn</i> . Preferred secondary adapter has been detected. Action: None.
19	Informational	Explanation: Team <i>nn</i> . Preferred primary adapter took over. Action: None.
20	Informational	Explanation: Team <i>nn</i> . Preferred secondary adapter took over. Action: None.
21	Warning	Explanation: Team <i>nn</i> . Primary adapter does not sense any Probes. Possible reason: partitioned Team. Action: Make sure the cables of the adapter team are connected to the same LAN segment. Reconfigure the team if necessary.

Table 18. NDIS (Windows NT or Windows 2000) driver teaming messages for the Ethernet controller.

Replacing the battery

When replacing the battery you must replace it with a lithium battery of the same type, from the same manufacturer. To avoid possible danger read and follow the safety statement below.

To order replacement batteries, call 1-800-772-2227 within the United States, and 1-800-465-7999 or 1-800-465-6666 within Canada. Outside the U.S. and Canada, call your IBM reseller or IBM marketing representative.

Note: After you replace the battery, you must reconfigure your computer and reset the system date and time.

Statement 2

CAUTION:



When replacing the lithium battery, use only IBM Part Number 33F8354 or an equivalent type battery recommended by the manufacturer. If your system has a module containing a lithium battery, replace it only with the same module type made by the same manufacturer. The battery contains lithium and can explode if not properly used, handled, or disposed of.

Do not:

- **Throw or immerse into water.**
- **Heat to more than 100 C (212 F)**
- **Repair or disassemble**

Dispose of the battery as required by local ordinances or regulations.

Complete the following steps to replace the battery:

1. Read "Safety information" on page 31, and follow any special handling and installation instructions supplied with the replacement battery.
2. Turn off the computer and peripheral devices and disconnect all external cables and power cords; then, remove the computer cover.
3. Remove the battery:
 - a. Use one finger to lift the battery clip over the battery.
 - b. Use one finger to slightly slide the battery out from its socket. The spring mechanism will push the battery out toward you as you slide it from the socket.
 - c. Use your thumb and index finger to pull the battery from under the battery clip.

- d. Ensure that the battery clip is touching the base of the battery socket by pressing gently on the clip.

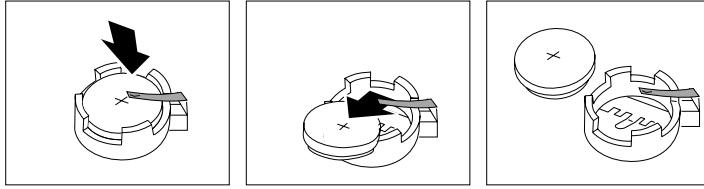

4. Insert the new battery:
 - a. Tilt the battery so that you can insert it into the socket, under the battery clip.
 - b. As you slide it under the battery clip, press the battery down into the socket.

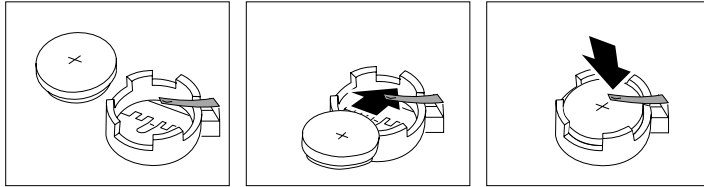

5. Reinstall the computer cover and connect the cables.
6. Turn on the computer.
7. Start the Configuration/Setup Utility program and set configuration parameters.
 - Set the system date and time.
 - Set the power-on password.
 - Reconfigure your computer.

Getting information, help, and service

If you need help, service, technical assistance, or just want more information about IBM products, you will find a wide variety of sources available from IBM to assist you.

This section contains information about where to go for additional information about IBM and IBM products, what to do if you experience a problem with your computer, and whom to call for service should it be necessary.

Getting information

Information about your IBM computer and preinstalled software, if any, is available in the documentation that comes with your computer. In addition, information about IBM products is available on the World Wide Web and through the IBM Automated Fax System.

Using the World Wide Web

On the World Wide Web, the IBM Web site has up-to-date information about IBM Personal Computer products and support. The address for the IBM Personal Computing home page is <http://www.ibm.com/pc>

You can find support information for your IBM products, including supported options, at <http://www.ibm.com/pc/support>

If you select Profile from the support page, you can create a customized support page that is specific to your hardware, complete with Frequently Asked Questions, Parts

Information, Technical Hints and Tips, and Downloadable Files. In addition, you can choose to receive e-mail notifications whenever new information becomes available about your registered products.

You also can order publications through the IBM Publications Ordering System at <http://www.elink.ibm.com/public/applications/publications/cgibin/pbi.cgi>

Getting information by fax

If you have a touch-tone telephone and access to a fax machine, in the U.S. and Canada you can receive by fax marketing and technical information on many topics, including hardware, operating systems, and local area networks (LANs).

You can call the IBM Automated Fax System 24 hours a day, 7 days a week. Follow the recorded instructions, and the requested information will be sent to your fax machine. In the U.S. and Canada, to access the IBM Automated Fax System, call 1-800-426-3395.

Getting help and service

If you have a problem with your computer, you will find a wide variety of sources available to help you.

Using the documentation and diagnostic programs

Many computer problems can be solved without outside assistance. If you experience a problem with your computer, the first place to start is the troubleshooting information of your computer documentation. If you suspect a software problem, see the documentation, including README files and online help, that comes with the operating system or application program.

Most IBM computers come with a set of diagnostic programs that you can use to help you identify hardware problems. See the troubleshooting information of your computer documentation for instructions on using the diagnostic programs.

The troubleshooting information or the diagnostic programs might tell you that you need additional or updated device drivers or other software. IBM maintains pages on the World Wide Web where you can get the latest technical information and download device drivers and updates. To access these pages, go to <http://www.ibm.com/pc/support> and follow the instructions.

Calling for service

If you have tried to correct the problem yourself and still need help, during the warranty period, you can get help and information by telephone through the IBM PC Help-Center. The following services are available during the warranty period:

- Problem determination - Trained personnel are available to assist you with determining if you have a hardware problem and deciding what action is necessary to fix the problem.
- IBM hardware repair - If the problem is determined to be caused by IBM hardware under warranty, trained service personnel are available to provide the applicable level of service.
- Engineering change management - Occasionally, there might be changes that are required after a product has been sold. IBM or your reseller, if authorized by IBM, will make selected Engineering Changes (ECs) available that apply to your hardware.

The following items are not covered:

- Replacement or use of non-IBM parts or nonwarranted IBM parts

Note: All warranted parts contain a 7-character identification in the format IBM FRU XXXXXXX.

- Identification of software problem sources
- Configuration of BIOS as part of an installation or upgrade
- Changes, modifications, or upgrades to device drivers
- Installation and maintenance of network operating systems (NOS)
- Installation and maintenance of application programs

Refer to your IBM hardware warranty for a full explanation of IBM warranty terms. Be sure to retain your proof of purchase to obtain warranty service.

In the U.S. and Canada, these services are available 24 hours a day, 7 days a week. In the U.K., these services are available Monday through Friday, from 9:00 a.m. to 6:00 p.m.

Note: Response time will vary depending on the number and complexity of incoming calls.

If possible, be at your computer when you call. Please have the following information ready:

- Machine Type and Model
- Serial numbers of your IBM hardware products
- Description of the problem
- Exact wording of any error messages
- Hardware and software configuration information

Phone numbers are subject to change without notice. For the most up-to-date phone numbers, go to <http://www.ibm.com/pc/support> and click **HelpCenter phone list**.

Country		Telephone number
Austria	Österreich	01-24 692 5901
Belgium - Dutch	Belgie	02-210 9820
Belgium - French	Belgique	02-210 9800
Canada	Toronto only	416-383-3344
Canada	Canada - all other	1-800-565-3344
Denmark	Danmark	35 25 02 91
Finland	Suomi	09-22 931 840
France	France	01 69 32 40 40
Germany	Deutschland	069-6654 9040
Ireland	Ireland	01-815 9200
Italy	Italia	02-4827 5040
Luxembourg	Luxembourg	298-977 5063
Netherlands	Nederland	020-504 0501
Norway	Norge	23 05 32 40
Portugal	Portugal	21-791 51 47
Spain	España	91-662 49 16
Sweden	Sverige	08-751 52 27
Switzerland	Schweiz/Suisse/Svizzera	0848-80-52-52
United Kingdom	United Kingdom	01475-555 055
U.S.A. and Puerto Rico	U.S.A. and Puerto Rico	1-800-772-2227

In all other countries, contact your IBM reseller or IBM marketing representative.

Other services

IBM Update Connector is a remote communication tool that you can use with some IBM computers to communicate with the HelpCenter. Update Connector enables you to receive and download updates for some of the software that might come with your computer.

With some computer models, you can register for International Warranty Service. If you travel with your computer or need to move it to another country, you might be able to receive an International Warranty Service Certificate that is honored virtually worldwide, wherever IBM or IBM resellers sell and service IBM products.

For more information or to register for International Warranty Service:

- In the U.S. or Canada, call 1-800-497-7426.
- In Europe, call 44-1475-893638 (Greenock, U.K.).
- In Australia and New Zealand, call 61-2-9354-4171.
- In all other countries, contact your IBM reseller or IBM marketing representative.

IBM Integrated Technology Services offers a broad range of information technology support, implementation, and management services. For more information about

these services, refer to the Integrated Technology Services Web site at <http://www.ibm.com/services/its>

For technical assistance with the installation of, or questions related to, Service Packs for your Microsoft Windows product, refer to the Microsoft Product Support Services Web site at <http://support.microsoft.com/directory/>, or you can contact the IBM Help-Center. Some fees might apply.

Purchasing additional services

During and after the warranty period, you can purchase additional services, such as support for IBM and non-IBM hardware, operating systems, and application programs; network setup and configuration; upgraded or extended hardware repair services; and custom installations. Service availability and service name might vary by country.

For more information about these services, see the online information.

Appendix A. Computer records

This appendix contains a form for recording information about your computer, which can be helpful if you ever need to have your computer serviced.

Serial numbers and keys

Record and retain the following information.

Product Name	IntelliStation R Pro
Model/Type (M/T)	
Serial Number (S/N)	
Key manufacturer address, phone number and key code number	

The model and type (M/T) numbers and the serial number (S/N) are located on labels on the top of the machine behind the bezel on the right.

Appendix B. Warranties and notices

This chapter contains warranty and emission notices. It also contains trademarks and general-information notices.

Warranty Information

Warranty Period

Machine - IBM IntelliStation R Pro Types 8654-55X, 8654-56X, 8654-57X, and 8654-58X

Warranty Period* - Three Years

** Contact your place of purchase for warranty service information. Some IBM Machines are eligible for On-site warranty service depending on the country where service is performed.*

IBM Statement of Limited Warranty

Z125-4753-06 8/2000

Part 1 - General Terms

This Statement of Limited Warranty includes Part 1 - General Terms and Part 2 - Country-unique Terms. The terms of Part 2 replace or modify those of Part 1. The warranties provided by IBM in this Statement of Limited Warranty apply only to Machines you purchase for your use, and not for resale, from IBM or your reseller. The term "Machine" means an IBM machine, its features, conversions, upgrades, elements, or accessories, or any combination of them. The term "Machine" does not include any software programs, whether pre-loaded with the Machine, installed subsequently or otherwise. Unless IBM specifies otherwise, the following warranties apply only in the country where you acquire the Machine. Nothing in this Statement of Limited Warranty affects any statutory rights of consumers that cannot be waived or limited by contract. If you have any questions, contact IBM or your reseller.

The IBM Warranty for Machines

IBM warrants that each Machine 1) is free from defects in materials and workmanship and 2) conforms to IBM's Official Published Specifications ("Specifications"). The warranty period for a Machine is a specified, fixed period commencing on its Date of Installation. The date on your sales receipt is the Date of Installation unless IBM or your reseller informs you otherwise.

If a Machine does not function as warranted during the warranty period, and IBM or your reseller are unable to either 1) make it do so or 2) replace it with one that is at least functionally equivalent, you may return it to your place of purchase and your money will be refunded.

Extent of Warranty

The warranty does not cover the repair or exchange of a Machine resulting from misuse, accident, modification, unsuitable physical or operating environment, improper maintenance by you, or failure caused by a product for which IBM is not responsible. The warranty is voided by removal or alteration of Machine or parts identification labels.

THESE WARRANTIES ARE YOUR EXCLUSIVE WARRANTIES AND REPLACE ALL OTHER WARRANTIES OR CONDITIONS, EXPRESS OR IMPLIED, INCLUDING, BUT NOT LIMITED TO, THE IMPLIED WARRANTIES OR CONDITIONS OF MERCHANTABILITY AND FITNESS FOR A PARTICULAR PURPOSE. THESE WARRANTIES GIVE YOU SPECIFIC LEGAL RIGHTS AND YOU MAY ALSO HAVE OTHER RIGHTS WHICH VARY FROM JURISDICTION TO JURISDICTION. SOME JURISDICTIONS DO NOT ALLOW THE EXCLUSION OR LIMITATION OF EXPRESS OR IMPLIED WARRANTIES, SO THE ABOVE EXCLUSION OR LIMITATION MAY NOT APPLY TO YOU. IN THAT EVENT, SUCH WARRANTIES ARE LIMITED IN DURATION TO THE WARRANTY PERIOD. NO WARRANTIES APPLY AFTER THAT PERIOD.

Items Not Covered by Warranty

IBM does not warrant uninterrupted or error-free operation of a Machine.

Any technical or other support provided for a Machine under warranty, such as assistance via telephone with "how-to" questions and those regarding Machine set-up and installation, will be provided **WITHOUT WARRANTIES OF ANY KIND**.

Warranty Service

To obtain warranty service for a Machine, contact IBM or your reseller. If you do not register your Machine with IBM, you may be required to present proof of purchase.

During the warranty period, IBM or your reseller, if approved by IBM to provide warranty service, provides without charge certain types of repair and exchange service to keep Machines in, or restore them to, conformance with their Specifications. IBM or your reseller will inform you of the available types of service for a Machine based on its country of installation. At its discretion, IBM or your reseller will 1) either repair or exchange the failing Machine and 2) provide the service either at your location or a service center. IBM or your reseller will also manage and install selected engineering changes that apply to the Machine.

Some parts of IBM Machines are designated as Customer Replaceable Units (called "CRUs"), e.g., keyboards, memory, or hard disk drives. IBM ships CRUs to you for replacement by you. You must return all defective CRUs to IBM within 30 days of your receipt of the replacement CRU. You are responsible for downloading designated Machine Code and Licensed Internal Code updates from an IBM Internet Web site or from other electronic media, and following the instructions that IBM provides.

When warranty service involves the exchange of a Machine or part, the item IBM or your reseller replaces becomes its property and the replacement becomes yours. You represent that all removed items are genuine and unaltered. The replacement may not be new, but will be in good working order and at least functionally equivalent to the item replaced. The replacement assumes the warranty service status of the replaced item. Many features, conversions, or upgrades involve the removal of parts and their return to IBM. A part that replaces a removed part will assume the warranty service status of the removed part.

Before IBM or your reseller exchanges a Machine or part, you agree to remove all features, parts, options, alterations, and attachments not under warranty service.

You also agree to

1. ensure that the Machine is free of any legal obligations or restrictions that prevent its exchange;
2. obtain authorization from the owner to have IBM or your reseller service a Machine that you do not own; and

3. where applicable, before service is provided:
 - a. follow the problem determination, problem analysis, and service request procedures that IBM or your reseller provides;
 - b. secure all programs, data, and funds contained in a Machine;
 - c. provide IBM or your reseller with sufficient, free, and safe access to your facilities to permit them to fulfill their obligations; and
 - d. inform IBM or your reseller of changes in a Machine's location.

IBM is responsible for loss of, or damage to, your Machine while it is 1) in IBM's possession or 2) in transit in those cases where IBM is responsible for the transportation charges.

Neither IBM nor your reseller is responsible for any of your confidential, proprietary or personal information contained in a Machine which you return to IBM or your reseller for any reason. You should remove all such information from the Machine prior to its return.

Limitation of Liability

Circumstances may arise where, because of a default on IBM's part or other liability, you are entitled to recover damages from IBM. In each such instance, regardless of the basis on which you are entitled to claim damages from IBM (including fundamental breach, negligence, misrepresentation, or other contract or tort claim), except for any liability that cannot be waived or limited by applicable laws, IBM is liable for no more than

1. damages for bodily injury (including death) and damage to real property and tangible personal property; and
2. the amount of any other actual direct damages, up to the charges (if recurring, 12 months' charges apply) for the Machine that is subject of the claim. For purposes of this item, the term "Machine" includes Machine Code and Licensed Internal Code.

This limit also applies to IBM's suppliers and your reseller. It is the maximum for which IBM, its suppliers, and your reseller are collectively responsible.

UNDER NO CIRCUMSTANCES IS IBM LIABLE FOR ANY OF THE FOLLOWING: 1) THIRD-PARTY CLAIMS AGAINST YOU FOR DAMAGES (OTHER THAN THOSE UNDER THE FIRST ITEM LISTED ABOVE); 2) LOSS OF, OR DAMAGE TO, YOUR RECORDS OR DATA; OR 3) SPECIAL, INCIDENTAL, OR INDIRECT DAMAGES OR FOR ANY ECONOMIC CONSEQUENTIAL DAMAGES, LOST PROFITS OR LOST SAVINGS, EVEN IF IBM, ITS SUPPLIERS OR YOUR RESELLER IS INFORMED OF THEIR POSSIBILITY. SOME JURISDICTIONS DO NOT ALLOW THE EXCLUSION OR LIMITATION OF INCIDENTAL OR CONSEQUENTIAL DAMAGES, SO THE ABOVE LIMITATION OR EXCLUSION MAY NOT APPLY TO YOU.

Governing Law

Both you and IBM consent to the application of the laws of the country in which you acquired the Machine to govern, interpret, and enforce all of your and IBM's rights, duties, and obligations arising from, or relating in any manner to, the subject matter of this Agreement, without regard to conflict of law principles.

Part 2 - Country-unique Terms

AMERICAS

BRAZIL

Governing Law: *The following is added after the first sentence:*

Any litigation arising from this Agreement will be settled exclusively by the court of Rio de Janeiro.

NORTH AMERICA

Warranty Service: *The following is added to this Section:*

To obtain warranty service from IBM in Canada or the United States, call 1-800-IBM-SERV (426-7378).

CANADA

Governing Law: *The following replaces "laws of the country in which you acquired the Machine" in the first sentence:*

laws in the Province of Ontario.

UNITED STATES

Governing Law: *The following replaces "laws of the country in which you acquired the Machine" in the first sentence:*

laws of the State of New York.

ASIA PACIFIC

AUSTRALIA

The IBM Warranty for Machines: *The following paragraph is added to this Section:*

The warranties specified in this Section are in addition to any rights you may have under the Trade Practices Act 1974 or other similar legislation and are only limited to the extent permitted by the applicable legislation.

Limitation of Liability: *The following is added to this Section:*

Where IBM is in breach of a condition or warranty implied by the Trade Practices Act 1974 or other similar legislation, IBM's liability is limited to the repair or replacement of the goods or the supply of equivalent goods. Where that condition or warranty relates to right to sell, quiet possession or clear title, or the goods are of a kind ordinarily acquired for personal, domestic or household use or consumption, then none of the limitations in this paragraph apply.

Governing Law: *The following replaces "laws of the country in which you acquired the Machine" in the first sentence:*

laws of the State or Territory.

CAMBODIA, LAOS, AND VIETNAM

Governing Law: *The following replaces "laws of the country in which you acquired the Machine" in the first sentence:*

laws of the State of New York.

The following is added to this Section:

Disputes and differences arising out of or in connection with this Agreement shall be finally settled by arbitration which shall be held in Singapore in accordance with the rules of the International Chamber of Commerce (ICC). The arbitrator or arbitrators designated in conformity with those rules shall have the power to rule on their own competence and on the validity of the Agreement to submit to arbitration. The arbitration award shall be final and binding for the parties without appeal and the arbitral award shall be in writing and set forth the findings of fact and the conclusions of law.

All proceedings shall be conducted, including all documents presented in such proceedings, in the English language. The number of arbitrators shall be three, with each side to the dispute being entitled to appoint one arbitrator.

The two arbitrators appointed by the parties shall appoint a third arbitrator before proceeding upon the reference. The third arbitrator shall act as chairman of the proceedings. Vacancies in the post of chairman shall be filled by the president of the ICC. Other vacancies shall be filled by the respective nominating party. Proceedings shall continue from the stage they were at when the vacancy occurred.

If one of the parties refuses or otherwise fails to appoint an arbitrator within 30 days of the date the other party appoints its, the first appointed arbitrator shall be the sole arbitrator, provided that the arbitrator was validly and properly appointed.

The English language version of this Agreement prevails over any other language version.

HONG KONG AND MACAU

Governing Law: *The following replaces "laws of the country in which you acquired the Machine" in the first sentence:*
laws of Hong Kong Special Administrative Region.

INDIA

Limitation of Liability: *The following replaces items 1 and 2 of this Section:*

1. liability for bodily injury (including death) or damage to real property and tangible personal property will be limited to that caused by IBM's negligence;
2. as to any other actual damage arising in any situation involving nonperformance by IBM pursuant to, or in any way related to the subject of this Statement of Limited Warranty, IBM's liability will be limited to the charge paid by you for the individual Machine that is the subject of the claim.

JAPAN

Governing Law: *The following sentence is added to this Section:*
Any doubts concerning this Agreement will be initially resolved between us in good faith and in accordance with the principle of mutual trust.

NEW ZEALAND

The IBM Warranty for Machines: *The following paragraph is added to this Section:*
The warranties specified in this Section are in addition to any rights you may have under the Consumer Guarantees Act 1993 or other legislation which cannot be excluded or limited. The Consumer Guarantees Act 1993 will not apply in respect of any goods which IBM provides, if you require the goods for the purposes of a business as defined in that Act.

Limitation of Liability: *The following is added to this Section:*

Where Machines are not acquired for the purposes of a business as defined in the Consumer Guarantees Act 1993, the limitations in this Section are subject to the limitations in that Act.

PEOPLE'S REPUBLIC OF CHINA (PRC)

Governing Law: *The following replaces this Section:*
Both you and IBM consent to the application of the laws of the State of New York

(except when local law requires otherwise) to govern, interpret, and enforce all your and IBM's rights, duties, and obligations arising from, or relating in any manner to, the subject matter of this Agreement, without regard to conflict of law principles.

Any disputes arising from or in connection with this Agreement will first be resolved by friendly negotiations, failing which either of us has the right to submit the dispute to the China International Economic and Trade Arbitration Commission in Beijing, the PRC, for arbitration in accordance with its arbitration rules in force at the time. The arbitration tribunal will consist of three arbitrators. The language to be used therein will be English and Chinese. An arbitral award will be final and binding on all the parties, and will be enforceable under the Convention on the Recognition and Enforcement of Foreign Arbitral Awards (1958).

The arbitration fee will be borne by the losing party unless otherwise determined by the arbitral award.

During the course of arbitration, this Agreement will continue to be performed except for the part which the parties are disputing and which is undergoing arbitration.

EUROPE, MIDDLE EAST, AFRICA (EMEA)

THE FOLLOWING TERMS APPLY TO ALL EMEA COUNTRIES:

The terms of this Statement of Limited Warranty apply to Machines purchased from IBM or an IBM reseller.

Warranty Service:

If you purchase an IBM Machine in Austria, Belgium, Denmark, Estonia, Finland, France, Germany, Greece, Iceland, Ireland, Italy, Latvia, Lithuania, Luxembourg, Netherlands, Norway, Portugal, Spain, Sweden, Switzerland or United Kingdom, you may obtain warranty service for that Machine in any of those countries from either (1) an IBM reseller approved to perform warranty service or (2) from IBM. If you purchase an IBM Personal Computer Machine in Albania, Armenia, Belarus, Bosnia and Herzegovina, Bulgaria, Croatia, Czech Republic, Georgia, Hungary, Kazakhstan, Kirghizia, Federal Republic of Yugoslavia, Former Yugoslav Republic of Macedonia (FYROM), Moldova, Poland, Romania, Russia, Slovak Republic, Slovenia, or Ukraine, you may obtain warranty service for that Machine in any of those countries from either (1) an IBM reseller approved to perform warranty service or (2) from IBM.

If you purchase an IBM Machine in a Middle Eastern or African country, you may obtain warranty service for that Machine from the IBM entity within the country of purchase, if that IBM entity provides warranty service in that country, or from an IBM reseller, approved by IBM to perform warranty service on that Machine in that country. Warranty service in Africa is available within 50 kilometers of an IBM authorized service provider. You are responsible for transportation costs for Machines located outside 50 kilometers of an IBM authorized service provider.

Governing Law:

The applicable laws that govern, interpret and enforce rights, duties, and obligations of each of us arising from, or relating in any manner to, the subject matter of this Statement, without regard to conflict of laws principles, as well as Country-unique terms and competent court for this Statement are those of the country in which the warranty service is being provided, except that in 1) Albania, Bosnia-Herzegovina, Bulgaria, Croatia, Hungary, Former Yugoslav Republic of Macedonia, Romania, Slovakia, Slovenia, Armenia, Azerbaijan, Belarus, Georgia, Kazakhstan, Kyrgyzstan, Moldova, Russia, Tajikistan, Turkmenistan, Ukraine, and Uzbekistan, the laws of Austria apply; 2) Estonia, Latvia, and Lithuania, the laws of Finland apply; 3) Algeria, Benin, Burkina Faso, Cameroon, Cape Verde, Central African Republic, Chad, Congo,

Djibouti, Democratic Republic of Congo, Equatorial Guinea, France, Gabon, Gambia, Guinea, Guinea-Bissau, Ivory Coast, Lebanon, Mali, Mauritania, Morocco, Niger, Senegal, Togo, and Tunisia, this Agreement will be construed and the legal relations between the parties will be determined in accordance with the French laws and all disputes arising out of this Agreement or related to its violation or execution, including summary proceedings, will be settled exclusively by the Commercial Court of Paris; 4) Angola, Bahrain, Botswana, Burundi, Egypt, Eritrea, Ethiopia, Ghana, Jordan, Kenya, Kuwait, Liberia, Malawi, Malta, Mozambique, Nigeria, Oman, Pakistan, Qatar, Rwanda, Sao Tome, Saudi Arabia, Sierra Leone, Somalia, Tanzania, Uganda, United Arab Emirates, United Kingdom, West Bank/Gaza, Yemen, Zambia, and Zimbabwe, this Agreement will be governed by English Law and disputes relating to it will be submitted to the exclusive jurisdiction of the English courts; and 5) in Greece, Israel, Italy, Portugal, and Spain any legal claim arising out of this Statement will be brought before, and finally settled by, the competent court of Athens, Tel Aviv, Milan, Lisbon, and Madrid, respectively.

THE FOLLOWING TERMS APPLY TO THE COUNTRY SPECIFIED:

AUSTRIA AND GERMANY

The IBM Warranty for Machines: *The following replaces the first sentence of the first paragraph of this Section:*

The warranty for an IBM Machine covers the functionality of the Machine for its normal use and the Machine's conformity to its Specifications.

The following paragraphs are added to this Section:

The minimum warranty period for Machines is six months. In case IBM or your reseller is unable to repair an IBM Machine, you can alternatively ask for a partial refund as far as justified by the reduced value of the unrepaired Machine or ask for a cancellation of the respective agreement for such Machine and get your money refunded.

Extent of Warranty: *The second paragraph does not apply.*

Warranty Service: *The following is added to this Section:*

During the warranty period, transportation for delivery of the failing Machine to IBM will be at IBM's expense.

Limitation of Liability: *The following paragraph is added to this Section:*

The limitations and exclusions specified in the Statement of Limited Warranty will not apply to damages caused by IBM with fraud or gross negligence and for express warranty.

The following sentence is added to the end of item 2:

IBM's liability under this item is limited to the violation of essential contractual terms in cases of ordinary negligence.

EGYPT

Limitation of Liability: *The following replaces item 2 in this Section:*

as to any other actual direct damages, IBM's liability will be limited to the total amount you paid for the Machine that is the subject of the claim. For purposes of this item, the term "Machine" includes Machine Code and Licensed Internal Code.

Applicability of suppliers and resellers (unchanged).

FRANCE

Limitation of Liability: *The following replaces the second sentence of the first paragraph of this Section:*

In such instances, regardless of the basis on which you are entitled to claim damages from IBM, IBM is liable for no more than: *(items 1 and 2 unchanged)*.

IRELAND

Extent of Warranty: *The following is added to this Section:*

Except as expressly provided in these terms and conditions, all statutory conditions, including all warranties implied, but without prejudice to the generality of the foregoing all warranties implied by the Sale of Goods Act 1893 or the Sale of Goods and Supply of Services Act 1980 are hereby excluded.

Limitation of Liability: *The following replaces items one and two of the first paragraph of this Section:*

1. death or personal injury or physical damage to your real property solely caused by IBM's negligence; and
2. the amount of any other actual direct damages, up to 125 percent of the charges (if recurring, the 12 months' charges apply) for the Machine that is the subject of the claim or which otherwise gives rise to the claim.

Applicability of suppliers and resellers (unchanged).

The following paragraph is added at the end of this Section:

IBM's entire liability and your sole remedy, whether in contract or in tort, in respect of any default shall be limited to damages.

ITALY

Limitation of Liability: *The following replaces the second sentence in the first paragraph:*

In each such instance unless otherwise provided by mandatory law, IBM is liable for no more than:

1. *(unchanged)*
2. as to any other actual damage arising in all situations involving nonperformance by IBM pursuant to, or in any way related to the subject matter of this Statement of Warranty, IBM's liability, will be limited to the total amount you paid for the Machine that is the subject of the claim.

Applicability of suppliers and resellers (unchanged).

The following replaces the third paragraph of this Section:

Unless otherwise provided by mandatory law, IBM and your reseller are not liable for any of the following: *(items 1 and 2 unchanged)* 3) indirect damages, even if IBM or your reseller is informed of their possibility.

SOUTH AFRICA, NAMIBIA, BOTSWANA, LESOTHO AND SWAZILAND

Limitation of Liability: *The following is added to this Section:*

IBM's entire liability to you for actual damages arising in all situations involving non-performance by IBM in respect of the subject matter of this Statement of Warranty will be limited to the charge paid by you for the individual Machine that is the subject of your claim from IBM.

UNITED KINGDOM

Limitation of Liability: *The following replaces items 1 and 2 of the first paragraph of this Section:*

1. death or personal injury or physical damage to your real property solely caused by IBM's negligence;
2. the amount of any other actual direct damages or loss, up to 125 percent of the charges (if recurring, the 12 months' charges apply) for the Machine that is the subject of the claim or which otherwise gives rise to the claim;

The following item is added to this paragraph:

3. breach of IBM's obligations implied by Section 12 of the Sale of Goods Act 1979 or Section 2 of the Supply of Goods and Services Act 1982.

Applicability of suppliers and resellers (unchanged).

The following is added to the end of this Section:

IBM's entire liability and your sole remedy, whether in contract or in tort, in respect of any default shall be limited to damages.

Notices

This publication was developed for products and services offered in the U.S.A.

IBM may not offer the products, services, or features discussed in this document in other countries. Consult your local IBM representative for information on the products and services currently available in your area. Any reference to an IBM product, program, or service is not intended to state or imply that only that IBM product, program, or service may be used. Any functionally equivalent product, program, or service that does not infringe any IBM intellectual property right may be used instead. However, it is the user's responsibility to evaluate and verify the operation of any non-IBM product, program, or service.

IBM may have patents or pending patent applications covering subject matter described in this document. The furnishing of this document does not give you any license to these patents. You can send license inquiries, in writing, to:

*IBM Director of Licensing
IBM Corporation
North Castle Drive
Armonk, NY 10504-1785
U.S.A.*

INTERNATIONAL BUSINESS MACHINES CORPORATION PROVIDES THIS PUBLICATION "AS IS" WITHOUT WARRANTY OF ANY KIND, EITHER EXPRESS OR IMPLIED, INCLUDING, BUT NOT LIMITED TO, THE IMPLIED WARRANTIES OF NON-INFRINGEMENT, MERCHANTABILITY OR FITNESS FOR A PARTICULAR PURPOSE. Some states do not allow disclaimer of express or implied warranties in certain transactions, therefore, this statement may not apply to you.

This information could include technical inaccuracies or typographical errors. Changes are periodically made to the information herein; these changes will be incorporated in new editions of the publication. IBM may make improvements and/or changes in the product(s) and/or the program(s) described in this publication at any time without notice.

Any references in this publication to non-IBM Web sites are provided for convenience only and do not in any manner serve as an endorsement of those Web sites. The materials at those Web sites are not part of the materials for this IBM product, and use of those Web sites is at your own risk.

IBM may use or distribute any of the information you supply in any way it believes appropriate without incurring any obligation to you.

Edition notice

© COPYRIGHT INTERNATIONAL BUSINESS MACHINES CORPORATION, 2000.
All rights reserved.

Note to U.S. Government Users — Documentation related to restricted rights — Use, duplication or disclosure is subject to restrictions set forth in GSA ADP Schedule Contract with IBM Corp.

Processing date data

This IBM hardware product and IBM software products that might be packaged with it have been designed, when used in accordance with their associated documentation, to process date data correctly within and between the 20th and 21st centuries, provided all other products (for example, software, hardware, and firmware) used with these products properly exchange accurate date data with them.

IBM cannot take responsibility for the date data processing capabilities of non-IBM products, even if those products are preinstalled or otherwise distributed by IBM. You should contact the vendors responsible for those products directly to determine the capabilities of their products and update them if needed. This IBM hardware product cannot prevent errors that might occur if software, upgrades, or peripheral devices you use or exchange data with do not process date data correctly.

The foregoing is a Year 2000 Readiness Disclosure.

Trademarks

The following terms are trademarks of the IBM Corporation in the United States, other countries, or both:

Alert on LAN	OS/2
Chipkill	PC Server
DB2	Predictive Failure Analysis
EtherJet	ServerProven
HelpCenter	SurePath
HelpWare	TechConnect
IBM	ThinkPad
IntelliStation	Update Connector
Light Path Diagnostics	ValuePoint
Netfinity	Wake on LAN

Lotus and Domino are trademarks of Lotus Development Corporation in the United States, other countries, or both.

Tivoli and NetView are trademarks of Tivoli Systems Inc. in the United States, other countries, or both.

Intel, MMX, LANDesk, Pentium, Pentium II Xeon, and Pentium III Xeon are trademarks of Intel Corporation in the United States, other countries, or both.

Microsoft, Windows, and Windows NT are trademarks of Microsoft Corporation in the United States, other countries, or both.

UNIX is a registered trademark of The Open Group in the United States and other countries.

Java and all Java-based trademarks and logos are trademarks or registered trademarks of Sun Microsystems, Inc. in the United States, other countries, or both.

Other company, product, and service names may be trademarks or service marks of others.

Important notes

Processor speeds indicate the internal clock speed of the microprocessor; other factors also affect application performance.

When referring to hard disk drive capacity, MB stands for 1 000 000 bytes and GB stands for 1 000 000 000 bytes. Total user-accessible capacity may vary depending on operating environments.

Maximum internal hard disk drive capacities assume the replacement of any standard hard disk drives and population of all hard disk drive bays with the largest currently supported drives available from IBM.

Unless otherwise stated, IBM makes no representations or warranties with respect to non-IBM products. Support (if any) for the non-IBM products is provided by the third party, not IBM.

Some software may differ from its retail version (if available), and may not include user manuals or all program functionality.

Electronic emission notices

Federal Communications Commission (FCC) Statement

Note: This equipment has been tested and found to comply with the limits for a Class A digital device, pursuant to Part 15 of the FCC Rules. These limits are designed to provide reasonable protection against harmful interference when the equipment is operated in a commercial environment. This equipment generates, uses, and can radiate radio frequency energy and, if not installed and used in accordance with the instruction manual, may cause harmful interference to radio communications. Operation of this equipment in a residential area is likely to cause harmful interference, in which case the user will be required to correct the interference at his own expense.

Properly shielded and grounded cables and connectors must be used in order to meet FCC emission limits. IBM is not responsible for any radio or television interference caused by using other than recommended cables and connectors or by unauthorized changes or modifications to this equipment. Unauthorized changes or modifications could void the user's authority to operate the equipment.

This device complies with Part 15 of the FCC Rules. Operation is subject to the following two conditions: (1) this device may not cause harmful interference, and (2) this

device must accept any interference received, including interference that may cause undesired operation.

Industry Canada Class A emission compliance statement

This Class A digital apparatus complies with Canadian ICES-003.

Avis de conformité à la réglementation d'Industrie Canada

Cet appareil numérique de classe A est conforme à la norme NMB-003 du Canada.

Australia and New Zealand Class A statement

Attention: This is a Class A product. In a domestic environment this product may cause radio interference in which case the user may be required to take adequate measures.

United Kingdom telecommunications safety requirement

Notice to Customers

This apparatus is approved under approval number NS/G/1234/J/100003 for indirect connection to public telecommunication systems in the United Kingdom.

European Union EMC Directive conformance statement

This product is in conformity with the protection requirements of EU Council Directive 89/336/EEC on the approximation of the laws of the Member States relating to electromagnetic compatibility. IBM cannot accept responsibility for any failure to satisfy the protection requirements resulting from a nonrecommended modification of the product, including the fitting of non-IBM option cards.

This product has been tested and found to comply with the limits for Class A Information Technology Equipment according to CISPR 22/European Standard EN 55022. The Limits for Class A equipment were derived for commercial and industrial environments to provide reasonable protection against interference with licensed communication equipment.

Attention: This is a Class A product. In a domestic environment this product may cause radio interference in which case the user may be required to take adequate measures.

Taiwan electrical emission statement

警告使用者：
這是甲類的資訊產品，在居住的環境中使用時，可能會造成射頻干擾，在這種情況下，使用者會被要求採取某些適當的對策。

Japanese Voluntary Control Council for Interference (VCCI) statement

この装置は、情報処理装置等電波障害自主規制協議会（VCCI）の基準に基づきクラスA情報技術装置です。この装置を家庭環境で使用すると電波妨害を引き起こすことがあります。この場合には使用者が適切な対策を講ずるよう要求されることがあります。

Power cords

For your safety, IBM provides a power cord with a grounded attachment plug to use with this IBM product. To avoid electrical shock, always use the power cord and plug with a properly grounded outlet.

IBM power cords used in the United States and Canada are listed by Underwriter's Laboratories (UL) and certified by the Canadian Standards Association (CSA).

For units intended to be operated at 115 volts: Use a UL-listed and CSA-certified cord set consisting of a minimum 18 AWG, Type SVT or SJT, three-conductor cord, a maximum of 15 feet in length and a parallel blade, grounding-type attachment plug rated 15 amperes, 125 volts.

For units intended to be operated at 230 volts (U.S. use): Use a UL-listed and CSA-certified cord set consisting of a minimum 18 AWG, Type SVT or SJT, three-conductor cord, a maximum of 15 feet in length and a tandem blade, grounding-type attachment plug rated 15 amperes, 250 volts.

For units intended to be operated at 230 volts (outside the U.S.): Use a cord set with a grounding-type attachment plug. The cord set should have the appropriate safety approvals for the country in which the equipment will be installed.

IBM power cords for a specific country or region are usually available only in that country or region.

IBM power cord part number	Used in these countries and regions
13F9940	Argentina, Australia, China (PRC), New Zealand, Papua New Guinea, Paraguay, Uruguay, Western Samoa
13F9979	Afghanistan, Algeria, Andorra, Angola, Austria, Belgium, Benin, Bulgaria, Burkina Faso, Burundi, Cameroon, Central African Rep., Chad, China (Macau S.A.R.), Czech Republic, Egypt, Finland, France, French Guiana, Germany, Greece, Guinea, Hungary, Iceland, Indonesia, Iran, Ivory Coast, Jordan, Lebanon, Luxembourg, Malagasy, Mali, Martinique, Mauritania, Mauritius, Monaco, Morocco, Mozambique, Netherlands, New Caledonia, Niger, Norway, Poland, Portugal, Romania, Senegal, Slovakia, Spain, Sudan, Sweden, Syria, Togo, Tunisia, Turkey, former USSR, Vietnam, former Yugoslavia, Zaire, Zimbabwe
13F9997	Denmark
14F0015	Bangladesh, Burma, Pakistan, South Africa, Sri Lanka

IBM power cord part number	Used in these countries and regions
14F0033	Antigua, Bahrain, Brunei, Channel Islands, China (Hong Kong S.A.R.), Cyprus, Dubai, Fiji, Ghana, India, Iraq, Ireland, Kenya, Kuwait, Malawi, Malaysia, Malta, Nepal, Nigeria, Polynesia, Qatar, Sierra Leone, Singapore, Tanzania, Uganda, United Kingdom, Yemen, Zambia
14F0051	Liechtenstein, Switzerland
14F0069	Chile, Ethiopia, Italy, Libya, Somalia
14F0087	Israel
1838574	Thailand
6952301	Bahamas, Barbados, Bermuda, Bolivia, Brazil, Canada, Cayman Islands, Colombia, Costa Rica, Dominican Republic, Ecuador, El Salvador, Guatemala, Guyana, Haiti, Honduras, Jamaica, Japan, Korea (South), Liberia, Mexico, Netherlands Antilles, Nicaragua, Panama, Peru, Philippines, Saudi Arabia, Suriname, Taiwan, Trinidad (West Indies), United States of America, Venezuela

Index

A

- acoustical noise emissions 2
- adapter
 - considerations 40
 - installation of 41
 - installing 40, 41
 - PCI bus 40
 - working with 39
- adapter fault tolerance 60
- adaptive load balancing 60
- administrator password 21
- Advanced System Management (ASM) bus
 - connecting 64
- Advanced System Management Cabling 64
- Advanced System Management ports 63
- arranging your workspace 7
- audio
 - connectors 13
 - controller 13
 - features 13
- audio adapter
 - troubleshooting information 103
- audio ports 63

B

- battery replacement 109
- beep codes
 - POST 70
- BIOS, restoring 93
- boot block jumper 26

C

- cable management 65
- cabling
 - advanced system management 64
 - connectors on back 64
 - Ethernet 59
 - RS-485 64
- CD-ROM drive 2
- CD-ROM problems 99
- Class A electronic emission notice 127
- components
 - IntelliStation R Pro 25
 - location of 25
 - major 25
- configuration programs 15
- configuration/setup utility
 - using 15
- Configuration/Setup Utility program 15
- configuring
 - Ethernet 59
 - the computer 15
- connecting

- the ASM bus 64
- connectors
 - system board 26
- connectors, external 54
- controller
 - Ethernet 59
- controls and indicators 5
- cover
 - installing 53
 - removing 38
- creating VLAN 62

D

- data rate
 - Ethernet 59
- device breakout cable
 - connecting 55
- device drivers
 - video 12
- diagnostic
 - error code format 82
 - error message tables 86
 - programs and error messages 82
 - programs, starting 84
 - test log, viewing 85
 - text messages 83
- diagnostic tools 67
- DIMM See memory module 46
- diskette drive 2
 - problem 99
- display
 - problem 100

E

- electrical input 2
- electronic emission Class A notice 127
- environment
 - air temperature 2
 - humidity 2
- error
 - diagnostic code format 82
- error log
 - POST 81
- error messages
 - diagnostic 82, 86
 - POST 73
 - SCSI 81
- Ethernet
 - adapter fault tolerance 60
 - adaptive load balancing 60
 - cabling 59
 - Cisco Fast EtherChannel 60
 - configuring 59
 - creating VLAN 62
 - error messages 106

- failover 59
- high performance modes 59
- pin-number assignment 62
- priority packet mode 60
- priority filters 60
- teaming 60
- teaming error messages 108
- troubleshooting information 104
- VLAN 61
- Windows NT error messages 106

Ethernet port 59

expansion bays 2

expansion enclosure

- problem 99

expansion slots 2

- location 39
- type 39

F

failover

- Ethernet 59

fan, replacing 52

FCC Class A notice 127

features

- audio 13

features and specifications 2

filters

- priority 60

H

handling

- static-sensitive devices 30

hard disk drive

- installing 45
- preinstallation steps 44
- replacing 45
- specifications 44

hardware

- problems 67

heat output 2

high priority queue 60

I

I/O ports 54

IEEE 802.1p tagging 60

important notes 127

installing

- an adapter 41
- battery 109
- C2T cables 64
- cover 53
- hard disk drive 45
- memory 46
- microprocessor 49
- options 25
- the device drivers 9

- the operating system 9

installing options 25

integrated

- Ethernet 59

IntelliStation R Pro

- features and specifications 2
- introduction 1
- major components 25
- overview 4

introduction 1

inventory checklist 1

J

jumper

- power-on password override 20

K

keyboard

- problem 100

L

LEDs

- front view 5
- on system board 28
- rear view 6

light path diagnostic panel 5, 6

Light Path Diagnostics 95

Light Path Diagnostics table 97

Light Path Diagnostics panel 96

Lights See LEDs 5

local area network

- Ethernet 59

M

major components 25

management

- cable 65

memory

- installing 46
- problem 100
- specifications 2

memory module

- installing 46
- specifications 2, 4
- supported 46

messages

- diagnostic error 82, 86
- diagnostic text 83
- Ethernet controller 106
- Ethernet teaming error 108
- POST error 73
- SCSI error 81

microprocessor

- installation 49
- installing 48
- problem 100
- specifications 2
- model number 1
- modes
 - Ethernet 59
- monitor
 - problem 100
- mouse
 - problem 100

N

- network connection
 - problems 104
- networks 59
- notices
 - electronic emission, Class A 127
 - FCC, Class A 127
 - miscellaneous 127
 - product 127
 - trademarks 126
- number
 - model 1
 - serial 1

O

- operating your computer 9
- option
 - problem 101
- options
 - installing 25

P

- password
 - administrator 21
 - override jumper 20
 - power-on 20
- password override switch
 - setting 20
- PCI
 - bus A 40
 - bus B 40
 - expansion slots 39
- PCI plug and play
 - Ethernet 59
- pin-number assignments
 - Ethernet 62
- plug and play
 - Ethernet 59
- pointing device
 - problem 100
- port
 - console 55
 - I/O 54
 - serial 57

- serial connector 58
- USB 58
- USB connector 59
- ports
 - Ethernet 59
 - Universal Serial Bus 58
- POST
 - beep codes 70
 - error log 81
 - error messages 73
- POST (power-on self-test) 69
- POST error logs 67
- power
 - problem 102
- power cords 129
- power supply
 - specifications 2
- power-on password 20
- priority filters 60
- priority levels 60
- priority packet mode 60
- problem
 - CD-ROM 99
 - diskette drive 99
 - hardware 67
 - intermittent 100
 - keyboard or mouse 100
 - memory 100
 - microprocessor 100
 - monitor 100
 - network connection 104
 - option 101
 - power 102
 - serial port 102
 - software 103
 - USB port 103
- problem solving 67
- product
 - notices 127
- PXE boot agent utility 15
 - using 23

R

- remote console
 - using the computer as 56
- replacing
 - the fan 52
- RS-485 63

S

- Safety information 31
- safety information
 - book vii, 31
 - electrical ix
 - laser x
 - lifting xi
- safety requirements
 - electronic emission Class A notice 127

- FCC Class A notice 127
- SCSI
 - error messages 81
- SCSISelect utility
 - using 22
- SCSISelect Utility program 15, 22
- selecting a location
 - for the computer 7
- serial number 1
- serial port
 - problem 102
- service summary 111
- setting
 - the password override switch 20
- size 2
- Slots See expansion slots 26, 28
- slots See expansion slots 39
- software
 - problem 103
- software CD content 3
- static-sensitive devices
 - handling 30
- switch block, system board 27
- system board layout
 - connectors
 - options 26
- system board LEDs 28
- system board switch block 27
- system management 4, 63
- system reliability considerations 29

T

- teaming 59
- teaming error messages 108
- test log
 - viewing diagnostic 85
- trademarks 126
- traffic class expediting 60
- troubleshooting 67
 - Ethernet 104
 - the audio adapter 103
- troubleshooting charts 99
- turning off the computer 11
- turning on the computer 10

U

- uninstalling
 - the device drivers 9
- United States electronic emission Class A notice 127
- United States FCC Class A notice 127
- USB
 - cables and hubs 58
 - port connectors 59
- USB port
 - problem 103
- using
 - passwords 20
 - the computer as a remote console 56

- the configuration/setup utility 15
- the PXE boot agent utility 23
- the SCSISelect utility 22
- using the audio features 13

V

- video
 - features 12
 - modes 12
 - monitor settings 12
- video controller
 - disabling 39
 - specifications 2
- video device drivers 12
- video ports 63
- virtual LAN (VLAN) 61
- virtual LAN mode (VLAN) 61
- VLAN, creating 62

W

- working
 - inside a computer
 - with the power on 29