

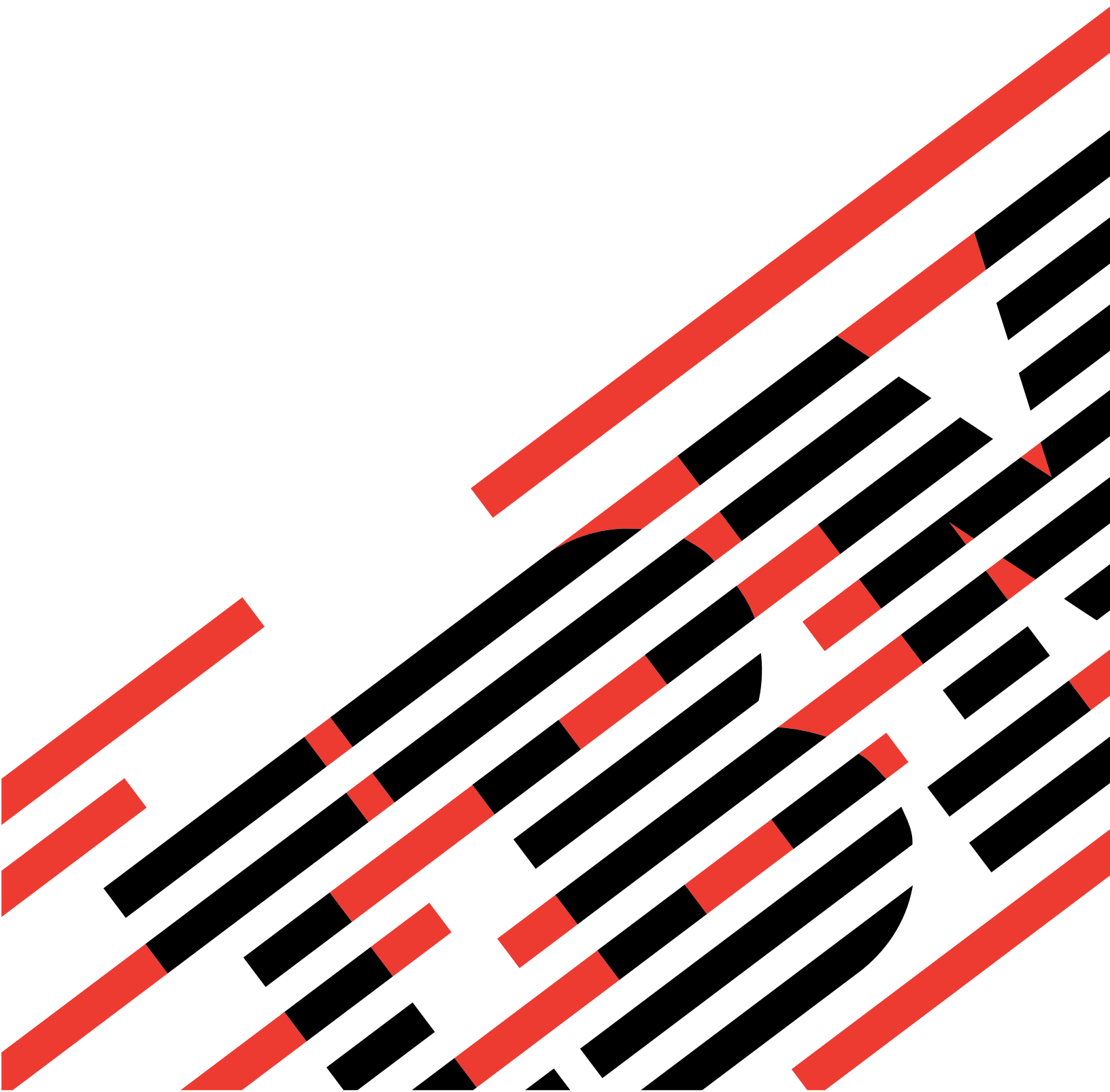

BladeCenter Fibre Channel Switch Management
User's Guide





@server

BladeCenter Fibre Channel Switch Management
User's Guide

Note: Before using this information and the product it supports, read the general information in Appendix C, "Notices", on page 135.

First Edition (January 2003)

© Copyright International Business Machines Corporation 2003. All rights reserved.

US Government Users Restricted Rights – Use, duplication or disclosure restricted by GSA ADP Schedule Contract with IBM Corp.

Contents

Chapter 1. Introduction	1
Related publications	2
Notices used in this book	3
Chapter 2. Command line interface (CLI)	5
Logging on to a switch	5
Command syntax	6
Commands	6
Admin command	8
Alias command	9
Config command	11
Date command	13
Fallback command	14
Help command	15
History command	16
Image command	17
Lip command (for external ports only)	18
Passwd command	19
Ps command	20
Quit command	21
Reset command	22
Set command	26
Set Config command	28
Set Log command	34
Set Port command	36
Set Setup command	38
Show command	41
Show Config command	48
Show Log command	50
Show Perf command	52
Show Setup command	54
Shutdown command	56
Test command	57
Uptime command	59
User command	60
Whoami command	62
Zone command	63
Zoneset command	66
Zoning command	68
Chapter 3. Using the SAN Utility	71
SAN Utility user interface	71
Menu bar	72
Toolbar	73
Fabric tree	74
Graphic window	75
Data window and tabs	75
Working status indicator	75
Using the Topology window	75
Fibre Channel switch module and link status	76
Working with switch modules and links	76
Topology data window tabs	78
Using the Faceplate window	78

Opening the Faceplate window and pop-up menus	78
Port views and status	79
Working with ports	79
Faceplate data window tabs	80
Managing fabrics	80
Setting up security	80
Managing the fabric database	81
Displaying fabric information	84
Zoning a fabric	86
Using the Zoning Config window	89
Restoring default zoning	89
Merging fabrics and zoning	89
Using the Edit Zoning window	90
Managing zone sets	91
Managing zones	93
Managing aliases	95
Managing switch modules	96
Displaying switch module information.	97
Managing alarms	101
Exporting name server information to a file	102
Paging a switch module	102
Setting the date and time	102
Resetting a switch module	102
Configuring a switch module	102
Network properties	105
Archiving a switch module	106
Managing firmware	107
Managing ports	107
Displaying port information	107
Configuring ports.	112
Chapter 4. Switch management utility functions	119
LED diagnostics	119
Heartbeat LED patterns	120
Switch module fault LED flash pattern	121
Switch module OK LED	121
Port logged-in LED flash patterns	121
Port fault LED flash patterns	122
Port testing	122
Fibre Channel switch module monitoring using SNMP	124
SNMP configuration	124
SNMP trap configuration	124
Restoring Fibre Channel switch module configuration	124
Configuration backup	125
Configuration restore	125
Restoring the factory default configuration	125
Reinitializing the configuration file system.	126
Restoring a switch module	126
Using the Fabric View application	126
Starting the Fabric View application	127
Displaying port performance graphs.	127
Arranging and sizing port performance graphs	127
Customizing port performance graphs	128
Appendix A. Mapping port locations and software numbering	131
Port mapping	131

Appendix B. Getting help and technical assistance	133
Before you call	133
Using the documentation.	133
Getting help and information from the World Wide Web	133
Software service and support	134
Hardware service and support.	134
Appendix C. Notices	135
Edition notice	135
Trademarks.	136
Important notes	136
Index	139

Chapter 1. Introduction

You can manage and configure your IBM® eServer BladeCenter™ 2-Port Fibre Channel Switch Module through a Telnet connection to the embedded command line interface (CLI) or by using the IBM BladeCenter SAN Utility application. The SAN Utility provides an intuitive graphical user interface (GUI) that you can use to configure multiple Fibre Channel switch modules through other connected SAN devices from a single interface. The IBM BladeCenter SAN Utility application is referred to throughout this publication as the SAN Utility. The IBM BladeCenter 2-Port Fibre Channel Switch Module is referred to throughout this publication as the switch module.

This *User's Guide* provides instructions to:

- Configure your switch module
- Manage fabrics, ports, and switch modules
- Use Telnet and the CLI to configure switch module parameters

You can manage the BladeCenter fabric through an Ethernet network using the SAN Utility or the CLI. The SAN Utility is installed on a Microsoft® Windows® 2000, Red Hat Linux® Advanced Server Version 2.1, Red Hat Linux Version 7.x, or SuSE Linux Professional Version 8.0 network management workstation.

The switch module has an embedded Telnet server through which a Telnet client can connect and manage the switch module using the CLI. See Chapter 2, "Command line interface (CLI)", on page 5 for more information about Telnet and CLI commands.

SNMP provides monitoring and trap functions for the fabric. The switch module firmware supports SNMP Versions 1, 2, and 3; the Fibre Alliance Management Information Base (FA-MIB) version 4.0; and the Fabric Element Management Information Base (FE-MIB) RFC 2837. Traps are formatted using SNMP version 2.

If you are an experienced user, you can use the Telnet CLI to perform the following tasks:

- Manage the switch module from the BladeCenter management module interface to the Telnet client
- Perform single switch management
- Use advanced control commands

If you are a new user or if you need to manage multiple switch modules from a single interface, you can use the SAN Utility GUI to perform the following tasks:

- Manage your switch module from a remote client or network management workstation
- Manage your multiswitch fabric

For information about installing the switch module and the SAN Utility, see the IBM *BladeCenter 2-Port Fibre Channel Switch Module Installation Guide* that comes with the switch module.

You can obtain up-to-date information about your switch module and other IBM server products at <http://www.ibm.com/eserver/bladecenter/>.

Related publications

This *User's Guide* describes how to use the SAN Utility application. In addition, it describes how to start the Telnet CLI and lists the CLI commands and their usage.

In addition to this *User's Guide*, the following related documentation is provided with your switch module:

- IBM *@server BladeCenter 2-Port Fibre Channel Switch Module Installation Guide*

This publication contains detailed installation instructions for the switch module. This publication also provides general information about your switch module, including information about features, how to install and set up your switch module, how to install the SAN Utility application, and how to get help.

- IBM *@server BladeCenter Type 8677 Installation and User's Guide*

This publication is provided in Portable Document Format (PDF) on the IBM *BladeCenter Documentation CD*. It contains general information about your BladeCenter unit, including:

- Information about features
- How to set up, cable, and start your BladeCenter™ unit
- How to install options in your BladeCenter unit
- How to configure your BladeCenter unit
- How to perform basic troubleshooting of your BladeCenter unit
- How to get help

- IBM *@server BladeCenter HS20 Type 8678 Installation and User's Guide*

This publication is provided in PDF on the IBM *BladeCenter Documentation CD*. It contains general information about your blade server, including:

- Information about features
- How to set up and start your blade server
- How to install options in your blade server
- How to configure your blade server
- How to install an operating system on your blade server
- How to perform basic troubleshooting of your blade server
- How to get help

- IBM *@server HS20 Fibre Channel Expansion Card Installation and User's Guide*

This publication contains instructions for installing your IBM HS20 Fibre Channel Expansion Card in an IBM BladeCenter HS20 blade server and information about:

- Configuring the HS20 Expansion Card
- Updating the BIOS code and device drivers of the HS20 Expansion card

- IBM *@server BladeCenter SAN Solutions Guide*

This publication is provided in PDF on the IBM *BladeCenter Documentation CD*. It provides a user-oriented discussion of how BladeCenter Fibre Channel options are used to provide different SAN storage solutions for various application requirements. This document also provides an overview and description for backup and restore, business continuance and high availability, and storage consolidation and data sharing solutions.

- *IBM @server BladeCenter Fibre Channel Switch Interoperability Guide*
This publication is provided in PDF on the IBM *BladeCenter Documentation* CD. It provides detailed Fibre Channel switch module configuration data and step-by-step configuration procedures for integrating the BladeCenter unit into other vendor switch fabrics. Each vendor configuration includes an initial integration checklist, configuration limitations, supported switch and firmware versions, specific management application operations, and a successful-integration checklist.
- *Rack Installation Instructions*
This publication contains the instructions for installing your BladeCenter unit in a rack.
- *Safety Information*
This multilingual publication is provided in PDF on the IBM *BladeCenter Documentation* CD. It contains translated versions of the caution and danger statements that appear in the documentation. Each caution and danger statement has a number, which you can use to locate the corresponding statement in your language.
- *IBM @server BladeCenter Hardware Maintenance Manual and Troubleshooting Guide*
This publication is provided in PDF on the IBM *BladeCenter Documentation* CD. It contains information to help you solve problems yourself or to provide helpful information to a service technician.

Depending on your blade server model, additional publications might be included on the IBM *BladeCenter Documentation* CD.

In addition to reviewing the publications in this library, be sure to review the IBM *@server BladeCenter Planning and Installation Guide* at <http://www.ibm.com/eserver/bladecenter/> on the World Wide Web for information to help you prepare for installation and configuration.

Notices used in this book

The following notices are used in this book:

- **Notes:** These notices provide important tips, guidance, or advice.
- **Important:** These notices provide information or advice that might help you avoid inconvenient or problem situations.
- **Attention:** These notices indicate potential damage to programs, devices, or data. An attention notice is placed just before the instruction or situation in which damage could occur.

Chapter 2. Command line interface (CLI)

Your switch module contains an embedded Telnet server. This server enables a Telnet client to establish a Telnet session with the switch module to retrieve information or to configure parameters using the CLI. You can use the CLI to perform a variety of fabric and switch management tasks through an Ethernet connection to your BladeCenter unit.

You can access the Telnet interface in two ways:

- In the BladeCenter management module Web interface
- In a command-line window on a connected network management workstation

Important: Before you configure your switch module, be sure that the management modules in your BladeCenter unit are properly configured. In addition, to access and manage your switch module from an external environment, you might need to enable certain features, such as the external ports and external management over all ports. See the applicable *BladeCenter Installation and User's Guide* publications on the IBM *BladeCenter Documentation* CD for more information. For more detailed information about configuring your switch module, see the IBM *@server BladeCenter 2-Port Fibre Channel Switch Module Installation Guide* on the IBM *BladeCenter Documentation* CD.

In addition to reviewing the publications in this library, be sure to review the IBM *@server BladeCenter Planning and Installation Guide* at <http://www.ibm.com/eserver/bladecenter> on the World Wide Web for information to help you prepare for BladeCenter unit installation and configuration.

Logging on to a switch

To log on to a switch using Telnet, complete the following steps:

1. Open a command-line window on the network management workstation, type one of the following commands, and press Enter.

For switch module bay 3:

```
telnet 192.168.70.129
```

For switch module bay 4:

```
telnet 192.168.70.130
```

A command prompt window opens.

2. At the **Login** prompt, type the initial default user ID, USERID. At the **Password** prompt, type the initial default password, PASSWORD (the sixth character is a zero, not the letter O). The user ID and password are case sensitive.

This user account provides full access to the switch and its configuration. After planning your fabric management needs and creating your own user accounts, consider changing the password for this account. See "Commands" on page 6 for more information about authority levels. See the "User command" on page 60 for information about creating user accounts.

Note: The switch module supports a combined maximum of 15 logins. This includes the SAN Utility in-band and out-of-band logins, Telnet out-of-band logins, and SNMP out-of-band logins. A maximum of 10 SAN Utility logins are accepted. Additional logins will be refused.

Command syntax

The command syntax is as follows:

command

keyword

keyword *[value]*

keyword [value1] [value2]

The command is followed by one or more keywords. Consider the following rules and conventions:

- Commands and keywords are lowercase and case sensitive.
- Required keyword values are shown in standard font: [value]. Optional values are shown in italics: *[value]*.
- The underlined portion of each keyword indicates the abbreviated form that can be used. For example the Delete keyword can be abbreviated Del.

Commands

The command set provides for User and Admin authority levels.

- User authority grants viewing access to the fabric and switches using the Show command and other read-only commands.
- Admin authority includes the User authority and grants permission to use the Admin command. The Admin Start command opens an admin session, which provides access to the commands that change switch and fabric configurations. See the “Admin command” on page 8.

Note: Admin authority is enforced only if fabric security is enabled on the switch. By default, fabric security is disabled. See the keywords of the “Set Setup command” on page 38 for information about setting fabric security.

The commands and their page numbers are listed by authority level in Table 1 on page 7. The following Admin session commands have some keywords that are available with User authority:

Alias

Config

Date

Set

User

Zone

Zoneset

Zoning

Table 1. Commands listed by authority level

User authority commands		Admin authority command	
Help	(page 15)	Admin	(page 8)
History	(page 16)	Admin session commands	
Ps	(page 20)	Alias	(page 9)
Quit	(page 21)	Config	(page 11)
Show	(page 41)	Date	(page 13)
Show Config	(page 48)	Fallback	(page 14)
Show Log	(page 50)	Image	(page 17)
Show Perf	(page 52)	Lip	(page 18)
Show Setup	(page 54)	Passwd	(page 19)
Uptime	(page 59)	Reset	(page 22)
Whoami	(page 62)	Set	(page 26)
		Set Config	(page 28)
		Set Log	(page 34)
		Set Port	(page 36)
		Set Setup	(page 38)
		Shutdown	(page 56)
		Test	(page 57)
		User	(page 60)
		Zone	(page 63)
		Zoneset	(page 66)
		Zoning	(page 68)

Admin command

Opens and closes an admin session. The admin session provides commands that change the fabric and switch configurations. Only one admin session can be open on the switch at any time. An inactive admin session will time out after a period of time that can be changed using the Set Setup System command. See the “Set Setup command” on page 38.

Authority

Admin

Syntax

```
admin
    start
    end
    cancel
```

Keywords

start

Opens the admin session.

end

Closes the admin session. The Logout, Shutdown, and Reset Switch commands will also end an admin session.

cancel

Terminates an admin session opened by another user. Use this keyword with care because it terminates the admin session without warning the other user and without saving pending changes.

Notes

Closing a Telnet window during an admin session does not release the session. In this case, you must either wait for the admin session to time out, or use the Admin Cancel command.

Examples

The following example shows how to open and close an admin session.

```
FCSM: user1> admin start

FCSM: (admin) user1>

.
.
.

FCSM (admin) : user1> admin end
FCSM: user1>
```

Alias command

Creates a named set of ports. Aliases make it easier to assign a set of ports to many zones. An alias cannot have a zone or another alias as a member.

Authority

Admin

Syntax

alias

```
add [alias] [members]
copy [alias_source] [alias_destination]
create [alias]
delete [alias]
list
members [alias]
remove [alias] [members]
rename [alias_old] [alias_new]
```

Keywords

add [alias] [members]

Specifies one or more ports given by [members] to add to the alias named [alias]. An alias can have a maximum of 2000 members. [members] can have one of the following formats:

- Domain ID and port number pair (domain ID, port number). Domain IDs and port numbers are in decimal format. Ports are numbered beginning with 0.
- 6-character hexadecimal device Fibre Channel address (hex)
- 16-character hexadecimal port worldwide name (PWWN) with the format xx:xx:xx:xx:xx:xx:xx:xx.

The application verifies that the [alias] format is correct but does not validate that such a port exists.

copy [alias_source] [alias_destination]

Creates a new alias named [alias_destination] and copies the membership into it from the alias given by [alias_source].

create [alias]

Creates an alias with the name given by [alias]. An alias name must begin with a letter and be no longer than 64 characters. Valid characters are 0-9, A-Z, a-z, &, _, and -. The zoning database supports a maximum of 256 aliases.

delete alias

Deletes the specified alias given by [alias] from the zoning database. If the alias is a member of the active zone set, the alias will not be removed from the active zone set until the active zone set is deactivated.

list

Displays a list of all aliases. This keyword is valid for User authority and does not require a zoning edit session or an admin session.

members [alias]

Displays all members of the alias given by [alias]. This keyword is available with User authority and does not require a zoning edit session or an admin session.

remove [alias] [members]

Removes the ports given by [members] from the alias given by [alias]. [members] can have one of the following formats:

- Domain ID and port number pair (domain ID, port number). Domain IDs and port numbers are in decimal format. Ports are numbered beginning with 0.
- 6-character hexadecimal device Fibre Channel address (hex)
- 16-character hexadecimal port worldwide name (PWWN) for the device with the format xx:xx:xx:xx:xx:xx:xx:xx.

rename [alias_old] [alias_new]

Renames the alias given by [alias_old] to the alias given by [alias_new].

Config command

Manages the Fibre Channel configurations on a switch. For information about setting the port and switch configurations, see the “Set Config command” on page 28.

Authority

Admin for all keywords except List

Syntax

config

activate [config]
backup
cancel
copy [config_source] [config_destination]
delete [config]
edit [config]
list
restore
save [config]

Keywords

activate [config]

Activates the configuration given by [config]. If you omit the configuration, the currently active configuration is used. Only one configuration can be active at a time.

backup

Creates a file named *configdata*, which contains the configuration information. To download this file, open a File Transfer Protocol (FTP) session, log in with account name of images and password of images, and type get configdata.

cancel

Terminates the current configuration edit session without saving changes that were made.

copy [config_source] [config_destination]

Copies the configuration given by [config_source] to the configuration given by [config_destination]. The switch supports up to 10 configurations including the default configuration.

delete [config]

Deletes the specified configuration file where [config] is a file name.

edit [config]

Opens an edit session for the configuration given by [config]. If you omit the configuration name, the currently active configuration is used.

list

Displays a list of all available configurations. This keyword is available with User authority.

restore

Restores configuration settings to an out-of-band switch from a backup file named configdata, which must be first uploaded on the switch using FTP. You create the backup file using the Config Backup command. Use FTP to load the backup file on a switch, and then enter the Config Restore command.

save [config]

Saves changes made during a configuration edit session in the configuration

given by [config]. If you omit the configuration name value, the configuration you chose for the Config Edit command is used.

Notes

If you edit the active configuration, changes will be suspended until you reactivate the configuration or activate another configuration.

Examples

The following shows an example of how to open and close a Config Edit session.

```
FCSM: user1> admin start
```

```
FCSM (admin) : user1> config edit
```

```
.
```

```
.
```

```
FCSM (admin-config) : user1> config cancel
```

```
Configuration mode will be canceled.Please confirm (y/n): [n] y
```

```
FCSM (admin) : user1> admin end
```

Date command

Displays or sets the blade server date and time. To set the date and time, you must provide the information string in this format: *MMDDhhmmCCYY*, where *MM* = month, *DD* = day, *hh* = hour, *mm* = minute, *CC* = century, and *YY* = year. You must reset the switch for the new date to take effect.

Authority

Admin to change the date; user to display the date.

Syntax

date
[MMDDhhmmCCYY]

Keywords

[MMDDhhmmCCYY]

Specifies the date – this requires an admin session. If you omit *[MMDDhhmmCCYY]*, the current date is displayed – this is available with User authority.

Examples

The following is an example of the Date command.

```
FCSM: user1> date
Thu Sep 26 07:51:24 2002
```

Fallback command

Loads the fallback version of the firmware from switch memory. The switch stores two versions of the firmware. This command alternately activates the two versions.

Authority

Admin

Syntax

fallback

Notes

- The Show Switch command displays the available firmware versions and the currently active version.
- After running the Fallback command, reset the switch for the firmware to be in effect.

Examples

The following is an example of the Fallback command.

```
FCSM: user1> admin start
FCSM (admin) : user1> fallback
    Reverting to previous software image. Please confirm (y/n): [n] y
FCSM: user1> admin end
FCSM: user1>
```

Help command

Displays a brief description of the specified command and its keywords.

Authority

User

Syntax

help

[command]

[keyword]

Keywords

[command]

A command name. If you omit this value, all available commands from which to choose are displayed.

[keyword]

A keyword associated with the command named by *[command]*. If you omit this value, available keywords for the specified command are displayed.

all Displays a list of all available commands (including command variations).

Examples

The following is an example of the Help Set command.

```
FCSM: user1> help set
```

```
set SET_OPTIONS
```

```
There are many attributes that can be set.
```

```
Type help with one of the following to get more information:
```

```
set alarm
set beacon
set blade
set config blade
set config port
set config ports
set config switch
set config threshold
set config zoning
set log
set pagebreak
set port
set setup snmp
set setup system
set switch
```

The following is an example of the Help Set Beacon command.

```
FCSM: user1> help set beacon
```

```
set beacon On | Off
```

```
This command allows the lights on the front of the switch to flash.
```

```
The On option will start and the Off option will stop the flashing.
```

History command

Displays a numbered list of the previously entered commands from which you can re-execute selected commands.

Authority

User

Syntax

history

Notes

Use the History command to provide context for the ! command.

- Enter ![command] to re-enter the most recent execution of that command.
- Enter ![line number] to re-execute the corresponding command from the History display
- Enter ![partial command string] to re-execute a command that matches the command string.
- Enter !! to re-execute the most recent command.

Examples

The following is an example of the History command.

```
FCSM: user1> history
 1 show switch
 2 date
 3 help set
 4 history
```

```
FCSM: user1> !2
date
```

```
Thu Sep 26 11:03:07 2002
```

Image command

Manages and installs switch firmware.

Authority

Admin

Syntax

image

cleanup

fetch [account_name] [ip_address] [file_source] [file_destination]

list

unpack [file]

Keywords

cleanup

Removes all firmware image files from the switch. All firmware image files are removed automatically each time the switch is reset.

fetch [account_name] [ip_address] [file_source] [file_destination]

Retrieves image file given by [file_source] and stores it on the switch with the file name given by [file_destination]. The image file is retrieved from the device with the IP address given by [ip_address] and an account name given by [account_name]. If an account name needs a password to access the device, you are prompted for it.

list

Displays the list of image files that reside on the switch.

unpack [file]

Installs the firmware file given by [file]. After unpacking the file, a message appears confirming successful unpacking. The switch must be reset for the new firmware to take effect.

Lip command (for external ports only)

Reinitializes the specified loop port.

Authority

Admin

Syntax

lip
 [port_number]

Keywords

[port_number]

The number of the port to be reinitialized.

Examples

The following is an example of the Lip command.

```
FCSM (admin) : user1> lip 2
```

Passwd command

Changes the password for a user account.

Authority

Admin to change the password for another account; user to change your own.

Syntax

```
passwd  
    [account_name]
```

Keywords

[account_name]

The user account name. You must open an admin session to change the password for an account name other than your own. If you omit [account_name], you are prompted to change the password for the current account name.

Examples

The following is an example of the Passwd command.

```
FCSM (admin) : user1> passwd user2
```

```
    Press 'q' and the ENTER key to abort this command.
```

```
account OLD password      :  
account NEW password (4-20 chars) :
```

```
please confirm account NEW password:
```

```
password has been changed.
```

Note: If you lose the password for the account, contact IBM Support (see Appendix B, “Getting help and technical assistance”, on page 133).

Ps command

Displays current blade server process information.

Authority

User

Syntax

ps

Examples

The following is an example of the Ps command.

```
FCSM: user1> ps
PID  PPID  %CPU   TIME      ELAPSED  COMMAND
 341   329   0.0   00:00:00  2-00:58:29  cns
 342   329   0.0   00:00:02  2-00:58:29  ens
 343   329   0.0   00:00:27  2-00:58:29  dlog
 344   329   1.3   00:40:39  2-00:58:29  ds
 345   329   1.4   00:41:38  2-00:58:29  mgmtApp
 346   329   0.0   00:00:06  2-00:58:29  fc2
 347   329   0.5   00:16:35  2-00:58:29  nserver
 348   329   0.4   00:12:20  2-00:58:29  mserver
 349   329   3.6   01:47:29  2-00:58:29  util
 350   329   0.0   00:00:36  2-00:58:29  snmpservicepath
 351   329   0.5   00:15:24  2-00:58:29  eport
 352   329   0.0   00:00:05  2-00:58:29  PortApp
 361   329   0.0   00:00:08  2-00:58:28  port_mon
 362   329   0.2   00:07:14  2-00:58:28  zoning
 363   329   0.0   00:00:00  2-00:58:28  diagApp
 385   329   0.0   00:00:02  2-00:58:18  snmpd
 386   329   0.0   00:00:00  2-00:58:18  snmpmain
```

Quit command

Closes the Telnet session.

Authority

User

Syntax

quit, exit, or logout

Reset command

Resets the switch and port configuration parameters.

Authority

Admin

Syntax

reset

config [*config_name*]
factory
port [*port_number*]
snmp
switch (default)
system
zoning

Keywords

config [*config_name*]

Resets the configuration given by [*config_name*] to the factory default values for switch, port, alarm threshold, and zoning configuration. This keyword clears all zoning definitions. If [*config_name*] does not exist on the switch, a configuration with that name is created. If you omit [*config_name*], the active configuration is reset. You must activate the configuration or reset the switch for the changes to take effect. See Table 2 through Table 4 on page 24.

factory

Resets switch, alarm threshold, port, SNMP, zoning configuration, and blade server configuration settings to the factory default values. The switch configuration is activated automatically. See Table 2 through Table 6 on page 24.

port [*port_number*]

Reinitializes the port given by [*port_number*]. Ports are numbered beginning with 0. For more information, see Table 37 on page 131.

snmp

Resets the SNMP configuration settings to the factory default values. See Table 5 on page 24 for SNMP configuration default values.

switch

Reinitializes the switch. This is the default. This command also closes the Telnet session.

system

Resets the blade server configuration settings to the factory default values. See Table 6 on page 24 for configuration default values.

zoning

Clears the zoning database and deactivates the active zone set. The zoning configuration values remain unchanged.

Notes

The following tables specify the various factory default settings.

Table 2. Switch configuration defaults

Parameter	Default
Admin State	Online

Table 2. Switch configuration defaults (continued)

Parameter	Default
Broadcast Enabled	True
Inband Enable	True
Domain ID	1
Domain ID Lock	False
Symbolic Name	Fibre Channel Switch Module
R_T_TOV	100
R_A_TOV	10000
E_D_TOV	2000
FS_TOV	5000
DS_TOV	5000
Principal Priority	254
System Description	IBM BladeCenter 2-Port Fibre Channel Switch Module
Configuration Last Saved By	Initial
Configuration Last Saved On	Initial

Table 3. Port configuration defaults

Parameter	External port (0,15) default	Internal port (1-14) default
Admin State	Online	Online
Link Speed	Auto	2 Gbps
Port Type	GL	F
TL_Port Mode	TLTargetMode	TLTargetMode
ISL Security	Any	Any
Symbolic Name	Port0 or Port15	Port1 – Port14
ALFairness	False	False
ARB_FF	False	False
InteropCredit	0	0
ExtCredit	0	0
FanEnable	True	True
LCFEnable	False	False
MFSEnable	True	True
MFS_TOV	10	10
MSEnable	True	True
NoClose	False	False
IOStreamGuard	False	False
VIEnable	False	False
CheckAlps	False	False

Table 4. Threshold configuration defaults

Parameter	Default
ThresholdMonitoringEnabled	True
CRCErrorsMonitoringEnabled	True
RisingTrigger	25
FallingTrigger	1
SampleWindow	10
DecodeErrorsMonitoringEnabled	True
RisingTrigger	200
FallingTrigger	0
SampleWindow	10
ISLMonitoringEnabled	True
RisingTrigger	2
FallingTrigger	0
SampleWindow	10
LoginMonitoringEnabled	True
RisingTrigger	5
FallingTrigger	1
SampleWindow	10
LogoutMonitoringEnabled	True
RisingTrigger	5
FallingTrigger	1
SampleWindow	10
LOSMonitoringEnabled	True
RisingTrigger	100
FallingTrigger	5
SampleWindow	10

Table 5. SNMP configuration defaults

Parameter	Default
Contact	Undefined
Location	Undefined
Description	Undefined
Trap [1] Address	10.0.0.1
Trap [2-5] Address	0.0.0.0
Trap [1-5] Port	162
Trap [1-5] Severity	Warning
Trap [1-5] Enabled	False
ObjectID	1.3.6.1.4.1.1663.1.1.1.1.16
AuthFailureTrap	False

Table 6. System configuration defaults

Parameter	Default
Ethernet Network IP Address	Switch module bay 3: 192.168.70.129 Switch module bay 4: 192.168.70.130
Ethernet Network IP Mask	255.255.255.0
Ethernet Gateway Address	10.90.90.254

Table 6. System configuration defaults (continued)

Parameter	Default
Ethernet Network Discovery	Static
Admin Timeout	30 minutes
Security Enabled	False
Local Log Enabled	True
Remote Log Enabled	False
Remote Log Host IP Address	10.0.0.254

Set command

Sets a variety of port and switch parameters.

Authority

Admin for all keywords except Alarm Clear, Beacon, and Pagebreak which are available with User authority.

Syntax

set

- alarm clear
- beacon [state]
- config [option]
- log [option]
- pagebreak [state]
- port [option]
- setup [option]
- switch [state]

Keywords

alarm clear

Clears the alarm log. This keyword is available with User authority.

beacon [state]

Enables or disables the flashing of the Port Logged-in LEDs according to [state]. This keyword is available with User authority. [state] can be one of the following:

On

Enables the flashing beacon.

Off

Disables the flashing beacon.

config [option]

Sets port, switch, alarm threshold, and zoning configuration parameters. See the “Set Config command” on page 28.

log [option]

Specifies the type of entries to be entered in the event log. See the “Set Log command” on page 34.

pagebreak [state]

Specifies how much information is displayed on the screen at a time according to the value given by [state]. This keyword is available with User authority. [state] can be one of the following:

on

Limits the display of information to 20 lines at a time.

off

Allows continuous display of information without a break.

port [option]

Sets port state and speed for the specified port temporarily until the next switch reset or new configuration activation. See the “Set Port command” on page 36.

setup [option]

Changes SNMP and blade server configuration settings. See the “Set Setup command” on page 38.

switch [state]

Temporarily changes the administrative state for all ports on the switch to the state given by [state]. The previous Set Config Switch settings are restored after a switch reset or a reactivation of a switch configuration. [state] can be one of the following:

Online

Places all ports online

Offline

Places all ports offline.

Diagnostics

Prepares all ports for testing.

Set Config command

Sets port, switch, alarm threshold, and zoning configuration parameters.

Authority

Admin authority and a Config Edit session. See the “Config command” on page 11 for information about starting a Config Edit session.

Syntax

set config

```
port [port_number]
ports [port_number]
switch
threshold
zoning
```

Keywords

port [port number]

Initiates an editing session in which to change configuration parameters for the port number given by [port_number]. If you omit [port_number], the BladeCenter unit begins with port 0 and proceeds in order through port 15. For each parameter, enter a new value or press the Enter key to accept the current value shown in brackets. Type q to cancel the configuration for one port, or qq to cancel the configuration for all ports. Table 7 describes the port parameters.

Note: For external ports (0,15), all port parameters apply. For internal ports, only the port state setting is configurable. For information about port numbering and mapping, see Table 37 on page 131.

ports [port number]

Initiates an editing session in which to change configuration parameters for all ports based on the configuration for the port given by [port_number]. If you omit [port_number], port 0 is used. For each parameter, enter a new value or press the Enter key to accept the current value shown in brackets. Type q to cancel the configuration. Table 7 describes the port parameters. For external ports (0,15), all parameters apply. For internal ports (1 through 14) only AdminState applies.

Table 7. Set Config port parameters

Parameter	Description
AdminState	Port administrative state: online, offline, diagnostics, or down.
LinkSpeed	1 Gbps or 2 Gbps
PortType	Type of port
TLPortMode	Initiates the configuration of external ports attributes. Indicates whether using initiator or target devices on the loop. If you specify [port_number], the display will present attributes for that port only; otherwise, all attributes for all ports will be available for configuration.

Table 7. Set Config port parameters (continued)

Parameter	Description
ISLSecurity	E_Port security. Determines which switches a port will establish a link with. <ul style="list-style-type: none"> Any - Will link with any switch. Ours - Will link only to another BladeCenter Fibre Channel switch module. None - The port will not establish an ISL link.
SymbolicPortName	Descriptive name
ALFairness	Default is switch that has priority
ARB_FF	Use ARB_FF instead of idles on loop FCAL option
InteropCredit	Number of buffer-to-buffer credits per port. 0 means the default (12) is unchanged.
ExtCredit	Extended credit port
FANEnable	Fabric Address Notification. If enabled, notifies logged-in NL_Ports of the FL_Port address, port name, and node name.
LCFEnable	Link control frame preference, R_CTL = 0xC
MFSEnable	Multi-frame sequence bundling
MFS_TOV	MFS limit for camp on
MSEnable	Management Server enable on this port
NoClose	Do not close unless another device arbitrates
I/O Stream Guard	Enables or disables the suppression of RSCN messages
VIEnable	Not applicable
CheckAlps	Close before sending frames to new target

switch

Initiates an editing session in which to change switch configuration settings. Each parameter is displayed, one line at a time and prompts you for a value. For each parameter, type a new value or press the Enter key to accept the current value shown in brackets. Type q to cancel the configuration.

Table 8. Set Config switch parameters

Parameter	Description
AdminState	Switch administrative state: online, offline, or diagnostics.
Broadcast Enable	Enables (True) or disables (False) forwarding if broadcasting frames.
InbandEnabled	Enables (True) or disables (False) the ability to manage the switch over an ISL.
DefaultDomainID	Default domain ID setting.
DomainIDLock	Prevents (True) or allows (False) dynamic reassignment of the domain ID.
SymbolicName	Descriptive name

Table 8. Set Config switch parameters (continued)

Parameter	Description
R_T_TOV	Receiver Transmitter Timeout Value. Specifies the number of milliseconds a port is to wait to receive a response from another port. The default is 100.
R_A_TOV	Resource Allocation Timeout Value. The number of milliseconds the switch waits to allow two ports to allocate enough resources to establish a link. The default is 10000.
E_D_TOV	Error Detect Timeout Value. The number of milliseconds a port is to wait for errors to clear. The default is 2000 msec.
FS_TOV	Fabric Stability Timeout Value. The default is 5000 msec.
DS_TOV	Distributed Services Timeout Value (Management Server, Name Server). The default is 5000 msec.
PrincipalPriority	The priority used in the FC-SW-2 principal switch selection algorithm. 1 is high, 255 is low.
ConfigDescription	The name for the configuration. The default is undefined.

threshold

Initiates a configuration session by which to generate and log alarms for selected events. Each event, its thresholds, and sampling interval is displayed, one line at a time and you are prompted for a value. For each parameter, enter a new value or press the Enter key to accept the current value shown in brackets. These parameters must be saved in a configuration and activated before they will take effect. See the “Config command” on page 11 for information about saving and activating a configuration. Table 9 describes the Set Config threshold parameters.

Table 9. Set Config threshold parameters

Parameter	Description
Threshold Monitoring Enabled	Master enable/disable parameter for all events. Enables (True) or disables (False) the generation of all enabled event alarms.
CRCErrorsMonitoringEnabled DecodeErrorsMonitoringEnabled ISLMonitoringEnabled LoginMonitoringEnabled LogoutMonitoringEnabled LOSMonitoringEnabled	The event type enable/disable parameter. Enables (True) or disables (False) the generation of alarms for each of the following events: <ul style="list-style-type: none"> • CRC errors • Decode errors • ISL connection count • Login errors • Logout errors • Loss-of-signal errors
Rising Trigger	The event count above which an event is logged. Once the count exceeds the rising threshold, one alarm is logged. The switch will not generate another alarm for that event until the count falls below the falling threshold and rises again above the rising threshold.

Table 9. Set Config threshold parameters (continued)

Parameter	Description
Falling Trigger	The event count above which an event becomes eligible for logging in the alarm log.
Sample Window	The period of time in seconds in which to count events.

zoning

Initiates an editing session in which to change switch zoning attributes. Each parameter is displayed, one line at a time, and you are prompted for a value. For each parameter, enter a new value or press the Enter key to accept the current value shown in brackets.

Table 10. Set Config zoning parameters

Parameter	Description
AutoSave	Determines whether zoning changes will be saved to flash (nonvolatile) memory (On) or to RAM (volatile) (Off). The default is On.
Default	Determines communication among ports/devices in the absence of an active zone set. "All" enables all ports/devices to communicate with one another. "None" prohibits communication among ports/devices.

Examples

The following is an example of the Set Config Port command.

```
FCSM: user1> admin start
FCSM (admin) : user1> config edit
FCSM (admin-config) : user1> set config port 0
```

A list of attributes with formatting and current values will follow. Enter a new value or simply press the ENTER key to accept the current value. If you wish to terminate this process before reaching the end of the list press 'q' or 'Q' and the ENTER key to do so.

```
Configuring Port Number: 0
```

```
-----
```

```
AdminState      (1=Online, 2=Offline, 3=Diagnostics, 4=Down) [Online      ]
LinkSpeed       (1=1Gb/s, 2=2Gb/s, 3=Auto)                 [Auto        ]
PortType        (TL / GL / G / F / FL / Donor)              [GL          ]
TLPortMode      (1=TLTargetMode, 2=TLInitiatorMode)         [TLTargetMode]
ISLSecurity     (Any / Ours / None)                         [Any         ]
SymPortName     (string, max=32 chars)                      [Port0       ]
ALFairness     (True / False)                             [False       ]
ARB_FF          (True / False)                             [False       ]
InteropCredit   (decimal value, 0-255)                      [0           ]
ExtCredit       (dec value, increments of 11, non-loop only) [0           ]
FANEnable      (True / False)                             [True        ]
LCFEnable      (True / False)                             [False       ]
MFSEnable      (True / False)                             [True        ]
MFS_TOV        (decimal value, 10-20480 msec) [10          ]
MSEnable       (True / False)                             [True        ]
NoClose        (True / False)                             [False       ]
IOStreamGuard  (Enable / Disable)              [Disabled    ]
VIEnable       (True / False)                             [False       ]
CheckAlps     (True / False)                             [False       ]
```

Finished configuring attributes.
 This configuration must be saved (see config save command) and
 activated (see config activate command) before it can take effect.
 To discard this configuration use the config cancel command.

The following is an example of the Set Config Switch command.

```
FCSM: user1> admin start
FCSM (admin) : user1> config edit
FCSM (admin-config) : user1> set config switch
```

A list of attributes with formatting and current values will follow.
 Enter a new value or simply press the ENTER key to accept the current value.
 If you wish to terminate this process before reaching the end of the list
 press 'q' or 'Q' and the ENTER key to do so.

```
AdminState          (1=Online, 2=Offline, 3=Diagnostics) [Online]
BroadcastEnabled    (True / False) [True]
InbandEnabled       (True / False) [True]
DefaultDomainID     (decimal value, 1-239) [1]
DomainIDLock        (True / False) [False]
SymbolicName        (string,max=32 chars) [Fibre Channel Switch Module]
R_T_TOV             (decimal value, 1-1000 msec) [100]
R_A_TOV             (decimal value, 100-100000 msec) [10000]
E_D_TOV             (decimal value, 10-20000 msec) [2000]
FS_TOV              (decimal value, 100-100000 msec) [5000]
DS_TOV              (decimal value, 100-100000 msec) [5000]
PrincipalPriority    (decimal value, 1-255) [254]
ConfigDescription   (string, max=64 chars) [IBM BladeCenter(TM) 2-port
                                                Fibre Channel Switch Module]
```

Finished configuring attributes.
 This configuration must be saved (see config save command) and
 activated (see config activate command) before it can take effect.
 To discard this configuration use the config cancel command.

The following is an example of the Set Config Threshold command.

```
FCSM (admin-config) : user1> set config threshold
A list of attributes with formatting and current values will follow.
Enter a new value or simply press the ENTER key to accept the current value.
If you wish to terminate this process before reaching the end of the list
press 'q' or 'Q' and the ENTER key to do so.
```

```
ThresholdMonitoringEnabled    (True / False) [False]

CRCErrorsMonitoringEnabled    (True / False) [False]
  RisingTrigger                (decimal value, 1-1000) [25 ]
  FallingTrigger                (decimal value, 0-1000) [1  ]
  SampleWindow                  (decimal value, 1-1000 sec) [10 ]

DecodeErrorsMonitoringEnabled (True / False) [True ]
  RisingTrigger                (decimal value, 1-1000) [200 ]
  FallingTrigger                (decimal value, 0-1000) [0  ]
  SampleWindow                  (decimal value, 1-1000 sec) [10 ]

ISLMonitoringEnabled          (True / False) [True ]
  RisingTrigger                (decimal value, 1-1000) [2  ]
  FallingTrigger                (decimal value, 0-1000) [0  ]
  SampleWindow                  (decimal value, 1-1000 sec) [10 ]

LoginMonitoringEnabled         (True / False) [True ]
  RisingTrigger                (decimal value, 1-1000) [5  ]
  FallingTrigger                (decimal value, 0-1000) [1  ]
  SampleWindow                  (decimal value, 1-1000 sec) [10 ]

LogoutMonitoringEnabled       (True / False) [True ]
  RisingTrigger                (decimal value, 1-1000) [5  ]
  FallingTrigger                (decimal value, 0-1000) [1  ]
  SampleWindow                  (decimal value, 1-1000 sec) [10 ]
```

LOSMonitoringEnabled	(True / False)	[True]
RisingTrigger	(decimal value, 1-1000)	[100]
FallingTrigger	(decimal value, 0-1000)	[5]
SampleWindow	(decimal value, 1-1000 sec)	[10]

The following is an example of the Set Config Zoning command.

```
FCSM: user1> admin start
FCSM (admin) : user1> config edit
FCSM (admin-config) : user1> set config zoning
```

A list of attributes with formatting and current values will follow.
Enter a new value or simply press the ENTER key to accept the current value.
If you wish to terminate this process before reaching the end of the list
press 'q' or 'Q' and the ENTER key to do so.

AutoSave	(True / False)	[True]
Default	(All / None)	[All]

Finished configuring attributes.
This configuration must be saved (see config save command) and
activated (see config activate command) before it can take effect.
To discard this configuration use the config cancel command.

Set Log command

Specifies the type of entries to be entered in the event log. The log is a storage file contained on the switch. The log can hold a maximum of 200 entries. When the log becomes full, the entries are replaced, starting with the oldest entry, to produce a list of the last 200 events which occurred. Log entries are created for ports, components, and event severity levels.

Authority

Admin

Syntax

set log

- archive
- clear
- component [list]
- level [level]
- port [port_list]
- restore
- save
- start (default)
- stop

Keywords

archive

Archives the log entries to a file on the switch named *logfile* that can be downloaded from the switch using FTP. To download the log file, open an FTP session, log in with an account name of *images* and password of *images*, and type `get logfile`.

clear

Clears all log entries.

component [list]

Specifies one or more components to monitor for events. Use spaces to delimit values in the list. Use one or more of the following values:

All

Monitors all components. To maintain optimal switch performance, do not use this setting with the Level keyword set to Info.

Blade

Not applicable

Chassis

Not applicable

Eport

Monitors all E_Ports.

Mgmtserver

Monitors management server status.

Nameserver

Monitors name server status.

None

Monitors none of the component events.

Other

Monitors other miscellaneous events.

Port
Monitors all port events.

Switch
Monitors switch management events.

Zoning
Monitors zoning conflict events.

level [level]

Specifies the severity level given by [level] to use in monitoring events for the specified components or ports. [level] can be one of the following values:

Critical
Monitors critical events.

Warn
Monitors warning events.

Info
Monitors informational events. To maintain optimal switch performance, do not use this setting with the Component keyword set to All.

None
Monitors none of the severity levels.

port [port_list]

Specifies one or more ports to monitor for events. Use one of the following values:

[port_list]
Specifies port or ports to monitor. Use spaces to delimit values in the list. Ports are numbered beginning with 0.

All
Specifies all ports.

None
Disables monitoring on all ports.

restore

Returns the port, component, and level settings to the default values.

save

Saves the log settings for the component, level, and port. These settings remain in effect after a switch reset. The log settings can be viewed using the Show Log Settings command. To export log entries to a file, use the Set Log Archive command.

start

Starts the logging of events based on the Port, Component, and Level keywords assigned to the current configuration. The logging continues until you enter the Set Log Stop command.

stop

Stops logging of events.

Notes

To maintain optimal switch performance, do not set the Component keyword to All and the Level keyword to Info at the same time.

Set Port command

Sets port state and speed for the specified port temporarily until the next switch reset or new configuration activation. This command also clears port counters. For information about port numbering and mapping, see Table 37 on page 131.

Note: For external ports (0,15), all port parameters apply. For internal ports, only the port state setting is configurable.

Authority

Admin

Syntax

set port [port_number]

bypass [alpa] (for external ports only)
clear
enable [alpa] (for external ports only)
speed [transmission_speed]
state [state]

Keywords

[port_number]

Specifies the port. Ports are numbered beginning with 0. For information about port numbering and mapping, see Table 37 on page 131.

bypass [alpa]

Sends a Loop Port Bypass (LPB) to a specific Arbitrated Loop Physical Address (ALPA) or to all ALPAs on the arbitrated loop. [alpa] can be a specific ALPA or the keyword ALL to choose all ALPAs.

clear

Clears the counters on the specified port.

enable [alpa]

Sends a Loop Port Enable (LPE) to all ALPAs on the arbitrated loop. [alpa] can be a specific ALPA or the keyword ALL to choose all ALPAs.

speed [transmission_speed]

Specifies the transmission speed for the specified port. Use one of the following port speed values:

1Gbps

One gigabit per second.

2Gbps

Two gigabits per second.

Auto

The port speed is automatically detected.

state [state]

Specifies the administrative state for the specified port. Use one of the following port state values:

Online

Places the port online.

Offline

Places the port offline.

Diagnostics

Prepares the port for testing.

Down
Disables the port.

Set Setup command

Changes SNMP and blade server configuration settings. The switch maintains one SNMP configuration and one configuration.

Authority

Admin

Syntax

set setup

snmp

system

Keywords

snmp

Prompts you, line-by-line, to change SNMP configuration settings. Table 11 describes the SNMP fields. For each parameter, enter a new value or press the Enter key to accept the current value shown in brackets.

Table 11. SNMP configuration settings

Entry	Description
Contact	Specifies the name of the person to be contacted to respond to trap events. The default is Undefined.
Location	Specifies the name of the switch location. The default is Undefined.
Trap [1-5] Address	Specifies the IP address to which SNMP traps are sent.
Trap [1-5] Port	Specifies the port for which SNMP traps are sent.
Trap [1-5] Severity	Specifies the severity level to use when monitoring trap events. The default is Warning.
Trap [1-5] Enabled	Specifies whether traps (event information) are enabled or disabled (default).
ReadCommunity	Read Community Authentication. A write-only field; the value on the switch and the SNMP management server must be the same.
WriteCommunity	Write Community Authentication. A write-only field; the value on the switch and the SNMP management server must be the same.
TrapCommunity	Trap Community Authentication. A write-only field; the value on the switch and the SNMP management server must be the same.
AuthFailureTrap	Specifies the IP address where a notification is sent in the event of an authentication failure.

system

Prompts you, line-by-line, to change blade server configuration settings.

Table 12 describes the system configuration fields. For each parameter, enter a new value or press the Enter key to accept the current value shown in brackets.

Table 12. System configuration settings

Entry	Description
Eth0NetworkAddress	Ethernet Internet protocol (IP) address
Eth0NetworkMask	Ethernet subnet mask address for the Ethernet port.

Table 12. System configuration settings (continued)

Entry	Description
Eth0GatewayIPAddress	Ethernet IP address gateway
Eth0NetworkDiscovery	Ethernet boot method (1 - Static). Note: BootP, DHCP, and RARP do not apply
AdminTimeout	Specifies the amount of time in minutes the switch waits before terminating an idle Admin session. Zero (0) disables the time out threshold. The default is 30; the maximum is 1440.
Security Enabled	Enables or disables the enforcement of account names and passwords.
Remote Log Enabled	Whether remote logging is enabled or disabled. If enabled, log information is saved to a remote host that supports the syslog protocol.
RemoteLogHost IP Address	The IP address of the host that will receive the remote log information if remote logging is enabled.

Notes

The two components of security are user authentication and fabric security. The user must be authenticated before gaining access to a switch. If an invalid account name/password combination is entered, that user can not access the switch, and thus cannot gain access to the fabric. If security is enabled (True) and a valid account name/password combination is entered, that user can access the switch but can not execute any command that exceeds their authority (privileges) level. If security is disabled (False) and a valid account name/password combination is entered, that user has access to all switches in the fabric and can execute all commands (both user and admin), regardless of their authority (privileges) level.

Examples

The following is an example of the Set Setup SNMP command.

```
FCSM: user1> admin start
```

```
FCSM (admin) : user1> set setup snmp
```

```
A list of attributes with formatting and current values will follow.
Enter a new value or simply press the ENTER key to accept the current value.
If you wish to terminate this process before reaching the end of the list
press 'q' or 'Q' and the ENTER key to do so.
```

```
Trap Severity Options
```

```
-----
```

```
unknown, emergency, alert, critical, error, warning, notify, info, debug, mark
```

```
Contact          (string, max=32 chars)      [<sysContact undefined> ]
Location         (string, max=32 chars)      [<sysLocation undefined>]
Trap1Address     (dot-notated IP Address)    [10.0.0.1                ]
Trap1Port        (decimal value)            [162                      ]
Trap1Severity    (see allowed options above) [warning                  ]
Trap1Enabled     (True / False)              [False                    ]
Trap2Address     (dot-notated IP Address)    [0.0.0.0                  ]
Trap2Port        (decimal value)            [162                      ]
Trap2Severity    (see allowed options above) [warning                  ]
Trap2Enabled     (True / False)              [False                    ]
Trap3Address     (dot-notated IP Address)    [0.0.0.0                  ]
Trap3Port        (decimal value)            [162                      ]
Trap3Severity    (see allowed options above) [warning                  ]
Trap3Enabled     (True / False)              [False                    ]
Trap4Address     (dot-notated IP Address)    [0.0.0.0                  ]
Trap4Port        (decimal value)            [162                      ]
Trap4Severity    (see allowed options above) [warning                  ]
Trap4Enabled     (True / False)              [False                    ]
```

```

Trap5Address      (dot-notated IP Address)    [0.0.0.0      ]
Trap5Port         (decimal value)                [162         ]
Trap5Severity     (see allowed options above) [warning     ]
Trap5Enabled      (True / False)                  [False       ]
ReadCommunity     (string, max=32 chars)         [public      ]
WriteCommunity    (string, max=32 chars) [private     ]
TrapCommunity     (string, max=32 chars) [public      ]
AuthFailureTrap   (True / False)                  [False       ]

```

Do you want to save and activate this snmp setup? (y/n): [n]

The following is an example of the Set Setup System command.

```

FCSM: user1> admin start
FCSM (admin) : user1> set setup system

```

A list of attributes with formatting and current values will follow.
Enter a new value or simply press the ENTER key to accept the current value.
If you wish to terminate this process before reaching the end of the list
press 'q' or 'Q' and the ENTER key to do so.

```

Eth0NetworkAddress (dot-notated IP Address)    [10.90.10.93 ]
Eth0NetworkMask    (dot-notated IP Address)    [255.255.252.0]
Eth0GatewayAddress (dot-notated IP Address)    [10.20.8.254 ]
Eth0NetworkDiscovery (1=Static, 2=Bootp, 3=Dhcp, 4=Rarp) [Static      ]
AdminTimeout       (dec value 0-1440 minutes, 0=never) [30          ]
SecurityEnabled     (True / False)                [False       ]
LocalLogEnabled     (True / False)                [True        ]
RemoteLogEnabled    (True / False)                [False       ]
RemoteLogHostAddress (dot-notated IP Address)    [10.0.0.254  ]

```

Do you want to save and activate this system setup? (y/n): [n]

Show command

Displays fabric, switch, and port operational information.

Authority

User

Syntax

show

- about
- alarm
- broadcast
- chassis
- config [option]
- domains
- donor
- fabric
- interface
- log [option]
- lsdb
- mem [count]
- ns [option]
- pagebreak
- perf [option]
- port [port_number]
- post log
- setup [option]
- steering [domain_id]
- support
- switch
- topology
- users
- version

Keywords

about

Displays an introductory set of information about operational attributes of the switch. This keyword is equivalent to the Version keyword.

alarm

Displays the last 200 alarm entries.

broadcast

Displays the broadcast tree information and all ports that are currently transmitting and receiving broadcast frames.

chassis

Not applicable

config [option]

Displays switch and port configuration attributes. For more information, see the “Show Config command” on page 48.

domains

Displays a list of each domain and its worldwide name in the fabric.

donor

Displays list of current donor configuration for all ports.

fabric

Displays list of each domain, fabric ID, worldwide name, node IP address, port IP address, and symbolic name in the fabric.

interface

Displays the status of the active network interfaces.

log [option]

Displays log entries. See the “Show Log command” on page 50.

lsdb

Displays Link State database information.

mem [count]

Displays information about memory activity for the number of seconds given by [count]. If you omit [count], the value 1 is used. Displayed memory values are in units of 1 KB.

Note: This keyword will display memory activity updates until [count] is reached; it cannot be interrupted. Therefore, avoid using large values for [count].

ns [option]

Displays name server information for the specified [option]. If you omit [option], name server information for the local domain ID is displayed. [option] can have the following values:

all Displays name server information for all switches and ports.

[domain_id]

Displays name server information for the switch given by [domain_id].
[domain_id] is a switch domain ID.

[port_id]

Displays name server information for the port given by [port_id]. [port_id] is a port Fibre Channel address.

pagebreak

Displays the current pagebreak setting. The pagebreak setting limits the display of information to 20 lines (On) or allows the continuous display of information without a break (Off).

perf [option]

Displays performance information for all ports. See the “Show Perf command” on page 52.

port [port_number]

Displays operational information for the port given by [port_number]. Ports are numbered beginning with 0. If the port number is omitted, information is displayed for all ports. Table 13 on page 43 describes the port parameters. For information about port numbering and mapping, see Table 37 on page 131.

Note: For external ports (0,15), all parameters apply. For internal ports (1 through 14) only AdminState applies.

Table 13. Show Port parameters

Entry	Description
Alinit	Incremented each time the port begins AL initialization.
AlinitError	Number of times the port entered initialization and the initialization failed.
ClassXFramesIn	Number of class x frames received by this port.
ClassXFramesOut	Number of class x frames sent by this port.
ClassXWordsIn	Number of class x words received by this port.
ClassXWordsOut	Number of class x words sent by this port.
DecodeError	Decoding error detected.
EpConnects	Number of times an E_Port connects through ISL negotiation.
FBusy	Number of times the switch sent a F_BSY because Class 2 frame could not be delivered within ED_TOV time. Number of class 2 and class 3 fabric busy (F_BSY) frames generated by this port in response to incoming frames. This usually indicates a busy condition on the fabric or N_port that is preventing delivery of this frame.
Flowerrors	Received a frame when there were no available credits.
FReject	Number of frames from devices that were rejected.
InvalidCRC	Invalid CRC detected.
InvalidDestAddr	Invalid destination address detected.
LIP ALPD ALPS	Number of F7, AL_PS LIPs, or AL_PD (vendor specific) resets, performed.
LIPF7ALPS	This LIP is used to reinitialize the loop. An L_port, identified by AL_PS, may have noticed a performance degradation and is trying to restore the loop.
LIPF8ALPS	This LIP denotes a loop failure detected by the L_port identified by AL_PS.
LIPF7F7	A loop initialization primitive frame used to acquire a valid AL_PA.
LIPF8F7	A loop initialization primitive frame used to indicate that a loop failure has been detected at the receiver.
Link Failures	Number of optical link failures detected by this port. A link failure is a loss of synchronization for a period of time greater than the value of R_T_TOV or by loss of signal while not in the offline state. A loss of signal causes the switch to attempt to re-establish the link. If the link is not re-established by the time specified by R_T_TOV, a link failure is counted. A link reset is performed after a link failure.
Login	Time when user logged in.
Logout	Time when user logged out.
LoopTimeouts	A 2-second timeout as specified by FC-AL-2.
LossOfSync	Number of synchronization losses (>100 ms) detected by this port. A loss of synchronization is detected by receipt of an invalid transmission word.
PrimSeqErrors	Primitive sequence errors detected.
RxLinkResets	Number of link reset primitives received from an attached device.

Table 13. Show Port parameters (continued)

Entry	Description
RxOfflineSeq	Number of offline sequences received. An OLS is issued for link initialization, a Receive & Recognize Not_Operational (NOS) state, or to enter the offline state.
TotalErrors	Total number of errors detected.
TotalLIPsRecvd	Number of loop initialization primitive frames received by this port.
TotalLinkResets	Total number of link reset primitives.
TotalOfflineSeq	Total number of Offline Sequences issued by this port.
TotalRxFrames	Total number of frames received by this port.
TotalRxWords	Total number of words received by this port.
TotalTxFrames	Total number of frames issued by this port.
TotalTxWords	Total number of words issued by this port.
TxLinkResets	Number of Link Resets issued by this port.
TxOfflineSeq	Total number of Offline Sequences issued by this port.
TxWait	Time waiting to transmit when blocked with no credit. Measured in FC Word times.

post log

Displays the POST log which contains results from the POST.

setup [option]

Displays setup attributes for the system, SNMP, and the switch manufacturer. See the “Show Setup command” on page 54.

steering [domain_id]

Displays the routes that data takes to the switch given by [domain_id]. If you omit [domain_id], the system displays routes for all switches in the fabric.

support

Executes a series of commands that display a complete description of the switch, its configuration, and operation. The display can be captured from the screen and used for diagnosing problems. This keyword is intended for use at the request of your authorized maintenance provider. The following commands are executed:

- Date
- Alias List
- Config List
- Date
- History
- Ps
- Show (About, Alarm, Backtrace, Chassis, Config Port, Config Switch, Dev, Dev Settings, Domains, Donor, Fabric, Log, Log Settings, Lsdb, Mem, Ns, Perf, Port, Setup Mfg, Setup Snmp, Setup System, Steering, Switch, Topology, Users)
- Uptime
- User Accounts
- Whoami
- Zoneset (Active, List)

- Zoning (History, Limits, List)

switch

Displays switch operational information.

topology

Displays all connected devices.

users

Displays a list of logged-in users. This is equivalent to the User List command.

version

Displays an introductory set of information about operational attributes of the switch. This keyword is equivalent to the About keyword.

Examples

The following is an example of the Show Setup SNMP command.

FCSM: user1> show setup snmp

```
SNMP Information
-----
Contact          <sysContact undefined>
Location         <sysLocation undefined>
Description      IBM BladeCenter(TM) 2-port Fibre Channel Switch Module
Trap1Address     10.0.0.1
Trap1Port        162
Trap1Severity    warning
Trap1Enabled     False
Trap2Address     0.0.0.0
Trap2Port        162
Trap2Severity    warning
Trap2Enabled     False
Trap3Address     0.0.0.0
Trap3Port        162
Trap3Severity    warning
Trap3Enabled     False
Trap4Address     0.0.0.0
Trap4Port        162
Trap4Severity    warning
Trap4Enabled     False
Trap5Address     0.0.0.0
Trap5Port        162
Trap5Severity    warning
Trap5Enabled     False
ObjectID         1.3.6.1.4.1.1663.1.1.1.1.16
AuthFailureTrap False
```

The following is an example of the Show Topology command.

FCSM: user1> show topology

Unique ID Key

```
-----
A = ALPA, D = Domain ID, P = Port ID
```

Loc	Local		Rem	Remote	Unique
Port	Type	PortWWN	Type	NodeWWN	ID
----	----	-----	----	-----	-----
Ext:15	E	20:0f:00:c0:dd:00:90:fb	E	10:00:00:c0:dd:00:90:d74	(0x4) D

The following is an example of the Show Topology (for Port #15) command.

FCSM: user1> show topology 15

Local Link Information

```
-----
Port      Ext2:15
PortID    020f00
```

```
PortWWN    20:0f:00:c0:dd:00:90:fb
PortType   E
```

Remote Link Information

Remote Switch

```
PortNumber 10
DomainID   04
NodeWWN    10:00:00:c0:dd:00:90:d7
PortType   E
Description Switch
IPAddress  10.0.0.3
```

The following is an example of the Show Port command.

```
FCSM: user1> show port 0
Port Number: 0
-----
AdminState      Online          PortID          640000
AsicNumber      0              PortWWN         20:00:00:c0:dd:00:91:03
AsicPort        0              RunningType     E
ConfigType      GL             SFPPartNumber   FTRJ-8519-3-2.5
DiagStatus      Passed         SFPRevision     X1
EpConnState     Connected     SFPTYPE         100-M5-SN-I
EpIsoReason     NotApplicable SFPVendor       FINISAR CORP.
LinkSpeed       2Gb/s        SFPVendorID     00659000
LinkState       Active        SymbolicName     Port0
LoginStatus     LoggedIn      SyncStatus      SyncAcquired
MaxCredit       12           XmitterEnabled  True
OperationalState Online
ALInit          11           FlowErrors      0              PrimSeqErrors   0
ALInitError     1            FReject         0              RxLinkResets    0
Class2FramesIn  0            InvalidCRC      0              RxOfflineSeq    0
Class2FramesOut 0            InvalidDestAddr 0              TotalErrors     1
Class2WordsIn   0            LIP_AL_PD_AL_PS 0              TotalLIPsRecvd 15
Class2WordsOut  0            LIP_F7_AL_PS   0              TotalLinkResets 0
Class3FramesIn  0            LIP_F7_F7      15             TotalOfflineSeq 0
Class3FramesOut 0            LIP_F8_AL_PS   0              TotalRxFrames   0
Class3Toss      0            LIP_F8_F7      0              TotalRxWords    0
Class3WordsIn   0            LinkFailures    0              TotalTxFrames   0
Class3WordsOut  0            Login           7              TotalTxWords    0
DecodeErrors    0            Logout          6              TxLinkResets    0
EpConnects     7            LoopTimeouts    0              TxOfflineSeq    0
FBusy           0            LossOfSync      1              TxWaits         0
```

The following is an example of the Show Switch command.

```
FCSM: user1> show switch
Switch Information
-----
SymbolicName      Fibre Channel Switch Module
SwitchWWN         10:00:00:c0:dd:00:91:03
SwitchType        BladeCenter
PROMVersion       V1.4.0.1-0 (Thu Sep 12 17:46:41 2002)
CreditPool       0
DomainID          1 (0x1)
FirstPortAddress  010000
FlashSize - MBytes 128
LogLevel          Critical
MaxPorts          16
NumberOfResets    14
ReasonForLastReset NormalReset
SWImageVersion (1) - build date V1.4.0.18-3 (Thu Sep 19 03:55:16 2002)
SWImageVersion (2) - build date V1.4.0.19-1 (Fri Sep 20 03:56:20 2002)
ActiveConfiguration default
ActiveSWImage     2
```

AdminState	Online
AdminModeActive	False
BeaconOnStatus	False
OperationalState	Online
PrincipalSwitchRole	True
BoardTemp (1) - Degrees Celsius	50
BoardTemp (2) - Degrees Celsius	50
SwitchDiagnosticsStatus	Passed
SwitchTemperatureStatus	Normal

Show Config command

Display port, switch, alarm threshold, and zoning attributes for the current configuration.

Authority

User

Syntax

show config

port [*port_number*]

switch

threshold

zoning

Keywords

port [*port_number*]

Displays configuration parameters for the port number given by [*port_number*]. Ports are numbered beginning with 0. If the port value is omitted, all ports are specified.

Note: For external ports (0,15), all parameters apply. For internal ports (1 through 14) only AdminState applies. For information about port numbering and mapping, see Table 37 on page 131.

switch

Displays configuration parameters for the switch.

threshold

Displays alarm threshold parameters for the switch.

zoning

Displays zoning configuration parameters for the switch.

Examples

The following is an example of the Show Config Port command.

```
FCSM: user1> show config port 15
Configuration Name: lei
-----
Port Number: 15
-----
AdminState      Online
LinkSpeed       Auto
PortType        GL
TLPortMode      TLTargetMode
ISLSecurity     Any
SymbolicName    Port15
ALFairness      False
ARB_FF          False
InteropCredit   0
ExtCredit        0
FANEnable       True
LCFEnable       False
MFSEnable       True
MFS_TOV         10
MSEnable        True
NoClose         False
IOStreamGuard   Disabled
VIEnable        False
CheckAlps       False
```

The following is an example of the Show Config Switch command.

```
FCSM: user1> show config switch
Configuration Name: lei
-----
Switch Configuration Information
-----
AdminState           Online
BroadcastEnabled     True
InbandEnabled        True
DomainID              1 (0x1)
DomainIDLock         False
SymbolicName         Fibre Channel Switch Module
R_T_TOV              100
R_A_TOV              10000
E_D_TOV              2000
FS_TOV               5000
DS_TOV               5000
PrincipalPriority     254
ConfigDescription    IBM BladeCenter(TM) 2-port Fibre Channel Switch Module
ConfigLastSavedBy    Initial
ConfigLastSavedOn    Initial
```

The following is an example of the Show Config Threshold command.

```
FCSM: user1> show config threshold
Configuration Name: default
-----
Threshold Configuration Information
-----
ThresholdMonitoringEnabled      True
CRCErrorsMonitoringEnabled     True
  RisingTrigger                 25
  FallingTrigger                1
  SampleWindow                  10
DecodeErrorsMonitoringEnabled  True
  RisingTrigger                 200
  FallingTrigger                0
  SampleWindow                  10
ISLMonitoringEnabled           True
  RisingTrigger                 2
  FallingTrigger                0
  SampleWindow                  10
LoginMonitoringEnabled         True
  RisingTrigger                 5
  FallingTrigger                1
  SampleWindow                  10
LogoutMonitoringEnabled        True
  RisingTrigger                 5
  FallingTrigger                1
  SampleWindow                  10
LOSMonitoringEnabled           True
  RisingTrigger                 100
  FallingTrigger                5
  SampleWindow                  10
```

The following is an example of the Show Config Zoning command.

```
FCSM: user1> show config zoning
Configuration Name: default
-----
Zoning Configuration Information
-----
AutoSave              True
Default              All
```

Show Log command

Displays the contents of the log or the parameters used to create entries in the log. The log contains a maximum of 200 entries. When the log reaches its entry capacity, subsequent entries overwrite the existing entries, beginning with the oldest.

Authority

User

Syntax

show log

component

level

options

port

settings

Keywords

component

Displays the components currently being monitored for events.

level

Displays the event severity level needed to create an entry in the log. If the severity level occurs on a port or on a component which is not defined, no entry is made in the log.

options

Displays the options used to set the component and log level attributes.

port

Displays the ports being monitored for events. If an event occurs which is of the defined level and on a defined component, but not on a defined port, no entry is made in the log.

settings

Displays the current settings for component, level and port. This command is equivalent to executing the following commands separately: Show Log Component, Show Log Level, and Show Log Port.

Examples

The following is an example of the Show Log Component command.

```
FCSM: user1> show log component
Current setting(s) for log component: NameServer
```

The following is an example of the Show Log Level command.

```
FCSM: user1> show log level
Current settings for log
-----
level      Critical
```

The following is an example of the Show Log Options command.

```
FCSM: user1> show log options

Allowed options for 'level': Critical,Warn,Info,None

Allowed options for 'component': All,None,NameServer,MgmtServer,Zoning,Switch,
```

Chassis,Blade,Port,Eport,Snmp,Other

Current setting(s) for log port: 0 1 2 3 4 5 6 7 8 9 10 11 12 13 14 15

The following is an example of the Show Log command.

```
[327][Wed Jan 25 09:36:54.860 1989][I][Eport:0xdd00b8b6.304.4 Port: 0/8][Eport
State = E_A0_GET_DOMAIN_ID]
[328][Wed Jan 25 09:36:54.860 1989][I][Eport:0xdd00b8b6.304.4 Port: 0/8][FSPF
PortUp state=0]
[329][Wed Jan 25 09:36:54.861 1989][I][Eport:0xdd00b8b6.304.4 Port: 0/8][Send
ing init hello]
[330][Wed Jan 25 09:36:54.861 1989][I][Eport:0xdd00b8b6.304.4 Port: 0/8][Proc
essing EFP, oxid= 0x8]
[331][Wed Jan 25 09:36:54.861 1989][I][Eport:0xdd00b8b6.304.4 Port: 0/8][Epor
t State = E_A2_IDLE]
[332][Wed Jan 25 09:36:54.861 1989][I][Eport:0xdd00b8b6.304.4 Port: 0/8][EFP,
WWN= 0x100000c0dd00b845, len= 0x30]
[333][Wed Jan 25 09:36:54.864 1989][I][Eport:0xdd00b8b6.304.4 Port: 0/8][Send
ing LSU oxid= 0xc: type= 1]
[334][Wed Jan 25 09:36:54.864 1989][I][Eport:0xdd00b8b6.304.4 Port: 0/8][Send
Zone Merge Request]
[335][Wed Jan 25 09:36:54.865 1989][I][Eport:0xdd00b8b6.304.4 Port: 0/8][LSDB
Xchg timer set]
[336][Wed Jan 25 09:36:54.865 1989][I][Eport:0xdd00b8b6.304.4 Port: 0/8][Sett
ing attribute Oper.UserPort.0.8.EpConnState Connected]
```

Show Perf command

Displays port performance in frames per second and bytes per second. If you omit the keyword, the command displays data transmitted (out), data received (in), and total data transmitted and received in frames per second and bytes per second.

Authority

User

Syntax

show perf

byte
inbyte
outbyte
frame
inframe
outframe
errors

Keywords

byte

Displays continuous performance data in total bytes per second transmitted and received for all ports. Type q and press the Enter key to stop the display.

inbyte

Displays continuous performance data in bytes per second received for all ports. Type q and press the Enter key to stop the display.

outbyte [port_number]

Displays continuous performance data in bytes per second transmitted for all ports. Type q and press the Enter key to stop the display.

frame [port_number]

Displays continuous performance data in total frames per second transmitted and received for all ports. Type q and press the Enter key to stop the display.

inframe [port_number]

Displays continuous performance data in frames per second received for all ports. Type q and press the Enter key to stop the display.

outframe [port_number]

Displays continuous performance data in frames per second transmitted for all ports. Type q and press the Enter key to stop the display.

errors [port_number]

Displays continuous error counts for all ports. Type q and press the Enter key to stop the display.

Examples

The following is an example of the Show Perf command.

```
FCSM: user1>: show perf
```

Port	Bytes/s (in)	Bytes/s (out)	Bytes/s (total)	Frames/s (in)	Frames/s (out)	Frames/s (total)
Ext1:0	0	0	0	0	0	0
Ext2:15	0	0	0	0	0	0
Bay1	0	0	0	0	0	0

Bay2	0	0	0	0	0	0
Bay3	0	0	0	0	0	0
Bay4	0	0	0	0	0	0
Bay5	0	0	0	0	0	0
Bay6	0	0	0	0	0	0
Bay7	0	0	0	0	0	0
Bay8	0	0	0	0	0	0
Bay9	0	0	0	0	0	0
Bay10	0	0	0	0	0	0
Bay11	0	0	0	0	0	0
Bay12	0	0	0	0	0	0
Bay13	0	0	0	0	0	0
Bay14	0	0	0	0	0	0

Show Setup command

Displays the current SNMP and system settings.

Authority

User

Syntax

show setup

mfg

snmp

system

Keywords

mfg

Displays manufacturing information about the switch.

snmp

Displays the current SNMP settings.

system

Displays the current system settings.

Examples

The following is an example of the Show Setup Mfg command.

```
FCSM: user1> show setup mfg
Manufacturing Information
-----
BoardSerialNumber    P9
BrandName            IBM
BuildDate            Unknown
ChassisPartNumber    Unknown
ChassisSerialNumber  P9
MACAddress            00:c0:dd:00:91:02
PlanarPartNumber      Unknown
SwitchSymbolicName   Fibre Channel Switch Module
SwitchWWN             10:00:00:c0:dd:00:91:03
SystemDescription     IBM BladeCenter(TM) 2-port Fibre Channel Switch Module
SystemObjectID        1.3.6.1.4.1.1663.1.1.1.1.16
```

The following is an example of the Show Setup Snmp command.

```
FCSM: user1> show setup snmp
SNMP Information
-----
Contact              <sysContact undefined>
Location              <sysLocation undefined>
Description           IBM BladeCenter(TM) 2-port Fibre Channel Switch Module
Trap1Address          10.0.0.254
Trap1Port             162
Trap1Severity         warning
Trap1Enabled          False
Trap2Address          0.0.0.0
Trap2Port             162
Trap2Severity         warning
Trap2Enabled          False
Trap3Address          0.0.0.0
Trap3Port             162
Trap3Severity         warning
Trap3Enabled          False
Trap4Address          0.0.0.0
Trap4Port             162
Trap4Severity         warning
```

```
Trap4Enabled      False
Trap5Address      0.0.0.0
Trap5Port         162
Trap5Severity     warning
Trap5Enabled      False
ObjectID          1.3.6.1.4.1.1663.1.1.1.1.16
AuthFailureTrap   False
```

The following is an example of the Show Setup System command.

```
FCSM: user1> show setup system
System Information
-----
Eth0NetworkAddress 10.20.8.188
Eth0NetworkMask    255.255.252.0
Eth0GatewayAddress 10.20.8.254
Eth0NetworkDiscovery Static
AdminTimeout       30
SecurityEnabled    False
LocalLogEnabled    True
RemoteLogEnabled   False
RemoteLogHostAddress 10.0.0.254
```

Shutdown command

Terminates all data transfers on the switch at convenient points and closes the Telnet session. Always power cycle the switch after entering this command.

Authority

Admin

Syntax

shutdown

Notes

Always use this command to effect an orderly shutdown before removing power from the switch. Failure to do so could damage the flash memory and the switch configuration.

Test command

Tests switch module ports using internal (SerDes level), external small form-factor pluggable (SFP), and online loopback tests. Internal and external tests require that the switch module port be placed in diagnostic mode. See the “Set Port command” on page 36 for information about changing the port administrative state. While the test is running, the remaining ports on the switch remain fully operational. See “Port testing” on page 122 for more information.

Authority

Admin

Syntax

test

```
port [port_number] [test_type]
cancel
status
```

Keywords

port [port_number] [test_type]

Tests the port given by [port_number] using the test given by [test_type]. If you omit [test_type], Internal is used. [test_type] can have the following values:

Internal (for internal and external ports)

Tests the SerDes. This is the default. The port must be in diagnostics mode to perform this test.

External (for external ports only)

Tests both the SerDes and SFP. The port must be in diagnostics mode to perform this test, and a loopback plug must be installed in the SFP.

Online (for internal and external ports)

Tests one online port.

cancel

Cancels the online test in progress.

status

Displays the status of a test in progress, or if there is no test in progress, the status of the test that was executed last.

Examples

To run Internal (SerDes) or External (SFP) port tests, complete the following steps:

1. To start an admin session, type the following command:

```
admin start
```

2. Place the port in Diagnostics mode by typing the following command (*x* = port number):

```
set port x state diagnostics
```

3. Insert the loopback plug into the SFP on the selected port (for external port test only).

4. Choose one of the two types of port loopback tests to run:

- To run an internal loopback test, type the following command:

```
test x internal
```

- To run an external loopback test, type the following command. A loopback plug must be installed for this test to pass.

```
test x external
```

Note: The external loopback test can be performed only on external switch module ports.

After the test type has been chosen and the command executed, a message on the screen will appear detailing the test results.

5. After the test is run, put the port back into online state by typing the following command (x = port number):

```
set port x state online
```

6. To verify the port is back online, type the following command. The contents of the **AdminState** field should be `Online`.

```
show port x
```

The online node-to-node test can test only one port at a time, and that port must be online and connected to an external device or a blade server Fibre Channel expansion card. To run the online node-to-node test, complete the following steps:

1. To start an admin session, type the following command:

```
admin start
```

2. To run the online node-to-node test, type the following command:

```
test x online
```

A series of test parameters are displayed on the screen.

3. Press the Enter key to accept each default parameter value, or type a new value for each parameter and press the Enter key. The `TestLength` parameter is the number of frames sent, the `FrameSize` (256 byte maximum in some cases) parameter is the number of bytes in each frame, and the `DataPattern` parameter is the pattern in the payload. Before running the test, make sure that the device attached to the port can handle the test parameters.

```
FCSM (admin) : user1> test x online
```

A list of attributes with formatting and current values will follow.

Enter a new value or simply press the ENTER key to accept the default value. If you wish to terminate this process before reaching the end of the list press 'q' or 'Q' and the ENTER key to do so.

```
TestLength  (decimal value, 1-4294967295)  [100  ]
FrameSize   (decimal value, 36-2148)        [256  ]
DataPattern (32-bit hex value or 'Default') [Default]
StopOnError (True/False)                        [False ]
```

```
Do you want to start the test? (y/n) [n]
```

4. After all parameter values are defined, press the Y key to start the test.

Uptime command

Displays the elapsed time since the switch was last reset and reset method.

Authority

User

Syntax

uptime

Examples

The following is an example of the Uptime command.

```
FCSM: user1> uptime
Elapsed up time : 0 day(s), 2 hour(s), 28 min(s), 44 sec(s)
Reason last reset: NormalReset
```

User command

Administers or displays user accounts.

Authority

Admin. The List keyword is available with User authority.

Syntax

user

```
accounts
add
delete [account_name]
list
```

Keywords

accounts

Displays all user accounts that exist on the switch.

add

Add a user account to the switch. After this command is executed, the administrator will be prompted for the information needed to establish the user account. A switch can have a maximum of 15 user accounts. Account names are limited to 15 characters; passwords are limited to 31 characters.

delete [account_name]

Deletes the account name given by [account_name] from the switch.

list

Displays the list of users currently logged in and their session numbers. Provides the same function as the Show Users command. This keyword is valid for User authority and does not require an admin session.

Examples

The following is an example of the User Accounts command.

```
FCSM (admin) : user1> user accounts
Current list of user accounts
-----
images      (admin authority = False)
admin       (admin authority = True)
USERID      (admin authority = True)
```

The following is an example of the User Add command.

```
FCSM (admin) : user1> user add
Press 'q' and the ENTER key to abort this command.

account name (1-15 chars)      : user3
account password (4-20 chars) :

please confirm account password:
should this account have admin authority? (y/n) [n] : y
OK to add user account 'user3' with admin authority?
Please confirm (y/n): [n] y
```

The following is an example of the User Delete command.

```
FCSM (admin) : user1> user del user3
The user account will be deleted. Please confirm (y/n): [n] y
```

The following is an example of the User List command.

```
FCSM (admin) : user1> user list
Current list of users logged in
-----
admin@OB-session1 - in admin mode
admin@OB-session2
user1@OB-session3
```

Whoami command

CommandDisplays the account name, session number, and switch domain ID for the Telnet session.

Authority

User

Syntax

whoami

Examples

The following is an example of the Whoami command.

```
FCSM: user1> whoami
User name      : admin@0B-session3
Switch name    : Fibre Channel Switch Module
Switch domain ID: 100 (0x64)
```

Zone command

Manages zones and zone membership on a switch. The Zone command defines members (ports and devices) for a single switch. Zones are members of zone sets.

Authority

Admin authority and a Zoning Edit session. See the “Zoning command” on page 68 for information about starting a Zoning Edit session. The List, Members, and Zonesets keywords are available with User authority and do not require a Zoning Edit session.

Syntax

zone

```
add [zone] [members]
copy [zone_source] [zone_destination]
create [zone]
delete [zone]
list
members [zone]
remove [zone] [members]
rename [zone_old] [zone_new]
type [zone] [zone_type]
zonesets [zone]
```

Keywords

add [zone] [members]

Specifies one or more ports given by [members] to add to the zone named [zone]. A zone can have a maximum of 256 members. [members] can have one of the following formats:

- Domain ID and port number pair (domain ID, port number). Domain IDs and port numbers are in decimal format. Ports are numbered beginning with 0.
- 6-character hexadecimal device Fibre Channel address (hex)
- 16-character hexadecimal port worldwide name (PWWN) with the format xx:xx:xx:xx:xx:xx:xx:xx.
- Alias name

The application verifies that the [zone] format is correct, but does not validate that such a port exists.

copy [zone_source] [zone_destination]

Creates a new zone named [zone_destination] and copies the membership into it from the zone given by [zone_source].

create [zone]

Creates a zone with the name given by [zone]. An zone name must begin with a letter and be no longer than 64 characters. Valid characters are 0-9, A-Z, a-z, &, _, and -. The zoning database supports a maximum of 256 zones.

delete [zone]

Deletes the specified zone given by [zone] from the zoning database. If the zone is a member of the active zone set, the zone will not be removed from the active zone set until the active zone set is deactivated.

list

Displays a list of all zones and the zone sets of which they are members. This keyword is valid for User authority and does not require a zoning edit session.

members [zone]

Displays all members of the zone given by [zone]. This keyword is available with User authority and does not require a Zoning Edit session.

remove [zone] [members]

Removes the ports given by [members] from the zone given by [zone]. [members] can have one of the following formats:

- Domain ID and port number pair (Domain ID, Port Number). Domain IDs and port numbers are in decimal. Ports are numbered beginning with 0.
- 6-character hexadecimal device Fibre Channel address (hex)
- 16-character hexadecimal port worldwide name (PWWN) with the format xx:xx:xx:xx:xx:xx:xx:xx.
- Alias name

rename [zone_old] [zone_new]

Renames the zone given by [zone_old] to the zone given by [zone_new].

type [zone] [zone_type]

Specifies the zone type given by [zone_type] to be assigned to the zone name given by [zone]. If you omit the [zone_type], the system displays the zone type for the zone given by [zone]. [zone_type] can be one of the following:

```
soft
    Name server zone

hardacl
    Access control list hard zone

hardvpf
    Virtual private fabric hard zone
```

zonesets [zone]

Displays all zone sets of which the zone given by [zone] is a member. This keyword is available with User authority and does not require a Zoning Edit session.

Examples

The following is an example of the Zone List command.

```
FCSM: user1> zone list
```

```
Zone      ZoneSet
-----
wnn_b0241f
           zone_set_1

wnn_23bd31
           zone_set_1

wnn_221416
           zone_set_1

wnn_2215c3
           zone_set_1

wnn_0160ed
           zone_set_1

wnn_c001b0
           zone_set_1

wnn_401248
           zone_set_1
```



```
wnn_02402f      zone_set_1
wnn_22412f      zone_set_1
```

The following is an example of the Zone Members command.

```
FCSM: user1> zone members wnn_b0241f
```

```
Current List of Members for Zone: wnn_b0241f
-----
50:06:04:82:bf:d2:18:c2
50:06:04:82:bf:d2:18:d2
21:00:00:e0:8b:02:41:2f
```

The following is an example of the Zone Zonesets command.

```
FCSM: user1> zone zonesets zone1
```

```
Current List of ZoneSets for Zone: wnn_b0241f
-----
zone_set_1
```

Zoneset command

Manages zone sets and zone set membership across the fabric.

Authority

Admin authority and a Zoning Edit session. See the “Zoning command” on page 68 for information about starting a Zoning Edit session. The Active, List, Zones keywords are available with User authority. You must close the Zoning Edit session before using the Activate and Deactivate keywords.

Syntax

zoneset

```
activate [zone_set]
active
add [zone_set] [zone_list]
copy [zone_set_source] [zone_set_destination]
create [zone_set]
deactivate
delete [zone_set]
list
remove [zone_set] [zone_list]
rename [zone_set_old] [zone_set_new]
zones [zone_set]
```

Keywords

activate [zone_set]

Activates the zone set given by [zone_set]. This keyword deactivates the active zone set. Close the Zoning Edit session before using this keyword.

active

Displays the name of the active zone set. This keyword is available with User authority and does not require a Zoning Edit session.

add [zone_set] [zone_list]

Adds a list of zones and aliases given by [zone_list] to the zone set given by [zone_set]. Zone and alias names are delimited by spaces in [zone_list]. This keyword requires a Zoning Edit session.

copy [zone_set_source] [zone_set_destination]

Creates a new zone set named [zone_set_destination] and copies into it the membership from the zone set given by [zone_set_source]. This keyword requires a Zoning Edit session.

create [zone_set]

Creates the zone set with the name given by [zone_set]. A zone set name must begin with a letter and be no longer than 64 characters. Valid characters are 0-9, A-Z, a-z, &, _, and -. This keyword requires a Zoning Edit session. The zoning database supports a maximum of 256 zone sets.

deactivate

Deactivates the active zone set. Close the Zoning Edit session before using this keyword.

delete [zone_set]

Deletes the zone set given by [zone_set]. If the specified zone set is active, the command is suspended until the zone set is deactivated. This keyword requires a Zoning Edit session.

list

Displays a list of all zone sets. This keyword is available with User authority and does not require a Zoning Edit session.

remove [zone_set] [zone_list]

Removes a list of zones and aliases given by [zone_list] from the zone set given by [zone_set]. Zone and alias names are delimited by spaces in [zone_list]. If [zone_set] is the active zone set, the zone will not be removed until the zone set has been deactivated. This keyword requires a Zoning Edit session.

rename [zone_set_old] [zone_set_new]

Renames the zone set given by [zone_set_old] to the name given by [zone_set_new]. You can rename the active zone set. This keyword requires a Zoning Edit session.

zones [zone_set]

Displays all zones that are members of the zone set given by [zone_set]. This keyword is available with User authority and does not need a Zoning Edit session.

Notes

- A zone set must be active for its definitions to be applied to the fabric.
- Only one zone set can be active at one time.
- A zone can be a member of more than one zone set.

Examples

The following is an example of the Zoneset Active command.

```
FCSM: user1> zoneset active
```

```
The active ZoneSet is: Beta
```

The following is an example of the Zoneset List command.

```
FCSM: user1> zoneset list
```

```
Current List of ZoneSets
-----
alpha
beta
```

The following is an example of the Zoneset Zones command.

```
FCSM: user1> zoneset zones ssss
```

```
Current List of Zones for ZoneSet: ssss
-----
zone1
zone2
zone3
```

Zoning command

Opens a Zoning Edit session in which to create and manage zone sets and zones. See the “Zone command” on page 63” and the “Zoneset command” on page 66” for information about managing zone and zone sets.

Authority

Admin. The List keyword is available with User authority.

Syntax

zoning

active
cancel
clear
edit
history
limits
list
restore
save

Keywords

active

Displays membership information for the active zone set including member zones and zone members.

cancel

Closes the current Zoning Edit session. Any unsaved changes are lost.

clear

Clears all inactive zone sets from the volatile edit copy of the zoning database. This keyword does not affect the nonvolatile zoning database. However, if you enter the Zoning Clear command followed by the Zoning Save command, the nonvolatile zoning database will be cleared from the switch. The preferred method for clearing the zoning database from the switch is the Reset Zoning command.

edit

Opens a Zoning Edit session.

history

Displays a history of zoning modifications including the following:

- Time of the most recent zone set activation or deactivation and the user who performed it
- Time of the most recent modifications to the zoning database and the user who made them.
- Checksum for the zoning database.

limits

Displays the maximum limits imposed on the zoning database for the number of zone sets, zones, aliases, members per zone, members per alias, and total members.

list

Lists all fabric zoning definitions. This keyword is available with User authority.

restore

Reverts the changes to the zoning database that have been made during the current Zoning Edit session since the last Zoning Save command was entered.

save

Saves changes made during the current Zoning Edit session. The system will inform you that the zone set must be activated to implement any changes. This does not apply if you entered the Zoning Clear command during the Zoning Edit session.

Examples

The following is an example of the Zoning Edit command.

```
FCSM: user1> admin start

FCSM (admin) : user1> zoning edit

FCSM (admin-zoning) : user1>
.
.
FCSM (admin-zoning) : user1> zoning cancel

    Zoning edit mode will be canceled. Please confirm (y/n): [n]  y

FCSM (admin) : user1> admin end
```

The following is an example of the Zoning List command.

```
FCSM: user1> zoning list

Active ZoneSet Information

ZoneSet      Zone      ZoneMember
-----
wnn
    wnn_b0241f
        50:06:04:82:bf:d2:18:c2
        50:06:04:82:bf:d2:18:d2
        21:00:00:e0:8b:02:41:2f

    wnn_23bd31
        50:06:04:82:bf:d2:18:c2
        50:06:04:82:bf:d2:18:d2
        10:00:00:00:c9:23:bd:31

    wnn_221416
        50:06:04:82:bf:d2:18:c2
        50:06:04:82:bf:d2:18:d2
        10:00:00:00:c9:22:14:16

    wnn_2215c3
        50:06:04:82:bf:d2:18:c2
        50:06:04:82:bf:d2:18:d2
        10:00:00:00:c9:22:15:c3

Configured Zoning Information

ZoneSet      Zone      ZoneMember
-----
wnn
    wnn_b0241f
        50:06:04:82:bf:d2:18:c2
        50:06:04:82:bf:d2:18:d2
        21:00:00:e0:8b:02:41:2f

    wnn_23bd31
        50:06:04:82:bf:d2:18:c2
        50:06:04:82:bf:d2:18:d2
        10:00:00:00:c9:23:bd:31

    wnn_221416
```

50:06:04:82:bf:d2:18:c2
50:06:04:82:bf:d2:18:d2
10:00:00:00:c9:22:14:16

wnn_2215c3

50:06:04:82:bf:d2:18:c2
50:06:04:82:bf:d2:18:d2
10:00:00:00:c9:22:15:c3

Chapter 3. Using the SAN Utility

You can use the SAN Utility application to access and configure switch modules. For information about installing, uninstalling, and starting the SAN Utility application, see the *IBM eServer BladeCenter 2-Port Fibre Channel Switch Module Installation Guide*. The SAN Utility application can be installed on a BladeCenter blade server or an external network management workstation configured with one of the operating systems described in the *IBM eServer BladeCenter 2-Port Fibre Channel Switch Installation Guide*.

To manage your switch modules and fabrics, the SAN Utility application provides two basic windows: Topology and Faceplate. The SAN Utility user interface, its elements, and the tasks that you can perform from the Faceplate window and Topology window are described in this chapter.

Important: Before you configure your switch module, be sure that the management modules in your BladeCenter unit are properly configured. In addition, to access and manage your switch module from an external environment, you might need to enable certain features, such as the external ports and external management over all ports. See the applicable *BladeCenter Unit Installation and User's Guide* publications on the *IBM BladeCenter Documentation CD* for more information.

In addition to reviewing the publications in this library, be sure to review the *IBM BladeCenter Planning and Installation Guide* at <http://www.ibm.com/eserver/bladecenter/> on the World Wide Web for information to help you prepare for system installation and configuration.

SAN Utility user interface

The Topology window and Faceplate window share the following common elements:

- Menu bar
- Toolbar
- Fabric tree
- Graphic window
- Data window and tabs
- Working Status indicator

The Topology window displays all of the switch modules that are enabled and the connections between switch modules and other Fibre Channel devices, as shown in Figure 1 on page 72.

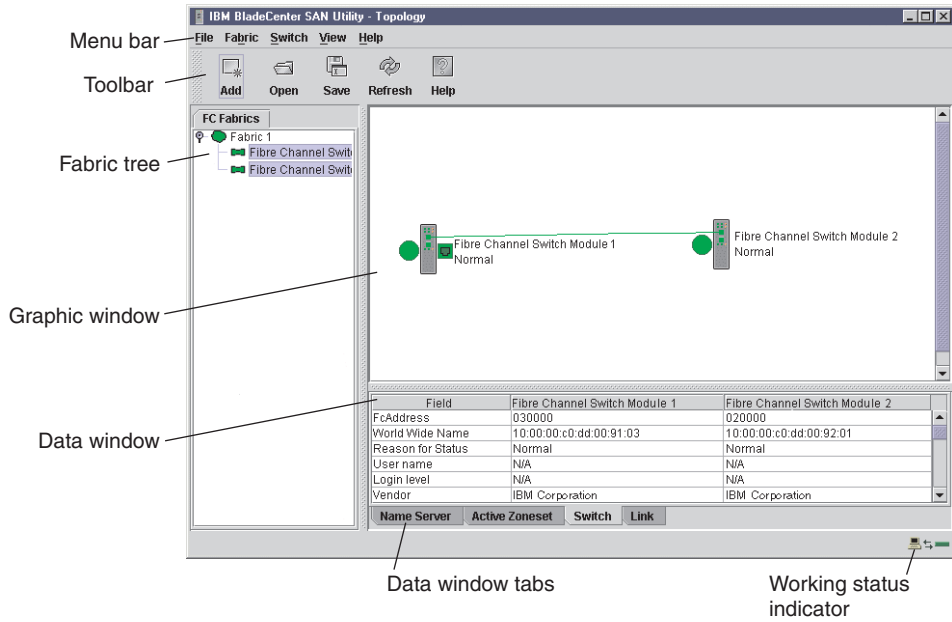

Figure 1. Topology window

The Faceplate window displays the front of a single switch module and its active ports, as shown in Figure 2.

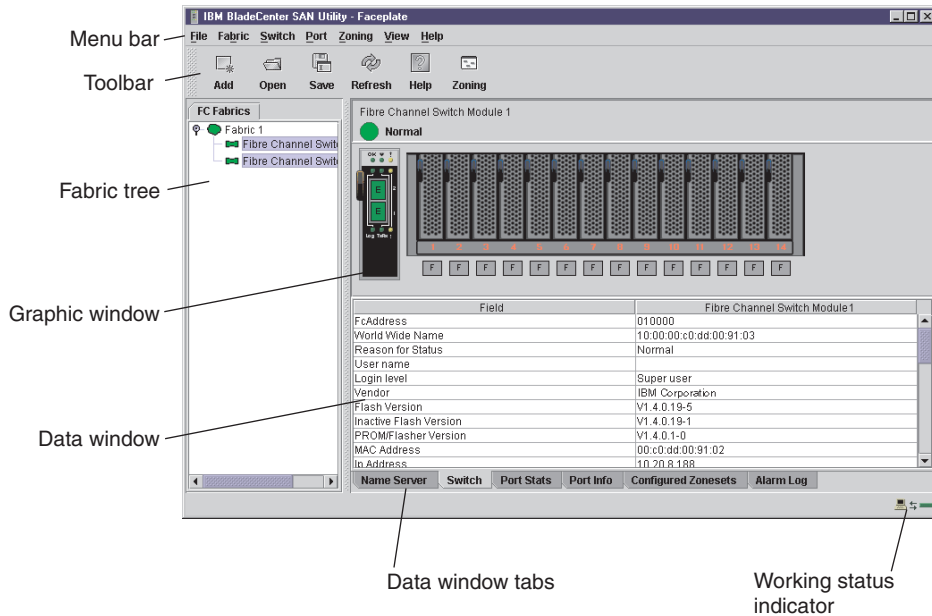

Figure 2. Faceplate window

Menu bar

The menu bar is displayed at the top of the Faceplate window and Topology window. Depending on which window is open, the menu bar has similar menu selections. Figure 3 on page 73 shows menu items that are available in the Topology window. In the Faceplate window, menu items shown with a gray background are available.

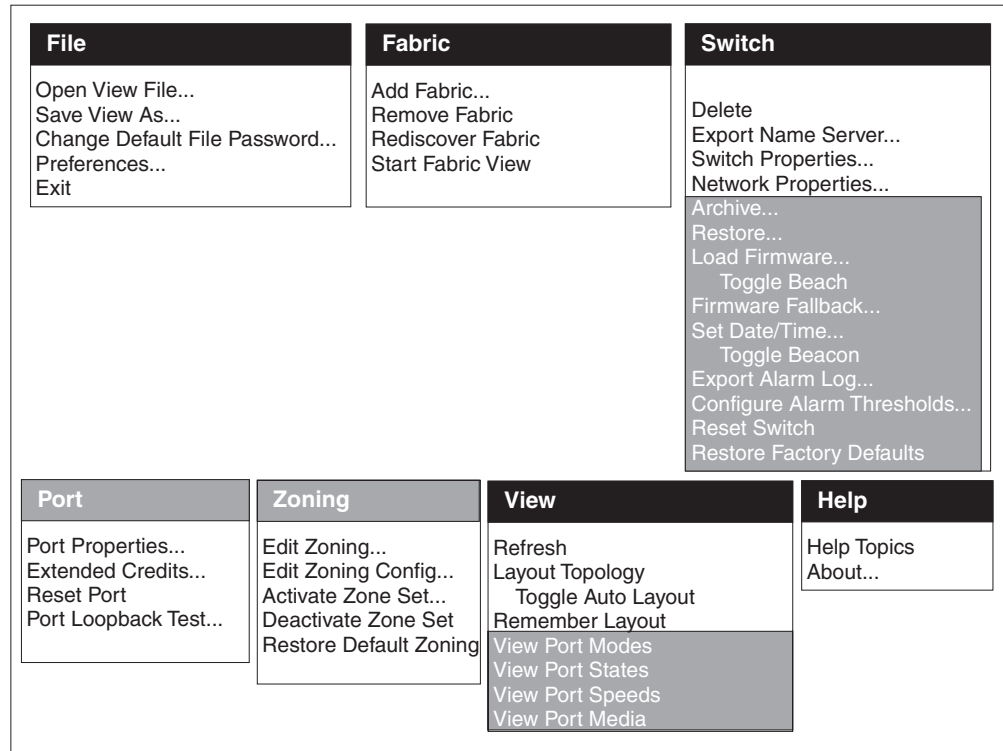

Figure 3. Menu bar selection examples

Some menu selections have shortcut keys as shown in Table 14.

Table 14. Menu shortcut keys

Shortcut key	Menu selection
F5	View → Refresh
Ctrl+O	File → Open View File

In addition to the menu bar, both the Topology and Faceplate windows have context-sensitive menus that open when you click in the graphic window with the right mouse button. See “Opening the Faceplate window and pop-up menus” on page 78 for more information about these pop-up menus.

Toolbar

The toolbar consists of a row of graphical buttons that you can use to access SAN Utility functions as shown and described in Table 15. The toolbar buttons are an alternative method to using the menu bar.

Table 15. Toolbar buttons







Toolbar button	Toolbar button name	Description
	Add Fabric	Adds a new fabric
	Open View File	Opens an existing fabric view file

Table 15. Toolbar buttons (continued)

Toolbar button	Toolbar button name	Description
 Save	Save View As	Saves the current fabric view to a file
 Refresh	Refresh	Polls the fabric to update the Topology or Faceplate window with the current information
 Help	Help Topics	Opens the online help
 Zoning	Edit Zoning	Opens the Edit Zoning window (available only in the Faceplate window)

Fabric tree

The fabric tree, in the FC Fabric pane, lists the managed fabrics and their switch modules. To adjust the window, click and drag the moveable window border. An entry handle to the left of an entry in the tree indicates that you can expand the entry. When you click the handle or double-click the entry, the entry expands to show its member switches. These fabric tree elements are shown in Figure 4.

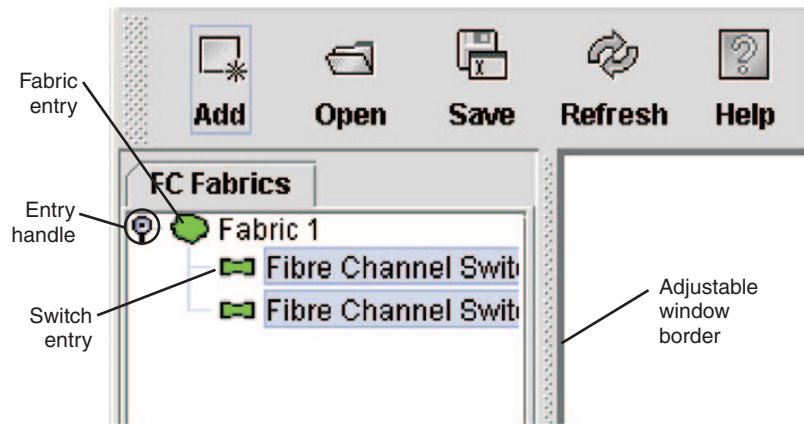

Figure 4. Fabric tree

Each fabric tree entry has a small icon next to it that uses color to indicate the following operational status:

- A green switch module entry icon indicates that the switch is in normal operation.
- A red switch module entry icon indicates that the switch has a communications failure.
- A blue switch module entry icon indicates that the switch status is Unknown or that security is enabled on the switch module but security is disabled on the fabric management switch.
- An amber switch module entry icon indicates that the switch is operational with errors.

You can use the fabric tree to access any fabric or switch module using the Topology or Faceplate window. You can click a fabric entry to open the Topology window from the fabric tree. You can click a switch module entry to open the Faceplate window from the fabric tree.

Graphic window

The graphic window as shown in Figure 1 on page 72, shows graphic information about fabrics and switch modules such as the fabric topology and the switch faceplate. To adjust the window length, click and drag the window border that it shares with the data window.

Data window and tabs

The data window as shown in Figure 2 on page 72 displays a table of data and statistics associated with the selected tab. Use the scroll bar to browse through the data. The window length can be adjusted by clicking and dragging the border that it shares with the graphic window.

To adjust the column width, move the pointer over the column heading border shared by two columns until a right/left arrow graphic is displayed. Click and drag the arrow to the desired width. The data window tabs show options for the types of information that you can display in the data window. These options vary depending on the display.

Working status indicator

The working status indicator as shown in Figure 1 on page 72 is in the lower-right corner of the Topology window and shows when the network management workstation is exchanging information with the fabric. As conditions change, the fabric forwards this information to the network management workstation where it is reflected in the various displays.

Using the Topology window

The Topology window shown in Figure 5 on page 76 polls the selected fabric and displays its topology. switch modules and interswitch links (ISL) are displayed in the graphic window and use color to indicate status. The following functional elements are displayed in the Topology window when you click on the Data window tabs:

- Switch module and link status
- Working with switch modules and links
- Topology data windows

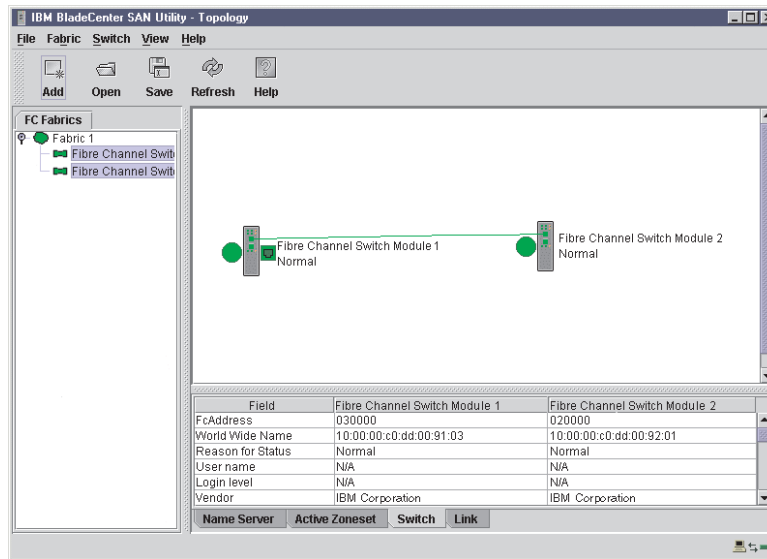

Figure 5. Topology window

Fibre Channel switch module and link status

The Fibre Channel switch module icon shape and color provide information about the switch and its operational state. In the Topology window, lines represent links between switch modules. See Table 16 for Fibre Channel switch module and link status and “Fabric status” on page 84 for more information about other Topology window icons.

Table 16. Fibre Channel switch module and link status indicators

Switch module icon color	Status
Green	Normal Fibre Channel switch operation
Amber	Operational with errors
Red	Inactive or Fibre Channel switch failure
Blue	Unknown Fibre Channel device

Working with switch modules and links

Switch module and link icons are selectable and moveable and serve as access points for other windows and menus. You select switch modules and links to display information, modify configurations, or delete them from the window. The context-sensitive pop-up menus are accessible through the switch module and link icons.

Click a switch module or link in the graphic window to display its status in the data window. To select multiple switch modules or links, hold down the Ctrl key while selecting. When no switch modules or links are selected, information about all switch modules is displayed. To deselect a switch module or link that is currently selected, click the switch or link.

Different switch module icons will be displayed depending on the different switch vendor products present in the attached fabric. See Table 17 on page 84 for a list of switch module icons and vendors. Attached switch modules that are not

manageable through the SAN Utility will be displayed as “third-party manageable” switch icons. The topology configuration in Figure 6 shows an example of a switch fabric with third-party switch modules.

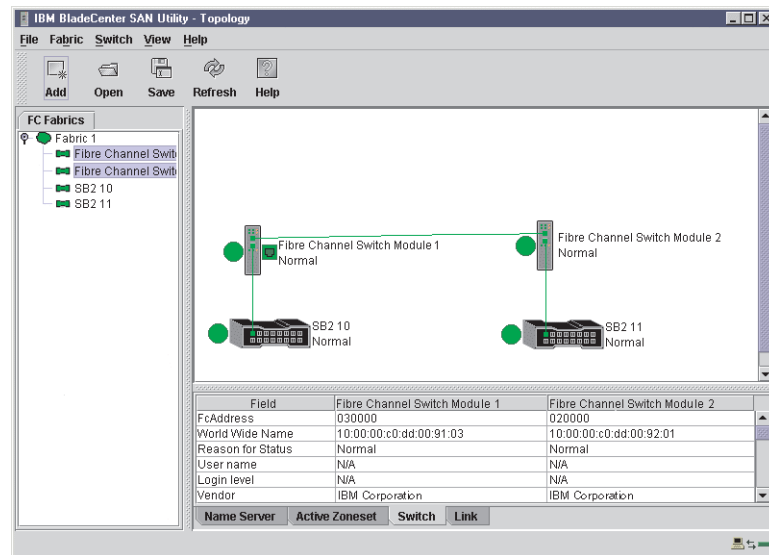

Figure 6. Switch fabric showing third-party manageable switch modules

Arranging switch modules in the window

You can use the following two methods to arrange individual switch module icons:

- To move an individual switch module icon, click and drag the icon to another location in the graphic window. Links stretch or contract to remain connected.
- To arrange all switch module icons in the Topology window, click **View → Layout Topology**.

The **Toggle Auto Layout** check box in the **View** menu is selected by default so that the SAN Utility can arrange the icons when you select **Layout Topology**.

You can save a custom arrangement, or layout, and restore that layout during a SAN Utility session. To create a custom arrangement, arrange the icons; then, click **View → Remember Layout**. To restore the saved layout, click **View**, clear the **Toggle Auto Layout** check box, and click **Layout Topology**.

Selecting switch modules and links

Selected switch module icons are highlighted in violet. Selected ISLs are highlighted in amber. You can select switch modules and links by performing the following tasks:

- To select a switch module or a link, click the icon or link.
- To select multiple switch modules or links, hold down the Ctrl key and click the switch modules or links that you want.
- To select all switch modules or links, right-click in the graphic window background. Click **Select All Switches** or click **All Links** from the pop-up menu.

To cancel a selection, press and hold the Ctrl key, and select the item again. To cancel multiple selections, click in the graphic window background.

Topology data window tabs

The Topology Data window contains four tabs at the bottom of the window. When you click a tab, the following information is displayed:

- **Name Server** - Click the **Name Server** tab to display all devices that are logged with the name server and their location within the current fabric configuration. See “Name Server Data window” on page 112 for more information about your configuration.
- **Active Zoneset** - Click the **Active Zoneset** tab to display the active zone set for the fabric, including zones and their member ports. See “Active Zoneset Data window” on page 85 for more information about this data window. See “Zoning a fabric” on page 86 for information about zone sets and zones.
- **Switch** - Click the **Switch** tab to display the current network and switch module configuration data for the selected switches. See “Switch Data window” on page 98 for more information.
- **Link** - Click the **Link** tab to display the current link status for the selected switch modules in the fabric.

Using the Faceplate window

The Faceplate window shown in Figure 7 and described in this section displays the switch module name and operational state and the port status. The following functional elements are displayed in the Faceplate window when you click on the Data window tabs:

- Port views and status
- Working with ports
- Faceplate data windows

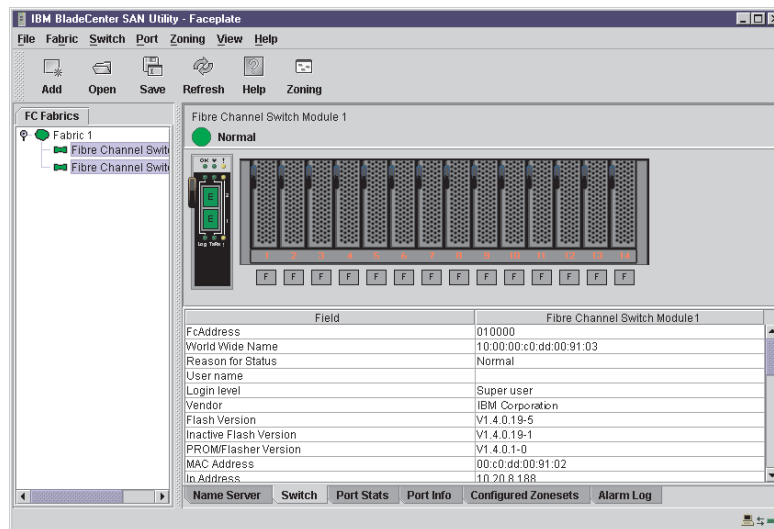

Figure 7. Faceplate window

Opening the Faceplate window and pop-up menus

The Faceplate window shows the front of a single switch module and its ports. You can open the Faceplate window and pop-up menus when you are in the Topology window by performing the following tasks:

- To open the Faceplate window when viewing the Topology window, click a switch module entry or icon in the fabric tree, or double-click the switch module graphic.
- To open the fabric pop-up menu when viewing the Topology window, right-click the graphic window background. The fabric pop-up menu displays selections to refresh the fabric, select all switch modules, select all links, or layout topology.
- To open the switch module pop-up menu when viewing the Topology window, right-click the switch module icon in the graphic window. The switch pop-up menu displays selections to refresh the switch, delete the switch from the display, open the Switch Properties window, or open the Network Properties window.
- To open the link pop-up menu, right-click the link. The Link pop-up menu displays a selection to delete the link from the display.
- To open a Faceplate window pop-up menu, right-click the faceplate graphic in the Graphic window. The faceplate pop-up menu displays selections to refresh the switch module, select all ports, manage switch, port, and network properties, extend credits, and run the Port Loopback tests.

Port views and status

Port color and text provides information about the port and its operational state. Green indicates that the port is active, and gray indicates that the port is inactive. The Faceplate window displays the following views of port status corresponding to the View menu options in the Faceplate window:

- Port mode
- Port state
- Port speed
- Port media

See “Monitoring port status” on page 108 for more information about these displays.

Working with ports

Ports are selectable and serve as access points for other windows and menus. You select ports to display information about them in the data window or to modify them. You cannot use the SAN Utility to select internal bays and external ports at the same time; you must select either internal bays or external ports. Context-sensitive pop-up menus and properties windows are accessible through the Faceplate window and port icons.

Selecting ports

When you select a port, the port is highlighted with a white border. You can select ports in the following ways:

- To select one port, click the port in the Faceplate display.
- To select a range of either internal or external consecutive ports, select a port and then press and hold the shift key and select another port. The application selects both end ports and all ports in between in port number.
- To select several nonconsecutive ports, hold the Ctrl key while selecting ports.
- To select all external ports, right-click anywhere on the switch module faceplate, and select **Select All Ports** from the pop-up menu. To select all internal ports, click any blade server and select **All Ports** from the pop-up menu.

To cancel a selection, press and hold the Ctrl key and select it again.

Opening pop-up menus

You can manage the switch module and its ports using the following methods:

- To open the pop-up menu, right-click anywhere in the graphic window. If no ports are selected, port specific tasks are unavailable in the menu.
- To select one or more ports and open the Port pop-up menu, right-click a port.

Faceplate data window tabs

The Faceplate Data window contains six tabs at the bottom of the display. When you click a tab, the following information is displayed:

- **Name Server** - Click the **Name Server** tab to display all devices connected to the switch module that are logged with the name server.
- **Switch** - Click the **Switch** tab to display the current switch module configuration data.
- **Port Statistics** - Click the **Port Stats** tab to display the port performance data for the selected port.
- **Port Information** - Click the **Port Info** tab to display the port detail information for the selected port.
- **Configured Zonesets** - Click the **Configured Zonesets** tab to display all zone sets, zones, and zone membership in the zoning database.
- **Alarm Log** - Click the **Alarm Log** tab to display the system error information.

Managing fabrics

This section describes the following four main tasks for managing fabrics:

- Setting up security
- Managing the fabric database
- Displaying fabric information
- Zoning a fabric

Setting up security

Access to a switch module and permission to configure a switch is managed through user accounts created by a fabric administrator. A user account consists of an account name, a password, and an authority level. The authority level determines whether an account can merely monitor the switch module and fabric activity (User authority), or change switch module configurations (Administrative authority). See “User command” on page 60 for information about administrating user accounts. Fabric security determines the enforcement of user accounts on a switch module. A fabric administrator can enable or disable the fabric security on a switch module using the **Set Setup System** command.

If fabric security is disabled (default), you can use the SAN Utility to log in to a switch module without an account name and password. The **Login name** and **Password** fields in the Add a Fabric window are ignored, and you are granted Admin authority. If fabric security is enabled, you must enter an account name and password to log in to a switch module and add the fabric to the workspace. Having successfully added a fabric, you can perform only those tasks in the SAN Utility that are granted by the authority level for that account. All switch modules in a fabric should use the same fabric security value. See “Set Setup command” on page 38 for information about the System keyword and the Security Enable parameter.

Note: A switch module supports a combined maximum of 15 active login sessions. This includes SAN Utility in-band and out-of-band login attempts, Telnet out-of-band login attempts, and SNMP out-of-band login sessions. Of this 15,

there can be a maximum of 10 SAN Utility login attempts included in the 15 total attempts. Additional logins are refused.

Managing the fabric database

A fabric database contains the set of fabrics that you have added during a SAN Utility session. Initially, a Topology window with an empty fabric database opens. This section describes the following fabric database management tasks:

- Adding a fabric
- Removing a fabric
- Opening a fabric view file
- Saving a fabric view file
- Rediscovering a fabric
- Adding a new switch module to a fabric
- Replacing a failed switch module in a fabric
- Deleting switch modules and links

Adding a fabric

Complete the following steps to add a fabric to the database:

1. In the Faceplate window, click **Fabric** → **Add Fabric**.

The Add a New Fabric window opens, as shown in Figure 8.

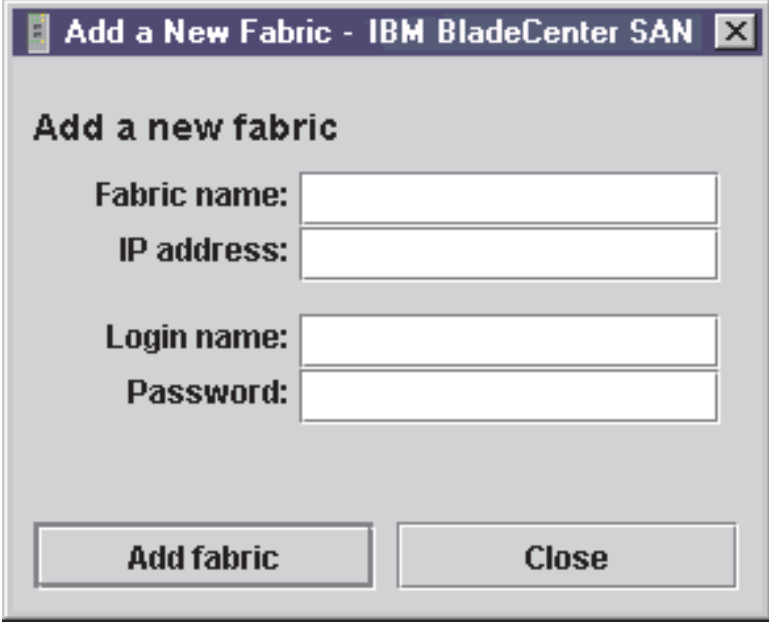

The image shows a dialog box titled "Add a New Fabric - IBM BladeCenter SAN". The dialog has a title bar with a close button. The main area is titled "Add a new fabric" and contains four input fields: "Fabric name:", "IP address:", "Login name:", and "Password:". At the bottom, there are two buttons: "Add fabric" and "Close".

Figure 8. Add a New Fabric window

2. In the **Fabric name** field, type a fabric name.
3. In the **IP address** field, type the IP address of the switch module through which to manage the fabric.
4. In the **Login name** field, type the initial default login ID, USERID. In the **Password** field, type the initial default password, PASSWORD (the sixth character is a zero, not the letter O). The user ID and password are case sensitive.

Note: The password is for the switch module and is stored in the switch firmware. You are not required to type a user ID or password if security is

disabled. See “Setting up security” on page 80. See “Set Setup command” on page 38 for information about the Set Setup commands in the Telnet section to log in, and obtain password and security information.

5. Click **Add fabric**.

Removing a fabric

Complete the following steps to delete a fabric file from the database:

1. Select a fabric in the fabric tree.
2. In the Faceplate window, click **Fabric** → **Remove Fabric**.

Opening a fabric view file

Complete the following steps to open an existing fabric view file:

1. In the Faceplate window, click **File** → **Open View File**, or click the **Open** icon.
If there is a change to the fabric you are using, you are prompted to save the changes to the view file before opening a different view file.
The Open View window opens.
2. In the Open View window, type the name of the file you want to open.
3. Type a file password if necessary.
4. Click **Load View File**. If the fabric has changed, you are prompted to save the file before opening the new view.

Saving a fabric view file

Complete the following steps to save a fabric view file:

1. In the Faceplate window, click **File** → **Save View As** or click the **Save** icon.
The Save View window opens.
2. In the Save View window, type a new file name.
3. Click **OK**.
4. Type a file password, if necessary.

Rediscovering a fabric

After making changes or deleting switch modules from a fabric view, refresh the fabric configuration. Use the Rediscover Fabric option to clear the current fabric information that is displayed and rediscover the switch module information. To rediscover a fabric, in the Faceplate window, click **Fabric** → **Rediscover Fabric**.

Adding a new switch module to a fabric

After you install a switch module into your BladeCenter unit, the switch uses the default fabric configuration settings. The default fabric configuration settings are as follows:

- Fabric zoning is sent to the switch module from the fabric.
- All external ports (0,15) are GL_Ports; all internal ports (1 through 14) are F_Ports.
- The default IP addresses are:
For switch module bay 3:
192.168.70.129

For switch module bay 4:
192.168.70.130

Complete the following steps to add a new switch module to a fabric and not make changes to the default fabric configuration settings:

1. If the switch module is not new, to reset the switch to the factory configuration, in the Faceplate window, click **Switch → Restore Factory Defaults**.
2. If you want to manage the switch module through the Ethernet port, configure the network SNMP configuration using the Network Properties window. For more information, see “Network properties” on page 105.
3. Configure any special switch settings.

Note: To prevent communication with other switch modules in the fabric until the new switch is configured, in the Zoning Config window, click **None** in the **Default Visibility** field. For more information, see “Zoning configuration” on page 88.

4. Connect the interswitch links (ISL), but do not connect the devices.
5. In the Port Properties window, configure the port types for the new switch (GL_Port, TL_Port, Donor).
6. Connect the Fibre Channel devices to the switch module.
7. In the Edit Zoning window, make the necessary zoning changes.

Replacing a failed switch module in a fabric

Complete the following steps to replace a failed switch module for which an archive is available. See “Restoring a switch module” on page 126 and “Archiving a switch module” on page 106 for more information.

1. Remove the failed switch module. For more information, see the *Installation Guide*.
2. Install the new replacement switch module. For more information, see the *Installation Guide*.
3. Log in to the fabric through the replacement switch module. In the Topology window, select the replacement switch module from the fabric tree.
4. Click **Switch → Restore**.
The Restore Switch window opens.
5. In the Restore Switch window, type a name or select the archived switch configuration file to copy to the switch module. For more information, see “Archiving a switch module” on page 106.
6. Click **OK** to write the configuration file to the switch module.

Deleting switch modules and links from the Topology display

The SAN Utility does not automatically delete switch modules or links that have failed or that are physically removed. In this case, you can delete switch modules and links in the Topology window to bring the display up to date. If you delete a switch or a link that is still active, the SAN Utility restores it automatically. You can also refresh the display.

Complete the following steps to delete a switch module in the Topology window:

1. Select one or more switch modules in the Topology window.
2. Click **Switch → Delete**.

Complete the following steps to delete a link:

1. Select one or more links in the Topology window.
2. Click **Switch → Delete**.

Displaying fabric information

The Topology window is the primary tool for monitoring a fabric. The graphics window of the Topology window provides status information for switch modules, interswitch links, and the Ethernet connection to the network management workstation.

The data window tabs show name server, switch, and active zone set information. The **Active Zoneset** tab shows the zone definitions for the active zone set. See “Switch Data window” on page 98 and “Name Server Data window” on page 112 for information about the Switch Data and Name Server Data windows.

Fabric status

The fabric updates the Topology and Faceplate windows by forwarding changes in status to the network management workstation as they occur. Use the fabric to update the display status, or you can refresh the display at any time. To refresh the Topology window, use one of the following methods:

- In the Topology window, click **Refresh**.
- Click **View** → **Refresh**.
- Press the F5 key.
- Right-click anywhere in the background of the Topology window. Select **Refresh Fabric** from the pop-up menu.

The Topology window displays switch module and status icons that provide status information about switches, interswitch links, and the Ethernet connection. The switch module icons indicate different vendor switches and switch types. The switch module status icons, displayed on the left side of a switch, vary in shape and color. Each switch module that is managed by an Ethernet Internet protocol (IP) has a colored Ethernet icon that is displayed on the right side of the switch. A green Ethernet icon indicates normal operation, amber indicates operational with errors, and red indicates inactive or failure. Table 17 shows the different switch module icons and their descriptions.

Note: Different switch module icons are displayed depending on the different switch vendor products presented in the attached fabric. For a list of switch module icons and vendors, see Table 17. Attached switch modules that are not manageable through the SAN Utility are displayed as third-party manageable switch icons. The topology configuration in Figure 6 on page 77 shows an example of a switch fabric with third-party switch modules.

Table 17. Topology window switch module and status icons













Switch module icon	Description
	BladeCenter Fibre Channel switch module
	QLogic 8-port Fibre Channel switch module
	QLogic 16-port Fibre Channel switch module Inrange switch module

Table 17. Topology window switch module and status icons (continued)

Switch module icon	Description
	McData switch module
	Brocade switch module
	Other third-party switch modules
	Switch communication normal (green)
	Switch is operational with errors (amber)
	Switch communication interrupted (red)
	Switch management communication unknown (blue)
	Fabric management switch Ethernet connection normal (green)
	Fabric management switch Ethernet connection critical (red)
	Fabric management switch Ethernet connection warning (amber)

Active Zoneset Data window

The Active Zoneset Data window displays the zone membership for the active zone set that resides on the fabric management switch. The active zone set is the same on all switch modules in the fabric. You can confirm this by adding a fabric through another switch module and comparing Active Zone Set displays.

To open the Active Zoneset Data window, click the **Active Zoneset** tab below the data window in the Topology window. See “Zoning a fabric” on page 86 for more information about zone sets and zones. See “Configured Zonesets Data window” on page 100 for information about the zone set definitions on a specific switch module.

The Active Zoneset data window, shown in Figure 9 on page 86, uses display conventions for expanding and contracting entries that are similar to the fabric tree. An entry handle to the left of an entry in the fabric tree indicates that you can expand the entry. Click this handle or double-click the following entries to expand or contract them:

- A zone set entry expands to show its member zones.
- A zone entry expands to show its member ports.
- A port entry expands to show the port Fibre Channel address.
- A Fibre Channel address entry expands to show the port worldwide name.

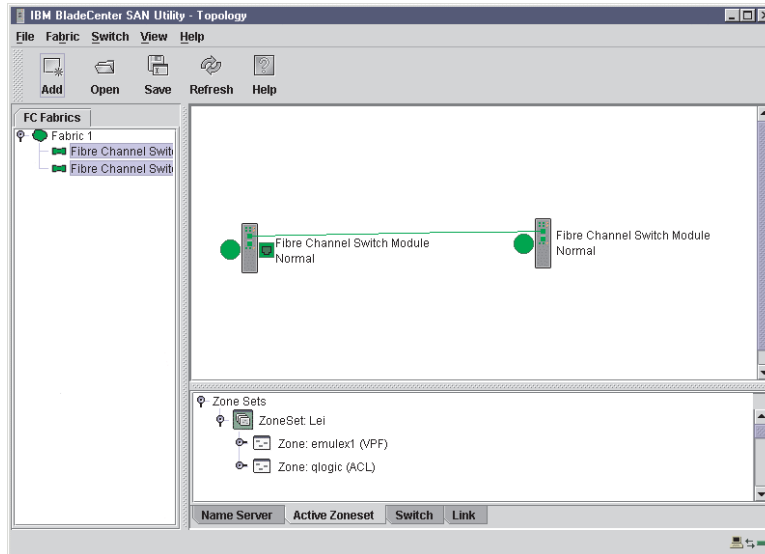

Figure 9. Active Zonesets window

Zoning a fabric

Fibre Channel fabrics use zoning to restrict or extend access to devices in the fabric. A zone is a named group of devices that can communicate with each other.

You can use zoning to divide the ports and devices of the fabric into zones for more efficient and secure communication among functionally grouped nodes. You can set the Auto Save and Default Visibility zoning configuration parameters using the SAN Utility or the **Set Config Zoning** command. See “Auto save” on page 88 for information about the Auto Save parameter, see “Default visibility” on page 88 for information about the Default Visibility parameter, and see “Using the Zoning Config window” on page 89 for information about the Set Config Zoning command.

Zoning concepts

The following zoning concepts provide some context for the zoning tasks described in this section:

- Zones
- Aliases
- Zone sets
- Zoning database
- Zoning configuration

Zones: A *zone* is a named group of ports or devices that can communicate with each other. Membership in a zone is defined by port number, device Fibre Channel address, or device World Wide Name (WWN). Zone members can communicate only with members of the same zone. Zones can overlap; that is, a port or device can be a member of more than one zone.

There are three zone types that are supported but have restrictive levels of communication. These zone types are:

- Soft zone
- Access control list (ACL) - hard zone

- Virtual private fabric (VPF) - hard zone

Soft zoning: Soft zoning divides the fabric for purposes of controlling discovery. Members of the same soft zone automatically discover and communicate freely with all other members of the same zone. The soft zone boundary is not secure; traffic across soft zones can occur if addressed correctly. Soft zones that include members from multiple switch modules need not include the ports of the interswitch links. Soft zone boundaries yield to ACL and VPF zone boundaries. Soft zones can overlap; that is, a port can be a member of more than one soft zone. Membership is defined by Fibre Channel address, port ID and domain ID, or worldwide name. Soft zoning supports all port modes.

Access control list zones: Access control list (ACL) zoning divides the fabric for purposes of controlling discovery and inbound traffic. ACL zoning is a type of hard zoning that is hardware enforced. This type of zoning is useful for controlling access to certain devices without totally isolating them from the fabric. Members can communicate with each other and transmit outside the ACL zone but cannot receive inbound traffic from outside the zone. The ACL zone boundary is secure against inbound traffic. ACL zones can overlap; that is, a port can be a member of more than one ACL zone. ACL zones that include members from multiple switch modules need not include the ports of the interswitch links. ACL zone boundaries supersede soft zone boundaries but yield to VPF zone boundaries. Membership can be defined only by port ID and domain ID. ACL zoning supports all port modes except TL_Ports.

Virtual private fabric zones: Virtual private fabric (VPF) zoning divides the fabric for purposes of controlling discovery and both inbound and outbound traffic. This type of zoning is useful for providing security and reserving paths between devices to guarantee bandwidth. VPF zoning is a type of hard zoning that is hardware enforced. Members can transmit to and receive only from members of the same VPF zone. The VPF zone boundary is secure against both inbound and outbound traffic. VPF zones that include members from multiple switch modules must include the ports of the interswitch links. VPF zones cannot overlap; that is, a port can be a member of only one VPF zone. VPF zone boundaries supersede both soft and ACL zone boundaries. Membership can be defined only by port ID and domain ID. VPF zoning supports all port modes.

Note: Domain ID conflicts can result in automatic reassignment of switch module domain IDs. These reassignments are not reflected in zones that use domain ID and port number pairs or Fibre Channel addresses to define their membership. Be sure to reconfigure zones that are affected by a domain ID change. To prevent zoning definitions from becoming invalid when the membership is defined by domain ID/port number or Fibre Channel address, you must lock domain IDs.

Aliases: To make it easier to add a group of ports or devices to one or more zones, you can create an alias. An *alias* is a named set of ports or devices that are grouped together for convenience. Unlike zones, aliases impose no communication restrictions between its members. You can add an alias to one or more zones. However, you cannot add a zone to an alias, nor can an alias be a member of another alias.

Zone sets: A *zone set* is a named group of zones. A zone can be a member of more than one zone set. All zones that are not members of a zone set belong to the orphan zone set. The orphan zone set is saved to the switch module. Each switch module in the fabric maintains its own zoning database containing one or

more zone sets. This zoning database resides in nonvolatile or permanent memory and is therefore retained after a reset. For information about displaying the zoning database, see “Configured Zonesets Data window” on page 100.

To apply zoning to a fabric, select a zone set and activate it. When you activate a zone set, the switch module distributes that zone set to every switch in the fabric. Therefore, every switch module in the fabric will have identical active zone sets. For information about displaying the active zone set, see “Active Zoneset Data window” on page 85.

Zoning database: Each switch module has its own *zoning database*. The zoning database is made up of all aliases, zones, and zone sets that have been created on the switch or received from other switch modules. The switch module maintains two copies of the zoning database: one copy is maintained in temporary memory for editing purposes; the second copy is maintained in permanent memory. Zoning database edits are made on an individual switch basis and are not propagated to other switch modules in the fabric when saved.

The Auto Save zoning configuration parameter controls whether the temporary zoning database is automatically saved in permanent memory. For more information about the Auto Save parameters, see “Zoning configuration”.

The zoning limits for a fabric are:

- Maximum number of zonesets is 256
- Maximum number of zones is 256
- Maximum number of aliases is 256
- Maximum number of members per zone is 2000
- Maximum number of members per alias is 2000
- Maximum total number of zone and alias members is 2000
- Maximum total number of zone set members is 1000

Zoning configuration: You can set the zoning configuration parameters using the SAN Utility or the **Set Zoning Config** command. For information about zoning configuration using the SAN Utility, see “Using the Zoning Config window” on page 89 and “Set Config command” on page 28.

The following parameters make up the zoning configuration:

- Auto Save
- Default Visibility

Auto save: The **Auto Save** parameter determines whether changes to the active zone set that a switch module receives from other switches in the fabric are saved to permanent memory on that switch module. Changes are saved when an updated zone set is activated. Zoning changes are always saved to temporary memory. However, if Auto Save is enabled, the switch module firmware saves changes to the active zone set in both temporary and permanent memory. If Auto Save is disabled, changes to the active zone set are stored only in temporary memory.

Default visibility: The **Default Visibility** parameter determines the level of communication that is permitted between devices when there is no active zone set. The default visibility parameter can be set differently on each switch module. When default visibility is enabled (set to **All**) on a switch module, all ports on the switch can communicate with all ports on switch modules that also have the **Default Visibility** parameter set to **Enabled**. When default visibility is disabled (set to

None) on a switch module, none of the ports on that switch module can communicate with any other switch in the fabric.

Using the Zoning Config window

Use the Zoning Config window to change the Auto Save and Default Visibility configuration parameters. Complete the following steps to open the Zoning Config window and change configuration parameters:

1. In the Faceplate window, click **Zoning** → **Edit Zoning Config**. The Zoning Config window opens.

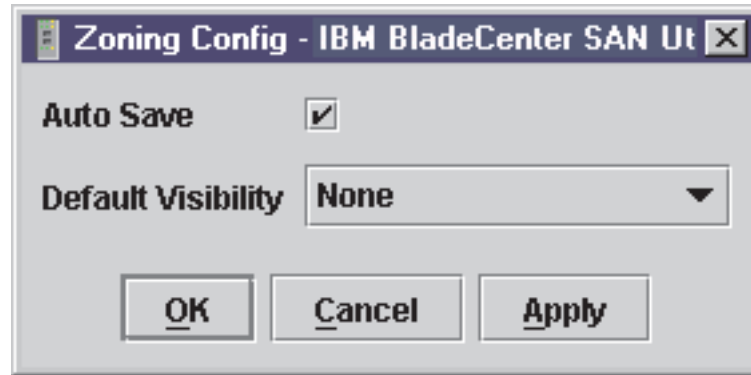

Figure 10. Zoning Config window

2. Make the necessary changes to the **Auto Save** and **Default Visibility** fields and click **OK**.

Restoring default zoning

Restoring the default zoning clears the switch module of all zoning definitions. Complete the following steps to restore the default zoning for a switch module.

Attention: The use of this command will deactivate any active zone set. If the switch module is not isolated from the fabric, this command will deactivate the active zone set for the entire fabric.

1. In the Faceplate window, click **Zoning** → **Restore Default Zoning**.
2. Click **OK** to confirm that you want to restore default zoning and save changes to the zoning database.

Merging fabrics and zoning

If you join two fabrics, the active zone sets from the two fabrics attempt to merge. The fabrics can consist of a single switch module or many switches already connected together. The switch modules in the two fabrics attempt to create a new active zone set containing the union of the active zone set of each fabric. The propagation of zoning information affects only the active zone set, not the configured zone sets.

Zone merge failure

If a zone merge is unsuccessful, the interswitch links between the fabrics will isolate because of a zone merge failure, which generates an alarm log entry. The reason for the E_Port isolation can also be determined by viewing the port information. See the “Port Information Data window” on page 100 and the “Show command” on page 41 (Port keyword).

A zone merge will fail if the two active zone sets have member zones with identical names that differ in content or type. For example, consider Fabric A and Fabric B, each with a zone in its active zone set named “ZS1.” Fabric A “ZS1” contains a member specified by Domain ID 1 and Port 1; Fabric B “ZS1” contains a member specified by Domain ID 1 and Port 2. In this case, the merge fails, and the interswitch links between the fabrics are isolated.

Zone merge failure recovery

When a zone merge failure occurs, the conflict that caused the failure must be resolved. You can correct a failure due to a zone conflict by deactivating one of the active zone sets or editing the conflicting zones so that their membership is the same. You can deactivate the active zone set on one switch module if the active zone set on the other switch accurately defines your zoning needs. If not, you must edit the zone memberships and reactivate the zone sets. For information about adding and removing zone members, see “Managing zones” on page 93. To permit the fabrics to join, reset the ports that were isolated. See “Resetting a port” on page 117.

Using the Edit Zoning window

Use the Edit Zoning window to edit the zoning database for a specific switch module. To edit the zoning database, in the Faceplate window, click **Zone** → **Edit Zoning**. The Edit Zoning window opens.

Note: You can make changes only to an active zone set, which is stored in flash (nonvolatile) memory and retained after setting a switch module.

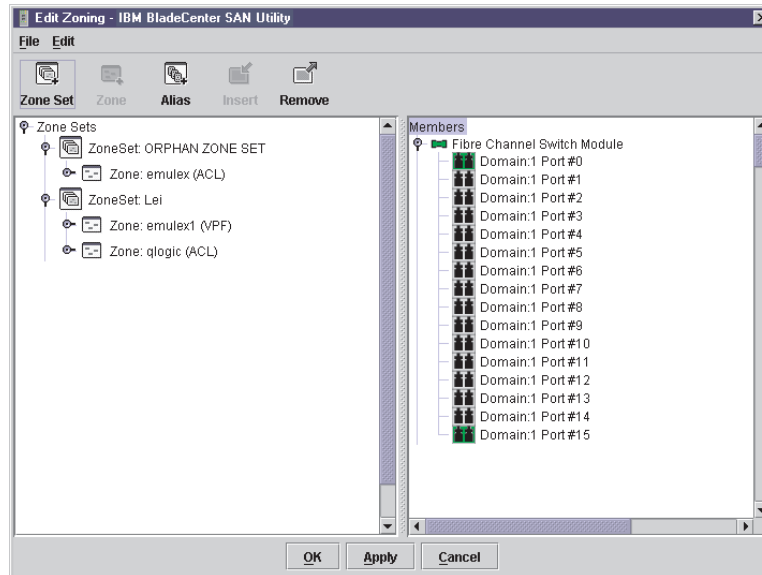

Figure 11. Edit Zoning window

The Edit Zoning window displays a Zone Sets tree in the left pane and a Port and Device (or members) tree in the right pane, as shown in Figure 11. Both trees use display conventions similar to the fabric tree for expanding and contracting zone sets, zones, and ports. An expanded port shows the port Fibre Channel address; an expanded address shows the port worldwide name. You can select zone sets, zones, and ports in the following ways:





- Click a zone, zone set, or port icon.

- Right-click to select a zone set or zone and open the corresponding pop-up menu.
- Hold down the Shift key while clicking several consecutive icons.
- Hold down the Ctrl key while clicking several nonconsecutive icons.

Using the toolbar, pop-up menus, or a drag-and-drop method, you can create and manage zone sets and zones in the zoning database. Click **Apply** to save your changes to the zoning database without closing the window. Click **OK** to save your changes to the zoning database and close the window.

The following table explains the toolbar buttons and functions.

Table 18. Edit Zoning window toolbar buttons

Toolbar button	Function
 Zone Set	Create a new zone set.
 Zone	Create a new zone.
 Alias	Create an additional name for a set of objects.
 Insert	Add the selected zone to a zone set, or add the selected port to a zone.
 Remove	Delete the selected zone from a zone set, or delete the selected port from a zone.

Managing zone sets

Zoning a fabric involves creating a zone set, creating zones as zone set members, then adding devices as zone members. The zoning database supports multiple zone sets to serve the different security and access needs of your storage area network. Only one zone set can be active at one time. Managing zone sets involves the following tasks:

- Creating zone sets
- Activating and deactivating zone sets
- Copying a zone to a zone set
- Removing a zone from one zone set or from all zone sets
- Removing a zone set
- Removing all zoning definitions

Note: Changes that you make to the zoning database are limited to the managed switch module and do not propagate to the rest of the fabric. To distribute changes to configured zone sets fabric-wide, you must edit the zoning databases on the individual switch modules.

Creating a zone set

Complete the following steps to create a zone set:

1. In the Faceplate window, click **Zoning** → **Edit Zoning**.
The Edit Zoning window opens.
2. Click **Edit** → **Create Zone Set**.
The Create Zone Set window opens.
3. Type a name for the zone set, and click **OK**. The new zone set name is displayed in the Zone Sets window.
4. Complete one of the following tasks to create new zones in a zone set:
 - Right-click a zone set and select **Create A Zone** from the pop-up menu. In the Create A Zone window, type a name for the new zone, and click **OK**. The new zone name is displayed in the Zone Sets window.
 - To copy an existing zone into the new zone set, in the Faceplate window, select the zone and drag it into the new zone set.
5. Click **Apply** to save changes to the zoning database.

Activating and deactivating a zone set

You must activate a zone set to apply its zoning definitions to the fabric. Only one zone set can be active at one time. When you activate a zone set, the switch module distributes that zone set to the temporary zoning database on every switch in the fabric, replacing any zone set of the same name. If Auto Save is enabled, the zone set is saved in the permanent zoning database also. For more information, see “Auto save” on page 88.

The purpose of the deactivate function is to suspend all fabric zoning, which results in free communication fabric-wide or no communication, depending on the default visibility setting. For more information, see “Default visibility” on page 88. It is not necessary to deactivate the active zone set before activating a new one.

Complete the following steps to activate a zone set:

1. In the Faceplate window, click **Zoning** → **Activate Zone Set**.
The Activate Zoneset window opens.
2. In the Select Zone Set menu, click **Zone Set** → **Activate**.

Complete the following steps to deactivate a zone set:

1. In the Faceplate window, click **Zoning** → **Deactivate Zone Set**.
A message warning you about traffic disruption is displayed.
2. Click **Yes** to confirm that you want to deactivate the active zone.

Copying a zone to a zone set

Complete the following steps to copy an existing zone and its membership from one zone set to another:

1. In the Faceplate window, select the zone and drag it to the zone set you want.
2. Click **Apply** to save your changes to the zoning database.

Removing a zone from a zone set or from all zone sets

Complete the following steps to remove a zone from a zone set or from all zone sets in the database:

1. In the Faceplate window, click **Zoning** → **Edit Zoning**.
The Edit Zoning window opens.
2. In the Zone Sets tree, select the zone you want to remove.
3. Click **Edit** → **Remove** to remove the zone from the zone set, or select **Remove from All Zones** to remove the zone from all zone sets.
4. Click **Apply** to save changes to the zoning database.

Note: You can use shortcut menus to remove a zone from a zone set or from all zone sets in the database.

Removing a zone set

Removing a zone set from the database affects the member zones in the following ways:

- Member zones that are members of other zone sets are not affected.
- Member zones that are not members of other zone sets become members of the orphan zone set. The orphan zone set is saved on the switch module.

Complete the following steps to remove a zone set from the database:

1. In the Faceplate window, click **Zoning** → **Edit Zoning**.
The Edit Zoning window opens.
2. In the Zone Sets tree, select the zone set to be removed.
3. Click **Edit** → **Remove** to remove the zone set.
4. Click **Apply** to save changes to the zoning database.

Note: You can use shortcut menus to remove a zone set from the database.

Removing all zoning definitions

To remove all zone and zone set definitions from the zoning database, use one of the following methods:

- Click **Edit** → **Remove All**. In the Remove All window, click **Yes** to confirm that you want to delete all zones and zone sets.
- Right-click the **Zone Sets** heading at the top of the Zone Sets tree, and select **Clear Zoning** from the pop-up menu. Click **Yes** to confirm that you want to delete all zone sets and zones.

Managing zones

Managing zones involves the following tasks:

- Creating a zone in a zone set
- Adding zone members
- Renaming a zone or a zone set
- Removing a zone member
- Removing a zone from a zone set
- Removing a zone from all zone sets
- Changing zone types

Note: Changes that you make to the zoning database are limited to the managed switch module and do not propagate to the rest of the fabric. To distribute changes to configured zone sets fabric-wide, you must edit the zoning databases on the individual switch modules.

Creating a zone in a zone set

When a zone is created, its zone type is soft. To change the zone type to a hard zone, see “Changing zone types” on page 95 for more information. See “Zones” on page 86 for information on zone types (soft and hard). Complete the following steps to create a zone in a zone set:

1. In the Faceplate window, click **Zoning** → **Edit Zoning**.
The Edit Zoning window opens.
2. Click **Edit** → **Create a Zone**.
The Create a Zone window opens.
3. Type a name for the new zone and click **OK**. The new zone name is displayed in the Zone Sets window.

Note: If you type the name of a zone that already exists in the database, the SAN Utility will create a copy of that zone and its membership in the zone set.

4. Use one of the following methods to add ports or devices to the zone:
 - In the zone set tree, select the zone set. In the graphic window, select the port to add to the zone. Click **Edit** → **Add Members**.
 - Select a port by port number, Fibre Channel address, or worldwide name in the Port or Device tree, and drag it into the zone.
 - Select a port by port number, Fibre Channel address, or worldwide name in the Port and Device tree. Right-click the zone and select **Add Zone Members** from the pop-up menu.
5. Click **Apply** to save your changes to the zoning database.

Adding zone members

Adding a zone member to a zone will affect every zone set in which that zone is a member. To add member ports and devices to a zone, choose one of the following methods:

- Select a port by port number, Fibre Channel address, or worldwide name in the Port and Device tree, and drag it into the zone. To select and drag multiple ports and devices, press and hold the Ctrl key while dragging.
- Select one or more ports by port number, Fibre Channel address, or worldwide name in the Port and Device tree. Right-click the zone and select **Add Zone Members** from the pop-up menu.

Click **Apply** to save your changes to the zoning database.

Note: Domain ID conflicts can result in automatic reassignment of switch module domain IDs. These reassignments are not reflected in zones that use domain ID and port number pair to define their membership. Be sure to reconfigure zones that are affected by a domain ID change.

Renaming a zone or a zone set

Complete the following steps to rename a zone:

1. In the Edit Zoning window, in the Zone Sets tree, click the zone or zone set to be renamed.
2. Click **Edit** → **Rename**.
3. In the Rename Zone/Rename Zone Set window, type a new name for the zone and zone set.
4. Click **OK**.

Removing a zone member

Removing a zone member will affect every zone and zone set in which that zone is a member. Complete the following steps to remove a member from a zone:

1. In the Edit Zoning window, select the zone member to be removed.
2. Click **Edit** → **Remove**.
3. Click **OK** to save the changes and close the Edit Zoning window.

Removing a zone from a zone set

Removing a zone from a zone set will affect every zone set in which that zone is a member. Zones that are no longer members of any zone set are moved to the orphan zone set. The orphan zone set is saved on the switch module.

Complete the following steps to delete a zone from a zone set:

1. In the Edit Zoning window, select the zone to be removed.
2. Click **Edit** → **Remove**.
3. Click **OK** to save the changes and close the Edit Zoning window.

Removing a zone from all zone sets

Complete the following steps to delete a zone from all zone sets:

1. In the Edit Zoning window, select the zone to be removed
2. Click **Edit** → **Remove Zone from All Sets**.
3. Click **OK** to save the changes and close the Edit Zoning window.

Changing zone types

Zones that are no longer members of any zone set are moved to the orphan zone set. The orphan zone set is saved on the switch module.

Complete the following steps to change a zone type:

1. In the Faceplate window, select the switch module with the zone type you want to change.
2. Click **Zoning** → **Edit Zoning** or click the **Zoning** icon to open the Edit Zoning window.
3. In the Zone Sets tree, select the zone to change.
4. Click **Edit** → **Set Zone Type**.
The Set Zone Type window opens.
5. Click **Zone Type** → **Soft**, **ACL** (hard zoning), or **VPF** (hard zoning).
 - Soft zoning is the least restrictive type of zoning.
 - ACL zoning is hard zoning and is enforced by hardware and defines access to a given port. ACL zones need not include interswitch links.
 - VPF zoning is hard zoning that defines ports that can communicate with each other. VPF zones must include interswitch links.

For more information about zone types, see “Zones” on page 86.

Managing aliases

An alias is a named set of ports or devices that are grouped together for convenience. An alias is not a zone and cannot have a zone or another alias as a member. This section describes how to create, remove, and add a member to an alias.

Note: Changes that you make to the zoning database are limited to the managed switch module and do not propagate to the rest of the fabric. To distribute

changes to configured zone sets fabric wide, you must edit the zoning databases on the individual switch modules.

Creating an alias

Complete the following steps to create an alias:

1. In the Faceplate window, click **Zoning** → **Edit Zoning**.
The Edit Zoning window opens.
2. Click **Edit** → **Create Alias**.
The Create Alias window opens.
3. Type a name for the alias and click **OK**. The alias name is displayed in the Zone Sets window.
4. Click **OK** to save the alias name to the zoning database.

Adding a member to an alias

To add a member to an alias, use one of the following methods:

- Drag-and-drop method
- Menu options

Complete the following steps to add a member to an alias using the drag-and-drop method:

1. In the right pane of the Faceplate window, click and hold down the mouse button on the member to be added to the alias.
2. Drag the selected member from the right pane to the alias in the left pane.

Complete the following steps to add a member to an alias using the menu options:

1. Click **Zoning** → **Edit Zoning**.
The Edit Zoning window opens.
2. In the left pane of the Edit Zoning window, select an alias.
3. In the right pane, select the member to add to the selected alias.
4. Use one of the following actions:
 - Click **Edit** → **Add Members**.
 - Click **Insert**.
5. Click **OK** to save the changes and close the Edit Zoning window.

Removing an alias from all zones

Complete the following steps to remove an alias from all zones:

1. In the Zone Sets tree of the Edit Zoning window, select the alias to be removed.
2. Click **Edit** → **Remove Alias from All Zones**.
3. In the Remove window, click **Yes**.

Managing switch modules

This section describes the following tasks that manage switch modules in the fabric.

- Displaying switch module information
- Managing alarms
- Exporting name server information to a file
- Paging a switch module
- Setting the switch module date and time
- Resetting a switch module
- Configuring a switch module

- Archiving a switch module
- Managing firmware

Displaying switch module information

The Faceplate window and data windows provide the following specific switch module information:

- Name server information
- Switch module specifications and addresses
- Configuration parameters
- Performance statistics
- Configured zone sets
- Alarm log information

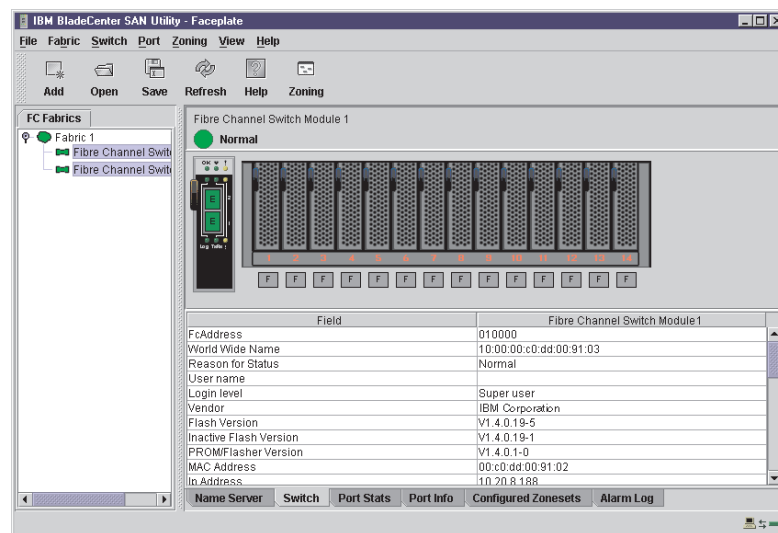

Figure 12. Faceplate data window

A fabric updates the Topology and Faceplate windows by forwarding changes in status to the network management workstation as they occur. You can use the fabric to update the switch module status, or you can refresh the switch status at any time. To refresh a switch module status that is displayed, use one of the following actions:

- Click **Refresh**.
- Click **View** → **Refresh**.
- Press the F5 key.
- Right-click a switch module in the Topology window and click **Refresh Switch**.
- Right-click in the graphic window in the Faceplate window, and click **Refresh Switch**.

Name Server data window

The Name Server data window displays information about the devices that are logged in to the fabric. Click the **Name Server** tab below the data window to display name server information for all devices that are logged in to the selected fabric. To narrow the display to devices that are logged in to specific switch modules, select one or more switches in the fabric tree or the Topology window. For a description of

the entries in the Name Server Data window, see Table 19. For exporting name server information, see “Exporting alarm log information to a file” on page 102.

Note: Internal ports 1 through 14 are fixed.

Table 19. Name server data window entries

Entry	Description
Device	Device number in the fabric
Switch	Switch module name
Port	Port number: Ext1:0, Ext2:15
Address	Fibre Channel address
Type	Node type
NWWN	Node worldwide name
PWWN	Port worldwide name
Vendor	Host bus adapter and device vendor
FC-4 types	Device Fibre Channel protocol types
Active zones	Zones in the current active zone set that contains the device

Switch Data window

The Switch Data window displays current network and switch module information for the selected switches. For more information about the Switch data window, see “Configuring a switch module” on page 102. To open the Switch Data window, select one or more switch modules in the Topology window and click the **Switch** tab below the window. You can also open the Switch Data window from the Faceplate window.

Table 20. Switch data window entries

Entry	Description
FcAddress	Switch module Fibre Channel address
World Wide name	Switch module worldwide name
Reason for status	Additional status information
User name	Name of user
Login level	Security level
Security enabled	Fabric security on the switch module that enforces account names and passwords
Vendor	Switch module manufacturer
Flash version	Active flash
Inactive flash version	Inactive firmware version
PROM/Flasher version	Firmware version
MAC address	Media access control address
IP address	Internet protocol address
Subnet mask	Mask that determines the IP address subnet
Gateway	Gateway address
Negotiated domain ID	The domain ID currently in use by the fabric
Configured domain ID	The domain ID defined by the network administrator
Domain ID lock	Domain ID lock status. Prevents (True) or permits (False) dynamic domain ID reassignment

Table 20. Switch data window entries (continued)

Entry	Description
Number of ports	Number of ports on the switch module
Switch type	IBM Fibre Channel switch module model
Operational state	Switch module operational state: Online, offline, and diagnostic
Administrative state	Current switch module administrative state: Online, offline, and diagnostic
Configured Admin State	Switch module administrative state that is stored in the switch configuration
MFS timeout	Multiframe sequencing timeout value
RA timeout	Resource allocation timeout value
RT timeout	Receiver transmitter timeout value
ED timeout	Error detect timeout value
Zoning merge mode	Active zone set merge or all zone set merge
Zoning merge auto save	Zoning auto save status. Saves zoning updates in temporary and permanent memory (True) or only in temporary memory (False).
Zoning default visibility	Zoning visibility status. Permits (ALL) or prevents (None) communication with other switch modules in the absence of an active zone set.
Temperature	Not applicable
Fan 1 status	Not applicable
Fan 2 status	Not applicable
Fan 3 status	Not applicable
Power supply 1 status	Not applicable
Power supply 2 status	Not applicable
Beacon status	Beacon status. Port Logged-in LEDs are flashing (On) or not (Off).
Broadcast support	Broadcast support status. Broadcast support is enabled or disabled (default).
Inband enabled	Inband management status. Permits (True) or prevents (False) a switch module from being managed over an ISL.
Switch date	Switch module time and date

Link data window

The Link data window displays information about all switch module links in the fabric or selected links. This information includes the switch module name and port number at the end of each link. To open the Link data window, click the **Link** tab below the window.

Fabric view port graphing application

You can use the Fabric View application to view port performance as graphs. The Fabric View window displays data communication rates and total errors for selected ports as shown in Figure 23 on page 127. You can graph communication data rates in frames per second or KB per second. See “Using the Fabric View application” on page 126 for information about tasks that can be performed when using the Fabric View application.

Port Statistics Data window

The Port Statistics Data window displays port performance data for the selected ports. To open the Port Statistics Data window, click the **Port Stats** tab below the data window in the Faceplate window. For a description of the Port Statistics Data window entries, see Table 28 on page 110.

The Statistics menu is accessible in the Port Statistics Data window, and provides different ways to view detailed port information. Click the down arrow to open the **Statistics** menu. In the **Statistics** menu, you can:

- Click **Absolute** to view the total count of statistics since the last switch module reset.
- Click **Rate** to view the number of statistics counted per second over the polling period.
- Click **Baseline** to view the total count of statistics since the last time the baseline was set.
- Click **Clear Baseline** to set the current baseline.

Port Information Data window

The Port Information Data window displays port detail information for the selected ports. To open the Port Information Data window, click the **Port Info** tab below the data window in the Faceplate window. For a description of the Port Information Data window entries, see Table 29 on page 112.

Configured Zonesets Data window

The Configured Zonesets Data window displays all zone sets, zones, and zone membership in the zoning database. To open the Configured Zonesets Data window, click the **Configured Zonesets** tab below the data window in the Faceplate window shown in Figure 13.

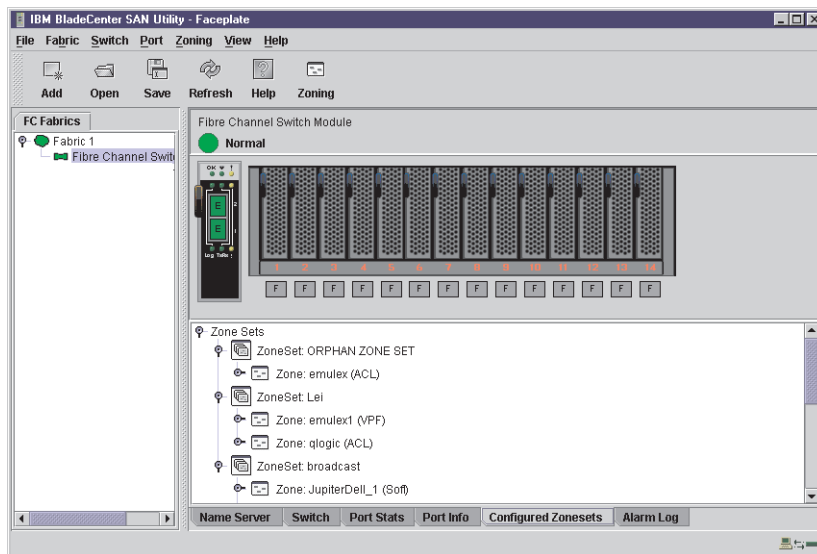

Figure 13. Zonesets Data window

The Configured Zonesets Data window uses display conventions for expanding and contracting entries that are similar to the fabric tree. An entry handle to the left of an entry in the tree indicates that you can expand the entry. Click this handle or double-click the following entries to expand or contract them:

- A zone set entry expands to show its member zones.

- A zone entry expands to show its members by port number, worldwide name, or Fibre Channel address.

Alarm Log Data window

The Alarm Log Data window displays switch module event information. To open the Alarm Log Data window, click the **Alarm Log** tab below the data window in the Faceplate window.

Managing alarms

You can configure the switch module to generate and log alarms. To display the Alarm Log, click the **Alarm Log** tab in the Faceplate window. For information about the alarm log, see “Alarm Log Data window”. You can also export the alarm log to a file in XML format.

Configuring alarms

Configuring an alarm involves choosing an event type, rising and falling thresholds, a sampling interval, and then enabling or disabling the alarm.

Complete the following steps to configure an alarm:

1. In the Faceplate window, click **Switch** → **Configure Alarm Thresholds**.
2. The Alarm Threshold Configuration window shown in Figure 14, prompts you to select an event, set thresholds, set a sampling interval, and enable or disable the alarm.

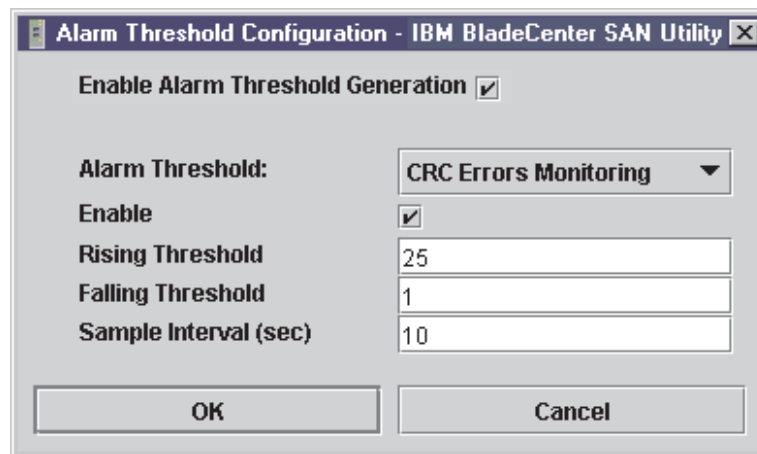

Figure 14. Alarm Threshold Configuration window

3. Select an event type from the **Alarm Threshold** pull-down menu. Choose from the following options:
 - CRC error monitoring
 - Decode error monitoring
 - ISL monitoring
 - Login monitoring
 - Logout monitoring
 - Loss of signal monitoring
4. Enter a value in the **Falling Threshold** field. The falling threshold is the event count above which an event becomes eligible for logging in the alarm log.
5. Enter a value in the **Rising Threshold** field. The rising threshold is the event count above which an event is logged. After the count exceeds the rising

threshold, one alarm is logged. The switch module will not generate another alarm for that event until the count falls below the falling threshold and rises again above the rising threshold.

6. Enter a sample interval, in milliseconds. The sample interval defines the period of time in which to count events.
7. Select the **Enable** check box to make the alarm eligible for use.
8. Repeat step 3 on page 101 through step 7 for each alarm you want to configure or enable.
9. Select the **Enable Alarm Threshold Generation** check box to activate all alarms enabled in step 7.
10. Click **OK** to save all changes.

Exporting alarm log information to a file

Complete the following steps to save the switch module alarm log to a file:

1. In the Faceplate window, click **Switch** → **Export Alarm Log**.
2. Type a file name in the Save window.
3. Click **Save**.

Exporting name server information to a file

Complete the following steps to save switch module name server information to a file:

1. In the Topology window, click **Switch** → **Export Name Server**.
2. Type a file name in the Save window.
3. Click **Save**.

Paging a switch module

You can use the beacon feature to page a switch module. The beacon feature causes both external port Logged-in LEDs to flash, making it easier to locate the switch module you are paging. To page a switch, in the Faceplate window, click **Switch** → **Toggle Beacon**. To cancel the beacon, click **Toggle Beacon**.

Setting the date and time

Complete the following steps to set the date and time on a switch module:

1. Select a switch in the Topology window and open the Faceplate window.
2. In the Faceplate window, click **Switch** → **Set Date/Time**
3. Type the **year**, **month**, **day** and **time** in the Switch Date and Time window, and then click **OK**. The system prompts you to reset the switch module to implement the new date and time.

Resetting a switch module

Resetting a switch module restarts the switch using configuration parameters in memory. You can reset a switch module using the following methods:

- Select the switch module to be reset in the fabric tree. Click **Switch** → **Reset Switch**.
- Remove and then reinsert the Fibre Channel switch module in the BladeCenter unit.

Configuring a switch module

The SAN Utility is used to configure the switch module. Switch module configuration is divided into two areas: chassis configuration and network configuration. Chassis

configuration specifies parameters that relate to switch module identity on the Fibre Channel network. Network configuration specifies parameters that relate to switch module identity on the Ethernet network. To open the Switch Properties window, click **Switch** → **Switch Properties**. You can also right-click a switch graphic in the Topology window or Faceplate window and click **Switch Properties**.

Switch module properties

Use the Switch Properties window shown in Figure 15 to change the module name, administrative state and domain ID; to enable or disable broadcast support; and to enable or disable inband management. The timeout values are displayed for reference purposes only when the switch module is online. These fields become active when the switch module is taken offline. After making changes, click **OK** to put the new values into effect.

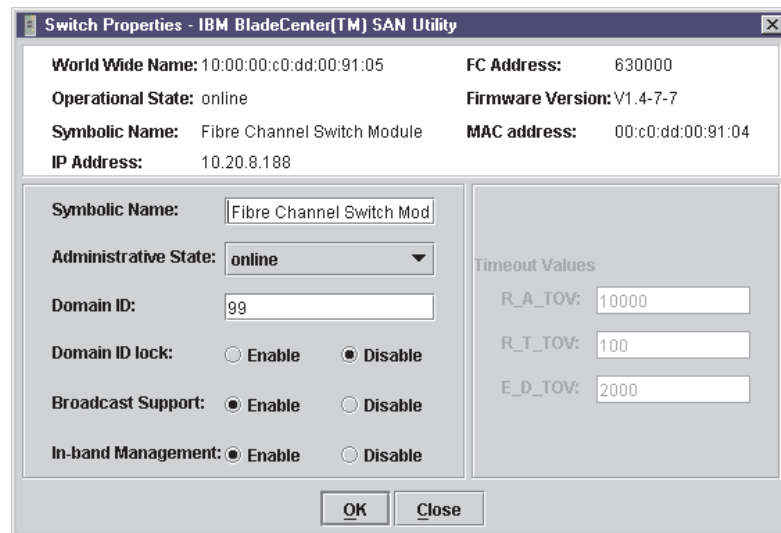

Figure 15. Switch Properties window

Symbolic name: The symbolic name is a user-defined name that identifies the switch module.

Switch module administrative state: The switch module administrative state determines the operational state of the switch and its ports. The switch module administrative state exists in two forms: the configured administrative state and the current administrative state. The configured administrative state is the state that is saved in the switch configuration and is preserved across switch resets. The SAN Utility always makes changes to the configured administrative state. The current administrative state is the state that is applied to the switch module for temporary purposes and is not retained across switch resets. The current administrative state is set using the **Set Switch** command. For more information about the Set Switch command, see “Set command” on page 26.

Table 21. Switch module administrative states

Parameter	Description
Online	The switch module is available.
Offline	The switch module is unavailable.
Test	The switch module is in diagnostics mode and is unavailable.

Domain ID and Domain ID Lock

The domain ID is a unique Fibre Channel identifier for the switch module. The Fibre Channel address consists of the domain ID, port ID, and the Arbitrated Loop Physical Address (ALPA). The maximum number of switch modules within a fabric is 239, with each switch having a unique domain ID.

Switch modules come from the factory with the domain IDs unlocked. This means that if there is a domain ID conflict in the fabric, the switch module with the highest principal priority, or the principal switch, will reassign any domain ID conflicts and establish the fabric. If you lock the domain ID on a switch module and a domain ID conflict occurs, the switch module with the higher WWN will be isolated as a separate fabric, and the Logged-in LEDs on both switch modules will flash to show the affected ports. See “Set Config command” on page 28 for information about the switch module keyword and the Domain ID Lock and Principal Priority parameters.

If you connect a new switch module to an existing fabric with its domain ID unlocked and a domain conflict occurs, the new switch module will be isolated as a separate fabric. However, you can remedy this by resetting the new switch module or taking it offline then back online. The principal switch module will reassign the domain ID, and the switch will join the fabric.

Note: Domain ID reassignment is not reflected in zoning that is defined by domain ID and port number pair. You must reconfigure zones that are affected by domain ID reassignment.

Broadcast support

Broadcast is supported by the switch module, which enables TCP/IP support. Broadcast is implemented using the proposed standard specified in Multi-Switch Broadcast for FC-SW-3, T11 Presentation Number T11/02-031v0. The FSPF is used to set up a fabric spanning tree used in transmission of broadcast frames. Broadcast frames are retransmitted on all ISLs indicated in the spanning tree and all online F/FL_Ports. Broadcast zoning is supported with ACL and VPF hard zones. When a broadcast frame is received, these hard zones are enforced at the F/FL_Port. If the originator of the broadcast is in a hard zone, the frame is retransmitted on all online F/FL_Ports within the hard zone. If the originator of the broadcast frame is not in a hard zone, the frame is retransmitted on online F/FL_Ports that are not in a hard zone.

In-band management

In-band management is the ability to manage switch modules across interswitch links. If you disable in-band management on a particular switch module, you can no longer communicate with that switch module by means other than a direct Ethernet or serial connection.

Timeout values

The switch module timeout values determine the timeout values for all external ports on the switch. Table 22 on page 105 describes the switch module timeout parameters. R_A_TOV, R_T_TOV, or E_D_TOV values must be the same for all switch modules in the fabric.

Note: Timeout values can be changed only if the switch module operational state is offline.

Table 22. Timeout values

Parameter	Description
R_A_TOV	Resource Allocation Timeout. Represents the maximum time a frame can be delayed in the fabric and still be delivered. The default is 10000 milliseconds.
R_T_TOV	Receiver Transmitter Timeout. The amount of time that Sync can be lost between two ports before Link Failure is detected. The default is 100 milliseconds.
E_D_TOV	Error Detect Timeout. Represents the maximum round trip time that an operation between two N_Ports requires. The default is 2000 milliseconds.

Network properties

Use the Network Properties window shown in Figure 16 to change IP and SNMP configuration parameters. After making changes, click **OK** to put the new values into effect. To open the Network Properties window, click **Switch** → **Network Properties**.

Note: The Read Community, Trap Community, and Write Community settings are like passwords; therefore, they are write-only fields. The current settings are not displayed.

The screenshot shows the 'Network Properties - IBM BladeCenter(TM) SAN Utility' window. It contains several sections for configuration:

- World wide name:** 10:00:00:c0:dd:00:91:05
- Operational state:** online
- Symbolic name:** Fibre Channel Switch Module
- FC address:** 630000
- Firmware version:** V1.4-7-7
- MAC address:** 00:c0:dd:00:91:04
- IP configuration:**
 - IP address: 10.20.8.188
 - Subnet mask: 255.255.252.0
 - Boot method: static
 - Gateway: 10.20.8.254
- Enable Remote Logging (syslog):** Logging (syslog) Host IP Address: 10.0.0.254
- SNMP configuration:**
 - Contact: <sysContact undefined>
 - Location: <sysLocation undefined>
 - Read community: [empty field]
 - Trap community: [empty field]
 - Authentication trap: False
 - Write community: [empty field]
- SNMP Trap Configuration:**
 - Trap 1 enabled:
 - Trap Address: 10.0.0.1
 - Trap Port: 162
 - Trap Severity: Warning

At the bottom, there are buttons for 'OK' and 'Close', and a row of tabs for 'Trap 1' through 'Trap 5'.

Figure 16. Network Properties window

IP configuration

The IP configuration identifies the switch module on the Ethernet network and determines which start (boot) method to use. Start methods described in the following table are for external and internal ports. Table 23 on page 106 describes the IP configuration parameters.

Table 23. IP configuration parameters

Parameter	Description
IP address	Internet protocol (IP) address for the Ethernet port. Note: When the BladeCenter unit is turned on, the management module loads the following factory default Ethernet IP addresses: <ul style="list-style-type: none">• Switch module bay 3: 192.168.70.129• Switch module bay 4: 192.168.70.130
Subnet mask	Subnet mask address for the Ethernet port. The default value is 255.255.255.0.
Boot method	Static - Uses the IP configuration parameters entered in the Switch Properties window.
Gateway	IP gateway address. The default value is 10.90.90.254.

Remote logging

The Remote Logging (syslog) feature enables saving of the log information to a remote host that supports the syslog protocol. When enabled, the log entries are sent to the syslog host at the IP address that you specify in the **Logging Host IP Address** field. Log entries are saved in the internal switch module log whether this feature is enabled or not.

To save log information to a remote host, you must edit the `syslog.conf` file and then restart the syslog daemon. The `syslog.conf` file on the remote host must contain an entry that specifies the name of the log file in which to save error messages. Add the following line to the `syslog.conf` file:

```
local0.info <tab> /var/adm/messages.name
```

Use `<tab>` to separate the selector field (`local0.info`) and action field, which contains the log file path name (`/var/adm/messages/messages.name`).

Archiving a switch module

You can create an XML archive file containing the switch module configuration parameters. Archived parameters include the following:

- Switch module properties and statistics
- IP configuration
- SNMP configuration
- Port properties and statistics
- Zoning configuration

You can use this archive file to restore the configuration on the same switch module or on a replacement switch. You can also use the archive file as a template for configuring new switch modules to add to a fabric. Security settings and user account information are not archived. You can use the archive later to restore the switch module. For more information, see “Restoring a switch module” on page 126.

Complete the following steps to archive a switch module configuration:

1. In the Faceplate window, click **Switch** → **Archive**.
2. In the Save window, type a file name.
3. Click **Save**.

Managing firmware

The switch module memory is partitioned for two firmware images. This is useful when you are upgrading firmware so that both the old and new firmware are maintained on the switch module. When you load new firmware, the currently active firmware is preserved and the new firmware becomes the second image or the fallback version. You can activate either firmware image. If you activate the fallback firmware, the current firmware becomes the fallback version.

Loading firmware

The switch module does not have to be offline for you to download firmware. However, the switch module must be reset to activate the new firmware, which requires administrative authority. The SAN Utility prompts you to reset the switch module after the firmware is loaded.

Complete the following steps to load firmware to a switch module:

1. In the Faceplate window, click **Switch** → **Load Firmware**.
The Firmware Upload window opens.
2. In the Firmware Upload window, click **Select** to browse and select the firmware file to be uploaded.
3. Click **Start** to begin the firmware install process.
4. When the installation is complete, click **Close**. The Firmware Upload window closes.
5. The SAN Utility prompts you to reset the switch module. Click **OK** to reset the switch and activate the new firmware.

Activating the fallback firmware

Complete the following steps to activate the fallback firmware:

1. In the Faceplate window, click **Switch** → **Firmware Fallback**.
2. The Firmware Fallback window displays the file name of the current firmware and the fallback firmware versions. Click **Yes** to select the fallback firmware or **No** to cancel.
3. The SAN Utility prompts you to reset the switch module. Click **OK** to reset the switch and activate the new fallback firmware.

Managing ports

This section describes the following tasks that manage ports and devices:

- Displaying port information
- Configuring ports

Displaying port information

Port information is available primarily in the Faceplate window shown in Figure 17 on page 108. Faceplate Display Data windows provide information and statistics for switch modules and ports. Use the Topology window to show the status information for links between switch modules.

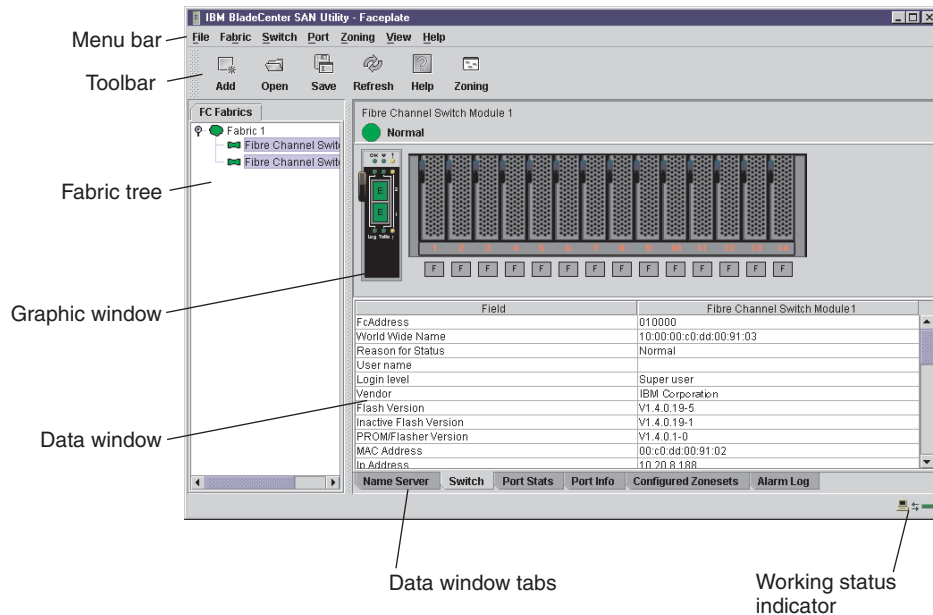

Figure 17. Faceplate Display Data window

Monitoring port status

The Faceplate window provides the following port related information:

- SNMP configuration (see “Fibre Channel switch module monitoring using SNMP” on page 124 for more information)
- Port mode
- Port operational state
- Port speed
- Port media

To display port number and status information for a port, position the cursor over a port displayed in the Faceplate window. The status information changes, depending on the View menu option that you select.

Displaying port modes: To display port mode status, from the Faceplate window, click **View** → **View Port Modes**. Table 24 lists the available port modes and their descriptions.

Table 24. Port mode descriptions

Mode	Description
F	Fabric port
FL	Fabric loop port
TL	Translated loop port
G	Generic port
GL	Generic fabric loop port
E	Expansion port
D	Donor port

Displaying port operational states: To display the operational state of each port, in the Faceplate window, click **View** → **View Port States**. Table 25 lists and describes the available operational states. The port operational state refers to the actual port state and not the administrative state you might assign.

Table 25. Port operational states

State	Description
On	Online - The port is active and ready to send data.
la	Inactive - The port operational state is Offline, but the administrative state is Online.
Off	Offline - The port is active and can receive a signal but cannot accept a device login.
Tst	Diagnostics - The port is in Diagnostics mode in preparation for testing.
Dn	Down – The port is inactive or disabled; it is not receiving a signal and cannot be logged in to.



Displaying port speeds: To display the speed of each port in the Faceplate window, click **View** → **View Port Speeds**. Table 26 lists the available speeds.

Table 26. Port speeds

State	Description
1 Gb	1 Gbps (gigabits per second) transmission speed
2 Gb	2 Gbps transmission speed

Displaying SFP module media status: To display SFP module media status, click **View** → **View Port Media**. Table 27 lists and describes the available media states.

Table 27. SFP module media view

Media icon	Description
	The SFP module is online (green)
	The SFP module is offline (gray)
None	The port is empty; no SFP module is detected or installed

Port graphing and Fabric View application

You can use the Fabric View application to view port performance as graphs. The Fabric View window displays data communication rates and total errors for selected ports as shown in Figure 23 on page 127. You can graph communication data rates using either frames per second or KB per second. For more information about port graphing, see “Using the Fabric View application” on page 126.

Port Statistics Data window

The Port Statistics Data window displays statistics about port performance. To open the Port Statistics Data window, select one or more ports in the Faceplate window and click the **Port Stats** tab in the data pane of the Faceplate window. Table 28 describes the Port Statistics Data window entries. See Table 37 on page 131 for information about port numbering and mapping.

The Statistics menu is available on the Port Statistics Data window. Click the down arrow to open the Statistics menu and then use one of the following methods to view the detailed port information:

- Click **Absolute** to view the total count of statistics since the last switch module reset.
- Click **Rate** to view the number of statistics counted per second over the polling period.
- Click **Baseline** to view the total count of statistics since the last time the baseline was set.

When viewing baseline statistics, click **Clear Baseline** to set the current baseline.

Table 28. Port Statistics Data window entries

Entry	Description
Start time	The beginning of the period of time for which the statistics apply. The start time for the Absolute view is not applicable. The start time for the Rate view is the beginning of the polling interval. The start time for the Baseline view is the last time the baseline was set.
End time	The last time the statistics were updated on the display.
Total time	Total time period from start time to end time.
Login count	Number of logins that have occurred on the switch module.
Logout count	Number of logouts that have occurred on the switch module.
AI init count	Number of times the port entered the initialization state.
Invalid destination address	Number of address identifiers (S_ID, D_ID) found to be in error.
Total LIP received	Number of loop initialization primitive frames received.
LIP F7F7 count	A loop initialization primitive frame used to acquire an Arbitrated Loop Physical Address (AL_PA).
LIP F8F7 count	Currently not used.
LIP F7AIPs count	This LIP is used to reinitialize the loop. An L_Port, identified by AL_PS, might have noticed a performance degradation and is trying to restore the loop.
LIP F8AIPs Count	This LIP denotes a loop failure detected by the L_Port identified by AL_PS.
LIP AIPdAIPs Count	Number of F7, AL_PS LIPs, or AL_PD (vendor specific) resets, performed.
Class 2 In Frames	Number of class 2 frames received by this port.
Class 2 Out Frames	Number of class 2 frames transmitted by this port.
Class 2 Words In	Number of class 2 words received by this port.
Class 2 Words Out	Number of class 2 words transmitted by this port.
Class 3 In Frames	Number of class 3 frames received by this port.
Class 3 Out Frames	Number of class 3 frames transmitted by this port.

Table 28. Port Statistics Data window entries (continued)

Entry	Description
Class 3 Words In	Number of class 3 words received by this port.
Class 3 Words Out	Number of class 3 words transmitted by this port.
Decode Error Count	Number of invalid transmission words detected during decoding. Decoding is from the 10-bit characters and special K characters.
Loss Of Sync Count	Number of synchronization losses (>100 ms) detected by this port. A loss of synchronization is detected by receipt of an invalid transmission word.
Invalid CRC Count	Number of invalid CRC frames detected.
Tx Wait Count	Number of times the port entered a wait state because it was out of buffer-to-buffer credits.
Class 3 Toss Count	Number of class 2 and class 3 sequences that were discarded by this port. A sequence can be discarded because of detection of a missing frame (based on SEQ_CNT), detection of an E_D_TOV timeout, receiving a reject frame, receiving frames for a stopped sequence, or other causes.
FReject Count	Number of frames, from devices, that have been rejected. Frames can be rejected for many reasons.
FBusy Count	Number of class 2 and class 3 fabric busy (F_BSY) frames generated by this port in response to incoming frames. This usually indicates a busy condition on the fabric or N_Port that is preventing delivery of this frame.
Link Failures	Number of optical link failures detected by this port. A link failure is a loss of synchronization for a period of time greater than the value of R_T_TOV or by loss of signal while not in the offline state. A loss of signal causes the switch module to attempt to reestablish the link. If the link is not reestablished by the time specified by R_T_TOV, a link failure is counted. A link reset is performed after a link failure.
Primitive Sequence Errors	Number of bad primitives received by the port.
Rx Link Resets	Number of link reset primitives received from an attached device.
Tx Link Resets	Number of link reset primitives sent from this port to an attached port.
Rx Offline Sequences	Number of offline sequence primitives received by the port.
Tx Offline Sequences	Number of offline primitives transmitted by the port.
Total Errors	Total number of primitive and nonprimitive port link errors.
Total Tx Frames	Total number of frames transmitted by the port.
Total Rx Frames	Total number of frames received by the port.
Total Tx Words	Total number of words transmitted by the port.
Total Rx Words	Total number of words received by the port.
Total Link Resets	Number of link-reset primitives that are transmitted by the port.
Total Offline Sequences	Total number of offline sequences transmitted and received by the port.

See Table 37 on page 131 for information about port numbering and mapping.

Port Information data window

The Port Information data window displays port detail information for the selected port. To open the Port Information data window, click the **Port Info** tab below the data window in the Faceplate window.

Table 29. Port Information Data window entries

Entry	Description
Port Address	Port Fibre Channel address.
Administrative Port Mode	The current administrative port mode: GL, G, FL, F, TL.
Operational Port Mode	The operational port mode.
Administrative Port State	The current administrative port state: online, offline, diagnostics, or down.
Operational Port State	The operational port state.
Configured Administrative Port State	The port administrative state that is stored in the switch module configuration.
Logged In	Indicates whether logged in or not.
E Port Connection Status	Indicates whether the E_Port connection is enabled.
E Port Isolation Reason	Indicates why the E_Port is isolated.
MFS Mode	Port tuning indicator.
I/O Stream Guard	Whether RSCN suppression is enabled or disabled.
Administrative Port Speed	The speed requested by the user.
Operational Port Speed	The speed actually used by the port.
TLMode	Indicates if TL target or TL initiator is used.
BB Credits	Indicates whether the buffer-to-buffer credits are set.
Ext Credits Requested	Indicates whether the extended credits are requested for ports.
Medium	The SFP module type.

Name Server Data window

The Name Server Data window displays information about the port and the connected device. To open the Name Server Data window, select one or more switch modules in the Topology window and click the **Name Server** tab below the data window. You can also open the Name Server Data window in the Faceplate window. See Table 19 on page 98 for a description of the Name Server Data window entries.

Configuring ports

Note: For external ports (0, 15), all port parameters apply. For internal ports, only the port state setting is configurable.

The external Fibre Channel ports are self-configuring GL_Ports that auto-negotiate transmission speeds of 1 Gbps or 2 Gbps depending on the connected device. A GL_Port connects to a loop of public devices or a single device and configures itself as a fabric loop port (FL_Port), fabric port (F_Port), or an expansion port (E_Port). Each external port has 12 buffer credits. This enables a cable length up to 20 km at 1 Gbps or 10 km at 2 Gbps. Eleven credits from one port can be borrowed by the other port to extend transmission distances.

The buffer credit flow control mechanism provides a way to ensure full use of the media, regardless of length, by providing for frame streaming. With frame streaming, the sender can transmit as many frames as there are credits without having to wait for a response to one frame before transmitting the next frame. The media can then be continuously in use at its rated capacity.

The external port (0,15) settings or characteristics are configured using the Port Properties window shown in Figure 18. To open the Port Properties window, select one or more external ports and click **Port** → **Port Properties**.

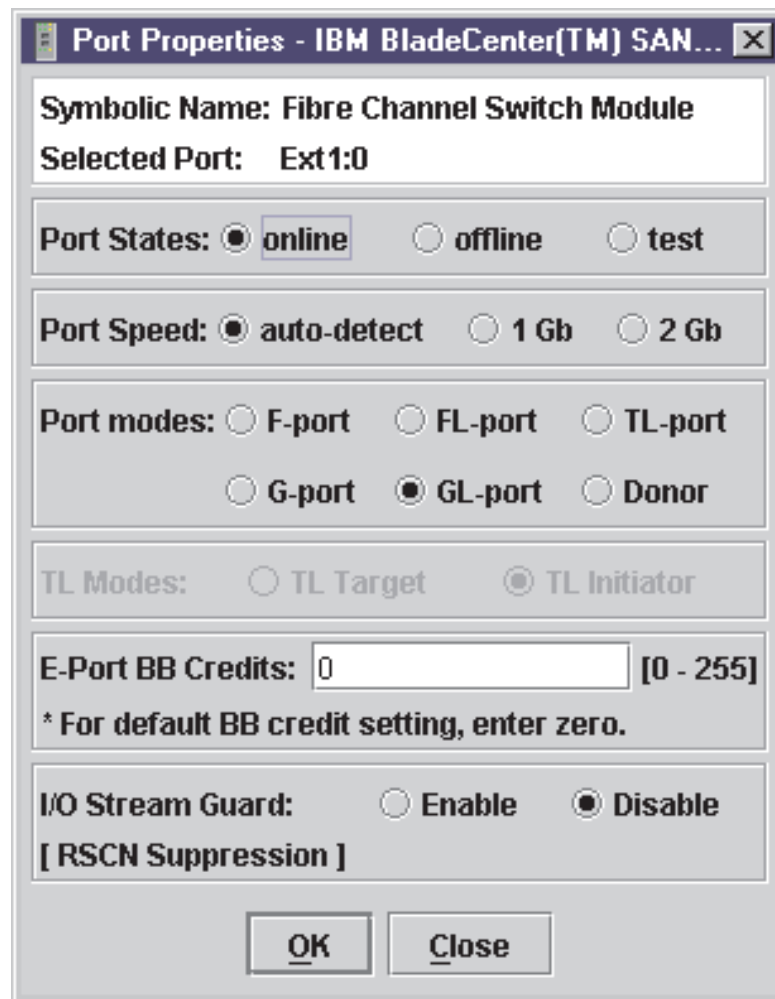

Figure 18. External Port Properties window

The Port Properties window displays the switch module name and the selected external ports. Use the Port Properties window to change the following parameters:

- Port state
- Port speed
- Port mode
- TL mode
- Port buffer credits
- I/O stream guard (RSCN suppression)

Internal port (1 through 14) configuration is limited to the port state as shown in Figure 19. To open the Port Properties window, select one or more internal ports and click **Port** → **Port Properties**.

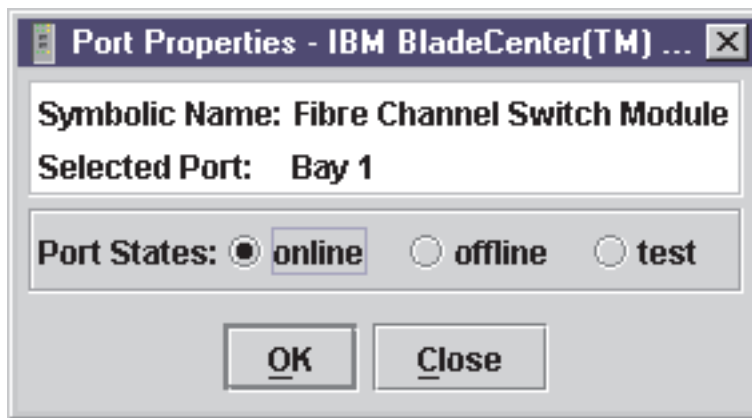

Figure 19. Internal Port Properties window

Changing port administrative states

The Port Administrative state determines the operational state of a port. The port administrative state exists in two forms: the configured administrative state and the current administrative state.

The Configured Administrative state is the state that is saved in the switch module configuration and is preserved across switch module resets. The SAN Utility always makes changes to the configured administrative state.

The Current Administrative state is the state that is applied to the port for temporary purposes and is not preserved across switch module resets. The current administrative state is set using the **Set Port** command. See “Set Port command” on page 36 for more information. See Table 30 for additional port administrative state descriptions.

The Port Administrative state determines the internal and external port operational state. The port administrative state refers to the requested state in the SAN Utility or through a Telnet command. The port operational state refers to the state actually used by the port.

Complete the following steps to change the port administrative state:

1. Select one or more ports in the Faceplate window.
2. Click **Port** → **Port Properties**.
The Port Properties window opens.
3. Click the **Port States** that corresponds to the port state you want.
4. Click **OK** to write the new port state to the switch module.

Table 30. Port administrative states

State	Description
Online	Activates and prepares the port to send data.
Offline	The port cannot receive a signal or accept a device login.
Test	Prepares a port for testing and prevents the port from accepting a device login.

Changing port speeds (external ports only)

The switch module external ports (0,15) are capable of transmitting and receiving at 1 Gbps or 2 Gbps. The ports are configured for either transmission speed or to sense the transmission speed of the device to which it is connected. Internal ports (1 through 14) are fixed at 2 Gbps. Table 31 describes the port speeds. Complete the following steps to change the port speed:

1. Select one or more ports in the Faceplate window.
2. Click **Port** → **Port Properties**.
3. Select the speed that you want.
4. Click **Apply** to write the new port speed to the switch module.

Table 31. Port speeds

State	Description
Auto-detect	Matches the transmission speed of the connected device. Auto-detect is the default.
1 Gb	Sets the transmission speed to 1 Gbps.
2 Gb	Sets the transmission speed to 2 Gbps.

Changing port modes (external ports only)

The switch module external ports (0,15) support both public and private devices as single devices or in loops. External ports can be configured to self-discover the proper mode to match the device or switch module to which it is connected. Internal ports (1 through 14) are fixed as F_Ports. Table 32 describes the port modes. Complete the following steps to change the port mode:

1. Select one or more ports in the Faceplate window.
2. Click **Port** → **Port Properties**.
The Port Properties window opens.
3. Select the Port Mode speed that you want.
4. Click **OK** to write the new port mode to the switch module.

Table 32. Port modes

State	Description
F_Port	Fabric port - Supports a single public device (N_Port).
FL_Port	Fabric loop port - Supports a loop of up to 126 public devices (NL_Port).
TL_Port	Translated loop port - Supports a loop of up to 124 private target devices or 125 private initiator devices capable of communicating with up to 63 off-loop initiator devices or 64 off-loop target devices.
G_Port	Generic port - Self-discovers as an F_Port or an E_Port.
GL_Port	Generic loop port - Self-discovers as an F_Port, FL_Port, or an E_Port.
Donor	Donor port - Allows buffer credits to be used by another port.

Configuring translated loop (TL) modes (external ports only)

You can configure an external (0,15) TL_Port to support a loop of private target devices or a loop of private initiator devices.

- For a loop of up to 124 private target devices, click **TL Target**. This enables up to 63 initiator devices anywhere in the fabric to automatically connect with the private devices on the TL_Port. Group the TL_Port and up to 63 initiators in the

same soft or ACL zone using the worldwide name or domain ID and port ID membership, to limit the number of possible initiators to 63.

- For a loop of up to 125 private initiator devices, click **TL Initiator**. This enables the private initiators on the TL_Port to automatically connect to up to 64 target and initiator devices in the same soft or ACL zone. You must group the TL_Port and the target devices in the same soft or ACL zone using the worldwide name or domain ID and port ID membership. If there are more than 65 members in the zone, the TL_Port is unable to communicate with the fabric.

Changing buffer-to-buffer credits (external ports only)

Each switch module external port (0,15) has a receive buffer capacity of 12 Fibre Channel frames or credits, which is equal to approximately 24 KB. Port buffer credits can be changed on ports to accommodate connections to other switch modules that have different port buffer capacities. Complete the following steps to change external port buffer credits:

1. Select one or more ports in the Faceplate window.
2. Click **Port → Port Properties**.
3. In the **E_Port BB Credits** field, type the new number.
4. Click **OK** to write the new buffer-to-buffer setting to the switch module.

I/O stream guard

The I/O Stream Guard feature suppresses registered state control notification (RSCN) messages on external ports (0,15).

Extending port credits

Each external port (0,15) is supported by a data buffer with a 12-credit capacity; that is, 12 maximum sized frames. For fiber-optic cables, this enables full bandwidth class 2 service over a distance of 20 km (12.4 mi) at 1 Gbps (0.6 credits per km), or 10 km (6.2 mi) at 2 Gbps (1.2 credits per km). Longer distances can be spanned at full bandwidth by borrowing credits from designated donor ports; therefore, pooling the buffer capacities. This is called *credit extension*. Each donor port contributes 11 credits to the pool from which the recipient ports can draw. Only external ports (0,15) can be donor or recipient ports. For example, one donor port contributes 11 credits to the pool from which a recipient draws for a total of 23 credits (11+12). This provides approximately 38 Km (23.6 mi) at 1 Gbps (23÷0.6) or 19 km (11.8 mi) at 2 Gbps (23÷1.2).

Complete the following steps to extend port buffer credits:

1. In the Faceplate window, select the ports that are to serve as donor ports. Click **Port → Port Properties**. In the Port Properties window, click **Donor → OK**.

Note: Donor ports are incapable of transmitting or receiving data.

2. In the Faceplate window, select the recipient port. Recipient ports must be external ports configured as G_Ports or F_Ports. Click **Port → Extended Credits**. The Extended Credits window opens as shown in Figure 20 on page 117.

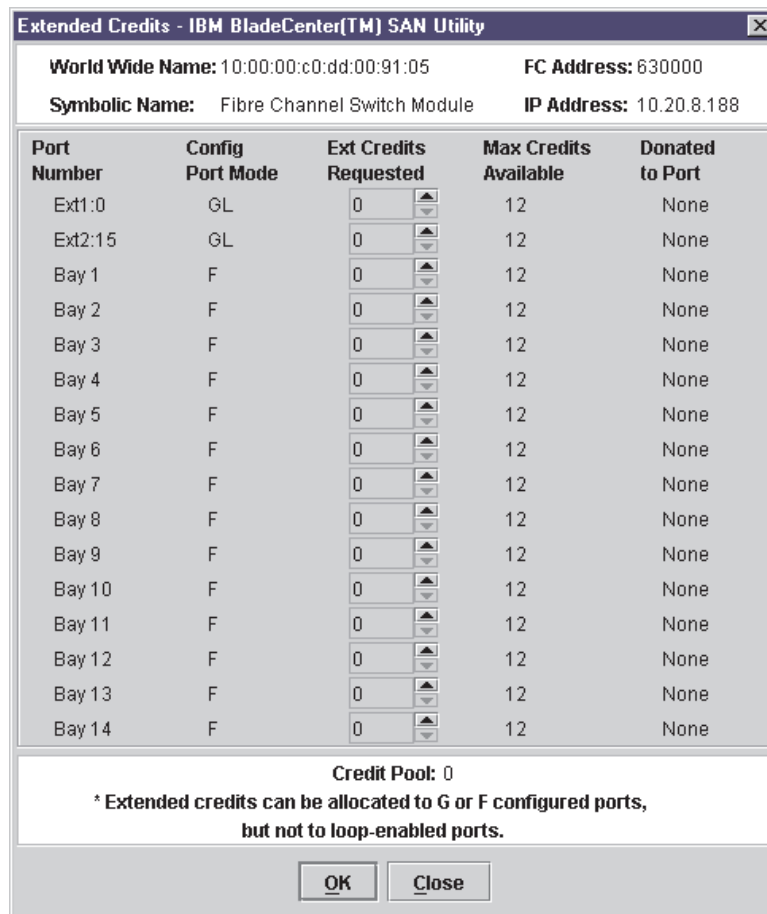

Figure 20. Extended Credits window

3. Distribute the borrowed credits by incrementing the **Ext Credits Requested** field for the recipient ports up to the total credits in the pool. Click **OK**. If you exceed this total, a message is entered in the alarm log indicating that some recipient ports did not receive the requested credits.
4. To confirm that the requested credits were received, reopen the Extended Credits window and match the number of credits in the **Ext Credits Requested** column with the number in the **Donated to Port** column.

Note: As credits are used, the Logged-in LEDs on the corresponding donor ports are lit continuously. In addition, donor port Activity LEDs will reflect the same traffic as the recipient port. Donor ports whose credits are being used are unavailable to devices that are connected to them.

Resetting a port

The Reset Port option reinitializes the port using configuration parameters stored in memory. Complete the following steps to reset a port:

1. In the Faceplate window, select the ports to be reset.
2. Click **Port** → **Reset Port**.

To run an internal, external, or online port loopback test on an external port, see “Port testing” on page 122.

Chapter 4. Switch management utility functions

This chapter contains information about the following topics:

- LED diagnostics
- Port testing
- Fibre Channel switch module monitoring using SNMP
- Restoring Fibre Channel switch module configuration defaults
- Using the Fabric View application

LED diagnostics

The BladeCenter Fibre Channel switch module performs a POST as part of its power-on procedure. The POST diagnostic program performs the following tests:

- Checksum tests on the boot firmware in PROM and the switch module firmware in flash memory Internal data loopback test on all ports
- Access and integrity test on the switch module ASIC

During the POST, the switch module logs any errors encountered. Some POST errors are fatal; others are non-fatal. The switch module uses the heartbeat LED and the logged-in LED to indicate switch and port status. A fatal error disables the switch module so that it will not operate. If a non-fatal error occurs, the switch module can still operate but disables the ports that have errors. Regardless of whether the problem is fatal or nonfatal, contact your IBM technical support representative.

If there are no POST errors, the heartbeat LED flashes at a steady rate of once per second. If a fatal error occurs, the heartbeat LED will show an error flash pattern. If there are non-fatal errors, the switch module disables the failed ports and flashes the associated logged-in LEDs. See “Heartbeat LED patterns” on page 120 for more information about heartbeat LED flash patterns.

There are three sets of LEDs on the information panel. The first row of LEDs at the top of the switch module represent switch module status and include OK, ♥ (heartbeat), and ! (Fibre Channel switch fault). The second and third sets of LEDs represent status for external Fibre Channel port 2 and external Fibre Channel port 1. The port LEDs include port logged-in, port activity, and port fault. Figure 21 on page 120 shows the location of these LEDs on the switch module. For more information about switch module LEDs, see the IBM *@server BladeCenter 2-Port Fibre Channel Switch Module Installation Guide*.

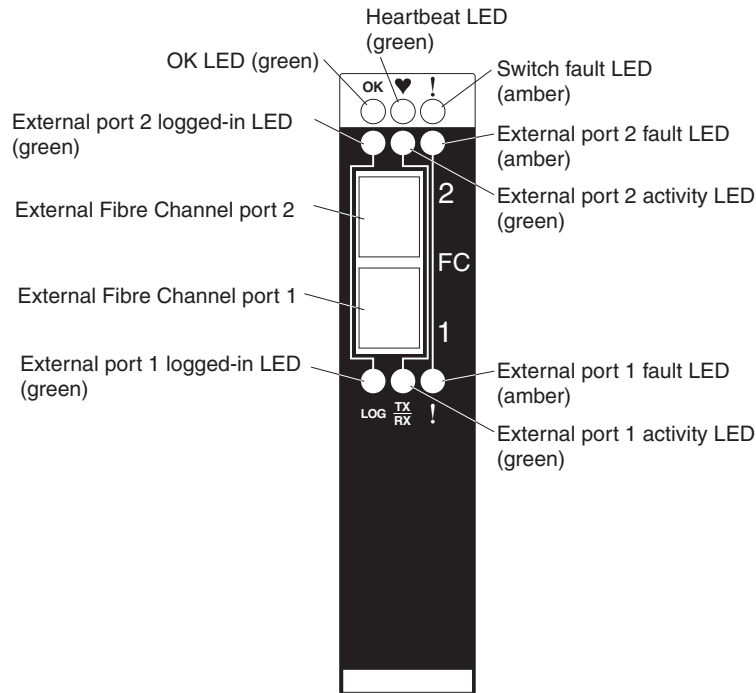

Figure 21. Switch module LEDs

Heartbeat LED patterns

The heartbeat LED uses different flash patterns to indicate the following conditions:

- Normal
- Internal firmware failure
- Fatal error
- Configuration file system error

Normal (all pass) LED flash pattern

If POST diagnostics pass and the switch module processor is operating correctly, the switch will go to normal operation, and the heartbeat LED will flash at a steady rate of one flash per second.

Internal firmware failure LED flash pattern

An internal firmware failure flash pattern is two flashes per second followed by a 2-second pause, as shown in the following illustration. The two-flash error pattern indicates that the firmware has failed and that the switch module must be reset.

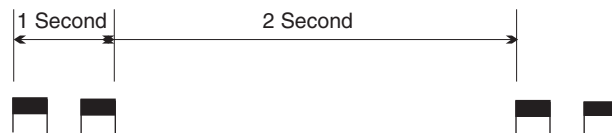

Fatal error LED flash pattern

A fatal error flash pattern is three flashes per second followed by a 2-second pause, as shown in the following illustration. The three-flash error pattern indicates that a fatal error has made the switch module inoperable. If a fatal error occurs, contact

your IBM technical support representative.

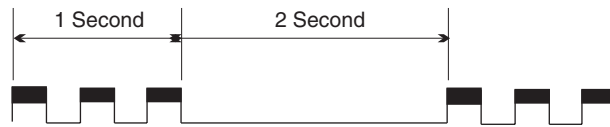

Configuration file system error LED flash pattern

A configuration file system error flash pattern is four flashes per second followed by a 2-second pause, as shown in the following illustration. The four-flash error pattern indicates that a configuration file system error has occurred.

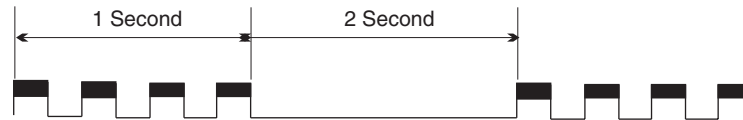

Switch module fault LED flash pattern

The amber Switch Fault LED is lit to indicate one or more of the following conditions:

- POST failure
- Over temperature condition
- Port operational test failure. See “Port fault LED flash patterns” on page 122 for information about port operational tests.

If the Switch Fault LED is lit for reasons other than a port operational test failure, take the BladeCenter Fibre Channel switch module offline and contact your IBM technical support representative.

Switch module OK LED

The green OK LED is lit to indicate that the switch module has completed POST diagnostics without errors. If this LED is not lit when you turn on the BladeCenter unit or turns off during operation, remove the switch module and inspect the connector for damage.

Port logged-in LED flash patterns

The Port Logged-in LED has the following flash patterns:

- Logged in - The logged-in LED is lit continuously.
- Logging in - The logged-in LED flashes at once per second as shown in the following illustration.
- Set beacon - Enables or disables the flashing of the Port Logged-in LEDs according to [state]. For information about the set beacon command, see “Set command” on page 26.
- Error - The logged-in LED flashes at twice per second as shown in the following illustration.

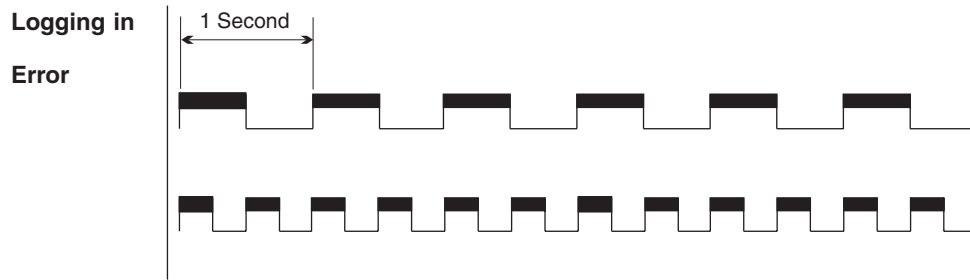

A logged-in LED error indication is often the result of E_Port isolation. Table 33 describes the causes and remedies for E_Port isolation conditions. An isolated E_Port is indicated by a red link in the Topology window. See “Timeout values” on page 104, “Domain ID and Domain ID Lock” on page 104, and “Zoning a fabric” on page 86, for information about how to set IDs, timeout values, and edit zoning.

Table 33. E-port isolation causes and fixes

Isolation cause	Fix
Two switch modules in the same fabric have the same domain ID	Correct the domain IDs on the malfunctioning switch modules. Domain IDs are decimal numbers in the range from 1 to 239. Domain IDs must be unique.
All switch modules in the fabric do not have the same timeout values	Correct the timeout values on the malfunctioning switch modules.
When merging two fabrics, the active zone sets contain zones with the same names but different membership.	Deactivate one of the active zone sets or edit the conflicting zones so that their membership is the same. The conflicting zones have the same name but different membership. Take the affected ports offline then back online to restore the interswitch links.

Port fault LED flash patterns

The amber port fault LED is lit to indicate that the port has failed one of the following port operational tests performed with the SAN Utility or the CLI:

- Internal
- External
- Online

If the port fault LED is lit, take the port offline and contact your IBM technical support representative.

Port testing

The port loopback tests verify correct port operation by sending a test data frame out through the loop and then verifying that the frame received matches the frame that was sent. You can perform the following port tests from the Port Loopback window:

- Internal SerDes test (internal and external ports) - The SerDes (serializer/deserializer) level test verifies internal and external port circuitry. The SerDes level test sends a test frame from the ASIC through the SerDes chip and back to the ASIC for the selected internal ports. The port passes the test if the frame that was sent by the ASIC matches the test frame that was received.

Note: A loopback plug is required to perform an external SFP test.

- External SFP test (external ports only) - The SFP level test also verifies port circuitry. The SFP level test sends a test frame from the ASIC through the SerDes chip, through the SFP module fitted with the loopback plug, and back to the ASIC for the selected external ports. The external port passes the test if the test frame that was sent by the ASIC matches the test frame that was received.
- Online node-to-node test (internal ports) - The node-to-node test verifies communications between the port and its device node or device loop. The port being tested must be online and connected to a device. The port passes the test if the test frame that was sent matches the test frame that was received.

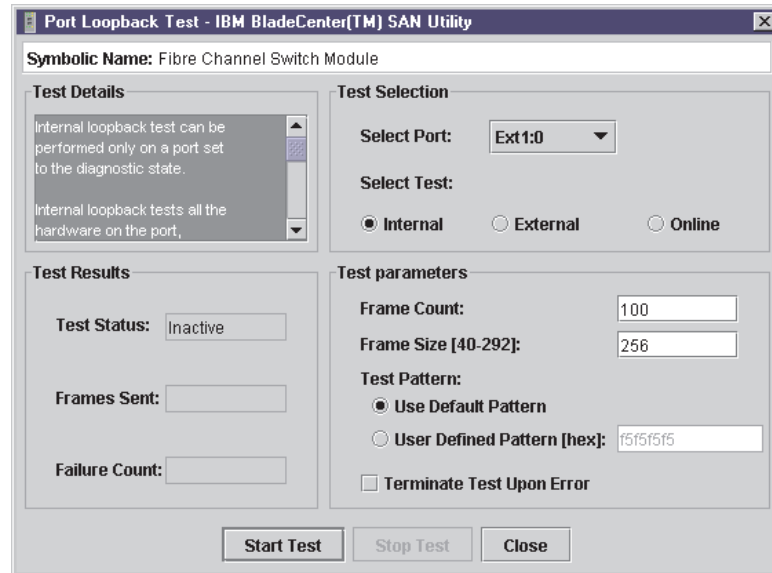

Figure 22. Port Loopback Test window

Note: The internal SerDes and external SFP level tests disrupt communication on the selected port. The online node-to-node level test does not disrupt communication, because it requires that the port is online.

Complete the following steps to run the internal, external, or online port loopback test on an external port:

1. In Faceplate window, select the external port to be tested.
2. Click **Port** → **Port Loopback Test**.
The Port Loopback Test window opens.
3. In the test selection pane, select the type of loopback test (internal, external, or online) to be run. If you want to run the internal or external test, the SAN Utility prompts you to confirm that the port state needs to be changed to the diagnostic state. Click **OK**. The SAN Utility changes the port state.
4. Type the frame count, frame size, and select a test pattern. You can use the default pattern or type an 8-digit pattern (hexadecimal). For online tests, click the **Terminate Test Upon Error** check box if you want the test to stop when encountering an error.
5. Click **Start Test** to begin the test. The test results pane displays the test status, number of frames sent, and number of errors found.

Fibre Channel switch module monitoring using SNMP

This section describes SNMP configuration and trap parameters. The switch module SNMP agent enables external network management monitoring and notification of switch module status.

SNMP configuration

SNMP configuration defines how authentication traps are managed. Table 34 describes the SNMP configuration parameters.

Table 34. SNMP configuration parameters

Parameter	Description
Contact	Specifies the name of the person to contact for trap events. The default is undefined.
Read community	Read Community Authentication. A write-only field; the value on the switch module and the SNMP management server must be the same. The default value is Public.
Trap community	Trap Community Authentication. A write-only field; the value on the switch module and the SNMP management server must be the same. The default value is Public.
Location	Specifies the switch module location. The default is undefined.
Authentication trap	Enables or disables the reporting of SNMP authentication failures. If enabled, and the incorrect community string values are used, an authentication failure event occurs and a notification trap is sent to the configured trap addresses. The default value is False.
Write community	Write Community Authentication. A write-only field; the value on the switch module and the SNMP management server must be the same. The default value is Private.

SNMP trap configuration

The SNMP trap configuration defines how traps are set. Table 35 describes the SNMP trap configuration parameters.

Table 35. SNMP trap configuration parameters

Parameter	Description
Trap enabled	Select this check box to enable or disable the trap.
Trap address	Specifies the IP address to which SNMP traps are sent. The default is 10.0.0.1 for trap 1 and 0.0.0.0 for traps 2–5. A maximum of five trap addresses are supported.
Trap port	The port number on which the trap is set.
Trap severity	Specifies a severity level to assign to the trap. Open the menu and select a level. Traps must be enabled to access this menu. Trap severity levels include Unknown, Emergency, Alert, Critical, Error, Warning, Notify, Info, Debug, and Mark.

Restoring Fibre Channel switch module configuration

This section describes switch module configuration restoration tasks that are performed using the Telnet CLI interface and the management module.

Configuration backup

Changes made to the switch module since it was manufactured can be saved to a file in nonvolatile memory. However, the backup file is lost if the switch module is reset. Use the File Transfer Protocol (FTP) user images procedures to save the configdata file to the network management workstation. (In FTP, no directory listing is available. The configuration backup file is always named configdata.) For information about SNMP configuration, see “SNMP configuration” on page 124 and “SNMP trap configuration” on page 124.

Configuration restore

Switch module configurations can be duplicated to easily propagate an identical configuration to other switch modules. Use the FTP User Images procedures with the **Put** command to send the previously saved (using config backup) configdata file to the switch module. In Telnet, use the **Config Restore** command to return the switch module configuration to the previously saved configuration. The switch module is automatically reset after a successful restore.

Restoring the factory default configuration

You can restore the switch module and port configuration settings to the factory default values. To restore the factory configuration on a switch module, click **Switch** → **Restore Factory Defaults**. Table 36 lists the factory default switch module configuration settings. Restoring the switch module to the factory default configuration does not restore the login name and password settings.

Table 36. Factory default configuration settings

Settings	Value
Module name	Fibre Channel switch module
Administrative state	Online
Domain ID	1
Resource allocation time out (RA_TOV)	10000 milliseconds
Receiver transmitter timeout (RT_TOV)	100 milliseconds
Error detect timeout (ED_TOV)	2000 milliseconds
IP address	Switch module bay 3: 192.168.70.129 Switch module bay 4: 192.168.70.130
Subnet mask address	255.255.255.0
Gateway address	10.90.90.254
Boot method	Static
Contact	Undefined
Location	Undefined
Trap address	Trap 1: 10.0.0.1, Traps 2–5: 0.0.0.0
Trap community	Public
Read community	Public
Write community	Private
Port state	Online - external ad internal ports
Port speed	Auto-detect - external; 2G - internal

Table 36. Factory default configuration settings (continued)

Settings	Value
Port mode	GL - external; F - internal

Reinitializing the configuration file system

If the heartbeat LED on the switch module is showing the four-flash pattern, the configuration file system might be damaged. To recover the factory switch module configuration, use the **Config Restore** Telnet command. The heartbeat LED four-flash pattern continues until a previous switch module configuration is successfully restored. The heartbeat LED is not reflected in the SAN Utility.

Restoring a switch module

Restoring a switch module loads the archived switch configuration parameters to the switch module. The switch module configuration must be archived before it can be restored. See “Archiving a switch module” on page 106 for more information.

1. Log in to the fabric through the switch module you want to restore. You cannot restore a switch module over an ISL.
2. In the Faceplate window, click **Switch** → **Restore**.
3. In the Restore window, type the archive file name or browse for the file.
4. Click **Restore**.

Using the Fabric View application

You can use the Fabric View application to view port performance as graphs. The Fabric View window displays data communication rates and total errors for selected ports as shown in Figure 23 on page 127. You can graph communication data rates using either frames per second or KB per second.

This section provides the instructions you need to perform the following tasks in the Fabric View window:

- Start the Fabric View application
- Display port performance graphs
- Arrange and size port performance graphs
- Customize port performance graphs

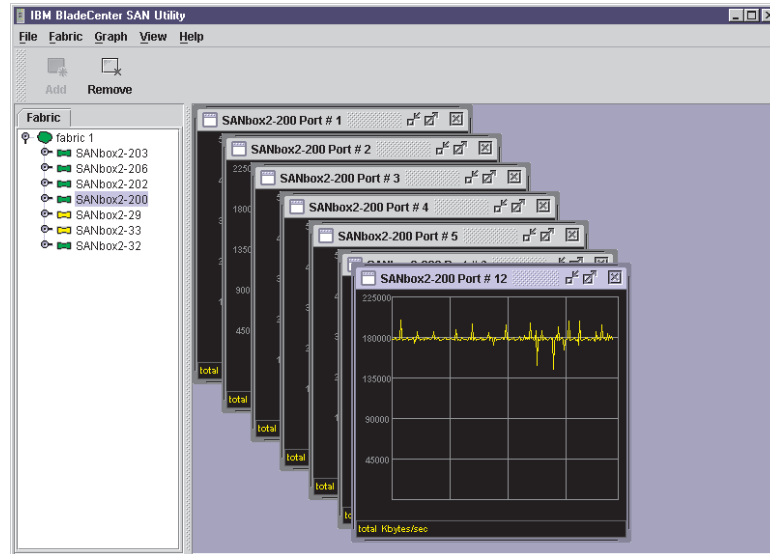

Figure 23. Fabric View graphs

Starting the Fabric View application

To start Fabric View using the SAN Utility, open the Faceplate window and click **Start Fabric View** from the Switch menu.

Displaying port performance graphs

Complete the following steps to display port performance graphs:

1. Click **Fabric** and select **Add Fabric** or click the **Add** button. Type a **fabric name** and an **IP address** in the Add a New Fabric window. Include a login name and a password if required.
2. Set the graphing options and polling frequency. By default, the Fabric View application plots total bytes transmitted and received at a polling frequency of once per second. See “Customizing port performance graphs” on page 128 for information about changing what is plotted and how it is plotted.
3. Select a switch module icon in the Fabric Tree to display a graph for each logged-in port on that switch module; or display a graph for a single port by clicking on the switch module entry handle and selecting one or more ports.
4. You can move graphs around individually by clicking and dragging, or you can arrange them as a group. See “Arranging and sizing port performance graphs” for more information.
5. To remove a graph, click **Close**. To remove all graphs, click **View** and click **Close All Graphs**.

Fabric View can access only one fabric at a time. To access another fabric, you must first remove the current fabric. To remove a fabric, click **Fabric** and select **Remove Fabric** or click the **Remove** button.

Arranging and sizing port performance graphs

Complete the following steps to arrange and size graphs in the Fabric View window:

1. Click **View** and select **Tile Graphs Vertically**. Tiling vertically sizes and arranges the graphs in the longest columns possible.

2. Click **View** and select **Tile Graphs Horizontally**. Tiling horizontally sizes and arranges the graphs in the longest rows possible.
3. Click **View** and select **Cascade Graph Panels**. Cascading overlaps the graphs so that all graphs are at least partially visible.

Customizing port performance graphs

You can customize the graph polling frequency, what is plotted in the graphs, and the graph color scheme. Complete the following steps to customize the port performance graphs:

1. To set the polling frequency for all graphs, click **Graph** and click **Set Polling Frequency**.
2. Type an interval, in seconds (0 through 60), and click **OK**.
3. To select what is to be plotted, click **Graph** and click **Options**. The Modify Graph Display window opens.

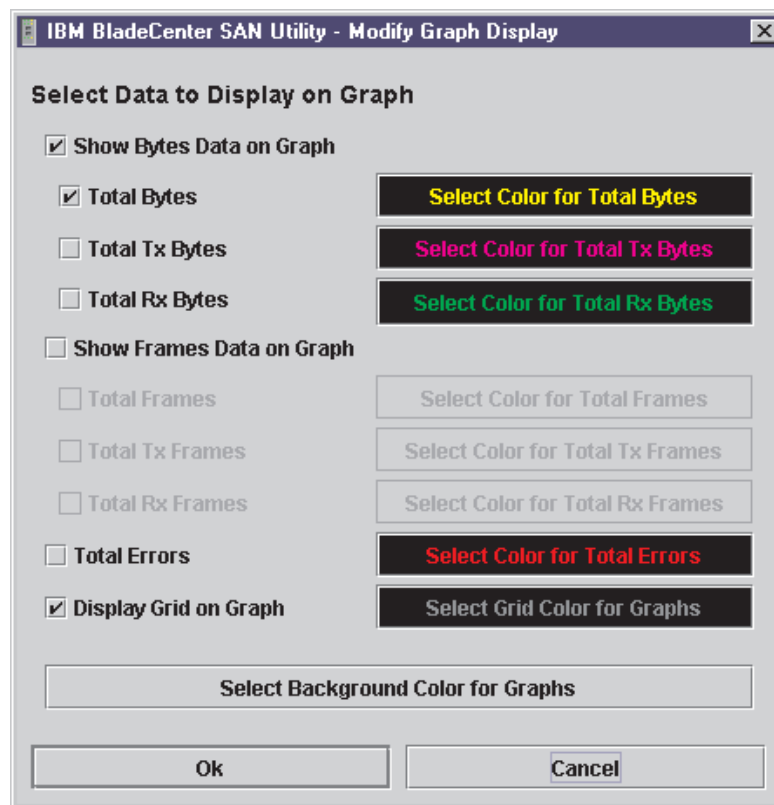

Figure 24. Modify Graph Display window

4. To modify the graph display, select the units for the graph:
 - Select the **Show Bytes Data on Graph** check box to plot data in KB per second.
 - Select the **Show Frames Data on Graph** check box to plot data in frames per second.
5. Choose what data type to plot. For example, if you selected **Show Frames Data on Graph** in step 4, you can plot one or all of the following:
 - Total frames transmitted and received (Total Frames)
 - Total frames transmitted (Total Tx Frames)

- Total frames received (Total Rx Frames)

In addition to these, you can also plot total errors by selecting the **Total Errors** check box.

6. Display or hide the unit grid. Select the **Display Grid on Graph** check box to display the unit grid.
7. Choose the color scheme for the graph. You can select the color for each data type, the unit grid, and the background by clicking the corresponding color field or button. In each case, you can choose a color using the swatches, Red-Green-Blue (RGB), or Hue-Saturation-Brightness (HSB):
 - Swatches – Click the **Swatches** tab. Select a swatch from the palette and click **OK**.
 - RGB – Click the **RGB** tab. Select a color by moving the slides to adjust the values for red, blue, and green; or type values in the fields. Click **OK**.
 - HSB – Click the **HSB** tab. Select a color using any of the following methods and click **OK**:
 - Click in the color palette.
 - Select **H**, **S**, or **B** and use the slide to vary the selected value.
 - Type values in the **H**, **S**, or **B** fields.

Appendix A. Mapping port locations and software numbering

Your switch module has two external Fibre Channel ports (external Fibre Channel port 1 and external Fibre Channel port 2) and 14 internal Fibre Channel ports that connect to each of the 14 blade server bays (ports 1 to 14). The SAN Utility and CLI for the switch module require port numbering from 0 to 15. The SNMP monitoring agent for the switch module numbers the ports from 1 to 16.

Port mapping

Table 37 shows the mapping of switch module port numbering and whether the port has the capability to be configured.

Table 37. Port mapping

Switch module physical port connection	SAN Utility and CLI logical port number	SNMP port numbering	Configurable
External port 1	0 (Ext1:0*)	1	Yes
Blade server bay 1	1	2	No
Blade server bay 2	2	3	No
Blade server bay 3	3	4	No
Blade server bay 4	4	5	No
Blade server bay 5	5	6	No
Blade server bay 6	6	7	No
Blade server bay 7	7	8	No
Blade server bay 8	8	9	No
Blade server bay 9	9	10	No
Blade server bay 10	10	11	No
Blade server bay 11	11	12	No
Blade server bay 12	12	13	No
Blade server bay 13	13	14	No
Blade server bay 14	14	15	No
External port 2	15 (Ext2:15*)	16	Yes

* Indicates a symbolic port name if it is different from the logical port number.

Note: The Fibre Channel ports that connect to each of the blade server bays (1 through 14) are fixed 2 Gbps F_Port configurations. Only the administrative state for these ports can be changed.

Appendix B. Getting help and technical assistance

If you need help, service, or technical assistance or just want more information about IBM® products, you will find a wide variety of sources available from IBM to assist you. This appendix contains information about where to go for additional information about IBM and IBM products, what to do if you experience a problem with your xSeries or IntelliStation® system, and whom to call for service, if it is necessary.

Before you call

Before you call, make sure that you have taken these steps to try to solve the problem yourself:

- Check all cables to make sure that they are connected.
- Check the power switches to make sure that the system is turned on.
- Use the troubleshooting information in your system documentation, and use the diagnostic tools that come with your system.
- Go to the IBM Support Web site at <http://www.ibm.com/pc/support/> to check for technical information, hints, tips, and new device drivers.
- Use an IBM discussion forum on the IBM Web site to ask questions.

You can solve many problems without outside assistance by following the troubleshooting procedures that IBM provides in the online help or in the publications that are provided with your system and software. The information that comes with your system also describes the diagnostic tests that you can perform. Most xSeries and IntelliStation systems, operating systems, and programs come with information that contains troubleshooting procedures and explanations of error messages and error codes. If you suspect a software problem, see the information for the operating system or program.

Using the documentation

Information about your IBM xSeries or IntelliStation system and preinstalled software, if any, is available in the documentation that comes with your system. That documentation includes printed books, online books, README files, and help files. See the troubleshooting information in your system documentation for instructions for using the diagnostic programs. The troubleshooting information or the diagnostic programs might tell you that you need additional or updated device drivers or other software. IBM maintains pages on the World Wide Web where you can get the latest technical information and download device drivers and updates. To access these pages, go to <http://www.ibm.com/pc/support/> and follow the instructions. Also, you can order publications through the IBM Publications Ordering System at <http://www.elink.ibm.com/public/applications/publications/cgibin/pbi.cgi>.

Getting help and information from the World Wide Web

On the World Wide Web, the IBM Web site has up-to-date information about IBM xSeries and IntelliStation products, services, and support. The address for IBM xSeries information is <http://www.ibm.com/eserver/xseries/>. The address for IBM IntelliStation information is <http://www.ibm.com/pc/intellistation/>.

You can find service information for your IBM products, including supported options, at <http://www.ibm.com/pc/support/>. If you click **Profile** from the support page, you can create a customized support page. The support page has many sources of information and ways for you to solve problems, including:

- Diagnosing problems, using the IBM Online Assistant
- Downloading the latest device drivers and updates for your products
- Viewing Frequently Asked Questions (FAQ)
- Viewing hints and tips to help you solve problems
- Participating in IBM discussion forums
- Setting up e-mail notification of technical updates about your products

Software service and support

Through IBM Support Line, you can get telephone assistance, for a fee, with usage, configuration, and software problems with xSeries servers, IntelliStation workstations, and appliances. For information about which products are supported by Support Line in your country or region, go to <http://www.ibm.com/services/sl/products/>.

For more information about Support Line and other IBM services, go to <http://www.ibm.com/services/>, or go to <http://www.ibm.com/planetwide/> for support telephone numbers.

Hardware service and support

You can receive hardware service through IBM Integrated Technology Services or through your IBM reseller, if your reseller is authorized by IBM to provide warranty service. Go to <http://www.ibm.com/planetwide/> for support telephone numbers.

In the U.S. and Canada, hardware service and support is available 24 hours a day, 7 days a week. In the U.K., these services are available Monday through Friday, from 9 a.m. to 6 p.m.

Appendix C. Notices

This information was developed for products and services offered in the U.S.A.

IBM may not offer the products, services, or features discussed in this document in other countries. Consult your local IBM representative for information on the products and services currently available in your area. Any reference to an IBM product, program, or service is not intended to state or imply that only that IBM product, program, or service may be used. Any functionally equivalent product, program, or service that does not infringe any IBM intellectual property right may be used instead. However, it is the user's responsibility to evaluate and verify the operation of any non-IBM product, program, or service.

IBM may have patents or pending patent applications covering subject matter described in this document. The furnishing of this document does not give you any license to these patents. You can send license inquiries, in writing, to:

*IBM Director of Licensing
IBM Corporation
North Castle Drive
Armonk, NY 10504-1785
U.S.A.*

INTERNATIONAL BUSINESS MACHINES CORPORATION PROVIDES THIS PUBLICATION "AS IS" WITHOUT WARRANTY OF ANY KIND, EITHER EXPRESS OR IMPLIED, INCLUDING, BUT NOT LIMITED TO, THE IMPLIED WARRANTIES OF NON-INFRINGEMENT, MERCHANTABILITY OR FITNESS FOR A PARTICULAR PURPOSE. Some states do not allow disclaimer of express or implied warranties in certain transactions, therefore, this statement may not apply to you.

This information could include technical inaccuracies or typographical errors. Changes are periodically made to the information herein; these changes will be incorporated in new editions of the publication. IBM may make improvements and/or changes in the product(s) and/or the program(s) described in this publication at any time without notice.

Any references in this information to non-IBM Web sites are provided for convenience only and do not in any manner serve as an endorsement of those Web sites. The materials at those Web sites are not part of the materials for this IBM product, and use of those Web sites is at your own risk.

IBM may use or distribute any of the information you supply in any way it believes appropriate without incurring any obligation to you.

Edition notice

**© COPYRIGHT INTERNATIONAL BUSINESS MACHINES CORPORATION, 2003.
All rights reserved.**

Note to U.S. Government Users Restricted Rights — Use, duplication or disclosure restricted by GSA ADP Schedule Contract with IBM Corp.

Trademarks

The following terms are trademarks of International Business Machines Corporation in the United States, other countries, or both:

Active Memory	Predictive Failure Analysis
Active PCI	PS/2
Active PCI-X	ServeRAID
Alert on LAN	ServerGuide
BladeCenter	
C2T Interconnect	ServerProven
Chipkill	TechConnect
EtherJet	Tivoli
e-business logo	Tivoli Enterprise
FlashCopy	Update Connector
IBM	Wake on LAN
IntelliStation	XA-32
Light Path Diagnostics	XA-64
NetBAY	X-Architecture
Netfinity	Xcel4
NetView	XpandOnDemand
OS/2 WARP	xSeries

Lotus, Lotus Notes, SmartSuite, and Domino are trademarks of Lotus Development Corporation and/or IBM Corporation in the United States, other countries, or both.

ActionMedia, LANDesk, MMX, Pentium, and ProShare are trademarks of Intel Corporation in the United States, other countries, or both.

Microsoft, Windows, and Windows NT are trademarks of Microsoft Corporation in the United States, other countries, or both.

UNIX is a registered trademark of The Open Group in the United States and other countries.

Java and all Java-based trademarks and logos are trademarks or registered trademarks of Sun Microsystems, Inc. in the United States, other countries, or both.

Linux is a registered trademark of Linus Torvalds.

Other company, product, or service names may be trademarks or service marks of others.

Important notes

Processor speeds indicate the internal clock speed of the microprocessor; other factors also affect application performance.

CD-ROM drive speeds list the variable read rate. Actual speeds vary and are often less than the maximum possible.

When referring to processor storage, real and virtual storage, or channel volume, KB stands for approximately 1000 bytes, MB stands for approximately 1 000 000 bytes, and GB stands for approximately 1 000 000 000 bytes.

When referring to hard disk drive capacity or communications volume, MB stands for 1 000 000 bytes, and GB stands for 1 000 000 000 bytes. Total user-accessible capacity may vary depending on operating environments.

Maximum internal hard disk drive capacities assume the replacement of any standard hard disk drives and population of all hard disk drive bays with the largest currently supported drives available from IBM.

Maximum memory may require replacement of the standard memory with an optional memory module.

IBM makes no representation or warranties regarding non-IBM products and services that are ServerProven[®], including but not limited to the implied warranties of merchantability and fitness for a particular purpose. These products are offered and warranted solely by third parties.

IBM makes no representations or warranties with respect to non-IBM products. Support (if any) for the non-IBM products is provided by the third party, not IBM.

Some software may differ from its retail version (if available), and may not include user manuals or all program functionality.

Index

A

- access and integrity test 119
- access control list (ACL) zones 87
- Active Zoneset Data window 85
- Add a New Fabric window 81
- administrative port state 114
- alarm
 - configuring 101
 - exporting log information 102
- Alarm Log Data window 101
- Alarm Threshold Configuration window 101
- alias
 - adding a member 96
 - command 9
 - creating 96
 - defined 87
 - managing 95
 - removing from all zones 96

B

- beacon feature (paging a switch) 102
- BladeCenter management module interface 1
- BladeCenter unit 3
- broadcast support 104
- buffer-to-buffer credits 116

C

- changing port modes 115
- changing port speeds 115
- checksum test 119
- command line commands 8, 71
- command line interface (CLI) 5
- command syntax 6
- configuration
 - auto save parameters 88
 - backup 125
 - default visibility parameters 88
 - factory default 125
 - file system reinitialization 126
- Configured Administrative state 114
- Current Administrative state 114

D

- diagnostic flash patterns 119
- diagnostics test 103
- domain ID lock 104

E

- Edit Zoning window
 - port and device tree 90
 - using the 90
 - zone sets tree 90

- exporting
 - alarm log information 102
 - name server information to file 102
- Extended Credits window 117
- extending port credits 116
- external port
 - mapping 131
 - selecting 79
 - views and status 79
 - working with 79
- External Port Properties window 113

F

- fabric
 - adding 81
 - database management 81
 - default configuration 82
 - managing 80
 - monitoring 84
 - opening an existing 82
 - rediscovering 82
 - removing 82
 - replacing a failed switch 83
 - saving 82
 - security 80
 - status 84
- fabric tree 74
- Fabric View application 99
- Fabric View window 127
- Faceplate data window 75, 97
- Faceplate data window tabs
 - alarm log 80
 - configured zone sets 80
 - port information 80
 - port statistics 80
 - switch 80
- Faceplate window
 - data window 78, 80
 - data window and tabs 71
 - Display Data windows 107
 - displaying port speeds 109
 - fabric tree 71
 - functional elements 78
 - graphic window 71
 - managing switches 79
 - menu bar 71, 72
 - port operational states 109
 - port views and status 78
 - selecting ports 79
 - toolbar 71
 - working status indicator 71
 - working with ports 78
- Fibre Channel switch fault LED 119
- Fibre Channel switch module 1
- firmware
 - activating the fallback 107
 - loading 107

firmware (*continued*)
managing 107

G

getting help and technical assistance
 checking the software 133
 hardware service and support 134
 problem determination 133
 running diagnostics 133
 software service and support 134
 World Wide Web 133
graphic window 75
graphical user interface, SAN Utility
 Faceplate window 71
 Topology window 71

H

heartbeat LED 119

I

I/O Stream Guard feature 116
IBM BladeCenter SAN Utility application 1
in-band management 104
indicators, information panel 119
information panel 119
internal port
 mapping 131
 selecting 79
 working with 79
Internal Port Properties window 113
interswitch links 84
IP address 105
IP address, default
 BladeCenter unit bay 3 82
 BladeCenter unit bay 4 82
IP configuration parameters
 boot method 106
 IP gateway address 106
 subnet mask 106

L

LEDs
 diagnostic flash patterns 119
 front view 119
 heartbeat 120
 OK 121
 port fault 122
 port logged-in 121
 port status 119
 POST diagnostics 119
 switch fault 121
 switch module status 119
Link Data window 99
loopback test 119

M

managing fabrics 80
managing switches 96
mapping ports 131
menu bar 72
merging fabrics and zoning 89
Modify Graph Display window 128

N

network management workstation
 running Microsoft Windows 2000 1
 running Red Hat Linux Advanced Server Version 2.1 1
 running Red Hat Linux Version 7.x 1
 running SuSE Linux Professional Version 8.0 1
network properties
 community settings 105
 window 105
node worldwide name (NWWN) 98
node-to-node test 123
notes, important 136
notices used in this book 3, 135

O

OK LED 119

P

paging a switch with the beacon feature 102
pop-up menus 78
port
 activity LED 119
 administrative state 114
 changing mode 115
 external 79
 fault LED 119
 internal 79
 logged-in LED 119
 loopback test 122
 mapping 131
 node-to-node test 123
 operational state 109
 selecting 79
 SerDes level test 122
 SFP level test 123
 speeds 109, 115
 views and status 79
 working with 79
Port Administrative state 114
port graphing 109
Port Information Data window 100
Port Statistics Data window 100
port worldwide name (PWWN) 98
power-on self-test (POST) 119
publications, related 2

R

- registered state change notification (RSCN) 29
- related publications 2
- Remote Logging (syslog) feature 106
- restoring default zoning 89

S

- SAN devices 1
- SAN Utility application
 - managing multiple switches 1
 - user interface 71
 - using 71
- SerDes level test 122
- SFP level test 123
- small form-factor pluggable (SFP) module
 - displaying media status 109
 - port operational state 109
- SNMP configuration parameters
 - authentication trap 124
 - changing 105
 - community authentication 124
 - contact 124
 - location 124
- soft zoning 87
- Switch Data window 98
- switch management utility functions
 - LED diagnostics 119
 - port testing 122
 - switch module monitoring using SNMP 124
 - using the Fabric View application 126
- switch module
 - administrative states 103
 - archiving configuration parameters 106
 - ASIC 119
 - configuring 102
 - configuring using the Telnet interface 5
 - default password 5
 - default user ID 5
 - displaying information 97
 - IP addresses 5
 - monitoring 124
 - resetting 102
 - setting the date and time 102
 - XML archive file 106
- Switch Properties window 103
- symbolic name 103

T

- Telnet interface 5
 - logging on to a switch module 5
- toolbar 73
- Topology Data window tabs
 - link 78
 - name server 78
 - switch 78
- Topology window
 - arranging switches 77
 - data window and tabs 71

- Topology window (*continued*)
 - deleting a switch 83
 - fabric tree 71
 - functional elements 75
 - graphic window 71
 - menu bar 71, 72
 - selecting a switch 77
 - switch and link status 75
 - switch and status icons 84
 - toolbar 71
 - using the 75
 - working status indicator 71
- trademarks 136
- translated loop (TL) modes 115

V

- virtual private fabric (VPF) zones 87

W

- working status indicator 75
- World Wide Web, getting help and information 133

Z

- zone
 - a database 88
 - a fabric 86
 - adding members to a 94
 - configuration parameters 88
 - defined 86
 - hard zone access control list 86
 - hard zone virtual private fabric 87
 - management 93
 - merge failure 89
 - merge failure recovery 90
 - orphan 87
 - removing a member 95
 - renaming 94
 - set 87
 - soft zone 86
- zone set
 - activating and deactivating 92
 - copying an existing 92
 - creating 92
 - managing 91
 - removing a zone from a 92
 - removing definitions 93
- Zonesets Data window 100
- Zoning Config window 89



Part Number: 02R0678

Printed in U.S.A.

(1P) P/N: 02R0678

