

BladeCenter T Management Module



# Installation Guide



BladeCenter T Management Module



# Installation Guide

**Note:**

Before using this information and the product it supports, read the general information in Appendix B, "IBM Statement of Limited Warranty Z125-4753-08 04/2004," on page 37 and Appendix C, "Notices," on page 61.

**Second Edition (November 2004)**

**© Copyright International Business Machines Corporation 2004. All rights reserved.**  
US Government Users Restricted Rights – Use, duplication or disclosure restricted by  
GSA ADP Schedule Contract with IBM Corp.

---

# Contents

<b>Safety</b> . . . . .	<b>v</b>
<b>Chapter 1. Introduction</b> . . . . .	<b>1</b>
Related documentation . . . . .	2
About your documentation CD . . . . .	3
System requirements. . . . .	3
Using the Documentation Browser . . . . .	3
Notices and statements used in this document . . . . .	5
Overview of the management module . . . . .	6
<b>Chapter 2. Installing and removing a management module.</b> . . . . .	<b>7</b>
Installation guidelines . . . . .	7
System reliability considerations. . . . .	8
Handling static-sensitive devices. . . . .	8
Preparing for management-module redundancy . . . . .	10
Installing a management module . . . . .	12
Removing a management module . . . . .	16
Cabling the KVM and LAN modules. . . . .	19
Cabling the KVM module ports . . . . .	19
Cabling the LAN module Ethernet ports. . . . .	20
<b>Chapter 3. Management, KVM, and LAN module LEDs and external ports</b> . . . . .	<b>23</b>
Management module controls and indicators . . . . .	23
KVM (keyboard, video, mouse) module indicators and input/output connectors . . . . .	24
LAN-module indicators and input/output connectors . . . . .	26
<b>Chapter 4. Configuring the management module</b> . . . . .	<b>29</b>
Starting the management and configuration program . . . . .	30
Configuring the management module . . . . .	31
<b>Appendix A. Getting help and technical assistance</b> . . . . .	<b>35</b>
Before you call . . . . .	35
Using the documentation. . . . .	35
Getting help and information from the World Wide Web . . . . .	36
Software service and support . . . . .	36
Hardware service and support . . . . .	36
<b>Appendix B. IBM Statement of Limited Warranty Z125-4753-08 04/2004</b> . . . . .	<b>37</b>
Part 1 - General Terms. . . . .	37
Part 2 - Country-unique Terms . . . . .	41

Part 3 - Warranty Information . . . . .	56
<b>Appendix C. Notices . . . . .</b>	<b>61</b>
Edition notice . . . . .	62
Trademarks . . . . .	62
Important notes . . . . .	63
Product recycling and disposal . . . . .	64
Battery return program . . . . .	64
Electronic emission notices . . . . .	65
Federal Communications Commission (FCC) statement. . . . .	65
Industry Canada Class A emission compliance statement . . . . .	65
Australia and New Zealand Class A statement . . . . .	66
United Kingdom telecommunications safety requirement . . . . .	66
European Union EMC Directive conformance statement . . . . .	66
Taiwanese Class A warning statement . . . . .	66
Chinese Class A warning statement . . . . .	67
Japanese Voluntary Control Council for Interference (VCCI) statement . . . . .	67
<b>Index . . . . .</b>	<b>69</b>

---

## Safety

Before installing this product, read the Safety Information.

قبل تركيب هذا المنتج، يجب قراءة الملاحظات الأمنية

Antes de instalar este produto, leia as Informações de Segurança.

在安裝本產品之前，請仔細閱讀 **Safety Information**  
(安全信息)。

安裝本產品之前，請先閱讀「安全資訊」。

Prije instalacije ovog produkta obavezno pročitajte Sigurnosne Upute.

Před instalací tohoto produktu si přečtěte příručku bezpečnostních instrukcí.

Læs sikkerhedsforskrifterne, før du installerer dette produkt.

Lees voordat u dit product installeert eerst de veiligheidsvoorschriften.

Ennen kuin asennat tämän tuotteen, lue turvaohjeet kohdasta Safety Information.

Avant d'installer ce produit, lisez les consignes de sécurité.

Vor der Installation dieses Produkts die Sicherheitshinweise lesen.

Πριν εγκαταστήσετε το προϊόν αυτό, διαβάστε τις πληροφορίες ασφαλείας (safety information).

לפני שתתקינו מוצר זה, קראו את הוראות הבטיחות.

A termék telepítése előtt olvassa el a Biztonsági előírásokat!

Prima di installare questo prodotto, leggere le Informazioni sulla Sicurezza.

製品の設置の前に、安全情報をお読みください。

본 제품을 설치하기 전에 안전 정보를 읽으십시오.

Пред да се инсталира овој продукт, прочитајте информацијата за безбедност.

Les sikkerhetsinformasjonen (Safety Information) før du installerer dette produktet.

Przed zainstalowaniem tego produktu, należy zapoznać się z książką "Informacje dotyczące bezpieczeństwa" (Safety Information).

Antes de instalar este produto, leia as Informações sobre Segurança.

Перед установкой продукта прочтите инструкции по технике безопасности.

Pred inštaláciou tohto zariadenia si pečítajte Bezpečnostné predpisy.

Pred namestitvijo tega proizvoda preberite Varnostne informacije.

Antes de instalar este producto, lea la información de seguridad.

Läs säkerhetsinformationen innan du installerar den här produkten.



**Statement 1:**



**DANGER**

Electrical current from power, telephone, and communication cables is hazardous.

To avoid a shock hazard:

- Do not connect or disconnect any cables or perform installation, maintenance, or reconfiguration of this product during an electrical storm.
- Connect all power cords to a properly wired and grounded electrical outlet.
- Connect to properly wired outlets any equipment that will be attached to this product.
- When possible, use one hand only to connect or disconnect signal cables.
- Never turn on any equipment when there is evidence of fire, water, or structural damage.
- Disconnect the attached power cords, telecommunications systems, networks, and modems before you open the device covers, unless instructed otherwise in the installation and configuration procedures.
- Connect and disconnect cables as described in the following table when installing, moving, or opening covers on this product or attached devices.

**To Connect:**

1. Turn everything OFF.
2. First, attach all cables to devices.
3. Attach signal cables to connectors.
4. Attach power cords to outlet.
5. Turn device ON.

**To Disconnect:**

1. Turn everything OFF.
2. First, remove power cords from outlet.
3. Remove signal cables from connectors.
4. Remove all cables from devices.

**Statement 5:**



**CAUTION:**

The power control button on the device and the power switch on the power supply do not turn off the electrical current supplied to the device. The device also might have more than one power cord. To remove all electrical current from the device, ensure that all power cords are disconnected from the power source.

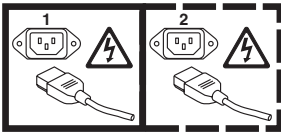

**Statement 6:**



**CAUTION:**

If you install a strain-relief bracket option over the end of the power cord that is connected to the device, you must connect the other end of the power cord to an easily accessible power source.

Statement 8:



**CAUTION:**

Never remove the cover on a power supply or any part that has the following label attached.



Hazardous voltage, current, and energy levels are present inside any component that has this label attached. There are no serviceable parts inside these components. If you suspect a problem with one of these parts, contact a service technician.

**Statement 13:**



**DANGER**

**Overloading a branch circuit is potentially a fire hazard and a shock hazard under certain conditions. To avoid these hazards, ensure that your system electrical requirements do not exceed branch circuit protection requirements. Refer to the information that is provided with your device for electrical specifications.**

**WARNING:** Handling the cord on this product or cords associated with accessories sold with this product, will expose you to lead, a chemical known to the State of California to cause cancer, and birth defects or other reproductive harm. *Wash hands after handling.*

**ADVERTENCIA:** El contacto con el cable de este producto o con cables de accesorios que se venden junto con este producto, pueden exponerle al plomo, un elemento químico que en el estado de California de los Estados Unidos está considerado como un causante de cancer y de defectos congénitos, además de otros riesgos reproductivos. *Lávese las manos después de usar el producto.*

---

## Chapter 1. Introduction

This IBM® @server® BladeCenter™ T Management Module Installation Guide contains information about installing and configuring the management module.

**Note:** The illustrations in this document might differ slightly from your hardware.

For installation details, see Chapter 2, “Installing and removing a management module,” on page 7. For additional information, see the instructions in your BladeCenter T documents.

The management module is one of two management modules that can be installed in the IBM @server BladeCenter T Type 8720 or 8730 enclosure. Only one management module can be active; the second management module, if present, provides redundancy.

You can obtain up-to-date information about your management module and other IBM server products at <http://www.ibm.com/eserver/xseries/>.

Record information about the management module in the following table.

<b>Product name</b>	IBM @server BladeCenter T Management Module
<b>Serial number</b>	_____
<b>Media access control (MAC) address</b>	_____

The product name and serial number are on the identification label on the top center of the BladeCenter T Management Module. You will need this information when you register your BladeCenter T Management Module with IBM. The media access control (MAC) address is on a label at the front of the management module. See “Overview of the management module” on page 6 for an illustration that shows the location of the identification label.

The management module functions as a service processor for the multiple blade servers in a BladeCenter T unit. You configure the BladeCenter T unit and modules through the management module, configuring information such as the management-module and I/O-module IP addresses. The management module also performs USB-to-PS/2® conversions for the system keyboard and mouse and can send the VGA data stream to a remote console for viewing.

The service processor in the management module communicates with the service processor in each blade server for functions such as:

- Blade server power-on requests
- Blade server error and event reporting
- Blade server requests for keyboard, mouse, and video
- Blade server requests for optical drive and USB ports

In addition to blade servers, the management module also communicates with the I/O modules, power modules, blower modules, and the media tray in the BladeCenter T unit to detect their presence or absence and any error conditions, sending alerts when required.

---

## Related documentation

In addition to this *Installation Guide*, the following documentation might be on the *Documentation* CD that comes with your BladeCenter T management module. Depending on your BladeCenter product, additional documents might also be included on the *Documentation* CD. The most recent versions of all BladeCenter documentation is at <http://www.ibm.com/support/>.

- *Safety Information*

This document contains translated caution and danger statements. Each caution and danger statement that appears in the documentation has a number that you can use to locate the corresponding statement in your language in the *Safety Information* document.

- *BladeCenter T Management Module User's Guide*

This document provides general information about the management module for your BladeCenter T unit type, including information about features, how to configure your BladeCenter® T Management Module, and how to get help.

- *@server BladeCenter Management Module Command-Line Interface Reference Guide*

This document explains how to use the management module command-line interface to directly access BladeCenter management functions as an alternative to using the Web-based user interface. The command-line interface also provides access to the text-console command prompt on each blade server through a serial over LAN (SOL) connection.

- *IBM @server BladeCenter Serial over LAN Setup Guide*

This document explains how to update and configure BladeCenter components for Serial over LAN (SOL) operation. The SOL connection provides access to the text-console command prompt on each blade server, enabling the blade servers to be managed from a remote location.

In addition to the documentation in this library, be sure to review the *IBM BladeCenter T Planning and Installation Guide* for your BladeCenter T unit type for information to help you prepare for system installation and configuration. This document is available at <http://www.ibm.com/pc/eserver/bladecenter>.

---

## About your documentation CD

Your BladeCenter T management module comes with an IBM *BladeCenter Documentation CD*, which contains documentation for your system in PDF and includes the IBM Documentation Browser to help you find information quickly.

### System requirements

To run the documentation CD, use a system that has the following minimum hardware and software:

- Microsoft® Windows NT® 4.0 (with Service Pack 3 or later), Windows® 2000, SUSE LINUX, or Red Hat® Linux.
- 100 MHz Intel microprocessor.
- 32 MB RAM.
- Adobe Acrobat Reader 3.0 (or later) or xpdf, which comes with Linux operating systems. Acrobat Reader software is included on the CD, and you can install it when you run the Documentation Browser.

### Using the Documentation Browser

Use the Documentation Browser to browse the contents of the CD, read brief descriptions of the documents, and view documents using Adobe Acrobat Reader or xpdf. The Documentation Browser automatically detects the regional settings in use on your system and presents the information in the language for that region (if available). If a topic is not available in the language for that region, the English version is displayed.

Use one of the following procedures to start the Documentation Browser:

- If Autostart is enabled, insert the documentation CD into your optical drive. The Documentation Browser will start automatically.
- If Autostart is disabled or is not enabled for all users:
  - If you are using a Windows operating system, insert the documentation CD into your optical drive; then, click **Start --> Run**. In the **Open** field, type  
`e:\win32.bat`  
where *e* is the drive letter of your optical drive, and click **OK**.
  - If you are using a Linux operating system, insert the documentation CD into your optical drive and run the following command from the `/mnt/cdrom` directory:  
`sh runlinux.sh`

Select your computer from the **Product** menu. The **Available Topics** list displays all the documents for your computer. Some documents might be in folders. A plus sign (+) indicates each folder or document that has additional topics under it. Click the plus sign to display the additional documents.

When you select a document, a description of the document appears under **Topic Description**. To select more than one document, press and hold the Ctrl key while you select the documents. Click **View Book** to view the selected document or documents in Acrobat Reader or xpdf. If you selected more than one document, all the selected documents are opened in Acrobat Reader or xpdf.

To search all the documents, type a word or word string in the **Search** field and click **Search**. The documents in which the word or word string appears are listed in order of the most occurrences. Click a document to view it, and press Ctrl+F to use the Acrobat search function or press Alt+F to use the xpdf search function within the document.

Click **Help** for detailed information about using the Documentation Browser.



---

## Notices and statements used in this document

The caution and danger statements that appear in this document are also in the multilingual *Safety Information* document, which is on the IBM *BladeCenter T Documentation* CD. Each statement is numbered for reference to the corresponding statement in the *Safety Information* document.

The following notices and statements are used in this document:

- **Notes:** These notices provide important tips, guidance, or advice.
- **Important:** These notices provide information or advice that might help you avoid inconvenient or problem situations.
- **Attention:** These notices indicate potential damage to programs, devices, or data. An attention notice is placed just before the instruction or situation in which damage could occur.
- **Caution:** These statements indicate situations that can be potentially lethal or extremely hazardous to you. A caution statement is placed just before the description of a potentially hazardous procedure step or situation.
- **Danger:** These statements indicate situations that can be potentially lethal or extremely hazardous to you. A danger statement is placed just before the description of a potentially lethal or extremely hazardous procedure step or situation.

---

## Overview of the management module

The following illustration shows the management module.

**Note:** The illustrations in this document might differ slightly from your hardware.

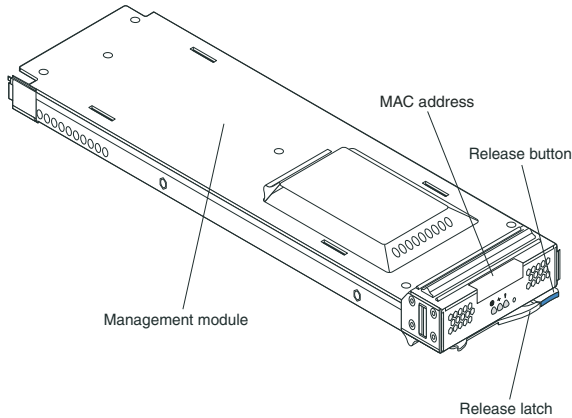

The IBM @server BladeCenter T Management Module is a hot-swap unit that is installed into the front of the BladeCenter T unit. The module also contains the video compression board.

For information about the indicators on the front of the management module, and the associated KVM (keyboard, video, mouse) and LAN modules, see Chapter 3, “Management, KVM, and LAN module LEDs and external ports,” on page 23.

---

## Chapter 2. Installing and removing a management module

The following illustration shows the management-module bay locations on the front of the BladeCenter T unit.

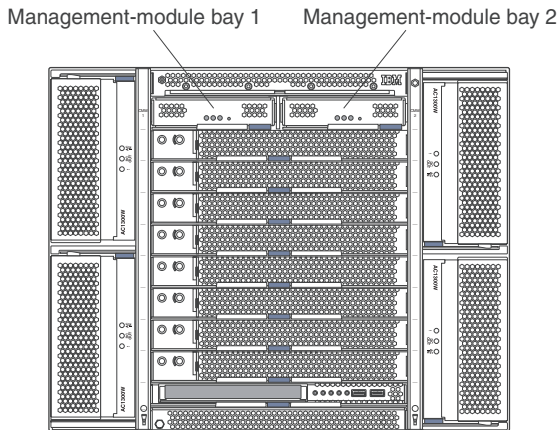

---

### Installation guidelines

Before you begin to install the management module in the BladeCenter T unit, read the following information:

- Read the safety information beginning on page v and the handling guidelines in "Handling static-sensitive devices" on page 8. This information will help you work safely with your BladeCenter T unit and options.
- Blue on a component indicates touch points, where you can grip the component to remove it from or install it in the server, open or close a latch, and so on.
- Orange on a component or an orange label on or near a component indicates that the component can be hot-swapped, which means that you can remove or install the component while the BladeCenter T unit is running. (Orange can also indicate touch points on hot-swap components.) For complete details about installing or removing a management module, see the detailed information in this chapter.

- You do not have to disconnect the BladeCenter T unit from power to install or replace any of the hot-swap modules in the BladeCenter T unit. You must shut down the operating system and turn off a hot-swap blade server on the front of the BladeCenter T unit before removing the blade server, but you do not need to shut down the BladeCenter T unit itself.
- For a list of supported options for your BladeCenter T unit, go to <http://www.ibm.com/pc/compat/>.

## System reliability considerations

**Attention:** To help ensure proper cooling and system reliability, make sure that:

- Each of the module bays in the BladeCenter T unit has either a module or filler module installed.
- Each of the blade bays on the front of the BladeCenter T unit has either a blade server or filler blade installed.
- Each of the drive bays in a blade server storage expansion option has either a hot-swap drive or a filler panel installed.
- A removed hot-swap module or drive is replaced within 1 minute of removal. Failure to replace a module or drive with another module, drive, or filler module within 1 minute can affect performance in the blade servers.
- A removed blade server is replaced within 20 minutes of removal. Failure to replace a blade server with another blade server or filler blade within 20 minutes can affect performance in the blade servers.
- A failed blower is replaced as soon as possible, to restore cooling redundancy.

## Handling static-sensitive devices

**Attention:** Static electricity can damage electronic devices and your BladeCenter T unit. To avoid damage, keep static-sensitive devices in their static-protective packages until you are ready to install them.

Use an ESD wrist strap and the ESD connectors on the BladeCenter T unit. Electrostatic discharge (ESD) is the release of stored static electricity that can damage electric circuits. Static electricity is often stored in your body and discharged when you come in contact with an object with a different potential. The ESD wrist strap safely channels the electricity from your body to a proper ground (the BladeCenter T unit).

Use an ESD wrist strap whenever you are working on the BladeCenter T unit, especially when you are handling modules, options, and blade servers. To work properly, the wrist strap must have a good contact at both ends (touching your skin at one end and connected to the ESD connector on the front or back of the BladeCenter T unit.)

### Location of ESD connector (front of unit)

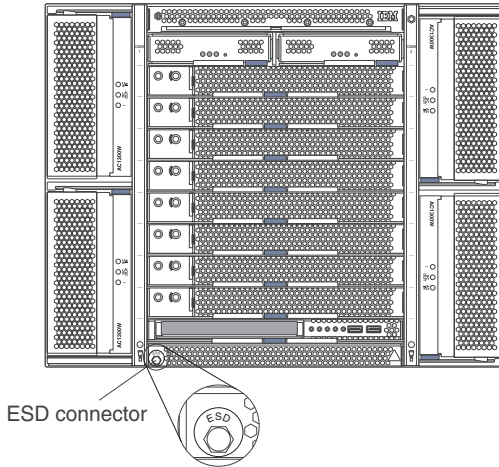

### Location of ESD connector (rear of unit)

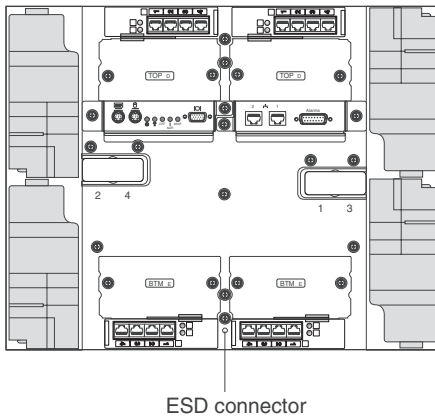

To reduce the possibility of electrostatic discharge, observe the following precautions:

- Limit your movement. Movement can cause static electricity to build up around you.
- Handle the device carefully, holding it by its edges or its frame.
- Do not touch solder joints, pins, or exposed printed circuitry.
- Do not leave the device where others can handle and damage it.
- While the device is still in its static-protective package, touch it to an unpainted metal part of the system unit for at least 2 seconds. This drains static electricity from the package and from your body.
- Remove the device from its package and install it directly into the BladeCenter T unit without setting down the device. If it is necessary to set down the device, place it back into its static-protective package. Do not place the device on the BladeCenter T unit or on a metal surface.
- Take additional care when handling devices during cold weather. Heating reduces indoor humidity and increases static electricity.

---

## Preparing for management-module redundancy

When two management modules are installed in a BladeCenter T unit, only one management module is active; the second management module, if present, provides redundancy. The active management module is the primary module; the redundant module is the secondary module. If the primary management module fails, or if you request a changeover through the Web interface, the secondary management module becomes active and primary.

Management-module redundancy requires specific minimum levels of firmware. If you intend to install a second management module in the BladeCenter T unit, make sure that you have downloaded and applied the latest level of firmware from the IBM Support Web site.

Complete the following steps to prepare your management modules for redundancy:

1. Go to the IBM Support Web site at <http://www.ibm.com/pc/support/> to check for technical information, hints, tips, and the latest firmware.
2. Download the latest management-module firmware and use the management-module Web interface to apply it to your current primary management module (see “Starting the management and configuration program” on page 30 for detailed instructions about logging in to the Web interface). You must update all parts of the management-module firmware that are in the download.
  - a. In the **MM Control** section in the navigation pane, click **Firmware Update**.

- b. Click **Browse** to locate the firmware file that you downloaded; then, click **Update**. Follow the instructions on the screen.
3. Install the second management module in the available management-module bay (see “Installing a management module” on page 12 for instructions).
4. Wait approximately 2 minutes while the primary management module transfers configuration information to the second management module. If the firmware installed on the primary management module is a different version than that on the second management module, the version of firmware installed on the primary management module will automatically be applied to both management modules. The firmware update for the second management module takes approximately 10 minutes to complete.

The management modules are now prepared for redundancy.

**Notes:**

1. Whenever power is restored to a BladeCenter T unit that has two functional management modules installed, the management module in bay 1 is automatically the active management module, even if the module in bay 2 was the active module before power was removed.
2. Go to the IBM Support Web site at <http://www.ibm.com/pc/support/> for the available systems-management software that you can use to manage redundant management modules.

---

## Installing a management module

Statement 8:



### CAUTION:

Never remove the cover on a power supply or any part that has the following label attached.



Hazardous voltage, current, and energy levels are present inside any component that has this label attached. There are no serviceable parts inside these components. If you suspect a problem with one of these parts, contact a service technician.

Complete the following steps to install a management module at the front of the BladeCenter T unit:

1. Read the safety information beginning on page v and “Installation guidelines” on page 7 through “Handling static-sensitive devices” on page 8.
2. If you are installing a second management module, read “Preparing for management-module redundancy” on page 10.
3. If you are replacing the only management module in the BladeCenter T unit and the management module is functional, you might want to save the configuration file to another medium before you proceed.
  - To save the configuration file, click **Configuration File** under the **MM Control** section in the navigation pane and follow the instructions under **Backup MM Configuration**.
  - To restore the saved configuration file to the replacement management module, click **Configuration File** under the **MM Control** section in the navigation pane and follow the instructions under **Restore MM Configuration**).

See the *IBM @server BladeCenter T Management Module User's Guide* for more information.



4. Remove the bezel assembly from the front of the BladeCenter T unit by forcefully pulling forward on the blue touch points at the top sides of the bezel.

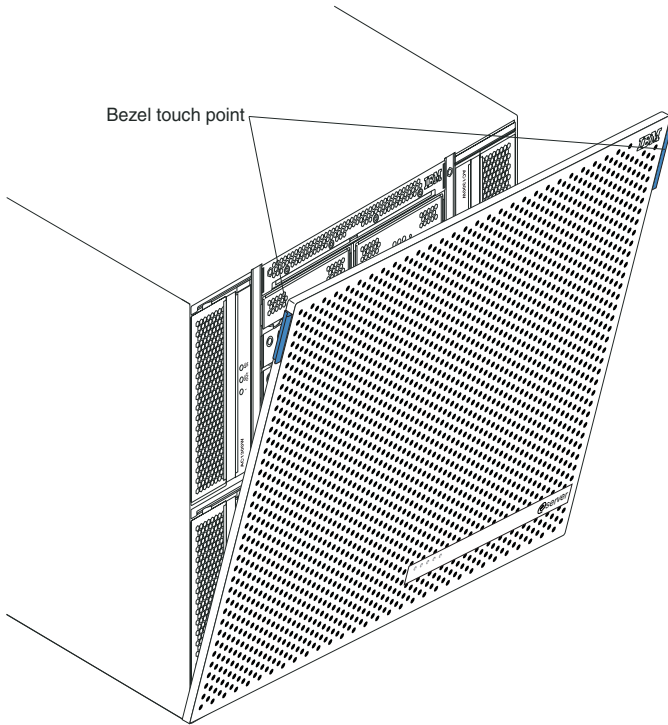

5. Pull the bezel outward from the top and then lift it up and away from the BladeCenter T unit. Carefully set the bezel aside in a safe location.
6. If you are replacing a management module, remove the current module from the bay (see “Removing a management module” on page 16). If you are adding a management module, remove the filler module from the selected management-module bay and store the filler module for future use.

7. Connect an ESD wrist strap to the ESD connector at the front of the BladeCenter T unit (see the illustration on page 9 for the location of the ESD connector) and place the wrist strap around your wrist. If you have not already done so, touch the static-protective package that contains the management module to an unpainted metal part of the BladeCenter T unit or any unpainted surface on any other grounded rack component for at least 2 seconds.
8. Remove the management module from its static-protective package.

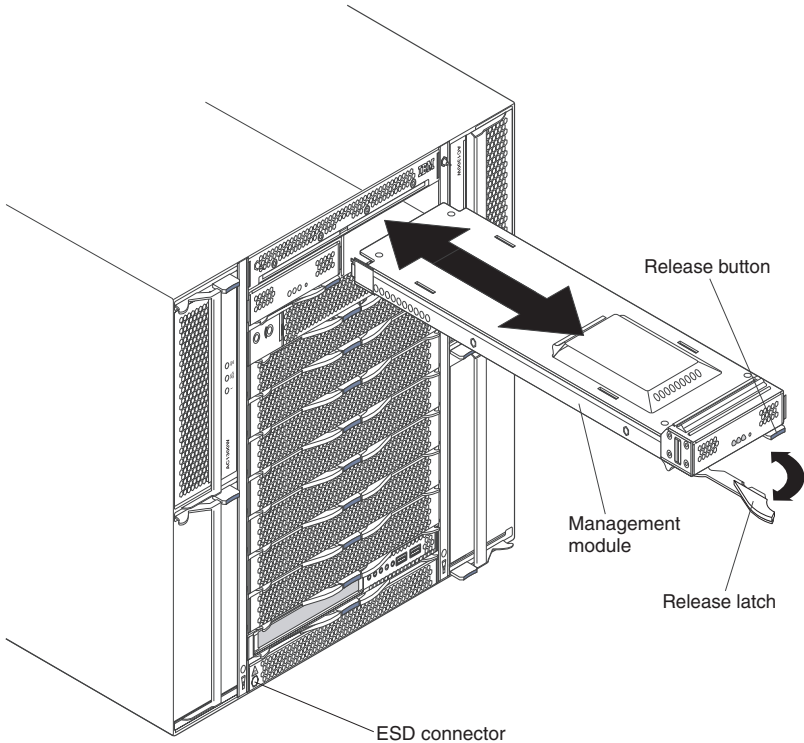

9. Press the blue release button on the management module to open the release latch. Make sure that the release latch on the management module is in the open position (parallel to the module).
10. Holding the management module at the front with one hand and in the middle with the other hand, align the management module with the management-module bay. The side of the management module with the release latch must be facing down.
11. Gently slide the management module into the selected management-module bay until it stops. Push the management module in the rest of the way until the latch starts to close.

12. Push the release latch on the front of the management module to the closed position.
13. Make sure that the Error LED on each management module is not lit, indicating that the management module is operating correctly.
14. Install the bezel assembly on the front of the BladeCenter T unit by inserting the bottom bezel hooks into the bezel slots at the bottom of the unit.
15. Push in the bottom and the top of the bezel assembly until they both lock firmly into place.
16. If this is the only management module in the BladeCenter T unit, configure the new management module. See Chapter 4, “Configuring the management module,” on page 29 for more information. If this is the secondary management module and you followed the instructions in “Preparing for management-module redundancy” on page 10, no configuring is necessary. The secondary management module receives the configuration and status information automatically from the primary management module when necessary. However, you must apply the latest level of firmware from the IBM Support Web site to ensure smooth changeovers; return to “Preparing for management-module redundancy” on page 10 for instructions.

**Note:** Do not initiate any management-module changeover for approximately 2 minutes after installing the secondary management module; the secondary management module needs the time to receive initial configuration and status information.

---

## Removing a management module

Statement 8:



### CAUTION:

Never remove the cover on a power supply or any part that has the following label attached.



Hazardous voltage, current, and energy levels are present inside any component that has this label attached. There are no serviceable parts inside these components. If you suspect a problem with one of these parts, contact a service technician.

Complete the following steps to remove a management module.

### Note:

- These instructions assume that the BladeCenter T unit is connected to power.
- If you are removing the only management module in the BladeCenter T unit, you might prefer to stop all management-module local and remote sessions before proceeding, to avoid unexpected termination of sessions.
- If you are removing the only management module in the BladeCenter T unit, be aware that as soon as you remove the module from the BladeCenter T unit, the blowers will increase to full speed.
- If you are replacing the only management module in the BladeCenter T unit and the management module is functional, you might want to save the configuration file to another medium before you proceed (under the MM Control section in the navigation pane, click **Configuration File** and follow the instructions under **Backup MM Configuration**). You will be able to restore the saved configuration file to the replacement management module (under the MM Control section in the navigation pane, click **Configuration File** and follow

the instructions under **Restore MM Configuration**). See the *IBM @server BladeCenter T Management Module User's Guide* for more information.

- If you have just installed a second management module in the BladeCenter T unit, do not remove the first (primary) management module for approximately 2 minutes; the second (secondary) management module needs the time to receive initial configuration and status information and make sure that the firmware levels match.
1. Read the safety information beginning on page v and “Installation guidelines” on page 7 through “Handling static-sensitive devices” on page 8.
  2. Remove the bezel from the front of the BladeCenter T unit (see step 4 on page 13 for instructions).
  3. Connect an ESD wrist strap to the ESD connector at the front of the BladeCenter T unit (see the illustration on page 9 for the location of the ESD connector) and place the wrist strap around your wrist.
  4. Press the blue release button at the front of the management module.
  5. Pull the release latch all the way toward the left side of the management module until it stops, as shown in the illustration. The management module moves slightly out of the bay.

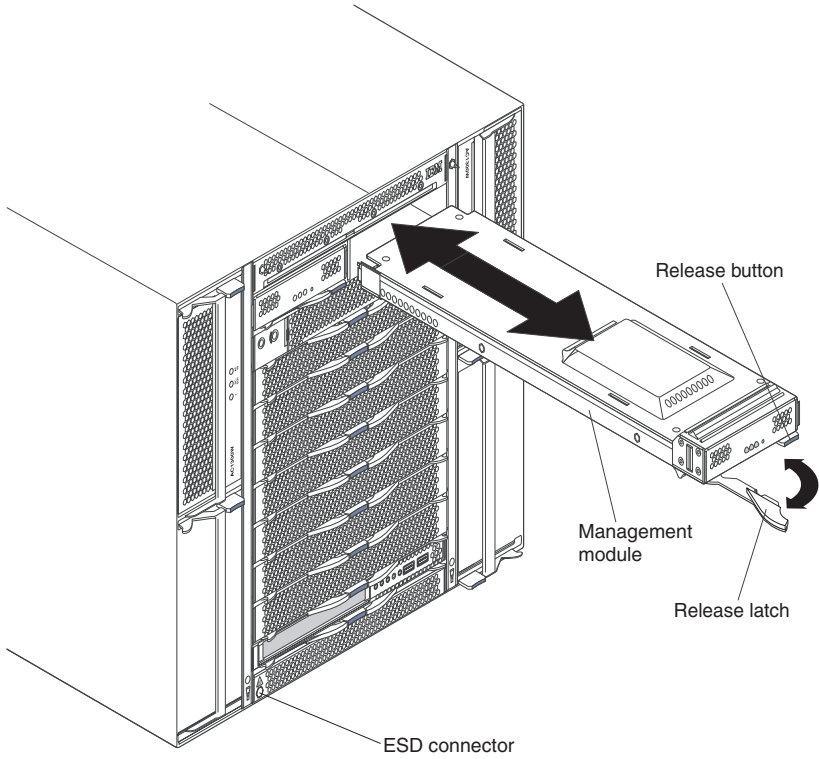

6. Slide the management module out of the bay and set it aside. Within 1 minute, place either another management module or a filler module in the bay.
7. If you placed another management module in the bay, verify that the error LED on the management module is not lit.
8. If you have not already done so, configure the replacement management module. See Chapter 4, “Configuring the management module,” on page 29 for more information.

---

## Cabling the KVM and LAN modules

The KVM (keyboard, video, mouse) module provides the electrical and mechanical interface to the BladeCenter T unit for a local keyboard, video monitor, and mouse. The KVM module also has LEDs that display BladeCenter T unit status at the rear of the BladeCenter T unit. These LEDs display the same information as the LEDs on the media tray in the front of the BladeCenter T unit.

The LAN module provides the electrical and mechanical interface to the BladeCenter T unit for the two local area network (Ethernet) connections, driven from each BladeCenter T management module, and the Telco external alarms. There is a separate dedicated LAN connector for each management module, and both must be connected to the active management network to have complete management-module redundancy. Both the KVM and LAN modules are at the rear of the BladeCenter T unit.

The BladeCenter T management module controls the KVM module and the LAN module. When two management modules are installed in the BladeCenter T unit, only one management module is active; the second management module, if present, provides redundancy. The active management module is the primary module; the redundant management module is the secondary module. If the primary management module fails or if you request a changeover through the Web interface, the secondary management module becomes active and primary and takes over the control of the KVM and LAN modules.

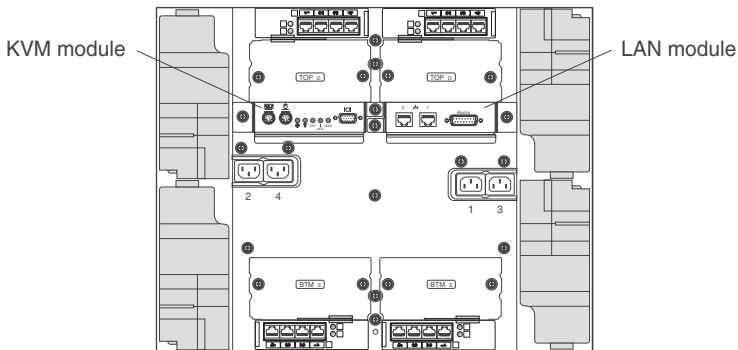

### Cabling the KVM module ports

Connect the keyboard, video, and mouse to the appropriate connectors on the KVM module (see the “KVM (keyboard, video, mouse) module indicators and input/output connectors” on page 24 for more information) The KVM connectors are automatically connected to the primary management module.

If you always use a remote session to communicate with the blade servers in the BladeCenter T unit, you do not have to connect a local keyboard, monitor, and mouse to the KVM module (see the *BladeCenter Management Module User's Guide* for information about remote sessions).

## Cabling the LAN module Ethernet ports

**Note:** To make sure that the BladeCenter T unit installation complies with EMC product regulations for intra-building lightning surges, you must use shielded LAN cables that are grounded at both ends.

You can connect directly to an Ethernet port on a personal computer (PC) using a cross-over cable, or you can make the connection through an Ethernet switch. Both connection methods are shown in the following illustration.

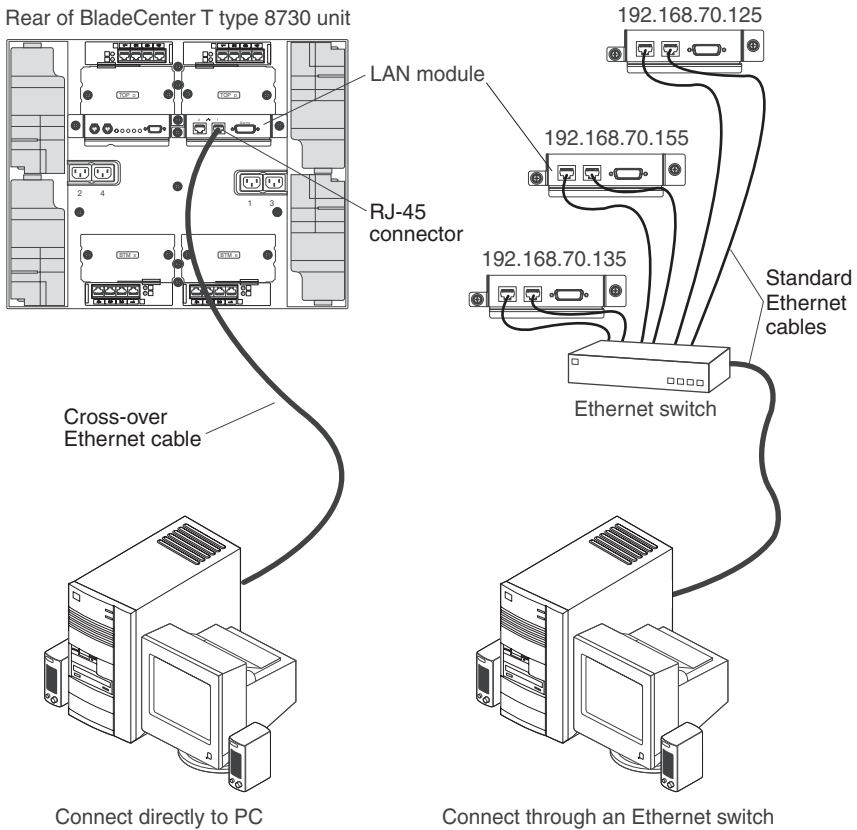

The right Ethernet port on the LAN module is driven by management module 1 (MM 1), and the left Ethernet port of the LAN module is driven by management module 2 (MM 2). By connecting both Ethernet ports (MM 1 and



MM 2) to your management network, you can communicate with the new primary management module when changeover occurs.

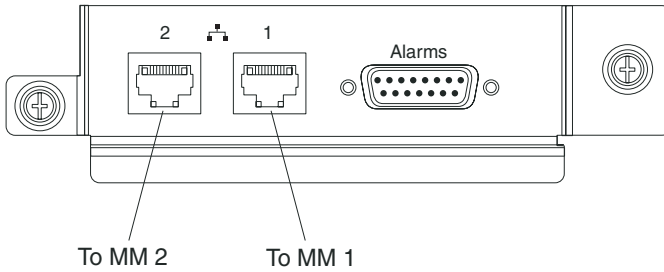

Complete the following steps to connect the Ethernet cable to the management module.

1. Connect one end of a Category 5 or higher Ethernet cable to an Ethernet connector on the LAN module. Connect the other end of an Ethernet cable to the network.
2. Check the Ethernet LEDs to make sure that the network connection is working. The Ethernet link LED indicates that there is an active connection through the port to the network. The Ethernet activity LED indicates that there is activity through the port over the network link. The following illustration shows the locations of the Ethernet LEDs on the LAN module.

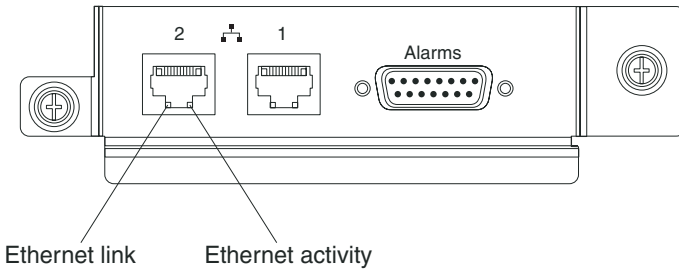



---

## Chapter 3. Management, KVM, and LAN module LEDs and external ports

This chapter describes the LEDs and controls on the BladeCenter T management modules, KVM modules, and LAN modules. This chapter also identifies the external ports on the KVM and LAN modules.

---

### Management module controls and indicators

These management-module controls and indicators provide status information about the management module and remote management connection. For additional information, see the *Hardware Maintenance Manual and Troubleshooting Guide* on the IBM BladeCenter T Documentation CD.

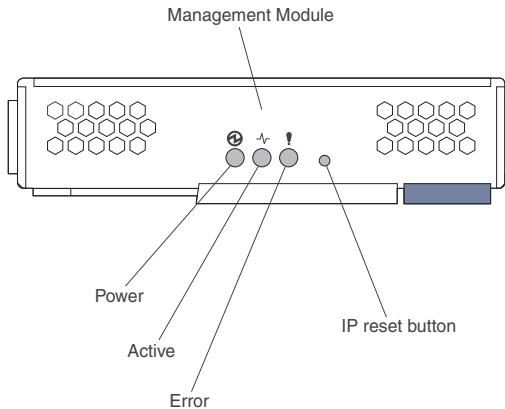

**Management-module LEDs:** These LEDs provide status information about the management module and remote management connection.

- **Power:** When this green LED is lit, it indicates that the management module has power.
- **Active:** When this green LED is lit, it indicates that the management module is actively controlling the BladeCenter T unit. Only one management module actively controls the BladeCenter T unit. If two management modules are installed in the BladeCenter T unit, this LED is lit on only one.
- **Error:** When this amber LED is lit, it indicates that an error has been detected somewhere on the management module. When this LED is lit, the system error LED (critical, major, or minor) on each of the BladeCenter T system-status panels is also lit.

**Management-module IP reset button:** *Do not* press this button unless you intend to erase your configured IP addresses for the management module and lose connection with the remote management station, the switch modules, and

the blade servers. If you press this button, you will have to reconfigure the management module settings (see the information beginning with Chapter 4, “Configuring the management module,” on page 29 for instructions).

Press this recessed button to reset the IP configuration of the management module network interfaces (Ethernet 1, Ethernet 2, gateway address, and so on) to the factory defaults and then restart the management module.

Use a straightened paper clip to press the button.

---

## KVM (keyboard, video, mouse) module indicators and input/output connectors

The KVM module is a hot-swap module that is installed on the rear of the BladeCenter T unit and is held in place by captive thumbscrews. This module contains two PS/2-style connectors for the keyboard and mouse, a system-status panel, and an HD-15 video connector.

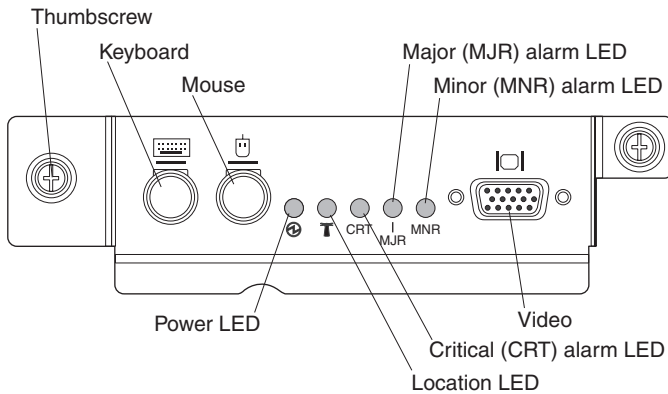

**System-status LEDs:** These LEDs provide status information for the BladeCenter T unit.

- **Power:** When continuously lit, this green LED indicates the presence of power in the BladeCenter T unit. The LED turns off when the power source is interrupted.

**Attention:** If the power LED is off, it does not mean electrical power is not present in the BladeCenter T unit. The LED circuitry might be faulty. To remove all electrical power from the BladeCenter T unit, you must disconnect all power cords from all power modules.

- **Location:** This blue LED is for system identification. A system administrator or servicer uses this LED to locate a specific BladeCenter T unit for service or repair. You can turn on, turn off, or flash the location LED through the Web interface or a remote management console.

**Alarm LEDs:** These LEDs provide alarm notifications for the BladeCenter T unit.

- **CRT (Critical alarm, amber or red):** When continuously lit, this LED indicates the presence of a critical system fault. The system is configured with amber as the default. See the *BladeCenter T Management Module User's Guide* for information on setting the color of this LED.

A critical system fault is an error or event that is unrecoverable or that results in a loss of redundancy. In these cases, the system might not continue to operate. An example is the loss of a redundant power supply.

- **MJR (Major alarm, amber or red):** When continuously lit, this LED indicates the presence of a major system fault. The system comes with amber as the default. See the *BladeCenter T Management Module User's Guide* for information on setting the color of this LED.

A major system fault is an error or event that has a detectable impact to system operation. In this case, the system can continue to operate but with reduced performance. An example is the loss of one of two mirrored disks.

- **MNR (Minor alarm, amber):** When continuously lit, this LED indicates the presence of a minor system fault. A minor system fault is an error or event that has little impact to system operation. An example is a correctable ECC error.

**Connectors:** The KVM module has the following I/O connectors. Only one blade server at a time can be connected to the KVM connectors. The blade server that is connected to the KVM connectors is the same blade server that is connected to the management-module remote-console interface.

- **Keyboard connector:** The BladeCenter T KVM module contains one PS/2-style keyboard connector.

Use this connector to connect a PS/2 keyboard to the BladeCenter T unit.

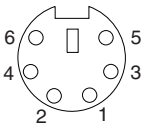

- **Mouse connector:** The BladeCenter T KVM module contains one PS/2-style mouse connector.

Use this connector to connect a PS/2 mouse to the BladeCenter T unit.

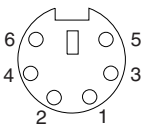

- **Video connector:** The BladeCenter T KVM module contains one standard video connector. The integrated video controller on each blade server is compatible with SVGA and VGA and communicates through this video port.

Use this connector to connect a video monitor to the BladeCenter T unit.

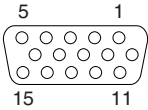

## LAN-module indicators and input/output connectors

The LAN module is a hot-swap module that is installed on the rear of the BladeCenter T unit and is held in place by captive thumbscrews. The LAN module provides the electrical and mechanical interface to the BladeCenter T unit for the two local area network (Ethernet) connections, as driven from each management module, and the Telco external alarms. This module contains two RJ-45 connectors with LEDs and one DB-15P (male) Telco alarm connector.

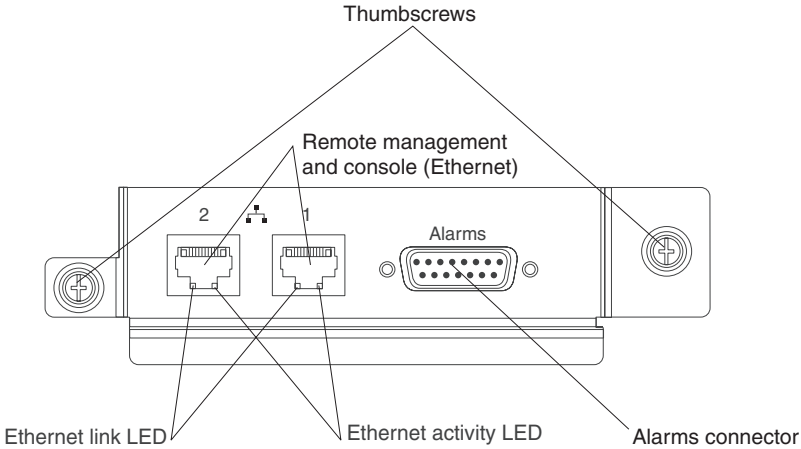

**LAN-module LEDs:** These LEDs provide status information about the LAN connection:

- **Ethernet link:** When this green LED is lit, there is an active connection through the port to the network.
- **Ethernet activity:** When this green LED is flashing, it indicates that there is activity through the port over the network link.

### LAN-module connectors:

- **Remote management and console (Ethernet) connectors:** The LAN module provides two Ethernet RJ-45 connectors.

The BladeCenter T LAN module contains two 10/100 Mb Ethernet connectors that provide the remote connections, driven from each management module, to the network management station on the network.

Use these ports for remote management and remote console.

The network management station, through these connectors, can access control functions running in the management module, the service processor on each blade server, or within each I/O module. However, it cannot use these ports to communicate with application programs running in the blade servers. The network management station must direct those communications through a network connected to the external ports in the I/O modules in the BladeCenter T unit.

- Alarms connector:** The LAN module provides one Telco DB-15P (male) alarms connector for critical, major, and minor Telco alarms. Each of the alarms has a relay that enables multiple system alarm indicators to be daisy-chained together. Table 1 shows the pinouts for the Telco alarms connector.

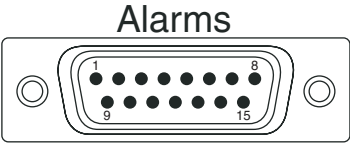

**Note:** The external alarm reset inputs (major and minor) reset the alarm relays in the BladeCenter T unit, but do not reset the alarm condition of the BladeCenter T unit. Alarm conditions within the BladeCenter T unit must be reset through the management-module Web interface or command-line interface.

Table 1. Telco alarms connector pinout

Pin #	Description	I/O
1	Minor alarm reset +	I
2	Minor alarm reset -	I
3	Major alarm reset +	I
4	Major alarm reset -	I
5	Critical alarm normally open	O
6	Critical alarm normally closed	O
7	Critical alarm common	O
8	Minor alarm normally open	O
9	Minor alarm normally closed	O
10	Minor alarm common	O
11	Major alarm normally open	O
12	Major alarm normally closed	O
13	Major alarm common	O
14	Reserved	
15	Reserved	

The electrical specifications for the alarms connector are as follows:

– **Outputs**

- Voltage range: 0 V dc to -100 V dc (maximum current 0.3 A at 100 V dc)
- Current range: 0 A to 1 A (maximum voltage 30 V dc at 1 A)
- Worst-case VA: 1 A at -30 V dc (30 VA maximum) indefinitely

– **Inputs**

- Voltage range: 0 V dc to -100 V dc (including transients)
- Differential input voltage: 3 V dc to 72 V dc

– **Reset input activation**

Pulse width: 200 ms (minimum) to 300 ms



---

## Chapter 4. Configuring the management module

The BladeCenter T unit automatically detects the modules and blade servers that are installed and reads their vital product data (VPD). When the BladeCenter T unit is started, the management module automatically configures the remote management port on the management module, accessed through the LAN module on the rear of the BladeCenter T unit, so that you can configure and manage the BladeCenter T unit and blade servers. You configure and manage the BladeCenter T unit remotely, through the management module, using the Web-based user interface.

After you connect the active management module to the network, the Ethernet port connection is configured in one of the following ways:

- If you have an accessible, active, and configured dynamic host configuration protocol (DHCP) server on the network, the host name, IP address, gateway address, subnet mask, and DNS server IP address are set automatically.
- If the DHCP server does not respond within 2 minutes after the port is connected, the management module uses the factory-defined static IP address and default subnet address.

Either of these actions enables the Ethernet connection on the active management module.

The management module supports the following Web browsers for remote (client) access. The client Web browser that you use must be Java™-enabled, must support JavaScript™ 1.2 or later, and must have the Java Virtual Machine (JVM) 1.4.1 or later Plug-in installed. The JVM Plug-in is available at the Java Web site at <http://www.java.com/>.

- Microsoft Internet Explorer 5.5, or later (with latest Service Pack installed)
- Netscape Navigator 7.0, or later
- Mozilla version 1.3, or later

The following server operating systems have USB support, which is required for the Remote Control feature.

- Microsoft Windows Server 2003
- Microsoft Windows 2000 with Service Pack 4 or later
- Red Hat Linux version 7.3
- SUSE LINUX version 8.0
- Novell NetWare 6.5

**Note:** The Remote Disk feature works with only the Microsoft Windows 2000 operating system.

To use the Remote Control feature, the client system must also have an Intel<sup>™</sup> Pentium<sup>®</sup> III or later microprocessor operating at 700 MHz or faster (or an equivalent microprocessor).

The management-module Web interface does not support the double-byte character set (DBCS) languages.

---

## Starting the management and configuration program

Complete the following steps to start the management and configuration program:

1. Open a Web browser. In the address or URL field, type the IP address or host name defined for the management module remote connection. (Your computer must be on the same subnet as the management module.)  
The Enter Network Password window opens.
2. Type your user name and password. If you are logging in to the management module for the first time, you can obtain your user name and password from your system administrator. All login attempts are documented in the event log.

**Note:** The initial user ID and password for the management module are:

- User ID: USERID (all capital letters)
  - Password: PASSWORD (note the zero, not O, in PASSWORD)
3. Follow the instructions that appear on the screen. Be sure to set the timeout value you want for your Web session.

The BladeCenter T management and configuration window opens.

**BladeCenter T Management Module**

Bay 1: SN#01

**System Status Summary**

● System is operating normally. All monitored parameters are OK.

The following links can be used to view the status of different components.

[Blade Servers](#)  
[I/O Modules](#)  
[Management Modules](#)  
[Power Modules](#)  
[Blowers](#)

**Blade Servers**

Click the icon in the Status column to view detailed information about each blade server.

Bay	Status	Name	Pwr	Owner <sup>***</sup>		Network		WOL <sup>*</sup>	Local Control			BSE <sup>**</sup>
				KVM	MT <sup>†</sup>	Onboard	Card		Pwr	KVM	MT <sup>†</sup>	
1	●	SN#K10V7363140	Off			Eth	---   ---	On	X	X	X	
2	●	SN#K10V7364105	Off			Eth	---   ---	On	X	X	X	
3	●	Blade 04	Off			Eth	---   ---	On	X	X	X	
4		No blade present										
5		No blade present										
6	●	SN#K10UJ353166	Off	X	X	Eth	---   ---	On	X	X	X	
7		No blade present										
8		No blade present										

<sup>\*</sup> MT = Media Tray (CD/USB) , WOL = Wake on LAN , BEM = Blade Expansion Module ,  
<sup>\*\*</sup> BSE = Blade Storage Expansion , BPE = Blade PCI Expansion  
<sup>\*\*\*</sup> You can change the KVM and Media Tray ownership on the Remote Control panel (under Blade Tasks).

The navigation pane (on the left side of the management module window) contains navigational links that you use to manage your BladeCenter T unit and check the status of the components (modules and blade servers).

## Configuring the management module

Use your Web browser to connect to the management module (see the *IBM @server BladeCenter Management Module User's Guide* for information). In the browser **Address** field, specify the IP address the management module is using:

- If the IP address was assigned through a DHCP server, get the IP address from your network administrator.
- The factory-defined static IP address is 192.168.70.125, the default subnet address is 255.255.255.0, and the default host name is MMxxxxxxxxxxx, where xxxxxxxxxxxx is the burned-in medium access control (MAC) address. The MAC address is on a label on the front of the management module, above the LEDs, as shown in the following illustration.

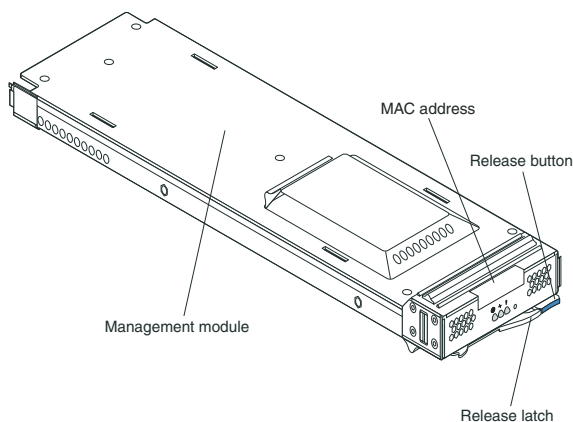

**Note:** If the IP configuration is assigned by the DHCP server, the network administrator can use the MAC address of the management module network interface to find out what IP address and host name are assigned.

**Important:** You configure only the primary (active) management module. The secondary management module receives the configuration and status information automatically from the primary management module when necessary. The configuration information in this chapter applies to the primary management module, which might be the only management module installed in the BladeCenter T unit.

If the management module that you installed is a replacement for the only management module in the BladeCenter T unit, and you saved the configuration file before replacing the management module, you can restore the saved configuration file to the replacement management module using the management module Web interface. See the *IBM @server BladeCenter Management Module User's Guide* for information about saving and restoring configuration files.

**Note:** There are two ways to configure the I/O modules; through the management-module Web interface, or through an external switch-module port enabled through the management module, using a Telnet interface or a Web browser. See the documentation that comes with the switch module for more information.

For the active management module to communicate with the I/O modules in the BladeCenter T unit, you must configure the IP addresses for the following internal and external ports:

- The external Ethernet (remote management) port on the management module, accessed through the LAN module on the rear of the BladeCenter T unit (see the *IBM @server BladeCenter Management Module User's Guide* for information). The initial management module autoconfiguration enables the network management station to connect to the management module to configure the port completely and to configure the rest of the BladeCenter T unit.
- The internal Ethernet port on the management module for communication with the I/O modules (see the *IBM @server BladeCenter Management Module User's Guide* for information).
- The management port on each switch module provides for communication with the management module. You configure this port by configuring the IP address for the switch module (see the *IBM @server BladeCenter Management Module User's Guide* for information).

**Note:** Some types of I/O modules, such as the pass-thru module, have no management port.

See the documentation that comes with the I/O module to determine what else you must configure in the I/O module.

To communicate with the blade servers for functions such as deploying an operating system or application program over the external network, you must also configure at least one external (in-band) port on an Ethernet switch module in I/O-module bay 1 or 2. See the *Installation and User's Guide* for your BladeCenter T unit for general information about configuring the external ports on Ethernet I/O modules.

The Web-based user interface communicates with the management and configuration program that is part of the firmware that comes with the management module. You can use this program to perform the following tasks:

- Defining the login IDs and passwords.
- Selecting recipients for alert notification of specific events.
- Monitoring the status of the BladeCenter T unit and blade servers.
- Controlling the BladeCenter T unit and blade servers.
- Accessing the I/O modules to configure them.
- Changing the startup sequence in a blade server.
- Setting the date and time.
- Using a remote console for the blade servers.
- Changing ownership of the keyboard, video, and mouse.

- Changing ownership of the optical drive and USB ports. (The optical drive in the BladeCenter T unit is viewed as a USB device by the blade server operating system.)
- Activating On Demand blade servers.
- Setting the active color of the critical (CRT) and major (MJR) alarm LEDs

See the *IBM @server BladeCenter Management Module User's Guide* for detailed instructions for using the management and configuration program for the active management module and configuring external ports on Ethernet switch modules. You also can use the management and configuration program to view some of the blade server configuration settings.

---

## Appendix A. Getting help and technical assistance

If you need help, service, or technical assistance or just want more information about IBM products, you will find a wide variety of sources available from IBM to assist you. This appendix contains information about where to go for additional information about IBM and IBM products, what to do if you experience a problem with your IBM system, and whom to call for service, if it is necessary.

---

### Before you call

Before you call, make sure that you have taken these steps to try to solve the problem yourself:

- Check all cables to make sure that they are connected.
- Check the system and module LEDs to make sure that the system is turned on.
- Use the troubleshooting information in your system documentation, and use the diagnostic tools that come with your system. Information about diagnostic tools is in the *Hardware Maintenance Manual and Troubleshooting Guide* on the IBM BladeCenter T Documentation CD.
- Go to the IBM Support Web site at <http://www.ibm.com/pc/support/> to check for technical information, hints, tips, and new device drivers or to submit a request for information.

You can solve many problems without outside assistance by following the troubleshooting procedures that IBM provides in the online help or in the publications that are provided with your system and software. The information that comes with your system also describes the diagnostic tests that you can perform. Most IBM systems, operating systems, and programs come with information that contains troubleshooting procedures and explanations of error messages and error codes. If you suspect a software problem, see the information for the operating system or program.

---

### Using the documentation

Information about your IBM system and preinstalled software, if any, is available in the documentation that comes with your system. That documentation includes printed books, online books, readme files, and help files. See the troubleshooting information in your system documentation for instructions for using the diagnostic programs. The troubleshooting information or the diagnostic programs might tell you that you need additional or updated device drivers or other software. IBM maintains pages on the World Wide Web where you can get the latest technical information and

download device drivers and updates. To access these pages, go to <http://www.ibm.com/pc/support/> and follow the instructions. Also, you can order documents through the IBM Publications Ordering System at <http://www.elink.ibmblink.ibm.com/public/applications/publications/cgibin/pbi.cgi>.

---

## Getting help and information from the World Wide Web

On the World Wide Web, the IBM Web site has up-to-date information about IBM products, services, and support. The address for IBM xSeries information is <http://www.ibm.com/eserver/xseries/>. The address for IBM IntelliStation<sup>®</sup> information is <http://www.ibm.com/pc/intellistation/>. The address for IBM BladeCenter T information is <http://www.ibm.com/eserver/bladecenter/>.

You can find service information for your IBM products, including supported options, at <http://www.ibm.com/pc/support/>.

---

## Software service and support

Through IBM Support Line, you can get telephone assistance, for a fee, with usage, configuration, and software problems with IBM servers, workstations, and appliances. For information about which products are supported by Support Line in your country or region, go to <http://www.ibm.com/services/sl/products/>.

For more information about Support Line and other IBM services, go to <http://www.ibm.com/services/>, or go to <http://www.ibm.com/planetwide/> for support telephone numbers. In the U.S. and Canada, call 1-800-IBM-SERV (1-800-426-7378).

---

## Hardware service and support

You can receive hardware service through IBM Services or through your IBM reseller, if your reseller is authorized by IBM to provide warranty service. Go to <http://www.ibm.com/planetwide/> for support telephone numbers, or in the U.S. and Canada, call 1-800-IBM-SERV (1-800-426-7378).

In the U.S. and Canada, hardware service and support is available 24 hours a day, 7 days a week. In the U.K., these services are available Monday through Friday, from 9 a.m. to 6 p.m.



---

## Appendix B. IBM Statement of Limited Warranty Z125-4753-08 04/2004

---

### Part 1 - General Terms

#### Part 1 - General Terms

*This Statement of Limited Warranty includes Part 1 - General Terms, Part 2 - Country-unique Terms, and Part 3 - Warranty Information. The terms of Part 2 replace or modify those of Part 1. The warranties provided by IBM in this Statement of Limited Warranty apply only to Machines you purchase for your use, and not for resale. The term "Machine" means an IBM machine, its features, conversions, upgrades, elements, or accessories, or any combination of them. The term "Machine" does not include any software programs, whether pre-loaded with the Machine, installed subsequently or otherwise. **Nothing in this Statement of Limited Warranty affects any statutory rights of consumers that cannot be waived or limited by contract.***

#### What this Warranty Covers

IBM warrants that each Machine 1) is free from defects in materials and workmanship and 2) conforms to IBM's Official Published Specifications ("Specifications") which are available on request. The warranty period for the Machine starts on the original Date of Installation and is specified in Part 3 - Warranty Information. The date on your invoice or sales receipt is the Date of Installation unless IBM or your reseller informs you otherwise. Many features, conversions, or upgrades involve the removal of parts and their return to IBM. A part that replaces a removed part will assume the warranty service status of the removed part. Unless IBM specifies otherwise, these warranties apply only in the country or region in which you purchased the Machine.

**THESE WARRANTIES ARE YOUR EXCLUSIVE WARRANTIES AND REPLACE ALL OTHER WARRANTIES OR CONDITIONS, EXPRESS OR IMPLIED, INCLUDING, BUT NOT LIMITED TO, THE IMPLIED WARRANTIES OR CONDITIONS OF MERCHANTABILITY AND FITNESS FOR A PARTICULAR PURPOSE. SOME STATES OR JURISDICTIONS DO NOT ALLOW THE EXCLUSION OF EXPRESS OR IMPLIED WARRANTIES, SO THE ABOVE EXCLUSION MAY NOT APPLY TO YOU. IN THAT EVENT, SUCH WARRANTIES ARE LIMITED IN DURATION TO THE WARRANTY PERIOD. NO WARRANTIES APPLY AFTER THAT PERIOD. SOME STATES OR JURISDICTIONS DO NOT ALLOW LIMITATIONS ON HOW LONG AN IMPLIED WARRANTY LASTS, SO THE ABOVE LIMITATION MAY NOT APPLY TO YOU.**

#### What this Warranty Does not Cover

This warranty does not cover the following:

- any software programs, whether pre-loaded or shipped with the Machine, or installed subsequently;
- failure resulting from misuse (including but not limited to use of any Machine capacity or capability, other than that authorized by IBM in writing), accident, modification, unsuitable physical or operating environment, or improper maintenance by you;
- failure caused by a product for which IBM is not responsible; and
- any non-IBM products, including those that IBM may procure and provide with or integrate into an IBM Machine at your request.

The warranty is voided by removal or alteration of identification labels on the Machine or its parts.

IBM does not warrant uninterrupted or error-free operation of a Machine.

Any technical or other support provided for a Machine under warranty, such as assistance with “how-to” questions and those regarding Machine set-up and installation, is provided **WITHOUT WARRANTIES OF ANY KIND**.

### **How to Obtain Warranty Service**

If the Machine does not function as warranted during the warranty period, contact IBM or your reseller to obtain warranty service. If you do not register the Machine with IBM, you may be required to present proof of purchase as evidence of your entitlement to warranty service.

### **What IBM Will Do to Correct Problems**

When you contact IBM for service, you must follow the problem determination and resolution procedures that IBM specifies. An initial diagnosis of your problem can be made either by a technician over the telephone or electronically by access to an IBM website.

The type of warranty service applicable to your Machine is specified in Part 3 - Warranty Information.

You are responsible for downloading and installing designated Machine Code (microcode, basic input/output system code (called “BIOS”), utility programs, device drivers, and diagnostics delivered with an IBM Machine) and other software updates from an IBM Internet Web site or from other electronic media, and following the instructions that IBM provides.

If your problem can be resolved with a Customer Replaceable Unit (“CRU”) (e.g., keyboard, mouse, speaker, memory, hard disk drive), IBM will ship the CRU to you for you to install.

If the Machine does not function as warranted during the warranty period and your problem cannot be resolved over the telephone or electronically, through your application of Machine Code or software updates, or with a CRU, IBM or your reseller, if approved by IBM to provide warranty service, will either, at its discretion, 1) repair it to make it function as warranted, or 2) replace it with one that is at least functionally equivalent. If IBM is unable to do either, you may return the Machine to your place of purchase and your money will be refunded.

IBM or your reseller will also manage and install selected engineering changes that apply to the Machine.

### **Exchange of a Machine or Part**

When the warranty service involves the exchange of a Machine or part, the item IBM or your reseller replaces becomes its property and the replacement becomes yours. You represent that all removed items are genuine and unaltered. The replacement may not be new, but will be in good working order and at least functionally equivalent to the item replaced. The replacement assumes the warranty service status of the replaced item.

### **Your Additional Responsibilities**

Before IBM or your reseller exchanges a Machine or part, you agree to remove all features, parts, options, alterations, and attachments not under warranty service.

You also agree to:

1. ensure that the Machine is free of any legal obligations or restrictions that prevent its exchange;
2. obtain authorization from the owner to have IBM or your reseller service a Machine that you do not own; and
3. where applicable, before service is provided:
  - a. follow the service request procedures that IBM or your reseller provides;
  - b. backup or secure all programs, data, and funds contained in the Machine;
  - c. provide IBM or your reseller with sufficient, free, and safe access to your facilities to permit IBM to fulfill its obligations; and
  - d. inform IBM or your reseller of changes in the Machine's location.
4. (a) ensure all information about identified or identifiable individuals (Personal Data) is deleted from the Machine (to the extent technically possible), (b) allow IBM, your reseller or an IBM supplier to process on your behalf any remaining Personal Data as IBM or your reseller considers necessary to fulfill its obligations under this Statement of Limited Warranty (which may include shipping the Machine for such processing to other IBM

service locations around the world), and (c) ensure that such processing complies with any laws applicable to such Personal Data.

### Limitation of Liability

IBM is responsible for loss of, or damage to, your Machine only while it is 1) in IBM's possession or 2) in transit in those cases where IBM is responsible for the transportation charges.

Neither IBM nor your reseller are responsible for any of your confidential, proprietary or personal information contained in a Machine which you return to IBM for any reason. You should remove all such information from the Machine prior to its return.

Circumstances may arise where, because of a default on IBM's part or other liability, you are entitled to recover damages from IBM. In each such instance, regardless of the basis on which you are entitled to claim damages from IBM (including fundamental breach, negligence, misrepresentation, or other contract or tort claim), except for any liability that cannot be waived or limited by applicable laws, IBM is liable for no more than

1. damages for bodily injury (including death) and damage to real property and tangible personal property; and
2. the amount of any other actual direct damages, up to the charges (if recurring, 12 months' charges apply) for the Machine that is subject of the claim. For purposes of this item, the term "Machine" includes Machine Code and Licensed Internal Code ("LIC").

This limit also applies to IBM's suppliers and your reseller. It is the maximum for which IBM, its suppliers, and your reseller are collectively responsible.

**UNDER NO CIRCUMSTANCES IS IBM, ITS SUPPLIERS OR RESELLERS LIABLE FOR ANY OF THE FOLLOWING EVEN IF INFORMED OF THEIR POSSIBILITY: 1) THIRD PARTY CLAIMS AGAINST YOU FOR DAMAGES (OTHER THAN THOSE UNDER THE FIRST ITEM LISTED ABOVE); 2) LOSS OF, OR DAMAGE TO, DATA; 3) SPECIAL, INCIDENTAL, OR INDIRECT DAMAGES OR FOR ANY ECONOMIC CONSEQUENTIAL DAMAGES; OR 4) LOST PROFITS, BUSINESS REVENUE, GOODWILL OR ANTICIPATED SAVINGS. SOME STATES OR JURISDICTIONS DO NOT ALLOW THE EXCLUSION OR LIMITATION OF INCIDENTAL OR CONSEQUENTIAL DAMAGES, SO THE ABOVE LIMITATION OR EXCLUSION MAY NOT APPLY TO YOU. SOME STATES OR JURISDICTIONS DO NOT ALLOW LIMITATIONS ON HOW LONG AN IMPLIED WARRANTY LASTS, SO THE ABOVE LIMITATION MAY NOT APPLY TO YOU.**

### Governing Law

Both you and IBM consent to the application of the laws of the country in which you acquired the Machine to govern, interpret, and enforce all of your and IBM's rights, duties, and obligations arising from, or relating in any manner to, the subject matter of this Statement of Limited Warranty, without regard to conflict of law principles.

**THESE WARRANTIES GIVE YOU SPECIFIC LEGAL RIGHTS AND YOU MAY ALSO HAVE OTHER RIGHTS WHICH VARY FROM STATE TO STATE OR JURISDICTION TO JURISDICTION.**

### **Jurisdiction**

All of our rights, duties, and obligations are subject to the courts of the country in which you acquired the Machine.

---

## **Part 2 - Country-unique Terms**

### **AMERICAS**

#### **ARGENTINA**

**Jurisdiction:** *The following is added after the first sentence:*

Any litigation arising from this Statement of Limited Warranty will be settled exclusively by the Ordinary Commercial Court of the city of Buenos Aires.

#### **BOLIVIA**

**Jurisdiction:** *The following is added after the first sentence:*

Any litigation arising from this Statement of Limited Warranty will be settled exclusively by the courts of the city of La Paz.

#### **BRAZIL**

**Jurisdiction:** *The following is added after the first sentence:*

Any litigation arising from this Statement of Limited Warranty will be settled exclusively by the court of Rio de Janeiro, RJ.

#### **CHILE**

**Jurisdiction:** *The following is added after the first sentence:*

Any litigation arising from this Statement of Limited Warranty will be settled exclusively by the Civil Courts of Justice of Santiago.

## COLOMBIA

**Jurisdiction:** *The following is added after the first sentence:*

Any litigation arising from this Statement of Limited Warranty will be settled exclusively by the Judges of the Republic of Colombia.

## EQUADOR

**Jurisdiction:** *The following is added after the first sentence:*

Any litigation arising from this Statement of Limited Warranty will be settled exclusively by the Judges of Quito.

## MEXICO

**Jurisdiction:** *The following is added after the first sentence:*

Any litigation arising from this Statement of Limited Warranty will be settled exclusively by the Federal Courts of Mexico City, Federal District.

## PARAGUAY

**Jurisdiction:** *The following is added after the first sentence:*

Any litigation arising from this Statement of Limited Warranty will be settled exclusively by the courts of the city of Asuncion.

## PERU

**Limitation of Liability:** *The following is added at the end of this section:*

In accordance with Article 1328 of the Peruvian Civil Code the limitations and exclusions specified in this section will not apply to damages caused by IBM's willful misconduct ("dolo") or gross negligence ("culpa inexcusable").

## URUGUAY

**Jurisdiction:** *The following is added after the first sentence:*

Any litigation arising from this Statement of Limited Warranty will be settled exclusively by the City of Montevideo Court's Jurisdiction.

## VENEZUELA

**Jurisdiction:** *The following is added after the first sentence:*

Any litigation arising from this Statement of Limited Warranty will be settled exclusively by the Courts of the Metropolitan Area Of the City of Caracas.

## NORTH AMERICA

**How to Obtain Warranty Service:** *The following is added to this Section:*

To obtain warranty service from IBM in Canada or the United States, call 1-800-IBM-SERV (426-7378).

### CANADA

**Limitation of Liability:** *The following replaces item 1 of this section:*

1. damages for bodily injury (including death) or physical harm to real property and tangible personal property caused by IBM's negligence; and

**Governing Law:** *The following replaces "laws of the country in which you acquired the Machine" in the first sentence:*  
laws in the Province of Ontario.

### UNITED STATES

**Governing Law:** *The following replaces "laws of the country in which you acquired the Machine" in the first sentence:*  
laws of the State of New York.

## ASIA PACIFIC

### AUSTRALIA

**What this Warranty Covers:** *The following paragraph is added to this section:*

The warranties specified in this Section are in addition to any rights you may have under the Trade Practices Act 1974 or other similar legislation and are only limited to the extent permitted by the applicable legislation.

**Limitation of Liability:** *The following is added to this section:*

Where IBM is in breach of a condition or warranty implied by the Trade Practices Act 1974 or other similar legislation, IBM's liability is limited to the repair or replacement of the goods or the supply of equivalent goods. Where that condition or warranty relates to right to sell, quiet possession or clear title, or the goods are of a kind ordinarily acquired for personal, domestic or household use or consumption, then none of the limitations in this paragraph apply.

**Governing Law:** *The following replaces "laws of the country in which you acquired the Machine" in the first sentence:*  
laws of the State or Territory.

## **CAMBODIA AND LAOS**

**Governing Law:** *The following replaces "laws of the country in which you acquired the Machine" in the first sentence:*  
laws of the State of New York, United States of America.

## **CAMBODIA, INDONESIA, AND LAOS**

**Arbitration:** *The following is added under this heading:*  
Disputes arising out of or in connection with this Statement of Limited Warranty shall be finally settled by arbitration which shall be held in Singapore in accordance with the Arbitration Rules of Singapore International Arbitration Center ("SIAC Rules") then in effect. The arbitration award shall be final and binding for the parties without appeal and shall be in writing and set forth the findings of fact and the conclusions of law.

The number of arbitrators shall be three, with each side to the dispute being entitled to appoint one arbitrator. The two arbitrators appointed by the parties shall appoint a third arbitrator who shall act as chairman of the proceedings. Vacancies in the post of chairman shall be filled by the president of the SIAC. Other vacancies shall be filled by the respective nominating party. Proceedings shall continue from the stage they were at when the vacancy occurred.

If one of the parties refuses or otherwise fails to appoint an arbitrator within 30 days of the date the other party appoints its, the first appointed arbitrator shall be the sole arbitrator, provided that the arbitrator was validly and properly appointed.

All proceedings shall be conducted, including all documents presented in such proceedings, in the English language. The English language version of this Statement of Limited Warranty prevails over any other language version.

## **HONG KONG S.A.R. OF CHINA AND MACAU S.A.R. OF CHINA**

**Governing Law:** *The following replaces "laws of the country in which you acquired the Machine" in the first sentence:*  
laws of Hong Kong Special Administrative Region of China.

## **INDIA**

**Limitation of Liability:** *The following replaces items 1 and 2 of this section:*



1. liability for bodily injury (including death) or damage to real property and tangible personal property will be limited to that caused by IBM's negligence; and
2. as to any other actual damage arising in any situation involving nonperformance by IBM pursuant to, or in any way related to the subject of this Statement of Limited Warranty, the charge paid by you for the individual Machine that is the subject of the claim. For purposes of this item, the term "Machine" includes Machine Code and Licensed Internal Code ("LIC").

**Arbitration:** *The following is added under this heading:*

Disputes arising out of or in connection with this Statement of Limited Warranty shall be finally settled by arbitration which shall be held in Bangalore, India in accordance with the laws of India then in effect. The arbitration award shall be final and binding for the parties without appeal and shall be in writing and set forth the findings of fact and the conclusions of law.

The number of arbitrators shall be three, with each side to the dispute being entitled to appoint one arbitrator. The two arbitrators appointed by the parties shall appoint a third arbitrator who shall act as chairman of the proceedings. Vacancies in the post of chairman shall be filled by the president of the Bar Council of India. Other vacancies shall be filled by the respective nominating party. Proceedings shall continue from the stage they were at when the vacancy occurred.

If one of the parties refuses or otherwise fails to appoint an arbitrator within 30 days of the date the other party appoints its, the first appointed arbitrator shall be the sole arbitrator, provided that the arbitrator was validly and properly appointed.

All proceedings shall be conducted, including all documents presented in such proceedings, in the English language. The English language version of this Statement of Limited Warranty prevails over any other language version.

## **JAPAN**

**Governing Law:** *The following sentence is added to this section:*

Any doubts concerning this Statement of Limited Warranty will be initially resolved between us in good faith and in accordance with the principle of mutual trust.

## **MALAYSIA**

**Limitation of Liability:** *The word "SPECIAL" in item 3 of the fifth paragraph is deleted.*

## NEW ZEALAND

**What this Warranty Covers:** *The following paragraph is added to this section:*

The warranties specified in this section are in addition to any rights you may have under the Consumer Guarantees Act 1993 or other legislation which cannot be excluded or limited. The Consumer Guarantees Act 1993 will not apply in respect of any goods which IBM provides, if you require the goods for the purposes of a business as defined in that Act.

**Limitation of Liability:** *The following is added to this section:*

Where Machines are not acquired for the purposes of a business as defined in the Consumer Guarantees Act 1993, the limitations in this section are subject to the limitations in that Act.

## PEOPLE'S REPUBLIC OF CHINA (PRC)

**Governing Law:** *The following replaces "laws of the country in which you acquired the Machine" in the first sentence:*

laws of the State of New York, United States of America (except when local law requires otherwise).

## PHILIPPINES

**Limitation of Liability:** *Item 3 in the fifth paragraph is replaced by the following:*

**SPECIAL (INCLUDING NOMINAL AND EXEMPLARY DAMAGES), MORAL, INCIDENTAL, OR INDIRECT DAMAGES FOR ANY ECONOMIC CONSEQUENTIAL DAMAGES; OR**

**Arbitration:** *The following is added under this heading:*

Disputes arising out of or in connection with this Statement of Limited Warranty shall be finally settled by arbitration which shall be held in Metro Manila, Philippines in accordance with the laws of the Philippines then in effect. The arbitration award shall be final and binding for the parties without appeal and shall be in writing and set forth the findings of fact and the conclusions of law.

The number of arbitrators shall be three, with each side to the dispute being entitled to appoint one arbitrator. The two arbitrators appointed by the parties shall appoint a third arbitrator who shall act as chairman of the proceedings. Vacancies in the post of chairman shall be filled by the president of the Philippine Dispute Resolution Center, Inc. Other vacancies shall be filled by the respective nominating party. Proceedings shall continue from the stage they were at when the vacancy occurred.

If one of the parties refuses or otherwise fails to appoint an arbitrator within 30 days of the date the other party appoints its, the first appointed arbitrator shall be the sole arbitrator, provided that the arbitrator was validly and properly appointed.

All proceedings shall be conducted, including all documents presented in such proceedings, in the English language. The English language version of this Statement of Limited Warranty prevails over any other language version.

## SINGAPORE

**Limitation of Liability:** *The words "SPECIAL" and "ECONOMIC" in item 3 in the fifth paragraph are deleted.*

## EUROPE, MIDDLE EAST, AFRICA (EMEA)

### **THE FOLLOWING TERMS APPLY TO ALL EMEA COUNTRIES:**

The terms of this Statement of Limited Warranty apply to Machines purchased from IBM or an IBM reseller.

### **How to Obtain Warranty Service:**

*Add the following paragraph in **Western Europe** (Andorra, Austria, Belgium, Cyprus, Czech Republic, Denmark, Estonia, Finland, France, Germany, Greece, Hungary, Iceland, Ireland, Italy, Latvia, Liechtenstein, Lithuania, Luxembourg, Malta, Monaco, Netherlands, Norway, Poland, Portugal, San Marino, Slovakia, Slovenia, Spain, Sweden, Switzerland, United Kingdom, Vatican State, and any country subsequently added to the European Union, as from the date of accession):*

The warranty for Machines acquired in Western Europe shall be valid and applicable in all Western Europe countries provided the Machines have been announced and made available in such countries.

If you purchase a Machine in one of the Western European countries, as defined above, you may obtain warranty service for that Machine in any of those countries from either (1) an IBM reseller approved to perform warranty service or (2) from IBM, provided the Machine has been announced and made available by IBM in the country in which you wish to obtain service.

If you purchased a Personal Computer Machine in Albania, Armenia, Belarus, Bosnia and Herzegovina, Bulgaria, Croatia, Czech Republic, Georgia, Hungary, Kazakhstan, Kyrgyzstan, Federal Republic of Yugoslavia, Former Yugoslav Republic of Macedonia (FYROM), Moldova, Poland, Romania, Russia, Slovak Republic, Slovenia, or Ukraine, you may obtain warranty service for that Machine in any of those countries from either (1) an IBM reseller approved to perform warranty service or (2) from IBM.

If you purchase a Machine in a Middle Eastern or African country, you may obtain warranty service for that Machine from the IBM entity within the country of purchase, if that IBM entity provides warranty service in that country, or from an IBM reseller, approved by IBM to perform warranty service on that Machine in that country. Warranty service in Africa is available within 50 kilometers of an IBM approved service provider. You are responsible for transportation costs for Machines located outside 50 kilometers of an IBM approved service provider.

### **Governing Law:**

*The phrase “the laws of the country in which you acquired the Machine” is replaced by:*

1) “the laws of Austria” in **Albania, Armenia, Azerbaijan, Belarus, Bosnia-Herzegovina, Bulgaria, Croatia, Georgia, Hungary, Kazakhstan, Kyrgyzstan, FYR Macedonia, Moldova, Poland, Romania, Russia, Slovakia, Slovenia, Tajikistan, Turkmenistan, Ukraine, Uzbekistan, and FR Yugoslavia;** 2) “the laws of France” in **Algeria, Benin, Burkina Faso, Cameroon, Cape Verde, Central African Republic, Chad, Comoros, Congo Republic, Djibouti, Democratic Republic of Congo, Equatorial Guinea, French Guiana, French Polynesia, Gabon, Gambia, Guinea, Guinea-Bissau, Ivory Coast, Lebanon, Madagascar, Mali, Mauritania, Mauritius, Mayotte, Morocco, New Caledonia, Niger, Reunion, Senegal, Seychelles, Togo, Tunisia, Vanuatu, and Wallis & Futuna;** 3) “the laws of Finland” in **Estonia, Latvia, and Lithuania;** 4) “the laws of England” in **Angola, Bahrain, Botswana, Burundi, Egypt, Eritrea, Ethiopia, Ghana, Jordan, Kenya, Kuwait, Liberia, Malawi, Malta, Mozambique, Nigeria, Oman, Pakistan, Qatar, Rwanda, Sao Tome, Saudi Arabia, Sierra Leone, Somalia, Tanzania, Uganda, United Arab Emirates, the United Kingdom, West Bank/Gaza, Yemen, Zambia, and Zimbabwe;** and 5) “the laws of South Africa” in **South Africa, Namibia, Lesotho and Swaziland.**

**Jurisdiction:** *The following exceptions are added to this section:*

1) In **Austria** the choice of jurisdiction for all disputes arising out of this Statement of Limited Warranty and relating thereto, including its existence, will be the competent court of law in Vienna, Austria (Inner-City); 2) in **Angola, Bahrain, Botswana, Burundi, Egypt, Eritrea, Ethiopia, Ghana, Jordan, Kenya, Kuwait, Liberia, Malawi, Malta, Mozambique, Nigeria, Oman, Pakistan, Qatar, Rwanda, Sao Tome, Saudi Arabia, Sierra Leone, Somalia, Tanzania, Uganda, United Arab Emirates, West Bank/Gaza, Yemen, Zambia, and Zimbabwe** all disputes arising out of this Statement of Limited Warranty or related to its execution, including summary proceedings, will be submitted to the exclusive jurisdiction of the English courts; 3) in **Belgium and Luxembourg**, all disputes arising out of this Statement of Limited Warranty or related to its interpretation or its execution, the law, and the courts of the

capital city, of the country of your registered office and/or commercial site location only are competent; 4) **in France, Algeria, Benin, Burkina Faso, Cameroon, Cape Verde, Central African Republic, Chad, Comoros, Congo Republic, Djibouti, Democratic Republic of Congo, Equatorial Guinea, French Guiana, French Polynesia, Gabon, Gambia, Guinea, Guinea-Bissau, Ivory Coast, Lebanon, Madagascar, Mali, Mauritania, Mauritius, Mayotte, Morocco, New Caledonia, Niger, Reunion, Senegal, Seychelles, Togo, Tunisia, Vanuatu, and Wallis & Futuna** all disputes arising out of this Statement of Limited Warranty or related to its violation or execution, including summary proceedings, will be settled exclusively by the Commercial Court of Paris; 5) **in Russia**, all disputes arising out of or in relation to the interpretation, the violation, the termination, the nullity of the execution of this Statement of Limited Warranty shall be settled by Arbitration Court of Moscow; 6) **in South Africa, Namibia, Lesotho and Swaziland**, both of us agree to submit all disputes relating to this Statement of Limited Warranty to the jurisdiction of the High Court in Johannesburg; 7) **in Turkey** all disputes arising out of or in connection with this Statement of Limited Warranty shall be resolved by the Istanbul Central (Sultanahmet) Courts and Execution Directorates of Istanbul, the Republic of Turkey; 8) in each of the following specified countries, any legal claim arising out of this Statement of Limited Warranty will be brought before, and settled exclusively by, the competent court of a) Athens for **Greece**, b) Tel Aviv-Jaffa for **Israel**, c) Milan for **Italy**, d) Lisbon for **Portugal**, and e) Madrid for **Spain**; and 9) **in the United Kingdom**, both of us agree to submit all disputes relating to this Statement of Limited Warranty to the jurisdiction of the English courts.

**Arbitration:** *The following is added under this heading:*

**In Albania, Armenia, Azerbaijan, Belarus, Bosnia-Herzegovina, Bulgaria, Croatia, Georgia, Hungary, Kazakhstan, Kyrgyzstan, FYR Macedonia, Moldova, Poland, Romania, Russia, Slovakia, Slovenia, Tajikistan, Turkmenistan, Ukraine, Uzbekistan, and FR Yugoslavia** all disputes arising out of this Statement of Limited Warranty or related to its violation, termination or nullity will be finally settled under the Rules of Arbitration and Conciliation of the International Arbitral Center of the Federal Economic Chamber in Vienna (Vienna Rules) by three arbitrators appointed in accordance with these rules. The arbitration will be held in Vienna, Austria, and the official language of the proceedings will be English. The decision of the arbitrators will be final and binding upon both parties. Therefore, pursuant to paragraph 598 (2) of the Austrian Code of Civil Procedure, the parties expressly waive the application of paragraph 595 (1) figure 7 of the Code. IBM may, however, institute proceedings in a competent court in the country of installation.

**In Estonia, Latvia and Lithuania** all disputes arising in connection with this Statement of Limited Warranty will be finally settled in arbitration that will be held in Helsinki, Finland in accordance with the arbitration laws of Finland then in effect. Each party will appoint one arbitrator. The arbitrators will then

jointly appoint the chairman. If arbitrators cannot agree on the chairman, then the Central Chamber of Commerce in Helsinki will appoint the chairman.

## EUROPEAN UNION (EU)

### ***THE FOLLOWING TERMS APPLY TO ALL EU COUNTRIES:***

The warranty for Machines acquired in EU countries is valid and applicable in all EU countries provided the Machines have been announced and made available in such countries.

**How to Obtain Warranty Service:** *The following is added to this section:*

To obtain warranty service from IBM in EU countries, see the telephone listing in Part 3 - Warranty Information.

You may contact IBM at the following address:

IBM Warranty & Service Quality Dept.  
PO Box 30  
Spango Valley  
Greenock  
Scotland PA16 0AH

## CONSUMERS

Consumers have legal rights under applicable national legislation governing the sale of consumer goods. Such rights are not affected by the warranties provided in this Statement of Limited Warranty.

### **AUSTRIA, DENMARK, FINLAND, GREECE, ITALY, NETHERLANDS, NORWAY, PORTUGAL, SPAIN, SWEDEN AND SWITZERLAND**

**Limitation of Liability:** *The following replaces the terms of this section in its entirety:*

Except as otherwise provided by mandatory law:

1. IBM's liability for any damages and losses that may arise as a consequence of the fulfillment of its obligations under or in connection with this Statement of Limited Warranty or due to any other cause related to this Statement of Limited Warranty is limited to the compensation of only those damages and losses proved and actually arising as an immediate and direct consequence of the non-fulfillment of such obligations (if IBM is at fault) or of such cause, for a maximum amount equal to the charges you paid for the Machine. For purposes of this item, the term "Machine" includes Machine Code and Licensed Internal Code ("LIC").

The above limitation shall not apply to damages for bodily injuries (including death) and damages to real property and tangible personal property for which IBM is legally liable.

2. **UNDER NO CIRCUMSTANCES IS IBM, ITS SUPPLIERS OR RESELLERS LIABLE FOR ANY OF THE FOLLOWING, EVEN IF INFORMED OF THEIR POSSIBILITY: 1) LOSS OF, OR DAMAGE TO, DATA; 2) INCIDENTAL OR INDIRECT DAMAGES, OR FOR ANY ECONOMIC CONSEQUENTIAL DAMAGES; 3) LOST PROFITS, EVEN IF THEY ARISE AS AN IMMEDIATE CONSEQUENCE OF THE EVENT THAT GENERATED THE DAMAGES; OR 4) LOSS OF BUSINESS, REVENUE, GOODWILL, OR ANTICIPATED SAVINGS.**

## **FRANCE AND BELGIUM**

**Limitation of Liability:** *The following replaces the terms of this section in its entirety:*

Except as otherwise provided by mandatory law:

1. IBM's liability for any damages and losses that may arise as a consequence of the fulfillment of its obligations under or in connection with this Statement of Limited Warranty is limited to the compensation of only those damages and losses proved and actually arising as an immediate and direct consequence of the non-fulfillment of such obligations (if IBM is at fault), for a maximum amount equal to the charges you paid for the Machine that has caused the damages. For purposes of this item, the term "Machine" includes Machine Code and Licensed Internal Code ("LIC").

The above limitation shall not apply to damages for bodily injuries (including death) and damages to real property and tangible personal property for which IBM is legally liable.

2. **UNDER NO CIRCUMSTANCES IS IBM, ITS SUPPLIERS OR RESELLERS LIABLE FOR ANY OF THE FOLLOWING, EVEN IF INFORMED OF THEIR POSSIBILITY: 1) LOSS OF, OR DAMAGE TO, DATA; 2) INCIDENTAL OR INDIRECT DAMAGES, OR FOR ANY ECONOMIC CONSEQUENTIAL DAMAGES; 3) LOST PROFITS, EVEN IF THEY ARISE AS AN IMMEDIATE CONSEQUENCE OF THE EVENT THAT GENERATED THE DAMAGES; OR 4) LOSS OF BUSINESS, REVENUE, GOODWILL, OR ANTICIPATED SAVINGS.**

**THE FOLLOWING TERMS APPLY TO THE COUNTRY SPECIFIED:**

## **AUSTRIA**

**The provisions of this Statement of Limited Warranty replace any applicable statutory warranties.**

**What this Warranty Covers:** *The following replaces the first sentence of the first paragraph of this section:*

The warranty for an IBM Machine covers the functionality of the Machine for its normal use and the Machine's conformity to its Specifications.

*The following paragraphs are added to this section:*

The limitation period for consumers in action for breach of warranty is the statutory period as a minimum. In case IBM or your reseller is unable to repair an IBM Machine, you can alternatively ask for a partial refund as far as justified by the reduced value of the unrepaired Machine or ask for a cancellation of the respective agreement for such Machine and get your money refunded.

*The second paragraph does not apply.*

**What IBM Will Do to Correct Problems:** *The following is added to this section:*

During the warranty period, IBM will reimburse you for the transportation charges for the delivery of the failing Machine to IBM.

**Limitation of Liability:** *The following paragraph is added to this section:*

The limitations and exclusions specified in the Statement of Limited Warranty will not apply to damages caused by IBM with fraud or gross negligence and for express warranty.

*The following sentence is added to the end of item 2:*

IBM's liability under this item is limited to the violation of essential contractual terms in cases of ordinary negligence.

## EGYPT

**Limitation of Liability:** *The following replaces item 2 in this section:*

as to any other actual direct damages, IBM's liability will be limited to the total amount you paid for the Machine that is the subject of the claim. For purposes of this item, the term "Machine" includes Machine Code and Licensed Internal Code ("LIC").

*Applicability of suppliers and resellers (unchanged).*

## FRANCE

**Limitation of Liability:** *The following replaces the second sentence of the first paragraph of this section:*



In such instances, regardless of the basis on which you are entitled to claim damages from IBM, IBM is liable for no more than: (items 1 and 2 unchanged).

## GERMANY

**What this Warranty Covers:** *The following replaces the first sentence of the first paragraph of this section:*

The warranty for an IBM Machine covers the functionality of the Machine for its normal use and the Machine's conformity to its Specifications.

*The following paragraphs are added to this section:*

The minimum warranty period for Machines is twelve months. In case IBM or your reseller is unable to repair an IBM Machine, you can alternatively ask for a partial refund as far as justified by the reduced value of the unrepaired Machine or ask for a cancellation of the respective agreement for such Machine and get your money refunded.

*The second paragraph does not apply.*

**What IBM Will Do to Correct Problems:** *The following is added to this section:*

During the warranty period, transportation for delivery of the failing Machine to IBM will be at IBM's expense.

**Limitation of Liability:** *The following paragraph is added to this section:*

The limitations and exclusions specified in the Statement of Limited Warranty will not apply to damages caused by IBM with fraud or gross negligence and for express warranty.

*The following sentence is added to the end of item 2:*

IBM's liability under this item is limited to the violation of essential contractual terms in cases of ordinary negligence.

## HUNGARY

**Limitation of Liability:** *The following is added at the end of this section:*

The limitation and exclusion specified herein shall not apply to liability for a breach of contract damaging life, physical well-being, or health that has been caused intentionally, by gross negligence, or by a criminal act.

The parties accept the limitations of liability as valid provisions and state that the Section 314.(2) of the Hungarian Civil Code applies as the acquisition price as well as other advantages arising out of the present Statement of Limited Warranty balance this limitation of liability.

## IRELAND

**What this Warranty Covers:** *The following is added to this section:*

Except as expressly provided in these terms and conditions, all statutory conditions, including all warranties implied, but without prejudice to the generality of the foregoing all warranties implied by the Sale of Goods Act 1893 or the Sale of Goods and Supply of Services Act 1980 are hereby excluded.

**Limitation of Liability:** *The following replaces the terms of this section in its entirety:*

For the purposes of this section, a “Default” means any act, statement, omission, or negligence on the part of IBM in connection with, or in relation to, the subject matter of this Statement of Limited Warranty in respect of which IBM is legally liable to you, whether in contract or tort. A number of Defaults which together result in, or contribute to, substantially the same loss or damage will be treated as one Default occurring on the date of occurrence of the last such Default.

Circumstances may arise where, because of a Default, you are entitled to recover damages from IBM.

This section sets out the extent of IBM’s liability and your sole remedy.

1. IBM will accept unlimited liability for death or personal injury caused by the negligence of IBM.
2. Subject always to the **Items for Which IBM is Not Liable** below, IBM will accept unlimited liability for physical damage to your tangible property resulting from the negligence of IBM.
3. Except as provided in items 1 and 2 above, IBM’s entire liability for actual damages for any one Default will not in any event exceed the greater of 1) EUR 125,000, or 2) 125% of the amount you paid for the Machine directly relating to the Default.

### **Items for Which IBM is Not Liable**

Save with respect to any liability referred to in item 1 above, under no circumstances is IBM, its suppliers or resellers liable for any of the following, even if IBM or they were informed of the possibility of such losses:

1. loss of, or damage to, data;
2. special, indirect, or consequential loss; or

3. loss of profits, business, revenue, goodwill, or anticipated savings.

## SLOVAKIA

**Limitation of Liability:** *The following is added to the end of the last paragraph:*

The limitations apply to the extent they are not prohibited under §§ 373-386 of the Slovak Commercial Code.

## SOUTH AFRICA, NAMIBIA, BOTSWANA, LESOTHO AND SWAZILAND

**Limitation of Liability:** *The following is added to this section:*

IBM's entire liability to you for actual damages arising in all situations involving nonperformance by IBM in respect of the subject matter of this Statement of Warranty will be limited to the charge paid by you for the individual Machine that is the subject of your claim from IBM.

## UNITED KINGDOM

**Limitation of Liability:** *The following replaces the terms of this section in its entirety:*

For the purposes of this section, a "Default" means any act, statement, omission, or negligence on the part of IBM in connection with, or in relation to, the subject matter of this Statement of Limited Warranty in respect of which IBM is legally liable to you, whether in contract or tort. A number of Defaults which together result in, or contribute to, substantially the same loss or damage will be treated as one Default.

Circumstances may arise where, because of a Default, you are entitled to recover damages from IBM.

This section sets out the extent of IBM's liability and your sole remedy.

1. IBM will accept unlimited liability for:
  - a. death or personal injury caused by the negligence of IBM; and
  - b. any breach of its obligations implied by Section 12 of the Sale of Goods Act 1979 or Section 2 of the Supply of Goods and Services Act 1982, or any statutory modification or re-enactment of either such Section.
2. IBM will accept unlimited liability, subject always to the **Items for Which IBM is Not Liable** below, for physical damage to your tangible property resulting from the negligence of IBM.
3. IBM's entire liability for actual damages for any one Default will not in any event, except as provided in items 1 and 2 above, exceed the greater of 1) Pounds Sterling 75,000, or 2) 125% of the total purchase price payable or the charges for the Machine directly relating to the Default.

These limits also apply to IBM's suppliers and resellers. They state the maximum for which IBM and such suppliers and resellers are collectively responsible.

### Items for Which IBM is Not Liable

Save with respect to any liability referred to in item 1 above, under no circumstances is IBM or any of its suppliers or resellers liable for any of the following, even if IBM or they were informed of the possibility of such losses:

1. loss of, or damage to, data;
2. special, indirect, or consequential loss; or
3. loss of profits, business, revenue, goodwill, or anticipated savings.

---

## Part 3 - Warranty Information

This Part 3 provides information regarding the warranty applicable to your Machine, including the warranty period and type of warranty service IBM provides.

### Warranty Period

The warranty period may vary by country or region and is specified in the table below.

**Note:** "Region" means either Hong Kong or Macau Special Administrative Region of China.

A warranty period of 3 years on parts and 1 year on labor means that IBM provides warranty service without charge for:

1. parts and labor during the first year of the warranty period; and
2. parts only, on an exchange basis, in the second and third years of the warranty period. IBM will charge you for any labor provided in performance of the repair or replacement(s) in the second and third year of the warranty period.

### Machine - IBM @server BladeCenter T Management Module

Country or Region of Purchase	Warranty Period	Type of Warranty Service*
Worldwide	1 year	1
* See " <u>Types of Warranty Service</u> " for the legend and explanations of warranty-service types.		

### Types of Warranty Service

If required, IBM provides repair or exchange service depending on the type of warranty service specified for your Machine in the above table and as described below. Warranty service may be provided by your reseller if approved by IBM to perform warranty service. Scheduling of service will depend upon the time of your call and is subject to parts availability. Service levels are response time objectives and are not guaranteed. The specified level of warranty service may not be available in all worldwide locations, additional charges may apply outside IBM's normal service area, contact your local IBM representative or your reseller for country and location specific information.

**1. Customer Replaceable Unit ("CRU") Service**

IBM provides replacement CRUs to you for you to install. CRU information and replacement instructions are shipped with your Machine and are available from IBM at any time on your request. Installation of Tier 1 CRUs is your responsibility. If IBM installs a Tier 1 CRU at your request, you will be charged for the installation. You may install a Tier 2 CRU yourself or request IBM to install it, at no additional charge, under the type of warranty service designated for your Machine. IBM specifies in the materials shipped with a replacement CRU whether a defective CRU must be returned to IBM. When return is required, 1) return instructions and a container are shipped with the replacement CRU, and 2) you may be charged for the replacement CRU if IBM does not receive the defective CRU within 30 days of your receipt of the replacement.

**2. On-site Service**

IBM or your reseller will either repair or exchange the failing Machine at your location and verify its operation. You must provide suitable working area to allow disassembly and reassembly of the IBM Machine. The area must be clean, well lit and suitable for the purpose. For some Machines, certain repairs may require sending the Machine to an IBM service center.

**3. Courier or Depot Service\***

You will disconnect the failing Machine for collection arranged by IBM. IBM will provide you with a shipping container for you to return your Machine to a designated service center. A courier will pick up your Machine and deliver it to the designated service center. Following its repair or exchange, IBM will arrange the return delivery of the Machine to your location. You are responsible for its installation and verification.

**4. Customer Carry-In or Mail-In Service**

You will deliver or mail as IBM specifies (prepaid unless IBM specifies otherwise) the failing Machine suitably packaged to a location IBM designates. After IBM has repaired or exchanged the Machine, IBM will make it available for your collection or, for Mail-in Service, IBM will return it to you at IBM's expense, unless IBM specifies otherwise. You are responsible for the subsequent installation and verification of the Machine.

**5. CRU and On-site Service**

This type of Warranty Service is a combination of Type 1 and Type 2 (see above).

**6. CRU and Courier or Depot Service**

This type of Warranty Service is a combination of Type 1 and Type 3 (see above).

**7. CRU and Customer Carry-In or Mail-In Service**

This type of Warranty Service is a combination of Type 1 and Type 4 (see above).

**When a 5, 6 or 7 type of warranty service is listed, IBM will determine which type of warranty service is appropriate for the repair.**

\* This type of service is called ThinkPad<sup>®</sup> EasyServ or EasyServ in some countries.

The IBM Machine Warranty World Wide Web site at [http://www.ibm.com/servers/support/machine\\_warranties/](http://www.ibm.com/servers/support/machine_warranties/) provides a worldwide overview of IBM's Limited Warranty for Machines, a Glossary of IBM definitions, Frequently Asked Questions (FAQs) and Support by Product (Machine) with links to Product Support pages. **The IBM Statement of Limited Warranty is also available on this site in 29 languages.**

To obtain warranty service contact IBM or your IBM reseller. In Canada or the United States, call 1-800-IBM-SERV (426-7378). In the EU countries, see the telephone numbers below.

## EU Country Telephone List

Phone numbers are subject to change without notice. For the warranty service contact telephone number in a country subsequently added to the EU and not yet reflected in the list below, contact IBM in that country or visit the website above for a current telephone listing.

Austria -- +43-1-24592-5901	Latvia -- +386-61-1796-699
Belgium -- +32-70-23-3392	Lithuania -- +386-61-1796-699
Cyprus -- +357-22-841100	Luxembourg -- +352-298-977-5063
Czech Republic -- +420-2-7213-1316	Malta -- +356-23-4175
Denmark -- +45-4520-8200	Netherlands -- +31-20-514-5770
Estonia -- +386-61-1796-699	Poland -- +48-22-878-6999
Finland -- +358-8001-4260	Portugal -- +351-21-892-7147
France -- +33-238-557-450	Slovakia -- +421-2-4954-1217
Germany -- +49-1805-253553	Slovenia -- +386-1-4796-699
Greece -- +30-210-680-1700	Spain -- +34-91-714-7983
Hungary -- +36-1-382-5720	Sweden -- +46-8-477-4420
Ireland -- +353-1-815-4000	United Kingdom -- +44-1475-555-055
Italy -- +39-800-820-094	





---

## Appendix C. Notices

This information was developed for products and services offered in the U.S.A.

IBM may not offer the products, services, or features discussed in this document in other countries. Consult your local IBM representative for information on the products and services currently available in your area. Any reference to an IBM product, program, or service is not intended to state or imply that only that IBM product, program, or service may be used. Any functionally equivalent product, program, or service that does not infringe any IBM intellectual property right may be used instead. However, it is the user's responsibility to evaluate and verify the operation of any non-IBM product, program, or service.

IBM may have patents or pending patent applications covering subject matter described in this document. The furnishing of this document does not give you any license to these patents. You can send license inquiries, in writing, to:

*IBM Director of Licensing  
IBM Corporation  
North Castle Drive  
Armonk, NY 10504-1785  
U.S.A.*

INTERNATIONAL BUSINESS MACHINES CORPORATION PROVIDES THIS PUBLICATION "AS IS" WITHOUT WARRANTY OF ANY KIND, EITHER EXPRESS OR IMPLIED, INCLUDING, BUT NOT LIMITED TO, THE IMPLIED WARRANTIES OF NON-INFRINGEMENT, MERCHANTABILITY OR FITNESS FOR A PARTICULAR PURPOSE. Some states do not allow disclaimer of express or implied warranties in certain transactions, therefore, this statement may not apply to you.

This information could include technical inaccuracies or typographical errors. Changes are periodically made to the information herein; these changes will be incorporated in new editions of the publication. IBM may make improvements and/or changes in the product(s) and/or the program(s) described in this publication at any time without notice.

Any references in this information to non-IBM Web sites are provided for convenience only and do not in any manner serve as an endorsement of those Web sites. The materials at those Web sites are not part of the materials for this IBM product, and use of those Web sites is at your own risk.

IBM may use or distribute any of the information you supply in any way it believes appropriate without incurring any obligation to you.

---

## Edition notice

© Copyright International Business Machines Corporation 2004. All rights reserved.

U.S. Government Users Restricted Rights — Use, duplication, or disclosure restricted by GSA ADP Schedule Contract with IBM Corp.

---

## Trademarks

The following terms are trademarks of International Business Machines Corporation in the United States, other countries, or both:

Active Memory	Predictive Failure Analysis
Active PCI	PS/2
Active PCI-X	ServeRAID
Alert on LAN	ServerGuide
BladeCenter	ServerProven
C2T Interconnect	TechConnect
Chipkill	ThinkPad
EtherJet	Tivoli
e-business logo	Tivoli Enterprise
@server	Update Connector
FlashCopy	Wake on LAN
IBM	XA-32
IBM (logo)	XA-64
IntelliStation	X-Architecture
NetBAY	XceL4
Netfinity	XpandOnDemand
NetView	xSeries
OS/2 WARP	

Intel, MMX, and Pentium are trademarks of Intel Corporation in the United States, other countries, or both.

Microsoft, Windows, and Windows NT are trademarks of Microsoft Corporation in the United States, other countries, or both.

UNIX is a registered trademark of The Open Group in the United States and other countries.

Java and all Java-based trademarks and logos are trademarks of Sun Microsystems, Inc. in the United States, other countries, or both.

Adaptec and HostRAID are trademarks of Adaptec, Inc., in the United States, other countries, or both.

Linux is a trademark of Linus Torvalds in the United States, other countries, or both.

Red Hat, the Red Hat “Shadow Man” logo, and all Red Hat-based trademarks and logos are trademarks or registered trademarks of Red Hat, Inc., in the United States and other countries.

Other company, product, or service names may be trademarks or service marks of others.

---

## Important notes

Processor speeds indicate the internal clock speed of the microprocessor; other factors also affect application performance.

CD-ROM drive speeds list the variable read rate. Actual speeds vary and are often less than the maximum possible.

When referring to processor storage, real and virtual storage, or channel volume, KB stands for approximately 1000 bytes, MB stands for approximately 1 000 000 bytes, and GB stands for approximately 1 000 000 000 bytes.

When referring to hard disk drive capacity or communications volume, MB stands for 1 000 000 bytes, and GB stands for 1 000 000 000 bytes. Total user-accessible capacity may vary depending on operating environments.

Maximum internal hard disk drive capacities assume the replacement of any standard hard disk drives and population of all hard disk drive bays with the largest currently supported drives available from IBM.

Maximum memory may require replacement of the standard memory with an optional memory module.

IBM makes no representation or warranties regarding non-IBM products and services that are ServerProven<sup>®</sup>, including but not limited to the implied warranties of merchantability and fitness for a particular purpose. These products are offered and warranted solely by third parties.

IBM makes no representations or warranties with respect to non-IBM products. Support (if any) for the non-IBM products is provided by the third party, not IBM.

Some software may differ from its retail version (if available), and may not include user manuals or all program functionality.

---

## Product recycling and disposal

This unit contains materials such as circuit boards, cables, electromagnetic compatibility gaskets, and connectors which may contain lead and copper/beryllium alloys that require special handling and disposal at end of life. Before this unit is disposed of, these materials must be removed and recycled or discarded according to applicable regulations. IBM offers product-return programs in several countries. Information on product recycling offerings can be found on IBM's Internet site at <http://www.ibm.com/ibm/environment/products/prp.shtml>.

IBM encourages owners of information technology (IT) equipment to responsibly recycle their equipment when it is no longer needed. IBM offers a variety of programs and services to assist equipment owners in recycling their IT products. Information on product recycling offerings can be found on IBM's Internet site at <http://www.ibm.com/ibm/environment/products/prp.shtml>.

---

## Battery return program

This product may contain a sealed lead acid, nickel cadmium, nickel metal hydride, lithium, or lithium ion battery. Consult your user manual or service manual for specific battery information. The battery must be recycled or disposed of properly. Recycling facilities may not be available in your area. For information on disposal of batteries outside the United States, go to <http://www.ibm.com/ibm/environment/products/batteryrecycle.shtml> or contact your local waste disposal facility.

In the United States, IBM has established a return process for reuse, recycling, or proper disposal of used IBM sealed lead acid, nickel cadmium, nickel metal hydride, and battery packs from IBM equipment. For information on proper disposal of these batteries, contact IBM at 1-800-426-4333. Have the IBM part number listed on the battery available prior to your call.

In the Netherlands, the following applies.

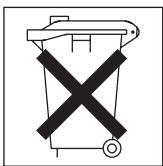

For Taiwan: Please recycle batteries.



---

## Electronic emission notices

### Federal Communications Commission (FCC) statement

**Note:** This equipment has been tested and found to comply with the limits for a Class A digital device, pursuant to Part 15 of the FCC Rules. These limits are designed to provide reasonable protection against harmful interference when the equipment is operated in a commercial environment. This equipment generates, uses, and can radiate radio frequency energy and, if not installed and used in accordance with the instruction manual, may cause harmful interference to radio communications. Operation of this equipment in a residential area is likely to cause harmful interference, in which case the user will be required to correct the interference at his own expense.

Properly shielded and grounded cables and connectors must be used in order to meet FCC emission limits. IBM is not responsible for any radio or television interference caused by using other than recommended cables and connectors or by unauthorized changes or modifications to this equipment. Unauthorized changes or modifications could void the user's authority to operate the equipment.

This device complies with Part 15 of the FCC Rules. Operation is subject to the following two conditions: (1) this device may not cause harmful interference, and (2) this device must accept any interference received, including interference that may cause undesired operation.

### Industry Canada Class A emission compliance statement

This Class A digital apparatus complies with Canadian ICES-003.

### Avis de conformité à la réglementation d'Industrie Canada

Cet appareil numérique de la classe A est conforme à la norme NMB-003 du Canada.

## Australia and New Zealand Class A statement

**Attention:** This is a Class A product. In a domestic environment this product may cause radio interference in which case the user may be required to take adequate measures.

## United Kingdom telecommunications safety requirement

### Notice to Customers

This apparatus is approved under approval number NS/G/1234/J/100003 for indirect connection to public telecommunication systems in the United Kingdom.

## European Union EMC Directive conformance statement

This product is in conformity with the protection requirements of EU Council Directive 89/336/EEC on the approximation of the laws of the Member States relating to electromagnetic compatibility. IBM cannot accept responsibility for any failure to satisfy the protection requirements resulting from a nonrecommended modification of the product, including the fitting of non-IBM option cards.

This product has been tested and found to comply with the limits for Class A Information Technology Equipment according to CISPR 22/European Standard EN 55022. The limits for Class A equipment were derived for commercial and industrial environments to provide reasonable protection against interference with licensed communication equipment.

**Attention:** This is a Class A product. In a domestic environment this product may cause radio interference in which case the user may be required to take adequate measures.

## Taiwanese Class A warning statement

警告使用者：  
這是甲類的資訊產品，在居住的環境中使用時，可能會造成射頻干擾，在這種情況下，使用者會被要求採取某些適當的對策。

## Chinese Class A warning statement

### 声 明

此为 A 级产品。在生活环境中，该产品可能会造成无线电干扰。在这种情况下，可能需要用户对其干扰采取切实可行的措施。

## Japanese Voluntary Control Council for Interference (VCCI) statement

この装置は、情報処理装置等電波障害自主規制協議会（VCCI）の基準に基づくクラスA情報技術装置です。この装置を家庭環境で使用すると電波妨害を引き起こすことがあります。この場合には使用者が適切な対策を講ずるよう要求されることがあります。





---

# Index

## B

- bezel assembly
  - installing 15
  - removing 13
- BladeCenter T unit
  - configuring 29

## C

- cabling
  - keyboard, video, and mouse 19
  - KVM module 19
  - LAN module 19
- cabling, remote connection Ethernet port 21
- Class A electronic emission notice 65
- color on components
  - blue 7
  - orange 7
- compatible options Web site 8
- connector
  - Ethernet 26
  - input/output 26
  - keyboard 25
  - KVM module 25
  - PS/2 mouse 25
  - remote management 26
  - remote management and console 26
  - Telco alarms 26
  - video 25

## D

- documentation CD
  - starting 3
  - using 3

## E

- electronic emission Class A notice 65
- ESD
  - connector 8, 14, 17
  - wrist strap 8, 14, 17
- Ethernet
  - configuring remote connection 29

- Ethernet (*continued*)
  - connectors 26
  - Ethernet connector, remote management and console 26
  - Ethernet-activity LED 26
  - Ethernet-link status LED 26, 27
  - port, cabling 21
- Ethernet ports 20

## F

- FCC Class A notice 65
- firmware 10

## H

- handling, static-sensitive devices 8
- hot-swap components 7

## I

- I/O module, definition 1
- identification labels 6
- installation
  - guidelines 7
  - illustration 14
  - procedure 12
- installing
  - management module 12
  - options 7
- introduction 1
- IP reset button, management module 23

## K

- keyboard connector 25
- KVM module
  - cabling 19
  - connectors
    - keyboard 25
    - mouse 25
    - video 25
  - function 19
  - LEDs
    - critical Telco alarm 24

## KVM module (*continued*)

### LEDs (*continued*)

- location 24
- major Telco alarm 24
- minor Telco alarm 24
- power 24

## L

labels 6

### LAN module

- cabling 19
- Ethernet ports 20
- function 19, 26
- LEDs

- Ethernet activity 26
- Ethernet link 26

### LEDs

- alarm 25
  - critical 25
  - major 25
  - minor 25
- Ethernet activity 26
- Ethernet-link status 26, 27
- KVM module 24
  - system-status panel 24, 25

### LAN module 26

- Ethernet activity 26
- power 26, 27
- management module 23
  - active 23
  - error 23
  - power 23
- system-status panel
  - location 24
  - power 24

### location

- management-module bays 7
- media access control (MAC)
  - address 6
- serial number 6

## M

### management module

- bay locations 7
- communication 2
- configuring 29
- firmware 10
- functions 1
- installing 12

### management module (*continued*)

- IP reset button 23
- LEDs 23
  - active 23
  - error 23
  - power 23
- overview 6
- primary 10, 11
- redundancy 10
- removing 16
- secondary 10
- media access control (MAC) address 1, 6
- mouse connector 25

## N

notes, important 63

### notices

- attention 5
- caution 5
- danger 5
- document 5
- electronic emission 65
- FCC, Class A 65
- important 5

## O

### options

- installing 7
- Web site 8

## P

### port

*See* connector

### power LED

- KVM module 26
- management module 23

## R

- related documentation 2
- remote management connector 26
- removing
  - bezel assembly 13
  - management module 16

## S

- serial number 6
- starting
  - the documentation CD 3
- statements
  - attention 5
  - caution 5
  - danger 5
  - important 5
- static electricity 8
- static-sensitive devices
  - ESD connector 8
  - ESD wrist strap 8
  - handling 8
- system reliability 8

## T

- Telco alarms connector 27
- touch points 7
- trademarks 62

## U

- United States electronic emission Class A notice 65
- United States FCC Class A notice 65
- using
  - the documentation CD 3

## V

- video connector 25

## W

- Web browsers, supported 29
- Web site
  - BladeCenter Planning and Installation Guide 3
  - compatible options 8
  - IBM products 1







Part Number: 25R4616

Printed in USA

(1P) P/N: 25R4616

