



@server

xSeries 200 (Type 8479)

xSeries 200VL (Type 8481)

User's Reference



IBM xSeries 200 and xSeries 200VL



User's Reference

Note:

Before using this information and the product it supports, be sure to read the general information in Appendix A, "Product warranty," on page 99 and Appendix B, "Notices," on page 109.

Second Edition (September 2001)

© Copyright International Business Machines Corporation 2001. All rights reserved.

US Government Users Restricted Rights – Use, duplication or disclosure restricted by GSA ADP Schedule Contract with IBM Corp.

Contents

| | |
|--------------------------------------------------------------------------|-----|
| Safety | vii |
| Chapter 1.Introducing the IBM xSeries 200 and xSeries 200VL | 1 |
| Features and specifications | 2 |
| Notices and statements used in this book | 3 |
| What the IBM xSeries 200 and xSeries 200VL offer | 3 |
| Reliability, availability, and serviceability features | 4 |
| Server controls and indicators | 5 |
| Turning on the server | 6 |
| Turning off the server | 6 |
| Chapter 2.Arranging your workspace | 7 |
| Comfort | 7 |
| Glare and lighting | 7 |
| Air circulation | 7 |
| Electrical outlets and cable lengths | 8 |
| Chapter 3.Configuring your server | 9 |
| Using the Configuration/Setup Utility program | 9 |
| Starting the Configuration/Setup Utility program | 9 |
| Choices available from the Configuration/Setup main menu | 10 |
| Using passwords | 12 |
| Using the SCSISelect utility program (some models) | 12 |
| Starting the SCSISelect utility program | 12 |
| Choices available from the SCSISelect menu | 13 |
| Using the PXE Boot Agent Utility program | 14 |
| Starting the PXE Boot Agent Utility program | 14 |
| Choices available from the PXE Boot Agent Utility menu | 15 |
| Chapter 4.Using the ServerGuide CDs | 17 |
| Features at a glance | 18 |
| Setup and configuration overview | 19 |
| System Partition | 20 |
| Typical NOS installation | 20 |
| Setting up or updating multiple servers | 20 |
| Installing your NOS without ServerGuide | 21 |
| Additional programs included with ServerGuide | 21 |
| Chapter 5.Installing options | 23 |
| Major components of the xSeries 200 and xSeries 200VL | 23 |
| System and PCI extender boards | 24 |
| System and PCI extender-board option connectors | 24 |
| System board internal cable connectors | 24 |
| System board external connectors | 25 |
| System board jumpers | 26 |
| Before you begin | 26 |
| System reliability considerations | 27 |
| Handling static-sensitive devices | 27 |
| Safety information | 28 |
| Moving the stabilizing feet | 32 |
| Removing the side cover | 34 |
| Removing the support-bracket assembly | 35 |
| Working with adapters | 36 |
| Adapter considerations | 36 |

| | |
|----------------------------------------------------------------|-----------|
| Installing an adapter | 37 |
| Installing a SCSI or ServeRAID adapter | 39 |
| Installing internal drives | 40 |
| Internal drive bays | 40 |
| Preinstallation steps (all bays) | 41 |
| Installing a drive in bay 2 or 4 | 41 |
| Installing a hard disk drive in bay 5, 6, or 7 | 43 |
| Installing memory modules | 44 |
| Removing and installing a microprocessor | 47 |
| Removing a microprocessor | 47 |
| Installing a microprocessor | 49 |
| Installing a security U-bolt | 50 |
| Installing the cover | 51 |
| Connecting external options | 52 |
| I/O connector locations | 52 |
| Input/output connectors | 53 |
| Mouse connector | 53 |
| Keyboard connector | 54 |
| Parallel connector | 54 |
| Viewing or changing the connector assignments | 55 |
| Parallel connector | 55 |
| Serial connectors | 56 |
| Viewing or changing the serial-connector assignments | 56 |
| Serial connectors | 56 |
| Ethernet connector | 57 |
| Configuring the Ethernet controller | 57 |
| High performance Ethernet modes | 57 |
| Ethernet connector | 59 |
| Universal Serial Bus connectors | 61 |
| USB cables and hubs | 61 |
| USB connectors | 61 |
| Audio connectors | 61 |
| Line out | 62 |
| Line in | 62 |
| Mic | 62 |
| MIDI connector | 62 |
| Video connector | 62 |
| Ultra160 SCSI connector (some models) | 63 |
| SCSI cabling requirements | 63 |
| Setting SCSI IDs | 63 |
| Chapter 6. Solving problems | 65 |
| Diagnostic tools overview | 65 |
| POST | 67 |
| Small computer system interface (SCSI) messages | 67 |
| Diagnostic programs and error messages | 68 |
| Text messages | 68 |
| Starting the diagnostic programs | 69 |
| Using the diagnostics CD | 69 |
| Downloading the diagnostics program | 70 |
| Using the diagnostic diskette | 70 |
| Viewing the test log | 70 |
| Diagnostic error message tables | 71 |
| ServerGuide error symptoms | 77 |
| Recovering the BIOS code | 78 |
| Clearing CMOS | 78 |

| | |
|--------------------------------------------------------------------------------|------------|
| Troubleshooting charts | 79 |
| Troubleshooting the Ethernet controller | 83 |
| Network connection problems | 83 |
| Ethernet controller troubleshooting chart | 84 |
| Ethernet controller messages | 85 |
| Novell NetWare or IntraNetWare system ODI driver teaming messages | 85 |
| NDIS 4.0 Windows driver messages | 87 |
| Ethernet teaming messages | 88 |
| Replacing the battery | 90 |
| Getting information, help, and service | 91 |
| Getting information | 91 |
| Using the World Wide Web | 91 |
| Getting information by fax | 91 |
| Getting help and service | 92 |
| Using the documentation and diagnostic programs | 92 |
| Calling for service | 92 |
| Purchasing additional services | 94 |
| Chapter 7. Getting information, help, and service | 95 |
| Getting information | 95 |
| Using the World Wide Web | 95 |
| Getting information by fax | 95 |
| Getting help and service | 95 |
| Using the documentation and diagnostic programs | 95 |
| Calling for service | 96 |
| Telephone numbers | 97 |
| Purchasing additional services | 97 |
| Appendix A. Product warranty | 99 |
| Warranty period | 99 |
| Warranty service and support | 99 |
| Before you call for service | 100 |
| Calling for service | 100 |
| IBM Statement of Limited Warranty Z125-4753-06 8/2000 | 100 |
| Part 1 - General Terms | 100 |
| Part 2 - Country-unique Terms | 103 |
| Appendix B. Notices | 109 |
| Edition notice | 109 |
| Trademarks | 110 |
| Important notes | 110 |
| Electronic emission notices | 111 |
| Federal Communications Commission (FCC) statement | 111 |
| Industry Canada Class A emission compliance statement | 111 |
| Australia and New Zealand Class A statement | 112 |
| United Kingdom telecommunications safety requirement | 112 |
| European Union EMC Directive conformance statement | 112 |
| Taiwan electrical emission statement | 112 |
| Japanese Voluntary Control Council for Interference (VCCI) statement | 112 |
| Power cords | 113 |
| Index | 115 |

Safety

Before installing this product, read the Safety Information.

مج، يجب قراءة دات السلامة

Antes de instalar este produto, leia as Informações de Segurança.

在安装本产品之前，请仔细阅读 **Safety Information** (安全信息)。

安裝本產品之前，請先閱讀「安全資訊」。

Prije instalacije ovog produkta obavezno pročitajte Sigurnosne Upute.

Před instalací tohoto produktu si přečtěte příručku bezpečnostních instrukcí.

Læs sikkerhedsforskrifterne, før du installerer dette produkt.

Lees voordat u dit product installeert eerst de veiligheidsvoorschriften.

Ennen kuin asennat tämän tuotteen, lue turvaohjeet kohdasta Safety Information.

Avant d'installer ce produit, lisez les consignes de sécurité.

Vor der Installation dieses Produkts die Sicherheitshinweise lesen.

Πριν εγκαταστήσετε το προϊόν αυτό, διαβάστε τις πληροφορίες ασφάλειας (safety information).

לפני שתתקינו מוצר זה, קראו את הוראות הבטיחות.

A termék telepítése előtt olvassa el a Biztonsági előírásokat!

Prima di installare questo prodotto, leggere le Informazioni sulla Sicurezza

製品の設置の前に、安全情報をお読みください。

본 제품을 설치하기 전에 안전 정보를 읽으십시오.

Пред да се инсталира овој продукт, прочитајте информацијата за безбедност.

Les sikkerhetsinformasjonen (Safety Information) før du installerer dette produktet.

Przed zainstalowaniem tego produktu, należy zapoznać się z książką "Informacje dotyczące bezpieczeństwa" (Safety Information).

Antes de instalar este produto, leia as Informações sobre Segurança.

Перед установкой продукта прочтите инструкции по технике безопасности.

Pred inštaláciou tohto zariadenia si pečítajte Bezpečnostné predpisy.

Pred namestitvijo tega proizvoda preberite Varnostne informacije.

Antes de instalar este producto lea la información de seguridad.

Läs säkerhetsinformationen innan du installerar den här produkten.

Statement 1



DANGER

Electrical current from power, telephone, and communication cables is hazardous.

To avoid a shock hazard:

- **Do not connect or disconnect any cables or perform installation, maintenance, or reconfiguration of this product during an electrical storm.**
- **Connect all power cords to a properly wired and grounded electrical outlet.**
- **Connect to properly wired outlets any equipment that will be attached to this product.**
- **When possible, use one hand only to connect or disconnect signal cables.**
- **Never turn on any equipment when there is evidence of fire, water, or structural damage.**
- **Disconnect the attached power cords, telecommunications systems, networks, and modems before you open the device covers, unless instructed otherwise in the installation and configuration procedures.**
- **Connect and disconnect cables as described in the following table when installing, moving, or opening covers on this product or attached devices.**

To Connect:

1. Turn everything OFF.
2. First, attach all cables to devices.
3. Attach signal cables to connectors.
4. Attach power cords to outlet.
5. Turn device ON.

To Disconnect:

1. Turn everything OFF.
2. First, remove power cords from outlet.
3. Remove signal cables from connectors.
4. Remove all cables from devices.

Statement 2



CAUTION:

When replacing the lithium battery, use only IBM Part Number 33F8354 or an equivalent type battery recommended by the manufacturer. If your system has a module containing a lithium battery, replace it only with the same module type made by the same manufacturer. The battery contains lithium and can explode if not properly used, handled, or disposed of.

Do not:

- Throw or immerse into water
- Heat to more than 100°C (212°F)
- Repair or disassemble

Dispose of the battery as required by local ordinances or regulations.

Statement 3



CAUTION:

When laser products (such as CD-ROMs, DVD drives, fiber optic devices, or transmitters) are installed, note the following:

- Do not remove the covers. Removing the covers of the laser product could result in exposure to hazardous laser radiation. There are no serviceable parts inside the device.
- Use of controls or adjustments or performance of procedures other than those specified herein might result in hazardous radiation exposure.



DANGER

Some laser products contain an embedded Class 3A or Class 3B laser diode. Note the following.

Laser radiation when open. Do not stare into the beam, do not view directly with optical instruments, and avoid direct exposure to the beam.

Statement 4

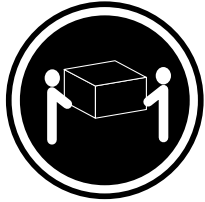

≥ 18 kg (39.7 lb)

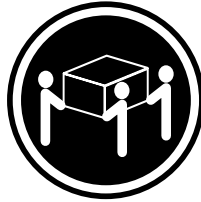

≥ 32 kg (70.5 lb)

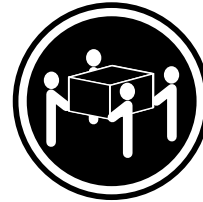

≥ 55 kg (121.2 lb)

CAUTION:
Use safe practices when lifting.

Statement 5



CAUTION:
The power control button on the device and the power switch on the power supply do not turn off the electrical current supplied to the device. The device also might have more than one power cord. To remove all electrical current from the device, ensure that all power cords are disconnected from the power source.

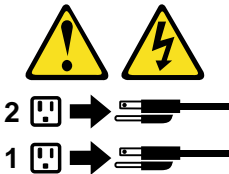

Statement 6



CAUTION:
If you install a strain-relief bracket option over the end of the power cord that is connected to the device, you must connect the other end of the power cord to an easily accessible power source.

Statement 8



CAUTION:

Never remove the cover on a power supply or any part that has the following label attached.

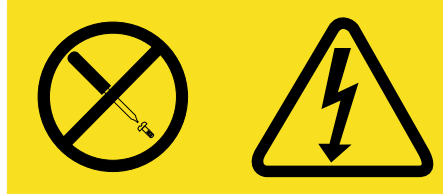

Hazardous voltage, current, and energy levels are present inside any component that has this label attached. There are no serviceable parts inside these components. If you suspect a problem with one of these parts, contact a service technician.

Statement 13



DANGER

Overloading a branch circuit is potentially a fire hazard and a shock hazard under certain conditions. To avoid these hazards, ensure that your system electrical requirements do not exceed branch circuit protection requirements. Refer to the information that is provided with your device for electrical specifications.

Chapter 1. Introducing the IBM xSeries 200 and xSeries 200VL

The IBM® eServer xSeries 200 and xSeries 200VL servers deliver performance and affordability for general server applications. They are ideally suited for networking environments that require superior microprocessor performance, efficient memory management, flexibility, and large amounts of reliable data storage.

The IBM xSeries 200 and xSeries 200VL servers come with a limited warranty and IBM Server Start Up Support. If you have access to the World Wide Web, you can obtain up-to-date information about your model and other IBM server products at the following World Wide Web address: <http://www.ibm.com/eserver/xseries>.

For service, assistance, or additional information on IBM Server Start Up Support and the World Wide Web, see “Getting information, help, and service” on page 91.

The server model and serial numbers are located on labels on the bottom of the server and on the lower-right side of the bezel. You will need these numbers when you register your server with IBM.

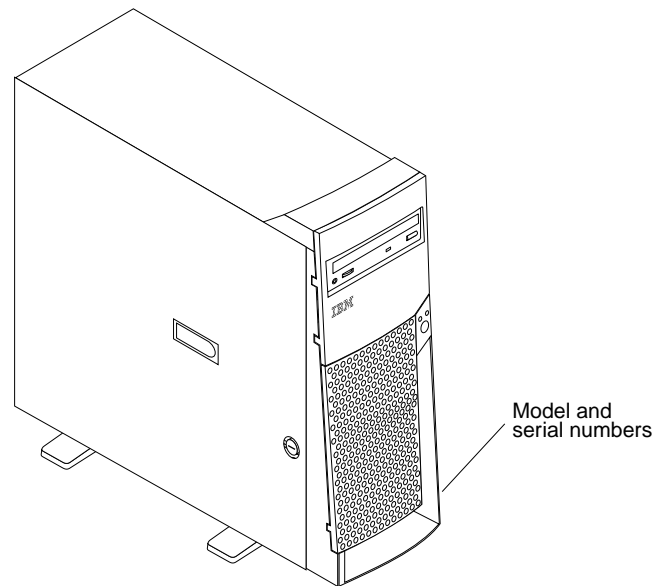

Features and specifications

The following table provides a summary of the features and specifications of your server. Depending on your server model, some features and specifications might not apply.

Table 1. Features and Specifications.

| | | |
|------------------------------------------------------------------------------------------------------------------------------------------------------------------------------------------------------------------------------------------------------------------------------------------------------------------------------------------------------------------------------------------------------------------------------------------------------------------------------------------------------------------------------------------------------------------------------------------------------------------------------------------------------------------------------------------------------------------------------------------------------------------------------------------------------------------------------------------------------------------------------------------------------------------------------------------------------------------------------------------------------------------------------------------------------------------------------------------------------------------------------------------------------------------------------------------------------------------------------------------------------------------------------------------------|----------------------------------------------------------------------------------------------------------------------------------------------------------------------------------------------------------------------------------------------------------------------------------------------------------------------------------------------------------------------------------------------------------------------------------------------------------------------------------------------------------------------------------------------------------------------------------------------------------------------------------------------------------------------------------------------------------------------------------------------------------------------------------------------------------------------------------------------------------------------------------------------------------------------------------------------------------------------------------------------------------------------------------------------------------------------------------------------------------------------------------------------------------------------------------------------------|-----------------------------------------------------------------------------------------------------------------------------------------------------------------------------------------------------------------------------------------------------------------------------------------------------------------------------------------------------------------------------------------------------------------------------------------------------------------------------------------------------------------------------------------------------------------------------------------------------------------------------------------------------------------------------------------------------------------------------------------------------------------------------------------------------------------------------------------------------------------------------------------------------------------------------------------------------------------------------------------------------------------------------------------------------------------------------------------------------------------------------------------------------------------------------------------------------------------------------------------------------------------------------------------------------------------------------------------------------------------|
| <p>Microprocessor: Supports one microprocessor (depending on your model)</p> <ul style="list-style-type: none"> Intel® Pentium® III with 256 KB or 512 KB Level-2 cache and MMX™ (MMX2) technology or Intel Celeron™ with 128 KB Level-2 cache and MMX (MMX2) technology <p>Memory:</p> <ul style="list-style-type: none"> Minimum: 128 MB Maximum: 1.5 GB Type: PC133 MHz, ECC SDRAM, unregistered DIMMs Slots: Three dual inline <p>Drives: (depending on your model)</p> <ul style="list-style-type: none"> Diskette: 1.44 MB CD-ROM: IDE Hard disk drive <p>Expansion bays: (depending on your model)</p> <ul style="list-style-type: none"> Two 5.25-in. bays (one CD-ROM drive installed) Two 3.5-in. bays (one diskette drive installed) Three 3.5-in. slim-high bays available <p>PCI expansion slots:</p> <ul style="list-style-type: none"> Three 33 MHz/32-bit on the system board (some models come with a SCSI adapter installed) Two 33 MHz/32-bit on the PCI extender board <p>AGP slot:</p> <p>Accelerated graphics port (AGP) (contains the video adapter)</p> | <p>Power supply:</p> <p>One 330 watt (90-240 V ac)</p> <p>Video:</p> <p>ATI Rage XL</p> <ul style="list-style-type: none"> AGP video adapter Compatible with SVGA and VGA 8 MB SDRAM video memory <p>Size:</p> <ul style="list-style-type: none"> Height: 470 mm (18.5 in.) Depth: 508 mm (19.9 in.) Width: 165 mm (6.5 in.) Weight: approximately 19.5 kg (43 lb) when fully configured or 15.9 kg (35 lb) minimum <p>Integrated functions:</p> <ul style="list-style-type: none"> One 10BASE-T/100BASE-TX, Intel Ethernet controller with Alert on LAN™ and Wake on LAN® support Two serial ports Parallel port Two USB ports Keyboard port Mouse port MIDI port Audio ports <ul style="list-style-type: none"> Line out Line in Mic Dual-channel bus mastering IDE controller <p>Acoustical noise emissions:</p> <ul style="list-style-type: none"> Sound power, idling: 5.1 bel maximum Sound power, operating: 5.3 bel maximum | <p>Environment:</p> <ul style="list-style-type: none"> Air temperature: <ul style="list-style-type: none"> Server on: 10° to 35° C (50.0° to 95.0° F). Altitude: 0 to 914 m (2998.7 ft) Server on: 10° to 32° C (50.0° to 89.6° F). Altitude: 914 m (2998.7 ft) to 2133 m (6998.0 ft) Server off: 10° to 43° C (50.0° to 109.4° F). Maximum altitude: 2133 m (6998.0 ft) Humidity: <ul style="list-style-type: none"> Server on: 8% to 80% Server off: 8% to 80% <p>Heat output:</p> <p>Approximate heat output in British thermal units (Btu) per hour</p> <ul style="list-style-type: none"> Minimum configuration: 341 Btu (100 watts) Maximum configuration: 1604 Btu (470 watts) <p>Electrical input:</p> <ul style="list-style-type: none"> Sine-wave input (50-60 Hz) required Input voltage low range: <ul style="list-style-type: none"> Minimum: 90 V ac Maximum: 137 V ac Input voltage high range: <ul style="list-style-type: none"> Minimum: 180 V ac Maximum: 265 V ac Input kilovolt-amperes (kVA) approximately: <ul style="list-style-type: none"> Minimum: 0.095 kVA Maximum: 0.470 kVA |
|------------------------------------------------------------------------------------------------------------------------------------------------------------------------------------------------------------------------------------------------------------------------------------------------------------------------------------------------------------------------------------------------------------------------------------------------------------------------------------------------------------------------------------------------------------------------------------------------------------------------------------------------------------------------------------------------------------------------------------------------------------------------------------------------------------------------------------------------------------------------------------------------------------------------------------------------------------------------------------------------------------------------------------------------------------------------------------------------------------------------------------------------------------------------------------------------------------------------------------------------------------------------------------------------|----------------------------------------------------------------------------------------------------------------------------------------------------------------------------------------------------------------------------------------------------------------------------------------------------------------------------------------------------------------------------------------------------------------------------------------------------------------------------------------------------------------------------------------------------------------------------------------------------------------------------------------------------------------------------------------------------------------------------------------------------------------------------------------------------------------------------------------------------------------------------------------------------------------------------------------------------------------------------------------------------------------------------------------------------------------------------------------------------------------------------------------------------------------------------------------------------|-----------------------------------------------------------------------------------------------------------------------------------------------------------------------------------------------------------------------------------------------------------------------------------------------------------------------------------------------------------------------------------------------------------------------------------------------------------------------------------------------------------------------------------------------------------------------------------------------------------------------------------------------------------------------------------------------------------------------------------------------------------------------------------------------------------------------------------------------------------------------------------------------------------------------------------------------------------------------------------------------------------------------------------------------------------------------------------------------------------------------------------------------------------------------------------------------------------------------------------------------------------------------------------------------------------------------------------------------------------------|

Notices and statements used in this book

The caution and danger statements also appear in the multilingual safety book provided on the *IBM xSeries Documentation* CD. Each statement is numbered for easy reference to the corresponding statement in the safety book.

The notice and statement definitions are as follows:

- **Notes:** These notices provide important tips, guidance, or advice.
- **Important:** These notices provide information that might help you avoid inconvenient or problem situations.
- **Attention:** These notices indicate possible damage to programs, devices, or data. An attention notice is placed just before the instruction or situation in which damage could occur.
- **Caution:** These statements indicate situations that can be potentially hazardous to you. A caution statement is placed just before a description of a potentially hazardous procedure step or situation.
- **Danger:** These statements indicate situations that can be potentially lethal or extremely hazardous to you. A danger statement is placed just before the description of a potentially lethal or extremely hazardous procedure step or situation.

What the IBM xSeries 200 and xSeries 200VL offer

The design of your server takes advantage of advancements in data storage and memory management. Your server includes:

- Impressive performance using an innovative approach to microprocessor utilization

Your server comes with one Celeron or Pentium III microprocessor installed.

- Large system memory

The memory bus in your server supports up to 1.5 GB of system memory. The memory controller provides error code correction (ECC) support for up to three industry-standard PC133, 3.3 V, 168-pin, 133 megahertz (MHz), unregistered, synchronous dynamic random access memory (SDRAM) dual in-line memory modules (DIMMs).

- Systems-management capabilities

See the documentation provided with your systems-management software for more information.

- Integrated network environment support

Your server comes with an Ethernet controller on the system board. This Ethernet controller has an interface for connecting to 10-Mbps or 100-Mbps networks. The server automatically selects between 10BASE-T and 100BASE-TX environments. The controller provides full-duplex (FDX) capability, which enables simultaneous transmission and reception of data on the Ethernet local area network (LAN). These controllers support Alert on LAN 2 technology.

- IBM *ServerGuide*™ CDs

The *ServerGuide* CDs that are included with your server provide programs to help you set up your server and install the network operating system (NOS). The *ServerGuide* program detects the hardware options that are installed and provides the correct configuration programs and device drivers. In addition, the *ServerGuide* CDs include a variety of application programs for your server.

For more information about the *ServerGuide* CDs, see Chapter 4, “Using the ServerGuide CDs,” on page 17.

Reliability, availability, and serviceability features

Three of the most important considerations in server design are reliability, availability, and serviceability (RAS). The RAS features help to ensure the integrity of the data that is stored on your server; that your server is available when you want to use it; and that should a failure occur, you can easily diagnose and repair the failure with minimal inconvenience.

The following is an abbreviated list of the RAS features that your server supports.

- Reliability features
 - Boot block recovery
 - Cooling fans with speed-sensing capability
 - Customer-upgradable basic input/output system (BIOS)
 - ECC front-side buses (FSBs)
 - ECC L2 cache
 - ECC memory
 - Parity checking on the small computer system interface (SCSI) bus
 - Advanced configuration and power interface (ACPI)
 - Power-on self-test (POST)
 - SDRAM with serial presence detect (SPD)
- Availability features
 - Advanced desktop management interface (DMI) features
 - Auto-restart initial program load (IPL) power supply
 - Automatic error retry or recovery
 - Automatic server restart
 - Automatic restart after power failure
 - Built-in, menu-driven configuration programs
 - Built-in, menu-driven SCSI configuration programs (some models)
 - Built-in, menu-driven setup programs
 - Failover Ethernet support
 - Menu-driven diagnostic programs on CD-ROM
 - Microsoft® Windows NT® failover support
 - Monitoring support for temperature, voltage, and fan speed
 - Server management
 - ServeRAID™ adapter support
 - Wake on LAN capability
- Serviceability features
 - 24 hours a day, seven days a week customer support¹
 - Adaptec 29160 built-in self-test (BIST)
 - Alert on LAN 2
 - CD-ROM-based diagnostics
 - Diagnostic support of Ethernet adapters
 - Error codes and messages
 - Processor serial number access
 - Read-only memory (ROM) checksums
 - Vital product data (VPD) (includes serial number information and replacement part numbers, stored in nonvolatile memory, for easier remote maintenance)

1. Service availability will vary by country. Response time will vary depending on the number and nature of incoming calls.

Server controls and indicators

The following section identifies the controls and indicators on the front and rear of your server.

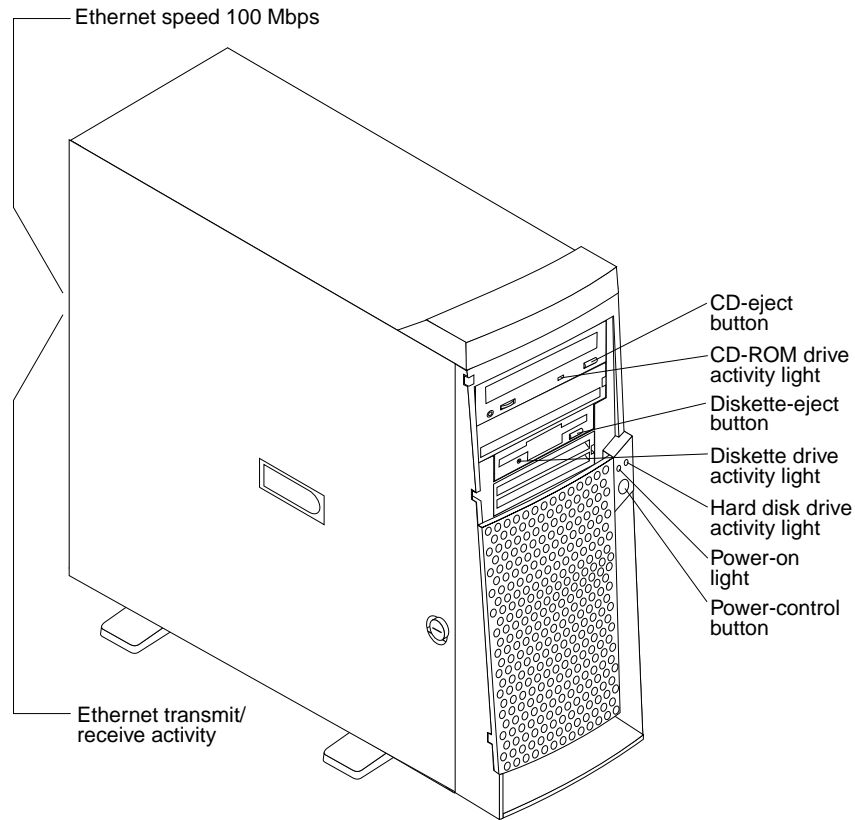

CD-eject button: Push this button to open the CD tray to insert or remove a CD.

CD-ROM drive activity light: When this light is on, the CD-ROM drive is in use.

Diskette-eject button: Push this button to release a diskette from the drive.

Diskette drive activity light: When this light is on, the diskette drive is in use.

Ethernet speed 100 Mbps: When this light is on, the Ethernet speed is 100 Mbps. When the light is off, the Ethernet speed is 10 Mbps. The Ethernet speed light is located on the Ethernet (RJ-45) connector on the rear of the server.

Ethernet transmit/receive activity: When this light is on, there is activity between the server and the network. The Ethernet transmit/receive activity light is located on the Ethernet (RJ-45) connector on the rear of the server.

Hard disk drive activity light: When this light is on, the hard disk drive is in use.

Power-on light: This status indicator lights when you turn on your server.

Power-control button: Press this button to manually turn the server on or off.

See “I/O connector locations” on page 52 for the location of the input/output (I/O) connectors on the rear of the server.

Turning on the server

After you plug one end of the server power cord into the power supply outlet on the rear of the server, and the other end of the power cord into an electrical outlet, the server can start as follows:

- You can press the power-control button on the front of the server to start the server.
- If the server is turned on and a power failure occurs, the server will start automatically when power is restored.

Turning off the server

You can turn off the server in the following ways:

Statement 5



CAUTION:

The power control button on the device and the power switch on the power supply do not turn off the electrical current supplied to the device. The device also might have more than one power cord. To remove all electrical current from the device, ensure that all power cords are disconnected from the power source.

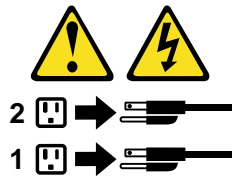

- You can press the power-control button on the front of the server. This starts an orderly shutdown of the operating system, if this feature is supported by your operating system, and places the server in standby mode.

Note: After turning off the server, wait at least 5 seconds before you press the power-control button to turn on the server again.

- You can press and hold the power-control button for more than 4 seconds to cause an immediate shutdown of the server and place the server in standby mode. You can use this feature if the operating system stops functioning.
- You can disconnect the server power cords from the electrical outlets to shut off all power to the server.

Note: After disconnecting the power cords, wait approximately 15 seconds for your system to stop running.

Chapter 2. Arranging your workspace

To get the most from your server, arrange both the equipment you use and your work area to suit your needs and the kind of work you do. Your comfort is of foremost importance, but light sources, air circulation, and the location of electrical outlets also can affect the way you arrange your workspace.

Comfort

Although no single working position is ideal for everyone, here are a few guidelines to help you find a position that suits you best.

Sitting in the same position for a long time can cause fatigue. A good chair can make a big difference. The backrest and seat should adjust independently and provide good support. The seat should have a curved front to relieve pressure on the thighs. Adjust the seat so that your thighs are parallel to the floor and your feet are either flat on the floor or on a footrest.

When using the keyboard, keep your forearms parallel to the floor and your wrists in a neutral, comfortable position. Try to keep a light touch on the keyboard and your hands and fingers relaxed. You can change the angle of the keyboard for maximum comfort by adjusting the position of the keyboard feet.

Adjust the monitor so the top of the screen is at, or slightly below, eye-level. Place the monitor at a comfortable viewing distance, usually 51 to 61 cm (20 to 24 in.), and position it so you can view it without having to twist your body. Also position other equipment you use regularly, such as the telephone or a mouse, within easy reach.

Glare and lighting

Position the monitor to minimize glare and reflections from overhead lights, windows, and other light sources. Even reflected light from shiny surfaces can cause annoying reflections on your monitor screen. Place the monitor at right angles to windows and other light sources, when possible. Reduce overhead lighting, if necessary, by turning off lights or using lower wattage bulbs. If you install the monitor near a window, use curtains or blinds to block the sunlight. You might have to adjust the brightness and contrast controls on the monitor as the room lighting changes throughout the day.

Where it is impossible to avoid reflections or to adjust the lighting, an antiglare filter placed over the screen might be helpful. However, these filters might affect the clarity of the image on the screen; try them only after you have tried all other methods of reducing glare.

Dust buildup compounds problems that are associated with glare. Remember to clean your monitor screen periodically using a soft cloth that is moistened with a nonabrasive liquid glass cleaner.

Air circulation

Your server and monitor produce heat. Your server has one or more fans that pull in fresh air and force out hot air. The monitor lets hot air escape through vents. Blocking the air vents can cause overheating, which might result in a malfunction or damage. Place the server and monitor so that nothing blocks the air vents; usually, 15 cm (6 in.)

of air space is sufficient. Also, make sure that the vented air is not blowing on someone else.

Electrical outlets and cable lengths

The location of electrical outlets and the length of power cords and cables that connect to the monitor, printer, and other devices might determine the final placement of your server.

When arranging your workspace:

- Avoid the use of extension cords. When possible, plug the server power cords directly into electrical outlets.
- Keep power cords and cables neatly routed away from walkways and other areas where they might get kicked accidentally.

For more information about power cords, refer to the power cord information in this on-line publication.

Chapter 3. Configuring your server

The following configuration programs are provided with your server:

- **Configuration/Setup Utility**

This program is part of the BIOS code that comes with your server. You can use this program to configure serial- and parallel-connector assignments, change the drive startup sequence, set the date and time, and set passwords. See “Using the Configuration/Setup Utility program” for more information.

- **SCSISelect Utility (some models)**

With the SCSISelect Utility program, you can configure the devices that are attached to the SCSI adapter. Use this program to change default values, resolve configuration conflicts, and perform a low-level format on a SCSI hard disk drive. See “Using the SCSISelect utility program (some models)” on page 12 for more information.

- **PXE Boot Agent Utility**

The Preboot eXecution Environment (PXE) Boot Agent Utility program is part of the BIOS code that comes with your server. Depending on your server model, you can use this program to change network startup (boot) protocols and startup order, to select operating-system wake-up support, and to set menu wait times.

Attention: The network startup protocols and startup order options are not supported on this product.

See “Using the PXE Boot Agent Utility program” on page 14 for more information.

- **ServerGuide CDs**

The *ServerGuide* CDs include software setup and installation tools that are specifically designed for IBM xSeries servers. You can use these CDs during the initial installation of your server to configure the server hardware and simplify your network operating system installation. The ServerGuide CDs also contain a collection of application programs, which you can install after your server is up and running. See Chapter 4, “Using the ServerGuide CDs,” on page 17 for more detailed information.

- **ServeRAID programs**

The ServeRAID programs come with the optional ServeRAID adapters and with server models that have a ServeRAID adapter preinstalled. If your server has a ServeRAID adapter installed, you must use the ServeRAID Configuration program to define and configure your disk-array subsystem *before* you install your operating system. See the ServeRAID documentation provided on the *IBM xSeries Documentation* CD for more information.

Using the Configuration/Setup Utility program

This section provides instructions for starting the Configuration/Setup Utility program and also provides descriptions of the menu choices that are available.

Starting the Configuration/Setup Utility program

Complete the following steps to start the Configuration/Setup Utility program:

1. Turn on the server and watch the monitor screen.
2. When the message Press F1 for Configuration/Setup appears, press the F1 key.
3. Follow the instructions that appear on the screen.

Choices available from the Configuration/Setup main menu

From the Configuration/Setup Utility main menu, you can select settings that you want to change. The Configuration/Setup Utility main menu is similar to the following illustration:

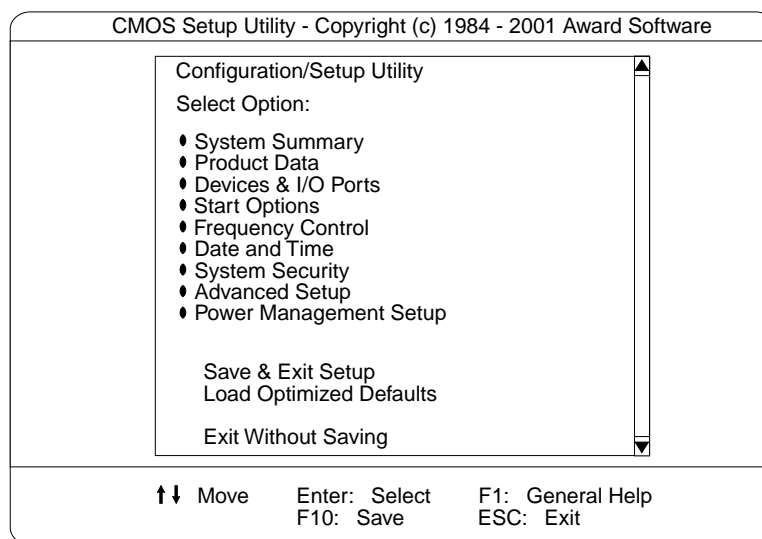

Notes:

1. You can press the F1 key to display help information for a selected menu item.
2. Some menu choices might differ, depending on the types of passwords set for your system and IBM system management adapters, or in the version of BIOS code installed on your server.

Descriptions of the choices that are available from the main menu are as follows:

- **System Summary**

Select this choice to display configuration information. This includes the type and speed of the microprocessor and the amount of memory that is installed.

Changes that you make to configuration settings appear on this summary screen. You cannot edit the fields.

This choice appears on both the full and limited Configuration/Setup Utility menus.

- **Product Data**

Select this choice to view system information, such as the machine type and model, the server serial number, and the revision level or issue date of the BIOS code that is stored in the flash electrically erasable programmable read-only memory (EEPROM).

- **Devices & I/O Ports**

Select this choice to view or change the assignments for devices and input/output ports. This choice appears only on the full Configuration/Setup Utility main menu.

- **Start Options**

Select this choice to view or change the start options. Start options take effect when you start your server.

You can select keyboard operating characteristics, such as the keyboard speed. You also can specify whether the server starts with the keyboard number lock on or off.

The server uses a startup sequence to determine the device from which the operating system starts. For example, you can define a startup sequence that checks for a startable diskette in the diskette drive, then checks the hard disk drive in a drive bay, and then checks a network adapter.

You can enable a virus-warning test that checks for changes in the master boot record at startup. You also can choose to run POST in the Quick mode and read the microprocessor serial number.

- **Frequency Control**

Select this choice to enable or disable the auto-detect DIMM/PCI clock.

- **Date and Time**

Select this choice to set the system date and time.

The system time is in a 24-hour format: hour:minute:second.

Note: You may also set the date and time using the procedures provided on the *ServerGuide* CDs.

- **System Security**

Select this choice to set a power-on or administrator password. See “Using passwords” on page 12 for more information. You can also enable the chassis-intrusion detector to alert you each time the server cover is removed.

Note: To have your system generate an intrusion alert, you must enable the intrusion alert function, and you must set an administrator password. For more information about setting passwords, see “Using passwords” on page 12.

- **Advanced Setup**

Select this choice to change values for advanced hardware features, such as Cache Control and PCI configuration.

A message appears above the choices on this menu to alert you that the system might malfunction if these options are configured incorrectly. Follow the instructions on the screen carefully.

- **Cache Control**

Select this choice to enable or disable the microprocessor cache.

Attention: Do not make changes to the Cache Control option unless directed to do so by an IBM authorized service representative.

- **ROM Shadowing**

Select this choice to enable or disable the state of ROM shadowing.

- **Chipset Feature**

Select this choice to modify settings that control features of the core chip set on the system board.

Attention: Do not make changes to the Chipset Feature option unless directed to do so by an IBM authorized service representative.

- **Memory Settings**

Select this choice to manually enable or disable a bank of memory.

If a memory error is detected during POST or memory configuration, the server can automatically disable the failing memory bank and continue operating with reduced memory capacity. If this occurs, you must manually enable the memory bank after the problem is corrected. Select **Memory Settings** from the Advanced Setup menu, and use the arrow keys to highlight the bank that you want to enable; then, use the arrow keys to select **Enable**.

- **Power Management Setup**

Select this choice to enable or disable system power savings.

- **Save and Exit Setup**

Select this choice to save your customized settings.

- **Load Optimized Defaults**

Select this choice to discard your changes and restore the factory settings.

- **Exit Without Saving**

Select this choice if you want to exit without saving changes, or if no changes have been made.

Using passwords

The **System Security** choice appears only on the full Configuration/Setup Utility menu. After you select this choice, you can set a power-on password or an administrator password.

You can use any combination of up to seven characters (A–Z, a–z, and 0–9) for the power-on password or the administrator password. When you have set one or both of the passwords, record them and keep them in a secure place.

If both a power-on and administrator password are set, you can type either password at the password prompt that appears as you start your server. However, if you want to change the settings in the Configuration/Setup Utility program, you must type the administrator password to access the full configuration menus. If you type the power-on password, you can only view limited information in the Configuration/Setup Utility program.

If you forget the power-on password, you can regain access to the server through either of the following methods:

- Start the Configuration/Setup Utility program and change the power-on password.
- Change the position of the CMOS jumper as described in “Clearing CMOS” on page 78.

Using the SCSISelect utility program (some models)

SCSISelect is a built-in, menu-driven configuration utility program that you can use to:

- View the default SCSI IDs
- Locate and correct configuration conflicts

The following sections provide instructions for starting the SCSISelect Utility program and descriptions of the menu choices that are available.

Note: If your server has a redundant arrays of independent disks (RAID) adapter installed, use the configuration method that is supplied with the RAID adapter to view or change SCSI settings for devices attached to the adapter.

Starting the SCSISelect utility program

Complete the following steps to start the SCSISelect Utility program:

1. Turn on the server.
2. When the <<< Press <CTRL><A> for SCSISelect™ Utility! >>> prompt appears, press Ctrl+A.
3. When the Would you like to configure the host adapter or run the SCSI disk utility? question appears, make your selection and press Enter.

4. Use the arrow keys to select a choice from the menu.
 - Press Esc to exit the SCSISelect Utility program.
 - Press the F5 key to switch between color and monochrome modes (if your monitor permits).
5. Follow the instructions on the screen to change the settings of the selected items; then, press Enter.

Choices available from the SCSISelect menu

The following choices appear on the SCSISelect Utility menu:

- **Configure/View Host Adapter Settings**

Select this choice to view or change the SCSI controller settings. To reset the SCSI controller to its default values, press the F6 key; then, follow the on-screen instructions.

You can view or change the following controller settings:

- **Host Adapter SCSI ID**

Select this choice to view the SCSI controller identification (ID), which is usually 7.

- **SCSI Parity Checking**

Select this choice to view the assigned value. The assigned value is *Enabled*, and cannot be changed.

- **Host Adapter SCSI Termination**

Select this choice to view the assigned value. The assigned value is *Automatic*, and cannot be changed.

- **Boot Device Options**

Select this choice to configure startable-device parameters. Before you can make updates, you must know the ID of the device whose parameters you want to configure.

- **SCSI Device Configuration**

Select this choice to configure SCSI-device parameters. Before you can make updates, you must know the ID of the device whose parameters you want to configure.

Note: The Maximum Sync Transfer Rate is the transfer rate for Ultra SCSI devices.

- The transfer rate for Ultra160 low voltage differential (LVD) devices is 160.0 MBps.
- The transfer rate for Ultra2 SCSI LVD devices is 80.0 MBps.
- The transfer rate for Fast SCSI devices is 20.0 MBps.

- **Advanced Configuration Options**

Select this choice to view or change the settings for advanced configuration options. These options include support for large hard disk drives and support for drives with Ultra SCSI speeds.

- **SCSI Disk Utilities**

Select this choice to view the SCSI IDs that are assigned to each device or to format a SCSI device.

To use the utility program, select a drive from the list. Read the on-screen instructions carefully before making a selection.

Note: If you press Ctrl+A before the selected drives are ready, an Unexpected SCSI Command Failure screen might appear. Restart the server and

watch the SCSISelect messages as each drive starts. After the drive that you want to view or format starts, press Ctrl+A.

- **Format Disk**

Attention: The Low-Level Format program erases *all* data and programs.

Select this choice to perform a low-level format on a hard disk drive. Depending on the hard disk drive capacity, the Low-Level Format program could take up to two hours.

Use the Low-Level Format program:

- When you are installing software that requires a low-level format
- When you get recurring messages from the diagnostic tests directing you to run the Low-Level Format program on the hard disk drive
- As a last resort before replacing a failing hard disk drive

Note: If your server has a PCI RAID adapter installed, refer to the RAID adapter documentation for instructions for performing low-level formats on hard disk drives attached to the adapter.

To start the Low-Level Format program:

1. If the hard disk drive is working, make a backup copy of all the files and programs on the hard disk drive. (See your operating system information for instructions.)
2. Select **Format Disk**; then, follow the instructions on the screen.

Note: Hard disk drives normally contain more tracks than their stated capacity (to allow for defective tracks). A message appears on the screen if the defect limit is reached. If this happens, replace the hard disk drive.

Using the PXE Boot Agent Utility program

The PXE boot agent is a built-in, menu-driven configuration utility program that you can use to:

- Select whether to display the setup prompt
- Set menu wait time
- Select operating-system wake-up support

Attention: The network startup protocols and startup order options are not supported on this product.

The following sections provide instructions for starting the PXE Boot Agent Utility program and descriptions of the menu choices that are available.

Starting the PXE Boot Agent Utility program

To start the PXE Boot Agent Utility program:

1. Turn on the server.
2. When the Initializing Intel (R) Boot Agent Version X.X.XX PXE 2.0 Build XXX (WfM 2.0) prompt appears, press Ctrl+S.
Note: By default, you will have 2 seconds after the prompt appears on the screen to press Ctrl+S.
3. Use the arrow keys or press Enter to select a choice from the menu.
 - Press Esc to return to the previous menu.
 - Press the F4 key to exit.

4. Follow the instructions on the screen to change the settings of the selected items; then, press Enter.

Choices available from the PXE Boot Agent Utility menu

The following choices appear on the PXE Boot Agent Utility menu:

- **Network Boot Protocol**

PXE is the default value for this menu item.

Note: Do not change this value. There are no other network boot protocols supported.

- **Boot Order**

Attention: This option is not supported on this product. To change the boot order, use the Configuration/Setup Utility program. See, "Using the Configuration/Setup Utility program" on page 9 for more information.

- **Show setup prompt**

Select this choice to either display the PXE setup prompt or disable it. **Disable** is the default setting.

When this choice is enabled, Press Ctrl+S to enter the setup menu will appear on the screen under the initializing prompt.

- **Setup time wait menu**

Select this choice to set the amount of time (in seconds) that the system will pause during initialization for a Ctrl+S input.

— 2 seconds (default)

— 3 seconds

— 5 seconds

— 8 seconds

- **Legacy OS wake up support**

Select this choice to enable or disable the legacy operating-system wake-up support.

— Disabled (default)

— Enabled

Notes:

1. Use the default setting for Advanced Configuration and Power Interface (ACPI) aware operating systems, such as Windows 2000 and Windows NT.
2. If your server is running a non-ACPI operating system, you must set this selection to Enabled to use the Wake on LAN support.
3. When using a non-ACPI operating system, do not send a wake-up packet to the server while it is turned on. If a wake-up packet has been sent while the server is on and you are unable to turn the server off, see the "Power" section in the "Troubleshooting charts" on page 79 for more information.

Chapter 4. Using the ServerGuide CDs

The ServerGuide CDs include easy-to-use software setup and installation tools that are specifically designed for your IBM server. The ServerGuide Setup and Installation program detects the server model and hardware options that are installed and uses that information during setup to configure the hardware. The ServerGuide tools simplify network operating system (NOS) installations by providing updated device drivers, and in some cases, installing them automatically.

If a newer version of the ServerGuide software is available, you can purchase an update package. For details, see the ServerGuide Updates form that comes with your server library, or go to the ServerGuide fulfillment Web site at <http://www.ibm.com/pc/coupon>.

The ServerGuide software has these features to make setup easier:

- An easy-to-use interface with online help
- Diskette-free setup, and configuration programs that are based on detected hardware
- Performance Optimizer program, which easily tunes your ServeRAID adapter settings for your server environment
- A system BIOS update program, which updates the BIOS code directly from the CD
- Device drivers that are provided for your server model and detected hardware
- NOS partition size and file-system type that are selectable during setup
- Powerful application programs and administration tools

Features at a glance

The following is a summary of ServerGuide features.

Note: Exact features and functions can vary with different versions of the ServerGuide software. To learn more about the version that you have, start the *Setup and Installation CD* and view the online Overview.

| | | |
|----------------------------------------------------------------------------------------------------------------------------------------------------------------------------------------------------------------------------------------------------------------------------------------------------------------------------------------------------------------------------------------------------------------------------------------------------------------------------------------------------------------------------------------------------------------------------------------------------------------------------------------------------------------------------------------------------------------------------------------------------------------------------------------------------------------------------------------------------------------------------------------------------------------------------------------------------------------------------------------------------------------------------------------------------------------------------------------------------|-------------------------------------------------------------------------------------------------------------------------------------------------------------------------------------------------------------------------------------------------------------------------------------------------------------------------------------------------------------------------------------------------------------------------------------------------------------------------------------------------------------------------------------------------------------------------------------------------------------------------------------------------------------------------------------------------------------------------------------------------------------------------------------------------------------------------------------------------------------------------------------------------------------------------------------------------------------------------------------------------------------------------------------------------------------------------------------------------------------------------------------------------------------------------------------------------------------------------------------------------------|----------------------------------------------------------------------------------------------------------------------------------------------------------------------------------------------------------------------------------------------------------------------------------------------------------------------------------------------------------------------------------------------------------|
| <p>Setup and Installation CD</p> <p>Note: The ServerGuide program requires a supported IBM server with an <i>enabled</i> startable (bootable) CD-ROM drive. Not all features are supported on all models.</p> <ul style="list-style-type: none"> • Sets system date and time. • Detects the ServeRAID adapter or controller and runs the ServeRAID configuration program. • Updates the licensed internal code (firmware) level without creating diskettes. • Checks the system BIOS code and microcode (firmware) levels of supported options to determine whether a later level is available from the CD. You can perform updates without the use of diskettes. • Provides the Performance Optimizer program to easily tune your ServeRAID adapter settings for your server environment. • Creates a System Partition on the default drive. You can run server-specific utility programs after setup. • Detects installed hardware options and provides updated device drivers for most adapters and devices. | <p>Setup and Installation CD (continued)</p> <ul style="list-style-type: none"> • Creates a <i>Setup Replication Diskette</i> for replicating setup selections for other servers of the same model. • Provides diskette-free installation for Microsoft® Windows® 2000, Windows NT®, Novell NetWare, SCO UnixWare, and Red Hat Linux operating systems. • Provides a replicated installation path for multiple Windows 2000, Windows NT Server 4.0, Windows Enterprise Edition, and Red Hat Linux installations. • Includes an online README file with links to tips for your hardware and NOS installation. <p>Note: Installation requires your NOS CD.</p> <p>System Updates and Applications CD</p> <ul style="list-style-type: none"> • Creates diagnostic, RAID, device driver, and other support diskettes from the CD; or with an Internet connection, you can check for an update from a dedicated IBM file transfer protocol (FTP) server. • Installs some updates without requiring diskettes. Where applicable, you can run executable files directly from the CD or unzip files to any drive on your server or another server on your network. | <p>System Updates and Applications CD (continued)</p> <ul style="list-style-type: none"> • Includes a vast library of fully tested device drivers for your server. • Includes a search function to help you locate updates by title or keywords. • Installs powerful applications directly from the CD. See the CD label for a current list of applications. |
|----------------------------------------------------------------------------------------------------------------------------------------------------------------------------------------------------------------------------------------------------------------------------------------------------------------------------------------------------------------------------------------------------------------------------------------------------------------------------------------------------------------------------------------------------------------------------------------------------------------------------------------------------------------------------------------------------------------------------------------------------------------------------------------------------------------------------------------------------------------------------------------------------------------------------------------------------------------------------------------------------------------------------------------------------------------------------------------------------|-------------------------------------------------------------------------------------------------------------------------------------------------------------------------------------------------------------------------------------------------------------------------------------------------------------------------------------------------------------------------------------------------------------------------------------------------------------------------------------------------------------------------------------------------------------------------------------------------------------------------------------------------------------------------------------------------------------------------------------------------------------------------------------------------------------------------------------------------------------------------------------------------------------------------------------------------------------------------------------------------------------------------------------------------------------------------------------------------------------------------------------------------------------------------------------------------------------------------------------------------------|----------------------------------------------------------------------------------------------------------------------------------------------------------------------------------------------------------------------------------------------------------------------------------------------------------------------------------------------------------------------------------------------------------|

Setup and configuration overview

When you use the *Setup and Installation* CD, you do not need setup diskettes. You can use the CD to configure any supported IBM server model. The setup program checks your system BIOS, service processors, and other system hardware to determine if system updates are available. The setup program provides a list of tasks that are required to set up your server model. On RAID servers, you can run the ServeRAID Manager program to create logical drives.

Note: Exact features and functions can vary with different versions of the ServerGuide software.

When you start the *Setup and Installation* CD, the following happens:

- You are prompted for your language, country, and keyboard layout. (This information is stored and later passed on to the NOS installation program.)
- The ServerGuide program displays choices for running the configuration programs. For example:
 - The Express Configuration method runs the required programs for your server, based on the hardware that is detected.
 - The Custom Configuration method displays all programs that are available for your server, and you decide which programs to run.
 - The Replicated Configuration method provides the option of duplicating your setup selections to other servers that are the same model.
- If you select the Custom Configuration method, the following programs are optional. If you select the Express Configuration method, some or all of these programs are run, depending on the hardware that is detected.
 - The Set Date and Time feature is provided so that you do not have to use the Configuration/Setup Utility program to access these settings.
 - The Clear Hard Disks program is provided so you can delete all partitions on all hard disk drives. If the server has a ServeRAID adapter installed, you can select to restore the configuration on the ServeRAID adapter to the factory default settings.
 - The ServerGuide program checks the server BIOS code and microcode (firmware) levels for supported options and then checks the CD for a newer level. CD content can be newer than the hardware. The ServerGuide program can perform a flash update of the BIOS code and supported microcode (firmware) options without the use of diskettes.
 - The ServeRAID program starts, leading you through the entire configuration process.
 - The Performance Optimizer program easily tunes your server for your environment.
 - The ServerGuide program creates a System Partition on the default drive.
- The ServerGuide program displays a confirmation summary, so that you will know when you have completed all the required tasks. Then, you are ready to install your NOS.

Notes:

1. Plug and Play adapters are configured automatically. Non-Plug and Play adapters or non-IBM adapters might require switch settings, additional device drivers, and installation after the NOS is installed. See the documentation that comes with the adapter.
2. Diagnostics for your server come in BIOS code or on a separate diagnostics CD.

System Partition

The ServerGuide program creates a 50 MB System Partition on the default drive. The System Partition contains server-specific utility programs such as service processor disk operating system (DOS) utilities, system diagnostics, flash BIOS updates, and other programs.

Note: Programs in the System Partition vary by server model, and not all server models run utility programs from the System Partition. To determine which ones do, start the *Setup and Installation* CD and view the online Overview.

After setup is complete, you can access programs in the System Partition by restarting the server and pressing Alt+F1 when the prompt is displayed. The System Partition menu displays the programs that are available on your server model.

Typical NOS installation

You can use the ServerGuide program to shorten your installation time. The ServerGuide program provides the necessary device drivers, based on the hardware that you have and the NOS that you are installing. The following is a brief explanation of a typical ServerGuide NOS installation.

Note: Exact features and functions can vary with different versions of the ServerGuide software.

- After you have completed the setup process, the operating-system installation program starts. (You will need your copy of the NOS CD to complete the installation.)
- The ServerGuide program stores information about the server model, service processor, hard disk controllers, and network adapters. It then checks the CD for newer device drivers. This information is stored and then passed to the NOS installation program.
- With some NOS installations, you can create a *NOS Replication Diskette* for setting up additional servers. The diskette will contain the Internet protocol (IP) address, server name, and other selections.
- The ServerGuide program presents NOS partition options that are based on your NOS selection and the installed hard disk drives.
- If you are installing the NOS from diskette, the ServerGuide program displays the required diskettes that you must create and the optional diskettes that you might want to create. The diskettes that you can create are the device-driver diskettes for the installed adapters or controllers.

The ServerGuide program prompts you to insert your NOS CD and restart the server. At this point, the installation program for the NOS (for example, Microsoft Windows 2000) takes control to complete the installation.

Setting up or updating multiple servers

You can use the ServerGuide program to create diskettes that help you set up or update multiple servers. You can modify information on the diskettes as you use them to set up or update other servers.

Note: Availability and function can vary by server model and by the hardware that is installed.

You can create a setup-replication diskette, which contains your hardware configuration selections. Use this diskette to replicate selections to other servers that are of the same model.

You can create a NOS-replication diskette, which contains your server name, domain name, and other information that you need to complete multiple installations. This feature supports systems running Windows 2000, Windows NT Server 4.0, and Red Hat Linux operating systems.

Installing your NOS without ServerGuide

If you have already configured the server hardware and you decide not to use the ServerGuide program to install your NOS, download the latest NOS installation instructions:

1. Go to <http://www.ibm.com/pc/support>.
2. Click **Servers**.
3. From the **Family** field, select your server model.
4. Click **OS installation**. The available installation instructions are displayed.

Additional programs included with ServerGuide

As a convenience, the ServerGuide program comes with additional software to assist you with the server installation.

A variety of powerful applications are included with the ServerGuide software. Offerings can vary with the different versions of the ServerGuide software. Check the application CD labels for a list of applications, or start the *Setup and Installation* CD and view the online Overview.

Chapter 5. Installing options

This chapter provides instructions to help you install options in your server. Some option-removal instructions are provided, in case you need to remove one option to install another. For a list of supported options for your server, see the ServerProven™ list at <http://www.ibm.com/pc/compat>.

Major components of the xSeries 200 and xSeries 200VL

The blue color on components and labels indicates touch points where a component can be gripped, a latch moved, and so on.

The following illustration shows the locations of major components in your server.

Note: The illustrations in this document might differ slightly from your hardware.

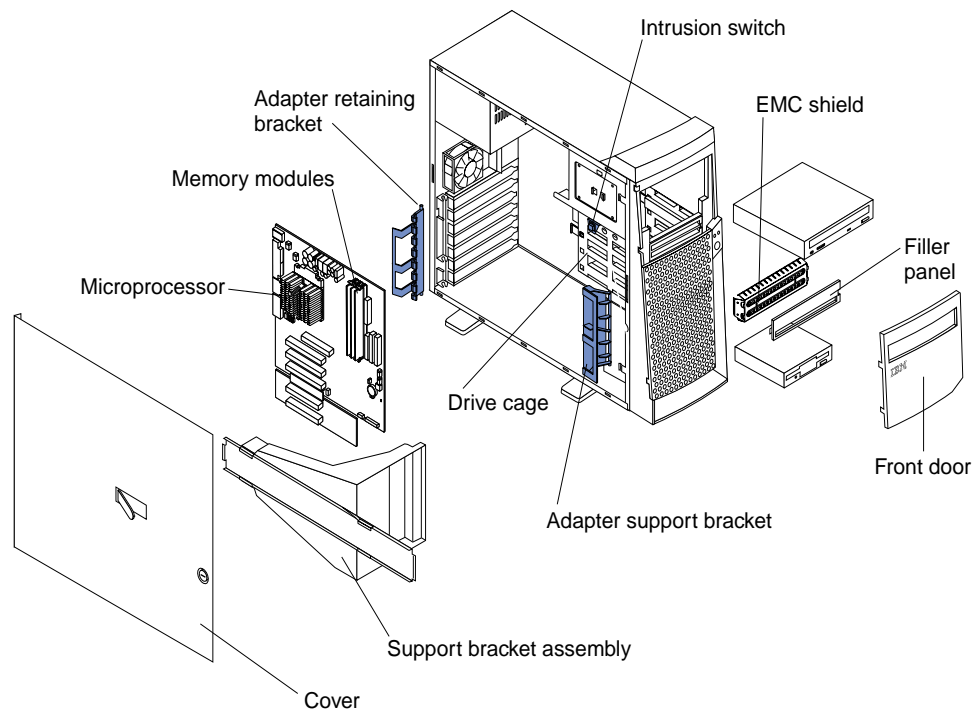

System and PCI extender boards

The illustrations in the following sections show the connectors and jumpers on the system and PCI extender boards.

System and PCI extender-board option connectors

The following illustration identifies system and PCI extender-board connectors for options you can install.

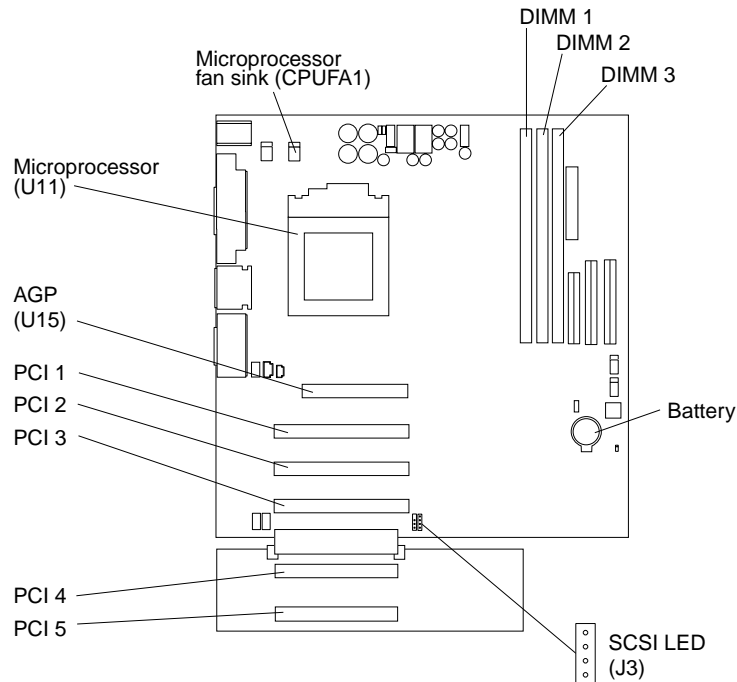

System board internal cable connectors

The following illustration identifies system board connectors for internal cables.

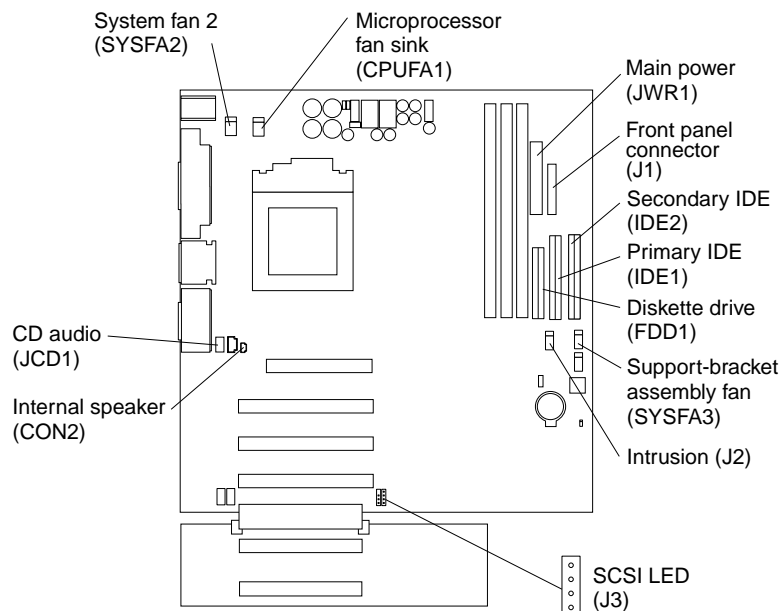

System board external connectors

The following illustration identifies system board connectors for external devices.

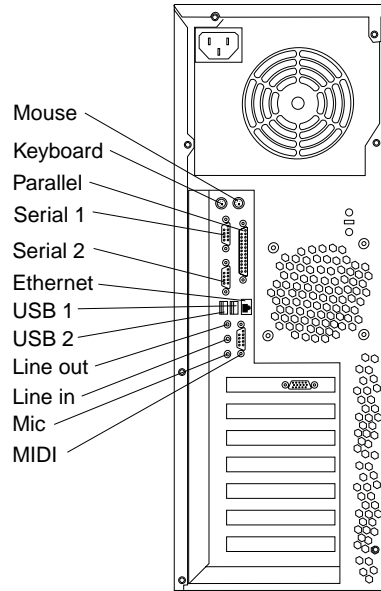

System board jumpers

The following illustration identifies the jumpers on the system board.

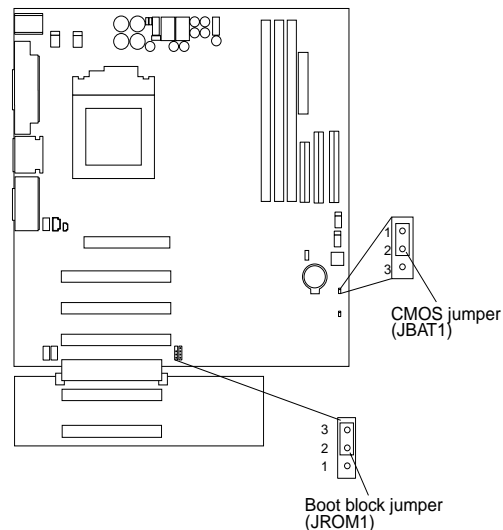

Boot block jumper

For typical operation of the system, a jumper is installed on pins 2 and 3 of the boot block jumper.

Note: Do not remove the boot block jumper (JROM1) unless instructed to do so by an IBM authorized service representative.

CMOS jumper

For typical operation of the system, a jumper is installed on pins 1 and 2 of the complementary metal oxide semiconductor (CMOS) jumper. See “Clearing CMOS” on page 78 for information about the CMOS jumper.

Before you begin

Before you begin to install options in your server, read the following information:

- Become familiar with the handling guidelines specified under “Handling static-sensitive devices” on page 27, and the safety statements in “Safety information” on page 28. These guidelines will help you work safely with your server or options.
- The blue color on components and labels identifies touch points where a component can be gripped, a latch moved, and so on.
- Make sure that you have an adequate number of properly grounded electrical outlets for your server, monitor, and any other options that you intend to install.
- When you need to access the inside of the server to install options, you might find it easier to lay the server on its side. If you do so, make sure the stabilizing feet are in the horizontal position. Otherwise, the feet might break off because of the weight of the server. For complete details, see “Moving the stabilizing feet” on page 32.
- Back up all important data before you make changes to hard disk drives.
- Have a small, flat-blade screwdriver available.

- For a list of supported options for your server, refer to <http://www.ibm.com/pc/compat> on the World Wide Web.

System reliability considerations

To help ensure proper cooling and system reliability, make sure that:

- Each of the drive bays either has a drive or a filler panel and electromagnetic compatibility (EMC) shield installed.
- There is space around the server to allow the server cooling system to work properly. Leave approximately 127 mm (5 in.) of space around the front and rear of the server.
- Cables for optional adapters are routed according to the instructions that are provided with the adapters.
- A failed fan is replaced within 1 hour.

Handling static-sensitive devices

Attention: Static electricity can damage electronic devices and your system. To avoid damage, keep static-sensitive devices in their static-protective package until you are ready to install them.

To reduce the possibility of electrostatic discharge, observe the following precautions:

- Limit your movement. Movement can cause static electricity to build up around you.
- Handle the device carefully, holding it by its edges or its frame.
- Do not touch solder joints, pins, or exposed printed circuitry.
- Do not leave the device where others can handle and possibly damage the device.
- While the device is still in its static-protective package, touch it to an unpainted metal part of the system unit for at least two seconds. (This drains static electricity from the package and from your body.)
- Remove the device from its package and install it directly into your system unit without setting it down. If it is necessary to set the device down, place it in its static-protective package. Do not place the device on your system unit cover or on a metal table.
- Take additional care when handling devices during cold weather because heating reduces indoor humidity and increases static electricity.

Safety information

Before installing this product, read the Safety Information.

مع، يجب قراءة دات السلامة

Antes de instalar este produto, leia as Informações de Segurança.

在安装本产品之前，请仔细阅读 **Safety Information** (安全信息)。

安裝本產品之前，請先閱讀「安全資訊」。

Prije instalacije ovog produkta obavezno pročitajte Sigurnosne Upute.

Před instalací tohoto produktu si přečtěte příručku bezpečnostních instrukcí.

Læs sikkerhedsforskrifterne, før du installerer dette produkt.

Lees voordat u dit product installeert eerst de veiligheidsvoorschriften.

Ennen kuin asennat tämän tuotteen, lue turvaohjeet kohdasta Safety Information.

Avant d'installer ce produit, lisez les consignes de sécurité.

Vor der Installation dieses Produkts die Sicherheitshinweise lesen.

Πριν εγκαταστήσετε το προϊόν αυτό, διαβάστε τις πληροφορίες ασφάλειας (safety information).

לפני שתתקינו מוצר זה, קראו את הוראות הבטיחות.

A termék telepítése előtt olvassa el a Biztonsági előírásokat!

Prima di installare questo prodotto, leggere le Informazioni sulla Sicurezza

製品の設置の前に、安全情報をお読みください。

본 제품을 설치하기 전에 안전 정보를 읽으십시오.

Пред да се инсталира овој продукт, прочитајте информацијата за безбедност.

Les sikkerhetsinformasjonen (Safety Information) før du installerer dette produktet.

Przed zainstalowaniem tego produktu, należy zapoznać się z książką "Informacje dotyczące bezpieczeństwa" (Safety Information).

Antes de instalar este produto, leia as Informações sobre Segurança.

Перед установкой продукта прочтите инструкции по технике безопасности.

Pred inštaláciou tohto zariadenia si pečítajte Bezpečnostné predpisy.

Pred namestitvijo tega proizvoda preberite Varnostne informacije.

Antes de instalar este producto lea la información de seguridad.

Läs säkerhetsinformationen innan du installerar den här produkten.

Statement 1



DANGER

Electrical current from power, telephone, and communication cables is hazardous.

To avoid a shock hazard:

- **Do not connect or disconnect any cables or perform installation, maintenance, or reconfiguration of this product during an electrical storm.**
- **Connect all power cords to a properly wired and grounded electrical outlet.**
- **Connect to properly wired outlets any equipment that will be attached to this product.**
- **When possible, use one hand only to connect or disconnect signal cables.**
- **Never turn on any equipment when there is evidence of fire, water, or structural damage.**
- **Disconnect the attached power cords, telecommunications systems, networks, and modems before you open the device covers, unless instructed otherwise in the installation and configuration procedures.**
- **Connect and disconnect cables as described in the following table when installing, moving, or opening covers on this product or attached devices.**

To Connect:

1. Turn everything OFF.
2. First, attach all cables to devices.
3. Attach signal cables to connectors.
4. Attach power cords to outlet.
5. Turn device ON.

To Disconnect:

1. Turn everything OFF.
2. First, remove power cords from outlet.
3. Remove signal cables from connectors.
4. Remove all cables from devices.

Statement 2



CAUTION:

When replacing the lithium battery, use only IBM Part Number 33F8354 or an equivalent type battery recommended by the manufacturer. If your system has a module containing a lithium battery, replace it only with the same module type made by the same manufacturer. The battery contains lithium and can explode if not properly used, handled, or disposed of.

Do not:

- Throw or immerse into water
- Heat to more than 100°C (212°F)
- Repair or disassemble

Dispose of the battery as required by local ordinances or regulations.

Statement 3



CAUTION:

When laser products (such as CD-ROMs, DVD drives, fiber optic devices, or transmitters) are installed, note the following:

- Do not remove the covers. Removing the covers of the laser product could result in exposure to hazardous laser radiation. There are no serviceable parts inside the device.
- Use of controls or adjustments or performance of procedures other than those specified herein might result in hazardous radiation exposure.



DANGER

Some laser products contain an embedded Class 3A or Class 3B laser diode. Note the following.

Laser radiation when open. Do not stare into the beam, do not view directly with optical instruments, and avoid direct exposure to the beam.

Statement 4

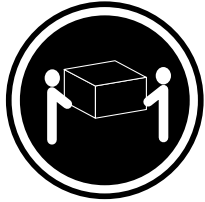

≥ 18 kg (39.7 lb)

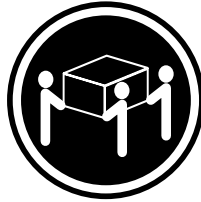

≥ 32 kg (70.5 lb)

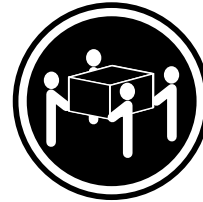

≥ 55 kg (121.2 lb)

CAUTION:
Use safe practices when lifting.

Statement 5



CAUTION:
The power control button on the device and the power switch on the power supply do not turn off the electrical current supplied to the device. The device also might have more than one power cord. To remove all electrical current from the device, ensure that all power cords are disconnected from the power source.

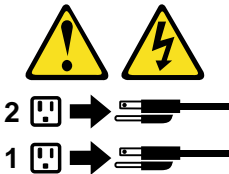

Moving the stabilizing feet

The four feet on the bottom of the server provide additional stability when the feet are placed in the stabilizing position.

If the feet on your system are similar to the feet in the first illustration below, rotate them a quarter-turn inward to move them out of the way, or a quarter-turn outward to provide stability.

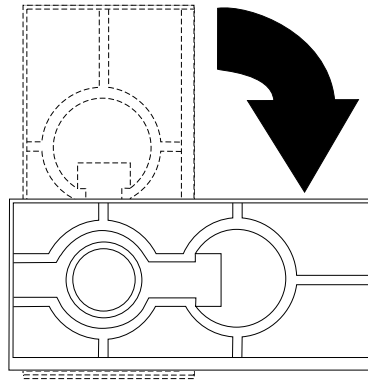

If the feet on your system are similar to the feet in the following illustration, complete the following steps to place the feet in the stabilizing position.

1. Place the server on its side.
2. Locate the release tab inside the foot; then, lift up on the tab.

Note: The following illustration shows the rear feet located on the bottom rear of the server.

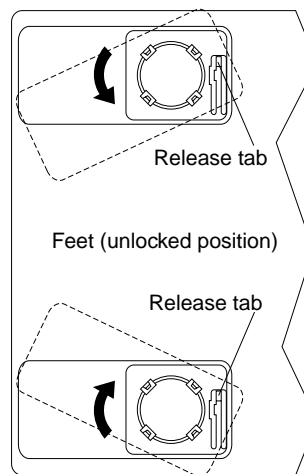

3. Rotate the foot inward to the unlocked position; then, remove the foot from the server.
4. Align the post in the center of the foot with the hole on the bottom of the server and place the foot between the guides as indicated.

Note: The following illustration shows the rear feet located on the bottom rear of the server.

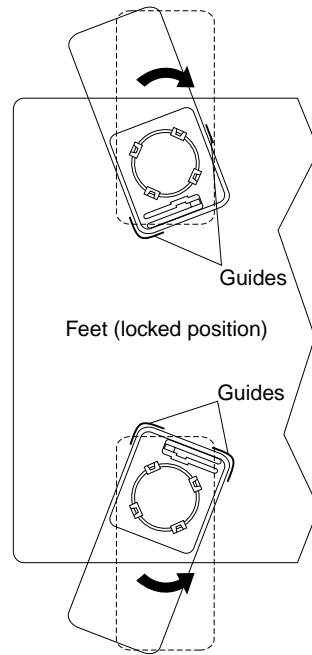

5. Rotate the foot outward until the foot locks into place.
6. Complete steps 2 through 5 for each foot.

Note: When you need to access the inside of the server to install options, you might find it easier to lay the server on its side. If you do so, make sure the feet are in the horizontal position (see the previous steps). Otherwise, the feet might break off the server because of the weight of the server.

Removing the side cover

The following information describes how to remove the side cover.

Note: The illustrations in this document might differ slightly from your hardware.

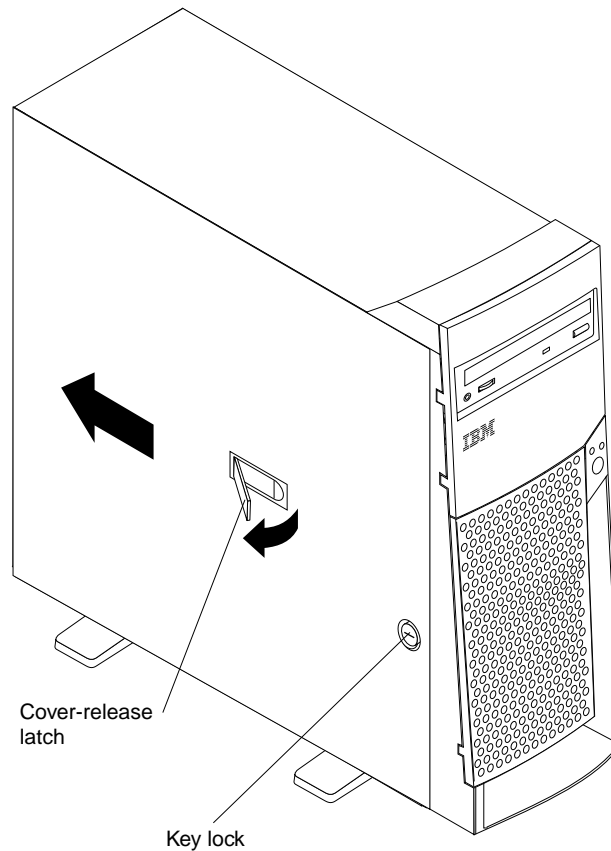

Complete the following steps to remove the side cover of the server.

1. Review the information in “Before you begin” on page 26 and the safety precautions listed in Statement 1 and Statement 5 in “Safety information” on page 28.
2. Turn off the server and peripheral devices and disconnect all external cables and power cords.
3. If necessary, unlock the server cover.
4. Pull out on the cover-release latch, which will slide the cover toward the rear of the server about 12.7 mm (0.5 in.). Then, remove the cover from the server and set it aside.

To replace the side cover, see “Installing the cover” on page 51.

Attention: For proper cooling and airflow, replace the cover before turning on the server. Operating the server with the cover removed might damage server components.

Removing the support-bracket assembly

When working with some options such as hard disk drives, microprocessors, and memory modules, you must first remove the support-bracket assembly to access the location of the option.

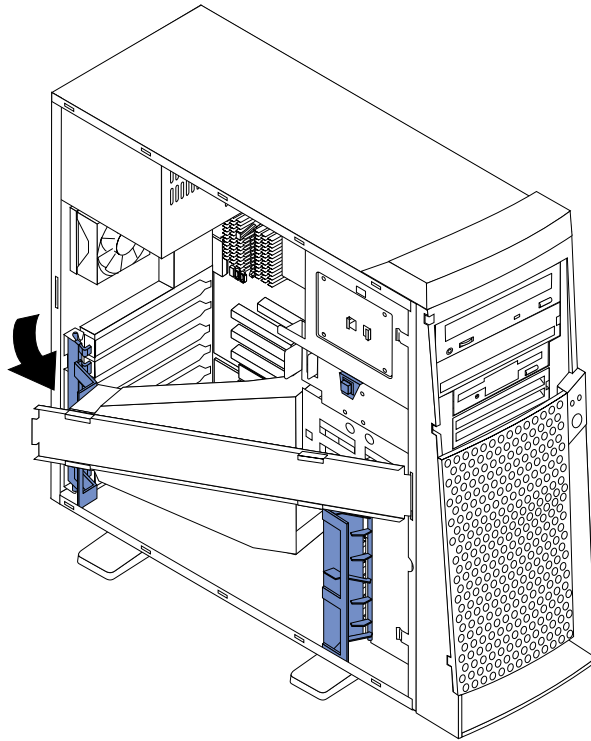

Complete the following steps to remove the support-bracket assembly.

1. Review the information in “Before you begin” on page 26 and the safety precautions listed in Statement 1 and Statement 5 in “Safety information” on page 28.
2. Turn off the server and peripheral devices and disconnect all external cables and power cords; then, remove the side cover. See “Removing the side cover” on page 34 for details.
3. Disconnect the support-bracket assembly fan cable from the connector (SYSFA3) on the system board. For the location of the fan cable connector, see “System board internal cable connectors” on page 24.
4. Locate the end of the support-bracket assembly near the rear of the server. Pull it out approximately 152.4 mm (6 in.).
5. Pull the front end of the support-bracket assembly away from the server and place the assembly aside.

To reinstall the support-bracket assembly, reverse these steps.

Working with adapters

Your server comes with adapter connectors, called *slots*. The AGP video adapter is installed in the AGP slot. You can install up to five PCI adapters in PCI expansion slots 1 through 5. All PCI expansion slots are 32-bit, 33 MHz slots.

Note: The illustrations in this document might differ slightly from your hardware.

The following illustration shows the location of the PCI expansion slots on the system and PCI extender boards.

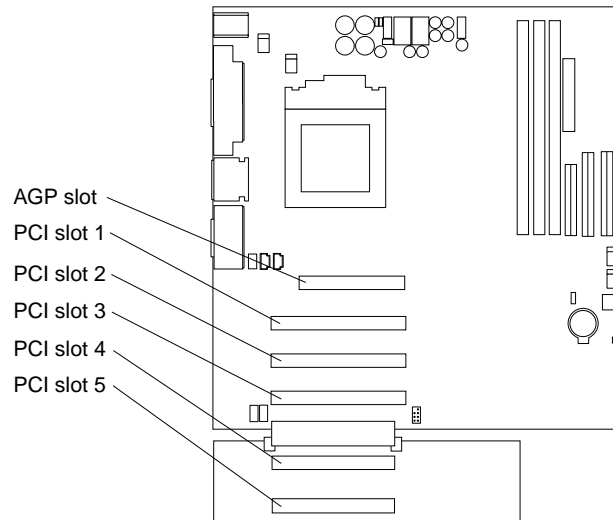

Adapter considerations

Before you install an adapter, review the following:

- Locate the documentation that comes with the adapter and follow those instructions in addition to the instructions given in this chapter. If you need to change switch or jumper settings on your adapter, follow the instructions that come with the adapter.
- You can install full-length adapters in all five PCI expansion slots.
- Your server supports 5.0V and universal PCI adapters; it does not support 3.3V adapters.
- Your server uses a rotational interrupt technique to configure PCI adapters. Because of this technique, you can install a variety of PCI adapters that currently do not support sharing of PCI interrupts.
- If you are installing or replacing an adapter that will control your startup (boot) drive, install the adapter in PCI expansion slot 2.
- PCI expansion slots 1 through 5 are on PCI bus 0.

The system scans the AGP slot and PCI expansion slots 1 through 5 to assign system resources; then, the system starts (boots) the PCI devices in the following order, if you have not changed the default boot sequence: PCI expansion slots 1 through 5; then, the system board integrated drive electronics (IDE) or SCSI devices.

Note: To change the startup sequence for PCI devices, start the Configuration/Setup Utility program, select **Start Options** from the main menu, select **Startup Sequence**; then, select **Second device (SCSI)** to designate the adapter boot sequence. See Chapter 3, “Configuring your server,” on page 9 for details on using the Configuration/Setup Utility program.

- For a list of supported options for your server, refer to <http://www.ibm.com/pc/compat> on the World Wide Web.

Installing an adapter

Refer to the following illustration to install an adapter.

Note: The illustrations in this document might differ slightly from your hardware.

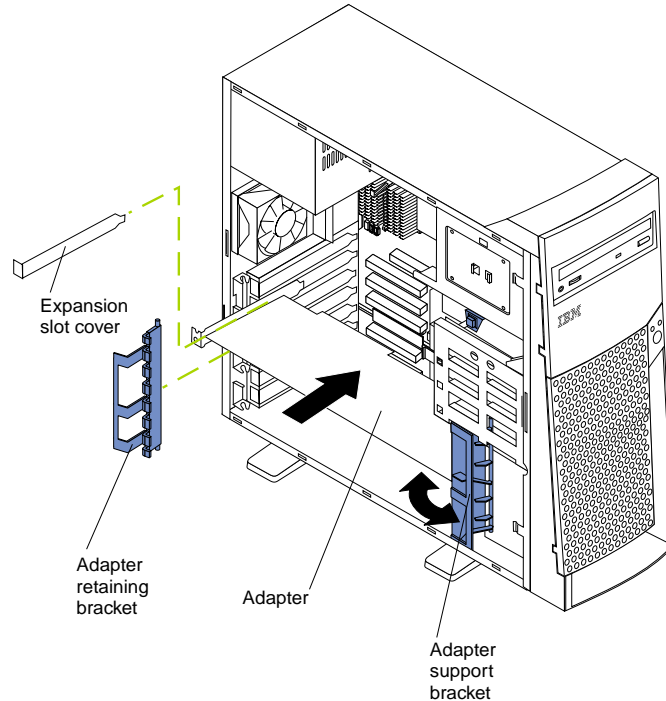

Complete the following steps to install an adapter.

Attention: When you handle static-sensitive devices, take precautions to avoid damage from static electricity. For details on handling these devices, see “Handling static-sensitive devices” on page 27.

1. Review the safety precautions listed in Statement 1 and Statement 5 in “Safety information” on page 28.
2. Turn off the server and peripheral devices and disconnect all external cables and power cords; then, remove the side cover. For more information about removing the side cover, see “Removing the side cover” on page 34.
3. Determine which PCI expansion slot you will use for the adapter.

Note: If you are installing or replacing an adapter that will control your startup (boot) drive, install the adapter in PCI expansion slot 2.
4. If you are installing a full-length adapter, rotate the front adapter support bracket to the open (unlocked) position.
5. Rotate the rear adapter retaining bracket to the open (unlocked) position, and then remove it from the server.
6. Remove the PCI expansion-slot cover. From the rear of the server, press in on the slot cover. Grasp it and pull it out of the slot. Store it in a safe place for future use.

Attention: PCI expansion-slot covers must be installed on all vacant slots. This maintains the electronic emissions characteristics of the server and ensures proper cooling of server components.

7. Touch the static-protective package containing the adapter to any unpainted metal surface on the server. Then, remove the adapter from the static-protective package. Avoid touching the components and gold-edge connectors on the adapter.
8. Place the adapter, component-side up, on a flat, static-protective surface.
9. Set any jumpers or switches as described by the adapter manufacturer.
10. To install the adapter, carefully grasp the adapter by its top edge or upper corners, and align it with the expansion slot guides; then, press the adapter *firmly* into the PCI expansion slot.

Attention: When you install an adapter in the server, be sure that it is completely and correctly seated in the PCI expansion slot before you turn on the server. Incomplete insertion might cause damage to the system board or the adapter.

11. Connect required cables to the adapter.

Attention: Route cables so that they do not block the flow of air from the fans.

12. If you have another adapter to install, do so now.
13. If you have installed a full-length adapter, rotate the front adapter support bracket to the closed (locked) position.
14. Reinstall the rear adapter retaining bracket; then, rotate the bracket to the closed (locked) position.
15. If you have other options to install, do so now.
16. Reinstall the side cover (see “Installing the cover” on page 51 for details).
17. Reconnect the external cables and power cords; then, turn on the peripheral devices and the server.

Installing a SCSI or ServeRAID adapter

Complete the following steps to install a SCSI or ServeRAID adapter.

1. If you have not already installed the SCSI adapter, complete steps 1 through 10 of “Installing an adapter” on page 37. Then, return here to complete the installation.

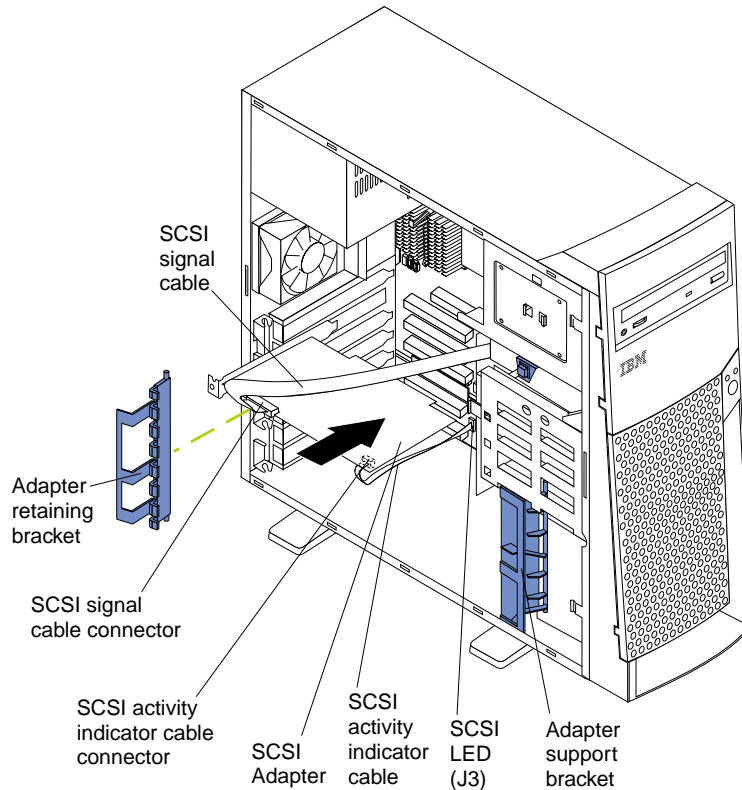

2. Connect one end of the SCSI signal cable (purchased separately) to the adapter; then, connect one or more of the signal cable connectors to the rear of the SCSI devices.
3. Connect the SCSI activity indicator cable (purchased separately) to the adapter and to the SCSI LED connector (J3) on the system board. See “System board internal cable connectors” on page 24 for the location of this connector.
Note: If you are installing or replacing an adapter that will control your startup (boot) drive, install the adapter in PCI expansion slot 2.
4. If you have another adapter to install or remove, do so now.
5. If you have installed a full-length adapter, rotate the front adapter support bracket to the closed (locked) position.
6. Reinstall the rear adapter retaining bracket; then, rotate the bracket to the closed (locked) position.
7. If you have other options to install, do so now.
8. Reinstall the side cover. See “Installing the cover” on page 51 for details.
9. Reconnect the external cables and power cords; then, turn on the peripheral devices and the server.

Installing internal drives

Depending on your server model, you might have one or more of the following drives installed:

- Diskette
- Hard disk
- CD-ROM

Internal drive bays

Your server comes with an IDE CD-ROM drive installed in bay 1, a 3.5-in., 1.44 MB diskette drive installed in bay 3. Some server models have a hard disk drive installed in bay 5.

Note: The illustrations in this document might differ slightly from your hardware.

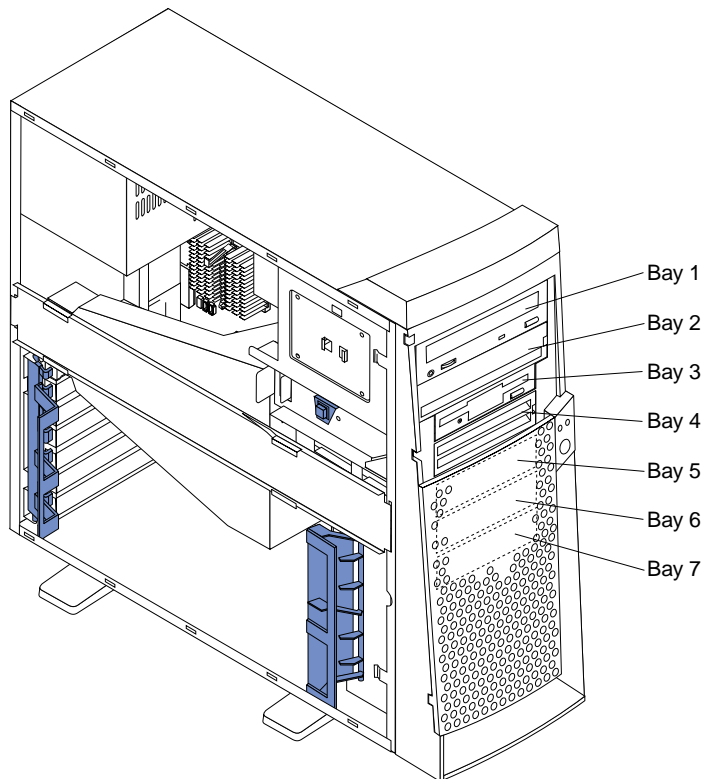

Drive considerations:

- Diskette drives, tape drives, and CD-ROM drives are removable-media drives. You can install removable-media drives in bays 1, 2, 3, and 4.
- You can install a 3.5-in., slim-high or a 5.25-in., half-high, removable-media drive, such as a tape backup drive, in bay 2.
- You can install only a 3.5-in., slim-high, removable-media drive in bay 4.
- The server supports only one diskette drive, which uses 1 MB and 2 MB diskettes.
- Before you install a 3.5-in. drive in a 5.25-in. bay, you must attach the 5.25 in. conversion kit, supplied with your option, to the 3.5-in. drive. Refer to the documentation that comes with the option for the conversion kit installation instructions.

Note: Only 3.5-in. options that ship with proper mounting hardware can be supported in the 5.25-in. bays.

- If you have a tape backup drive in your server, use a dry process cleaning cartridge to clean the tape head two hours after you first use a new data cartridge. Then, clean the tape head once a month, or after each eight hours of continuous read/write operations, whichever occurs first. For complete details about the tape backup drive, refer to the documentation that comes with your server or your backup option.
- The electromagnetic interference (EMI) integrity and cooling of the server are both protected by having bays 1 through 4 covered or occupied. When you install a drive, save the EMC shield and filler panel from the bay, in case you later remove the drive and do not replace it with another.
- For a list of supported options for your server, refer to <http://www.ibm.com/pc/compat> on the World Wide Web.

Preinstallation steps (all bays)

Before you install drives in your server, verify that you have all the cables and other equipment specified in the documentation that comes with the drive. You might also need to perform certain preinstallation activities. Some of the steps are required only during the initial installation of an option.

1. Read “Safety information” on page 28, “Handling static-sensitive devices” on page 27, and the documentation that comes with your drive.
2. Choose the bay in which you want to install the drive.

Note: You can only install a 3.5-in. device in bay 4.
3. Check the instructions that come with the drive to see if you need to set any switches or jumpers on the drive. If you are installing a SCSI device, be sure to set the SCSI ID for that device.

Installing a drive in bay 2 or 4

Complete the following steps to install a drive in bay 2 or 4.

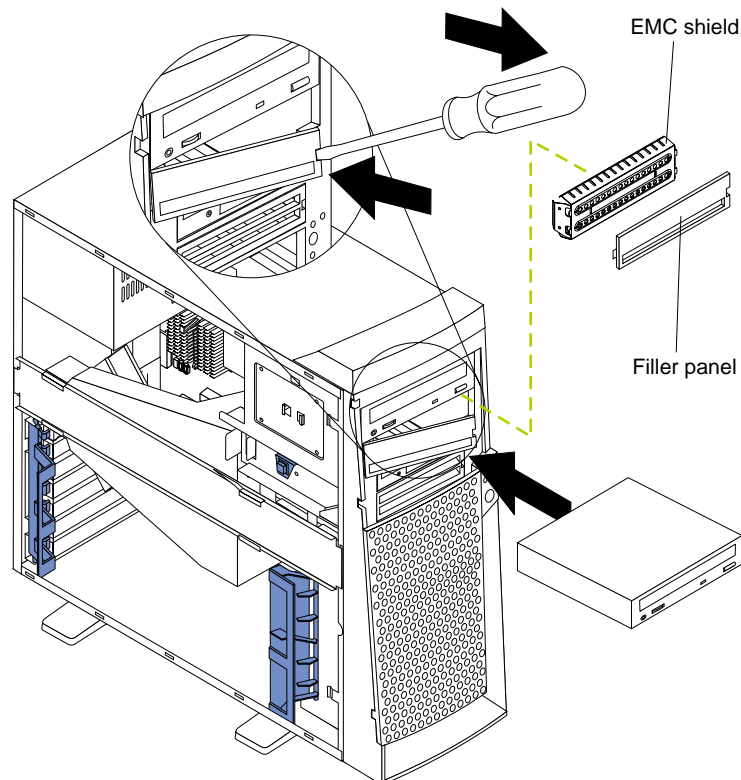

Attention: When you handle static-sensitive devices, take precautions to avoid damage from static electricity. For details on handling these devices, see “Handling static-sensitive devices” on page 27.

1. Read the information in “Preinstallation steps (all bays)” on page 41 and “Safety information” on page 28.
2. Turn off the server and peripheral devices and disconnect the external cables and power cords; then, remove the side cover (see “Removing the side cover” on page 34 for details).
3. Remove the support-bracket assembly and disconnect the fan cable from the connector (SYSFA3) on the system board. See “Removing the support-bracket assembly” on page 35 for details. See “System board internal cable connectors” on page 24 for the location of the fan cable connector.
4. Use a screwdriver to gently pry the filler panel and EMC shield away from the server.

Note: If you are installing a drive that is a laser product, observe the following safety precaution.

Statement 3



CAUTION:

When laser products (such as CD-ROMs, DVD drives, fiber optic devices, or transmitters) are installed, note the following:

- Do not remove the covers. Removing the covers of the laser product could result in exposure to hazardous laser radiation. There are no serviceable parts inside the device.
- Use of controls or adjustments or performance of procedures other than those specified herein might result in hazardous radiation exposure.



Danger

Some laser products contain an embedded Class 3A or Class 3B laser diode. Note the following. Laser radiation when open. Do not stare into the beam, do not view directly with optical instruments, and avoid direct exposure to the beam.

5. Touch the static-protective package containing the drive to any unpainted metal surface on the server; then, remove the drive from the package and place it on a static-protective surface.
6. Set any jumpers or switches on the drive according to the documentation that comes with the drive.
7. Install the drive:
 - If you are installing a 5.25-in. drive in bay 2, push the drive into the bay. Then, use the two screws that come with your option to attach the drive to the drive cage.
 - If you are installing a 3.5-in. drive in bay 2, you must attach the 5.25-in. conversion kit, supplied with your option, to the 3.5-in. drive.
8. Cable the drive:

- If the drive is an IDE device, plug one connector of the IDE signal cable into the back of the drive and the other end of the cable into the IDE connector (IDE1) on the system board. For the location of the IDE connectors, see “System board internal cable connectors” on page 24.
 - If the drive is a SCSI device, your server must have a SCSI adapter installed. Plug one connector of the SCSI signal cable into the back of the drive and the other end of the cable into the connector on the SCSI adapter. See “Installing an adapter” on page 37.
- Note:** Make sure to route the signal cable so that it does not block the air flow to the rear of the drives or over the microprocessor.
9. If you have another drive to install or remove, do so now.
 10. Plug one of the power cables from the power supply into the back of the drive. The connectors are keyed and can be inserted only one way.
 11. Replace the support-bracket assembly and reconnect the fan cable to the connector (SYSFA3) on the system board. See, “Removing the support-bracket assembly” on page 35 for details. See “System board internal cable connectors” on page 24 for the location of the fan cable connector.
 12. If you have other options to install, do so now.
 13. Reinstall the side cover. See “Installing the cover” on page 51 for details.
 14. Reconnect the external cables and power cords; then, turn on the peripheral devices and the server.

Installing a hard disk drive in bay 5, 6, or 7

Complete the following steps to install a hard disk drive in bay 5, 6, or 7.

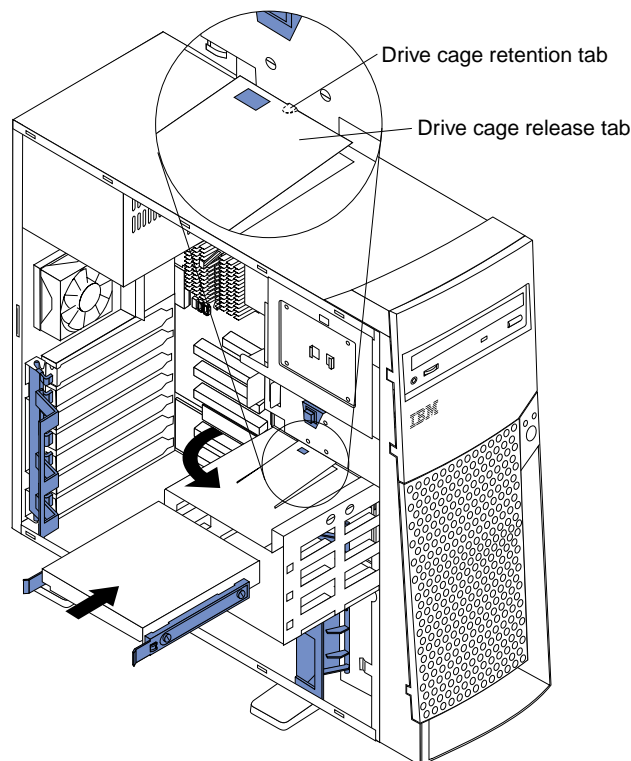

Attention: When you handle static-sensitive devices, take precautions to avoid damage from static electricity. For details on handling these devices, see “Handling static-sensitive devices” on page 27.

1. Read the information in “Preinstallation steps (all bays)” on page 41 and “Safety information” on page 28.
2. Turn off the server and peripheral devices and disconnect all external cables and power cords; then, remove the cover (see “Removing the side cover” on page 34 for details).
3. Remove the support-bracket assembly and disconnect the fan cable from the connector (SYSFA3) on the system board. See “Removing the support-bracket assembly” on page 35 for details. See “System board internal cable connectors” on page 24 for the location of the fan cable connector.
4. Access the drive cage.
 - a. If your server has hard disk drives installed in the drive cage, disconnect the power and signal cables from the rear of the drives.
 - b. Rotate the drive cage out of the server until it locks into place over the drive cage retention tab.

Note: Before you install a hard disk drive, ensure that the drive cage locks into place over the drive cage retention tab by pressing on the side of the drive cage.
5. Touch the static-protective package containing the drive to any unpainted metal surface on the server; then, remove the drive from the package and place it on a static-protective surface.
6. Set any jumpers or switches on the drive according to the documentation that comes with the drive.
7. Attach the blue plastic guide rails to the sides of the drive using the screws and guide rails provided in the drive cage.
8. Slide the drive into the drive cage until the plastic tabs on the guide rails lock into place in the drive cage.
9. Lift the drive cage up and press in on the drive cage release tab; then, rotate the drive cage back into the server.

Note: Clear any cables that might impede the replacement of the drive cage.
10. Connect the power and signal cables to the rear of each drive.

Note: Make sure to route the signal cable so that it does not block the air flow to the rear of the drives or over the microprocessor.
11. If you have other options to install or remove, do so now.
12. Replace the support-bracket assembly and reconnect the fan cable to the connector (SYSFA3) on the system board. See “Removing the support-bracket assembly” on page 35 for details. See “System board internal cable connectors” on page 24 for the location of the fan cable connector.
13. Reinstall the side cover. See “Installing the cover” on page 51 for details.
14. Reconnect the external cables and power cords; then, turn on the peripheral devices and the server.

Installing memory modules

Adding memory to your server is an easy way to make programs run faster. You can increase the amount of memory in your server by installing options called memory modules. Your server uses a noninterleaved memory configuration.

Memory considerations:

- Your server comes with a DIMM installed on the system board in DIMM connector 1. When installing additional memory modules, install the second memory module in DIMM connector 2, and the third in DIMM connector 3. (See the illustration in this section for memory connector locations.)
- Your server supports 128 MB, 256 MB, and 512 MB DIMMs. Your server supports a minimum of 128 MB and a maximum of 1.5 GB of system memory. See the ServerProven list at <http://www.ibm.com/pc/compat> for a list of memory modules for use with your server.
- Installing or removing DIMMs changes the configuration information in the server. Therefore, after installing or removing a DIMM, you must change and save the new configuration information by using the Configuration/Setup Utility program. When you restart the server, the system displays a message indicating that the memory configuration has changed. Start the Configuration/Setup Utility program and select **Save Settings**. See Chapter 3, “Configuring your server,” on page 9 for more information.
- The illustrations in this document might differ slightly from your hardware.

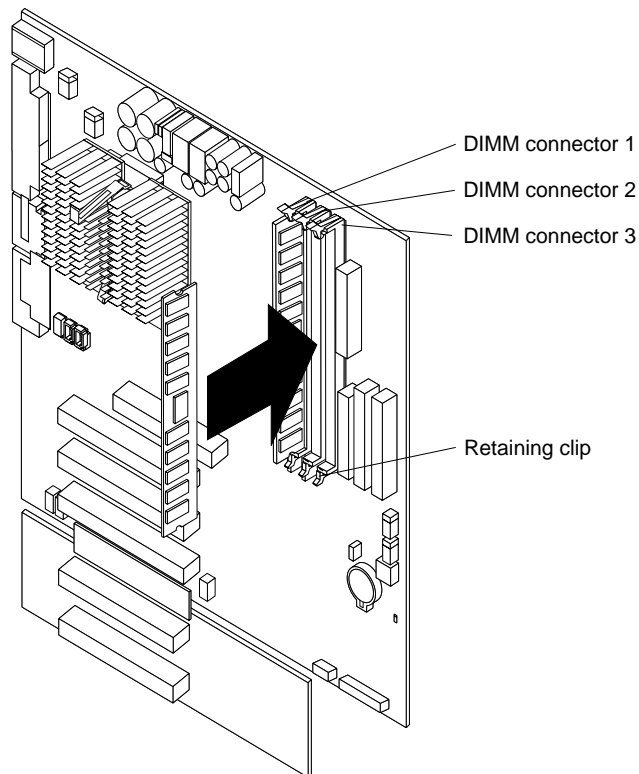

Complete the following steps to install a DIMM.

Attention: When you handle static-sensitive devices, take precautions to avoid damage from static electricity. For details on handling these devices, see “Handling static-sensitive devices” on page 27.

1. Review the safety precautions in Statement 1 and Statement 5 in “Safety information” on page 28.
2. Turn off the server and peripheral devices and disconnect all external cables and power cords; then, remove the cover (see “Removing the side cover” on page 34 for details).
3. Remove the support-bracket assembly and disconnect the fan cable from the connector (SYSFA3) on the system board. See “Removing the support-bracket assembly” on page 35 for details. See “System board internal cable connectors” on page 24 for the location of the fan cable connector.
4. Install the DIMM:
 - a. If you are installing a DIMM in connector 1, remove the AGP video adapter.
Remove the AGP video adapter only if you are replacing the DIMM in connector 1. See “System and PCI extender-board option connectors” on page 24 for the location of the AGP slot.
 - b. Open the retaining clip on each end of the DIMM connector.
Attention: To avoid breaking the retaining clips or damaging the DIMM connectors, open and close the clips gently.
 - c. Touch the static-protective package containing the DIMM to any unpainted metal surface on the server. Then, remove the DIMM from the package.
 - d. Turn the DIMM so that the pins align correctly with the connector.
 - e. Insert the DIMM into the connector by aligning the DIMM edges with the slots at each end of the DIMM connector. Firmly press the DIMM straight down into the connector by applying pressure on both ends of the DIMM simultaneously. Be sure that the retaining clips snap into the locked position when the DIMM is firmly seated in the connector.
 - f. If a gap exists between the DIMM and the retaining clips, the DIMM has not been properly installed. In this case, open the retaining clips and remove the DIMM; then, reinsert the DIMM.
 - g. If you removed the AGP video adapter, reinstall it now. See “Installing an adapter” on page 37.
5. If you have other options to install or remove, do so now.
6. Replace the support-bracket assembly and reconnect the fan cable to the connector (SYSFA3) on the system board. See “Removing the support-bracket assembly” on page 35 for details. See “System board internal cable connectors” on page 24 for the location of the fan cable connector.
7. Replace the side cover. See “Installing the cover” on page 51.
8. Reconnect the external cables and power cords; then, turn on the peripheral devices and the server.

If you want to remove a DIMM, reverse these steps.

Removing and installing a microprocessor

Your server supports only one microprocessor, which is installed on the system board in the microprocessor connector (U11).

Notes:

1. Before you install a new microprocessor, review the documentation that comes with the microprocessor to determine whether you need to update the server BIOS code. The latest level of the BIOS code for your server is available through the World Wide Web. Refer to “Getting information, help, and service” on page 91 for the appropriate World Wide Web addresses.
2. For a list of supported operating systems, see <http://www.ibm.com/pc/compat> on the World Wide Web.

Note: The illustrations in this document might differ slightly from your hardware.

Removing a microprocessor

Your comes with a heat sink or a fan sink installed on the microprocessor, depending on your server model.

Note: The following illustration shows a heat sink installed on the microprocessor.

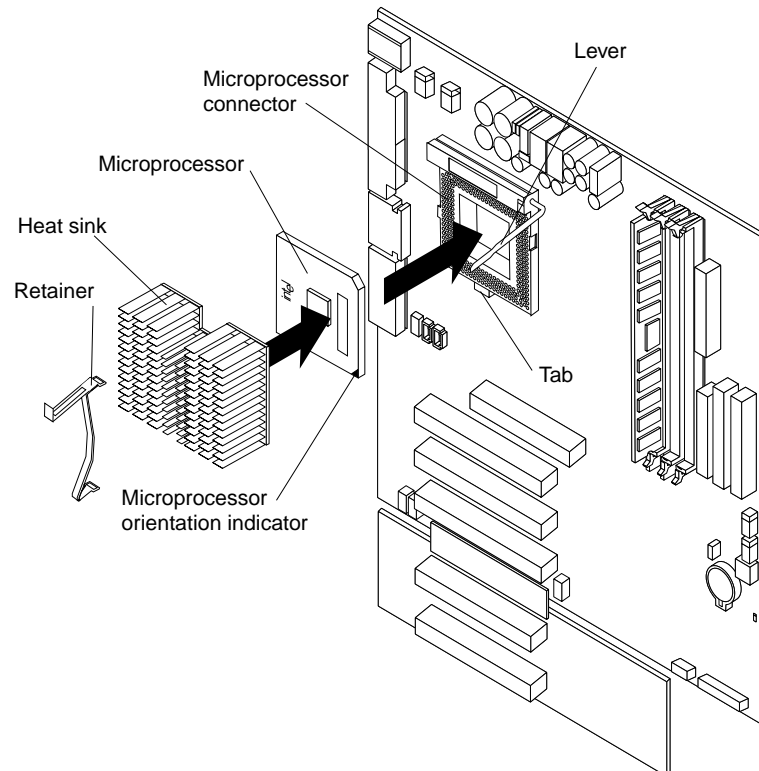

Note: This illustration shows the fan sink installed on the microprocessor.

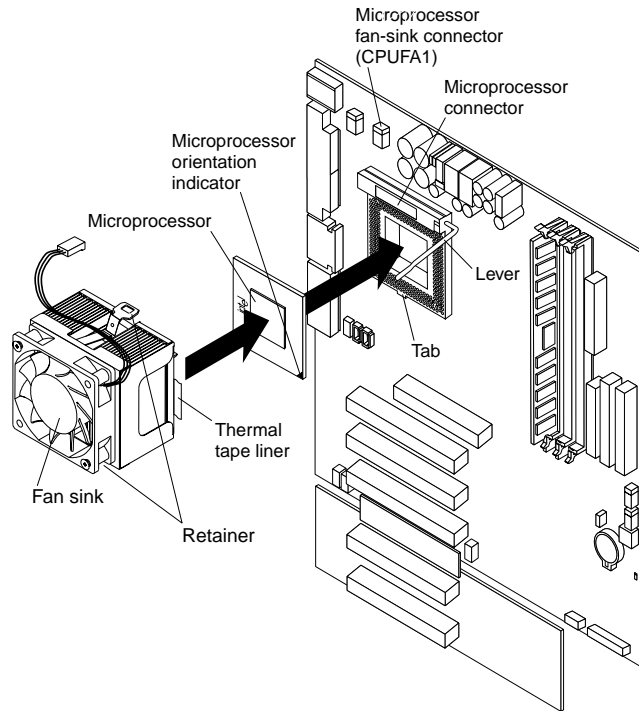

Complete the following steps to remove a microprocessor.

Attention: When you handle static-sensitive devices, take precautions to avoid damage from static electricity. For details on handling these devices, see “Handling static-sensitive devices” on page 27.

1. Review the safety precautions listed in Statement 1 and Statement 5 in “Safety information” on page 28.
2. Turn off the server and peripheral devices and disconnect all external cables and power cords; then, remove the cover (see “Removing the side cover” on page 34 for details).
3. Remove the support-bracket assembly and disconnect the fan cable from the connector (SYSFA3) on the system board. See “Removing the support-bracket assembly” on page 35 for details. See “System board internal cable connectors” on page 24 for the location of the fan cable connector.
4. Push down and back on the retainer to remove it from the heat sink or the fan sink.

Note: Allow sufficient time for a heat sink to cool, before you remove it from the microprocessor.

5. If you are removing a fan sink from the microprocessor, disconnect the fan-sink power cable from the microprocessor fan-sink connector located on the system board. See “System board internal cable connectors” on page 24 for the location.
6. Firmly grasp the heat sink or fan sink and lift it off the microprocessor.
7. Pull out and lift up the release lever and remove the microprocessor from the connector. Store the microprocessor in a static-protective package for possible future use.
8. To install a new microprocessor, continue with step 4 in “Installing a microprocessor” on page 49.

Installing a microprocessor

Complete the following steps to install a microprocessor.

Attention: When you handle static-sensitive devices, take precautions to avoid damage from static electricity. For details on handling these devices, see “Handling static-sensitive devices” on page 27.

1. Review the safety precautions listed in Statement 1 and Statement 5 in “Safety information” on page 28.
2. Turn off the server and peripheral devices and disconnect all external cables and power cords; then, remove the cover (see “Removing the side cover” on page 34 for details).
3. Remove the support-bracket assembly and disconnect the fan cable from the connector (SYSFA3) on the system board. See “Removing the support-bracket assembly” on page 35 and “System board internal cable connectors” on page 24 for instructions.
4. Install the microprocessor:
 - a. Touch the static-protective package containing the new microprocessor to any unpainted metal surface on the server; then, remove the microprocessor from the package.
 - b. Pull out and lift up on the microprocessor-release lever to unlock the microprocessor connector.
 - c. Arrange the microprocessor over the microprocessor connector as shown in the following illustration. Carefully press the microprocessor into the connector.

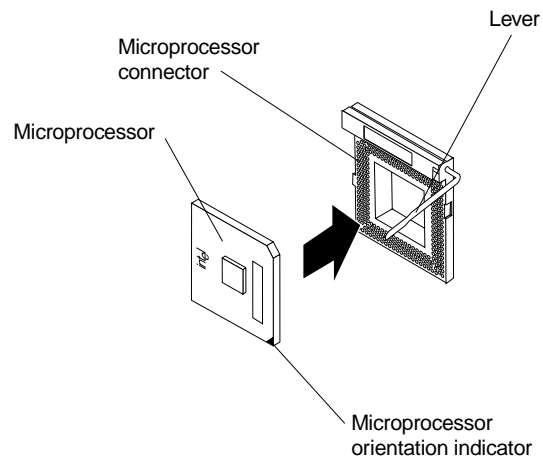

Attention: Do not use excessive force when pressing the microprocessor into the connector.

5. Push the microprocessor-release lever down to lock the microprocessor into the connector.
6. Install the new heat or fan sink that comes with the microprocessor option.
 - a. Peel the plastic protective strip off the bottom of the heat or the fan sink. Make sure the square of thermal material is still on the bottom of the heat sink or fan sink; if not, replace it with a new heat sink or fan sink.
 - b. Align and place the heat sink or the fan sink on top of the microprocessor.
 - c. Locate the tab on the front of the microprocessor socket (the side facing the PCI slots). Then, press down and latch the retainer onto the tab.

- d. Locate the tab on the rear of the microprocessor socket (the side facing the power supply). Then, press down and latch the retainer onto the tab.
 - e. If you have installed a fan sink, connect the fan-sink power cable to the microprocessor fan-sink connector (CPUFA1) on the system board. See “System board internal cable connectors” on page 24 for the location of the microprocessor fan-sink connector.
Note: Make sure the cable is not in a position to interfere with the fan sink operation.
7. If you have other options to install or remove, do so now.
 8. Replace the support-bracket assembly and reconnect the fan cable to the connector (SYSFA3) on the system board. See “Removing the support-bracket assembly” on page 35 for details. See “System board internal cable connectors” on page 24 for the location of the fan cable connector.
 9. Reinstall the side cover. See “Installing the cover” on page 51.
 10. Reconnect the external cables and power cords; then, turn on the peripheral devices and the server.

Installing a security U-bolt

To help prevent hardware theft, you can add a security U-bolt and cable to your server. After you add the security cable, make sure that it does not interfere with other cables that are connected to the server.

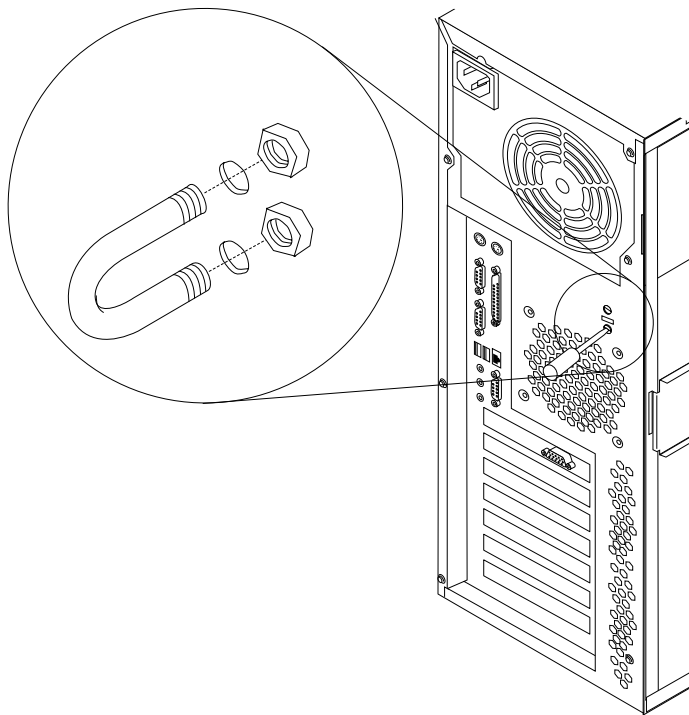

Before you begin:

- Obtain the following items:
 - A flat-blade screwdriver
 - An adjustable wrench

- A 19 mm (0.75 in.) U-bolt or wire rope (similar to National Manufacturing No. 3230, Stock No. 176-735)
- Threaded nuts that fit the U-bolt
- A security cable
- A lock, such as a combination lock or padlock
- Read “Safety information” on page 28 and “Handling static-sensitive devices” on page 27.

Complete the following steps to install a U-bolt.

1. Turn off the server and peripheral devices and disconnect all external cables and power cords; then, remove the cover (see “Removing the side cover” on page 34 for details).
2. Use a screwdriver to remove the two metal knockouts.
3. Insert the U-bolt through the rear panel; then, attach and tighten the nuts.
4. If you have other options to install or remove, do so now.
5. Reinstall the side cover. See “Installing the cover” for details.
6. Thread the cable through the U-bolt and around an object that is a part of or permanently secured to the building structure or foundation, and from which it cannot be removed; then, fasten the cable ends together with a lock.
7. Reconnect the external cables and power cords; then, turn on the peripheral devices and the server.

Installing the cover

The following information describes the cover installation procedure.

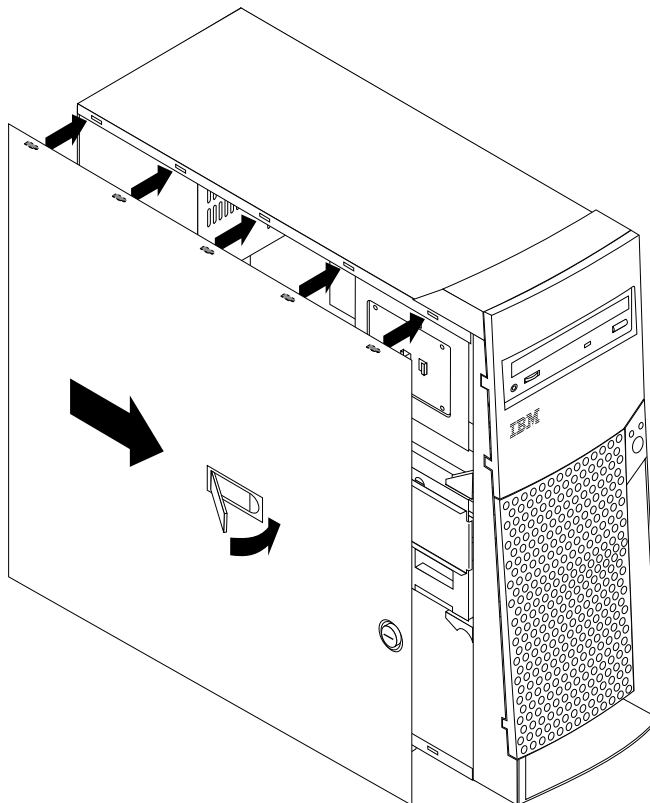

Notes:

1. The illustrations in this document might differ slightly from your hardware.
2. If you removed the support-bracket assembly after you removed the cover, reinstall it before you install the cover. See “Removing the support-bracket assembly” on page 35 for details.

Complete the following steps to install the server cover.

1. Clear any cables that might impede the reinstallation of the cover.
2. Install the side cover:

Note: The cover-release latch must be in the unlocked (opened) position before reinstalling the cover on the server.

- a. Insert the tabs located inside the cover into the slots located on the server chassis.
- b. Close the cover-release latch to secure the cover in place.

Note: Make sure each tab on the cover is in its corresponding slot before closing the cover-release latch.

3. Lock the cover.
4. If you have not done so already, make sure the stabilizing feet are in the stabilizing position so that they properly support the server. See “Moving the stabilizing feet” on page 32 for details.
5. Connect the external cables and power cords; then, turn on the peripheral devices and the server.

Connecting external options

If you install a SCSI adapter in your server, you can attach a SCSI storage expansion enclosure.

To attach an external device:

1. Read “Before you begin” on page 26 and the documentation that comes with your options.
2. Be sure your server and all peripheral devices are turned off.
3. Follow the instructions that come with the option to prepare it for installation and to connect it to the server.

Note: If you are attaching a SCSI device, see “Ultra160 SCSI connector (some models)” on page 63 for SCSI ID and cabling information.

I/O connector locations

The following illustration shows the input/output connectors and the expansion slots on the rear of the server. For pin assignments and other details about these connectors, see “Input/output connectors” on page 53.

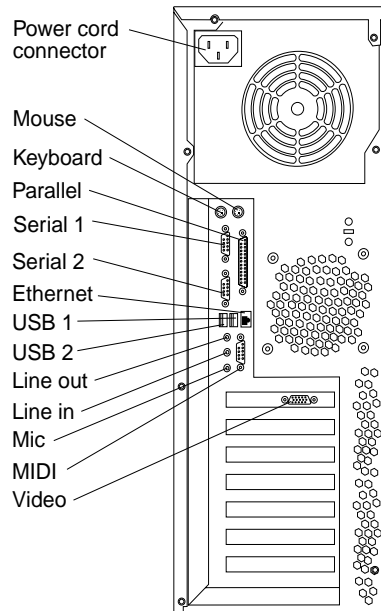

If your server cables and connector panel have color-coded connectors, match the color of the cable end with the color of the connector. For example, match a blue cable end with a blue panel connector, a red cable end with a red panel connector, and so on.

Note: If the server is a SCSI model, the SCSI adapter will be located in PCI slot 2; the external connector will be located in a slot below the video connector. See “System and PCI extender-board option connectors” on page 24 for the location of the PCI slots.

Input/output connectors

This section provides information about the following I/O connectors on your server:

- One mouse
- One keyboard
- One parallel
- Two serial
- One Ethernet
- Two USB
- Line out
- Line in
- Mic
- MIDI
- One video
- One Ultra160 SCSI (some models)

Mouse connector

The system board has one mouse connector that supports a mouse or other pointing device. The mouse connector is located on the rear of your server. See “I/O connector

locations” on page 52 for its location. The following table shows the pin-number assignments for the mouse connector.

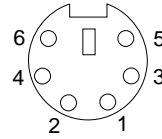

Table 2. Mouse connector pin-number assignments .

| Pin | Signal |
|-----|---------------|
| 1 | Data |
| 2 | Not connected |
| 3 | Ground |
| 4 | +5 V dc |
| 5 | Clock |
| 6 | Not connected |

Keyboard connector

There is one keyboard connector on the rear of your server. See “I/O connector locations” on page 52 for its location.

Note: If you attach a standard (non-USB) keyboard to the keyboard connector, the USB connectors and devices will be disabled during the power-on self-test.

The following table shows the pin-number assignments for the keyboard connector.

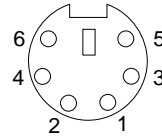

Table 3. Keyboard connector pin-number assignments .

| Pin | I/O | Signal |
|-----|-----|----------------|
| 1 | I/O | Data |
| 2 | N/A | Reserved |
| 3 | N/A | Ground |
| 4 | N/A | +5 V dc |
| 5 | I/O | Keyboard clock |
| 6 | N/A | Reserved |

Parallel connector

Your server has one parallel connector. This connector supports three standard Institute of Electrical and Electronics Engineers (IEEE) 1284 modes of operation: standard parallel port (SPP), enhanced parallel port (EPP), and extended capability port (ECP).

Viewing or changing the connector assignments

You can use the built-in Configuration/Setup Utility program to configure the parallel connector as bidirectional that is, so that data can be both read from and written to a device. In bidirectional mode, the server supports the ECP and EPP modes.

Complete the following steps to view or change the parallel-connector assignment:

1. Restart the server and watch the monitor screen.
2. When the message Press F1 for Configuration/Setup appears, press the F1 key.
3. When the Configuration/Setup Utility menu appears, select **Devices & I/O Ports**; then, press Enter.
4. Select the parallel connector; then, use the arrow keys to advance through the settings available.

Note: When you configure the parallel connector as bidirectional, use an IEEE 1284-compliant cable. The cable must not exceed 3 meters (9.8 feet).

5. Press Esc twice to return to the Configuration/Setup main menu; then, select **Save & Exit Setup** to exit from the Configuration/Setup Utility main menu.

Parallel connector

There is a 25-pin, female D-shell parallel connector on the rear of your server. See “I/O connector locations” on page 52 for the location of this connector. The following table shows the pin-number assignments for the parallel connector.

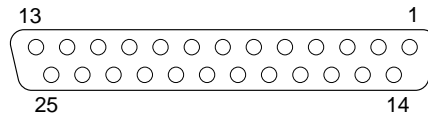

Table 4. Parallel connector pin-number assignments.

| Pin | I/O | SPP/ECP Signal | EPP Signal |
|-----|-----|-----------------|----------------|
| 1 | O | -STROBE | -WRITE |
| 2 | I/O | Data 0 | Data 0 |
| 3 | I/O | Data 1 | Data 1 |
| 4 | I/O | Data 2 | Data 2 |
| 5 | I/O | Data 3 | Data 3 |
| 6 | I/O | Data 4 | Data 4 |
| 7 | I/O | Data 5 | Data 5 |
| 8 | I/O | Data 6 | Data 6 |
| 9 | I/O | Data 7 | Data 7 |
| 10 | I | -ACK | -ACK |
| 11 | I | BUSY | -WAIT |
| 12 | I | PE (paper end) | PE (paper end) |
| 13 | I | SLCT (select) | SLCT (select) |
| 14 | O | -AUTO FD (feed) | -AUTO FD |
| 15 | I | -ERROR | -ERROR |
| 16 | O | -INIT | -INIT |

Table 4. Parallel connector pin-number assignments.

| Pin | I/O | SPP/ECP Signal | EPP Signal |
|-----|-----|----------------|------------|
| 17 | O | -SLCT IN | -SLCT IN |
| 18 | - | Ground | Ground |
| 19 | - | Ground | Ground |
| 20 | - | Ground | Ground |
| 21 | - | Ground | Ground |
| 22 | - | Ground | Ground |
| 23 | - | Ground | Ground |
| 24 | - | Ground | Ground |
| 25 | - | Ground | Ground |

Serial connectors

Your server has two standard serial connectors located on the rear of the server.

Some application programs require specific connectors, and some modems function properly only at certain communication connector addresses. You might need to use the Configuration/Setup Utility program to change communication connector address assignments to prevent or resolve address conflicts.

Viewing or changing the serial-connector assignments

Complete the following steps to view or change the serial-connector assignments.

1. Restart the server and watch the monitor screen.
2. When the message Press F1 for Configuration/Setup appears, press the F1 key.
3. When the Configuration/Setup Utility menu appears, select **Devices & I/O Ports**; then, press Enter.
4. Select the serial connector; then, use the arrow keys to advance through the available settings.
5. Press Esc twice to return to the Configuration/Setup Utility main menu; then, select **Save & Exit Setup** to exit from the Configuration/Setup Utility main menu.

Serial connectors

There are two 9-pin, male D-shell serial connectors on the rear of your server. See "I/O connector locations" on page 52 for the location of these connectors. The following table shows the pin-number assignments for the serial connectors.

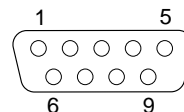

Table 5. Serial connector pin-number assignments.

| Pin | Signal | Pin | Signal |
|-----|---------------------|-----|-----------------|
| 1 | Data carrier detect | 6 | Data set ready |
| 2 | Receive data | 7 | Request to send |
| 3 | Transmit data | 8 | Clear to send |

Table 5. Serial connector pin-number assignments.

| Pin | Signal | Pin | Signal |
|-----|---------------------|-----|----------------|
| 4 | Data terminal ready | 9 | Ring indicator |
| 5 | Signal ground | | |

Ethernet connector

Your server comes with an integrated Ethernet controller. This controller provides an interface for connecting to 10-Mbps or 100-Mbps networks and provides full-duplex capability, which enables simultaneous transmission and reception of data on the Ethernet LAN.

To access the Ethernet connector, connect a Category 3, 4, or 5 unshielded twisted-pair (UTP) cable to the Ethernet (RJ-45) connector on the rear of your server. See “I/O connector locations” on page 52.

Note: The 100BASE-TX Fast Ethernet standard requires that the cabling in the network be Category 5.

Configuring the Ethernet controller

When you connect your server to the network, the Ethernet controller automatically detects the data-transfer rate (10Mbps or 100Mbps) on the network and then sets the controller to operate at the appropriate rate. In addition, if the Ethernet connector that your server is connected to supports auto-negotiation, the Ethernet controller will set the appropriate duplex state. That is, the Ethernet controller will adjust to the network data rate, whether the data rate is standard Ethernet (10BASE-T), Fast Ethernet (100BASE-TX), half duplex (HDX), or full duplex (FDX). The controller supports HDX and FDX modes at both speeds.

The Ethernet controller is integrated on the system board. You do not need to set any jumpers or configure the controller for your operating system before you use the Ethernet controller. However, you must install a device driver to enable your operating system to address the Ethernet controller. The device drivers are provided on the *ServerGuide* CDs.

High performance Ethernet modes

Your Ethernet controller supports optional modes, such as teaming, priority packets, and virtual LANs, which provide higher performance and throughput for your server.

Teaming mode: Your Ethernet controller provides options, called *teaming options*. These options increase throughput and fault tolerance when running with Windows NT 4.0 or NetWare 4.1x or later.

- **Adapter Fault Tolerance (AFT)** provides automatic redundancy for your adapter. If the primary adapter fails, the secondary adapter takes over. Adapter fault tolerance supports from two to four adapters per team.
- **Adaptive Load Balancing (ALB)** enables you to balance the transmission data flow among two to four adapters. ALB also includes the AFT option. You can use ALB with any 100BASE-TX switch.
- **Cisco Fast EtherChannel (FEC)** creates a team of two to four adapters to increase transmission and reception throughput. FEC also includes the AFT option. You can use FEC only with a switch that has FEC capability.

Teaming requires you to install at least one additional Ethernet adapter. For additional information about the teaming modes, refer to the documentation that comes with these additional adapters.

Priority Packet mode: Priority Packet is a traffic-prioritization utility that enables you to set up filters to process high-priority traffic before normal traffic. You can send information from critical nodes or applications with an indicated priority. Because you set this priority at the host or entry point of the network, the network devices can base forwarding decisions on priority information defined in the packet.

Priority Packet information is available on the IBM Networking Web site at <http://www.ibm.com/networking/support>.

Priority Packet prioritizes traffic based on priority filters. These are parameters you assign to outgoing (transmit) packets. Using the Priority Filter Wizard, you can set up predefined or custom priority filters based on a node medium access control (MAC) address, Ethernet type, or by various properties of the protocol and connector. Priority Packet provides two different methods for prioritizing traffic: IEEE 802.1p tagging and High Priority Queue.

IEEE 802.1p is an IEEE standard for tagging, or adding additional bytes of information to packets with different priority levels. Packets are tagged with 4 additional bytes, which increase the packet size and indicate a priority level. When you send these packets out on the network, the higher priority packets are transferred first. Priority packet tagging (also known as Traffic Class Expediting) enables the adapter to work with other elements of the network (such as switches and routers) to deliver priority packets first. You can assign specific priority levels from 0 (low) to 7 (high).

You can assign values to packets based on their priority when you use the IEEE 802.1p standard for packet tagging. This method requires a network infrastructure that supports packet tagging. The routing devices receiving and transferring these packets on your network must support 802.1p for tagging to be effective.

After you set up the priority filter in Priority Packet, you must start IBMSet and select **802.1p/802.1Q Tagging** on the Advanced tab.

Note: IEEE 802.1p tagging increases the size of the packets it tags. Some hubs and switches will not recognize the larger packets and will drop them. Check your hub or switch documentation to see if they support 802.1p. (You can configure the switch to strip the tags from the packets and send it on to the next destination as normal traffic.) If these devices do not support 802.1p, or if you are not sure, use high priority queue (HPQ) to prioritize network traffic.

The requirements for effectively using IEEE 802.1p tagging are:

- The other devices receiving and routing 802.1p tagged packets must support 802.1p.
- The adapters on these devices must support 802.1p. The Ethernet controller in your server and all IBM 10/100 Ethernet Security Adapters support 802.1p.
- The adapter cannot be assigned to an adapter team.
- If you are setting up virtual local area networks (VLANs) and packet tagging on the same adapter, 802.1p/802.1Q tagging must be enabled on the IBMSet Advanced tab.

If your network infrastructure devices do not support IEEE 802.1p or you are not sure, you can still define filters and send packets as high priority. While HPQ does not provide the precise priority levels of 802.1p tagging, it does assign traffic as either high or low priority and sends high priority packets first. Therefore, if there are multiple applications on a system sending packets, the packets from the application with a filter are sent out first. HPQ does not change network routing, nor does it add any information to the packets.

To assign HPQ, you can specify it using Priority Packet when you create or assign a filter.

To effectively use HPQ, the adapter cannot be assigned to an adapter team.

Virtual LAN mode: A virtual LAN is a logical grouping of network devices put together as a LAN, regardless of their physical grouping or collision domains. Using VLANs increases network performance and improves network security.

VLANs offer you the ability to group users and devices together into logical workgroups. This can simplify network administration when connecting clients to servers that are geographically dispersed across the building, campus, or enterprise network.

Typically, VLANs are configured at the switch and any server can be a member of one VLAN per installed network adapter. Your Ethernet controller supersedes this by communicating directly with the switch, enabling multiple VLANs on a single network adapter (up to 64 VLANs).

To set up VLAN membership, your Ethernet controller must be attached to a switch that has VLAN capability. You also need to use Windows NT 4.0 or later, or Novell NetWare 4.1x or later.

Notes:

1. Windows NT versions prior to 4.0 do not support VLANs.
2. VLANs require NT 4.0 with Service Pack 3.0 and the network driver interface specification (NDIS) driver hotfix from Microsoft.
3. In Windows NT, VLANs cannot be implemented on controllers that have been configured for teaming options. NetWare can support teaming options and VLANs on the same adapters.

Complete the following steps to join a VLAN from Windows NT 4.0.

1. Create a VLAN on the switch. Use the parameters you assign there to join the VLAN from the server. Refer to your switch documentation for more information.
2. Double-click the **Network** icon in the Control Panel window.
3. On the Adapters tab, select the adapter you want to be on the VLAN and click **Properties**.
4. In IBMSet, click **Join VLAN**. Note that VLANs cannot be assigned to adapters that are already defined to have an adapter teaming option.
5. Type the VLAN ID and VLAN name. The VLAN ID must match the VLAN ID of the switch. The ID range is from 1 to 1000. The VLAN name is for information only and does not need to match the name on the switch.
6. Click **Join VLAN**. Repeat steps 3 through 5 for each VLAN you want the server to join. The VLANs you add are listed on the Adapters tab.
7. Click **Close** and restart the server.

Ethernet connector

There is an RJ-45 Ethernet connector on the back of the server. See "I/O connector locations" on page 52 for the location of this connector. The following table shows the pin-number assignments for the Ethernet connector.

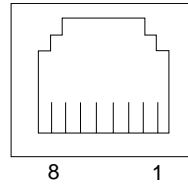

Table 6. Ethernet RJ-45 connector pin-number assignments..

| Pin | Signal | Pin | Signal |
|-----|-----------------|-----|----------------|
| 1 | + Transmit data | 5 | Not connected |
| 2 | - Transmit data | 6 | - Receive data |
| 3 | + Receive data | 7 | Not connected |
| 4 | Not connected | 8 | Not connected |

Universal Serial Bus connectors

Your server has two Universal Serial Bus (USB) connectors, which are configured automatically. USB is a serial interface standard for telephony and multimedia devices. It uses Plug and Play technology to determine the type of device that is attached to the connector.

Notes:

1. If you attach a standard (non-USB) keyboard to the keyboard connector, the USB connectors and devices will be disabled during the power-on self-test.
2. If you install a USB keyboard that has a mouse connector, the USB keyboard emulates a mouse, and you will not be able to disable the mouse settings in the Configuration/Setup Utility program.
3. Some operating systems do not support USB devices. Refer to your operating-system documentation to determine whether your operating system supports USB devices.

USB cables and hubs

You need a 4-pin cable to connect devices to a USB 1 or USB 2. If you plan to attach more than two USB devices, you must use a hub to connect the devices. The hub provides multiple connectors for attaching additional external USB devices.

USB technology transfers data at up to 12 Mbps with a maximum of 127 external devices and a maximum signal distance of five meters (16 ft) per segment.

USB connectors

There are two USB connectors located on the rear of the server for attaching USB-compatible devices. See "I/O connector locations" on page 52 for the location of the USB connectors. The following table shows the pin-number assignments for the USB connectors.

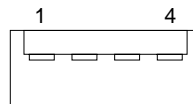
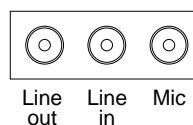

Table 7. USB connector pin-number assignments.

| Pin | Signal |
|-----|--------|
| 1 | +5 V |
| 2 | -Data |
| 3 | +Data |
| 4 | Ground |

Audio connectors

The audio connectors are used to connect external audio equipment to your server. See "I/O connector locations" on page 52 for the location of these connectors.



Line out

This connector is used to send audio signals from the server to external devices, such as powered speakers with built-in amplifiers, headphones, multimedia keyboards, or the audio line-in connector on a stereo system.

Line in

This connector is used to accept audio signals from external devices, such as line output from a stereo, television, or musical instrument into the server sound system.

Mic

This connector is used to connect a microphone to your server when you want to record voice or other sounds on the hard disk drive. It might also be used by speech-recognition software.

MIDI connector

The musical instrument digital interface (MIDI) connector enables your server to interact with musical instruments and other musical equipment. You might use the MIDI connector as an interface between your server and a synthesizer to edit and store sound information for the synthesizer on the server. See “I/O connector locations” on page 52 for the location of the MIDI connector. The following table shows the pin-number assignments for the MIDI connector.

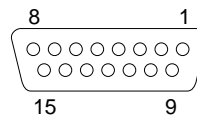

Table 8. MIDI connector pin-number assignments.

| Pin | Signal | Pin | Signal | Pin | Signal |
|-----|---------------------|-----|---------------------|-----|---------------------|
| 1 | +5 V | 6 | Joystick 1 -- Y | 11 | Joystick 2 -- X |
| 2 | Joystick 1 Switch A | 7 | Joystick 1 Switch B | 12 | MIDI - OUT |
| 3 | Joystick 1 -- X | 8 | +5 V | 13 | Joystick 2 -- Y |
| 4 | Switch Common | 9 | +5 V | 14 | Joystick 2 Switch D |
| 5 | Switches Common | 10 | Joystick 2 Switch C | 15 | MIDI - IN |

Video connector

Your server uses an AGP video adapter located in the AGP slot on the system board. There is a 15-pin analog video connector located on the rear of the server. See “I/O connector locations” on page 52 for the location of this connector. The following table shows the pin-number assignments for the video connector.

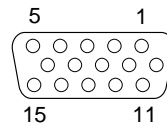

Table 9. Video connector pin-number assignments.

| Pin | Signal | Pin | Signal | Pin | Signal |
|-----|---------------------|-----|--------|-----|---------------|
| 1 | Red | 6 | Ground | 11 | Not connected |
| 2 | Green or monochrome | 7 | Ground | 12 | DDC SDA |

Table 9. Video connector pin-number assignments.

| Pin | Signal | Pin | Signal | Pin | Signal |
|-----|---------------|-----|-------------|-----|------------------------------------|
| 3 | Blue | 8 | Ground | 13 | Horizontal synchronization (Hsync) |
| 4 | Not connected | 9 | +5 V dc DDC | 14 | Vertical synchronization (Vsync) |
| 5 | Ground | 10 | Ground | 15 | DDC SCL |

Ultra160 SCSI connector (some models)

Some server models come with a SCSI adapter, which supports a single Ultra160 SCSI channel in a full-featured PCI 2.1-/2.2-compliant bus master package. This configuration supports a zero wait state, 32-bit memory transfers at 160 MB per second, when low voltage differential (LVD) SCSI peripherals are attached. This channel supports up to 15 SCSI devices. In addition, the SCSI adapter uses:

- Double-transition clocking to achieve high transfer rates
- Domain name validation to negotiate compatible data transfer speeds with each device
- Cyclic-redundancy checking, instead of the usual parity checking, to significantly improve data reliability

Note: If you install a RAID adapter, you can move the SCSI signal cable from the SCSI connector on the SCSI adapter to an internal channel connector on the RAID adapter to control the internal drives from the RAID adapter.

SCSI cabling requirements

You can install five internal SCSI devices using the SCSI signal cable that comes with your server or purchased separately, depending on your server model. If you plan to attach external SCSI devices, you must install an optional SCSI PCI adapter and order additional SCSI cables. To select and order the correct cables for use with external devices, contact your IBM reseller or IBM marketing representative.

For information about the maximum length of a SCSI cable between the terminated ends of the cable, refer to the American National Standards Institute (ANSI) SCSI standards. Adhering to these standards will help ensure that your server operates correctly.

Setting SCSI IDs

Each SCSI device connected to a SCSI controller must have a unique SCSI ID. This ID enables the SCSI controller to identify the device and ensure that different devices on the same SCSI channel do not attempt to transfer data simultaneously. SCSI devices that are connected to different SCSI channels can have duplicate SCSI IDs.

To install external SCSI devices, you must first install an optional SCSI PCI adapter. Refer to the information that is provided with the device for instructions to set its SCSI ID.

If a SCSI adapter is installed in your server, you can use its 68-pin SCSI connector to connect different types of SCSI devices. The following table shows the pin-number assignments for the SCSI connector.

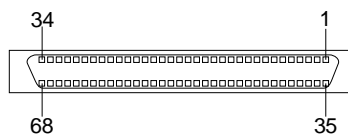

Table 10. 68-pin SCSI connector pin-number assignments.

| Pin | Signal | Pin | Signal |
|-----|---------------|-----|---------------|
| 1 | +Data 12 | 35 | -Data 12 |
| 2 | +Data 13 | 36 | -Data 13 |
| 3 | +Data 14 | 37 | -Data 14 |
| 4 | +Data 15 | 38 | -Data 15 |
| 5 | +Data P1 | 39 | -Data P1 |
| 6 | +Data 0 | 40 | -Data 0 |
| 7 | +Data1 | 41 | -Data 1 |
| 8 | +Data 2 | 42 | -Data 2 |
| 9 | +Data 3 | 43 | -Data 3 |
| 10 | +Data 4 | 44 | -Data 4 |
| 11 | +Data 5 | 45 | -Data 5 |
| 12 | +Data 6 | 46 | -Data 6 |
| 13 | +Data 7 | 47 | -Data 7 |
| 14 | +Data P | 48 | -Data P |
| 15 | Ground | 49 | Ground |
| 16 | DIFFSENS | 50 | Ground |
| 17 | Term power | 51 | Term power |
| 18 | Term power | 52 | Term power |
| 19 | Reserved | 53 | Reserved |
| 20 | Ground | 54 | Ground |
| 21 | +Attention | 55 | -Attention |
| 22 | Ground | 56 | Ground |
| 23 | +Busy | 57 | -Busy |
| 24 | +Acknowledge | 58 | -Acknowledge |
| 25 | +Reset | 59 | -Reset |
| 26 | +Message | 60 | -Message |
| 27 | +Select | 61 | -Select |
| 28 | +Control/Data | 62 | -Control/Data |
| 29 | +Request | 63 | -Request |
| 30 | +Input/Output | 64 | -Input/Output |
| 31 | +Data 8 | 65 | -Data 8 |
| 32 | +Data 9 | 66 | -Data9 |
| 33 | +Data 10 | 67 | -Data 10 |
| 34 | +Data 11 | 68 | -Data 11 |

Chapter 6. Solving problems

This section provides basic troubleshooting information to help you resolve some common problems that might occur with your system.

If you cannot locate and correct the problem using the information in this section, refer to “Getting information, help, and service” on page 91 for more information.

Diagnostic tools overview

The following tools are available to help you identify and resolve hardware-related problems:

- **POST beep codes**

The power-on self-test beep codes indicate the detection of a problem. See “POST” on page 67 for more information.

- **Diagnostic programs and error messages**

The system diagnostic programs are provided on the *IBM Enhanced Diagnostics* CD. These programs test the major components of your server. See “Diagnostic programs and error messages” on page 68 for more information.

- **Troubleshooting charts**

These charts list problem symptoms and steps to correct the problems. See the “Troubleshooting charts” on page 79 for more information.

- **Customized support page**

You can create a customized support page on the World Wide Web that is specific to your hardware, including frequently asked questions, parts information, technical hints and tips, and downloadable files. In addition, you can choose to receive electronic mail (e-mail) notifications whenever new information becomes available about your registered products.

After you register and profile your server, you can diagnose problems using the IBM Online Assistant, and you can participate in the IBM discussion forum. For more detailed information about registration and creating a customized profile for your IBM products, visit the following addresses on the Web:

- <http://www.ibm.com/pc/register>
- <http://www.ibm.com/pc/support>

Server Support

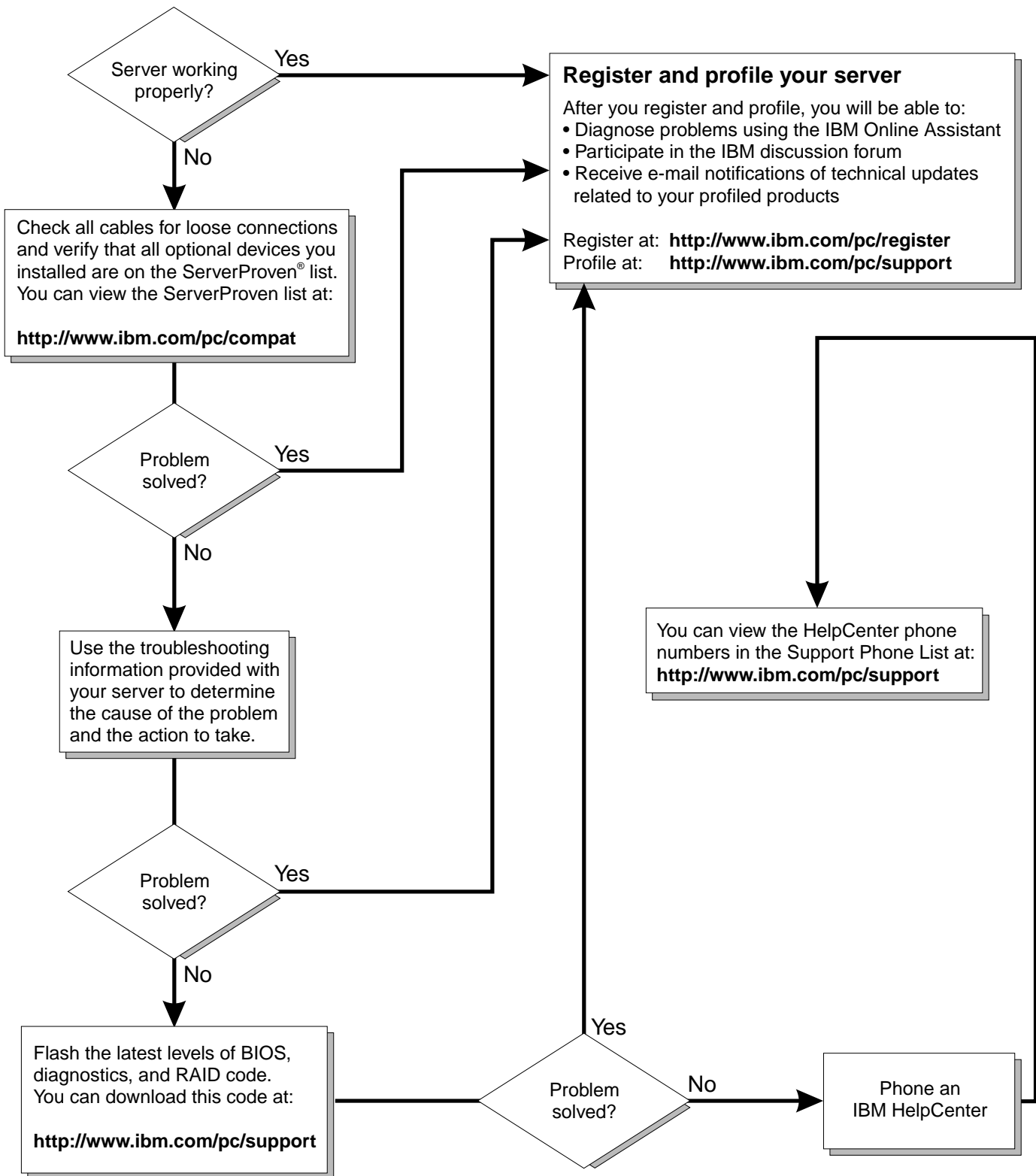

POST

When you turn on the server, it performs a series of tests to check the operation of system components and some of the options that are installed in the server. This series of tests is called the power-on self-test, or POST.

If POST finishes without detecting any problems, the first window of your operating system or application program appears.

Notes:

1. If you have a power-on password set, you must type the password and press Enter, when prompted, before POST will continue.
2. A single problem might cause several error messages. When this occurs, work to correct the cause of the first error message. After you correct the cause of the first error message, the other error messages usually will not occur the next time you run the test.

The possible types of beep codes that your system might emit are:

Repeating long beeps

Indicates that a memory error has occurred. Ensure that all DIMMs are correctly installed.

One long beep and two short beeps

Indicates that a video error has occurred and the BIOS code cannot initialize the video screen to display any additional information. Ensure that the video adapter is correctly installed.

Small computer system interface (SCSI) messages

If you receive a SCSI error message, one or more of the following might be causing the problem:

- A failing SCSI device (adapter, drive, controller)
- An improper SCSI configuration
- Duplicate SCSI IDs in the same SCSI chain
- An improperly installed SCSI terminator
- A defective SCSI terminator
- An improperly installed cable
- A defective cable

To solve the problem, verify that:

- The external SCSI devices are turned on. External SCSI devices must be turned on *before* the server.
- The cables for all external SCSI devices are connected correctly.
- The last device in each SCSI chain is terminated properly.
- The SCSI devices are configured correctly.

If you have verified these items and the problem persists, run the diagnostic programs to obtain additional information about the failing device. If the error remains or recurs, call for service.

Note: If your server does not have a SCSI hard disk drive, ignore any messages that indicates that the BIOS is not installed. You will get these messages only when running the SCSISelect Utility.

Diagnostic programs and error messages

The system diagnostic programs are stored on the *IBM Enhanced Diagnostics CD*. These programs provide the primary methods of testing the major components of your server.

Diagnostic error messages indicate that a problem exists; they are not intended to be used to identify a failing part. Troubleshooting and servicing of complex problems that are indicated by error messages should be performed by trained service personnel.

Sometimes the first error to occur causes additional errors. In this case, the server displays more than one error message. Always follow the suggested action instructions for the *first* error message that appears.

The following sections contain the error codes that might appear in the detailed test log and summary log, when running the diagnostic programs.

The error code format is as follows:

fff-ttt-iii-date-cc-text message

where:

| | |
|---------------------|-----------------------------------------------------------------------------------------------------------------------------------------------------------------------------------------------------------|
| fff | is the three-digit function code that indicates the function being tested when the error occurred. For example, function code 089 is for the microprocessor. |
| ttt | is the three-digit failure code that indicates the exact test failure that was encountered. (These codes are for trained service personnel and are described in the <i>Hardware Maintenance Manual</i> .) |
| iii | is the three-digit device ID. (These codes are for trained service personnel and are described in the <i>Hardware Maintenance Manual</i> .) |
| date | is the date that the diagnostic test was run and the error recorded. |
| cc | is the check value that is used to verify the validity of the information. |
| text message | is the diagnostic message that indicates the reason for the problem. |

Text messages

The diagnostic text message format is as follows:

Function Name: Result (test specific string)

where:

| | | | | | |
|----------------------|-------------------------------------------------------------------------------------------------------------------------------------------------------------------------------------------------------------------------------------------------------------------------|---------------|---------------------------------------------------------------------------|---------------|-----------------------------------------------------------------|
| Function Name | is the name of the function being tested when the error occurred. This corresponds to the function code (fff) given in the previous list. | | | | |
| Result | can be one of the following: <table><tr><td>Passed</td><td>This result occurs when the diagnostic test completes without any errors.</td></tr><tr><td>Failed</td><td>This result occurs when the diagnostic test discovers an error.</td></tr></table> | Passed | This result occurs when the diagnostic test completes without any errors. | Failed | This result occurs when the diagnostic test discovers an error. |
| Passed | This result occurs when the diagnostic test completes without any errors. | | | | |
| Failed | This result occurs when the diagnostic test discovers an error. | | | | |

| | |
|-----------------------------|-------------------------------------------------------------------------------------------------------------------------------------------------|
| User Aborted | This result occurs when you stop the diagnostic test before it is complete. |
| Not Applicable | This result occurs when you specify a diagnostic test for a device that is not present. |
| Aborted | This result occurs when the test could not proceed because of the system configuration. |
| Warning | This result occurs when a possible problem is reported during the diagnostic test, such as when a device that is to be tested is not installed. |
| Test Specific String | This is additional information that is used to analyze the problem. |

Starting the diagnostic programs

The IBM Enhanced Diagnostics programs will isolate your server hardware from software that you have installed on your hard disk drive. The programs run independently of the operating system, and *must be run either from the CD or from the diskette*. This method of testing is generally used when other methods are not accessible or have not been successful in isolating a problem suspected to be hardware related.

An *IBM Enhanced Diagnostics CD* comes with your server. You can also download the latest image of the diagnostics from <http://www.ibm.com/pc/support> on the World Wide Web.

Using the diagnostics CD

To start the IBM Enhanced Diagnostics CD, do the following:

1. Turn off your server and any peripheral devices.
2. Turn on all attached devices; then, turn on your server.
3. When you see **Press F1 For Configuration/Setup**, press the F1 key.
4. When the Configuration/Setup Utility menu appears, select **Start Options**.
5. From the Start Options menu, select **Startup Sequence**.
6. Note the device selected as the First Startup Device. Later, you must restore this setting.
7. Select **CD-ROM** as the First Startup Device.
8. Press Esc two times to return to the Configuration/Setup Utility menu.
9. Place the *IBM Enhanced Diagnostics CD* in the CD-ROM drive.
10. Select **Save & Exit Setup** and follow the prompts. The diagnostics will load. Follow the instructions on the screen to run the diagnostics.

When the tests complete, you can view the test log by selecting **Utility** from the top of the screen.

If the diagnostic programs do not detect any hardware error, but the problem persists during normal server operations, a software error might be the cause. If you suspect a software problem, refer to the information that comes with the software package.

Important: When you finish running the diagnostic programs, remove the CD from the CD-ROM drive and turn off the server. You must restore the First Startup Device to the original setting. Use steps 2 through 8 of this procedure to do this.

Downloading the diagnostics program

Complete the following steps to download the latest image of the *IBM Enhanced Diagnostics* from the World Wide Web and create a startable *Enhanced Diagnostics* diskette:

1. Go to the following World Wide Web site: <http://www.ibm.com/pc/support>
2. Download the diagnostics file for your server to a hard disk drive directory (not to a diskette).
3. Go to a DOS prompt and change to the directory where the file was downloaded.
4. Insert a blank high-density diskette into diskette drive A.
5. Type *filename a:* where filename is the name of the file you downloaded from the Web, and press Enter.

The downloaded file is self-extracting and will be copied to the diskette. When the copy completes, you have a startable *IBM Enhanced Diagnostics* diskette.

Using the diagnostic diskette

Complete the following steps to start the *IBM Enhanced Diagnostics* diagnostics diskette:

1. Turn off your server and any peripheral devices.
2. Insert the *IBM Enhanced Diagnostics* diskette into the diskette drive.
3. Turn on the peripheral devices; then, turn on your server.
4. Follow the instructions on the screen.

When the tests complete, you can view the test log by selecting **Utility** from the top of the screen.

If the diagnostic programs do not detect any hardware error, but the problem persists during normal server operations, a software error might be the cause. If you suspect a software problem, refer to the information that comes with the software package.

Viewing the test log

The test log records data about system failures and other pertinent information. The test log will not contain any information until after the diagnostic program has run.

Note: If you already are running the diagnostic programs, begin with step 4.

Do the following to view the test log:

1. Insert the diagnostic CD or diskette in the appropriate drive.
2. Turn on the system and watch the screen.
If the system is on, shut down your operating system and restart the system.
3. If a power-on password is set, the system prompts you for it. Type the appropriate password; then, press Enter.
4. Run the diagnostic programs, and when the Diagnostic Programs screen appears, select **Utility**.
5. Select **View Test Log** from the list that appears; then, follow the instructions on the screen. You can save the test log to a file on a diskette or to your hard disk drive.

Note: The system maintains the test-log data while the system is powered on. When you turn off the power to the server, the test log is cleared.

Diagnostic error message tables

The following tables provide descriptions of the error messages that might be listed in the test log after you run the diagnostic programs.

Attention: If diagnostic error messages appear that are not listed in the following tables, make sure that your system has the latest levels of BIOS and ServeRAID code, and you are using the latest diagnostic code.

| Code | Function | Result | Text message | Action |
|------|----------------|---------|---------------------------------------------------------------------------------------------------------------------------------------------------------------------------|-----------------------------------------------------------------------------------------------------------------------------------------------------------------------------------------------------------------------------|
| 001 | Core system | Failed | Processor board, ECC Test | Call for service. |
| | | | System board | |
| | | | Processor and system boards | |
| | | | Integrated serial port | |
| 005 | Video port | | Processor and system boards | |
| 011 | Serial port | | Integrated serial port | |
| 014 | Parallel port | | Integrated parallel port | |
| 015 | USB interface | Aborted | Can NOT test USB interface while it is in use. Note: If you have a USB keyboard or mouse attached, you cannot run the diagnostic program for the USB interface. | <ol style="list-style-type: none"> Turn off the system. Replace the USB keyboard and mouse with a standard keyboard and mouse. Turn on the system. Run the diagnostic test again. |
| | | Failed | System board | Call for service. |
| 020 | PCI interface | Failed | System board | Call for service. |
| 030 | SCSI interface | Failed | SCSI adapter in slot <i>n</i> failed register/counter/power test (where <i>n</i> is the slot number of the failing adapter) | Refer to the information provided with the adapter for instructions. If the problem persists, call for service. |
| | | | SCSI controller on system board failed register/counter/power test | Call for service. |
| 075 | Power supply | Failed | Voltage sensed by the system is out of range | Call for service. |

| Code | Function | Result | Text message | Action |
|------|----------------|--------|---------------------------------------------------------------------------------------------------------------------------------------------------------------|----------------------------------------------------------------------------------------------------------------------------------------------------------------------------------------------------------------------------------------------------------------------------------------------------------------------------------------------------------------------------------------------|
| 089 | Microprocessor | Failed | Invalid microprocessor in slot xyz or BIOS setup problem (where xyz identifies the microprocessor that is causing the error message) | <ol style="list-style-type: none"> 1. Check the system error log for the related error messages. 2. If your system does not have the latest level BIOS code installed, update the BIOS code. 3. If the problem remains, replace the xyz microprocessor and run the test again. <p>If the problem persists, call for service.</p> |
| | | | Processor in socket id xyz is installed but not functioning (where xyz identifies the microprocessor that is causing the error message) | |
| | | | Microprocessor in socket id xyz (where xyz identifies the microprocessor that is causing the error message) | <ol style="list-style-type: none"> 1. Reseat the microprocessor. 2. If the problem remains, replace the microprocessor. <p>If the problem persists, call for service.</p> |
| | | | Processor in socket id xyz is defective (where xyz identifies the microprocessor that is causing the error message) | <p>Replace the microprocessor.</p> <p>If the problem persists, call for service.</p> |
| | | | Test setup error: Application microprocessor not installed or BIOS setup problem | <ol style="list-style-type: none"> 1. Verify that the Application microprocessor is installed and seated correctly. 2. If your system does not have the latest level BIOS code installed, update the BIOS code. 3. If the problem remains, replace the Application microprocessor and run the test again. <p>If the problem persists, call for service.</p> |
| | | | VRM corresponding to microprocessor in socket xyz is defective (where xyz identifies the microprocessor whose VRM is causing the error message) | <p>Replace the VRM.</p> <p>If the problem remains, call for service.</p> |
| | | | VRM corresponding to microprocessor in socket id xyz is not installed (where xyz identifies the microprocessor whose VRM is causing the error message) | <p>Install a VRM.</p> <p>If the problem persists, call for service.</p> |

| Code | Function | Result | Text message | Action |
|------|----------------|--------|--------------------------------------------------------------------------------------------------------------------|---------------------------------------------------------------------------------------------------------------------------------------------------------------------------------------|
| 175 | System thermal | Failed | Fan # <i>n</i> (where <i>n</i> is the number of the failing fan) | Replace the indicated fan. |
| | | | Temperature sensed on processor board is out of range | Call for service. |
| 180 | Status display | Failed | Any failure message | Call for service. |
| 201 | System memory | Failed | DIMMs in location DIMM <i>n</i> (where <i>n</i> is the number of the socket that contains the failing DIMM) | <ol style="list-style-type: none"> 1. Reseat the failing DIMM. 2. If the problem remains, replace the DIMM. <p>If the problem persists, call for service.</p> |
| | | | Test setup error: Corrupt BIOS code in ROM | <p>If your system does not have the latest level BIOS code installed, update the BIOS code to the latest level.</p> <p>If the problem persists, call for service.</p> |
| | | | Test setup error: Corrupt DMI BIOS code, information in BIOS code is not as expected | |

| Code | Function | Result | Text message | Action |
|------|-----------------|--------------------------------------------------------------------------------------------------------------------------------------------------------------------------------|---------------------------------------------------------------------------------------------------------------------------------------------------------------------------------|-----------------------------------------------------------------------------------------------------------------------------------------------------------------------------------------------------|
| 202 | System cache | Aborted | Test setup error: BIOS cannot access VPD information | If your system does not have the latest level BIOS code installed, update the BIOS code to the latest level and run the diagnostic program again. If the problem persists, call for service. |
| | | | Test setup error: Corrupt DMI BIOS, information in BIOS is not as expected | |
| | | | Test setup error: No L2 cache detected on microprocessor socket id xyz or BIOS setup problem (where xyz identifies the microprocessor that is causing the error message) | |
| | | Test setup error: Unknown hardware problem associated with microprocessor in socket id xyz. (where xyz identifies the microprocessor that is causing the error message) | 2. Run the diagnostic program again. 3. If the problem remains, replace the failing processor. If the problem persists, call for service. | |
| | | Failed | Microprocessor in socket ID xyz (where xyz identifies the microprocessor that is causing the error message) | 1. Reseat the identified microprocessor. 2. If the problem remains, replace the microprocessor. If the problem persists, call for service. |
| | | Warning | Test setup error: Cache is disabled. Use system setup to enable before retrying the test | Use the Cache Control choice under the Advanced Setup menu, under the Configuration/Setup Utility program main menu, to enable the cache. If the problem persists, call for service. |
| 206 | Diskette drive | Failed | Internal diskette drive bay | Call for service. |
| 215 | CD-ROM | Failed | On system board. | Call for service. |
| | | Aborted | The CD-ROM drive is not present. | Verify that the cables are properly connected to the CD-ROM drive. If the problem persists, call for service. |
| 217 | Hard disk drive | Failed | BIOS drive # <i>n</i> (where <i>n</i> is the drive bay number) | Call for service. |

| Code | Function | Result | Text message | Action |
|------|---------------|--------|--------------------------------------------------------------------------------------------------------------------|---------------------------------------------------------------------------------------------------------------------------------------------------------------------------------------------------------------------|
| 301 | Keyboard | Failed | On system-board keyboard test failed | <ol style="list-style-type: none"> 1. Verify that the keyboard cable is connected. 2. If the problem remains, replace the keyboard cable. <p>If the problem persists, call for service.</p> |
| 302 | Mouse | Failed | On system-board pointing device test failed. | Replace the pointing device. If the problem persists, call for service. |
| 305 | Video monitor | | Any message | Refer to the information that came with the monitor. |
| 405 | Ethernet | Failed | In PCI slot <i>n</i> (where <i>n</i> is the PCI slot number in which the failing Ethernet adapter is installed) | Replace the Ethernet adapter in slot <i>n</i> . If the problem persists, call for service. |
| | | | On system board | Call for service. |

| Code | Function | Result | Text message | Action |
|-------------|----------------------|----------------|-------------------------------------|-----------------------------------------------------------------------------------------------------------------------------------------------------------------------------------------------------------------------------------------------------------------------------------------------------------------------------------------------|
| 415 | Analog/digital modem | Not applicable | No modem was detected | <ol style="list-style-type: none"> 1. Verify that the modem is properly attached to the system. 2. If the problem remains, replace the modem. <p>If the problem persists, call for service.</p> |
| | | | PCI modem detected, but not enabled | <ol style="list-style-type: none"> 1. Change the configuration to enable the modem. 2. If the problem remains, replace the modem. <p>If the problem persists, call for service.</p> |
| | | Failed | Modem reset failed | <p>Replace the modem.</p> <p>If the problem persists, call for service.</p> |
| | | | No dial tone detected | <ol style="list-style-type: none"> 1. Make sure that the phone line attached to the modem has a dial tone. (Connect a phone to the line and listen, if necessary.) If there is no tone, have the phone line serviced. 2. If the problem remains, replace the modem. <p>If the problem persists, call for service.</p> |

ServerGuide error symptoms

Look for the symptom in the left column of the chart. Probable solutions to the problem are in the right column.

Setup and Installation CD

| Symptom | Suggested action |
|--------------------------------------------------------------------------------|---------------------------------------------------------------------------------------------------------------------------------------------------------------------------------------------------------------------------------------------------------------------------------------------------------------------------------------------------------------------------------------------------------------------------------|
| Setup and Installation CD will not start. | <ul style="list-style-type: none">• Ensure that the system is a supported server with a startable (bootable) CD-ROM drive.• If the startup (boot) sequence settings have been altered, ensure that the CD-ROM drive is first in the startup sequence.• If more than one CD-ROM drive is installed, ensure that only one drive is set as the primary drive. Start the CD from the primary drive. |
| ServerRAID program cannot view all installed drives - or - cannot install NOS. | <ul style="list-style-type: none">• Ensure that there are no duplicate SCSI IDs or IRQ assignments.• Ensure that the hard disk drive is connected properly. |
| The Operating System Installation program continuously loops. | Make more space available on the hard disk. |
| ServerGuide will not start <i>your</i> NOS CD. | Ensure that the NOS CD you have is supported by the ServerGuide program. See the <i>Setup and Installation</i> CD label for a list of supported NOS versions. |
| Cannot install NOS - option is unavailable. | Ensure that the NOS is supported on your server. If the NOS is supported, either there is no logical drive defined (ServerRAID systems) or the ServerGuide System Partition is not present. Run the ServerGuide setup and configuration program, and ensure that setup is complete. |

System Updates and Applications CD

| Symptom | Suggested action |
|-----------------------------------------|---------------------------------------------------------------|
| Get "time out" or "Unknown host" errors | Be sure you have access to the Internet through FTP directly. |

Recovering the BIOS code

If the BIOS code has become damaged, such as from a power failure during a flash update, you can recover the BIOS code using a BIOS flash diskette.

You can obtain a BIOS flash diskette from one of the following sources:

- Use the ServerGuide program to make a BIOS flash diskette.
- Download files from the World Wide Web to make a BIOS flash diskette. Go to <http://www.ibm.com/pc/support/> select IBM System Support, and then make the selections for your system.
- Contact your IBM service representative.

Complete the following steps to recover the BIOS code:

1. When prompted, insert the BIOS flash diskette into the diskette drive.
2. Restart the server. The BIOS begins the power-on self-test.
3. The BIOS flash utility automatically starts.
4. When prompted as to whether you want to save the current code to a diskette, select N.
5. When prompted, press Y to continue the flash process.
6. The system automatically starts the flash utility a second time.
7. When prompted as to whether you want to save the current BIOS code, stop the process by removing the BIOS flash diskette from the diskette drive.
8. Restart the server, which should start up normally.

Clearing CMOS

If you need to *erase* configuration information, you must move the CMOS jumper.

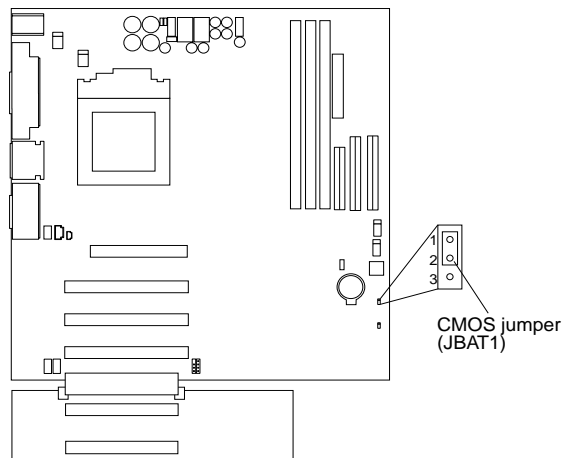

The default position is a jumper installed on pins 1 and 2. Before you change the position of this jumper, you *must* turn off the server and peripheral devices and disconnect all external cables and power cords. Remove the server cover and then move the jumper to pins 2 and 3.

After moving the jumper, wait at least 5 minutes for the CMOS information to clear.

Changing the position of this jumper erases all configuration and setup information, including the power-on and administrator passwords. Therefore, you must reconfigure the server after clearing CMOS memory (see Chapter 3, “Configuring your server,” on page 9). If possible, record your server configuration information *before* moving the CMOS jumper.

After you clear the CMOS information, move the jumper back to its normal position (pins 1 and 2); then, replace the server cover. Reconnect the external cables and power cords; then, turn on the peripheral devices and the server.

Troubleshooting charts

You can use the troubleshooting charts in this section to find solutions to problems that have definite symptoms.

Important: If diagnostic error messages appear that are not listed in the following tables, make sure that your system has the latest level of BIOS code and you are using the latest diagnostic code.

See “Starting the diagnostic programs” on page 69 to test the system. If you have run the diagnostic test programs or if running the tests does not reveal the problem, call for service.

Look for the symptom in the left column of the chart. Instructions and probable solutions to the problem are in the right column. If you have just added new software or a new option and your system is not working, do the following before using the troubleshooting charts:

- Remove the software or device that you just added.
- Run the diagnostic tests to determine if your system is running correctly.
- Reinstall the new software or new device.

Table 11. Troubleshooting charts.

| Device | Suggested action |
|----------------------------------------------------------------------------------|----------------------------------------------------------------------------------------------------------------------------------------------------------------------------------------------------------------------------------------------------------------------------------------------------------------------------------------------------------------------------------------------------------------------------------------------------------------------------------------|
| CD-ROM drive | Verify that: |
| CD-ROM drive is not recognized. | <ol style="list-style-type: none"> 1. The primary IDE channel is enabled in the Configuration/Setup Utility program. 2. All cables and jumpers are installed correctly. 3. The correct device driver is installed for the CD-ROM drive. |
| Diskette drive | If there is a diskette in the drive, verify that: |
| Diskette drive in-use light stays on, or the system bypasses the diskette drive. | <ol style="list-style-type: none"> 1. The diskette drive is enabled in the Configuration/Setup Utility program. 2. The diskette is good and not damaged. (Try another diskette if you have one.) 3. The diskette contains the necessary files to start the system. 4. Your software program is working properly. <p>If the diskette drive in-use light stays on, or the system continues to bypass the diskette drive, call for service.</p> |

Table 11. Troubleshooting charts.

| Device | Suggested action |
|--------------------------------------------------------------------------------------------------------------------------------------|--------------------------------------------------------------------------------------------------------------------------------------------------------------------------------------------------------------------------------------------------------------------------------------------------------------------------------------------------------------------------------------------------------------------------------------------------------------------------------------------------------------------------------------------------------------------------------------------------|
| <p>Expansion enclosure</p> <p>The SCSI expansion enclosure used to work, but does not work now.</p> | <p>Verify that:</p> <ol style="list-style-type: none"> 1. The cables for all external SCSI options are connected correctly. 2. The last option in each SCSI chain, or the end of the SCSI cable, is terminated correctly. 3. External SCSI options are turned on. You must turn on external SCSI options before turning on the system. <p>For more information, see your SCSI and expansion enclosure documentation.</p> |
| <p>Other devices</p> <p>Problems such as broken cover locks or indicator lights not working.</p> | <p>Call for service.</p> |
| <p>Intermittent problems</p> <p>A problem occurs only occasionally and is difficult to detect.</p> | <p>Verify that:</p> <ol style="list-style-type: none"> 1. All cables and cords are connected securely to the rear of the system and attached options. 2. When the system is turned on, air is flowing from the rear of the system at the fan grille. If there is no air flow, the fan is not working. This causes the system to overheat and shut down. 3. Ensure that the SCSI bus and devices are configured correctly and that the last external device in each SCSI chain is terminated correctly. <p>If the items above are correct, call for service.</p> |
| <p>Keyboard, mouse, or pointing-device</p> <p>All or some keys on the keyboard do not work.</p> | <ol style="list-style-type: none"> 1. Make sure that the keyboard cable is properly connected to the system. 2. Make sure that the system and the monitor are turned on. 3. Try using another keyboard. <p>If the items above are correct, call for service.</p> |
| <p>The mouse or pointing device does not work.</p> | <ol style="list-style-type: none"> 1. Verify that the mouse or pointing-device cable is securely connected and the device drivers are installed correctly. 2. Try using another mouse or pointing device. <p>If the problem remains, call for service.</p> |
| <p>Memory</p> <p>The amount of memory displayed is less than the amount of memory installed.</p> | <p>Verify that:</p> <ol style="list-style-type: none"> 1. The memory modules are seated properly. 2. You have installed the correct type of memory. 3. If you changed the memory, you must update the memory configuration with the Configuration/Setup Utility program. 4. All banks of memory on the DIMMs are enabled. The system might have automatically disabled a DIMM bank if it detected a problem, or a DIMM bank could have been manually disabled. <p>If the items above are correct and the screen remains blank, call for service.</p> |
| <p>Monitor</p> <p>The monitor works when you turn on the system, but goes blank when you start some application programs.</p> | <p>Verify that:</p> <ol style="list-style-type: none"> 1. The primary monitor cable is connected to the video port. 2. You installed the necessary device drivers for the applications. <p>Some IBM monitors have their own self-tests. If you suspect a problem with your monitor, refer to the information that comes with the monitor for adjusting and testing instructions.</p> <p>If you still cannot find the problem, call for service.</p> |

Table 11. Troubleshooting charts.

| Device | Suggested action |
|----------------------------------------------------------------|------------------------------------------------------------------------------------------------------------------------------------------------------------------------------------------------------------------------------------------------------------------------------------------------------------------------------------------------------------------------------------------------------------------------------------------------------------------------------------------------------------------------------------------------------------------------------------------------------------------------------------------------------------------------------------------------------------------------------------------------------------------------------------------------------------------------------------------------------------------------------------------------------------------------------------------------------------------------------------------------------------------------------------------------------------------------------|
| The screen is blank. | Verify that: <ol style="list-style-type: none"> 1. The system power cord is plugged into the server and a working electrical outlet. 2. The monitor cables are connected properly. 3. The monitor is turned on and the brightness and contrast controls are adjusted correctly. If the items above are correct and the screen remains blank, call for service. |
| Only the cursor appears. | Call for service. |
| Wavy, unreadable, rolling, distorted screen, or screen jitter. | If the monitor self-tests show the monitor is working properly, consider the location of the monitor. Magnetic fields around other devices (such as transformers, appliances, fluorescent lights, and other monitors) can cause screen jitter or wavy, unreadable, rolling, or distorted screen images. If this happens, turn off the monitor. (Moving a color monitor while it is turned on might cause screen discoloration.) Then move the device and the monitor at least 305 mm (12 in.) apart. Turn on the monitor. <p>Notes:</p> <ol style="list-style-type: none"> 1. To prevent diskette drive read/write errors, be sure the distance between monitors and diskette drives is at least 76 mm (3 in.). 2. Non-IBM monitor cables might cause unpredictable problems. 3. An enhanced monitor cable with additional shielding is available for the 9521 and 9527 monitors. For information about the enhanced monitor cable, see your IBM reseller or IBM marketing representative. If the problem remains, call for service. |
| Wrong characters appear on the screen. | If the wrong language is displayed, update the BIOS code with the correct language. If the problem remains, call for service. |
| Option | Verify that: |
| An IBM option that was just installed does not work. | <ol style="list-style-type: none"> 1. The option is designed for the server. Refer to the "Server Support" flowchart for information about obtaining ServerProven compatibility information from the World Wide Web. 2. You followed the installation instructions that came with the option. 3. The option is installed correctly. 4. You have not loosened any other installed options or cables. 5. You updated the configuration information in the Configuration/Setup Utility program. Whenever memory or an option is changed, you must update the configuration. If the problem remains, call for service. |
| An IBM option that used to work does not work now. | Verify that all of the option hardware and cable connections are secure. If the option comes with its own test instructions, use those instructions to test the option. If the failing option is a SCSI option, verify that: <ol style="list-style-type: none"> 1. The cables for all external SCSI options are connected correctly. 2. The last option in each SCSI chain, or the end of the SCSI cable, is terminated correctly. 3. All external SCSI options are turned on. You must turn on external SCSI options before turning on the server. If the problem remains, call for service. |

Table 11. Troubleshooting charts.

| Device | Suggested action |
|---------------------------------------------------------------------------------------------------------------------------------------------------|----------------------------------------------------------------------------------------------------------------------------------------------------------------------------------------------------------------------------------------------------------------------------------------------------------------------------------------------------------------------------------------------------------------------------------------------------------------------------------------------------------------------------------------------------------------------------------------------------------------------------------------------------------------------------------------------------------------------------------------------------------------------------------------|
| <p>Parallel port</p> <p>The number of parallel ports displayed is less than the number of parallel ports installed.</p> | <p>Verify that:</p> <ol style="list-style-type: none"> Each port is assigned a unique address. The parallel-port adapter, if you installed one, is seated properly. <p>If the problem remains, call for service.</p> |
| <p>Power</p> <p>The system does not power on.</p> | <p>Verify that:</p> <ol style="list-style-type: none"> The power cables are properly connected to the server. The electrical outlet functions properly. The type of memory installed is correct. If you just installed an option, remove it, and restart the server. If the server now turns on, you might have installed more options than the power supply supports. <p>If the problem remains, call for service.</p> |
| <p>Printer</p> <p>The printer does not work.</p> | <p>Verify that:</p> <ol style="list-style-type: none"> The printer is turned on and is online. The printer signal cable is connected to the correct serial or parallel port on the system. <p>Note: Non-IBM printer cables might cause unpredictable problems.</p> <ol style="list-style-type: none"> You have assigned the printer port correctly in your operating system or application program. You have assigned the printer port correctly using the Configuration/Setup Utility program. <p>If the items above are correct and the printer still does not work, run the tests described in the documentation that comes with your printer. If the tests show that the printer is working properly, call for service.</p> |
| <p>Serial port</p> <p>The number of serial ports identified by the operating system is less than the number of serial ports installed.</p> | <p>Verify that:</p> <ol style="list-style-type: none"> Each port is assigned a unique address by the Configuration/Setup Utility program and none of the serial ports are disabled. The serial-port adapter, if you installed one, is seated properly. <p>If the problem still exists, call for service.</p> |
| <p>A serial device does not work.</p> | <p>Verify that:</p> <ol style="list-style-type: none"> The device is compatible with the server. The serial port is enabled and is assigned a unique address. <p>If the problem still exists, call for service.</p> |

Table 11. Troubleshooting charts.

| Device | Suggested action |
|-----------------------------------------|----------------------------------------------------------------------------------------------------------------------------------------------------------------------------------------------------------------------------------------------------------------------------------------------------------------------------------------------------------------------------------------------------------------------------------------------------------------------------------------------------------------------------------------------------------------------------------------------------------------------------------------------------------------------------------------------------------------------------------------------------------------------------------------------------------------------------|
| Software | To determine if problems are caused by the software, verify that: |
| Suspected software problem. | <ol style="list-style-type: none"> 1. Your system has the minimum memory requirements needed to use the software. For memory requirements, refer to the information that comes with the software. Note: If you have just installed an adapter or memory, you might have a memory address conflict. 2. The software is designed to operate on your system. 3. Other software works on your system. 4. The software that you are trying to use works on another system. <p>If you received any error messages when using the software program, refer to the information that comes with the software for a description of the messages and solutions to the problem.</p> <p>If the items above are correct and the problem remains, contact your place of purchase.</p> |
| Universal Serial Bus (USB) ports | Verify that: |
| A USB device does not work. | <ol style="list-style-type: none"> 1. You are not trying to use a USB device during POST, if you have a standard (non-USB) keyboard attached to the keyboard port. Note: If a standard (non-USB) keyboard is attached to the keyboard port, then the USB is disabled and no USB device will work during POST. 2. The correct USB device driver is installed. 3. Your operating system supports USB devices. <p>If the problem still exists, call for service.</p> |

Troubleshooting the Ethernet controller

This section provides troubleshooting information for problems that might occur with the 10/100 Mbps Ethernet controller.

Network connection problems

If the Ethernet controller cannot connect to the network, check the following:

- Make sure that the cable is installed correctly.
The network cable must be securely attached at all connections. If the cable is attached but the problem persists, try a different cable.
If you set the Ethernet controller to operate at 100 Mbps, you must use Category 5 cabling.
If you directly connect two workstations (without a hub), or if you are not using a hub with X ports, use a crossover cable.
Note: To determine whether a hub has an X port, check the port label. If the label contains an X, the hub has an X port.
- Determine if the hub supports auto-negotiation. If not, try configuring the integrated Ethernet controller manually to match the speed and duplex mode of the hub.
- Check the LAN activity light (if available) on the rear of the server. The LAN activity light illuminates when the Ethernet controller sends or receives data over the Ethernet network. If the LAN activity light is off, make sure that the hub and network are operating and that the correct device drivers are loaded.
- Make sure that you are using the correct device drivers, supplied with your system.

- Check for operating system-specific causes for the problem.
- Make sure that the device drivers on the client and system are using the same protocol.
- Test the Ethernet controller.

The way you test the Ethernet controller depends on which operating system you are using (see the Ethernet controller device driver README file).

Ethernet controller troubleshooting chart

You can use the following troubleshooting chart to find solutions to 10/100 Mbps Ethernet controller problems that have definite symptoms.

Table 12. Ethernet troubleshooting chart.

| Ethernet controller problem | Suggested action |
|---------------------------------------------------------------------------------------|---------------------------------------------------------------------------------------------------------------------------------------------------------------------------------------------------------------------------------------------------------------------------------------------------------------------------------------------------------------------------------------------------------------------------------------------------------------------------------------------------------------------------------------------------------------------------------------------------------------------------------------------------------------------------------------------------------------------------------------------------------------------------------------------------------------------------------------------------------------------------------------------------------------|
| The server stops running when loading device drivers. | <p>The PCI BIOS interrupt settings are incorrect.</p> <p>Check the following:</p> <ul style="list-style-type: none"> • Determine if the IRQ setting assigned to the Ethernet controller is also assigned to another device in the Configuration/Setup Utility program. <p>Although interrupt sharing is allowed for PCI devices, some devices do not function well when they share an interrupt with a dissimilar PCI device. Try changing the IRQ assigned to the Ethernet controller or the other device. For example, for NetWare Versions 3 and 4 it is recommended that disk controllers not share interrupts with LAN controllers.</p> <ul style="list-style-type: none"> • Make sure that you are using the most recent device driver available from the World Wide Web. • Run the network diagnostic program. <p>If the problem remains, call for service.</p> |
| The LAN activity light does not light (when available). | <p>Check the following:</p> <ul style="list-style-type: none"> • Make sure that you have loaded the network device drivers. • The network might be idle. Try sending data from this workstation. • Run diagnostics on the LEDs. |
| Data is incorrect or sporadic. | <p>Check the following:</p> <ul style="list-style-type: none"> • Make sure that you are using Category 5 cabling when operating the system at 100 Mbps. • Make sure that the cables do not run close to noise-inducing sources like fluorescent lights. |
| The Ethernet controller stopped working when another adapter was added to the system. | <p>Check the following:</p> <ul style="list-style-type: none"> • Make sure that the cable is connected to the Ethernet controller. • Make sure that your PCI system BIOS code is current. • Reseat the adapter. • Determine if the IRQ setting assigned to the Ethernet adapter is also assigned to another device in the Configuration/Setup Utility program. <p>Although interrupt sharing is allowed for PCI devices, some devices do not function well when they share an interrupt with a dissimilar PCI device. Try changing the IRQ assigned to the Ethernet adapter or the other device.</p> <p>If the problem remains, call for service.</p> |

Table 12. Ethernet troubleshooting chart.

| Ethernet controller problem | Suggested action |
|-----------------------------------------------------------------|----------------------------------------------------------------------------------------------------------------------------------------------------------------------------------------------------------------------------------------------------------------------------------------------------------------------------------------------------------|
| The Ethernet controller stopped working without apparent cause. | <p>Check the following:</p> <ul style="list-style-type: none"> • Run diagnostics for the Ethernet controller. • Try a different connector on the hub. • Reinstall the device drivers. Refer to your operating system documentation and to the ServerGuide information. <p>If the problem remains, call for service.</p> |

Ethernet controller messages

The integrated Ethernet controller might display messages from the following device drivers:

- Novell NetWare or IntraNetWare system open data-link interface (ODI)
- Network driver interface specification (NDIS) adapter for level 4.0 (Windows NT)

Novell NetWare or IntraNetWare system ODI driver teaming messages

This section provides explanations of the error messages for the Novell NetWare or IntraNetWare system ODI driver, and suggested actions to resolve each problem.

Table 13. NetWare driver messages for the Ethernet controller.

| Message | Description |
|------------------------------------------------------------------------------------------------------------------------------------------|------------------------------------------------------------------------------------------------------------------------------------------------------------------------------------------------------------------------------------------------------------------------------------------------------------------------------------------------------------------------------------------------------------------------|
| Couldn't allocate resources. | <p>Explanation: An unknown error has occurred when trying to allocate needed resources for the AFT Module.</p> <p>Action:</p> <ul style="list-style-type: none"> • Check the system configuration. If the problem persists, contact your network supplier. • Verify that the Ethernet controller is enabled. If the Ethernet controller is enabled, run the diagnostic programs. |
| AFT group for primary adapter in slot <i>nnn</i> already exists. | <p>Explanation: An attempt was made to rebind an adapter already in an AFT group.</p> <p>Action: Check the AFT slot numbers for existing AFT teams. If the problem persists, contact your network supplier.</p> |
| Error locating device control table (DCT) addresses in internal table. Make sure that you have loaded LAN drivers after loading AFT.NLM. | <p>Explanation: The bind command was entered prior to loading the device driver. The device driver must be loaded after loading AFT.NLM, but before any bind command can be issued. your network supplier.</p> <p>Action: Load the driver for the supported adapter and try loading the AFT module again. If the problem persists, contact your network supplier</p> |
| Insufficient number of arguments specified. | <p>Explanation: The appropriate or expected number of parameters was not entered in a command.</p> <p>Action: Check the parameters required for the given command. If the problem persists, contact your network supplier.</p> |

Table 13. NetWare driver messages for the Ethernet controller.

| Message | Description |
|---------------------------------------------------------------------------------------------------------------------------------------------------------------------------------------|----------------------------------------------------------------------------------------------------------------------------------------------------------------------------------------------------------------------------------------------------------------------------------------------------------------------------------------------------------------------------------|
| Duplicate slot numbers detected. | <p>Explanation: An attempt has been made to bind the same slot number more than once.</p> <p>Action: Check the slot numbers entered during the bind. Adapter slot numbers must be valid and unique. If the problem persists, contact your network supplier.</p> |
| 'xxx' is not supported for AFT team. | <p>Explanation: A bind command has been issued for adapters not supported by AFT.NLM.</p> <p>Action: Make sure that you attempt to bind only adapters supported by AFT.NLM.</p> |
| Primary and Secondary adapters do not match. AFT group is not created. | <p>Explanation: A bind command was entered for an adapter team that is a combination of system and client adapters. An AFT team must be a grouping of the same classification of adapter.</p> <p>Action: Verify that all the adapters bound in a team are of the same classification.</p> |
| Requested number of Secondary cards are not found. | <p>Explanation: The number of adapters specified in the bind command could not be located.</p> <p>Action: Verify the numbers and slot locations of the adapters to be bound. If the problem persists, contact your network supplier.</p> |
| Failed to create AFT group. Make sure that the drivers for supported adapters are loaded, primary adapter is bound to protocols, and secondary adapter is not bound to any protocols. | <p>Explanation: Binding of protocol failed. Protocol is either not bound to any adapter or is bound to more than one adapter in the group.</p> <p>Action: Ensure that the protocol is bound to only adapter in an AFT team.</p> |
| Error identifying slot numbers for the specified board names. | <p>Explanation: The mapping between the board name entered and the slot number for an adapter could not be established.</p> <p>Action: Check the board name for the adapter before issuing the bind command. If the problem persists, contact your network supplier.</p> |
| Can't unbind specified slot from AFT group. Make sure that the slot you specified is for the primary adapter in an AFT group. | <p>Explanation: The number entered in the unbind command was not the primary adapter in an AFT group.</p> <p>Action: Reissue the unbind command and specify the slot number for the primary adapter.</p> |
| LAN adapter at slot <i>nnnn</i> (Port 0xaa) failed to reset. Check the state of the adapter. | <p>Explanation: The adapter that you specified could not be initialized.</p> <p>Action:</p> <ol style="list-style-type: none"> 1. Load the driver for the supported adapter. 2. Check that the adapter is seated properly in the slot and try loading the AFT module again. <p>If the problem persists, contact your network supplier.</p> |
| AFT is not supported on this version of NetWare. | <p>Explanation: The NetWare on your system is not a version supported by AFT.</p> <p>Action: Load and bind AFT only on supported versions of NetWare (currently version 4.11 and above).</p> |
| Failed to allocate resources tags. | <p>Explanation: An unknown error has occurred when trying to allocate needed resources for the AFT module.</p> <p>Action: Check system configuration. If the problem persists, contact your network supplier.</p> |

Table 13. NetWare driver messages for the Ethernet controller.

| Message | Description |
|---------------------------------------------------------|---------------------------------------------------------------------------------------------------------------------------------------------------------------------------------------------------|
| Please unload all LAN drivers before unloading AFT.NLM. | <p>Explanation: An attempt was made to unload the AFT.NLM module before unloading the adapter driver.</p> <p>Action: Unload the adapter driver before unloading the AFT module.</p> |

NDIS 4.0 Windows driver messages

This section contains the error messages for the NDIS 4.0 drivers. The explanation and recommended action are included with each message.

Table 14. NDIS (Windows NT) driver messages for the Ethernet controller.

| Error code (hex) | Description |
|------------------|--------------------------------------------------------------------------------------------------------------------------------------------------------------------------------------------------------------------------------------------------------------------------------------------------------------------------------------------------------------------------------------------------------------------------------------------------------------------|
| 0x00 | <p>Explanation: The driver could not register the specified interrupt.</p> <p>Action: Using the Configuration/Setup Utility program, make sure that a PCI interrupt is assigned to your Ethernet card, and that Ethernet is enabled.</p> |
| 0x01 | <p>Explanation: One of the PCI cards did not get the required resources.</p> <p>Action: Using the Configuration/Setup Utility program, make sure that a PCI interrupt is assigned to your Ethernet card, and that Ethernet is enabled.</p> |
| 0x02 | <p>Explanation: Bad node address (multicast address).</p> <p>Action: Make sure the locally administered address is valid, if one is specified. The address cannot be a multicast address.</p> |
| 0x03 | <p>Explanation: Failed self-test.</p> <p>Action: Make sure a cable is attached to the Ethernet connector. If the problem persists, call for service.</p> |
| 0x0D | <p>Explanation: Could not allocate enough memory for transmit queues.</p> <p>Action:</p> <ol style="list-style-type: none"> 1. From the Windows NT desktop, click Start → Control Panel → Networks → Adapters. 2. Select your IBM Ethernet adapter from the list. 3. Click Properties → Advanced. 4. Lower the resource values that apply to the transmit queue. |
| 0x0E | <p>Explanation: Could not allocate enough memory for receive queue.</p> <p>Action:</p> <ol style="list-style-type: none"> 1. From the Windows NT desktop, click Start → Control Panel → Networks → Adapters. 2. Select your IBM Ethernet adapter from the list. 3. Click Properties → Advanced. 4. Lower the resource values that apply to the receive queue. |
| 0x0F | <p>Explanation: Could not allocate enough memory for other structures.</p> <p>Action:</p> <ol style="list-style-type: none"> 1. From the Windows NT desktop, click Start → Control Panel → Networks → Adapters. 2. Select your IBM Ethernet adapter from the list. 3. Click Properties → Advanced. 4. Lower the value for the resource named in the message. |

Table 14. NDIS (Windows NT) driver messages for the Ethernet controller.

| Error code (hex) | Description |
|-----------------------------------------|------------------------------------------------------------------------------------------------------------------------------------------------------------------------------------------------------------------------------------------------------------------------------------------------------|
| 0x10 | Explanation: Did not find any Ethernet controllers. Action: Using the Configuration/Setup Utility program, make sure that Ethernet is enabled. |
| 0x11 | Explanation: Multiple Ethernet controllers found, but none matched the required ID. Action: Using the Configuration/Setup Utility program, make sure that Ethernet is enabled. |
| 0x13 | Explanation: Did not find any Ethernet controllers that matched the required subven/subdev. Action: Using the Configuration/Setup Utility program, make sure that Ethernet is enabled. |
| 0x16 | Explanation: Single adapter found, but multiple instances tried to load. Action: Using the Configuration/Setup Utility program, make sure that Ethernet is enabled, and that the slot containing the IBM 10/100 Ethernet Adapter or the IBM 10/100 Etherjet PCI adapter is enabled. |
| 0x17 | Explanation: Slot parameter not specified in the registry. Action: Remove the adapter driver and reinstall it. If the problem persists, call for service. |
| All other 4-character hexadecimal codes | Action: Call for service. |

Ethernet teaming messages

This section describes the messages associated with Ethernet teaming.

Table 15. NDIS (Windows NT) driver teaming messages for the Ethernet controller.

| Event ID | Type | Description |
|----------|---------------|------------------------------------------------------------------------------------------------------------------------------------------------------------------------------------------------------------------------|
| 01 | Error | Explanation: Team name and physical adapter name are the same. This is an invalid configuration. Action: Reconfigure the adapter team by double-clicking the PROSet icon in the control panel. |
| 02 | Error | Explanation: Unable to allocate required resources. Action: Free some memory resources and restart. |
| 03 | Error | Explanation: Unable to read required registry parameters. Action: Reconfigure the adapter team by double-clicking the PROSet icon in the control panel. |
| 04 | Error | Explanation: Unable to bind to physical adapter. Action: Reconfigure the adapter team by double-clicking the PROSet icon in the control panel. |
| 05 | Error | Explanation: Unable to initialize an adapter team. Action: Reconfigure the adapter team by double-clicking the PROSet icon in the control panel. |
| 06 | Informational | Explanation: Team <i>nn</i> . Primary adapter is initialized. Action: None. |
| 07 | Informational | Explanation: Team <i>nn</i> . Secondary adapter is initialized. Action: None. |

Table 15. NDIS (Windows NT) driver teaming messages for the Ethernet controller.

| Event ID | Type | Description |
|----------|---------------|---------------------------------------------------------------------------------------------------------------------------------------------------------------------------------------------------------------------------------------------------------|
| 08 | Informational | Explanation: Team <i>nn</i> . Virtual adapter or Team is initialized. Action: None. |
| 09 | Informational | Explanation: Team <i>nn</i> . Primary adapter is switching over. Action: None. |
| 10 | Warning | Explanation: Team <i>nn</i> . Adapter link down. Action: Make sure the adapter is functioning properly. |
| 11 | Informational | Explanation: Team <i>nn</i> . Secondary adapter took over. Action: None. |
| 12 | Warning | Explanation: Team <i>nn</i> . Secondary adapter is deactivated from the Team. Action: Make sure the secondary adapter is functioning properly and that the adapter cable is securely connected to the LAN. |
| 13 | Informational | Explanation: Team <i>nn</i> . Secondary adapter has rejoined the Team. Action: None. |
| 14 | Informational | Explanation: Team <i>nn</i> . Secondary adapter link is up. Action: None. |
| 15 | Error | Explanation: Team <i>nn</i> . The last adapter has lost its link. Network connection has been lost. Action: Shut down the server and replace the adapters; then, restart the server to reestablish the connection. |
| 16 | Informational | Explanation: Team <i>nn</i> . An adapter has reestablished the link. Network connection has been restored. Action: None. |
| 17 | Informational | Explanation: Team <i>nn</i> . Preferred primary adapter has been detected. Action: None. |
| 18 | Informational | Explanation: Team <i>nn</i> . Preferred secondary adapter has been detected. Action: None. |
| 19 | Informational | Explanation: Team <i>nn</i> . Preferred primary adapter took over. Action: None. |
| 20 | Informational | Explanation: Team <i>nn</i> . Preferred secondary adapter took over. Action: None. |
| 21 | Warning | Explanation: Team <i>nn</i> . Primary adapter does not sense any probes. Possible reason: partitioned Team. Action: Make sure the cables of the adapter team are connected to the same LAN segment. Reconfigure the team if necessary. |

Replacing the battery

When replacing the battery, you must replace it with a lithium battery of the same type from the same manufacturer. To avoid possible danger, read and follow the safety statement below.

To order replacement batteries, call 1-800-772-2227 within the United States, and 1-800-465-7999 or 1-800-465-6666 within Canada. Outside the U.S. and Canada, call your IBM reseller or IBM marketing representative.

Note: After you replace the battery, you must reconfigure your system and reset the system date and time.

Statement 2



CAUTION:

When replacing the lithium battery, use only IBM Part Number 33F8354 or an equivalent type battery recommended by the manufacturer. If your system has a module containing a lithium battery, replace it only with the same module type made by the same manufacturer. The battery contains lithium and can explode if not properly used, handled, or disposed of.

Do not:

- Throw or immerse into water.
- Heat to more than 100 C (212 F)
- Repair or disassemble

Dispose of the battery as required by local ordinances or regulations.

Do the following to replace the battery:

1. Follow any special handling and installation instructions supplied with the replacement battery.
2. Turn off the server and all the peripheral devices. Disconnect all external cables and power cords; then, remove the server cover.
3. Do the following to remove the battery:
 - a. Use one finger to press the top of the battery clip away from the battery until the battery releases upward from the socket.
 - b. Lift and remove the battery from the battery socket.

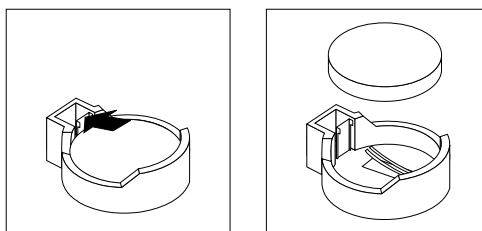

4. Do the following to insert the new battery:
 - a. Tilt the battery so that you can insert it into the socket on the side opposite the battery clip.

- b. Press the battery down into the socket until it clicks into place. Make sure the battery clip holds the battery securely.

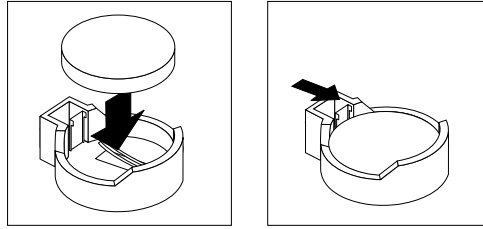

5. Reinstall the side cover (see “Installing the cover” on page 51 for details).
6. Reconnect the external cables and power cords; then, turn on the peripheral devices and the server.
7. Start the Configuration/Setup Utility program and set the system date and time, and the passwords, if necessary. Then, save the new configuration settings. See, Chapter 3, “Configuring your server,” on page 9 for complete details.

Chapter 7. Getting information, help, and service

If you need help, service, or technical assistance or just want more information about IBM products, you will find a wide variety of sources available from IBM to assist you. This section contains information about where to go for additional information about IBM and IBM products, what to do if you experience a problem with your computer, and whom to call for service should it be necessary.

Getting information

Information about your IBM server product and preinstalled software, if any, is available in the documentation that comes with your server. That documentation includes printed books, online books, README files, and help files. In addition, information about IBM products is available on the World Wide Web and through the IBM Automated Fax System.

Using the World Wide Web

On the World Wide Web, the IBM Web site has up-to-date information about IBM products and support. The address for the IBM Personal Computing home page is <http://www.ibm.com/pc/>.

You can find support information for your IBM products at <http://www.ibm.com/pc/support/>.

If you click **Profile** from the support page, you can create a customized support page that is specific to your hardware, complete with Frequently Asked Questions, Parts Information, Technical Hints and Tips, and Downloadable Files. In addition, you can choose to receive e-mail notifications whenever new information becomes available about your registered products.

You also can order publications through the IBM Publications Ordering System at <http://www.elink.ibm.com/public/applications/publications/cgibin/pbi.cgi>.

Getting information by fax

If you have a touch-tone telephone and access to a fax machine, in the U.S. and Canada, you can receive, by fax, marketing and technical information on many topics, including hardware, operating systems, and local area networks (LANs).

You can call the IBM Automated Fax System 24 hours a day, 7 days a week. Follow the recorded instructions, and the requested information will be sent to your fax machine. In the U.S. and Canada, to access the IBM Automated Fax System, call 1-800-426-3395.

Getting help and service

If you have a problem with your server product, you will find a wide variety of sources available to help you.

Using the documentation and diagnostic programs

Many problems can be solved without outside assistance. If you experience a problem with your server product, the first place to start is the troubleshooting information in your IBM documentation. If you suspect a software problem, see the documentation,

including README files and online help, that comes with the operating system or application program.

Most IBM server products come with a set of diagnostic programs that you can use to help you identify hardware problems. See the troubleshooting information in your IBM documentation for instructions on using the diagnostic programs.

The troubleshooting information or the diagnostic programs might tell you that you need additional or updated device drivers or other software. IBM maintains pages on the World Wide Web where you can get the latest technical information and download device drivers and updates. To access these pages, go to <http://www.ibm.com/pc/support/> and follow the instructions.

Calling for service

If you have tried to correct the problem yourself and still need help, during the warranty period, you can get help and information by telephone through the IBM HelpCenter®. The following services are available during the warranty period:

- **Problem determination** - Trained personnel are available to assist you with determining if you have a hardware problem and deciding what action is necessary to fix the problem.
- **IBM hardware repair** - If the problem is determined to be caused by IBM hardware under warranty, trained service personnel are available to provide the applicable level of service.
- **Engineering Change management** - Occasionally, there might be changes that are required after a product has been sold. IBM or your reseller, if authorized by IBM, will make selected Engineering Changes (ECs) available that apply to your hardware.

The following items are not covered:

- Replacement or use of non-IBM parts or nonwarranted IBM parts. All warranted parts contain a 7-character identification in the format IBM FRU XXXXXXX.
- Identification of software problem sources.
- Configuration of BIOS as part of an installation or upgrade.
- Changes, modifications, or upgrades to device drivers.
- Installation and maintenance of network operating systems (NOS).
- Installation and maintenance of application programs.

Refer to your IBM Statement of Limited Warranty for a full explanation of IBM warranty terms. Be sure to retain your proof of purchase to obtain warranty service.

In the U.S. and Canada, these services are available 24 hours a day, 7 days a week. In the U.K., these services are available Monday through Friday, from 9:00 a.m. to 6:00 p.m.

Note: Response time will vary depending on the number and complexity of incoming calls.

In addition, you are eligible for IBM Start Up Support for 90 days after installation. This service provides assistance for:

- Setting up your network operating system
- Installing and configuring interface adapters
- Installing and configuring network adapters

Please have the following information ready when you call:

- Machine type and model
- Serial numbers of your IBM hardware products

- Description of the problem
- Exact wording of any error messages
- Hardware and software configuration information

Telephone numbers

Phone numbers are subject to change without notice. For the most up-to-date phone numbers, go to <http://www.ibm.com/pc/support/> and click **Support Phone List**.

| Country | | Telephone number |
|------------------------|-------------------------|------------------|
| Austria | Österreich | 01-24 592 5901 |
| Belgium - Dutch | Belgie | 02-210 9820 |
| Belgium - French | Belgique | 02-210 9800 |
| Canada | Toronto only | 416-383-3344 |
| Canada | Canada - all other | 1-800-565-3344 |
| Denmark | Danmark | 45 20 82 00 |
| Finland | Suomi | 09-22 931 840 |
| France | France | 02 38 55 74 50 |
| Germany | Deutschland | 07032-1549 201 |
| Ireland | Ireland | 01-815 9202 |
| Italy | Italia | 02-482 9202 |
| Luxembourg | Luxembourg | 298-977 5063 |
| Netherlands | Nederland | 020-514 5770 |
| Norway | Norge | 23 05 32 40 |
| Portugal | Portugal | 21-791 51 47 |
| Spain | España | 91-662 49 16 |
| Sweden | Sverige | 08-477 4420 |
| Switzerland | Schweiz/Suisse/Svizzera | 058-333 0900 |
| United Kingdom | United Kingdom | 01475-555 055 |
| U.S.A. and Puerto Rico | U.S.A. and Puerto Rico | 1-800-772-2227 |

In all other countries or regions, contact your IBM reseller or IBM marketing representative.

Purchasing additional services

During and after the warranty period, you can purchase additional services, such as support for IBM and non-IBM hardware, operating systems, and application programs; network setup and configuration; upgraded or extended hardware repair services; and custom installations. Service availability and service name might vary by country or region.

For more information about these services, contact your IBM marketing representative.

Appendix A. Product warranty

This appendix contains the warranty period for your product, information about obtaining warranty service and support, and the IBM Statement of Limited Warranty.

Warranty period

Contact your place of purchase for warranty service information. Some IBM Machines are eligible for on-site warranty service depending on the country or region where service is performed or the machine type.

IBM @server xSeries 200VL - Machine Type 8481

| Country or region | Warranty period |
|-------------------|--------------------------------|
| All countries | Parts - 1 year, labor - 1 year |

IBM @server xSeries 200 - Machine Type 8479

| Country or region | Warranty period |
|----------------------------------|----------------------------------|
| United States, Canada, and Japan | Parts - 3 years, labor - 1 year |
| All other countries | Parts - 3 years, labor - 3 years |

Warranty service and support

With the original purchase of an IBM server product, you have access to extensive support. During the IBM Machine warranty period, you may call IBM or your reseller for problem-determination assistance under the terms of the IBM Statement of Limited Warranty.

The following services are available during the warranty period:

- **Problem determination** - Trained personnel are available to assist you with determining if you have a hardware problem and deciding what action is necessary to fix the problem.
- **IBM hardware repair** - If the problem is determined to be caused by IBM hardware under warranty, trained service personnel are available to provide the applicable level of service, either on-site or at an IBM service center as determined by IBM.
- **Engineering Change management** - Occasionally, there might be changes that are required after a product has been shipped from IBM. In those instances, IBM will make Engineering Changes (ECs) available that apply to your hardware.

The following items are not covered under warranty service:

- Replacement or use of non-IBM parts. All IBM parts contain a 7-character identification in the format IBM FRU XXXXXXX.
- Identification of non-IBM software problem sources.
- Installation of customer replaceable units (CRUs).
- Installation and configuration of machine code or licensed internal code that is designated as customer installable.

If you do not register your server with IBM, you might be required to present proof of purchase to obtain warranty service.

Before you call for service

You can solve many problems without outside assistance by following the troubleshooting procedures that IBM provides in the online help or in the publications that are provided with your server and software.

Most computers, operating systems, and application programs come with information that contains troubleshooting procedures and explanations of error messages and error codes. The information that comes with your server also describes the diagnostic tests that you can perform.

If you suspect a software problem, refer to the information for the operating system or application program.

Calling for service

Please have the following information ready:

- Machine type, model, and serial number
- Description of the problem
- Exact wording of any error messages
- Hardware and software configuration information

To find the telephone number for the HelpCenter™ nearest you, see "Telephone numbers" on page 97.

IBM Statement of Limited Warranty **Z125-4753-06 8/2000**

This warranty statement consists of two parts: Part 1 and Part 2. Be sure to read Part 1 and the country-unique terms in Part 2 that apply to your country or region.

Part 1 - General Terms

This Statement of Limited Warranty includes Part 1 - General Terms and Part 2 - Country-unique Terms. The terms of Part 2 replace or modify those of Part 1. The warranties provided by IBM in this Statement of Limited Warranty apply only to Machines you purchase for your use, and not for resale, from IBM or your reseller. The term "Machine" means an IBM machine, its features, conversions, upgrades, elements, or accessories, or any combination of them. The term "Machine" does not include any software programs, whether pre-loaded with the Machine, installed subsequently or otherwise. Unless IBM specifies otherwise, the following warranties apply only in the country where you acquire the Machine. Nothing in this Statement of Limited Warranty affects any statutory rights of consumers that cannot be waived or limited by contract. If you have any questions, contact IBM or your reseller.

The IBM Warranty for Machines

IBM warrants that each Machine 1) is free from defects in materials and workmanship and 2) conforms to IBM's Official Published Specifications ("Specifications"). The warranty period for a Machine is a specified, fixed period commencing on its Date of Installation. The date on your sales receipt is the Date of Installation unless IBM or your reseller informs you otherwise.

If a Machine does not function as warranted during the warranty period, and IBM or your reseller are unable to either 1) make it do so or 2) replace it with one that is at least functionally equivalent, you may return it to your place of purchase and your money will be refunded.

Extent of Warranty

The warranty does not cover the repair or exchange of a Machine resulting from misuse, accident, modification, unsuitable physical or operating environment, improper maintenance by you, or failure caused by a product for which IBM is not responsible. The warranty is voided by removal or alteration of Machine or parts identification labels.

THESE WARRANTIES ARE YOUR EXCLUSIVE WARRANTIES AND REPLACE ALL OTHER WARRANTIES OR CONDITIONS, EXPRESS OR IMPLIED, INCLUDING, BUT NOT LIMITED TO, THE IMPLIED WARRANTIES OR CONDITIONS OF MERCHANTABILITY AND FITNESS FOR A PARTICULAR PURPOSE. THESE WARRANTIES GIVE YOU SPECIFIC LEGAL RIGHTS AND YOU MAY ALSO HAVE OTHER RIGHTS WHICH VARY FROM JURISDICTION TO JURISDICTION. SOME JURISDICTIONS DO NOT ALLOW THE EXCLUSION OR LIMITATION OF EXPRESS OR IMPLIED WARRANTIES, SO THE ABOVE EXCLUSION OR LIMITATION MAY NOT APPLY TO YOU. IN THAT EVENT, SUCH WARRANTIES ARE LIMITED IN DURATION TO THE WARRANTY PERIOD. NO WARRANTIES APPLY AFTER THAT PERIOD.

Items Not Covered by Warranty

IBM does not warrant uninterrupted or error-free operation of a Machine.

Any technical or other support provided for a Machine under warranty, such as assistance via telephone with "how-to" questions and those regarding Machine set-up and installation, will be provided **WITHOUT WARRANTIES OF ANY KIND**.

Warranty Service

To obtain warranty service for a Machine, contact IBM or your reseller. If you do not register your Machine with IBM, you may be required to present proof of purchase.

During the warranty period, IBM or your reseller, if approved by IBM to provide warranty service, provides without charge certain types of repair and exchange service to keep Machines in, or restore them to, conformance with their Specifications. IBM or your reseller will inform you of the available types of service for a Machine based on its country of installation. At its discretion, IBM or your reseller will 1) either repair or exchange the failing Machine and 2) provide the service either at your location or a service center. IBM or your reseller will also manage and install selected engineering changes that apply to the Machine.

Some parts of IBM Machines are designated as Customer Replaceable Units (called "CRUs"), e.g., keyboards, memory, or hard disk drives. IBM ships CRUs to you for replacement by you. You must return all defective CRUs to IBM within 30 days of your receipt of the replacement CRU. You are responsible for downloading designated Machine Code and Licensed Internal Code updates from an IBM Internet Web site or from other electronic media, and following the instructions that IBM provides.

When warranty service involves the exchange of a Machine or part, the item IBM or your reseller replaces becomes its property and the replacement becomes yours. You represent that all removed items are genuine and unaltered. The replacement may not be new, but will be in good working order and at least functionally equivalent to the item replaced. The replacement assumes the warranty service status of the replaced

item. Many features, conversions, or upgrades involve the removal of parts and their return to IBM. A part that replaces a removed part will assume the warranty service status of the removed part.

Before IBM or your reseller exchanges a Machine or part, you agree to remove all features, parts, options, alterations, and attachments not under warranty service.

You also agree to

1. ensure that the Machine is free of any legal obligations or restrictions that prevent its exchange;
2. obtain authorization from the owner to have IBM or your reseller service a Machine that you do not own; and
3. where applicable, before service is provided:
 - a. follow the problem determination, problem analysis, and service request procedures that IBM or your reseller provides;
 - b. secure all programs, data, and funds contained in a Machine;
 - c. provide IBM or your reseller with sufficient, free, and safe access to your facilities to permit them to fulfill their obligations; and
 - d. inform IBM or your reseller of changes in a Machine's location.

IBM is responsible for loss of, or damage to, your Machine while it is 1) in IBM's possession or 2) in transit in those cases where IBM is responsible for the transportation charges.

Neither IBM nor your reseller is responsible for any of your confidential, proprietary or personal information contained in a Machine which you return to IBM or your reseller for any reason. You should remove all such information from the Machine prior to its return.

Limitation of Liability

Circumstances may arise where, because of a default on IBM's part or other liability, you are entitled to recover damages from IBM. In each such instance, regardless of the basis on which you are entitled to claim damages from IBM (including fundamental breach, negligence, misrepresentation, or other contract or tort claim), except for any liability that cannot be waived or limited by applicable laws, IBM is liable for no more than

1. damages for bodily injury (including death) and damage to real property and tangible personal property; and
2. the amount of any other actual direct damages, up to the charges (if recurring, 12 months' charges apply) for the Machine that is subject of the claim. For purposes of this item, the term "Machine" includes Machine Code and Licensed Internal Code.

This limit also applies to IBM's suppliers and your reseller. It is the maximum for which IBM, its suppliers, and your reseller are collectively responsible.

UNDER NO CIRCUMSTANCES IS IBM LIABLE FOR ANY OF THE FOLLOWING: 1) THIRD-PARTY CLAIMS AGAINST YOU FOR DAMAGES (OTHER THAN THOSE UNDER THE FIRST ITEM LISTED ABOVE); 2) LOSS OF, OR DAMAGE TO, YOUR RECORDS OR DATA; OR 3) SPECIAL, INCIDENTAL, OR INDIRECT DAMAGES OR FOR ANY ECONOMIC CONSEQUENTIAL DAMAGES, LOST PROFITS OR LOST SAVINGS, EVEN IF IBM, ITS SUPPLIERS OR YOUR RESELLER IS INFORMED OF THEIR POSSIBILITY. SOME JURISDICTIONS DO NOT ALLOW THE EXCLUSION OR LIMITATION OF INCIDENTAL OR CONSEQUENTIAL DAMAGES, SO THE ABOVE LIMITATION OR EXCLUSION MAY NOT APPLY TO YOU.

Governing Law

Both you and IBM consent to the application of the laws of the country in which you acquired the Machine to govern, interpret, and enforce all of your and IBM's rights, duties, and obligations arising from, or relating in any manner to, the subject matter of this Agreement, without regard to conflict of law principles.

Part 2 - Country-unique Terms

AMERICAS

BRAZIL

Governing Law: *The following is added after the first sentence:*

Any litigation arising from this Agreement will be settled exclusively by the court of Rio de Janeiro.

NORTH AMERICA

Warranty Service: *The following is added to this Section:*

To obtain warranty service from IBM in Canada or the United States, call 1-800-IBM-SERV (426-7378).

CANADA

Governing Law: *The following replaces "laws of the country in which you acquired the Machine" in the first sentence:*

laws in the Province of Ontario.

UNITED STATES

Governing Law: *The following replaces "laws of the country in which you acquired the Machine" in the first sentence:*

laws of the State of New York.

ASIA PACIFIC

AUSTRALIA

The IBM Warranty for Machines: *The following paragraph is added to this Section:*

The warranties specified in this Section are in addition to any rights you may have under the Trade Practices Act 1974 or other similar legislation and are only limited to the extent permitted by the applicable legislation.

Limitation of Liability: *The following is added to this Section:*

Where IBM is in breach of a condition or warranty implied by the Trade Practices Act 1974 or other similar legislation, IBM's liability is limited to the repair or replacement of the goods or the supply of equivalent goods. Where that condition or warranty relates to right to sell, quiet possession or clear title, or the goods are of a kind ordinarily acquired for personal, domestic or household use or consumption, then none of the limitations in this paragraph apply.

Governing Law: *The following replaces "laws of the country in which you acquired the Machine" in the first sentence:*

laws of the State or Territory.

CAMBODIA, LAOS, AND VIETNAM

Governing Law: *The following replaces "laws of the country in which you acquired the Machine" in the first sentence:*

laws of the State of New York.

The following is added to this Section:

Disputes and differences arising out of or in connection with this Agreement shall be finally settled by arbitration which shall be held in Singapore in accordance with the rules of the International Chamber of Commerce (ICC). The arbitrator or arbitrators designated in conformity with those rules shall have the power to rule on their own competence and on the validity of the Agreement to submit to arbitration. The arbitration award shall be final and binding for the parties without appeal and the arbitral award shall be in writing and set forth the findings of fact and the conclusions of law.

All proceedings shall be conducted, including all documents presented in such proceedings, in the English language. The number of arbitrators shall be three, with each side to the dispute being entitled to appoint one arbitrator.

The two arbitrators appointed by the parties shall appoint a third arbitrator before proceeding upon the reference. The third arbitrator shall act as chairman of the proceedings. Vacancies in the post of chairman shall be filled by the president of the ICC. Other vacancies shall be filled by the respective nominating party. Proceedings shall continue from the stage they were at when the vacancy occurred.

If one of the parties refuses or otherwise fails to appoint an arbitrator within 30 days of the date the other party appoints its, the first appointed arbitrator shall be the sole arbitrator, provided that the arbitrator was validly and properly appointed.

The English language version of this Agreement prevails over any other language version.

HONG KONG AND MACAU

Governing Law: *The following replaces "laws of the country in which you acquired the Machine" in the first sentence:*

laws of Hong Kong Special Administrative Region.

INDIA

Limitation of Liability: *The following replaces items 1 and 2 of this Section:*

1. liability for bodily injury (including death) or damage to real property and tangible personal property will be limited to that caused by IBM's negligence;
2. as to any other actual damage arising in any situation involving nonperformance by IBM pursuant to, or in any way related to the subject of this Statement of Limited Warranty, IBM's liability will be limited to the charge paid by you for the individual Machine that is the subject of the claim.

JAPAN

Governing Law: *The following sentence is added to this Section:*

Any doubts concerning this Agreement will be initially resolved between us in good faith and in accordance with the principle of mutual trust.

NEW ZEALAND

The IBM Warranty for Machines: *The following paragraph is added to this Section:*

The warranties specified in this Section are in addition to any rights you may have under the Consumer Guarantees Act 1993 or other legislation which cannot be

excluded or limited. The Consumer Guarantees Act 1993 will not apply in respect of any goods which IBM provides, if you require the goods for the purposes of a business as defined in that Act.

Limitation of Liability: *The following is added to this Section:*

Where Machines are not acquired for the purposes of a business as defined in the Consumer Guarantees Act 1993, the limitations in this Section are subject to the limitations in that Act.

PEOPLE'S REPUBLIC OF CHINA (PRC)

Governing Law: *The following replaces this Section:*

Both you and IBM consent to the application of the laws of the State of New York (except when local law requires otherwise) to govern, interpret, and enforce all your and IBM's rights, duties, and obligations arising from, or relating in any manner to, the subject matter of this Agreement, without regard to conflict of law principles.

Any disputes arising from or in connection with this Agreement will first be resolved by friendly negotiations, failing which either of us has the right to submit the dispute to the China International Economic and Trade Arbitration Commission in Beijing, the PRC, for arbitration in accordance with its arbitration rules in force at the time. The arbitration tribunal will consist of three arbitrators. The language to be used therein will be English and Chinese. An arbitral award will be final and binding on all the parties, and will be enforceable under the Convention on the Recognition and Enforcement of Foreign Arbitral Awards (1958).

The arbitration fee will be borne by the losing party unless otherwise determined by the arbitral award.

During the course of arbitration, this Agreement will continue to be performed except for the part which the parties are disputing and which is undergoing arbitration.

EUROPE, MIDDLE EAST, AFRICA (EMEA)

THE FOLLOWING TERMS APPLY TO ALL EMEA COUNTRIES:

The terms of this Statement of Limited Warranty apply to Machines purchased from IBM or an IBM reseller.

Warranty Service:

If you purchase an IBM Machine in Austria, Belgium, Denmark, Estonia, Finland, France, Germany, Greece, Iceland, Ireland, Italy, Latvia, Lithuania, Luxembourg, Netherlands, Norway, Portugal, Spain, Sweden, Switzerland or United Kingdom, you may obtain warranty service for that Machine in any of those countries from either (1) an IBM reseller approved to perform warranty service or (2) from IBM. If you purchase an IBM Personal Computer Machine in Albania, Armenia, Belarus, Bosnia and Herzegovina, Bulgaria, Croatia, Czech Republic, Georgia, Hungary, Kazakhstan, Kirghizia, Federal Republic of Yugoslavia, Former Yugoslav Republic of Macedonia (FYROM), Moldova, Poland, Romania, Russia, Slovak Republic, Slovenia, or Ukraine, you may obtain warranty service for that Machine in any of those countries from either (1) an IBM reseller approved to perform warranty service or (2) from IBM.

If you purchase an IBM Machine in a Middle Eastern or African country, you may obtain warranty service for that Machine from the IBM entity within the country of purchase, if that IBM entity provides warranty service in that country, or from an IBM reseller, approved by IBM to perform warranty service on that Machine in that country. Warranty service in Africa is available within 50 kilometers of an IBM authorized

service provider. You are responsible for transportation costs for Machines located outside 50 kilometers of an IBM authorized service provider.

Governing Law:

The applicable laws that govern, interpret and enforce rights, duties, and obligations of each of us arising from, or relating in any manner to, the subject matter of this Statement, without regard to conflict of laws principles, as well as Country-unique terms and competent court for this Statement are those of the country in which the warranty service is being provided, except that in 1) Albania, Bosnia-Herzegovina, Bulgaria, Croatia, Hungary, Former Yugoslav Republic of Macedonia, Romania, Slovakia, Slovenia, Armenia, Azerbaijan, Belarus, Georgia, Kazakhstan, Kyrgyzstan, Moldova, Russia, Tajikistan, Turkmenistan, Ukraine, and Uzbekistan, the laws of Austria apply; 2) Estonia, Latvia, and Lithuania, the laws of Finland apply; 3) Algeria, Benin, Burkina Faso, Cameroon, Cape Verde, Central African Republic, Chad, Congo, Djibouti, Democratic Republic of Congo, Equatorial Guinea, France, Gabon, Gambia, Guinea, Guinea-Bissau, Ivory Coast, Lebanon, Mali, Mauritania, Morocco, Niger, Senegal, Togo, and Tunisia, this Agreement will be construed and the legal relations between the parties will be determined in accordance with the French laws and all disputes arising out of this Agreement or related to its violation or execution, including summary proceedings, will be settled exclusively by the Commercial Court of Paris; 4) Angola, Bahrain, Botswana, Burundi, Egypt, Eritrea, Ethiopia, Ghana, Jordan, Kenya, Kuwait, Liberia, Malawi, Malta, Mozambique, Nigeria, Oman, Pakistan, Qatar, Rwanda, Sao Tome, Saudi Arabia, Sierra Leone, Somalia, Tanzania, Uganda, United Arab Emirates, United Kingdom, West Bank/Gaza, Yemen, Zambia, and Zimbabwe, this Agreement will be governed by English Law and disputes relating to it will be submitted to the exclusive jurisdiction of the English courts; and 5) in Greece, Israel, Italy, Portugal, and Spain any legal claim arising out of this Statement will be brought before, and finally settled by, the competent court of Athens, Tel Aviv, Milan, Lisbon, and Madrid, respectively.

THE FOLLOWING TERMS APPLY TO THE COUNTRY SPECIFIED:

AUSTRIA AND GERMANY

The IBM Warranty for Machines: *The following replaces the first sentence of the first paragraph of this Section:*

The warranty for an IBM Machine covers the functionality of the Machine for its normal use and the Machine's conformity to its Specifications.

The following paragraphs are added to this Section:

The minimum warranty period for Machines is six months. In case IBM or your reseller is unable to repair an IBM Machine, you can alternatively ask for a partial refund as far as justified by the reduced value of the unrepaired Machine or ask for a cancellation of the respective agreement for such Machine and get your money refunded.

Extent of Warranty: *The second paragraph does not apply.*

Warranty Service: *The following is added to this Section:*

During the warranty period, transportation for delivery of the failing Machine to IBM will be at IBM's expense.

Limitation of Liability: *The following paragraph is added to this Section:*

The limitations and exclusions specified in the Statement of Limited Warranty will not apply to damages caused by IBM with fraud or gross negligence and for express warranty.

The following sentence is added to the end of item 2:

IBM's liability under this item is limited to the violation of essential contractual terms in cases of ordinary negligence.

EGYPT

Limitation of Liability: *The following replaces item 2 in this Section:*

as to any other actual direct damages, IBM's liability will be limited to the total amount you paid for the Machine that is the subject of the claim. For purposes of this item, the term "Machine" includes Machine Code and Licensed Internal Code.

Applicability of suppliers and resellers (unchanged).

FRANCE

Limitation of Liability: *The following replaces the second sentence of the first paragraph of this Section:*

In such instances, regardless of the basis on which you are entitled to claim damages from IBM, IBM is liable for no more than: *(items 1 and 2 unchanged).*

IRELAND

Extent of Warranty: *The following is added to this Section:*

Except as expressly provided in these terms and conditions, all statutory conditions, including all warranties implied, but without prejudice to the generality of the foregoing all warranties implied by the Sale of Goods Act 1893 or the Sale of Goods and Supply of Services Act 1980 are hereby excluded.

Limitation of Liability: *The following replaces items one and two of the first paragraph of this Section:*

1. death or personal injury or physical damage to your real property solely caused by IBM's negligence; and
2. the amount of any other actual direct damages, up to 125 percent of the charges (if recurring, the 12 months' charges apply) for the Machine that is the subject of the claim or which otherwise gives rise to the claim.

Applicability of suppliers and resellers (unchanged).

The following paragraph is added at the end of this Section:

IBM's entire liability and your sole remedy, whether in contract or in tort, in respect of any default shall be limited to damages.

ITALY

Limitation of Liability: *The following replaces the second sentence in the first paragraph:*

In each such instance unless otherwise provided by mandatory law, IBM is liable for no more than:

1. *(unchanged)*
2. as to any other actual damage arising in all situations involving nonperformance by IBM pursuant to, or in any way related to the subject matter of this Statement of Warranty, IBM's liability, will be limited to the total amount you paid for the Machine that is the subject of the claim.

Applicability of suppliers and resellers (unchanged).

The following replaces the third paragraph of this Section:

Unless otherwise provided by mandatory law, IBM and your reseller are not liable for any of the following: *(items 1 and 2 unchanged)* 3) indirect damages, even if IBM or your reseller is informed of their possibility.

SOUTH AFRICA, NAMIBIA, BOTSWANA, LESOTHO AND SWAZILAND

Limitation of Liability: *The following is added to this Section:*

IBM's entire liability to you for actual damages arising in all situations involving nonperformance by IBM in respect of the subject matter of this Statement of Warranty will be limited to the charge paid by you for the individual Machine that is the subject of your claim from IBM.

UNITED KINGDOM

Limitation of Liability: *The following replaces items 1 and 2 of the first paragraph of this Section:*

1. death or personal injury or physical damage to your real property solely caused by IBM's negligence;
2. the amount of any other actual direct damages or loss, up to 125 percent of the charges (if recurring, the 12 months' charges apply) for the Machine that is the subject of the claim or which otherwise gives rise to the claim;

The following item is added to this paragraph:

3. breach of IBM's obligations implied by Section 12 of the Sale of Goods Act 1979 or Section 2 of the Supply of Goods and Services Act 1982.

Applicability of suppliers and resellers (unchanged).

The following is added to the end of this Section:

IBM's entire liability and your sole remedy, whether in contract or in tort, in respect of any default shall be limited to damages.

Appendix B. Notices

This publication was developed for products and services offered in the U.S.A.

IBM may not offer the products, services, or features discussed in this document in other countries. Consult your local IBM representative for information on the products and services currently available in your area. Any reference to an IBM product, program, or service is not intended to state or imply that only that IBM product, program, or service may be used. Any functionally equivalent product, program, or service that does not infringe any IBM intellectual property right may be used instead. However, it is the user's responsibility to evaluate and verify the operation of any non-IBM product, program, or service.

IBM may have patents or pending patent applications covering subject matter described in this document. The furnishing of this document does not give you any license to these patents. You can send license inquiries, in writing, to:

*IBM Director of Licensing
IBM Corporation
North Castle Drive
Armonk, NY 10504-1785
U.S.A.*

This information could include technical inaccuracies or typographical errors. Changes are periodically made to the information herein; these changes will be incorporated in new editions of the publication. IBM may make improvements and/or changes in the product(s) and/or the program(s) described in this publication at any time without notice.

INTERNATIONAL BUSINESS MACHINES CORPORATION PROVIDES THIS PUBLICATION "AS IS" WITHOUT WARRANTY OF ANY KIND, EITHER EXPRESS OR IMPLIED, INCLUDING, BUT NOT LIMITED TO, THE IMPLIED WARRANTIES OF NON-INFRINGEMENT, MERCHANTABILITY OR FITNESS FOR A PARTICULAR PURPOSE. Some states do not allow disclaimer of express or implied warranties in certain transactions, therefore, this statement may not apply to you.

Any references in this publication to non-IBM Web sites are provided for convenience only and do not in any manner serve as an endorsement of those Web sites. The materials at those Web sites are not part of the materials for this IBM product, and use of those Web sites is at your own risk.

IBM may use or distribute any of the information you supply in any way it believes appropriate without incurring any obligation to you.

Edition notice

**© COPYRIGHT INTERNATIONAL BUSINESS MACHINES CORPORATION, 2001.
All rights reserved.**

Note to U.S. Government Users — Documentation related to restricted rights — Use, duplication or disclosure is subject to restrictions set forth in GSA ADP Schedule Contract with IBM Corp.

Trademarks

The following terms are trademarks of International Business Machines Corporation in the United States, other countries, or both:

| | |
|------------------------|-----------------------------|
| Alert on LAN | Predictive Failure Analysis |
| Chipkill | ServeRAID |
| EtherJet | ServerGuide |
| e-business logo | ServerProven |
| HelpCenter | TechConnect |
| HelpWare | Tivoli |
| IBM | Tivoli Enterprise |
| Light Path Diagnostics | Update Connector |
| NetBAY | Wake on LAN |
| NetView | xSeries |
| OS/2 WARP | |

Lotus and Domino are trademarks of Lotus Development Corporation in the United States, other countries, or both.

Intel, Celeron, MMX, LANDesk, Pentium, Pentium II Xeon, and Pentium III Xeon are trademarks of Intel Corporation in the United States, other countries, or both.

Microsoft, Windows, and Windows NT are trademarks of Microsoft Corporation in the United States, other countries, or both.

UNIX is a registered trademark of The Open Group in the United States and other countries.

Java and all Java-based trademarks and logos are trademarks or registered trademarks of Sun Microsystems, Inc. in the United States, other countries, or both.

Other company, product, or service names may be the trademarks or service marks of others.

Important notes

Processor speeds indicate the internal clock speed of the microprocessor; other factors also affect application performance.

CD-ROM drive speeds list the variable read rate. Actual speeds vary and are often less than the maximum possible.

When referring to processor storage, real and virtual storage, or channel volume, KB stands for approximately 1000 bytes, MB stands for approximately 1000000 bytes, and GB stands for approximately 1000000000 bytes.

When referring to hard disk drive capacity or communications volume, MB stands for 1000000 bytes, and GB stands for 1000000000 bytes. Total user-accessible capacity may vary depending on operating environments.

Maximum internal hard disk drive capacities assume the replacement of any standard hard disk drives and population of all hard disk drive bays with the largest currently supported drives available from IBM.

Maximum memory may require replacement of the standard memory with an optional memory module.

IBM makes no representation or warranties regarding non-IBM products and services that are ServerProven, including but not limited to the implied warranties of merchantability and fitness for a particular purpose. These products are offered and warranted solely by third parties.

Unless otherwise stated, IBM makes no representations or warranties with respect to non-IBM products. Support (if any) for the non-IBM products is provided by the third party, not IBM.

Some software may differ from its retail version (if available), and may not include user manuals or all program functionality.

Electronic emission notices

Federal Communications Commission (FCC) statement

Note: This equipment has been tested and found to comply with the limits for a Class A digital device, pursuant to Part 15 of the FCC Rules. These limits are designed to provide reasonable protection against harmful interference when the equipment is operated in a commercial environment. This equipment generates, uses, and can radiate radio frequency energy and, if not installed and used in accordance with the instruction manual, may cause harmful interference to radio communications. Operation of this equipment in a residential area is likely to cause harmful interference, in which case the user will be required to correct the interference at his own expense.

Properly shielded and grounded cables and connectors must be used in order to meet FCC emission limits. IBM is not responsible for any radio or television interference caused by using other than recommended cables and connectors or by unauthorized changes or modifications to this equipment. Unauthorized changes or modifications could void the user's authority to operate the equipment.

This device complies with Part 15 of the FCC Rules. Operation is subject to the following two conditions: (1) this device may not cause harmful interference, and (2) this device must accept any interference received, including interference that may cause undesired operation.

Industry Canada Class A emission compliance statement

This Class A digital apparatus complies with Canadian ICES-003.

Avis de conformité à la réglementation d'Industrie Canada

Cet appareil numérique de la classe A est conforme à la norme NMB-003 du Canada.

Australia and New Zealand Class A statement

Attention: This is a Class A product. In a domestic environment this product may cause radio interference in which case the user may be required to take adequate measures.

United Kingdom telecommunications safety requirement

Notice to Customers

This apparatus is approved under approval number NS/G/1234/J/100003 for indirect connection to public telecommunication systems in the United Kingdom.

European Union EMC Directive conformance statement

This product is in conformity with the protection requirements of EU Council Directive 89/336/EEC on the approximation of the laws of the Member States relating to electromagnetic compatibility. IBM cannot accept responsibility for any failure to satisfy the protection requirements resulting from a nonrecommended modification of the product, including the fitting of non-IBM option cards.

This product has been tested and found to comply with the limits for Class A Information Technology Equipment according to CISPR 22/European Standard EN 55022. The Limits for Class A equipment were derived for commercial and industrial environments to provide reasonable protection against interference with licensed communication equipment.

Attention: This is a Class A product. In a domestic environment this product may cause radio interference in which case the user may be required to take adequate measures.

Taiwan electrical emission statement

警告使用者：
這是甲類的資訊產品，在
居住的環境中使用時，可
能會造成射頻干擾，在這
種情況下，使用者會被要
求採取某些適當的對策。

Japanese Voluntary Control Council for Interference (VCCI) statement

この装置は、情報処理装置等電波障害自主規制協議会（VCCI）の基準に基づくクラスA情報技術装置です。この装置を家庭環境で使用すると電波妨害を引き起こすことがあります。この場合には使用者が適切な対策を講ずるよう要求されることがあります。

Power cords

For your safety, IBM provides a power cord with a grounded attachment plug to use with this IBM product. To avoid electrical shock, always use the power cord and plug with a properly grounded outlet.

IBM power cords used in the United States and Canada are listed by Underwriter's Laboratories (UL) and certified by the Canadian Standards Association (CSA).

For units intended to be operated at 115 volts: Use a UL-listed and CSA-certified cord set consisting of a minimum 18 AWG, Type SVT or SJT, three-conductor cord, a maximum of 15 feet in length and a parallel blade, grounding-type attachment plug rated 15 amperes, 125 volts.

For units intended to be operated at 230 volts (U.S. use): Use a UL-listed and CSA-certified cord set consisting of a minimum 18 AWG, Type SVT or SJT, three-conductor cord, a maximum of 15 feet in length and a tandem blade, grounding-type attachment plug rated 15 amperes, 250 volts.

For units intended to be operated at 230 volts (outside the U.S.): Use a cord set with a grounding-type attachment plug. The cord set should have the appropriate safety approvals for the country in which the equipment will be installed.

IBM power cords for a specific country or region are usually available only in that country or region.

| IBM power cord part number | Used in these countries and regions |
|----------------------------|-----------------------------------------------------------------------------------------------------------------------------------------------------------------------------------------------------------------------------------------------------------------------------------------------------------------------------------------------------------------------------------------------------------------------------------------------------------------------------------------------------------------------------------------------------------------------------------------------------------------|
| 13F9940 | Argentina, Australia, China (PRC), New Zealand, Papua New Guinea, Paraguay, Uruguay, Western Samoa |
| 13F9979 | Afghanistan, Algeria, Andorra, Angola, Austria, Belgium, Benin, Bulgaria, Burkina Faso, Burundi, Cameroon, Central African Rep., Chad, China (Macau S.A.R.), Czech Republic, Egypt, Finland, France, French Guiana, Germany, Greece, Guinea, Hungary, Iceland, Indonesia, Iran, Ivory Coast, Jordan, Lebanon, Luxembourg, Malagasy, Mali, Martinique, Mauritania, Mauritius, Monaco, Morocco, Mozambique, Netherlands, New Caledonia, Niger, Norway, Poland, Portugal, Romania, Senegal, Slovakia, Spain, Sudan, Sweden, Syria, Togo, Tunisia, Turkey, former USSR, Vietnam, former Yugoslavia, Zaire, Zimbabwe |
| 13F9997 | Denmark |
| 14F0015 | Bangladesh, Burma, Pakistan, South Africa, Sri Lanka |
| 14F0033 | Antigua, Bahrain, Brunei, Channel Islands, China (Hong Kong S.A.R.), Cyprus, Dubai, Fiji, Ghana, India, Iraq, Ireland, Kenya, Kuwait, Malawi, Malaysia, Malta, Nepal, Nigeria, Polynesia, Qatar, Sierra Leone, Singapore, Tanzania, Uganda, United Kingdom, Yemen, Zambia |
| 14F0051 | Liechtenstein, Switzerland |
| 14F0069 | Chile, Ethiopia, Italy, Libya, Somalia |
| 14F0087 | Israel |
| 1838574 | Thailand |

| IBM power cord part number | Used in these countries and regions |
|-----------------------------------|----------------------------------------------------------------------------------------------------------------------------------------------------------------------------------------------------------------------------------------------------------------------------------------------------------------------------------------------------------------------------------|
| 6952301 | Bahamas, Barbados, Bermuda, Bolivia, Brazil, Canada, Cayman Islands, Colombia, Costa Rica, Dominican Republic, Ecuador, El Salvador, Guatemala, Guyana, Haiti, Honduras, Jamaica, Japan, Korea (South), Liberia, Mexico, Netherlands Antilles, Nicaragua, Panama, Peru, Philippines, Saudi Arabia, Suriname, Taiwan, Trinidad (West Indies), United States of America, Venezuela |

Index

A

- acoustical noise emissions 2
- adapter
 - boot option 36
 - considerations 36
 - installing 37
 - PCI 36
 - PCI bus 36
- adapter fault tolerance 57
- adapters
 - full length 36
- adaptive load balancing 57
- advanced configuration options 13
- advanced setup 11
- arranging workspace 7

B

- battery replacement 90
- bay
 - filler panel 42
- bays 1, 2, 3, or 4 41
- bays 5, 6, or 7 43
- bidirectional
 - parallel connector configuration 55
- BIOS, restoring 78

C

- cables
 - USB 61
- cabling
 - Ethernet 57
 - SCSI device 43, 44
 - SCSI requirements 63
- cache control 11
- CD-ROM
 - eject button 5
- CD-ROM drive 2
 - activity light 5
 - installing 40
- CD-ROM problems 79
- CDs
 - ServerGuide 18
- channels
 - SCSI 63
- chipset feature 11
- Cisco fast EtherChannel 57
- Class A electronic emission notice 111
- components
 - location of 23
- components, hardware 23
- configuration
 - with ServerGuide 19
- Configuration/Setup Utility 9

- main menu 10
- configure host adapter settings 13
- configuring
 - Ethernet 57
- configuring your server 9
- connector
 - USB 61
- connectors
 - Ethernet 57
 - external 52
 - input/output 52
 - keyboard 54
 - universal serial bus (USB) 61
- controls and indicators 5
- cooling 27
- core chipset control 11
- cover
 - installing 51
 - removing 34
- creating VLAN 59

D

- data rate
 - Ethernet 57
- date and time 11
- depth 2
- devices & I/O ports 10
- diagnostic
 - error code format 68
 - error message tables 71
 - programs and error messages 68
 - programs, starting 69
 - test log, viewing 69, 70
 - text messages 68
- diagnostic tools 65
- DIMM 45
 - installing 45
 - retaining clips 46
- DIMM connector
 - locations 45
- diskette
 - eject button 5
- diskette drive 2
 - activity light 5
 - installing 40
 - problem 79
- drive
 - bay filler panel 42
 - preinstallation 41
- drives
 - installing 40

E

- electrical input 2
- electronic emission Class A notice 111

- environment
 - air temperature 2
 - humidity 2
- error
 - diagnostic code format 68
- error messages
 - diagnostic 68, 71
- Ethernet
 - adapter fault tolerance 57
 - adaptive load balancing 57
 - cabling 57
 - Cisco Fast EtherChannel 57
 - configuring 57
 - creating VLAN 59
 - error messages 85
 - high performance modes 57
 - integrated on system board 57
 - IntraNetWare error messages 85
 - NetWare error messages 85
 - pin-number assignment 59
 - priority packet mode 58
 - priority filters 58
 - teaming 57
 - troubleshooting information 83
 - VLAN 59
 - Windows NT error messages 87
- Ethernet connector 57
 - pin-number assignments 59
- Ethernet controller 3
- Ethernet speed
 - activity light 5
- Ethernet transmit/receive
 - activity light 5
- exit without saving 12
- expansion bays 2
- expansion enclosure
 - problem 80
- expansion slots 2
- external connectors 25
- external options
 - connecting 52

F

- FCC Class A notice 111
- features
 - server 2, 3
 - ServerGuide 18
- filler panel 42
- filters
 - priority 58
- frequency control 11

H

- hard disk drive
 - activity light 5
 - installing 40
- hardware
 - problems 65

- hardware, major 23
- heat output 2
- height 2
- high priority queue 58
- host adapter
 - SCSI ID 13
 - SCSI termination 13
- host adapter settings, configure 13

I

- I/O connectors 53
- IDs
 - setting SCSI 63
- IEEE 802.1p tagging 58
- input/output connectors 52
- installing
 - adapters 37
 - battery 90
 - internal drives 40
 - memory modules 44
 - options 23
- integrated
 - Ethernet 57
 - SCSI 63
- integrated functions 2
- internal cable connectors 24
- internal drives
 - installing 40
- introduction 1

K

- keyboard
 - problem 80
 - speed 10
- keyboard connector 54
 - pin-number assignments 54

L

- load optimized defaults 12
- local area network
 - Ethernet 57

M

- maximum sync transfer rate 13
- memory
 - configuration changes 45
 - problem 80
 - settings 11
 - specifications 2
- memory module
 - installing 44
 - order of installation 45
 - specifications 2, 3

- supported 45
- messages
 - diagnostic error 68, 71
 - diagnostic text 68
 - Ethernet controller 85
- microprocessor
 - cache 11
 - installing 47
 - specifications 2
- model number 1
- modes
 - Ethernet 57
- mouse
 - problem 80
- mouse connector
 - pin-number assignments 54

N

- network connection
 - problems 83
- networks 57
- NOS installation
 - with ServerGuide 20
 - without ServerGuide 21
- notes, important 110
- notices
 - electronic emission 111
 - FCC, Class A 111
- number
 - model 1
 - serial 1

O

- option
 - problem 81
- options
 - installing 23

P

- parallel connector 54
 - pin-number assignments 55
- parallel port
 - problem 82
- parity checking, SCSI 13
- password
 - forgotten power-on 12
- passwords
 - using 12
- PCI
 - adapters 36
 - bus 0 36
 - expansion slots 36
- PCI configuration 11
- pin-number assignments
 - Ethernet 59
 - Ethernet connector 59

- keyboard connector 54
- mouse connector 54
- parallel connector 55
- SCSI connector 63
- serial connectors 56
- USB connectors 61
- pointing device
 - problem 80
- POST (power-on self-test) 67
- power
 - problem 82
- power control button 5
- power management setup 11
- power supply
 - specifications 2
- power-on light 5
- printer
 - problem 82
- priority filters 58
- priority levels 58
- priority packet mode 58
- problem
 - CD-ROM 79
 - diskette drive 79
 - hardware 65
 - intermittent 80
 - keyboard or mouse 80
 - memory 80
 - network connection 83
 - option 81
 - parallel port 82
 - power 82
 - printer 82
 - serial port 82
 - software 83
 - USB port 83
- problem solving 65
- product data 10
- PXE Boot Agent Utility 9

R

- RAS features 4
- reliability, system 27
- removable media drives
 - installing 40
- removing
 - side cover 34
 - support bracket 35
- retaining clips
 - DIMM 46
- ROM shadowing 11

S

- Safety vii, 28
- save and exit setup 12
- SCSI
 - adapter boot option 36
 - cabling requirements 63

- device 43
- disk utilities 13
 - RAID 63
 - setting IDs 63
- SCSI connector 63
 - pin-number assignments 63
- SCSI device configuration 13
- SCSI parity checking 13
- SCSISelect
 - boot device options 13
- SCSISelect menu
 - choices available 13
- SCSISelect Utility 9
- SCSISelect utility program
 - starting 12
 - using 12
- serial connectors 56
 - pin-number assignments 56
- serial number 1
- serial port
 - problem 82
- ServeRAID programs 9
- ServerGuide
 - additional programs 21
 - error symptoms 77
 - features 18
 - NOS installation 20
 - setting up multiple servers 20
 - using 17
- ServerGuide CDs 3, 9
- service summary 92, 95
- setting up
 - multiple servers 20
- setup
 - advanced 11
 - with ServerGuide 19
- side cover
 - removing 34
- size, server 2
- Slots See expansion slots 24
- software
 - problem 83
- software coupon
 - ServerGuide 17
- specifications
 - server 2
- start options 10
- startup sequence 11
- static-sensitive devices
 - handling 27
- support bracket
 - removing 35
- switches and jumpers 26
- system board
 - connectors
 - options 24
 - external connectors 25
 - internal cable connectors 24
 - switches and jumpers 26
- system management 3
- system reliability 27
- system security 11

system summary 10

T

- tape drive
 - installing 40
- teaming 57
- temperature
 - air 2
- test log
 - viewing diagnostic 69, 70
- thermal material
 - heat sink 49
- time and date 11
- trademarks 110
- traffic class expediting 58
- troubleshooting 65
 - Ethernet 83
- troubleshooting charts 79
- turning off the server 6
- turning on the server 6

U

- U5
 - connector 47
- United States electronic emission Class A notice 111
- United States FCC Class A notice 111
- universal serial bus ports 61
- USB connectors 61
 - pin-number assignments 61
- USB port
 - problem 83
- utility
 - Configuration/Setup 9
 - format disk 14
 - SCSI disk 13

V

- video controller
 - specifications 2
- virtual LAN (VLAN) 59
- virtual LAN mode (VLAN) 59
- virus-warning test 11
- VLAN, creating 59

W

- Web site
 - compatible options 45
 - ServerGuide 17
- weight 2
- width 2



Part Number: 32P0419

Printed in the United States of America.

32P0419

