



@server xSeries Hosting Appliance

(8672-26x)

Installation Guide

Welcome...

Thank you for buying an IBM @server xSeries Appliances server.

This *Installation Guide* contains information for setting up and configuring your appliance server.

You also can find the most current information about your server on the IBM Web site at: <http://www.ibm.com/pc/support>

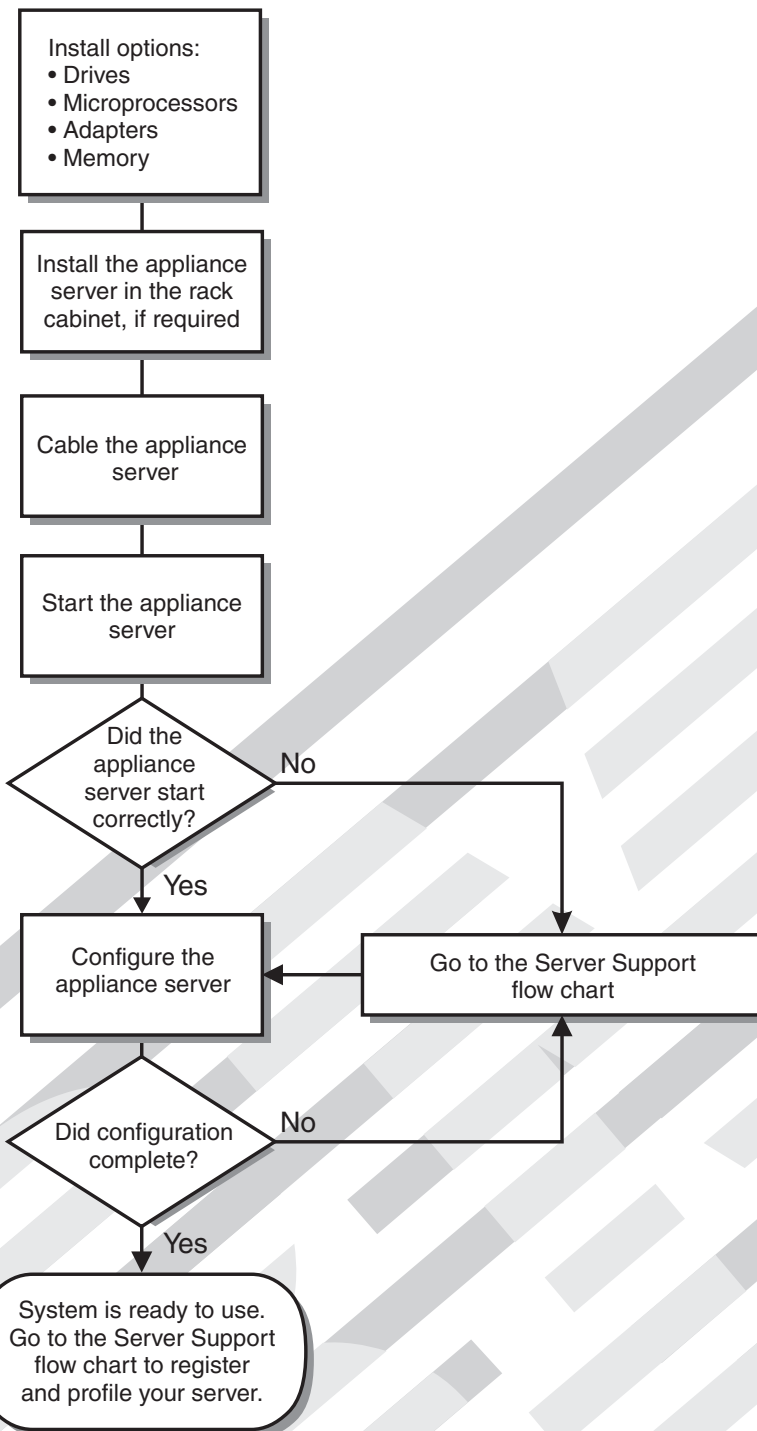

Server Support

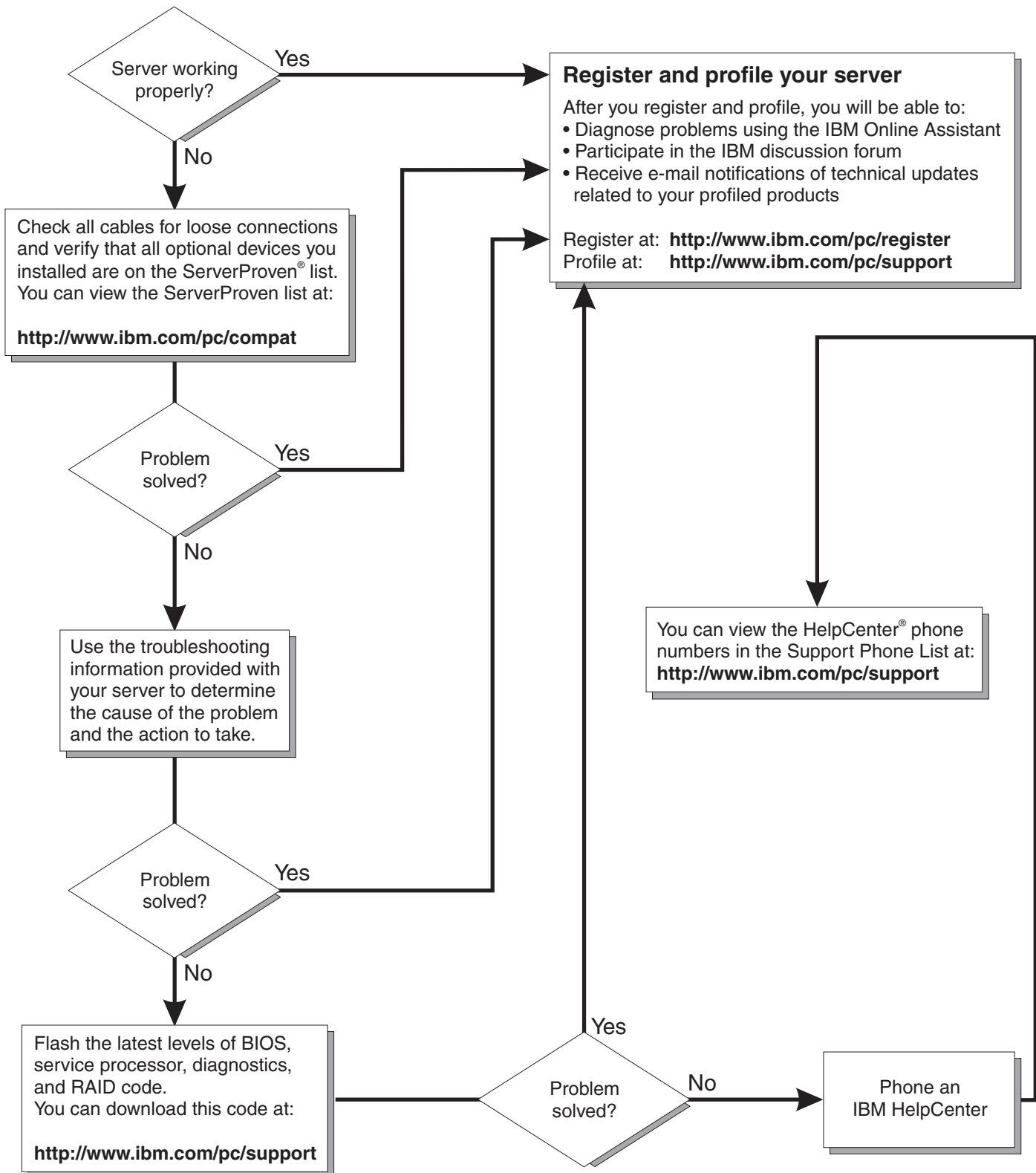

IBM @server xSeries Appliances



Installation Guide for xSeries Hosting Appliance

Note:

Before using this information and the product it supports, be sure to read the general information in “Product warranty and notices” on page 45.

First Edition (April 2002)

© Copyright International Business Machines Corporation 2002. All rights reserved.

US Government Users Restricted Rights – Use, duplication or disclosure restricted by GSA ADP Schedule Contract with IBM Corp.

Safety

Before installing this product, read the Safety Information.

قبل تركيب هذا المنتج، يجب قراءة الملاحظات الأمنية

Antes de instalar este produto, leia as Informações de Segurança.

在安装本产品之前，请仔细阅读 **Safety Information** (安全信息)。

安裝本產品之前，請先閱讀「安全資訊」。

Prije instalacije ovog produkta obavezno pročitajte Sigurnosne Upute.

Před instalací tohoto produktu si přečtěte příručku bezpečnostních instrukcí.

Læs sikkerhedsforskrifterne, før du installerer dette produkt.

Lees voordat u dit product installeert eerst de veiligheidsvoorschriften.

Ennen kuin asennat tämän tuotteen, lue turvaohjeet kohdasta Safety Information.

Avant d'installer ce produit, lisez les consignes de sécurité.

Vor der Installation dieses Produkts die Sicherheitshinweise lesen.

Πριν εγκαταστήσετε το προϊόν αυτό, διαβάστε τις πληροφορίες ασφάλειας (safety information).

לפני שתתקינו מוצר זה, קראו את הוראות הבטיחות.

A termék telepítése előtt olvassa el a Biztonsági előírásokat!

Prima di installare questo prodotto, leggere le Informazioni sulla Sicurezza.

製品の設置の前に、安全情報をお読みください。

본 제품을 설치하기 전에 안전 정보를 읽으십시오.

Пред да се инсталира овој продукт, прочитајте информацијата за безбедност.

Les sikkerhetsinformasjonen (Safety Information) før du installerer dette produktet.

Przed zainstalowaniem tego produktu, należy zapoznać się z książką "Informacje dotyczące bezpieczeństwa" (Safety Information).

Antes de instalar este produto, leia as Informações sobre Segurança.

Перед установкой продукта прочтите инструкции по технике безопасности.

Pred inštaláciou tohto zariadenia si pečítajte Bezpečnostné predpisy.

Pred namestitvijo tega proizvoda preberite Varnostne informacije.

Antes de instalar este producto, lea la información de seguridad.

Läs säkerhetsinformationen innan du installerar den här produkten.

Statement 1:



DANGER

Electrical current from power, telephone, and communication cables is hazardous. To avoid a shock hazard:

- **Do not connect or disconnect any cables or perform installation, maintenance, or reconfiguration of this product during an electrical storm.**
- **Connect all power cords to a properly wired and grounded electrical outlet.**
- **Connect to properly wired outlets any equipment that will be attached to this product.**
- **When possible, use one hand only to connect or disconnect signal cables.**
- **Never turn on any equipment when there is evidence of fire, water, or structural damage.**
- **Disconnect the attached power cords, telecommunications systems, networks, and modems before you open the device covers, unless instructed otherwise in the installation and configuration procedures.**
- **Connect and disconnect cables as described in the following table when installing, moving, or opening covers on this product or attached devices.**

To connect:

1. Turn everything OFF.
2. First, attach all cables to devices.
3. Attach signal cables to connectors.
4. Attach power cords to outlet.
5. Turn device ON.

To disconnect:

1. Turn everything OFF.
2. First, remove power cords from outlet.
3. Remove signal cables from connectors.
4. Remove all cables from devices.

Statement 2:

CAUTION:



When replacing the lithium battery, use only IBM Part Number 33F8354 or an equivalent type battery recommended by the manufacturer. If your system has a module containing a lithium battery, replace it only with the same module type made by the same manufacturer. The battery contains lithium and can explode if not properly used, handled, or disposed of.

Do not:

- Throw or immerse into water.
- Heat to more than 100 C (212 F)
- Repair or disassemble

Dispose of the battery as required by local ordinances or regulations.

Statement 3:



CAUTION:

When laser products (such as CD-ROMs, DVD drives, fiber optic devices, or transmitters) are installed, note the following:

- Do not remove the covers. Removing the covers of the laser product could result in exposure to hazardous laser radiation. There are no serviceable parts inside the device.
- Use of controls or adjustments or performance of procedures other than those specified herein might result in hazardous radiation exposure.



DANGER

Some laser products contain an embedded Class 3A or Class 3B laser diode. Note the following. Laser radiation when open. Do not stare into the beam, do not view directly with optical instruments, and avoid direct exposure to the beam.

Statement 4:



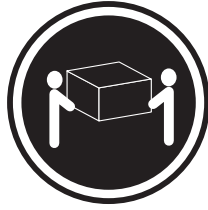

≥18 kg (37 lbs)



≥32 kg (70.5 lbs)



≥55 kg (121.2 lbs)

CAUTION:

Use safe practices when lifting.

Statement 5:

CAUTION:



The power control button on the device and the power switch on the power supply do not turn off the electrical current supplied to the device. The device also might have more than one power cord. To remove all electrical current from the device, ensure that all power cords are disconnected from the power source.

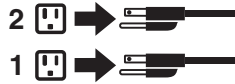

Statement 8:



CAUTION:

Never remove the cover on a power supply or any part that has the following label attached.



Hazardous voltage, current, and energy levels are present inside any component that has this label attached. There are no serviceable parts inside these components. If you suspect a problem with one of these parts, contact a service technician.

Contents

Safety	vi
-------------------------	-----------

Chapter 1. Introduction	1
Notices and statements used in this book.	2
System requirements.	3
Software on the xSeries Hosting Appliance	3
The IBM xSeries Hosting Appliance	5
Features and specifications.	5
Controls and indicators on the xSeries Hosting Appliance	6

Chapter 2. Installing your xSeries Hosting Appliance	9
Before you begin	9
Handling static-sensitive devices.	9
Removing the cover	10
Installing hard disk drives	11
Installing an IDE hard disk drive as part of the RAID array	11
Installing an IDE hard disk drive for storage	12
Installing memory	14
Replacing the cover.	16
Installing the xSeries Hosting Appliance in a rack cabinet	16
Cabling the xSeries Hosting Appliance	16
Turning on and turning off your server	18
Turning on the xSeries Hosting Appliance	18
Turning off the xSeries Hosting Appliance	19
Standby mode	19

Chapter 3. Configuring your xSeries Hosting Appliance.	21
Setting the initial Internet protocol (IP) address	21
Setting the initial IP address using the Advanced Appliance Configuration Utility	22
Setting the initial IP address using the command line	22
Installing and Configuring HostingDirector.	23
HostingDirector Post-Installation Configuration	24
Using the Configuration/Setup Utility program for the xSeries Hosting Appliance	27

Chapter 4. The Advanced Appliance Configuration Utility	29
--	-----------

Installing and starting the Advanced Appliance Configuration Utility	29
Using the group functions to manage your xSeries Hosting Appliances.	30
Creating a group	32
Moving an xSeries Hosting Appliance into a group	33
Removing xSeries Hosting Appliances from groups	33
Using the Assign by First Matching Group function	34
Restoring a factory image.	34
Restoring a factory image with the Advanced Appliance Configuration Utility	34
Restoring a factory image with the reload CD	34
Rescanning	35
Exporting and importing the database	35
Starting HostingDirector using the Advanced Appliance Configuration Utility	35

Chapter 5. Solving problems	37
Diagnostic tools overview	37
POST beep code descriptions	38
POST beep codes	38
Troubleshooting charts.	39

Appendix. Product warranty and notices.	45
IBM Statement of Limited Warranty	45
Part 1 - General Terms.	45
Part 2 - Country-unique Terms	47
Warranty information	53
Warranty period.	53
Notices	53
Edition notice	54
Processing date data	54
Trademarks	54
Important notes	56
Electronic emission notices	56
Power cords	58

Index	61
------------------------	-----------

Chapter 1. Introduction

Thank you for purchasing one of the IBM® @server xSeries Appliances. Your xSeries Hosting Appliance is identified in the table below:

Appliance	Machine Type/-Model
IBM @server xSeries Hosting Appliance	8672-26x

This *Installation Guide* provides the information that is needed to:

- Set up and cable your xSeries Hosting Appliance
- Start and configure your xSeries Hosting Appliance

The following items are also packaged with the *Installation Guide*:

- IBM @server xSeries Appliances *Documentation CD*
- IBM @server xSeries Appliances *Product Supplementary CD*
- IBM @server xSeries Appliances *Product Recovery CD*
- IBM @server xSeries Appliances *Diagnostic CD*
- Red Hat Linux® 7.1 *Source CD*
- *Rack Mounting Instructions* and template

Your xSeries Hosting Appliance serial number and model number are located on the ID label located on the right edge of the xSeries Hosting Appliance bezel as shown in Figure 1. You need these numbers for configuring your xSeries Hosting Appliance, and for registering your xSeries Hosting Appliance with IBM.

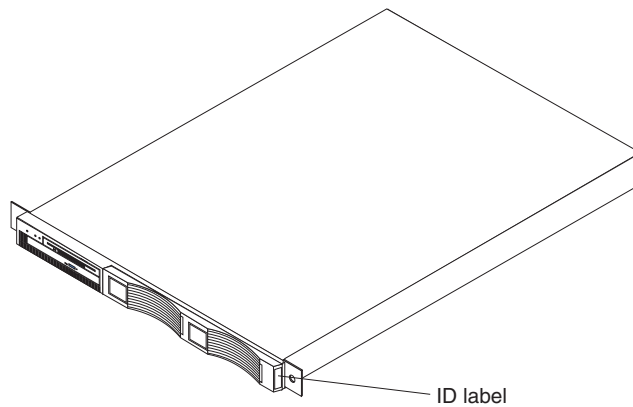

Figure 1. Locating the ID label

Note: The illustrations in this document might differ slightly from your hardware.

Notices and statements used in this book

The Caution and Danger statements described in “Safety” on page iii also appear in the multilingual safety information book provided on the *Documentation CD*. Each statement is numbered for easy reference to the corresponding statement in the safety book.

The notice and statement definitions are as follows:

- **Notes:** These notices provide important tips, guidance, or advice.
- **Important:** These notices provide information or advice that might help you avoid inconvenient or problem situations.
- **Attention:** These notices indicate possible damage to programs, devices, or data. An attention notice is placed just before the instruction or situation in which damage could occur.
- **Caution:** These statements indicate situations that can be potentially hazardous to you. A caution statement is placed just before the description of a potentially hazardous procedure step or situation.
- **Danger:** These statements indicate situations that can be potentially lethal or extremely hazardous to you. A danger statement is placed just before the description of a potentially lethal or extremely hazardous procedure step or situation.

System requirements

You must have a supported Web browser installed on your remote workstation to communicate with the xSeries Hosting Appliance through the Appliance System Manager. The supported browsers are Microsoft® Internet Explorer 5.x, or Netscape Communicator 4.6 or 6.2.

The IBM Advanced Appliance Configuration Utility agent is pre installed on the xSeries Hosting Appliance. You can use the Advanced Appliance Configuration Utility to manage one or more xSeries Hosting Appliances. You must install the Advanced Appliance Configuration Utility console from the *Product Supplementary* CD on the remote workstation you are using to manage the xSeries Hosting Appliance.

Note: The remote workstation running the Advanced Appliance Configuration Utility must be on the same physical subnet as the xSeries Hosting Appliance.

Software on the xSeries Hosting Appliance

The following software is installed on the IBM @server xSeries Hosting Appliance v1.0. You might need to install additional components to use all of the software features.

- **Red Hat Linux version 7.1**

Red Hat Linux version 7.1 (kernel 2.4.9) is the pre installed operating system.

- **IBM Advanced Appliance Configuration Utility**

The Advanced Appliance Configuration Utility agent is pre installed on your xSeries Hosting Appliance. You must install the Advanced Appliance Configuration Utility console from the *Product Supplementary* CD on a remote workstation that is on the same physical subnet as your xSeries Hosting Appliance. The utility detects IBM @server xSeries Hosting Appliances on the network, and enables you to set up and manage the network configuration for one or multiple xSeries Hosting Appliances. The IBM Advanced Appliance Utility provides the following:

- Automatic discovery of xSeries Hosting Appliances
- Point-to-point management
- Installation and management of multiple xSeries Hosting Appliances
- Automatic assignment of static IP addresses from a specified range to newly installed xSeries Hosting Appliances
- The capability to remotely initiate a factory image restoration

- **Sphera HostingDirector for IBM Appliances, version 1.0**

HostingDirector is the management platform for hosting multiple virtual servers on an appliance; it is pre installed on your xSeries Hosting Appliance. HostingDirector provides the following:

- Virtual Dedicated Server (VDS) technology can provide up to 1000 virtual servers on a single appliance
- Software provisioning across virtual servers
- Reporting capability
- Security

- **IBM Director version 3.1**

IBM Director, a comprehensive workgroup hardware manager, gives you the tools you need to centrally manage xSeries servers, IBM NetVista desktops,

IntelliStation workstations, and ThinkPad notebooks, as well as non-IBM Intel® processor-based systems. It automates tasks such as taking inventory, monitoring, and alerting, and puts system health information at your fingertips.

The Director agent is pre installed on your appliance. If you are using IBM Director, the appliance should appear in your management console.

For performance reasons, if you are not using IBM Director in your enterprise, you should disable the IBM Director agent installed on your appliance.

To disable the agent:

1. Telnet to the appliance.
2. Log in as root.
3. From the session prompt, run the following script:
`/opt/CSM/scripts/twgenable.pl`

You can re enable the IBM Director appliance agent by doing the following:

1. Telnet to the appliance.
2. Log in as root.
3. From the session prompt, run the following script:
`/opt/CSM/scripts/twgenable.pl`

For more information on IBM Director, visit

http://www.pc.ibm.com/ww/eserver/xseries/systems_management/nfdir.html.

- **Legato Backup Agent**

A Legato backup agent is preinstalled on the xSeries Hosting Appliance. If you are already using Legato as part of your system backup strategy, you do not need to install and configure a Legato backup agent on the xSeries Hosting Appliance. However, you must supply your own license. A Legato client license is not provided with the appliance.

The IBM xSeries Hosting Appliance

This section provides general information about the xSeries Hosting Appliance.

Features and specifications

Table 1 provides a summary of the features and specifications for the IBM @server xSeries Hosting Appliance.

Table 1. Features and specifications for the xSeries Hosting Appliance

<p>Microprocessor:</p> <ul style="list-style-type: none"> • Intel[®] Celeron[™] 950 MHz processor • 128 KB Level-2 cache <p>Memory:</p> <ul style="list-style-type: none"> • Standard: 256 MB • Maximum: 1.5 GB • Type: PC133 MHz, ECC SDRAM, unregistered DIMMs only • Slots: Three dual inline • Supports 128 MB, 256 MB, and 512 MB DIMMs <p>Drives:</p> <ul style="list-style-type: none"> • Diskette: 1.44 MB • CD-ROM: 24-10X IDE • Hard drive: 40 GB IDE <p>Expansion bays:</p> <p>Two 3.5-inch slim-high bays for IDE hard disk drives (one available)</p> <p>Power supply:</p> <p>One 200 watt (110 or 220 V ac auto-sensing)</p>	<p>Video:</p> <ul style="list-style-type: none"> • S3 Savage 4 Pro video controller on the system board • Compatible with SVGA and VGA • 8 MB SDRAM video memory <p>Size:</p> <ul style="list-style-type: none"> • Height: 4.37 cm (1.75 in.) • Depth: 63.5 cm (25 in.) • Width: 44 cm (17.32 in.) • Maximum weight: 19.05 kg (42 lb) depending on your configuration <p>Integrated functions:</p> <ul style="list-style-type: none"> • Dual-channel bus-mastering IDE controller • Dual 10BASE-T/100BASE-TX Ethernet controllers on the system board • IDE RAID controller • One serial port • Keyboard port • Mouse port <p>Acoustical noise emissions:</p> <ul style="list-style-type: none"> • Sound power, idling: 6.6 bel maximum • Sound power, operating: 6.8 bel maximum 	<p>Environment:</p> <ul style="list-style-type: none"> • Air temperature: <ul style="list-style-type: none"> – Server on: 10° to 35° C (50.0° to 95.0° F). Altitude: 0 to 914 m (2998.7 ft) – Server on: 10° to 32° C (50.0° to 89.6° F). Altitude: 914 m (2998.7 ft) to 2133 m (6998.0 ft.) – Server off: -40° to 60° C (-104° to 140° F). Maximum altitude: 2133 m (6998.0 ft) • Humidity: <ul style="list-style-type: none"> – Server on: 8% to 80% – Server off: 5% to 100% <p>Heat output:</p> <p>Approximate heat output in British thermal unit (Btu) per hour:</p> <ul style="list-style-type: none"> • Minimum configuration: 171 Btu (50 watts) • Maximum configuration: 410 Btu (120 watts) <p>Electrical input:</p> <ul style="list-style-type: none"> • Sine-wave input (47-63 Hz) required • Input voltage low range: <ul style="list-style-type: none"> – Minimum: 90 V ac – Maximum: 137 V ac • Input voltage high range: <ul style="list-style-type: none"> – Minimum: 180 V ac – Maximum: 265 V ac • Input kilovolt-amperes (kVA) approximately: <ul style="list-style-type: none"> – Minimum: 0.095 kVA – Maximum: 0.213 kVA
---	--	--

Controls and indicators on the xSeries Hosting Appliance

The following sections identify the controls and indicators on the front and rear of the xSeries Hosting Appliance.

Front view

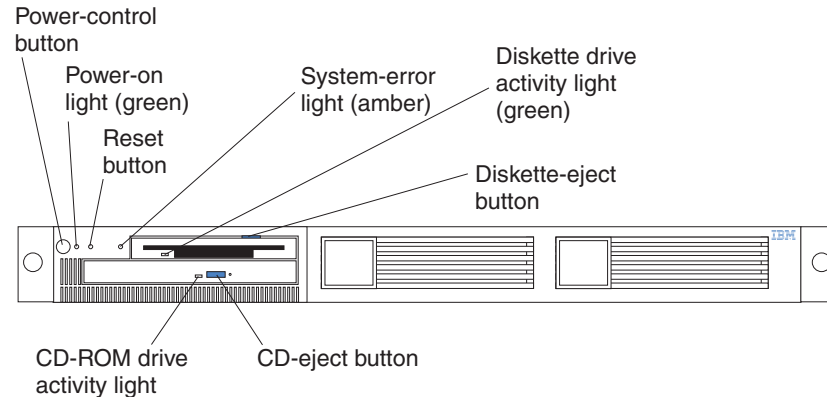

Figure 2. Identifying controls and indicators on the xSeries Hosting Appliance - front view

Power-control button: Press this button to manually turn on or turn off the xSeries Hosting Appliance.

Power-on light: This green LED lights and stays on when you turn on your xSeries Hosting Appliance, and blinks when the xSeries Hosting Appliance is in standby mode.

Reset button: Press this button to reset the xSeries Hosting Appliance and run the power-on self-test (POST).

System-error light: This amber LED lights when a system error occurs.

Diskette drive activity light: When this LED is on, it indicates that the diskette drive is in use.

Diskette-eject button: Push this button to release a diskette from the drive.

CD-eject button: Push this button to release a CD from the drive.

CD-ROM drive activity light: When this light is on, it indicates that the CD-ROM drive is in use.

Rear view

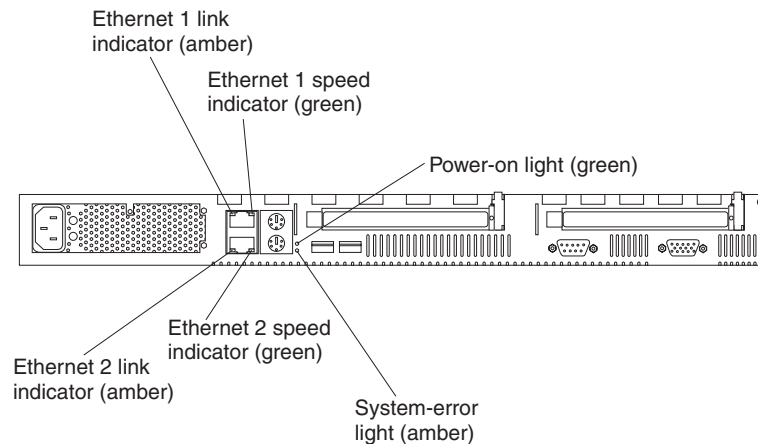

Figure 3. Identifying controls and indicators on the xSeries Hosting Appliance - back view

Ethernet 1 link indicator: This amber LED lights when there is an active link connection on the 10BASE-T or 100BASE-TX interface for Ethernet port 1.

Ethernet 1 speed indicator: This green LED lights when the speed of the Ethernet LAN that is connected to Ethernet port 1 is 100 Mbps.

Power-on light: This green LED lights and stays on when you turn on your xSeries Hosting Appliance and it will blink when the xSeries Hosting Appliance is in standby mode. This light duplicates the power-on light on the front of the xSeries Hosting Appliance.

System-error light: This amber LED lights when a system error occurs. This light duplicates the system-error light on the front of the xSeries Hosting Appliance.

Ethernet 2 speed indicator: This green LED lights when the speed of the Ethernet LAN connected to Ethernet port 2 is 100 Mbps.

Ethernet 2 link indicator: This amber LED lights when there is an active link connection on the 10BASE-T or 100BASE-TX interface for Ethernet port 2.

Chapter 2. Installing your xSeries Hosting Appliance

This chapter provides instructions for installing options in your xSeries Hosting Appliance, and installing the xSeries Hosting Appliance in a rack cabinet. For a list of supported options for your xSeries Hosting Appliance, see the ServerProven list at <http://www.ibm.com/pc/compat>. If you do not have any options to install, continue with “Installing the xSeries Hosting Appliance in a rack cabinet” on page 16.

Before you begin

To install options in your xSeries Hosting Appliance, begin by reading the following information.

- Become familiar with the safety and handling guidelines specified under “Handling static-sensitive devices”, and read the safety statements in “Safety” on page iii. These guidelines will help you work safely while working with your xSeries Hosting Appliance or options.
- Have a keyboard, monitor, and mouse available.
- Make sure that you have an adequate number of properly grounded electrical outlets for your xSeries Hosting Appliance, monitor, and any other options that you intend to install.
- Have a small, flat-blade screwdriver available.
- Before you install an optional device in your xSeries Hosting Appliance, verify that IBM supports that device on your model. You can view the list of supported devices for your model at: <http://www.ibm.com/pc/us/compat>.

Handling static-sensitive devices

Attention: Static electricity can damage electronic devices and your system. To avoid damage, keep static-sensitive devices in their static-protective packages until you are ready to install them. To reduce the possibility of electrostatic discharge, observe the following precautions:

- Limit your movement. Movement can cause static electricity to build up around you.
- Handle the device carefully, holding it by its edges or its frame.
- Do not touch solder joints, pins, or exposed printed circuitry.
- Do not leave the device where others can handle and possibly damage the device.
- While the device is still in its static-protective package, touch it to an unpainted metal part of the unit for at least two seconds. (This drains static electricity from the package and from your body.)
- Remove the device from its package and install it directly into your system unit without setting it down. If it is necessary to set the device down, place it in its static-protective packaging. (If your device is an adapter, place it component side up.) Do not place the device on your system unit cover or on a metal table.
- Take additional care when handling devices during cold weather, because heating reduces indoor humidity and increases static electricity.

Removing the cover

Complete the following steps to remove the xSeries Hosting Appliance cover:

1. Review the information in “Safety” on page iii.
2. Turn off the xSeries Hosting Appliance and all attached devices and disconnect all external cables and power cords.
3. Remove the two screws from the rear of the xSeries Hosting Appliance.
4. Pull out on the cover-release lever at the back of the xSeries Hosting Appliance to release the cover.
5. Slide the cover back, then up and off the xSeries Hosting Appliance.

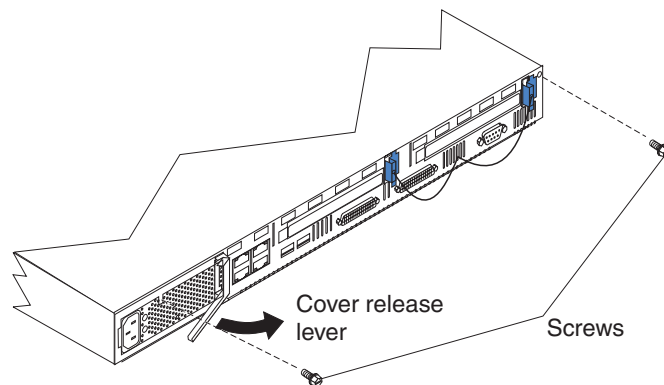

Figure 4. Removing the cover

Attention: For proper cooling and airflow, replace the cover before turning on the xSeries Hosting Appliance. Operating the xSeries Hosting Appliance for extended periods of time (over 30 minutes) with the cover removed might damage xSeries Hosting Appliance components.

Continue with “Installing hard disk drives” on page 11 and “Installing memory” on page 14.

Installing hard disk drives

Your appliance supports up to two IDE hard disk drives. You can add a second hard disk drive to the appliance in one of the following configurations:

- RAID

The appliance is shipped with one IDE hard disk drive connected to an IDE RAID adapter. This hard disk drive is configured for RAID 0 mode (no redundancy). Adding a second hard disk drive of equal or greater storage capacity to the RAID adapter enables you to configure for RAID 1 mode (disk mirroring). Upon restarting the appliance, the system automatically configures to RAID 1 mode.

- Storage

Alternatively, you can install a second hard disk drive and connect it to the secondary IDE port of the motherboard of the appliance. Hard disk drives installed on the secondary IDE port do not become part of the RAID array and are only used as additional storage space. After installation, HostingDirector will detect the additional hard disk drive and prompt you to mount and partition it for additional storage.

Note: If a factory reload is performed on the appliance, all contents of the storage drive are erased.

Before you install a hard disk drive, review the following:

- Inspect the drive or drive tray for any signs of damage.
- To maintain proper system cooling, do not operate the xSeries Hosting Appliance for more than two minutes without either a drive or a filler panel installed in each bay.
- Review the information in “Handling static-sensitive devices” on page 9.
- Check the instructions that come with the drive for more information about installing your drive.

Installing an IDE hard disk drive as part of the RAID array

Complete the following steps to install an IDE hard disk drive in the xSeries Hosting Appliance as part of the RAID array:

1. Review the information in “Safety” on page iii.
2. Turn off the xSeries Hosting Appliance and disconnect all external cables and power cords.
3. Set the drive to primary (master). Refer to the documentation that comes with the drive for instructions.
4. Remove the filler panel from the available hard disk drive bay.
5. Install the new hard disk drive in the drive bay:
 - a. Slide the drive into the bay, with the screw holes in the drive facing up, and align the screw holes in the drive with the screw holes in the xSeries Hosting Appliance chassis.
 - b. Use a screwdriver to drive the screws into the drive and secure it to the xSeries Hosting Appliance chassis.

Note: You might have to hold the drive up and in place to carefully align the drive with the screw holes in the chassis.

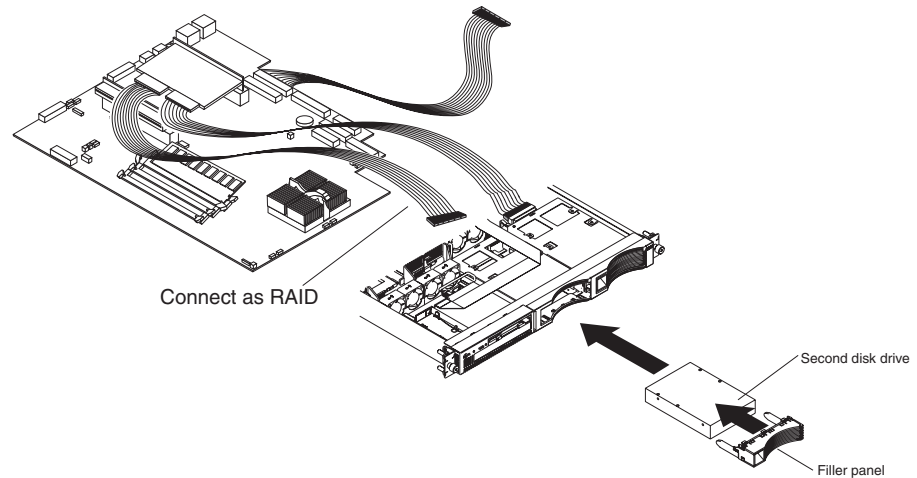

Figure 5. Installing the hard drive as RAID

- c. Attach the signal cable to the available interface tab of the RAID adapter card. Connect signal and power cables to the rear of the drive. Be sure to keep the signal cable and power cable clear of the path of the fan behind the drive bay.
6. If you have other options to install, install them now.

Continue with “Installing memory” on page 14, or “Replacing the cover” on page 16.

Installing an IDE hard disk drive for storage

Complete the following steps to install an IDE hard disk drive in the xSeries Hosting Appliance for storage purposes:

1. Review the information in “Safety” on page iii.
2. Turn off the xSeries Hosting Appliance and disconnect all external cables and power cords.
3. Set the drive to primary (master). Refer to the documentation that comes with the drive for instructions.
4. Remove the filler panel from the available hard disk drive bay.
5. Install the new hard disk drive in the drive bay:
 - a. Slide the drive into the bay, with the screw holes in the drive facing up, and align the screw holes in the drive with the screw holes in the xSeries Hosting Appliance chassis.
 - b. Use a screwdriver to drive the screws into the drive and secure it to the xSeries Hosting Appliance chassis.

Note: You might have to hold the drive up and in place to carefully align the drive with the screw holes in the chassis.

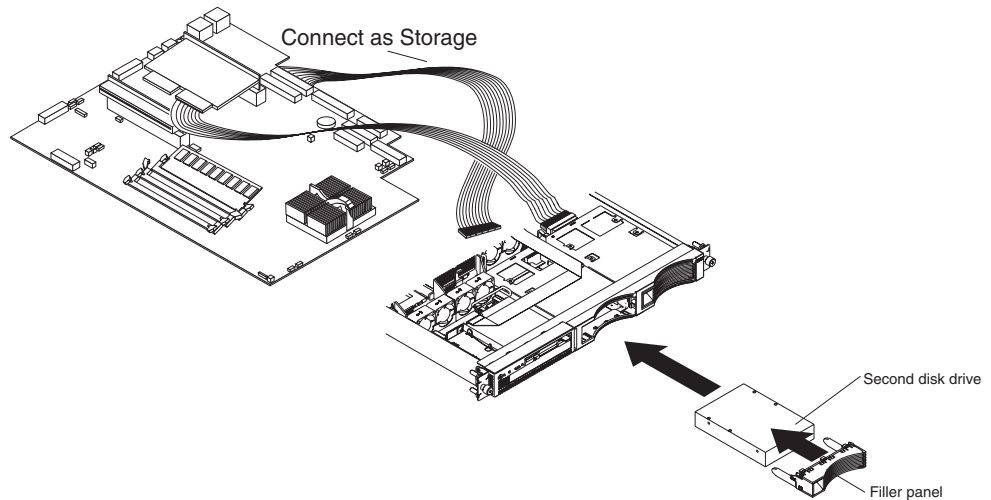

Figure 6. Installing the hard drive as storage

- c. Attach the signal cable to the secondary IDE port of the motherboard. Connect the signal and power cables to the rear of the drive. Be sure to keep the signal cable and power cable clear of the path of the fan behind the drive bay.
6. If you have other options to install, install them now.

Continue with "Installing memory" on page 14, or "Replacing the cover" on page 16.

Installing memory

Adding memory to your xSeries Hosting Appliance can improve system performance. You can increase the amount of memory in your xSeries Hosting Appliance by installing dual inline memory modules (DIMMs). Your xSeries Hosting Appliance uses a noninterleaved memory configuration, which enables you to add, remove, or replace one DIMM at a time. In an interleaved system you would have to add, remove, or replace memory in sets.

Your xSeries Hosting Appliance comes with a dual inline memory module (DIMM) installed on the system board in DIMM slot 1.

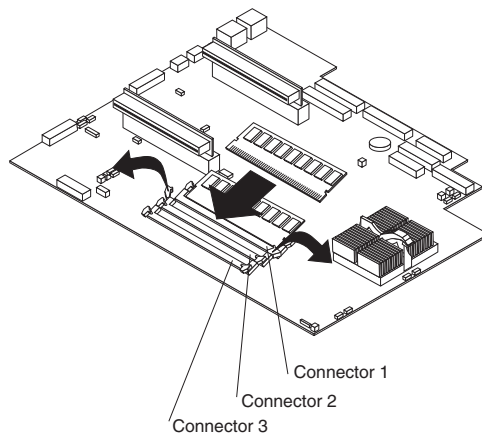

Figure 7. Installing memory

Note: Install additional DIMMs on the xSeries Hosting Appliance in the following order:

- DIMM connector 2
- DIMM connector 3

Complete the following steps to install a DIMM:

Attention: When you handle static-sensitive devices, take precautions to avoid damage from static electricity. For details on handling these devices, see “Handling static-sensitive devices” on page 9.

1. Review the information in “Safety” on page iii.
2. If necessary, remove the PCI adapter in slot 2 for easier access to the DIMM connectors.
3. Touch the static-protective package containing the DIMM to any unpainted metal surface on the xSeries Hosting Appliance. Then, remove the DIMM from the package.
4. Install the DIMM in the connector.

Attention: To prevent damage to the DIMM connectors, do not force the memory module into the connector.

- a. Turn the DIMM so that the index slots align correctly with the connector.

Note: The DIMM has two index slots, one in the center and the other on the left half of the DIMM connector edge.

- b. Insert the DIMM into the connector by pressing on both corners of the DIMM at the same time. Be sure to press straight into the connector.

Note: When installing a memory module, be sure that no gap exists between the DIMM and the retaining clips. If a gap does exist between the memory module and the retaining clips, remove the DIMM; then, reinsert the DIMM properly.

Attention: To avoid breaking the retaining clips or damaging the DIMM connectors, handle the clips gently.

5. If you removed the adapter from PCI slot 2, reinstall it.

Note: When you start the xSeries Hosting Appliance for the first time after adding memory, you must have a keyboard, monitor, and mouse connected to the xSeries Hosting Appliance. The system displays a message indicating that the memory configuration has changed.

- If you installed additional memory, start the Configuration/Setup Utility program, and select **Save Settings**. For more information, see “Using the Configuration/Setup Utility program for the xSeries Hosting Appliance” on page 27.
- If you just replaced a failed DIMM, you must start the Configuration/Setup Utility program, select **Advanced Setup**, select **Memory Settings**, highlight the connector or bank of connectors that you want to enable, and then select **Enable**.

6. If you have other options to install, install them now.

Replacing the cover

Complete the following steps to replace the xSeries Hosting Appliance cover:

1. Clear any cables that might impede the replacement of the clear shield or the cover.
2. Replace the clear shield, if it was removed.
3. Replace the cover by placing it into position and sliding it forward. Make sure that the cover engages the tabs at the front and rear of the xSeries Hosting Appliance.

Attention: Before sliding the cover forward, make sure that all of the tabs on the cover will engage the ledge at the front of the xSeries Hosting Appliance properly. If all the tabs do not engage the ledge properly, it will be extremely difficult to remove the cover later.

4. Insert the screws, and secure the cover as shown.

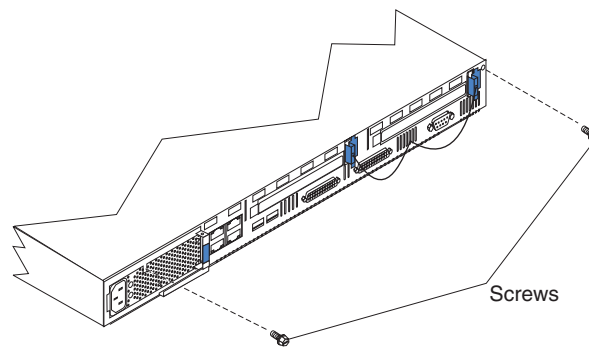

Figure 8. Replacing the cover

Continue with "Installing the xSeries Hosting Appliance in a rack cabinet".

Installing the xSeries Hosting Appliance in a rack cabinet

Install the xSeries Hosting Appliance in the rack cabinet using the *Rack Mounting Instructions* and template that come with your xSeries Hosting Appliance. Then, return to this manual and continue with "Cabling the xSeries Hosting Appliance".

Cabling the xSeries Hosting Appliance

Use the following illustration to cable the xSeries Hosting Appliance; then, go to "Turning on the xSeries Hosting Appliance" on page 18.

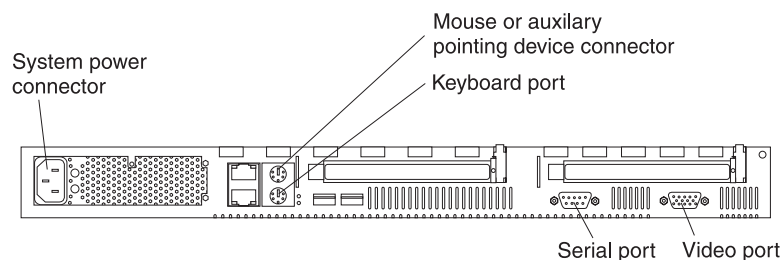

Figure 9. Locating the connectors

1. Plug an ethernet network cable into Ethernet port 1 of the xSeries Hosting Appliance (see Figure 3 on page 7).

2. Attach a power cord to the system power connector of the xSeries Hosting Appliance.

To effectively manage the cables on your xSeries Hosting Appliance, keep groups of cables secured together, and do not run cables across the back of the xSeries Hosting Appliance.

Notes:

1. Use cable straps to bundle like cables together.
2. Use cable straps to secure the cable bundles to the vertical rails of the rack cabinet.
3. When possible, separate data and power cables. For more information on cable routing, refer to the cabling instructions for your @server xSeries Hosting Appliance at <http://www.pc.ibm.com/support>.
4. Do not secure cables too tightly. Overtightening can cause internal damage to your cables.

Turning on and turning off your server

This section describes how to turn on and turn off the xSeries Hosting Appliance.

Turning on the xSeries Hosting Appliance

Statement 1:



DANGER

Electrical current from power, telephone, and communication cables is hazardous.

To avoid a shock hazard:

- Do not connect or disconnect any cables or perform installation, maintenance, or reconfiguration of this product during an electrical storm.
- Connect all power cords to a properly wired and grounded electrical outlet.
- Connect to properly wired outlets any equipment that will be attached to this product.
- When possible, use one hand only to connect or disconnect signal cables.
- Never turn on any equipment when there is evidence of fire, water, or structural damage.
- Disconnect the attached power cords, telecommunications systems, networks, and modems before you open the device covers, unless instructed otherwise in the installation and configuration procedures.
- Connect and disconnect cables as described in the following table when installing, moving, or opening covers on this product or attached devices.

To Connect:	To Disconnect:
<ol style="list-style-type: none">1. Turn everything OFF.2. Attach all cables to devices.3. Attach signal cables to connectors.4. Attach power cords to outlet.5. Turn device ON.	<ol style="list-style-type: none">1. Turn everything OFF.2. Remove power cords from outlet.3. Remove signal cables from connectors.4. Remove all cables from devices.

Complete the following steps to turn on the xSeries Hosting Appliance:

1. Plug the power cord of your xSeries Hosting Appliance into the power source.

Note: Plugging the power cord into a power source might cause the xSeries Hosting Appliance to start automatically.

2. Wait 30 seconds, and then press the power control button on the front of the xSeries Hosting Appliance.

Turning off the xSeries Hosting Appliance

Turning off the xSeries Hosting Appliance refers to the act of disconnecting the xSeries Hosting Appliance from the power source.

Statement 5:



CAUTION:

The power control button on the device and the power switch on the power supply do not turn off the electrical current supplied to the device. The device also might have more than one power cord. To remove all electrical current from the device, ensure that all power cords are disconnected from the power source.

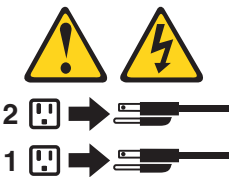

Complete the following steps to turn off the xSeries Hosting Appliance:

1. From HostingDirector, shutdown the appliance.
2. Press the power-control button on the front of the xSeries Hosting Appliance. This puts the xSeries Hosting Appliance into standby mode.
3. Disconnect the xSeries Hosting Appliance from the power source.

Note: After you turn off the xSeries Hosting Appliance, wait at least five seconds before you turn on the xSeries Hosting Appliance again.

Standby mode

Standby mode puts the xSeries Hosting Appliance into a wait state. When in a wait state, the xSeries Hosting Appliance is not running the operating system, and all core logic is shut down.

Complete the following steps to put the xSeries Hosting Appliance into standby mode:

1. From HostingDirector, shutdown the appliance.
2. Press the power-control button on the front of the xSeries Hosting Appliance.

Chapter 3. Configuring your xSeries Hosting Appliance

This chapter describes how to configure your IBM @server xSeries Hosting Appliance.

The appliance ships with a preloaded disk image that can be restored from the reload CDROM if it becomes damaged.

You can configure your xSeries Hosting Appliance remotely by using the IBM Advanced Appliance Configuration Utility, HostingDirector, or directly by attaching a network cable, monitor, keyboard, and mouse to the xSeries Hosting Appliance. For more information on cabling directly to your xSeries Hosting Appliance, see “Cabling the xSeries Hosting Appliance” on page 16.

Use the following general procedure to help you configure your xSeries Hosting Appliance:

1. Designate a workstation located on the same subnet as your appliance to remotely manage the xSeries Hosting Appliance.
2. Set the initial Internet protocol (IP) address through the IBM Advanced Appliance Configuration Utility or the appliance console as described in “Setting the initial IP address using the Advanced Appliance Configuration Utility” on page 22 or “Setting the initial IP address using the command line” on page 22.
3. Setup and configure HostingDirector from the IBM Advanced Appliance Configuration Utility as described in “Installing and Configuring HostingDirector” on page 23.

For instructions on installing and configuring the Advanced Appliance Configuration Utility, see Chapter 4, “The Advanced Appliance Configuration Utility” on page 29.

Setting the initial Internet protocol (IP) address

The appliance is shipped with a default IP address of 10.255.255.254 and a subnet mask of 255.0.0.0. While you can connect to the machine through HostingDirector using this information, you should use the IBM Advanced Appliance Configuration Utility to change the address before beginning Web management.

Note: Before you log on, ensure you have a valid IP address, net mask, host name, domain name, gateway, and primary DNS server address for the xSeries Hosting Appliance to use in your IP network. If you do not have this information, contact your network administrator.

As mentioned, you will typically use the IBM Advanced Appliance Configuration utility to configure the IP address for one or more xSeries Hosting Appliances. For configuring multiple servers, you can assign a range of addresses for a group of xSeries Hosting Appliances. When the xSeries Hosting Appliances are powered on, their initial network parameters are configured automatically. You must install the Advanced Appliance Configuration tool on a Windows machine that is on the same subnet as the xSeries Hosting Appliances.

Alternatively, you can set the initial IP address for an individual appliance using the command line. If a browser is not available and you plan to connect a keyboard and display to the xSeries Hosting Appliance, you can log into the xSeries Hosting Appliance, run the setup script, and answer questions to create the initial network configuration. After you restart the xSeries Hosting Appliance, it is ready to use with no further network configuration required.

Notes:

1. Although many management tasks, such as setting an IP address, can be accomplished by establishing a telnet session with the appliance and using native operating system utilities, you should perform administration tasks using HostingDirector and the Advanced Appliance Configuration Utility.
2. After you have configured the IP Address of the appliance and set up HostingDirector, you should not change the IP address of the appliance. Doing so will require you to perform a complete system restore.

Setting the initial IP address using the Advanced Appliance Configuration Utility

Complete the following steps to configure the IP address of the xSeries Hosting Appliance using the Advanced Appliance Configuration Utility:

1. Select a management workstation located on the same physical subnet as the appliance and insert the Supplementary CD. This workstation must have one of the following Web browsers installed:
 - Internet Explorer 4.x or higher
 - Netscape 4.6 or 6.2
2. Install the IBM Advanced Appliance Configuration utility by navigating to the IAAConfig directory on the CD and executing the setup.exe file.
3. Create a group for the xSeries Hosting Appliance. Select **Yes, allow group to assign network settings**, and then configure a range of IP addresses for the group. See “Creating a group” on page 32.
4. When the appliance starts for the first time on this subnet, it should automatically be assigned to the first matching group and receive an IP address. If it does not, refer to “Moving an xSeries Hosting Appliance into a group” on page 33 and assign the appliance to a group manually.
5. Select the xSeries Hosting Appliance in the left pane, and click **Start Web Management**. Type a user id of root and a password of password. An initial HostingDirector configuration window opens.
6. Continue with HostingDirector setup information contained in “Installing and Configuring HostingDirector” on page 23.

Note: The Advanced Appliance Configuration Utility configures and reports the TCP/IP settings of the first adapter on each xSeries Hosting Appliance only. The first adapter is the port 1 Ethernet controller. Be sure to connect the built-in Ethernet connector to the same subnet as your system running the Advanced Appliance Configuration Utility. Refer to the diagram listed in Figure 3 on page 7.

Setting the initial IP address using the command line

A command-line script is provided if a browser is not accessible. This script can be initiated through a Telnet session or from the appliance console. To use the command line to assign the initial IP address from the console, do the following:

1. Turn off the xSeries Hosting Appliance.

2. Attach a keyboard, mouse, and monitor to the xSeries Hosting Appliance.
3. Turn on the xSeries Hosting Appliance.
4. Log in to the xSeries Hosting Appliance using root as the user id and password as the password.
5. Make sure you are in the root directory and then type `/opt/CSM/scripts/setup.pl` and press **Enter**.
6. Respond to the following questions when prompted:

Root password:

- Type original password.
- Type new password.
- Confirm new password.

Host name for the xSeries Hosting Appliance:

Type your host name.

Domain name:

Type your domain name.

Network Interface for the appliance:

Select a Network Interface for the appliance. Select the number that corresponds to the ethernet adapter currently connected to the network (the primary adapter for your xSeries Hosting Appliance).

IP address:

Type your IP address.

Network mask:

Type your network mask.

Gateway (optional):

Type your gateway.

Primary domain name server (optional):

Type your primary domain name server.

Language:

Select the language for the appliance.

7. Verify the data you have entered and make any necessary changes.
8. Type 10 to exit the configuration and 1 to restart the xSeries Hosting Appliance.

Continue with HostingDirector setup information contained in “Installing and Configuring HostingDirector”.

Installing and Configuring HostingDirector

After you have configured the initial network settings of the appliance using the Advanced Appliance Configuration Utility, you are ready to use the Web browser-based setup wizard for HostingDirector to complete your appliance configuration.

1. From the IBM Advanced Appliance Configuration Utility, click the **System** tab.
2. From the System panel, click the **Start Web Management** button. This invokes a Web browser that hosts the HostingDirector installation process.
3. Accept the SSL security certificate by clicking the **Yes** button from the Security Alert window. An SSL certificate is created that is associated with the IP

address of the appliance. After this association has been made, the installation process restarts the Web server. The remainder of the session is secured through the SSL certificate.

4. Read the Terms of Use agreement. Click the **Accept** radio button from the License window to accept the terms. Click **Next**. The Network Interface configuration window opens.
5. Provide administrative information for the configured network interface of your appliance. Enter values for the following fields:

User Name:

The user account for the HostingDirector administrator.

Note: Provide each appliance with a unique user name account. Multiple appliances that are managed in a cluster are required to have unique user names.

Password:

A password for the HostingDirector administrator account. This password must be 6 - 8 characters in length.

Domain Name:

Domain name used for logging into the management applet. This field is optional. If this field is left blank, you must use the IP address of the appliance to log on.

Administrator's Email:

Email address for the HostingDirector administrator.

Administrator Description:

Optional field for adding a one-line description of the administrator account. This can include the name and phone number of the administrator.

Display Language:

Drop-down listbox for selecting a default language for each Virtual Dedicated Server created within HostingDirector.

6. Click **Finish**. HostingDirector initializes the configuration information you have provided into the current working session. After initialization is complete, you will be directed to the HostingDirector Login window.

Initial HostingDirector configuration is now complete.

HostingDirector Post-Installation Configuration

After you have installed HostingDirector, configure default HostingDirector settings before using your appliance as a host. You will provide configuration information for the following four areas:

- Usage Data
- Contact Information
- DNS Information
- IP Management

Note: The machine used to access HostingDirector must have a Java-enabled Web browser.

Complete the following procedures to configure HostingDirector settings (You will automatically be redirected to the login page for HostingDirector after completing the installation).

1. Log in to the HostingDirector application using the user name and password you configured for the administrator account.

Note: In the future, you can access the login page by directing your Web browser to one of the following:
 - `http://Appliance IP Address/manager`
 - `http://Appliance Domain/manager`
2. Click **Yes** to accept the license agreement. The HostingDirector main window will be displayed.
3. From the HostingDirector IAE Tree, select the Server node.
4. Click **Edit** on the HostingDirector toolbar.
5. Click the Usage Data tab located in the Server Properties details panel. Configure how usage data for each VDS is recorded:
 - a. Select the **Write to Log** check box to enable the logging of VDS usage data.
 - b. Specify a location and name for the usage data log file.
 - c. Select a counter to specify when usage logs are reset. For example, you can configure the counter to reset each month if you calculate customers usage on a monthly basis.
 - d. Select how many counters will be archived.
 - e. Click **OK**.
6. With the Server node still selected, click **Edit** on the HostingDirector toolbar.
7. Click the Contacts/Contact Address tabs located in the Server Properties details panel.
 - a. Enter contact information for the server administrator. Server level alerts are sent to the email address configured on this panel. This information is displayed in each customer's account Control Panel.
 - b. Determine which accounts will receive emailed system alerts (such as disk or file quota warnings). If you select the Enable All Alerts checkbox, Administrators, Resellers, and Site Owners will receive system alert emails. If left unselected, alerts will be sent to Site Owners only.
 - c. Click **OK**.
8. From the HostingDirector IAE Tree, select the DNS node.
9. Click **Edit** on the HostingDirector toolbar.
10. Click the Default DNS Header tab located in the Server Properties details panel.
 - a. Type the email address for your DNS administrator.
 - b. Modify SOA parameters if necessary. Default settings are recommended.
 - c. Click **OK**.
11. From the HostingDirector IAE Tree, select the Server Management node. An HTML-based Control Panel opens and replaces the applet-based Control Panel. IP Management is used to create, edit, share, and delete IP address ranges used by each VDS.
12. Select IP Management. Do the following:
 - a. Select **IP Ranges**.
 - b. Select **Add New IP Range** and then proceed through the configuration wizard panels to add a new IP range to the system. IP-based VDS's will use these IP addresses.
 - c. Click **OK**.
 - d. Select **Shared IP's**.

- e. Select **Add New Shared IP** and then proceed through the configuration wizard panels to add a new IP range to the system. Name-based VDSs will use these IP addresses.
 - f. Click **OK**.
13. Click the **Return to Control Panel** link on the top right of the Control Panel. You return to the Java-based Control Panel.

You have completed HostingDirector post-installation configuration. You can add VDSs (as described in the HostingDirector help system) and begin hosting.

Using the Configuration/Setup Utility program for the xSeries Hosting Appliance

This section provides the instructions needed to start the Configuration/Setup Utility program.

Note: The Configuration/Setup Utility might vary slightly, depending upon if you are using the @server xSeries Hosting Appliance.

The Configuration/Setup utility is a menu-driven program that is part of the BIOS code that comes with your xSeries Hosting Appliance. You can use this program to:

- Configure serial connector assignments
- Change the drive startup sequence
- Resolve configuration conflicts
- Set the date and time
- Set passwords

Attention: Your appliance ships with preconfigured BIOS settings. Changing these settings could result in difficulty managing your xSeries Hosting Appliance. Do not change the settings unless instructed to do so by IBM support personnel. The preconfigured basic input/output system (BIOS) settings are shown in Table 2.

Table 2. Preconfigured BIOS settings

Start options	Settings
Keyboardless operation mode	Enabled
Displayless operation mode	Enabled
Floppy diskette	Removed from boot sequence
Network	Removed from boot sequence
Virus detection	Disabled
Boot failure detect	Disabled

Note: To use this program you need to have a keyboard, mouse, and monitor connected to the xSeries Hosting Appliance.

To start the Configuration/Setup Utility program:

1. Turn on the xSeries Hosting Appliance.
2. When the message Press F1 for Configuration/Setup appears, press F1.

Note: If you have set both levels of passwords (user and administrator), you must type the administrator password to access the full Configuration/Setup menu.

3. Follow the instructions that appear on the screen.

Chapter 4. The Advanced Appliance Configuration Utility

The Advanced Appliance Configuration Utility is used to configure and manage xSeries Hosting Appliances. If you are adding multiple xSeries Hosting Appliances to your network, you can use the Advanced Appliance Configuration Utility to configure multiple xSeries Hosting Appliances simultaneously.

Use the following general procedure to manage the xSeries Hosting Appliance:

1. If you have not already done so, designate a mobile computer, workstation, or server for appliance management on the same physical subnet as the appliance.
2. Install and then start the Advanced Appliance Configuration Utility from the *Product Supplementary* CD on the workstation (see “Installing and starting the Advanced Appliance Configuration Utility”).
3. Create groups and add xSeries Hosting Appliances to the groups (see “Using the group functions to manage your xSeries Hosting Appliances” on page 30).

Installing and starting the Advanced Appliance Configuration Utility

To install and start the Advanced Appliance Configuration Utility, do the following:

1. Insert the *Product Supplementary* CD into the CD-ROM drive of the remote Microsoft Windows workstation designated for managing appliances.
2. From the IAAConfig directory, run the Setup.exe file.
3. From the remote workstation you are using to manage the network, go to Start, then open the IBM Advanced Appliance Configuration Utility (see Figure 10 on page 30).

Any IBM @server xSeries Hosting Appliance that is running and is connected to the same physical subnet as the system that is running the Advanced Appliance Configuration Utility console is automatically discovered when you start the Advanced Appliance Configuration Utility. Each xSeries Hosting Appliance appears in the All Appliances list and one of the following lists: the appliance list of the group it belongs to, the Unassigned Appliances list, or the Conflicting IP Address list. A rescan (see “Rescanning” on page 35) forces an immediate discovery of xSeries Hosting Appliances in the subnet.

Notes:

- a. The Advanced Appliance Configuration Utility configures and reports the TCP/IP settings of the first adapter on each xSeries Hosting Appliance only. The first adapter is the port 1 Ethernet controller. Be sure to connect the built-in Ethernet connector to the same subnet as your system running the Advanced Appliance Configuration Utility.
- b. Only one Advanced Appliance Configuration Utility console should be running at a time on the same physical subnet.

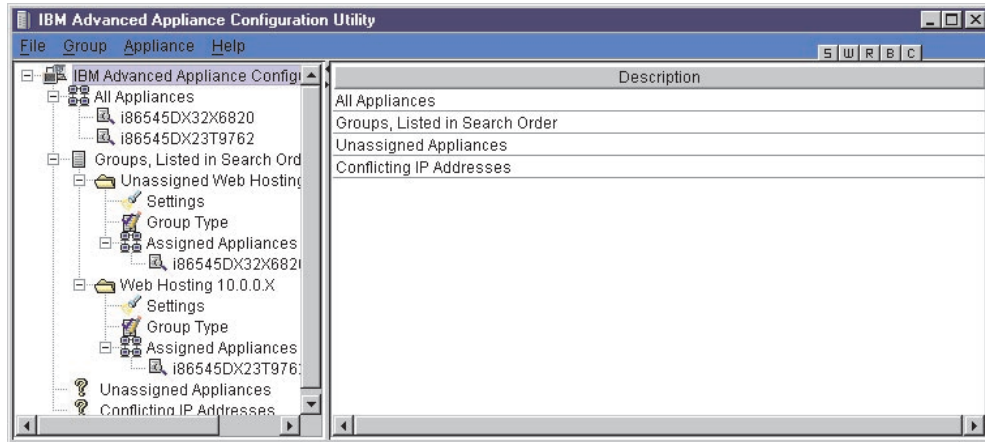

Figure 10. IBM advanced appliance configuration utility

Using the group functions to manage your xSeries Hosting Appliances

The Advanced Appliance Configuration Utility uses groups to automatically categorize discovered xSeries Hosting Appliances and to configure them with network settings. Groups enable you to display and configure network settings for multiple appliances at the same time.

Group types are defined by appliance type or purpose. Each group can contain only one type of xSeries Hosting Appliance. xSeries Hosting Appliances can belong only to a group that matches the type of xSeries Hosting Appliance. You can drag and drop xSeries Hosting Appliances from one group to another as long as the xSeries Hosting Appliance type matches the group.

Note: If the Advanced Appliance Configuration Utility is configured to not assign settings, it does not configure any of the network settings of the xSeries Hosting Appliance.

Groups provide a collection of xSeries Hosting Appliances that:

- Display network settings
- Provide a shortcut to HostingDirector

If the appliance network settings are configured by a method other than using the Advanced Appliance Configuration Utility, the xSeries Hosting Appliance is still discovered, and it joins the first group that matches the xSeries Hosting Appliance. If no matching group exists, the xSeries Hosting Appliance is listed in the Unassigned Appliances list.

The Advanced Appliance Configuration Utility window lists the following items (see Figure 10):

All Appliances

Every discovered xSeries Hosting Appliance is listed under all appliances.

Groups, Listed in Search Order

This view shows all groups that are defined, with xSeries Hosting Appliances that are assigned to each group nested beneath the group name in the Tree view. The IBM Advanced Appliance Configuration Utility automatically assigns one IP address per xSeries Hosting Appliance, using

available addresses assigned within the group type. When a group IP address range is exhausted, the Advanced Appliance Configuration Utility no longer manages the network settings of subsequently discovered xSeries Hosting Appliances. When an xSeries Hosting Appliance is discovered on the network, the Advanced Appliance Configuration Utility searches defined groups. Appliances are then automatically added to the first group that matches the purpose of the xSeries Hosting Appliance. The order in which groups appear is important in the appliance discovery process, because an xSeries Hosting Appliance is assigned to the first matching group that it discovers. To adjust the search order, right-click on a group and use up or down to adjust its position within the group list.

Unassigned Appliances

All discovered xSeries Hosting Appliances that do not match any existing group are listed under Unassigned Appliances.

Conflicting IP Addresses

If the IP address of the discovered xSeries Hosting Appliance has the same address of an already discovered xSeries Hosting Appliance and there is no group defined to automatically assign a different address, the xSeries Hosting Appliance is placed in the Conflicting IP Addresses list.

Creating a group

When you create a group, xSeries Hosting Appliances that match the appliance type of the group and are members of the Unassigned Appliances list automatically move to that group. To create a group, do the following:

1. Start the Advanced Appliance Configuration Utility. Click **Group > Create Group**. The Advanced Appliance Configuration Utility Group Wizard window opens.
2. Specify a group name. In the **Group Name** field, type a unique name that will identify the group.
3. Select the Appliance Group type. The Appliance Group type determines what purpose an xSeries Hosting Appliance must serve to be included in the group. For example, you can select the following value: IBM @server xSeries Hosting Appliance
4. If you want this group to manage the network settings of the assigned xSeries Hosting Appliances using the Advanced Appliance Configuration Utility, click **Yes**, and then specify the TCP/IP network settings to be used by members of the group. If you want to use another tool to configure the IP address, click **No** and proceed to step 5 on page 33. Specify the following parameters:

Start IP Address

The lowest IP address in a range of IP addresses that can be automatically assigned to an xSeries Hosting Appliance that is a member of the group.

End IP Address

The highest IP address in a range of IP addresses that can be automatically assigned to an xSeries Hosting Appliance that is a member of the group.

Subnet Mask

The subnet mask value to automatically assign to members of the group.

Default Gateway

The IP address for the default gateway to automatically assign to members of the group (optional).

DNS Address

The IP address of the Domain Name Server (DNS) to automatically assign to members of the group (optional). You can specify up to three entries.

Use Current Host Name

The host name of the xSeries Hosting Appliance and it is not automatically assigned.

Use "i"Prefix and Model-Serial number

The host name is set to use an "i" prefix and the model and serial number of the xSeries Hosting Appliance. This is the default name that is preconfigured on IBM @server xSeries Hosting Appliances. For example, an xSeries Hosting Appliance with the model number of 86545DX and serial number of 23T9762 yields a host name of i86545DX23T9762.

Use Prefix-IP Address

A user-specified prefix is combined with the xSeries Hosting Appliance IP address to generate the host name. Periods (.) are not valid in a host name, and are replaced with hyphens (-). When you supply the prefix, remember that the total length of the host name cannot exceed 15 characters.

Domain Name

Type the DNS domain name to assign to xSeries Hosting Appliances. This field is optional.

5. Click **Finish**.

After you have defined all groups, go to “Using the Assign by First Matching Group function” on page 34 or “Moving an xSeries Hosting Appliance into a group”.

Moving an xSeries Hosting Appliance into a group

To move an xSeries Hosting Appliance into an existing group, perform the following steps:

1. Using the mouse, select the xSeries Hosting Appliance icon. When you drag the icon, it changes and indicates where you can drop the xSeries Hosting Appliance.
2. Drag the xSeries Hosting Appliance icon into the group that you want. Although the xSeries Hosting Appliance is listed in the All Appliances list, you can drop the xSeries Hosting Appliance icon when you are over the group name or the Assigned Appliances list that belongs to the group.

If the group is configured to manage network settings and there is an IP address available from the IP address range of the group, the Advanced Appliance Configuration Utility automatically configures the network settings of the xSeries Hosting Appliance. Otherwise, the network settings are not configured by the Advanced Appliance Configuration Utility and no changes are made.

Note: If you perform a group reassignment for the xSeries Hosting Appliance, it retains its individual network settings and does not adopt the settings configured for the group.

Removing xSeries Hosting Appliances from groups

Use the **Remove Appliance** option to delete an xSeries Hosting Appliance from the Advanced Appliance Configuration Utility database. Removing an xSeries Hosting Appliance that is no longer in use enables the IP address that was assigned to the xSeries Hosting Appliance to be allocated to another xSeries Hosting Appliance. You can also remove an xSeries Hosting Appliance from a group and then rescan the network to add it to an appropriate group that appears higher in the group list (see “Rescanning” on page 35).

Note: If the xSeries Hosting Appliance you are trying to remove does not respond when you highlight it and click remove, it is automatically removed. However, if you attempt to remove an active xSeries Hosting Appliance, a warning message is displayed.

To remove an xSeries Hosting Appliance, highlight the xSeries Hosting Appliance; then from the right-click menu, click **Remove Appliance**.

Using the Assign by First Matching Group function

The **Assign by First Matching Group** option enables you to set xSeries Hosting Appliances to join the first matching group. You can move xSeries Hosting Appliances to the group that you want by using a drag-and-drop method or by right-clicking the unassigned xSeries Hosting Appliance and then clicking **Assign by First Matching Group**. To assign an xSeries Hosting Appliance to the first matching group, do the following:

1. Right-click the group to which you want to move the xSeries Hosting Appliance.
2. Click **Move Up in List** to move the selected group up in the list of groups.
3. Repeat steps 1 and 2 until the group that you want to add the xSeries Hosting Appliance to appears above the group that currently contains the xSeries Hosting Appliance.
4. Right-click the xSeries Hosting Appliance that you want to move to another group, and then click **Assign by First Matching Group**. The xSeries Hosting Appliance moves to the group that it matches.

Restoring a factory image

There are two options available for restoring the original factory image to the appliance. They are:

- Restoring the factory image with the Advanced Appliance Configuration Utility
- Restoring the factory image with the reload CD

Restoring a factory image with the Advanced Appliance Configuration Utility

To restore the factory image using the Advanced Appliance Configuration Utility, do the following:

1. Select the xSeries Hosting Appliance to which you want to restore the image.
2. Click **Appliance > Restore Factory Image**.
3. Click **Yes**.

Restoring a factory image with the reload CD

The reload CD provided with your appliance is a bootable CD that contains the original manufacturer's system image for your appliance. Complete the following steps to reload the factory image.

1. Create a Reload Enablement Disk by placing a blank diskette in a Windows workstation and using the diskcreator.exe program located in the Recovery_Enablement_Disk directory of the Supplementary CD. Ensure that the diskette is not write-protected.

Note: The Reload Enablement Disk can be used only for one factory restoration. If you must perform additional factory restorations, you will have to create a new Reload Enablement Disk.

2. Insert the Reload CD into the CD-ROM drive of the appliance.
3. Shutdown and turn off the appliance.
4. Insert the diskette in the floppy disk drive of your appliance.
5. Turn on the appliance. The factory image is restored, the CD is ejected, and the appliance restarts.

Rescanning

The Advanced Appliance Configuration Utility detects xSeries Hosting Appliances that are on the same physical subnet as the Advanced Appliance Configuration Utility console. xSeries Hosting Appliances that are actively communicating with the console have a file/magnifying glass icon; those that are not responding display an X on a red circle icon.

The Advanced Appliance Configuration Utility does not automatically detect a failed xSeries Hosting Appliance. If you suspect that an xSeries Hosting Appliance has failed, rescan the network to update the icons. To rescan the network, click **File > Rescan Network**.

Exporting and importing the database

The server database of the Advanced Appliance Configuration Utility Console contains group definitions and discovered xSeries Hosting Appliance information. When the xSeries Hosting Appliance starts, it reads the database file and updates the file automatically. To import or export a configuration database, do the following:

1. From the **File** menu, click **Import configuration** or **Export configuration**.
2. Type the file name (the exported file is an ASCII based text file). If a file name is specified, all file names are relative to the directory where the Advanced Appliance Configuration Utility is installed.

Notes:

1. The remote workstation that is running the Advanced Appliance Configuration Utility console automatically maintains a copy of the database (ServerConfiguration.properties) in the Advanced Appliance Configuration Utilities installed directory. To remove previous configuration data, close the Advanced Appliance Configuration Utility, delete this file, and then restart the utility. All previously configured groups are deleted. The Advanced Appliance Configuration Utility discovers connected xSeries Hosting Appliances and their network settings.
2. As a precaution, you cannot export to an already existing file.

Starting HostingDirector using the Advanced Appliance Configuration Utility

To use the Advanced Appliance Configuration Utility console to start HostingDirector, do the following:

1. Click the appliance that you want to manage.
2. Click **Start Web-Based Management**.

Your default Web browser starts; the browser starts the HostingDirector console automatically.

3. Log in to the HostingDirector Web page.

Chapter 5. Solving problems

This section provides basic troubleshooting information to help you resolve common problems that might occur with your server. You might need to connect a monitor, mouse, and keyboard to aid your troubleshooting.

Diagnostic tools overview

The following tools are available to help you identify and resolve hardware-related problems:

- **POST beep codes, error messages, and error logs**

The power-on self-test (POST) generates beep codes and messages that indicate successful test completion or the detection of a problem. See “POST beep code descriptions” on page 38.

- **Troubleshooting charts**

These charts list problem symptoms, and suggested steps to correct the problems. See “Troubleshooting charts” on page 39 for more information.

- **Diagnostic programs and error messages**

The server diagnostic programs are stored in upgradable read-only memory (ROM) on the *IBM Enhanced Diagnostics* CD for the xSeries Hosting Appliance. These programs are the primary method for testing the major components of your server.

- **Customized support page**

You can create a customized support page that is specific to your hardware, complete with Frequently Asked Questions, parts information, technical hints and tips, and downloadable files. In addition, you can choose to receive email notifications whenever new information becomes available about your registered products.

After you register and create a profile for your @server products, you can diagnose problems using the IBM Online Assistant, and you can participate in the IBM discussion forum. For more detailed information about registering and creating a customized profile for your IBM products, visit the following Web sites:

- <http://www.ibm.com/pc/register>
- <http://www.ibm.com/pc/support>

POST beep code descriptions

When you turn on the xSeries Hosting Appliance, it performs a series of tests to check the operation of xSeries Hosting Appliance components and some of the options that are installed in the xSeries Hosting Appliance. This series of tests is called the power-on self-test, or POST.

Beep codes are sounded in a series of long and short beeps. The types of beep codes that your xSeries Hosting Appliance can emit include the following:

No beeps

If no beep occurs after POST completes, call for service.

One short beep

One beep indicates that your xSeries Hosting Appliance successfully completed POST. POST detected no configuration or functional errors. One beep also occurs after your xSeries Hosting Appliance completes POST if you type an incorrect power-on password.

One long and two short beeps

A video I/O adapter ROM is not readable, or the video subsystem is defective. If you hear this beep combination twice, both the system board and an optional video adapter have failed the test. This beep combination might also indicate that the system board contains a failing component.

Three short beeps

A system memory error has occurred. This combination occurs only if the video basic input/output system (BIOS) cannot display the error message. Replace the failing memory module.

Continuous beep

Your startup microprocessor has failed, or your system board or speaker subsystem might contain a failing component. If the system continues through POST with no errors, or if no video appears, call for service.

Refer to "POST beep codes" for a comprehensive list of POST beep information.

POST beep codes

This section contains the POST beep codes for your xSeries Hosting Appliance. A 1-2-3 beep code is one beep, a pause, two consecutive beeps, another pause, and then three more consecutive beeps.

Table 3. POST beep codes

Beep code	Description	Action
1-1-2	Microprocessor register test has failed.	Call for service.
1-1-3	CMOS write/read test has failed.	
1-1-4	BIOS ROM checksum has failed.	
1-2-1	Programmable Interval Timer test has failed.	
1-2-2	DMA initialization has failed.	
1-2-3	DMA page register write/read test has failed.	
1-2-4	RAM refresh verification has failed. Turn off the server and then restart the server. If the problem persists, call for service.	

Table 3. POST beep codes (continued)

Beep code	Description	Action
1-3-1	First 64 KB RAM test has failed. Turn off the server and then restart the server. If the problem persists, call for service.	
1-3-2	First 64 KB RAM parity test has failed. Turn off the server and then restart the server. If the problem persists, call for service.	
1-4-3	Interrupt vector loading test has failed.	
2-1-1	Secondary DMA register test has failed.	
2-1-2	Primary DMA register test has failed.	
2-1-3	Primary interrupt mask register test has failed.	
2-1-4	Secondary interrupt mask register test has failed.	
2-2-1	Interrupt vector loading has failed.	
2-2-2	Keyboard controller test has failed.	
2-2-3	CMOS power failure and checksum checks have failed.	
2-2-4	CMOS configuration information validation has failed.	
2-3-2	Screen memory test has failed.	
2-3-3	Screen retrace tests have failed.	
2-3-4	Search for video ROM has failed.	
2-4-1	Screen test indicates the screen is operable.	
3-1-1	Timer tick interrupt test has failed.	
3-1-2	Interval timer channel 2 test has failed.	
3-1-3	RAM test has failed above address hex 0FFFF.	
3-1-4	Time-of-Day clock test has failed.	
3-2-1	Serial port test has failed.	
3-2-2	Parallel port test has failed.	
3-2-4	Comparison of CMOS memory size against actual size has failed.	
3-3-1	A memory size mismatch has occurred. Turn off the server and then restart the server. If the problem persists, call for service.	
3-3-2	I2C bus has failed.	

Troubleshooting charts

You can use the troubleshooting charts in this section to find solutions to problems that have definite symptoms.

Look for the device and symptom in the left column of the chart. Instructions and probable solutions to the problem are in the right column. If you have just added new software or a new option and your xSeries Hosting Appliance is not working, do the following before using the troubleshooting charts:

- Remove the software or device that you just added.
- Restart to determine if it is running correctly.
- Reinstall the new software or new device.

Table 4. Troubleshooting charts

Device	Suggested Action
CD-ROM drive	Verify that:
CD-ROM drive is not recognized.	<ul style="list-style-type: none"> • The primary IDE channel is enabled in the Configuration/Setup Utility program. • All cables and jumpers are installed correctly. • The correct device driver is installed for the CD-ROM drive.
Diskette drive	If there is a diskette in the drive, verify that:
Diskette drive activity light stays on.	<ul style="list-style-type: none"> • The diskette drive is enabled in the Configuration/Setup Utility program. • The diskette is good and not damaged. (Try another diskette if you have one.) • Your software program is OK. <p>If the diskette drive activity light stays on, call for service.</p>
Intermittent problems	Verify that:
A problem occurs only occasionally and is difficult to detect.	<ul style="list-style-type: none"> • All cables and cords are connected securely to the rear of the server and attached options. • When the server is turned on, air is flowing from the rear of the server at the fan grill. If there is no airflow, the fan is not working. This causes the server to overheat and shut down. • Ensure that the SCSI bus and devices are configured correctly and that the last external device in each SCSI chain is terminated correctly. <p>If the problem continues, call for service.</p>
Keyboard, mouse, or pointing-device problems.	<ul style="list-style-type: none"> • Make sure that the xSeries Hosting Appliance and the monitor are turned on. • Try using another keyboard. • Make sure that the keyboard cable is properly connected to the C2T breakout cable.
All or some keys on the keyboard do not work.	If the items above are correct but the problem continues, call for service.
The mouse or pointing device does not work.	<ul style="list-style-type: none"> • Verify that the mouse or pointing-device cable is securely connected and the device drivers are installed correctly. • Try using another mouse or pointing device. <p>If the problem continues, call for service.</p>

Table 4. Troubleshooting charts (continued)

Device	Suggested Action
Memory problems	Verify that: <ul style="list-style-type: none"> • The memory modules are seated properly. • You have installed the correct type of memory. • If you changed the memory, you updated the memory configuration with the Configuration/Setup Utility program. • All banks of memory on the DIMMs are enabled. The server might have automatically disabled a DIMM bank when it detected a problem, or a DIMM bank could have been manually disabled.
The amount of memory displayed is less than the amount of memory that is installed.	Look in the POST error log for error message 289: <ul style="list-style-type: none"> • If the DIMM was disabled by a systems-management interrupt (SMI), replace the DIMM. • If the DIMM was disabled by the user or by POST: <ol style="list-style-type: none"> 1. Start the Configuration/Setup Utility program. 2. Enable the DIMM. 3. Save the configuration and restart the server. • If you continue to get this error, replace the DIMM. If the problem continues, call for service.
Microprocessor problems	The startup (boot) microprocessor is not working properly. Verify that the startup microprocessor is seated properly. If it is, call for service.
The server emits a continuous tone during POST.	The startup (boot) microprocessor is not working properly. Verify that the startup microprocessor is seated properly. If it is, call for service.
Monitor problems	Some IBM monitors have their own self-tests. If you suspect a problem with your monitor, refer to the information that comes with the monitor for adjusting and testing instructions. If you still cannot determine the problem, call for service. Verify that: <ul style="list-style-type: none"> • The xSeries Hosting Appliance power cord is plugged into the xSeries Hosting Appliance and a working electrical outlet. • The monitor cables are connected properly. • The monitor is turned on and the brightness and contrast controls are adjusted correctly.
The screen is blank	If the screen remains blank, call for service.
Only the cursor appears.	Call for service.
The monitor works when you turn on the server, but goes blank when you start some application programs.	Verify that you installed the necessary device drivers for the applications. If the screen remains blank, call for service.

Table 4. Troubleshooting charts (continued)

Device	Suggested Action
<p>Wavy, unreadable, rolling, distorted screen, or screen jitter.</p>	<p>If the monitor self-tests show the monitor is working correctly, consider the location of the monitor. Magnetic fields around other devices (such as transformers, appliances, fluorescent lights, and other monitors) can cause screen jitter or wavy, unreadable, rolling, or distorted screen images. If this happens, turn off the monitor. (Moving a color monitor while it is turned on might cause screen discoloration.) Then move the device and the monitor at least 305 mm (12 in.) apart. Turn on the monitor.</p> <p>Notes:</p> <ol style="list-style-type: none"> 1. To prevent diskette drive read/write errors, be sure that the distance between monitors and diskette drives is at least 76 mm (3 in.). 2. Non-IBM monitor cables might cause unpredictable problems. 3. An enhanced monitor cable with additional shielding is available for the IBM model 9521 and 9527 monitors. For information about the enhanced monitor cable, see your IBM reseller or IBM marketing representative. <p>If the problem continues, call for service.</p>
<p>Wrong characters appear on the screen.</p>	<p>If the wrong language is displayed, update the BIOS code with the correct language. If the problem continues, call for service.</p>
<p>Option problems</p>	<p>Verify that:</p> <ul style="list-style-type: none"> • The option is designed for the xSeries Hosting Appliance. Refer to http://www.ibm.com/us/compat. • You followed the installation instructions that came with the option. • The option is installed correctly.
<p>An IBM option that was just installed does not work.</p>	<ul style="list-style-type: none"> • You have not loosened any other installed options or cables. • You updated the configuration information in the Configuration/Setup Utility program. Whenever memory or an option is changed, you must update the configuration. <p>If the problem continues, call for service.</p>
<p>Power problems</p>	<p>Verify that:</p> <ul style="list-style-type: none"> • The power cables are properly connected to the xSeries Hosting Appliance. • The electrical outlet functions properly. • The type of memory installed is correct.
<p>The xSeries Hosting Appliance does not power on.</p>	<ul style="list-style-type: none"> • If you just installed an option, remove it, and restart the server. If the server now powers on, you might have installed more options than the power supply supports. <p>If the problem continues, call for service.</p>

Table 4. Troubleshooting charts (continued)

Device	Suggested Action
Serial port problems	Verify that: Each port is assigned a unique address by the Configuration/Setup Utility program and none of the serial ports are disabled.
The number of serial ports identified by the operating system is less than the number of serial ports installed.	Note: Management port is the same as a serial port connector, and is not available for use by the operating system. This port does not appear in the Configuration/Setup Utility program menus; it can be configured. If the problem continues, call for service.
A serial device does not work.	Verify that: <ul style="list-style-type: none"> • The device is compatible with the server. • The serial port is enabled and is assigned a unique address. If the problem continues, call for service.
Software problem	To determine whether problems are caused by the software, verify that: <ul style="list-style-type: none"> • Your xSeries Hosting Appliance has the minimum memory requirements to use the software. For memory requirements, see the information that comes with the software. Note: If you have just installed an adapter or memory, you might have a memory address conflict. • The software is designed to operate on your xSeries Hosting Appliance.
Suspected software problem.	<ul style="list-style-type: none"> • Other software works on your server. • The software that you are using works on another system. If you received any error messages when using the software program, see the information that comes with the software for a description of the messages and solutions to the problem. If the problem continues, contact your place of purchase.

Appendix. Product warranty and notices

This appendix contains warranty and emission notices. It also contains trademarks and general-information notices.

IBM Statement of Limited Warranty

Z125-4753-06 8/2000

Part 1 - General Terms

This Statement of Limited Warranty includes Part 1 - General Terms and Part 2 - Country-unique Terms. The terms of Part 2 replace or modify those of Part 1. The warranties provided by IBM in this Statement of Limited Warranty apply only to Machines you purchase for your use, and not for resale, from IBM or your reseller. The term "Machine" means an IBM machine, its features, conversions, upgrades, elements, or accessories, or any combination of them. The term "Machine" does not include any software programs, whether pre-loaded with the Machine, installed subsequently or otherwise. Unless IBM specifies otherwise, the following warranties apply only in the country where you acquire the Machine. Nothing in this Statement of Limited Warranty affects any statutory rights of consumers that cannot be waived or limited by contract. If you have any questions, contact IBM or your reseller.

The IBM Warranty for Machines

IBM warrants that each Machine 1) is free from defects in materials and workmanship and 2) conforms to IBM's Official Published Specifications ("Specifications"). The warranty period for a Machine is a specified, fixed period commencing on its Date of Installation. The date on your sales receipt is the Date of Installation unless IBM or your reseller informs you otherwise.

If a Machine does not function as warranted during the warranty period, and IBM or your reseller are unable to either 1) make it do so or 2) replace it with one that is at least functionally equivalent, you may return it to your place of purchase and your money will be refunded.

Extent of Warranty

The warranty does not cover the repair or exchange of a Machine resulting from misuse, accident, modification, unsuitable physical or operating environment, improper maintenance by you, or failure caused by a product for which IBM is not responsible. The warranty is voided by removal or alteration of Machine or parts identification labels.

THESE WARRANTIES ARE YOUR EXCLUSIVE WARRANTIES AND REPLACE ALL OTHER WARRANTIES OR CONDITIONS, EXPRESS OR IMPLIED, INCLUDING, BUT NOT LIMITED TO, THE IMPLIED WARRANTIES OR CONDITIONS OF MERCHANTABILITY AND FITNESS FOR A PARTICULAR PURPOSE. THESE WARRANTIES GIVE YOU SPECIFIC LEGAL RIGHTS AND YOU MAY ALSO HAVE OTHER RIGHTS WHICH VARY FROM JURISDICTION TO JURISDICTION. SOME JURISDICTIONS DO NOT ALLOW THE EXCLUSION OR LIMITATION OF EXPRESS OR IMPLIED

WARRANTIES, SO THE ABOVE EXCLUSION OR LIMITATION MAY NOT APPLY TO YOU. IN THAT EVENT, SUCH WARRANTIES ARE LIMITED IN DURATION TO THE WARRANTY PERIOD. NO WARRANTIES APPLY AFTER THAT PERIOD.

Items Not Covered by Warranty

IBM does not warrant uninterrupted or error-free operation of a Machine.

Any technical or other support provided for a Machine under warranty, such as assistance via telephone with “how-to” questions and those regarding Machine set-up and installation, will be provided **WITHOUT WARRANTIES OF ANY KIND.**

Warranty Service

To obtain warranty service for a Machine, contact IBM or your reseller. If you do not register your Machine with IBM, you may be required to present proof of purchase.

During the warranty period, IBM or your reseller, if approved by IBM to provide warranty service, provides without charge certain types of repair and exchange service to keep Machines in, or restore them to, conformance with their Specifications. IBM or your reseller will inform you of the available types of service for a Machine based on its country of installation. At its discretion, IBM or your reseller will 1) either repair or exchange the failing Machine and 2) provide the service either at your location or a service center. IBM or your reseller will also manage and install selected engineering changes that apply to the Machine.

Some parts of IBM Machines are designated as Customer Replaceable Units (called “CRUs”), e.g., keyboards, memory, or hard disk drives. IBM ships CRUs to you for replacement by you. You must return all defective CRUs to IBM within 30 days of your receipt of the replacement CRU. You are responsible for downloading designated Machine Code and Licensed Internal Code updates from an IBM Internet Web site or from other electronic media, and following the instructions that IBM provides.

When warranty service involves the exchange of a Machine or part, the item IBM or your reseller replaces becomes its property and the replacement becomes yours. You represent that all removed items are genuine and unaltered. The replacement may not be new, but will be in good working order and at least functionally equivalent to the item replaced. The replacement assumes the warranty service status of the replaced item. Many features, conversions, or upgrades involve the removal of parts and their return to IBM. A part that replaces a removed part will assume the warranty service status of the removed part.

Before IBM or your reseller exchanges a Machine or part, you agree to remove all features, parts, options, alterations, and attachments not under warranty service.

You also agree to

1. ensure that the Machine is free of any legal obligations or restrictions that prevent its exchange;
2. obtain authorization from the owner to have IBM or your reseller service a Machine that you do not own; and
3. where applicable, before service is provided:

- a. follow the problem determination, problem analysis, and service request procedures that IBM or your reseller provides;
- b. secure all programs, data, and funds contained in a Machine;
- c. provide IBM or your reseller with sufficient, free, and safe access to your facilities to permit them to fulfill their obligations; and
- d. inform IBM or your reseller of changes in a Machine's location.

IBM is responsible for loss of, or damage to, your Machine while it is 1) in IBM's possession or 2) in transit in those cases where IBM is responsible for the transportation charges.

Neither IBM nor your reseller is responsible for any of your confidential, proprietary or personal information contained in a Machine which you return to IBM or your reseller for any reason. You should remove all such information from the Machine prior to its return.

Limitation of Liability

Circumstances may arise where, because of a default on IBM's part or other liability, you are entitled to recover damages from IBM. In each such instance, regardless of the basis on which you are entitled to claim damages from IBM (including fundamental breach, negligence, misrepresentation, or other contract or tort claim), except for any liability that cannot be waived or limited by applicable laws, IBM is liable for no more than

1. damages for bodily injury (including death) and damage to real property and tangible personal property; and
2. the amount of any other actual direct damages, up to the charges (if recurring, 12 months' charges apply) for the Machine that is subject of the claim. For purposes of this item, the term "Machine" includes Machine Code and Licensed Internal Code.

This limit also applies to IBM's suppliers and your reseller. It is the maximum for which IBM, its suppliers, and your reseller are collectively responsible.

UNDER NO CIRCUMSTANCES IS IBM LIABLE FOR ANY OF THE FOLLOWING: 1) THIRD-PARTY CLAIMS AGAINST YOU FOR DAMAGES (OTHER THAN THOSE UNDER THE FIRST ITEM LISTED ABOVE); 2) LOSS OF, OR DAMAGE TO, YOUR RECORDS OR DATA; OR 3) SPECIAL, INCIDENTAL, OR INDIRECT DAMAGES OR FOR ANY ECONOMIC CONSEQUENTIAL DAMAGES, LOST PROFITS OR LOST SAVINGS, EVEN IF IBM, ITS SUPPLIERS OR YOUR RESELLER IS INFORMED OF THEIR POSSIBILITY. SOME JURISDICTIONS DO NOT ALLOW THE EXCLUSION OR LIMITATION OF INCIDENTAL OR CONSEQUENTIAL DAMAGES, SO THE ABOVE LIMITATION OR EXCLUSION MAY NOT APPLY TO YOU.

Governing Law

Both you and IBM consent to the application of the laws of the country in which you acquired the Machine to govern, interpret, and enforce all of your and IBM's rights, duties, and obligations arising from, or relating in any manner to, the subject matter of this Agreement, without regard to conflict of law principles.

Part 2 - Country-unique Terms

AMERICAS

BRAZIL

Governing Law: *The following is added after the first sentence:* Any litigation arising from this Agreement will be settled exclusively by the court of Rio de Janeiro.

NORTH AMERICA

Warranty Service: *The following is added to this Section:* To obtain warranty service from IBM in Canada or the United States, call 1-800-IBM-SERV (426-7378).

CANADA

Governing Law: *The following replaces “laws of the country in which you acquired the Machine” in the first sentence:* laws in the Province of Ontario.

UNITED STATES

Governing Law: *The following replaces “laws of the country in which you acquired the Machine” in the first sentence:* laws of the State of New York.

ASIA PACIFIC

AUSTRALIA

The IBM Warranty for Machines: *The following paragraph is added to this Section:* The warranties specified in this Section are in addition to any rights you may have under the Trade Practices Act 1974 or other similar legislation and are only limited to the extent permitted by the applicable legislation.

Limitation of Liability: *The following is added to this Section:* Where IBM is in breach of a condition or warranty implied by the Trade Practices Act 1974 or other similar legislation, IBM’s liability is limited to the repair or replacement of the goods or the supply of equivalent goods. Where that condition or warranty relates to right to sell, quiet possession or clear title, or the goods are of a kind ordinarily acquired for personal, domestic or household use or consumption, then none of the limitations in this paragraph apply.

Governing Law: *The following replaces “laws of the country in which you acquired the Machine” in the first sentence:* laws of the State or Territory.

CAMBODIA, LAOS, AND VIETNAM

Governing Law: *The following replaces “laws of the country in which you acquired the Machine” in the first sentence:* laws of the State of New York.

The following is added to this Section: Disputes and differences arising out of or in connection with this Agreement shall be finally settled by arbitration which shall be held in Singapore in accordance with the rules of the International Chamber of Commerce (ICC). The arbitrator or arbitrators designated in conformity with those rules shall have the power to rule on their own competence and on the validity of the Agreement to submit to arbitration. The arbitration award shall be final and binding for the parties without appeal and the arbitral award shall be in writing and set forth the findings of fact and the conclusions of law.

All proceedings shall be conducted, including all documents presented in such proceedings, in the English language. The number of arbitrators shall be three, with each side to the dispute being entitled to appoint one arbitrator.

The two arbitrators appointed by the parties shall appoint a third arbitrator before proceeding upon the reference. The third arbitrator shall act as chairman of the proceedings. Vacancies in the post of chairman shall be filled by the president of the ICC. Other vacancies shall be filled by the respective nominating party. Proceedings shall continue from the stage they were at when the vacancy occurred.

If one of the parties refuses or otherwise fails to appoint an arbitrator within 30 days of the date the other party appoints its, the first appointed arbitrator shall be the sole arbitrator, provided that the arbitrator was validly and properly appointed.

The English language version of this Agreement prevails over any other language version.

HONG KONG AND MACAU

Governing Law: *The following replaces "laws of the country in which you acquired the Machine" in the first sentence: laws of Hong Kong Special Administrative Region.*

INDIA

Limitation of Liability: *The following replaces items 1 and 2 of this Section:*

1. liability for bodily injury (including death) or damage to real property and tangible personal property will be limited to that caused by IBM's negligence;
2. as to any other actual damage arising in any situation involving nonperformance by IBM pursuant to, or in any way related to the subject of this Statement of Limited Warranty, IBM's liability will be limited to the charge paid by you for the individual Machine that is the subject of the claim.

JAPAN

Governing Law: *The following sentence is added to this Section: Any doubts concerning this Agreement will be initially resolved between us in good faith and in accordance with the principle of mutual trust.*

NEW ZEALAND

The IBM Warranty for Machines: *The following paragraph is added to this Section: The warranties specified in this Section are in addition to any rights you may have under the Consumer Guarantees Act 1993 or other legislation which cannot be excluded or limited. The Consumer Guarantees Act 1993 will not apply in respect of any goods which IBM provides, if you require the goods for the purposes of a business as defined in that Act.*

Limitation of Liability: *The following is added to this Section: Where Machines are not acquired for the purposes of a business as defined in the Consumer Guarantees Act 1993, the limitations in this Section are subject to the limitations in that Act.*

PEOPLE'S REPUBLIC OF CHINA (PRC)

Governing Law: *The following replaces this Section: Both you and IBM consent to the application of the laws of the State of New York (except when local law requires otherwise) to govern, interpret, and enforce all your and IBM's rights, duties, and obligations arising from, or relating in any manner to, the subject matter of this Agreement, without regard to conflict of law principles.*

Any disputes arising from or in connection with this Agreement will first be resolved by friendly negotiations, failing which either of us has the right to submit the dispute to the China International Economic and Trade Arbitration Commission in Beijing, the PRC, for arbitration in accordance with its arbitration rules in force at the time. The arbitration tribunal will consist of three arbitrators. The language to be used therein will be English and Chinese. An arbitral award will be final and binding on all the parties, and will be enforceable under the Convention on the Recognition and Enforcement of Foreign Arbitral Awards (1958).

The arbitration fee will be borne by the losing party unless otherwise determined by the arbitral award.

During the course of arbitration, this Agreement will continue to be performed except for the part which the parties are disputing and which is undergoing arbitration.

EUROPE, MIDDLE EAST, AFRICA (EMEA)

THE FOLLOWING TERMS APPLY TO ALL EMEA COUNTRIES: The terms of this Statement of Limited Warranty apply to Machines purchased from IBM or an IBM reseller.

Warranty Service:

If you purchase an IBM Machine in Austria, Belgium, Denmark, Estonia, Finland, France, Germany, Greece, Iceland, Ireland, Italy, Latvia, Lithuania, Luxembourg, Netherlands, Norway, Portugal, Spain, Sweden, Switzerland or United Kingdom, you may obtain warranty service for that Machine in any of those countries from either (1) an IBM reseller approved to perform warranty service or (2) from IBM. If you purchase an IBM Personal Computer Machine in Albania, Armenia, Belarus, Bosnia and Herzegovina, Bulgaria, Croatia, Czech Republic, Georgia, Hungary, Kazakhstan, Kirghizia, Federal Republic of Yugoslavia, Former Yugoslav Republic of Macedonia (FYROM), Moldova, Poland, Romania, Russia, Slovak Republic, Slovenia, or Ukraine, you may obtain warranty service for that Machine in any of those countries from either (1) an IBM reseller approved to perform warranty service or (2) from IBM.

If you purchase an IBM Machine in a Middle Eastern or African country, you may obtain warranty service for that Machine from the IBM entity within the country of purchase, if that IBM entity provides warranty service in that country, or from an IBM reseller, approved by IBM to perform warranty service on that Machine in that country. Warranty service in Africa is available within 50 kilometers of an IBM authorized service provider. You are responsible for transportation costs for Machines located outside 50 kilometers of an IBM authorized service provider.

Governing Law:

The applicable laws that govern, interpret and enforce rights, duties, and obligations of each of us arising from, or relating in any manner to, the subject matter of this Statement, without regard to conflict of laws principles, as well as Country-unique terms and competent court for this Statement are those of the country in which the warranty service is being provided, except that in 1) Albania, Bosnia-Herzegovina, Bulgaria, Croatia, Hungary, Former Yugoslav Republic of Macedonia, Romania, Slovakia, Slovenia, Armenia, Azerbaijan, Belarus, Georgia, Kazakhstan, Kyrgyzstan, Moldova, Russia, Tajikistan, Turkmenistan, Ukraine, and Uzbekistan, the laws of Austria apply; 2) Estonia, Latvia, and Lithuania, the laws

of Finland apply; 3) Algeria, Benin, Burkina Faso, Cameroon, Cape Verde, Central African Republic, Chad, Congo, Djibouti, Democratic Republic of Congo, Equatorial Guinea, France, Gabon, Gambia, Guinea, Guinea-Bissau, Ivory Coast, Lebanon, Mali, Mauritania, Morocco, Niger, Senegal, Togo, and Tunisia, this Agreement will be construed and the legal relations between the parties will be determined in accordance with the French laws and all disputes arising out of this Agreement or related to its violation or execution, including summary proceedings, will be settled exclusively by the Commercial Court of Paris; 4) Angola, Bahrain, Botswana, Burundi, Egypt, Eritrea, Ethiopia, Ghana, Jordan, Kenya, Kuwait, Liberia, Malawi, Malta, Mozambique, Nigeria, Oman, Pakistan, Qatar, Rwanda, Sao Tome, Saudi Arabia, Sierra Leone, Somalia, Tanzania, Uganda, United Arab Emirates, United Kingdom, West Bank/Gaza, Yemen, Zambia, and Zimbabwe, this Agreement will be governed by English Law and disputes relating to it will be submitted to the exclusive jurisdiction of the English courts; and 5) in Greece, Israel, Italy, Portugal, and Spain any legal claim arising out of this Statement will be brought before, and finally settled by, the competent court of Athens, Tel Aviv, Milan, Lisbon, and Madrid, respectively.

THE FOLLOWING TERMS APPLY TO THE COUNTRY SPECIFIED:

AUSTRIA AND GERMANY

The IBM Warranty for Machines: *The following replaces the first sentence of the first paragraph of this Section:* The warranty for an IBM Machine covers the functionality of the Machine for its normal use and the Machine's conformity to its Specifications.

The following paragraphs are added to this Section:

The minimum warranty period for Machines is six months. In case IBM or your reseller is unable to repair an IBM Machine, you can alternatively ask for a partial refund as far as justified by the reduced value of the unrepaired Machine or ask for a cancellation of the respective agreement for such Machine and get your money refunded.

Extent of Warranty: *The second paragraph does not apply.*

Warranty Service: *The following is added to this Section:* During the warranty period, transportation for delivery of the failing Machine to IBM will be at IBM's expense.

Limitation of Liability: *The following paragraph is added to this Section:* The limitations and exclusions specified in the Statement of Limited Warranty will not apply to damages caused by IBM with fraud or gross negligence and for express warranty.

The following sentence is added to the end of item 2: IBM's liability under this item is limited to the violation of essential contractual terms in cases of ordinary negligence.

EGYPT

Limitation of Liability: *The following replaces item 2 in this Section:* as to any other actual direct damages, IBM's liability will be limited to the total amount you paid for the Machine that is the subject of the claim. For purposes of this item, the term "Machine" includes Machine Code and Licensed Internal Code.

Applicability of suppliers and resellers (unchanged).

FRANCE

Limitation of Liability: *The following replaces the second sentence of the first paragraph of this Section:*In such instances, regardless of the basis on which you are entitled to claim damages from IBM, IBM is liable for no more than: *(items 1 and 2 unchanged).*

IRELAND

Extent of Warranty: *The following is added to this Section:* Except as expressly provided in these terms and conditions, all statutory conditions, including all warranties implied, but without prejudice to the generality of the foregoing all warranties implied by the Sale of Goods Act 1893 or the Sale of Goods and Supply of Services Act 1980 are hereby excluded.

Limitation of Liability: *The following replaces items one and two of the first paragraph of this Section:*1. death or personal injury or physical damage to your real property solely caused by IBM's negligence; and 2. the amount of any other actual direct damages, up to 125 percent of the charges (if recurring, the 12 months' charges apply) for the Machine that is the subject of the claim or which otherwise gives rise to the claim.

Applicability of suppliers and resellers (unchanged).

The following paragraph is added at the end of this Section: IBM's entire liability and your sole remedy, whether in contract or in tort, in respect of any default shall be limited to damages.

ITALY

Limitation of Liability: *The following replaces the second sentence in the first paragraph:*In each such instance unless otherwise provided by mandatory law, IBM is liable for no more than: 1. *(unchanged)* 2. as to any other actual damage arising in all situations involving nonperformance by IBM pursuant to, or in any way related to the subject matter of this Statement of Warranty, IBM's liability, will be limited to the total amount you paid for the Machine that is the subject of the claim. *Applicability of suppliers and resellers (unchanged).*

The following replaces the third paragraph of this Section: Unless otherwise provided by mandatory law, IBM and your reseller are not liable for any of the following: *(items 1 and 2 unchanged)* 3) indirect damages, even if IBM or your reseller is informed of their possibility.

SOUTH AFRICA, NAMIBIA, BOTSWANA, LESOTHO AND SWAZILAND

Limitation of Liability: *The following is added to this Section:* IBM's entire liability to you for actual damages arising in all situations involving nonperformance by IBM in respect of the subject matter of this Statement of Warranty will be limited to the charge paid by you for the individual Machine that is the subject of your claim from IBM.

UNITED KINGDOM

Limitation of Liability: *The following replaces items 1 and 2 of the first paragraph of this Section:*

1. death or personal injury or physical damage to your real property solely caused by IBM's negligence;
2. the amount of any other actual direct damages or loss, up to 125 percent of the charges (if recurring, the 12 months' charges apply) for the Machine that is the subject of the claim or which otherwise gives rise to the claim;

The following item is added to this paragraph: 3. breach of IBM's obligations implied by Section 12 of the Sale of Goods Act 1979 or Section 2 of the Supply of Goods and Services Act 1982.

Applicability of suppliers and resellers (unchanged).

The following is added to the end of this Section: IBM's entire liability and your sole remedy, whether in contract or in tort, in respect of any default shall be limited to damages.

Warranty information

This section contains the warranty period for your product and the IBM Statement of Limited Warranty.

Warranty period

Contact your place of purchase for warranty service information. Some IBM Machines are eligible for on-site warranty service depending on the country or region where service is performed.

Machines-
IBM @server xSeries Hosting Appliance
Warranty period - Three years

Notices

This publication was developed for products and services offered in the U.S.A.

IBM may not offer the products, services, or features discussed in this document in other countries. Consult your local IBM representative for information on the products and services currently available in your area. Any reference to an IBM product, program, or service is not intended to state or imply that only that IBM product, program, or service may be used. Any functionally equivalent product, program, or service that does not infringe any IBM intellectual property right may be used instead. However, it is the user's responsibility to evaluate and verify the operation of any non-IBM product, program, or service.

IBM may have patents or pending patent applications covering subject matter described in this document. The furnishing of this document does not give you any license to these patents. You can send license inquiries, in writing, to:

*IBM Director of Licensing
IBM Corporation
North Castle Drive
Armonk, NY 10504-1785
U.S.A.*

INTERNATIONAL BUSINESS MACHINES CORPORATION PROVIDES THIS PUBLICATION "AS IS" WITHOUT WARRANTY OF ANY KIND, EITHER EXPRESS OR IMPLIED, INCLUDING, BUT NOT LIMITED TO, THE IMPLIED WARRANTIES OF NON-INFRINGEMENT, MERCHANTABILITY OR FITNESS FOR A PARTICULAR PURPOSE. Some states do not allow disclaimer of express or implied warranties in certain transactions, therefore, this statement may not apply to you.

This information could include technical inaccuracies or typographical errors. Changes are periodically made to the information herein; these changes will be incorporated in new editions of the publication. IBM may make improvements and/or changes in the product(s) and/or the program(s) described in this publication at any time without notice.

Any references in this publication to non-IBM Web sites are provided for convenience only and do not in any manner serve as an endorsement of those Web sites. The materials at those Web sites are not part of the materials for this IBM product, and use of those Web sites is at your own risk.

IBM may use or distribute any of the information you supply in any way it believes appropriate without incurring any obligation to you.

Edition notice

© COPYRIGHT INTERNATIONAL BUSINESS MACHINES CORPORATION, 2002. All rights reserved.

Note to U.S. Government Users — Documentation related to restricted rights — Use, duplication or disclosure is subject to restrictions set forth in GSA ADP Schedule Contract with IBM Corp.

Processing date data

This IBM hardware product and IBM software products that might be packaged with it have been designed, when used in accordance with their associated documentation, to process date data correctly within and between the 20th and 21st centuries, provided all other products (for example, software, hardware, and firmware) used with these products properly exchange accurate date data with them.

IBM cannot take responsibility for the date data processing capabilities of non-IBM products, even if those products are preinstalled or otherwise distributed by IBM. You should contact the vendors responsible for those products directly to determine the capabilities of their products and update them if needed. This IBM hardware product cannot prevent errors that might occur if software, upgrades, or peripheral devices you use or exchange data with do not process date data correctly.

The foregoing is a Year 2000 Readiness Disclosure.

Trademarks

The following terms are trademarks of the IBM Corporation in the United States, other countries, or both:

Alert on LAN	Light Path Diagnostics
e-business logo	Predictive Failure Analysis

HelpCenter	ServerProven
IBM	IBM logo

Intel, Celeron, MMX, LANDesk, Pentium, Pentium II Xeon, and Pentium III Xeon are trademarks of Intel Corporation in the United States, other countries, or both.

Microsoft, Windows, and Windows NT are trademarks of Microsoft Corporation in the United States, other countries, or both.



Java and all Java-based trademarks and logos are trademarks or registered trademarks of Sun Microsystems, Inc. in the United States, other countries, or both.

Linux is a registered trademark of Linus Torvalds.

Other company, product, and service names may be trademarks or service marks of others.

Important notes

Processor speeds indicate the internal clock speed of the microprocessor; other factors also affect application performance.

Maximum memory may require replacement of standard memory with optional maximum memory module.

When referring to processor storage, real and virtual storage, or channel volume, KB stands for approximately 1000 bytes, MB stands for approximately 1000000 bytes, and GB stands for approximately 1000000000 bytes.

When referring to hard disk drive capacity or communications volume, MB stands for 1 000 000 bytes, and GB stands for 1 000 000 000 bytes. Total user-accessible capacity may vary depending on operating environments.

CD-ROM speeds list variable read rate. Actual speeds vary and are often less than the maximum possible.

Maximum internal hard disk drive capacities assume the replacement of any standard hard disk drives and population of all hard disk drive bays with the largest currently supported drives available from IBM.

IBM makes no representation or warranties regarding non-IBM products and services that are ServerProven, including but not limited to the implied warranties of merchantability and fitness for particular purpose. These products are offered and warranted solely by third parties.

Unless otherwise stated, IBM makes no representations or warranties with respect to non-IBM products. Support (if any) for the non-IBM products is provided by the third party, not IBM.

Some software may differ from its retail version (if available), and may not include user manuals or all program functionality.

Electronic emission notices

Federal Communications Commission (FCC) statement

Note: This equipment has been tested and found to comply with the limits for a Class A digital device, pursuant to Part 15 of the FCC Rules. These limits are designed to provide reasonable protection against harmful interference when the equipment is operated in a commercial environment. This equipment generates, uses, and can radiate radio frequency energy and, if not installed and used in accordance with the instruction manual, may cause harmful interference to radio communications. Operation of this equipment in a residential area is likely to cause harmful interference, in which case the user will be required to correct the interference at his own expense.

Properly shielded and grounded cables and connectors must be used in order to meet FCC emission limits. Properly shielded and grounded cables and connectors must be used in order to meet FCC emission limits. IBM is not responsible for any radio or television interference caused by using other than recommended cables and connectors or by using other than recommended cables and connectors or by unauthorized changes or modifications to this equipment. Unauthorized changes or modifications could void the user's authority to operate the equipment.

This device complies with Part 15 of the FCC Rules. Operation is subject to the following two conditions: (1) this device may not cause harmful interference, and (2) this device must accept any interference received, including interference that may cause undesired operation.

Industry Canada Class A emission compliance statement

This Class A digital apparatus complies with Canadian ICES-003.

Avis de conformité à la réglementation d'Industrie Canada

Cet appareil numérique de la classe A est conforme à la norme NMB-003 du Canada.

Australia and New Zealand Class A statement

Attention: This is a Class A product. In a domestic environment this product may cause radio interference in which case the user may be required to take adequate measures.

United Kingdom telecommunications safety requirement

Notice to Customers

This apparatus is approved under approval number NS/G/1234/J/100003 for indirect connection to public telecommunication systems in the United Kingdom.

European Union EMC Directive conformance statement

This product is in conformity with the protection requirements of EU Council Directive 89/336/EEC on the approximation of the laws of the Member States relating to electromagnetic compatibility. IBM cannot accept responsibility for any failure to satisfy the protection requirements resulting from a nonrecommended modification of the product, including the fitting of non-IBM option cards.

This product has been tested and found to comply with the limits for Class A Information Technology Equipment according to CISPR 22/European Standard EN 55022. The Limits for Class A equipment were derived for commercial and industrial environments to provide reasonable protection against interference with licensed communication equipment.

Attention: This is a Class A product. In a domestic environment this product may cause radio interference in which case the user may be required to take adequate measures.

Taiwan electrical emission statement

警告使用者：
這是甲類的資訊產品，在居住的環境中使用時，可能會造成射頻干擾，在這種情況下，使用者會被要求採取某些適當的對策。

Japanese Voluntary Control Council for Interference (VCCI) statement

この装置は、情報処理装置等電波障害自主規制協議会（VCCI）の基準に基づくクラスA情報技術装置です。この装置を家庭環境で使用すると電波妨害を引き起こすことがあります。この場合には使用者が適切な対策を講ずるよう要求されることがあります。

Power cords

For your safety, IBM provides a power cord with a grounded attachment plug to use with this IBM product. To avoid electrical shock, always use the power cord and plug with a properly grounded outlet.

IBM power cords used in the United States and Canada are listed by Underwriter's Laboratories (UL) and certified by the Canadian Standards Association (CSA).

For units intended to be operated at 115 volts: Use a UL-listed and CSA-certified cord set consisting of a minimum 18 AWG, Type SVT or SJT, three-conductor cord, a maximum of 15 feet in length and a parallel blade, grounding-type attachment plug rated 15 amperes, 125 volts.

For units intended to be operated at 230 volts (U.S. use): Use a UL-listed and CSA-certified cord set consisting of a minimum 18 AWG, Type SVT or SJT, three-conductor cord, a maximum of 15 feet in length and a tandem blade, grounding-type attachment plug rated 15 amperes, 250 volts.

For units intended to be operated at 230 volts (outside the U.S.): Use a cord set with a grounding-type attachment plug. The cord set should have the appropriate safety approvals for the country in which the equipment will be installed.

IBM power cords for a specific country or region are usually available only in that country or region.

IBM power cord part number	Used in these countries and regions
13F9940	Argentina, Australia, China (PRC), New Zealand, Papua New Guinea, Paraguay, Uruguay, Western Samoa
13F9979	Afghanistan, Algeria, Andorra, Angola, Austria, Belgium, Benin, Bulgaria, Burkina Faso, Burundi, Cameroon, Central African Rep., Chad, China (Macau S.A.R.), Czech Republic, Egypt, Finland, France, French Guiana, Germany, Greece, Guinea, Hungary, Iceland, Indonesia, Iran, Ivory Coast, Jordan, Lebanon, Luxembourg, Malagasy, Mali, Martinique, Mauritania, Mauritius, Monaco, Morocco, Mozambique, Netherlands, New Caledonia, Niger, Norway, Poland, Portugal, Romania, Senegal, Slovakia, Spain, Sudan, Sweden, Syria, Togo, Tunisia, Turkey, former USSR, Vietnam, former Yugoslavia, Zaire, Zimbabwe
13F9997	Denmark
14F0015	Bangladesh, Burma, Pakistan, South Africa, Sri Lanka

IBM power cord part number	Used in these countries and regions
14F0033	Antigua, Bahrain, Brunei, Channel Islands, China (Hong Kong S.A.R.), Cyprus, Dubai, Fiji, Ghana, India, Iraq, Ireland, Kenya, Kuwait, Malawi, Malaysia, Malta, Nepal, Nigeria, Polynesia, Qatar, Sierra Leone, Singapore, Tanzania, Uganda, United Kingdom, Yemen, Zambia
14F0051	Liechtenstein, Switzerland
14F0069	Chile, Ethiopia, Italy, Libya, Somalia
14F0087	Israel
1838574	Thailand
6952301	Bahamas, Barbados, Bermuda, Bolivia, Brazil, Canada, Cayman Islands, Colombia, Costa Rica, Dominican Republic, Ecuador, El Salvador, Guatemala, Guyana, Haiti, Honduras, Jamaica, Japan, Korea (South), Liberia, Mexico, Netherlands Antilles, Nicaragua, Panama, Peru, Philippines, Saudi Arabia, Suriname, Taiwan, Trinidad (West Indies), United States of America, Venezuela

Index

A

- acoustical noise emissions 5
- Advanced Appliance Configuration Utility 29
 - discovering appliance servers 29
 - installing and starting 29
 - using group functions 30
- appliance server
 - configuring 21
 - standby mode 19
 - turning off 19
 - turning on 18

C

- CD-ROM
 - drive specification 5
 - problems 40
- Class A electronic emission notice 56
 - cover
 - installing 16
 - removing 10

D

- DIMMs
 - specifications 5
 - supported 5
- diskette drive
 - problem 40
 - specifications 5
- dual in-line memory module (DIMM) 14

E

- electrical input 5
- electronic emission Class A notice 56
 - environment
 - air temperature 5
 - humidity 5
- expansion bays 5

F

- FCC Class A notice 56

H

- hard disk drive
 - IDE 11

- hard disk drive (*continued*)
 - installing 11
 - non-hot-swap 11
 - specifications 11
- hardware problems 37
- heat output 5
- HostingDirector
 - installing and configuring 23
 - post-installation configuration 24
 - starting 35

I

- IBM Advanced Appliance Configuration Utility 3
- integrated functions 5

K

- keyboard problem 40

L

- LEDs
 - front view 6
 - rear view 7

M

- memory
 - modules 14
 - problem 41
 - specifications 5
 - supported 14
- microprocessor
 - problem 41
 - specifications 5
- mouse problem 40

N

- notices
 - electronic emission 56
 - FCC, Class A 56
- notices and statements 2

O

- option
 - installing 9

- problem 42

P

- pointing device problem 40
- power problem 42
- power supply specifications 5
- problem
 - CD-ROM 40
 - diskette drive 40
 - hardware 37
 - intermittent 40
 - keyboard or mouse 40
 - memory 41
 - microprocessor 41
 - option 42
 - power 42
 - serial port 43
 - software 43

S

- serial port problem 43
- server controls model 8672 6
- Setting the initial IP address using the Advanced Appliance Configuration Utility 22
- software problem 43
- static sensitive devices 9
- system requirements 3

T

- temperature, air 5
- trademarks 54
- troubleshooting charts 39

U

- United States electronic emission Class A notice 56
- United States FCC Class A notice 56

V

- VDS 3
- video controller specifications 5
- Virtual Dedicated Server 3



Part Number: 33P2696

Printed in U.S.A.

33P2696

