

Remote Supervisor Adapter



Installation Guide

Remote Supervisor Adapter



Installation Guide

Note: Before using this information and the product it supports, read the general information in Appendix B, "Warranty information" on page 57 and Appendix C, "Notices" on page 69.

Fifth Edition (October 2002)

© Copyright International Business Machines Corporation 2000, 2002. All rights reserved.

US Government Users Restricted Rights – Use, duplication or disclosure restricted by GSA ADP Schedule Contract with IBM Corp.

Contents

Safety	v
Chapter 1. Introduction	1
Installation prerequisites	1
Installation requirements	2
Remote Supervisor Adapter features	3
About your documentation CD	3
System requirements for the IBM Documentation Browser	3
Starting the IBM Documentation Browser	3
Using the IBM Documentation Browser	4
Using the search feature	4
Related publications	4
Notices and statements used in this book	5
Handling static-sensitive devices	5
Unpacking and verifying components	6
Inventory checklist	6
Remote Supervisor Adapter components	7
Chapter 2. Installing and configuring the adapter	9
Adapter installation task summary	10
xSeries 220 installation	11
xSeries 232 installation	13
xSeries 330 installation	15
xSeries 342 installation	18
Connecting the 20-pin ribbon cable	19
Connecting the external power-supply adapter	20
Using the ASM link cable and ASM interconnect module with an xSeries 330 server	22
Connecting the LAN and serial cables	22
Cabling the Ethernet LAN connector	23
Cabling the serial connector	24
Chapter 3. Using the Remote Supervisor Utility and configuring the adapter.	25
Updating the Remote Supervisor Adapter firmware	25
Enabling remote access to the adapter	26
Configuring the Ethernet settings	27
Configuring the serial connector	29
Setting up point-to-point protocol	30
Installing ASM processor device drivers in xSeries 330 servers	32
Installing adapter device drivers in other supported xSeries servers	32
Installing Windows 2000 device drivers	33
Installing Windows NT device drivers	34
Using the non-interactive method	34
Using the interactive method	34
Installing Linux device drivers	34
Kernel configuration notes	36
Remote mouse and keyboard notes	37
User name and password limitation for GUI login	37
Installing Novell NetWare device drivers	37
Installing SCO UnixWare or Caldera Open UNIX device drivers	38
Configuring the remote-control password	38
Completing the installation	39

Chapter 4. Using the ASM interconnect network	41
Overview	41
Planning and cabling your ASM interconnect network	41
Considerations when configuring xSeries 232 and xSeries 342 servers	42
Considerations when configuring xSeries 335 servers	42
Forwarding alerts	46
Connecting the ASM interconnect module	47
Using the RS-485 terminator plugs on interconnected servers	48
ASM interconnect network configuration examples	49
Appendix A. Getting help and technical assistance	55
Before you call	55
Using the documentation	55
Getting help and information from the World Wide Web	55
Software service and support	56
Hardware service and support	56
Appendix B. Warranty information	57
Warranty period	57
Problem determination	57
Running diagnostics	57
Checking software	57
Warranty service and support	58
International Warranty Service	58
Purchasing additional services	59
IBM Statement of Limited Warranty Z125-4753-06 8/2000	60
Part 1 - General Terms	60
Part 2 - Country-unique Terms	62
Appendix C. Notices	69
Edition notice	69
Trademarks	70
Important notes	70
Electronic emission notices	71
Federal Communications Commission (FCC) statement	71
Industry Canada Class A emission compliance statement	71
Australia and New Zealand Class A statement	71
United Kingdom telecommunications safety requirement	71
European Union EMC Directive conformance statement	72
Taiwanese Class A warning statement	72
Japanese Voluntary Control Council for Interference (VCCI) statement	72
Power cords	72
Index	75

Safety

Before installing this product, read the Safety Information.

قبل تركيب هذا المنتج، يجب قراءة الملاحظات الأمنية

Antes de instalar este produto, leia as Informações de Segurança.

在安装本产品之前，请仔细阅读 **Safety Information** (安全信息)。

安裝本產品之前，請先閱讀「安全資訊」。

Prije instalacije ovog produkta obavezno pročitajte Sigurnosne Upute.

Před instalací tohoto produktu si přečtěte příručku bezpečnostních instrukcí.

Læs sikkerhedsforskrifterne, før du installerer dette produkt.

Lees voordat u dit product installeert eerst de veiligheidsvoorschriften.

Ennen kuin asennat tämän tuotteen, lue turvaohjeet kohdasta Safety Information.

Avant d'installer ce produit, lisez les consignes de sécurité.

Vor der Installation dieses Produkts die Sicherheitshinweise lesen.

Πριν εγκαταστήσετε το προϊόν αυτό, διαβάστε τις πληροφορίες ασφάλειας (safety information).

לפני שתתקינו מוצר זה, קראו את הוראות הבטיחות.

A termék telepítése előtt olvassa el a Biztonsági előírásokat!

Prima di installare questo prodotto, leggere le Informazioni sulla Sicurezza.

製品の設置の前に、安全情報をお読みください。

본 제품을 설치하기 전에 안전 정보를 읽으십시오.

Пред да се инсталира овој продукт, прочитајте информацијата за безбедност.

Les sikkerhetsinformasjonen (Safety Information) før du installerer dette produktet.

Przed zainstalowaniem tego produktu, należy zapoznać się z książką "Informacje dotyczące bezpieczeństwa" (Safety Information).

Antes de instalar este produto, leia as Informações sobre Segurança.

Перед установкой продукта прочтите инструкции по технике безопасности.

Pred inštaláciou tohto zariadenia si pečítajte Bezpečnostné predpisy.

Pred namestitvijo tega proizvoda preberite Varnostne informacije.

Antes de instalar este producto, lea la información de seguridad.

Läs säkerhetsinformationen innan du installerar den här produkten.

Statement 1:



DANGER

Electrical current from power, telephone, and communication cables is hazardous.

To avoid a shock hazard:

- **Do not connect or disconnect any cables or perform installation, maintenance, or reconfiguration of this product during an electrical storm.**
- **Connect all power cords to a properly wired and grounded electrical outlet.**
- **Connect to properly wired outlets any equipment that will be attached to this product.**
- **When possible, use one hand only to connect or disconnect signal cables.**
- **Never turn on any equipment when there is evidence of fire, water, or structural damage.**
- **Disconnect the attached power cords, telecommunications systems, networks, and modems before you open the device covers, unless instructed otherwise in the installation and configuration procedures.**
- **Connect and disconnect cables as described in the following table when installing, moving, or opening covers on this product or attached devices.**

To Connect:	To Disconnect:
1. Turn everything OFF.	1. Turn everything OFF.
2. First, attach all cables to devices.	2. First, remove power cords from outlet.
3. Attach signal cables to connectors.	3. Remove signal cables from connectors.
4. Attach power cords to outlet.	4. Remove all cables from devices.
5. Turn device ON.	

Statement 2:



CAUTION:

When replacing the lithium battery, use only IBM Part Number 33F8354 or an equivalent type battery recommended by the manufacturer. If your system has a module containing a lithium battery, replace it only with the same module type made by the same manufacturer. The battery contains lithium and can explode if not properly used, handled, or disposed of.

Do not:

- Throw or immerse into water
- Heat to more than 100°C (212°F)
- Repair or disassemble

Dispose of the battery as required by local ordinances or regulations.

Statement 5:



CAUTION:

The power control button on the device and the power switch on the power supply do not turn off the electrical current supplied to the device. The device also might have more than one power cord. To remove all electrical current from the device, ensure that all power cords are disconnected from the power source.

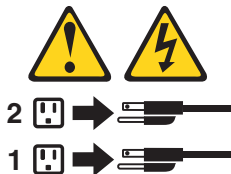

Chapter 1. Introduction

This manual provides information about installing the IBM® Remote Supervisor Adapter in IBM eServer xSeries™ servers, including how to:

- Install and cable your adapter
- Install device drivers
- Configure your adapter

The latest version of this publication and information about product updates are available from the IBM Support Web site at <http://www.ibm.com/pc/support/>. For service, assistance, or additional information on the World Wide Web, see Appendix A, “Getting help and technical assistance” on page 55.

After you install and configure the Remote Supervisor Adapter, you can use either the Advanced System Management (ASM) Web interface or the text-based interface to use the Remote Supervisor Adapter features. For more information, see the *IBM Remote Supervisor Adapter User's Guide* on the IBM Documentation CD.

Installation prerequisites

Before installing the Remote Supervisor Adapter, perform the following tasks:

- Download the most recent device drivers, Remote Supervisor Adapter firmware, configuration utility, management information bases (MIBs), and documentation from the <http://www.ibm.com/pc/support/> IBM Support Web site. You will create either one or two diskettes, depending on your server type.
- Install the operating system on your server before you install the Advanced System Management device drivers. For information about installing the operating system, see the documentation that comes with your server.
To install the operating system using ServerGuide™, use ServerGuide version 6.0.3, or later.

Note: If you previously installed the operating system using ServerGuide version 6.0.2, make sure that you install the Advanced System Management device drivers from the *IBM Remote Supervisor Adapter Support* CD, or download the device drivers from the <http://www.ibm.com/pc/support/> IBM Support Web site. Do not install the device drivers from the directory that ServerGuide 6.0.2 created on the hard disk during the installation of the operating system. For information about installing the device drivers, see “Installing adapter device drivers in other supported xSeries servers” on page 32, or see “Installing ASM processor device drivers in xSeries 330 servers” on page 32.

- Update the basic input/output system (BIOS) code on your server. The latest level of BIOS code for your server is available from the <http://www.ibm.com/pc/support/> IBM Support Web site. For information about how to update the BIOS code, see the documentation that comes with your server.
- If you plan to configure Simple Network Management Protocol (SNMP) traps on the Remote Supervisor Adapter, you must install and compile the management information bases (MIBs) on your SNMP manager. One MIB supports SNMP traps and the other MIB supports the Get, GetNext, and Set request and response operations. You can install the MIBs that are provided in the MIB directory on the *IBM Remote Supervisor Adapter Support* CD that comes with the Remote Supervisor Adapter or you can go to <http://www.ibm.com/pc/support/>.

- To configure the remote alert recipients for IBM Director over LAN or IBM Director over Modem, the remote alert recipient must be a server with the Director Management Server installed.

Note: The IBM Director over Modem option is supported only in IBM Director versions 2.2.1, 3.1, and 3.1.1.

Installation requirements

The following items are required to install the Remote Supervisor Adapter:

- Supported IBM @server xSeries server
- Advanced System Management device drivers for the Remote Supervisor Adapter, which are supported on the following operating systems:
 - Novell NetWare 4.2, or later
 - Microsoft® Windows NT® 4.0 Server (with Service Pack 4 or later)
 - Microsoft Windows® 2000 Server
 - Microsoft Windows 2000 Advanced Server
 - SCO UnixWare 7.1.1, or later
 - Caldera Open UNIX®, version 8.0, or later
 - Red Hat Linux®

Note: Not all versions of Red Hat Linux are supported for all servers. To check if there is a supported Remote Supervisor Adapter device driver for your server model running your version of Red Hat Linux, go to <http://www.ibm.com/pc/support/>.

- SuSE Linux

Note: Not all versions of SuSE Linux are supported for all servers. To check if there is a supported Remote Supervisor Adapter device driver for your server model running your version of SuSE Linux, go to <http://www.ibm.com/pc/support/>.

- Documentation that comes with your server

The Remote Supervisor Adapter supports the following Web browsers for remote access. The Web browser that you use must be Java™-enabled and must support JavaScript™ 1.2 or later.

- Microsoft Internet Explorer version 4.0 (with Service Pack 1), or later
- Netscape Navigator version 4.72, or later (Version 6.x is not supported)

Notes:

1. Java plug-in version 1.4 or later is required for the remote start (boot) feature, which is not available on all servers.
2. For best results when using the ASM Web interface, set the resolution on your monitor to 800 x 600 pixels and 256 colors.
3. The ASM Web interface and the ASM text-based interface do not support the double-byte character set (DBCS) languages.

Remote Supervisor Adapter features

The Remote Supervisor Adapter provides the following:

- Continuous health monitoring and control
- Advanced Predictive Failure Analysis[®] (PFA) support
- Configurable notification and alerts
- Event logs that are time stamped, saved by a battery power unit on the Remote Supervisor Adapter, and can be attached to e-mail alerts
- Remote graphics console redirection
- LAN, serial, and Advanced System Management (ASM) interconnect remote access
- Point-to-point protocol (PPP) support
- Full Simple Network Management Protocol (SNMP) configuration, monitoring, and trap support
- Domain Name System (DNS) and Dynamic Host Configuration Protocol (DHCP) support
- Remote power control
- Microsoft Windows NT and Windows 2000 blue-screen capture
- Remote firmware update and access to critical server settings
- Independent power, which enables around-the-clock access to the server even when the server power is off
- Remote start (boot) from a diskette image

About your documentation CD

Your Remote Supervisor Adapter comes with the IBM *Documentation CD*, which contains documentation for the adapter in Portable Document Format (PDF) and includes the IBM Documentation Browser to help you find information quickly.

System requirements for the IBM Documentation Browser

To run the documentation CD, use a system that has the following minimum hardware and software:

- Microsoft Windows NT 4.0 (with Service Pack 3 or later), Windows 98, or Windows 2000.
- 100 MHz Intel Pentium[®] microprocessor.
- 32 MB RAM.
- Adobe Acrobat Reader 3.0 or later. Adobe Acrobat Reader software is included on the documentation CD, and you can install it when you run the IBM Documentation Browser.

Starting the IBM Documentation Browser

Use one of the following procedures to start the Documentation Browser:

- If Autostart is enabled, insert the documentation CD into your CD-ROM drive. The Documentation Browser will start automatically.
- If Autostart is disabled, insert the documentation CD into your CD-ROM drive; then, click **Start** → **Run**. In the **Open** field, type
`e:\win32.bat`
where *e* is the drive letter of your CD-ROM drive, and click **OK**.

Using the IBM Documentation Browser

Use the IBM Documentation Browser to browse the contents of the documentation CD, select from a list of available topics, see brief descriptions of the selected topics, and view selected topics using Adobe Acrobat Reader. The Documentation Browser automatically detects the regional settings in use on your system and presents the information in the language for that region (if available). If a topic is not available in the language for that region, the English version is displayed.

Click **Help** for detailed information about using the IBM Documentation Browser.

Complete the following steps to use the Documentation Browser:

1. From the **Product** drop-down list, select **Remote Supervisor Adapter**.

The **Topics** list is displayed. It lists all topics that pertain to the selected product. Topics are in folders or under other topics. A plus sign (+) is displayed beside each folder or topic that has additional topics under it. Click the plus sign to display the additional topics.

2. Click a topic to select it.

When you select a topic, a description of the topic contents is displayed in the **Description** field.

Note: To select multiple topics, press and hold down the Ctrl key while selecting your topic.

3. View selected topics.

Click **View Book**. Adobe Acrobat Reader starts, and the selected topics are displayed.

Using the search feature

Complete the following steps to use the Documentation Browser search feature:

1. Type a key word in the **Search** field.
2. Click **Search**. The topics containing the search word are listed in order based on the number of occurrences.
3. Click a file to open it.
4. Press Ctrl+F and use the Adobe Acrobat search function to search within the file.

Related publications

This *Installation Guide* provides general information about your Remote Supervisor Adapter, including information about features, how to configure your Remote Supervisor Adapter, how to configure an ASM interconnect network, and how to get help.

In addition to this *Installation Guide*, the following documentation is provided in PDF on the IBM *Documentation CD* that comes with your Remote Supervisor Adapter.

- *IBM Remote Supervisor Adapter User's Guide*

This publication describes the features and functions of the Advanced System Management (ASM) Web interface and the text-based user interface.

- *Safety Information*

This publication contains translated caution and danger statements. Each caution and danger statement that appears in the documentation has a number that you can use to locate the corresponding statement in your language in the *Safety Information* book.

Notices and statements used in this book

The caution and danger statements that appear in this book are also in the multilingual *Safety Information* book, which is on the IBM *Documentation* CD. Each statement is numbered for reference to the corresponding statement in the *Safety Information* book.

The following notices and statements are used in the documentation:

- **Notes:** These notices provide important tips, guidance, or advice.
- **Important:** These notices provide information or advice that might help you avoid inconvenient or problem situations.
- **Attention:** These notices indicate potential damage to programs, devices, or data. An attention notice is placed just before the instruction or situation in which damage could occur.
- **Caution:** These statements indicate situations that can be potentially hazardous to you. A caution statement is placed just before the description of a potentially hazardous procedure step or situation.
- **Danger:** These statements indicate situations that can be potentially lethal or extremely hazardous to you. A danger statement is placed just before the description of a potentially lethal or extremely hazardous procedure step or situation.

Handling static-sensitive devices

Attention: Static electricity can damage electronic devices, including your server. To avoid damage, keep static-sensitive devices in their static-protective package until you are ready to install them.

To reduce the possibility of damage from electrostatic discharge, observe the following precautions:

- Limit your movement. Movement can cause static electricity to build up around you.
- Handle the device carefully, holding it by its edges or its frame.
- Do not touch solder joints, pins, or exposed circuitry.
- Do not leave the device where others can handle and damage it.
- While the device is still in its static-protective package, touch it to an unpainted metal part of the server for at least 2 seconds. This drains static electricity from the package and from your body.
- Remove the device from its package and install it directly into the server without setting down the device. If it is necessary to set down the device, place it back into its static-protective package. Do not place the device on your server cover or on a metal surface.
- Take additional care when handling devices during cold weather. Heating reduces indoor humidity and increases static electricity.

Unpacking and verifying components

The following sections list the items that come with the Remote Supervisor Adapter and describe the Remote Supervisor Adapter components. You must install the Remote Supervisor Adapter in a peripheral component interconnect (PCI) expansion slot.

Inventory checklist

The Remote Supervisor Adapter option package contains the following items.

Note: Not all items are required for all servers. To determine if an item is required for your server, see Table 2 on page 10.

- Remote Supervisor Adapter

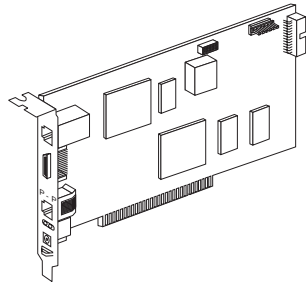

- Power-supply adapter

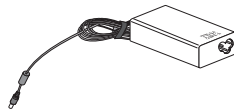

- Power cord



- 20-pin ribbon cable

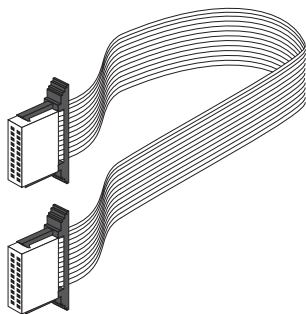

- Advanced System Management (ASM) link cable



- Universal power cord



- Advanced System Management (ASM) interconnect module (required for all xSeries 330 servers and certain ASM interconnect configurations)

Attention: To avoid damage to the Ethernet connector on the Remote Supervisor Adapter, do not plug the ASM interconnect module into the Ethernet (RJ-45) connector.

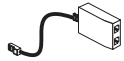

- RS-485 terminator plugs (comes with two)

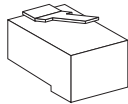

- *IBM Remote Supervisor Adapter Support CD*

This CD contains information that helps you configure hardware and install device drivers.

- *IBM Documentation CD*

This CD contains the Remote Supervisor Adapter documentation and the Documentation Browser.

Remote Supervisor Adapter components

The following illustration shows the Remote Supervisor Adapter and the locations of the connectors and components.

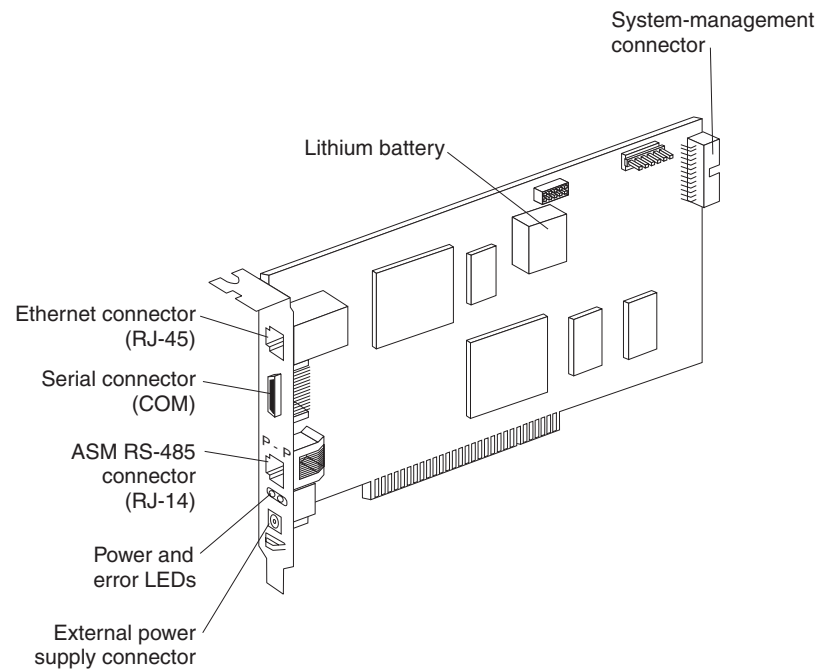

Ethernet connector (RJ-45)

Connect a Category 3 (10 Mbps) or Category 5 (100 Mbps) Ethernet cable to this connector to enable a LAN connection or Telnet session. The Ethernet connector LEDs on the Remote Supervisor Adapter are described in “Cabling the Ethernet LAN connector” on page 23.

Attention: The RJ-45 connectors on the Remote Supervisor Adapter are only for Ethernet and Advanced System Management interconnect use and are not for telecommunications use.

Serial connector (COM)

Connect a serial cable to this connector to enable system management through a modem, or connect a null modem cable to enable system management through a workstation or mobile computer.

ASM RS-485 connector (RJ-14)

Connect the ASM interconnect module that comes with the Remote Supervisor Adapter to the ASM RS-485 connector to connect the Remote Supervisor Adapter to the other devices on the ASM interconnect network.

Power and error LEDs

The green power LED indicates the status of the power connection. The amber error LED indicates an error on the Remote Supervisor Adapter.

External power-supply connector

Connect the power-supply adapter that comes with the Remote Supervisor Adapter to this connector. This connection provides power to the Remote Supervisor Adapter, independent of the server power supply.

Lithium battery

The lithium battery provides backup for the Remote Supervisor Adapter real-time clock, event log, and configuration settings.

System-management connector

If required for your server, connect the 20-pin ribbon cable that comes with the Remote Supervisor Adapter to the system-management connector on the Remote Supervisor Adapter and to the system-management connector on the system board in your server. To determine whether the 20-pin ribbon cable is required for your server, see Table 2 on page 10 or the documentation that comes with your server.

Chapter 2. Installing and configuring the adapter

This chapter details how to install and configure the Remote Supervisor Adapter in supported xSeries servers. The adapter installation procedures for your server are either included in this chapter or provided in the option installation information that comes with your server.

Use the following general tasks list to install and configure the Remote Supervisor Adapter. To determine whether a task is required for your server, see Table 2.

Task 1. Verify and complete the installation prerequisites. See “Installation prerequisites” on page 1.

Task 2. Unpack and verify the components. See “Unpacking and verifying components” on page 6.

Task 3. Install the Remote Supervisor Adapter in the server. For information about where to find the adapter installation procedures for your server, see Table 1.

Table 1. Remote Supervisor Adapter installation procedures

Server ¹	For the adapter installation procedures, see
xSeries 205 Type 8480	The documentation that comes with your server.
xSeries 220 Type 8645	page 11
xSeries 220 Type 8646	page 11
xSeries 232 Type 8668	page 13
xSeries 235 Type 8671	The documentation that comes with your server.
xSeries 255 Type 8685	The documentation that comes with your server.
xSeries 305 Type 8673	The documentation that comes with your server.
xSeries 330 Type 8654	page 15
xSeries 330 Type 8674	page 15
xSeries 330 Type 8675	page 15
xSeries 335 Type 8676	The documentation that comes with your server.
xSeries 342 Type 8669	page 18
xSeries 345 Type 8670	The documentation that comes with your server.
¹ For xSeries servers not listed in this table, see the adapter installation procedures in the documentation that comes with your server.	

Task 4. Connect the 20-pin ribbon cable, if required for your server. See Table 2 on page 10 and “Connecting the 20-pin ribbon cable” on page 19.

Task 5. Connect the external power-supply adapter, if required for your server. See Table 2 on page 10 and “Connecting the external power-supply adapter” on page 20.

Task 6. Connect the ASM link cable, if required for your server. See Table 2 on page 10 and “Using the ASM link cable and ASM interconnect module with an xSeries 330 server” on page 22.

Task 7. Connect the appropriate Ethernet and serial cables to their respective connectors on the Remote Supervisor Adapter. See “Connecting the LAN and serial cables” on page 22.

Task 8. Update the Remote Supervisor Adapter firmware. See “Updating the Remote Supervisor Adapter firmware” on page 25.

Task 9. Perform the initial configuration to enable remote access to the Remote Supervisor Adapter. See “Enabling remote access to the adapter” on page 26. Use this step to:

- Configure the Ethernet connector
- Configure the serial connector
- Set up the point-to-point protocol

Task 10. Install the Advanced System Management device drivers. See “Installing ASM processor device drivers in xSeries 330 servers” on page 32, or see “Installing adapter device drivers in other supported xSeries servers” on page 32.

Task 11. Configure the remote control password to enable the ASM Web interface remote control features. See “Configuring the remote-control password” on page 38.

Note: The remote control feature is not available for all servers.

Task 12. Complete the installation. See “Completing the installation” on page 39.

Task 13. Plan and cable the ASM interconnect network. See “Planning and cabling your ASM interconnect network” on page 41.

Adapter installation task summary

Table 2 lists the supported xSeries servers and the installation tasks that are required for each server.

Table 2. Remote Supervisor Adapter installation task summary by server

Server ¹	Required PCI slot	Is the power-supply adapter required or optional? ²	Is the 20-pin ribbon cable required?	System board connector location for the 20-pin ribbon cable	Is the ASM link cable required?
xSeries 205 Type 8480	1	Optional	Yes	CN20	No
xSeries 220 Type 8645	2	Required	Yes	J32	No
xSeries 220 Type 8646	2	Required	Yes	J32	No
xSeries 232 Type 8668	1	Optional	Yes	J54	No
xSeries 235 Type 8671	1	Optional	Yes	J27	No
xSeries 255 Type 8685	1	Optional	Yes	J16	No

Table 2. Remote Supervisor Adapter installation task summary by server (continued)

Server ¹	Required PCI slot	Is the power-supply adapter required or optional? ²	Is the 20-pin ribbon cable required?	System board connector location for the 20-pin ribbon cable	Is the ASM link cable required?
xSeries 305 Type 8673	1	Yes	Yes	CN12	No
xSeries 330 Type 8654	2	Yes	No	Not applicable	Yes
xSeries 330 Type 8674	2	Optional	Yes	J57	Yes
xSeries 330 Type 8675	1	Optional	Yes	J57	Yes
xSeries 335 Type 8676	1	Optional	Yes	J2	Yes ³
xSeries 342 Type 8669	1	Optional	Yes	J54	No
xSeries 345 Type 8670	5	Optional	Yes	J2	No

¹For installation information for supported xSeries servers not listed in this table, see the documentation that comes with your server.

²Connecting the power-supply adapter to the Remote Supervisor Adapter when it is not required for your server provides redundant power and access to the Remote Supervisor Adapter event log when the main server power source is unavailable.

³Required for RS-485 connectivity only.

xSeries 220 installation

Note: The illustrations in this document might differ slightly from your hardware.

Attention: When you handle static-sensitive devices, take precautions to avoid damage from static electricity. For details about handling static-sensitive devices, see “Handling static-sensitive devices” on page 5.

Complete the following steps to install the Remote Supervisor Adapter in an xSeries 220 server:

1. Review the safety information beginning on page v.
2. Turn off the server and attached devices, and disconnect all external cables and power cords.
3. Remove the server from the rack cabinet (if applicable).
4. Remove the server cover. For instructions, see the documentation that comes with your server.

5. Remove the rear adapter retaining bracket from the server, as shown in the following illustration.

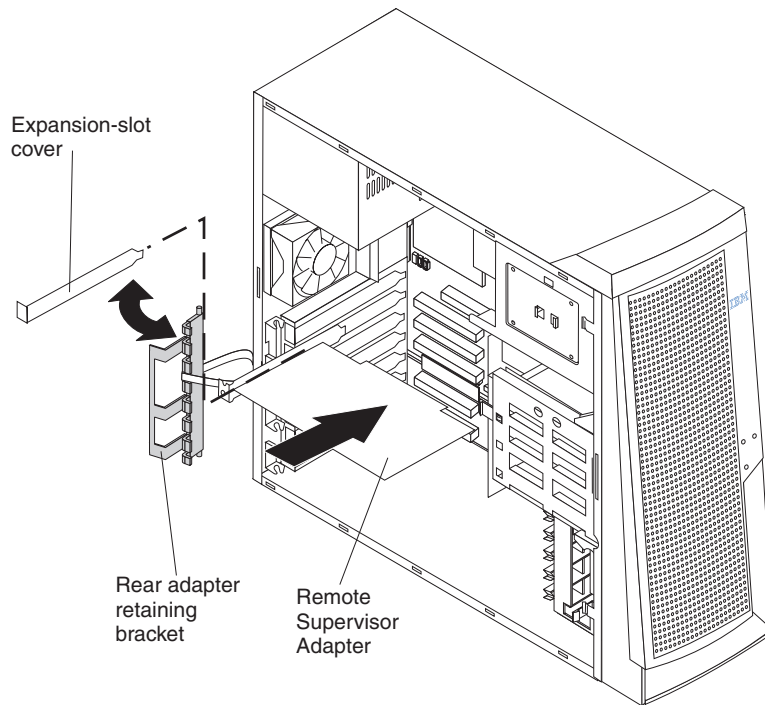

6. Remove the expansion-slot cover from PCI slot 2. Store it in a safe place for future use.

Note: You must install the Remote Supervisor Adapter in PCI slot 2.

Attention: Expansion-slot covers must be installed on all vacant slots. This maintains the electronic emission characteristics of the server and ensures proper cooling of server components.

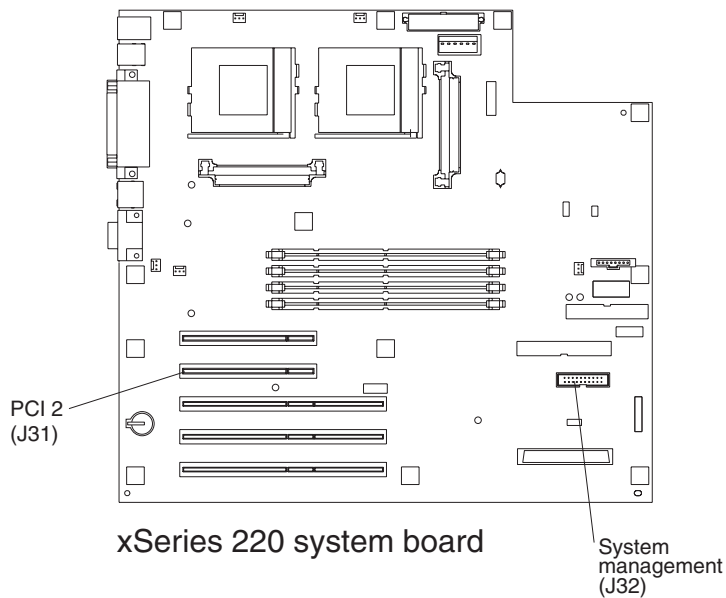

7. Remove the adapter from the static-protective package.

Attention: Avoid touching the components and gold-edge connectors on the adapter.

8. Install the adapter as follows:
 - a. Carefully grasp the adapter by its top edge or upper corners, and align it with PCI slot 2 on the system board.
 - b. Press the adapter firmly into the PCI slot.

Attention: When you install the adapter in the server, be sure that it is completely and correctly seated in the system-board connector before you apply power. Incomplete insertion might cause damage to the system board or the adapter.
9. Replace the rear adapter retaining bracket.
10. Connect the 20-pin ribbon cable according to the procedure in “Connecting the 20-pin ribbon cable” on page 19.
11. Replace the side cover.
12. Install the server in the rack cabinet (if applicable).
13. Connect the external cables and power cords that you disconnected in step 2 on page 11.
14. Continue with “Connecting the external power-supply adapter” on page 20.

xSeries 232 installation

Note: The illustrations in this document might differ slightly from your hardware.

Attention: When you handle static-sensitive devices, take precautions to avoid damage from static electricity. For details about handling static-sensitive devices, see “Handling static-sensitive devices” on page 5.

Complete the following steps to install the Remote Supervisor Adapter in an xSeries 232 server:

1. Review the safety information beginning on page v.
2. Turn off the server and attached devices, and disconnect all external cables and power cords.
3. Remove the server from the rack cabinet (if applicable).
4. Remove the server cover. For instructions, see the documentation that comes with your server.
5. Remove the adapter-retention bracket.
6. Remove the expansion-slot cover from PCI slot 1.

Note: You must install the Remote Supervisor Adapter in PCI slot 1.

Attention: You must install an expansion-slot cover in all vacant slots. This maintains the electronic emission characteristics of the server and ensures proper cooling of server components.

7. Remove the adapter from the static-protective package.

Attention: Avoid touching the components and gold-edge connectors on the adapter.

8. Install the adapter as follows:
 - a. Carefully grasp the adapter by its top edge or upper corners, and align it with the expansion slot.

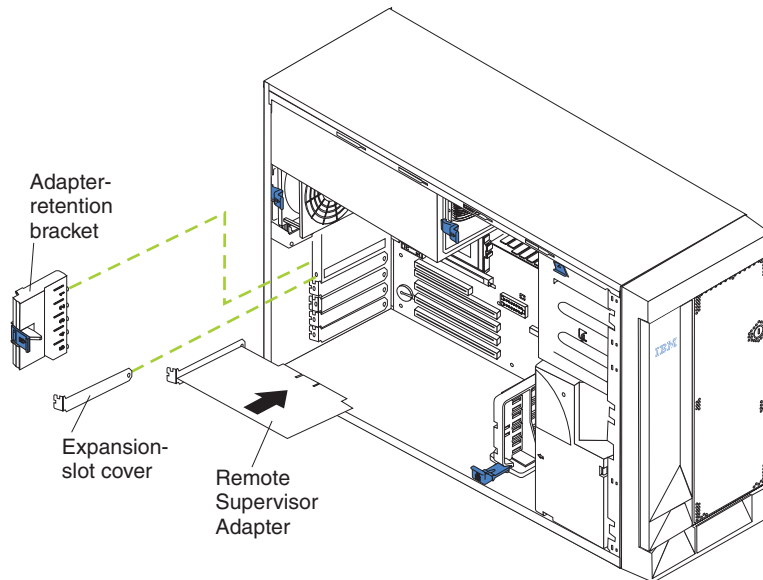

- b. Press the adapter *firmly* into the PCI slot.
 - c. Replace the adapter-retention bracket by aligning the bottom tabs of the adapter-retention bracket with the holes at the top of the expansion slots, and press the adapter-retention bracket toward the back of the server until it clicks into the locked position.
- Attention:** When you install the adapter in the server, be sure that it is completely and correctly seated in the connector before you apply power. Incorrect insertion might cause damage to the system board or the adapter.
9. Connect the 20-pin ribbon cable according to the procedure in “Connecting the 20-pin ribbon cable” on page 19.
 10. Replace the server cover.
 11. Install the server in the rack cabinet (if applicable).
 12. Connect the external cables and power cords that you disconnected in step 2 on page 13.
 13. Continue with “Connecting the LAN and serial cables” on page 22.

xSeries 330 installation

Note: The illustrations in this document might differ slightly from your hardware.

Attention: When you handle static-sensitive devices, take precautions to avoid damage from static electricity. For details about handling static-sensitive devices, see “Handling static-sensitive devices” on page 5.

Your server comes with riser cards installed in the two peripheral component interconnect (PCI) expansion slots on the system board.

The following illustration shows the location of the 33 MHz PCI expansion slots on the xSeries 330 system board. See Table 2 on page 10 for the correct PCI slot for your server.

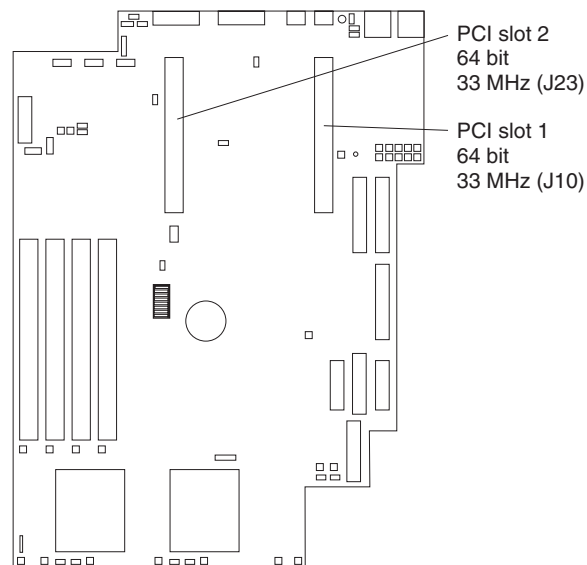

Complete the following steps to install the Remote Supervisor Adapter in an xSeries 330 server:

1. Review the safety information beginning on page v.
2. Turn off the server and attached devices, and disconnect all external cables and power cords.
3. Remove the server from the rack cabinet (if applicable).
4. Remove the server cover. For instructions, see the documentation that comes with your server.

5. Remove the expansion-slot clip that holds the expansion-slot cover in place by sliding it upward and off the frame of the server.

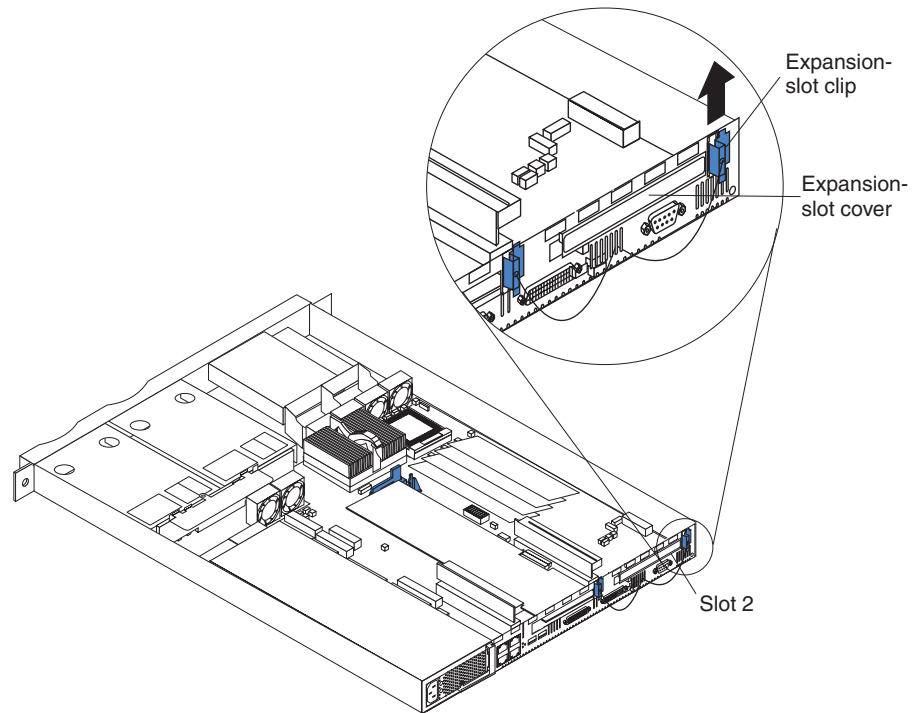

6. Remove the expansion-slot cover from the PCI slot. Store it in a safe place for future use.

Attention: There must be an expansion-slot cover in each vacant slot. This maintains the electronic emission characteristics of the server and ensures proper cooling of server components.

7. Remove the adapter from the static-protective package.

Attention: Avoid touching the components and gold-edge connectors on the adapter.

8. Install the adapter as follows:
 - a. Carefully grasp the adapter by its top edge or upper corners, and align it with the PCI slot connector on the PCI riser card.

Note: You must install the Remote Supervisor Adapter in PCI slot 1 for an xSeries 330 Type 8674 and in PCI slot 2 for Type 8654 and Type 8675.

- b. Press the adapter *firmly* into the PCI slot and replace the expansion-slot clip by sliding it down until it latches into place and securely holds the adapter.

Attention: When you install the adapter in the server, be sure that it is completely and correctly seated in the connector before you apply power. Improper insertion might cause damage.

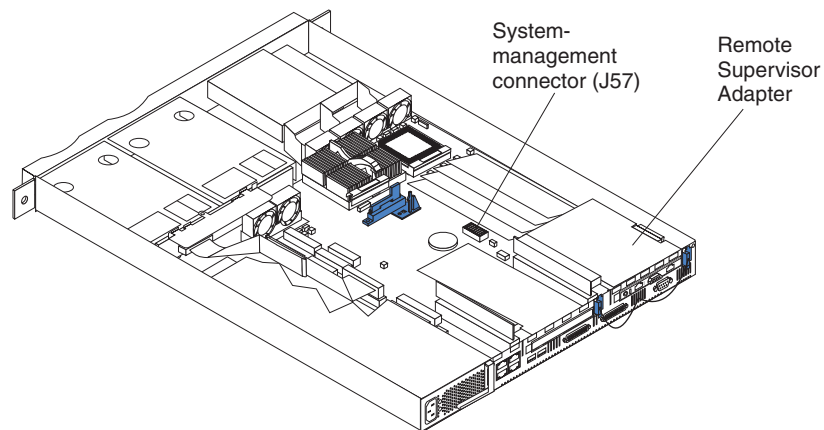

9. If the server is an xSeries 330 Type 8674 or Type 8675 (server type is located on the right-front side of the bezel), go to “Connecting the 20-pin ribbon cable” on page 19. The xSeries 330 Type 8674 and Type 8675 provide power to the Remote Supervisor Adapter through the 20-pin ribbon cable. Then, return here and continue with step 10.

If the server is an xSeries 330 Type 8654, continue with step 10.

10. Replace the cover on the server.
11. Install the server in the rack cabinet (if applicable).
12. Connect the external cables and power cords that you disconnected in step 2 on page 15.
13. If the server is an xSeries 330 type 8654, go to “Connecting the external power-supply adapter” on page 20.

If the server is an xSeries 330 Type 8674 or Type 8675, connecting the power-supply adapter is optional. Connecting the power-supply adapter to the Remote Supervisor Adapter when it is not required for your server provides redundant power and access to the Remote Supervisor Adapter event log when the main server power source is unavailable.

If you are not connecting the power-supply adapter, go to “Using the ASM link cable and ASM interconnect module with an xSeries 330 server” on page 22.

xSeries 342 installation

Note: The illustrations in this document might differ slightly from your hardware.

Attention: When you handle static-sensitive devices, take precautions to avoid damage from static electricity. For details about handling static-sensitive devices, see “Handling static-sensitive devices” on page 5.

Complete the following steps to install the Remote Supervisor Adapter in an xSeries 342 server:

1. Review the safety information beginning on page v.
2. Turn off the server and attached devices, and disconnect all external cables and power cords.
3. Remove the server from the rack cabinet (if applicable).
4. Remove the server cover. For instructions, see the documentation that comes with your server.
5. Remove the expansion-slot cover from PCI slot 1.
 - a. Loosen and remove the screw on the top of the expansion-slot cover.
 - b. Slide the expansion-slot cover out of the server. Store it in a safe place for future use.

Attention: Expansion-slot covers must be installed in all vacant slots. This maintains the electronic emission characteristics of the server and ensures proper cooling of server components.

6. Remove the adapter from the static-protective package.

Attention: Avoid touching the components and gold-edge connectors on the adapter.

7. Install the adapter as follows:
 - a. Carefully grasp the adapter by its top edge or upper corners, and align it with the expansion slot.

Note: You must install the Remote Supervisor Adapter in PCI slot 1.

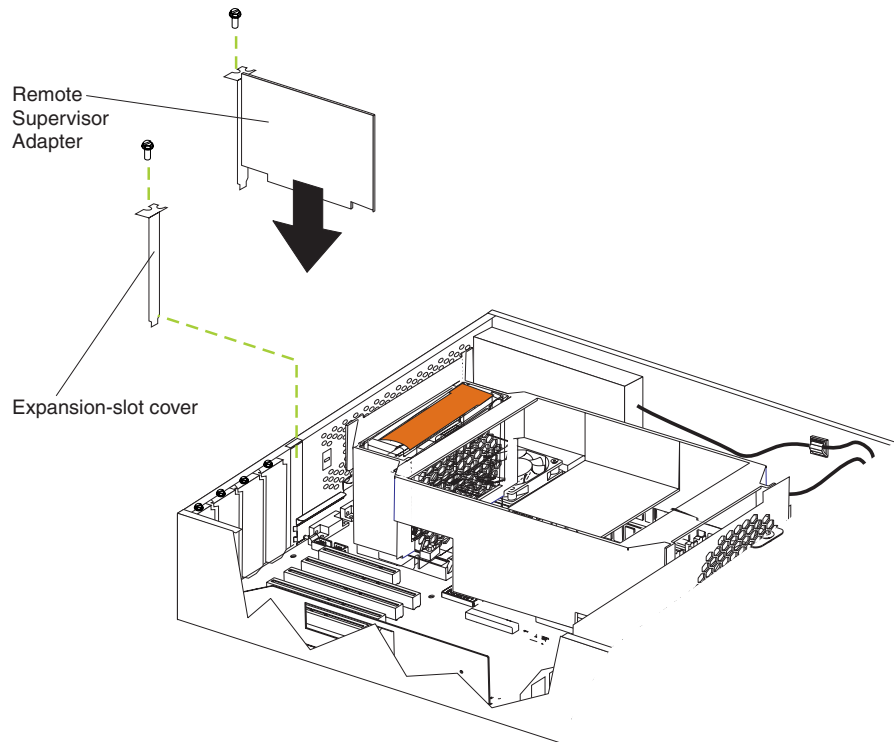

b. Press the adapter *firmly* into the PCI slot.

Attention: When you install the adapter in the server, be sure that it is completely and correctly seated in the connector before you apply power. Incorrect insertion might cause damage to the system board or the adapter.

c. Insert and tighten the expansion-slot screw on the top of the adapter bracket.

8. Connect the 20-pin ribbon cable according to the procedure in “Connecting the 20-pin ribbon cable”.
9. Replace the server cover.
10. Install the server in the rack cabinet (if applicable).
11. Connect the external cables and power cords that you disconnected in step 2 on page 18.
12. Go to “Connecting the LAN and serial cables” on page 22.

Connecting the 20-pin ribbon cable

The 20-pin ribbon cable connects the Remote Supervisor Adapter to the server system board and is required in some servers for power and data transfer. To determine whether the 20-pin ribbon cable is required in your server, see Table 2 on page 10.

Complete the following steps to connect the 20-pin ribbon cable from the Remote Supervisor Adapter to the server system board, if required for your server:

1. Connect one end of the 20-pin ribbon cable to the system-management connector on the Remote Supervisor Adapter. The 20-pin ribbon cable

connector ends are keyed for proper installation.

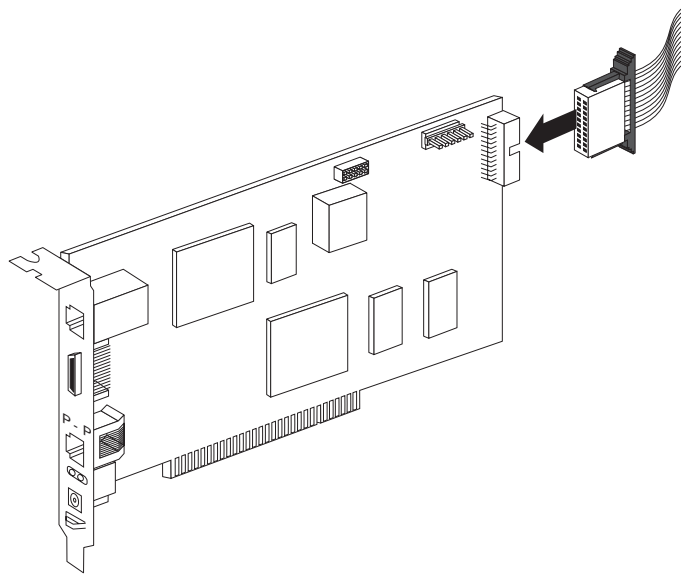

2. Connect the other end of the 20-pin ribbon cable to the system-management connector on the system board. For the connector location on your server system board, see Table 2 on page 10.

Attention: Route cables so that they do not block the flow of air from the fans.

Connecting the external power-supply adapter

Some servers require the external power-supply adapter (which comes with the Remote Supervisor Adapter) to provide the needed power for full functionality of the Remote Supervisor Adapter. After you connect the power-supply adapter to the Remote Supervisor Adapter, you can use the power cord to connect the power-supply adapter to a properly grounded electrical outlet. You can use the universal power cord that comes with the Remote Supervisor Adapter to connect the power-supply adapter to a power distribution unit (PDU) or to an uninterruptible power supply.

Note: Connecting the power-supply adapter to the Remote Supervisor Adapter when it is not required for your server provides access to the Remote Supervisor Adapter event log when the main server power source is unavailable.

To determine whether the power-supply adapter is required for your server, see Table 2 on page 10.

Complete the following steps to connect the power-supply adapter and power cord to your server:

1. Connect the power-supply control cable to the external power-supply connector on the Remote Supervisor Adapter.

The following illustration shows the location of the power-supply connector on a Remote Supervisor Adapter installed in a tower model server.

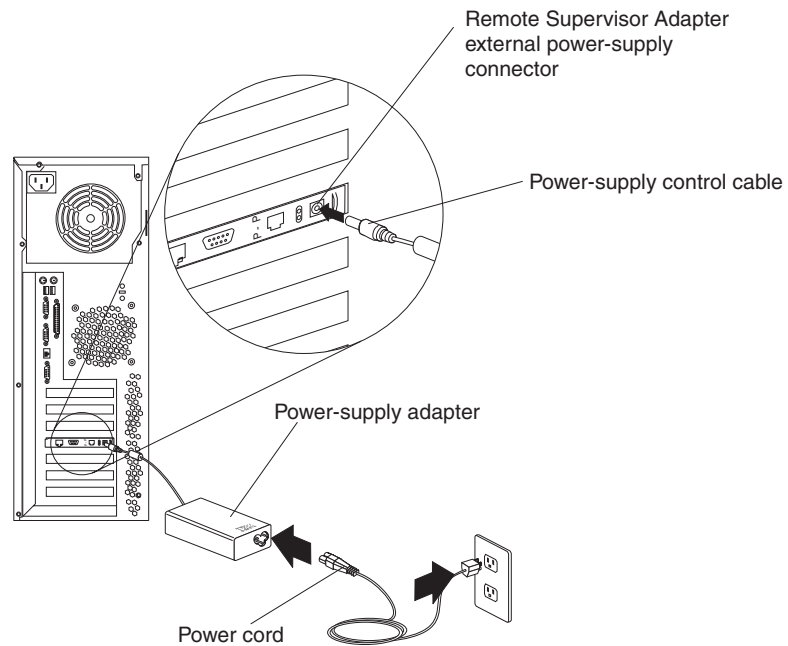

The following illustration shows the location of the power-supply connector on a Remote Supervisor Adapter installed in a rack-mounted server.

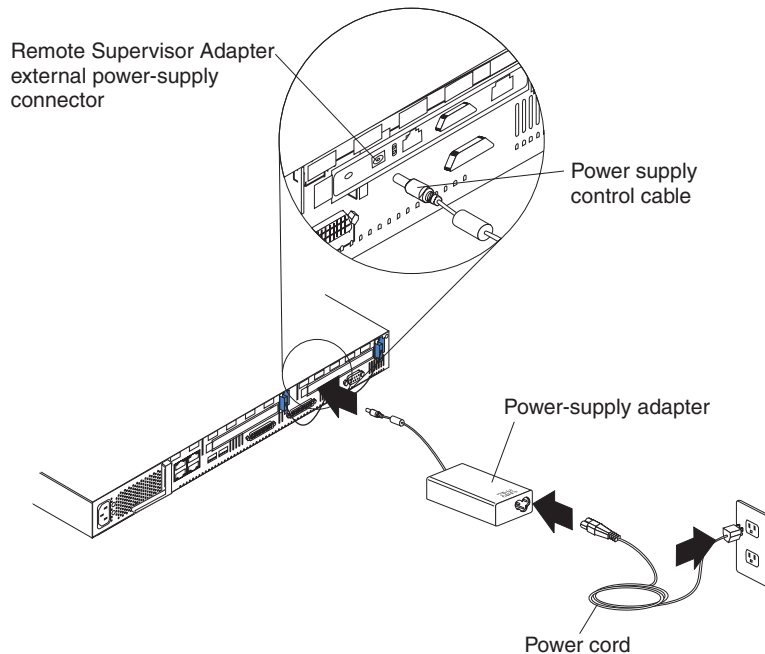

2. Connect one end of the power cord to the connector on the power-supply adapter.
3. Connect the other end of the power cord to a properly grounded electrical outlet.

Note: You can connect one end of the universal power cord to the power-supply adapter; then, connect the other end to a power distribution unit (PDU) or to an uninterruptible power supply.

4. Turn on the server.

5. Make sure that the Remote Supervisor Adapter power LED is lit. To find the location of the power LED, see the illustration in “Cabling the Ethernet LAN connector” on page 23.

Using the ASM link cable and ASM interconnect module with an xSeries 330 server

The ASM link cable and the ASM interconnect module provide communication between the Remote Supervisor Adapter and the integrated ASM processor on the system board of an xSeries 330 server. The ASM link cable and the ASM interconnect module come with the Remote Supervisor Adapter.

You also need to use the ASM link cable to connect an xSeries 330 or an xSeries 335 server to an ASM interconnect network. For information about using the ASM link cable on an ASM interconnect network, see Chapter 4, “Using the ASM interconnect network” on page 41.

Complete the following steps to connect the ASM link cable and the ASM interconnect module to the Remote Supervisor Adapter:

1. Connect the ASM interconnect module to the Remote Supervisor Adapter ASM RS-485 connector, as shown in the following illustration.

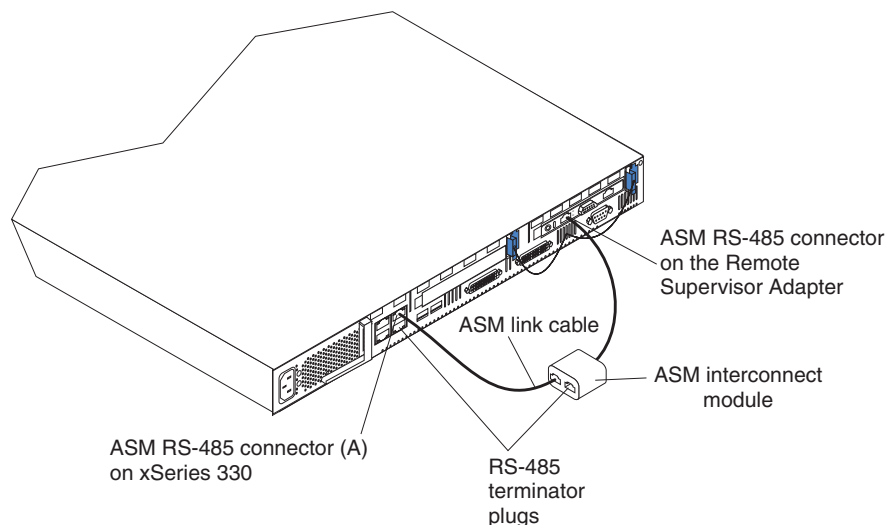

2. Connect one end of the ASM link cable (Category 3 or Category 5 Ethernet cable that comes with the Remote Supervisor Adapter) to the RS-485 connector (A) on the server.
3. Connect the other end of the ASM link cable to the ASM interconnect module.
4. Continue with “Connecting the LAN and serial cables”.

Connecting the LAN and serial cables

You can manage your server remotely through the Remote Supervisor Adapter using the connections and user interfaces that are described in Table 3 on page 23. Choose the interface method you want to use to perform remote management; then, perform the indicated cabling procedure.

Table 3. Cabling tasks to enable remote access to the Remote Supervisor Adapter

User interface to Remote Supervisor Adapter	Connection to Remote Supervisor Adapter	For the cabling procedure, see:
ASM Web interface over Ethernet	LAN using the Ethernet connector	“Cabling the Ethernet LAN connector” on page 23
Text-based user interface using the Telnet protocol over Ethernet		
Text-based user interface using a modem or a null modem	Serial connector	“Cabling the serial connector” on page 24
ASM Web interface using point-to-point (PPP) protocol		
Text-based user interface using the Telnet protocol over PPP		

Before you begin cabling your servers, and if you plan to set up an ASM interconnect network, go to Chapter 4, “Using the ASM interconnect network” on page 41 for instructions about cabling the ASM interconnect connector and setting up the network. You might want to review the configuration examples in Chapter 4 before you connect the cables. Then, return here to continue the cabling procedures.

Cabling the Ethernet LAN connector

Complete the following steps to connect the Remote Supervisor Adapter to your network using an Ethernet cable.

Attention: To avoid damage to the Ethernet connector on the Remote Supervisor Adapter, do not connect the ASM interconnect module into the Ethernet connector (RJ-45).

1. Connect one end of a Category 3 or Category 5 Ethernet cable to the Ethernet connector on the Remote Supervisor Adapter. Connect the other end of the Ethernet cable to your network.

2. Check the Remote Supervisor Adapter Ethernet LEDs. The location of the LEDs is shown in the following illustration.

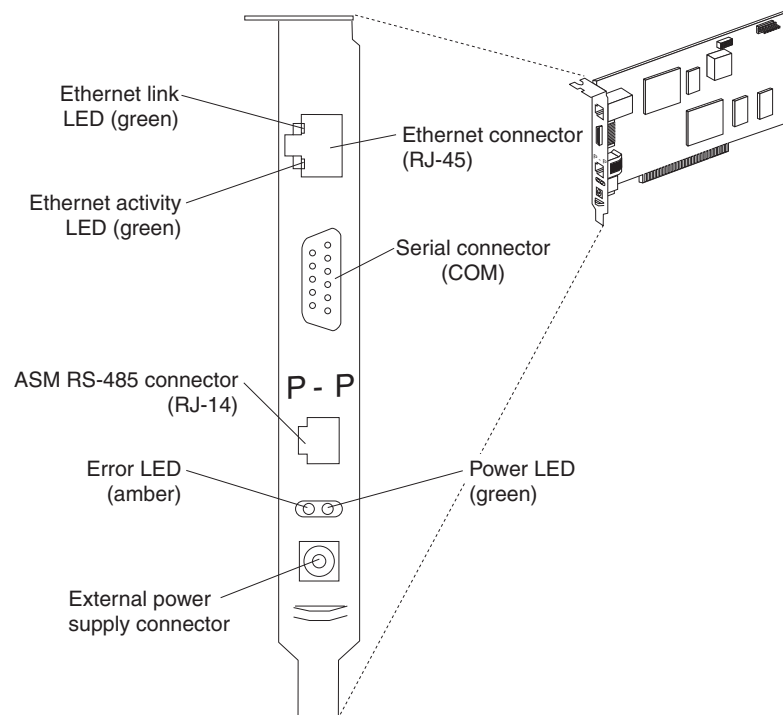

Ethernet link LED

The green Ethernet link LED is lit when the Ethernet cable is connected properly.

Ethernet activity LED

The green Ethernet activity LED is flashing when there is Ethernet activity.

If you want to use the serial connector, continue with “Cabling the serial connector” on page 24; otherwise, go to Chapter 3, “Using the Remote Supervisor Utility and configuring the adapter” on page 25.

Cabling the serial connector

To manage your server remotely using the serial connector, connect a modem or null modem cable to the serial connector on the Remote Supervisor Adapter.

Continue with Chapter 3, “Using the Remote Supervisor Utility and configuring the adapter” on page 25.

Chapter 3. Using the Remote Supervisor Utility and configuring the adapter

This chapter discusses how to use the IBM Remote Supervisor Utility to update the Remote Supervisor Adapter firmware and enable remote access, and how to install device drivers.

The Remote Supervisor Utility program is on the *IBM Remote Supervisor Adapter Support* CD that comes with the Remote Supervisor Adapter.

Updating the Remote Supervisor Adapter firmware

You must install the latest level of firmware on the Remote Supervisor Adapter for full feature support. You can obtain the latest firmware code from <http://www.ibm.com/pc/support/> IBM Support Web site. You can use the IBM Remote Supervisor Utility program to check the firmware level on the Remote Supervisor Adapter and to update the firmware.

Note: After using the Remote Supervisor Utility program to configure the Remote Supervisor Adapter to enable remote access, you can update the Remote Supervisor Adapter firmware using the ASM Web interface. For information about using the ASM Web interface, see the *IBM Remote Supervisor Adapter User's Guide*.

Complete the following steps to update the Remote Supervisor Adapter firmware using the Remote Supervisor Utility program:

1. If you have not already done so, turn on the server.
2. Insert the *IBM Remote Supervisor Adapter Support* CD into the CD-ROM drive. Be sure to close the CD-ROM drive before the server power-on self-test (POST) is completed.

Note: If you do not insert the CD and close the CD-ROM drive before POST is completed, you must restart the server with the CD in the CD-ROM drive.

- The CD starts automatically and the IBM Remote Supervisor Utility window opens.



- Use the Up Arrow and Down Arrow keys (↑ and ↓) to select **Update System Management Firmware**; then, press Enter. The Firmware Update Options Menu window opens.
- Use the arrow keys to select **Normal Flash - All subsystems**; then, press Enter.
- The Firmware Update Status window opens and displays a message to confirm that you want to update the firmware. Press Enter. The system updates the Remote Supervisor Adapter firmware.
- When the Remote Supervisor Adapter firmware update process is completed, press Enter to return to the utility program main window.
- Continue with “Enabling remote access to the adapter”.

Enabling remote access to the adapter

The Remote Supervisor Adapter requires configuration to enable remote access through the Ethernet and serial connectors. From Table 4, choose the interface method that you want to use to perform remote management; then, perform the indicated configuration procedure.

Table 4. Configuration tasks to enable remote access to the Remote Supervisor Adapter

User interface to Remote Supervisor Adapter	Connection to Remote Supervisor Adapter	For the configuration procedure, see:
ASM Web interface over Ethernet	LAN using the Ethernet connector	“Configuring the Ethernet settings” on page 27
Text-based user interface using the Telnet protocol over Ethernet		

Table 4. Configuration tasks to enable remote access to the Remote Supervisor Adapter (continued)

User interface to Remote Supervisor Adapter	Connection to Remote Supervisor Adapter	For the configuration procedure, see:
Text-based user interface using a modem or a null modem	Serial connector	“Configuring the serial connector” on page 29 and “Setting up point-to-point protocol” on page 30
ASM Web interface using point-to-point (PPP) protocol		
Text-based user interface using the Telnet protocol over PPP		

For detailed information about using the ASM Web interface and the text-based user interface, see the *IBM Remote Supervisor Adapter User's Guide*.

Configuring the Ethernet settings

If you have an accessible, active, and configured dynamic host configuration protocol (DHCP) server on your network, the hostname, IP address, gateway address, and subnet mask are set automatically. You do not need to perform further configuration tasks to enable the Ethernet connection because the default value for the **DHCP Setting** field is Enabled. If you want to configure the serial connector, go to “Configuring the serial connector” on page 29; otherwise, go to “Configuring the remote-control password” on page 38.

Complete the following steps to configure the Ethernet settings if you do not have a DHCP server on your network. If you completed a procedure and the utility program main window is open, go to step 3.

1. If you have not already done so, turn on the server.
2. Insert the *IBM Remote Supervisor Adapter Support* CD into the CD-ROM drive. Be sure to close the CD-ROM drive before the server POST is completed. The CD starts automatically and the IBM Remote Supervisor Utility window opens.

Note: If you do not insert the CD and close the CD-ROM drive before POST is completed, you must restart the server with the CD in the CD-ROM drive.

3. Use the Up Arrow and Down Arrow keys (↑ and ↓) to select **Configuration Settings**; then, press Enter. The Configuration Settings window opens.
4. Use the arrow keys to select **Ethernet Settings**; then, press Enter. The Ethernet Settings window opens.

Note: The values in the following window are only examples; your settings will be different.

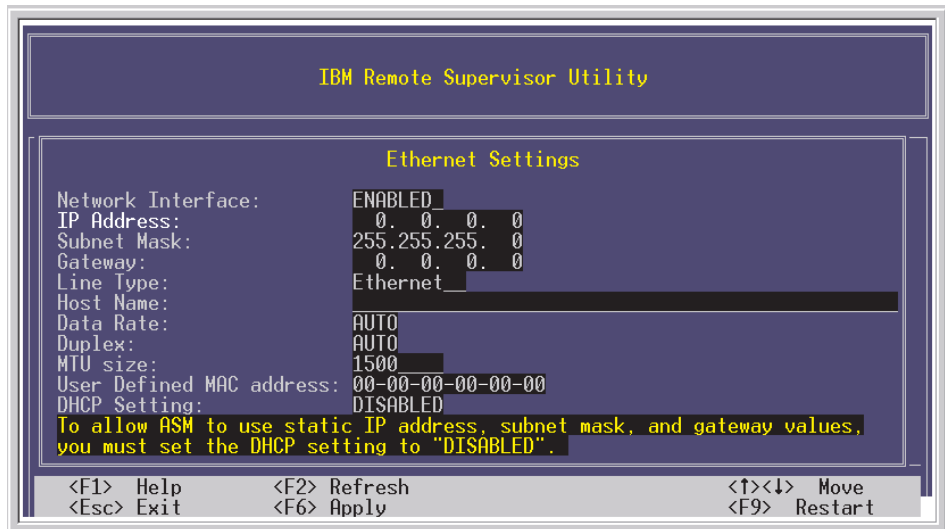

5. Use the arrow keys to navigate to each field. Your system administrator can provide the information for the following fields:

Network Interface

The default value is Enabled; verify that it is still set to Enabled.

IP Address

Type the IP address of the Remote Supervisor Adapter.

Subnet Mask

Type the subnet mask used by the Remote Supervisor Adapter. The default value is 255.255.255.0.

Gateway

Type the IP address of the gateway.

Host Name

Type the hostname of the Remote Supervisor Adapter. The default hostname is ASMA<burned-in MAC address>.

For detailed information about the Ethernet settings, see the *IBM Remote Supervisor Adapter User's Guide*.

6. Change the **DHCP Setting** field to **Disabled**. The default value is Enabled.
7. Press F6 to apply the change.
8. Press Esc. In the Warning window that opens, press Enter to restart the Remote Supervisor Adapter.
9. Press Esc to return to the Configuration Settings window.
If you want to configure the serial connector, go to "Configuring the serial connector" on page 29.
10. Press Esc to return to the utility program main window.
11. Use the arrow keys to select **Exit Utility** from the menu or press Esc to close the utility program.
12. Remove the CD from the CD-ROM drive and press Enter. The server restarts automatically.

- Continue with “Installing ASM processor device drivers in xSeries 330 servers” on page 32 or “Installing adapter device drivers in other supported xSeries servers” on page 32.

Configuring the serial connector

Complete the following steps to configure the Remote Supervisor Adapter serial connector for access using a modem or null modem. If you completed a procedure and the utility program main window is open, go to step 3; if the Configuration Settings window is open, go to step 4.

- Turn on the server.
- Insert the *IBM Remote Supervisor Adapter Support* CD into the CD-ROM drive. Be sure to close the CD-ROM drive before the server POST is completed. The CD starts automatically, and the IBM Remote Supervisor Utility window opens.

Note: If you do not insert the CD and close the CD-ROM drive before POST is completed, you must restart the server with the CD in the CD-ROM drive.

- Use the Up Arrow and Down Arrow keys (↑ and ↓) to select **Configuration Settings**; then, press Enter.

The Configuration Settings window opens.

- Use the arrow keys to select **Modem Settings**; then, press Enter.

The Modem Settings window opens.

Note: The values in the following window are only examples; your settings might be different.

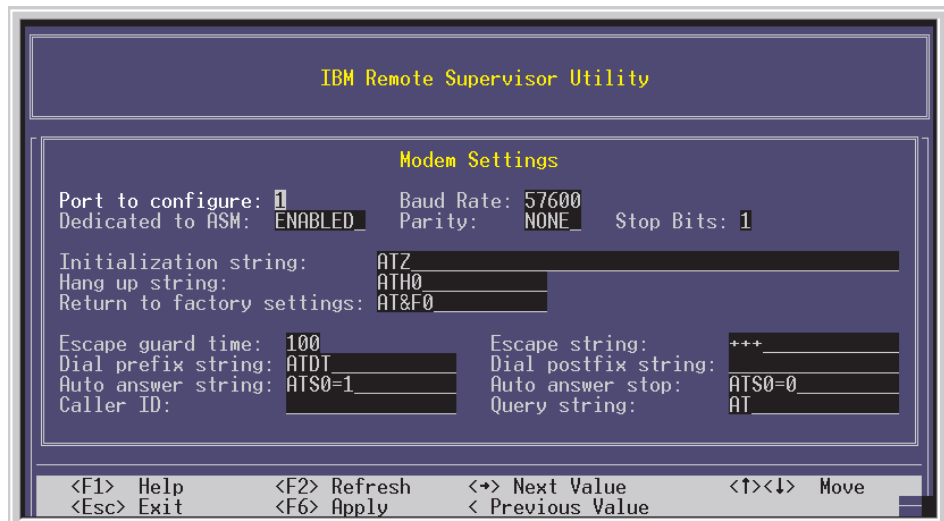

- Verify the following serial connector values:

Baud Rate

The default is 57600. Make sure that the baud rate matches the baud rate of the device you are connecting to the serial connector on the Remote Supervisor Adapter.

Dedicated to ASM (not available for all servers)

The default is Disabled. If you are using point-to-point protocol (PPP), set this field to Enabled.

You can dedicate the integrated serial connector on the Remote Supervisor Adapter to system management or share it with the

operating system. If the serial connector is dedicated to system management, it serves only the Remote Supervisor Adapter and is always available for dial-in or dial-out alerting purposes. You cannot view the serial connector using the operating system or any application.

If the serial connector is shared with the operating system, it is dedicated to the Remote Supervisor Adapter only while the server is turned off or during POST. The connector is made available to the operating system after POST is completed. You can use the serial connector from the operating system or any application. The Remote Supervisor Adapter takes over the connector from the operating system only when information about a critical event is received. The Remote Supervisor Adapter dials out and transmits an alert and keeps the connector dedicated until the server is restarted. The connector is no longer available to the operating system or applications.

Note: For the operating system and the Remote Supervisor Adapter to share the serial connector, you must install the Remote Supervisor Adapter device drivers. If the Remote Supervisor Adapter device drivers are not installed, the serial connector is dedicated to the Remote Supervisor Adapter only.

Parity

The default is None.

Stop Bits

The default is 1.

Note: The data bits value is preset to 8 and cannot be changed.

For detailed information about the serial connector and modem settings, see the *IBM Remote Supervisor Adapter User's Guide*.

6. If you made changes to the serial connector settings, press F6 to apply the change.
7. Press Esc to return to the Configuration Settings window.
If you want to set up point-to-point protocol, go to "Setting up point-to-point protocol".
8. Press Esc to return to the utility program main window.
9. Use the arrow keys to select **Exit Utility** from the menu, or press Esc to close the utility program.
10. Remove the CD from the CD-ROM drive and press Enter. The Remote Supervisor Adapter restarts automatically.
11. Continue with "Installing ASM processor device drivers in xSeries 330 servers" on page 32 or "Installing adapter device drivers in other supported xSeries servers" on page 32.

Setting up point-to-point protocol

The Remote Supervisor Adapter serial connector supports point-to-point protocol (PPP). PPP enables TCP/IP communication over the serial connector, which enables Web-based management and Telnet sessions over a modem.

Complete the following steps to set up PPP. If you completed a procedure and the utility program main window is open, go to step 3; if the Configuration Settings window is open, go to step 4 on page 31.

1. If you have not already done so, turn on the server.
2. Insert the *IBM Remote Supervisor Adapter Support* CD into the CD-ROM drive. Be sure to close the CD-ROM drive before the server POST is completed. The CD starts automatically and the IBM Remote Supervisor Utility window opens.

Note: If you do not insert the CD and close the CD-ROM drive before POST is completed, you must restart the server with the CD in the CD-ROM drive.

3. Use the Up Arrow and Down Arrow keys (↑ and ↓) to select **Configuration Settings**; then, press Enter.

The Configuration Settings window opens.

4. Use the arrow keys to select **PPP Settings**; then, press Enter.

The PPP Settings window opens.

Note: The values in the following window are only examples; your settings will be different.

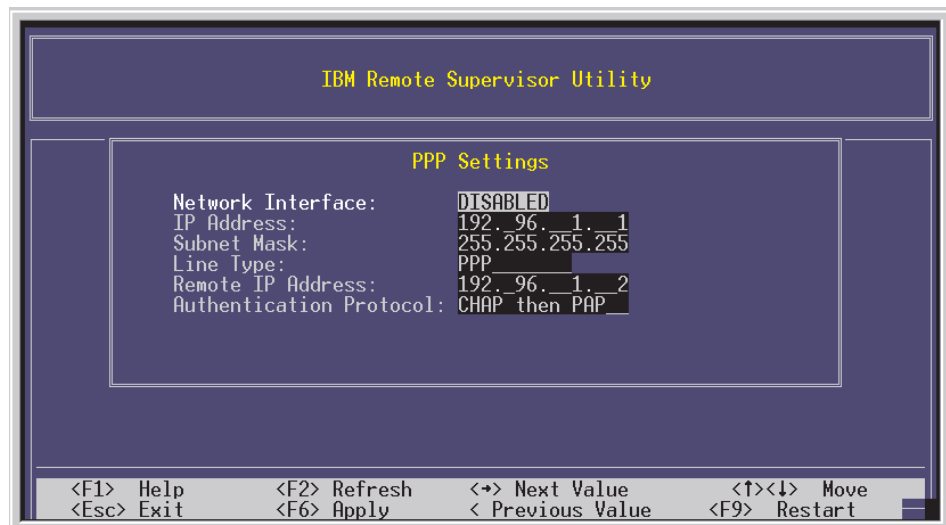

5. Use the arrow keys to navigate to each field. Verify the values in the following fields:

Network Interface

The default is Disabled. Change this field to Enabled.

IP Address

The default value is 192.96.1.1. You can use the default or another IP address, but the server must be able to establish a connection to that address. The default IP address (local and remote) is easily reconfigurable.

Subnet Mask

The default value is 255.255.255.255.

Line Type

The value is set to PPP.

Remote IP Address

The default value is 192.96.1.2.

Authentication Protocol

The default setting is challenge handshake authentication protocol (CHAP) then privileged access protection (PAP). Make sure that the value in this field matches your client settings.

For detailed information about the PPP settings, see the *IBM Remote Supervisor Adapter User's Guide*.

6. Press F6 to apply the changes.
7. Press Esc. In the Warning window that opens, press Enter to restart the Remote Supervisor Adapter.
8. Press Esc to return to the Configuration Settings window.
If you want to configure the serial connector, go to "Configuring the serial connector" on page 29.
9. Press Esc to return to the utility program main window.
10. Use the arrow keys to select **Exit Utility** from the menu or press Esc to close the utility program.
11. Remove the CD from the CD-ROM drive and press Enter. The server restarts automatically.
12. Continue with "Installing ASM processor device drivers in xSeries 330 servers" or "Installing adapter device drivers in other supported xSeries servers" on page 32.

Installing ASM processor device drivers in xSeries 330 servers

The Remote Supervisor Adapter controls and communicates with xSeries 330 servers through the ASM processor that is integrated on the system board. The ASM processor device drivers are specifically designed to work with this integrated ASM processor. If this is the first time you are setting up your xSeries 330 server, or if you previously set up this server without using the ServerGuide program, you must install the ASM processor device drivers to perform the following functions:

- In-band management
- Operating system shutdown
- Operating system watchdog
- Loader watchdog

The ASM processor device drivers come with your xSeries 330 server. For more information, see the documentation that comes with the server.

Continue with "Completing the installation" on page 39.

Installing adapter device drivers in other supported xSeries servers

The Remote Supervisor Adapter device drivers enable communication between the Remote Supervisor Adapter and the operating system of the server in which the Remote Supervisor Adapter is installed. You must install the Remote Supervisor Adapter device drivers to perform the following functions:

- In-band management
- Operating system shutdown
- Operating system watchdog
- Loader watchdog
- Redirect server console

The device drivers are included on the *IBM Remote Supervisor Adapter Support CD* that comes with the adapter. You can also obtain the latest device drivers from the <http://www.ibm.com/pc/support/> IBM Support Web site.

The following sections describe the procedures for installing the Remote Supervisor Adapter device drivers for the supported operating systems.

Notes:

1. If you are installing device drivers manually, note the following information:
 - Make sure that the operating system is installed on your server before you install the Remote Supervisor Adapter device drivers. For information about installing the operating system, see the documentation that comes with your server.
 - Be sure to stop any system-management application (for example, IBM Netfinity[®] Director, IBM Director, or Universal Manageability [UM] Services) before installing the device drivers on the Remote Supervisor Adapter. For information about IBM system-management applications, see your server documentation.
2. If you are installing device drivers using the ServerGuide program, note the following information:
 - To install the operating system using the ServerGuide program, use ServerGuide version 6.0.3, or later. If you install the Remote Supervisor Adapter and then install Microsoft Windows NT or Windows 2000 using ServerGuide version 6.0.3 or later, the Advanced System Management device drivers are installed automatically.
 - If you previously installed the operating system with ServerGuide version 6.0.2, make sure that you install the Advanced System Management device drivers from the *IBM Remote Supervisor Adapter Support CD*, not from the directory that ServerGuide 6.0.2 created on the hard disk during its installation of the operating system. You can also obtain the latest device drivers from the <http://www.ibm.com/pc/support/> IBM Support Web site.

After you install the Advanced System Management device drivers, go to “Configuring the remote-control password” on page 38 to set the remote control password.

Installing Windows 2000 device drivers

Complete the following steps to install the Advanced System Management device drivers for Windows 2000.

- If you are installing the ASM device drivers from a diskette, at the Windows 2000 command prompt, type
`a:\win2000\setup`
where *a* is the diskette drive letter.
- If you are installing the ASM device drivers from the *IBM Remote Supervisor Adapter Support CD*, at the Windows 2000 command prompt, type
`d:\dd\win2000\setup`
where *d* is the CD-ROM drive letter.

Note: During the installation of the ASM device drivers, the Windows 2000 Hardware wizard might start because it has detected the ASM hardware. To close the wizard, click **Cancel**. The actions of the wizard are not needed.

Continue with “Configuring the remote-control password” on page 38.

Installing Windows NT device drivers

To install the Advanced System Management device drivers for Windows NT, use one of the following methods:

- Non-interactive

The non-interactive method for installing the Advanced System Management device drivers accepts the default values for any window prompts that appear. You are prompted to respond only if an error occurs during installation.

- Interactive

The normal, or interactive method, prompts you with instructions and waits for you to respond before continuing with the installation.

Using the non-interactive method

Complete the following steps to use the non-interactive method:

1. Open a Windows NT command prompt; then, type one of the following commands:
 - If the installation is from a diskette, type
`a:\NT\SETUP -q`
where *a* is the drive letter assigned to your diskette drive, and press Enter.
 - If the installation is from a CD, type
`d:\DD\NT\SETUP -q`
where *d* is the drive letter assigned to your CD-ROM drive, and press Enter.
2. Follow the instructions that appear in the window.
3. Continue with “Configuring the remote-control password” on page 38.

Using the interactive method

Complete the following steps to use the interactive method:

1. Open a Windows NT command prompt; then, type one of the following commands:
 - If the installation is from a diskette, type
`a:\NT\SETUP`
where *a* is the drive letter assigned to your diskette drive, and press Enter.
 - If the installation is from a CD, type
`d:\DD\NT\SETUP`
where *d* is the drive letter assigned to your CD-ROM drive, and press Enter.
2. Follow the instructions that appear in the window.
3. Continue with “Configuring the remote-control password” on page 38.

Installing Linux device drivers

Use the information in this section to install the Advanced System Management device drivers for Linux.

Note: The server on which the source Red Hat Package Manager (RPM) file is run must have Linux development and build capability. Make sure that the Linux kernel source is installed and is properly configured for your hardware. If you intend to use the remote mouse and keyboard capabilities in an X Window System environment, you will also need the X development headers and libraries. For more information, see “Kernel configuration notes” on page 36.

The source RPM file (ibmasm-src-[redhat/suse]) contains the open source code for the IBM Advanced System Management device drivers for Linux. The file is

designed for installation using the RPM build system. Running the RPM utility against `ibmasm-src-[redhat/suse]` the first time builds Linux device drivers that are customized for the Linux kernel version of the server running the RPM utility. Running the RPM utility does not install device drivers on the build server; however, it generates a second RPM file that you can install on a server that is running the same Linux kernel and that has the same hardware configuration.

Notes:

1. Be sure to follow the Linux Advanced System Management device driver installation procedures in the order given.
2. If you are upgrading an existing Advanced System Management device driver, you must first remove the previously installed device driver packages. Depending upon your server configuration, you might see messages about missing files when running the `rpm -e` commands. You can ignore these messages.

Type the following two commands at a shell prompt to remove the previously installed device driver source and binaries:

```
rpm -e ibmasm
rpm -e ibmasm-src[redhat/suse]
```

To install the source RPM file for SuSE Linux, type the following command:

```
rpm -ivh ibmasm-src-suse-WRPxxxA.rpm
```

where `xxx` is the version of the source RPM file that you are installing.

To install the source RPM file for Red Hat Linux (other than version 6.2), type the following command:

```
rpm -ivh ibmasm-src-redhat-WRPxxxA.rpm
```

where `xxx` is the version of the source RPM file that you are installing.

To install the source RPM file for Red Hat Linux version 6.2, type the following commands:

```
ln -s /usr/src/linux /lib/modules/'uname -r'/build
rpm -ivh ibmasm-src-redhat-WRPxxxA.rpm
```

where `xxx` is the version of the source RPM file that you are installing.

The above RPM files will create a binary RPM file in the `/usr/local/ibmasm` directory that you must use to install the device driver.

To install the binaries, type the following commands:

```
cd /usr/local/ibmasm
ls -l ibmasm*.rpm
```

(The previous command enables you to see the version number.)

```
rpm -ivh ibmasm-1.0-y.y.i386.rpm
```

where `y.y` is the version of the binary RPM file that you are installing.

This RPM file creates `/usr/local/ibmasm/ibmasm.tgz`; decompresses and unpacks the archive in the same location; copies the device drivers, shared library, and all

configuration files to their appropriate locations; cleans up (remove files that are no longer required); and loads the device drivers.

The device drivers are configured to start when the server is started and to stop when the server is restarted or shut down.

To uninstall, type the following commands:

```
rpm -e ibmasm
rpm -e ibmasm-src-[redhat/suse]
```

The RPM file unloads the device drivers and removes all ibmasm-related files from your server.

Note: Be sure to uninstall the device drivers with the `-e` switch before installing a new version, rather than upgrading with the RPM upgrade (`-U`) switch.

Kernel configuration notes

Note: You do not need to configure the Red Hat kernel sources for Linux if you installed them during your initial Linux installation. If you did not install kernel sources during your initial Red Hat Linux installation, or if you are using SuSE Linux, you will need to configure the kernel sources as described in the sections that follow.

To ensure that the correct kernel sources are installed, you might need to type the following commands, depending on the distribution that you are running.

For Red Hat Linux:

```
rpm -qa | grep kernel
```

Sample results:

Note: The results vary with different kernel versions.

```
kernel-headers-2.4.2-2
```

```
kernel-source-2.4.2-2
```

```
kernel-smp-2.4.2-2
```

```
kernel-2.4.2-2
```

Make sure that kernel headers and kernel-source RPM packages are present and that they match your kernel version number.

If you installed the kernel sources after the initial Linux installation, you must configure them. Type the following commands:

```
cd /lib/modules/'uname -r'/build
make mrproper
```

Type one of the following commands based on your hardware configuration (the exact file names might vary):

```
cp -f configs/kernel-2.4.2-i586.config arch/i386/defconfig
cp -f configs/kernel-2.4.2-i586-smp.config arch/i386/defconfig
cp -f configs/kernel-2.4.2-i686-enterprise.config arch/i386/defconfig
```

```
make oldconfig
make dep
```

For SuSE Linux:

```
rpm -qa | grep kernel
```

Sample results:

Note: The results vary with different kernel versions.

```
kernel-source-2.4.4-SuSE17
```

SuSE Linux is configured with YaST. Use it to install the appropriate kernel source files. After installation, type the following commands to configure the kernel sources:

```
cd /lib/modules/'uname -r'/build
cp -f/boot/vmlinuz.version.h /lib/modules/'uname -r'/build/include/linux/version.h
cp -f/boot/vmlinuz.config /lib/modules/'uname -r'/build/.config
make cloneconfig
make dep
make menuconfig
```

Click **Exit** in the "menuconfig" panel and click **Yes** when prompted to save the configuration.

Remote mouse and keyboard notes

The remote mouse and keyboard functions can be built with both a text-based virtual terminal and with X Window System support if your development system has the appropriate X development header files and libraries installed. These files are installed if you select the development system options during the installation of the operating system.

User name and password limitation for GUI login

If the semi-graphics mode that SuSE Linux uses causes trouble with the remote mouse and keyboard operation, delete the line `vga=788` from `/etc/lilo.conf` and run the `lilo` command.

Installing Novell NetWare device drivers

Complete the following steps to install the Advanced System Management device drivers for the Novell NetWare operating system:

1. From a system console session, type one of the following commands:
 - If the installation is from a diskette, type
`LOAD a:\NETWARE\SETUP`
where *a* is the drive letter assigned to your diskette drive, and press Enter.
 - If the installation is from a CD, type
`LOAD d:\DD\NETWARE\SETUP`
where *d* is the drive letter assigned to your CD-ROM drive, and press Enter.
2. Follow the instructions that appear in the window.
3. Continue with "Configuring the remote-control password" on page 38.

Installing SCO UnixWare or Caldera Open UNIX device drivers

Complete the following steps to install the SCO UnixWare or Caldera Open UNIX Advanced System Management device drivers:

1. Open a shell prompt.
2. Mount the installation media as in the following examples.

Note: The commands in the following examples are case-sensitive.

- If you are mounting from diskette drive 0, type

```
mount -F dosfs /dev/fd0/ mnt
```

- If you are mounting from the default CD-ROM drive, type

```
mount -F cdfs -o -ro /dev/cdrom/ c1b0t010 /mnt
```

3. Install the ASM device drivers. If you are installing from either a diskette or CD, type

```
pkgadd -d /mnt/UW7ADVMG/UW7ADVMG.DS
```

4. Follow the instructions that are displayed in the window.
5. Continue with “Configuring the remote-control password”.

Configuring the remote-control password

If you want to use the remote-control features of the Remote Supervisor Adapter ASM Web interface, you must configure the remote-control password. The remote-control password is configured locally on the server in the basic input/output system (BIOS) setup menu (accessed by pressing F1 during POST).

Note: The remote-control feature is not available on all servers.

Complete the following steps to set up a remote-control password:

1. Turn on the server, and watch the monitor screen.
2. When the message Press F1 for Configuration/Setup is displayed, press F1. The Configuration/Setup Utility main menu window opens.
3. Use the Up Arrow and Down Arrow keys (↑ and ↓) to select **System Security**; then, press Enter. The System Security window opens.
4. Select **Remote Control Security Settings**; then, press Enter. The Remote Control Security Settings window opens.
5. Enter the remote control password that you will use each time you log in to the remote control features of the Remote Supervisor Adapter ASM Web interface. Select the **failed login threshold count** field to set how many times a password can be tried before login fails. Select the **automatic lockout delay** field to configure the timeout period for an automatic lockout delay.
6. Select **Save New Remote Control Password**; then, press Enter.
7. In the System Security window, press Esc.
8. Select **Save Settings**; then, press Enter.
9. Confirm your selection; then, exit the Configuration/Setup Utility.
10. Continue with “Completing the installation” on page 39.

Completing the installation

Complete the following steps to finish the installation of the Remote Supervisor Adapter:

1. If you did not restart the server after installing the ASM device drivers, restart the server now.

Note: You do not need to restart the server if you are running the Windows NT operating system.

2. See the *IBM Remote Supervisor Adapter User's Guide* for detailed instructions about completing the configuration of the Remote Supervisor Adapter features. These features include the following:
 - Defining the login IDs and passwords
 - Selecting the events that will receive alert notification
 - Monitoring remote server status using the ASM Web interface or a text-based user interface
 - Controlling the server remotely

If you want to set up an ASM interconnect network and have not already done so, go to Chapter 4, "Using the ASM interconnect network" on page 41. If you do not want to set up an ASM interconnect network, your installation is now completed.

Chapter 4. Using the ASM interconnect network

This chapter includes information about how to configure and connect your server to function within an ASM interconnect network.

Overview

You can connect system-management processors and adapters together to form an ASM interconnect network. *System-management processors and adapters* are Remote Supervisor Adapters, ASM processors, ASM PCI adapters, and integrated system management processors (ISMPs). These system-management processors and adapters are also known as *service processors*.

An ASM interconnect network provides two levels of functionality. First, the ASM interconnect network enables you to configure settings and to control the servers in which other system-management processors and adapters reside. Second, the ASM interconnect network enables other system-management processors and adapters to use the resources (Ethernet or modem) of other Remote Supervisor Adapters, ASM processors (modems only), and ASM PCI adapters in the ASM interconnect network for sending alerts. This interconnect network is used when system-management processors or adapters cannot send an alert and must forward the information to another system-management processor or adapter to send the alert.

Planning and cabling your ASM interconnect network

To support the most recent ASM features, a Remote Supervisor Adapter must be the main gateway to your ASM interconnect network if the network also includes servers with ASM PCI adapters, ASM processors, or ISMPs. The Remote Supervisor Adapter forwards the ASM information generated by the servers attached to the ASM interconnect network to other servers on your Ethernet network or that are attached through a modem. The connected ASM processors, ASM PCI Adapters, and ISMPs are managed through the user interface and Web browser access of the Remote Supervisor Adapter.

Before cabling the ASM interconnect network, review the following information:

- You must connect an ASM interconnect module to the Remote Supervisor Adapter.
- The cables in an ASM interconnect network are hot-swappable.
- Make sure that the firmware for the Remote Supervisor Adapter, ASM processor, ASM PCI adapter, and ISMP are at the latest level.
- The servers in an ASM interconnect network are referred to by their assigned names, not by their positions in the rack cabinet.

An ASM interconnect network can have up to 24 RS-485 connections, depending on the configuration. The connections can include Remote Supervisor Adapters, ASM processors, ASM PCI adapters, and ISMPs. Use the following information to determine the number of servers and connections that you can have on your ASM interconnect network:

- Each Remote Supervisor Adapter, ASM processor, ASM PCI adapter, and ISMP in a server that is connected to the network uses one connection. For example, if a server that is connected to the network has a Remote Supervisor Adapter and an integrated ASM processor, the server uses two connections on the network.

- The network must include at least one server with a Remote Supervisor Adapter (either installed as an option or preinstalled in the server).
- On an ASM interconnect network, one ASM processor or one ASM PCI adapter can communicate with 11 RS-485 connections. These connections must be to ASM processors, ASM PCI adapters, or Remote Supervisor Adapters. The ASM processor and ASM PCI adapter cannot communicate with ISMPs.
- If your existing ASM interconnect network has 12 RS-485 connections that include only ASM processors, ASM PCI adapters, and at least one Remote Supervisor Adapter, you can also add up to 12 ISMP-based servers to this same network. The Remote Supervisor Adapter on this network will communicate with all 23 RS-485 connections; however, an ASM processor or ASM PCI adapter on this network will communicate with only the 11 non-ISMP RS-485 connections. The ASM processor and ASM PCI adapter will not recognize the ISMPs, but the ISMPs can reside on the same ASM interconnect network.
- Make sure that the ASM interconnect network is set up as a bus, not as a ring. You must connect the servers to the ASM interconnect network in a series, with terminated beginning and end points. Be sure to use the RS-485 terminator plugs. For more information, see “Using the RS-485 terminator plugs on interconnected servers” on page 48.
- Make sure that the total combined length of all Ethernet cables connecting the servers in the ASM interconnect network does not exceed 91 m (300 ft).

Considerations when configuring xSeries 232 and xSeries 342 servers

You can connect xSeries 232 and xSeries 342 servers to an ASM interconnect network using the integrated system management processor (ISMP) connectors located on the back of those servers. If the ISMP firmware level is revision 6 or 8, you must update the ISMP firmware. Go to <http://www.ibm.com/pc/support/> to obtain the latest ISMP firmware and update instructions.

Attention:

1. If your server BIOS code level is earlier than revision 1.02, you must update your server BIOS code before you update the ISMP firmware. BIOS update diskettes and update instructions are on the IBM Support Web site.
2. Make sure that no servers or devices are connected to the server ISMP connectors when you update the ISMP firmware if its level is revision 6 or 8. You cannot update the firmware while devices are connected to the ISMP connectors.

You must connect at least one Remote Supervisor Adapter to the ASM interconnect network to support the connection of xSeries 232 and xSeries 342 servers using their ISMP connectors. If your Remote Supervisor Adapter firmware level is earlier than revision 17, you must update the Remote Supervisor Adapter firmware. Go to <http://www.ibm.com/pc/support/> to obtain the latest Remote Supervisor Adapter firmware and update instructions.

Considerations when configuring xSeries 335 servers

You can connect up to 24 xSeries 335 servers in an ASM interconnect network using one Remote Supervisor Adapter. However, if you use both xSeries 335 and other server models in the same interconnect network, the xSeries 335 servers must be installed at the end of the chain.

Notes:

1. An RS-485 terminator plug must be installed in the open RS-485 connector on the first server in the ASM interconnect network.
2. An xSeries 335 server is self-terminating; therefore, do not install an RS-485 terminator plug in the last open RS-485 connector in the ASM interconnect network.
3. The xSeries 335 uses Cable Chain Technology (C2T) for ASM interconnect connection. Follow the instructions for cabling a C2T chain in the documentation that comes with your xSeries 335 server.
4. Connect an ASM interconnect module (which comes with the Remote Supervisor Adapter) to the RS-485 connector on the Remote Supervisor Adapter in the first server. If the network contains more than 23 servers, do the same on the 24th server.
5. Connect an ASM link cable (which comes with the Remote Supervisor Adapter) from the ASM interconnect module to the integrated system management (ISM) connector in the first server on the interconnect network. Insert a terminator into the second connector on the ASM interconnect module. If the network contains more than 24 servers, do the same on the 25th server. Do not install an RS-485 terminator plug in the last xSeries 335 server, because the xSeries 335 server is self-terminating.
6. Your ASM interconnect network of xSeries 335 servers can include multiple Remote Supervisor Adapters. Use the following information to install and connect the Remote Supervisor Adapters:
 - You must install the Remote Supervisor Adapters starting with the first xSeries 335 server in the ASM interconnect network (typically the bottom server in a rack cabinet).
 - The xSeries 335 servers without Remote Supervisor Adapters must be together at the end of the C2T chain (or above the others in a rack cabinet).
 - Connect an ASM interconnect module to each Remote Supervisor Adapter.
 - For only the first xSeries 335 server with a Remote Supervisor Adapter, connect an ASM link cable from the ASM interconnect module to the ISM connector on the same server. (There is a C2T breakout cable connecting the monitor, keyboard, and pointing device to the C2T OUT connector on the first server.)
 - Using a Category 5 cable, connect the other Remote Supervisor Adapters to each other through their ASM interconnect modules.
 - Insert an RS-485 terminator plug in the open ASM interconnect module connector.

The following illustration shows an ASM interconnect network with three xSeries 335 servers and two xSeries 345 servers. The Remote Supervisor Adapter is installed in xSeries 335 server 1.

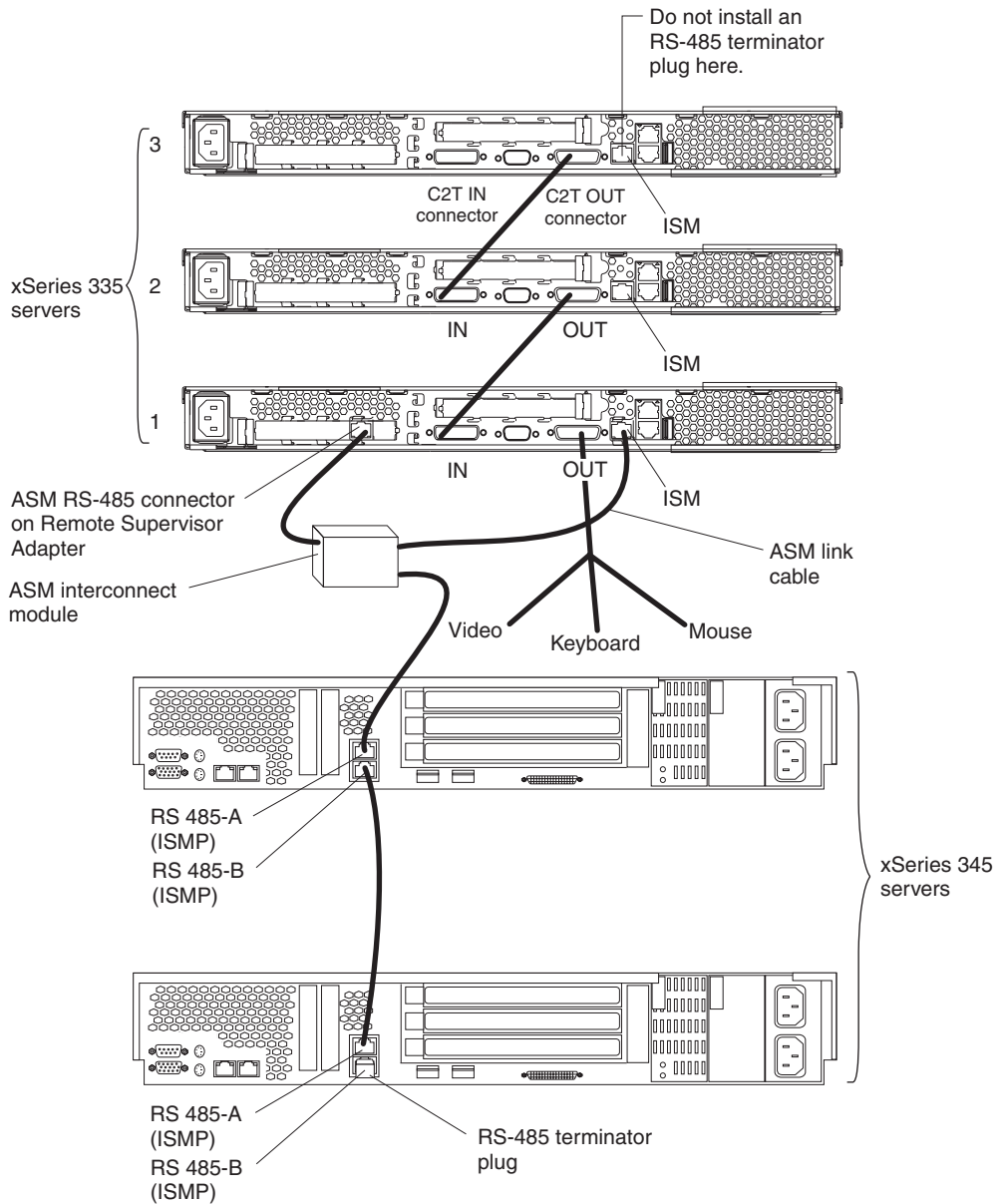

The following illustration shows an ASM interconnect network with three xSeries 335 servers and two xSeries 345 servers. The Remote Supervisor Adapter is installed in the bottom xSeries 345 server.

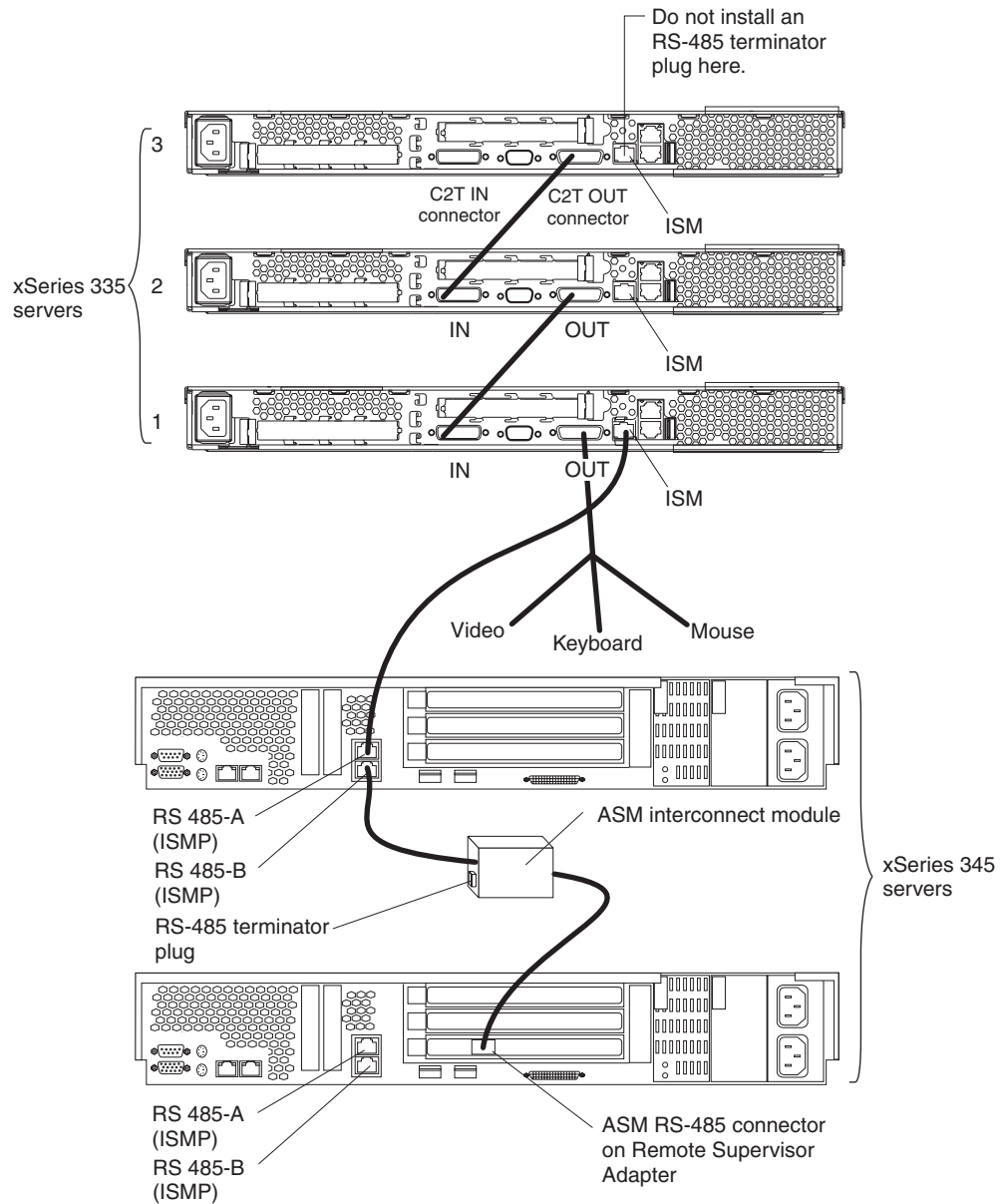

To interconnect 42 xSeries 335 servers in one rack cabinet, you must create two ASM interconnect networks. One interconnect network is limited to 24 system-management processors and adapters.

The following illustration shows an ASM interconnect network with 42 xSeries 335 servers.

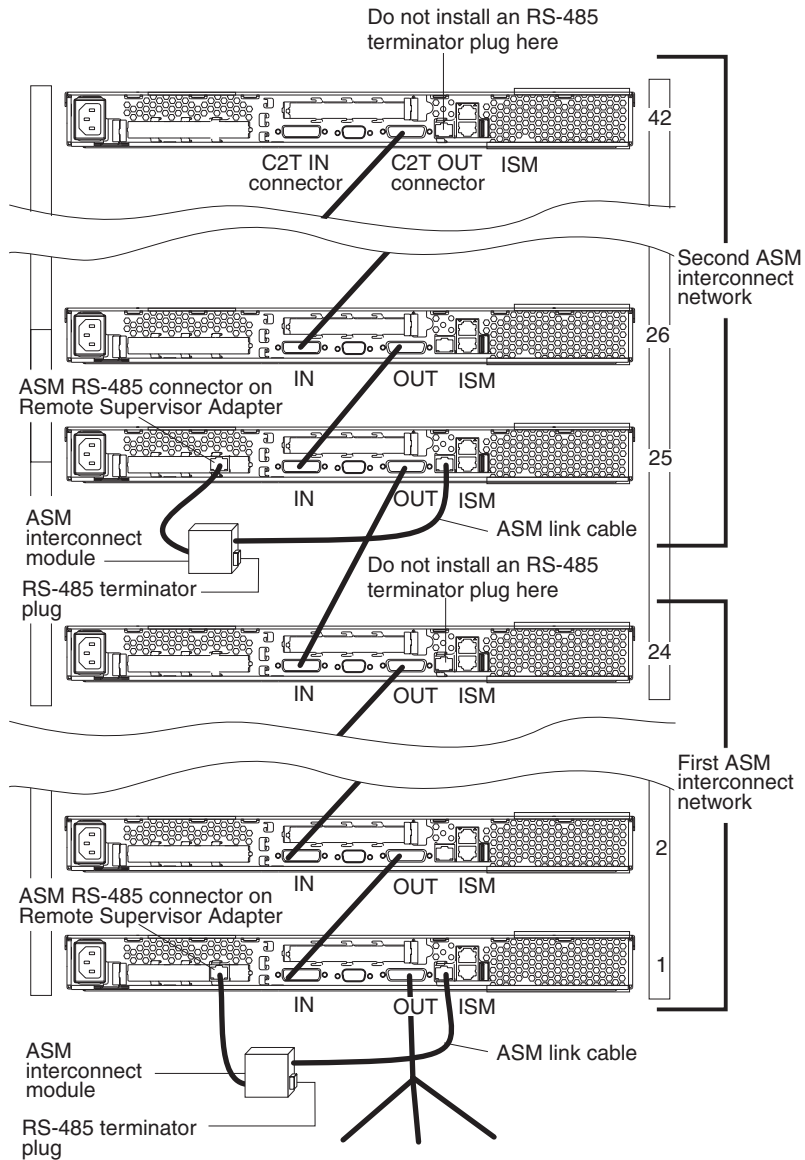

Forwarding alerts

Remote Supervisor Adapters, ASM PCI adapters, ASM processors, and ISMPs that are connected to an ASM interconnect network share resources and system-management information. This section provides information about how alerts are forwarded in the ASM interconnect network.

During normal operation, each Remote Supervisor Adapter, ASM processor, ASM PCI adapter, and ISMP on the ASM interconnect network communicates with the other processors and adapters on the network. Processors or adapters that have a modem or Ethernet connection notify the other processors and adapters that these communications resources are available for use by other servers on the ASM

interconnect network. These resources are then used as ASM interconnect network resources, enabling Remote Supervisor Adapters, ASM processors, ASM PCI adapters, and ISMPs on the ASM interconnect network to send alerts using a modem or the network, even if they do not have a modem or network connection physically attached.

Note: ISMPs can use the communications resources of a Remote Supervisor Adapter only.

When alerts are generated, they are forwarded to the Remote Supervisor Adapter, ASM processor, or ASM PCI adapter on the ASM interconnect network that has the communication resources to forward the alert. If no system on the ASM interconnect network meets the requirements, the alert is set for transmission if the connection type is configured or becomes available later.

If multiple modems or network connections exist in the ASM interconnect network, you cannot specify which system will receive an alert or which will use its modem or network connection to forward the alert. If an alert is forwarded to a Remote Supervisor Adapter, ASM processor, or ASM PCI adapter that is unable to deliver the alert (for example, the modem it is configured to use has failed or the network cannot resolve the destination IP address), the processor or adapter attempts to forward the alert to another system on the ASM interconnect network that has the communication resources to forward the alert.

Alerts are typically sent only once (per connection type), but an alert is forwarded to another interconnect device if the resources exist on other interconnect devices in the network. For example, on a three ASM processor network where ASM processor 1 generates a modem alert, but does not have a modem and the two other ASM servers with ASM processors have modems connected to them, the following might occur:

If ASM processor 1 generates an alert and the modem is unplugged from ASM processor 2 45 seconds or less prior to ASM processor 1 generating the alert, ASM processor 1 forwards the alert to ASM processor 2 having previously determined that ASM processor 2 had an available modem (which is now no longer available). When ASM processor 2 receives the forwarded alert, knowing its modem is not available, it determines that a modem is attached to ASM processor 3, and forwards the alert to ASM processor 3. Therefore, depending upon the time frame (45 seconds) within which a resource (modem) fails, the alert might be forwarded multiple times until a device on the interconnect network can send the alert.

Connecting the ASM interconnect module

The ASM interconnect module connects the Remote Supervisor Adapter to the ASM interconnect network. This module comes with the Remote Supervisor Adapter.

Complete the following steps to connect the ASM interconnect module to a Remote Supervisor Adapter installed in an xSeries server.

Attention: To avoid damage to the Ethernet connector, do not plug the ASM interconnect module into the Ethernet (RJ-45) connector.

1. Connect the ASM interconnect module to the Remote Supervisor Adapter ASM RS-485 connector. The RS-485 connector is labeled "P – P" (for peer-to-peer) on the back panel of the adapter.

The following illustration shows the location of the ASM RS-485 connector on a Remote Supervisor Adapter installed in a tower model server.

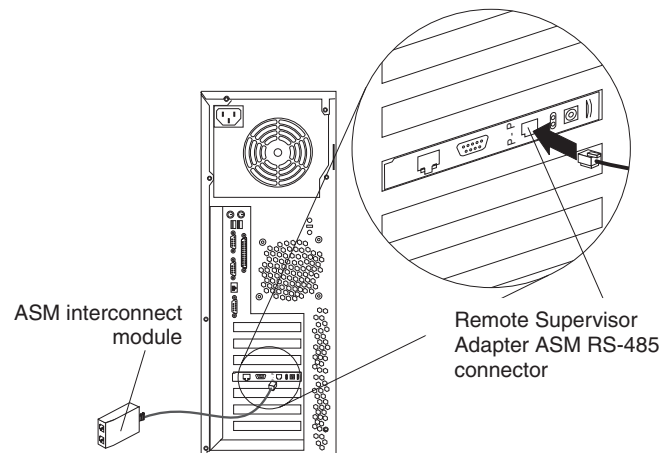

The following illustration shows the location of the ASM RS-485 connector on a Remote Supervisor Adapter installed in a rack-mounted server.

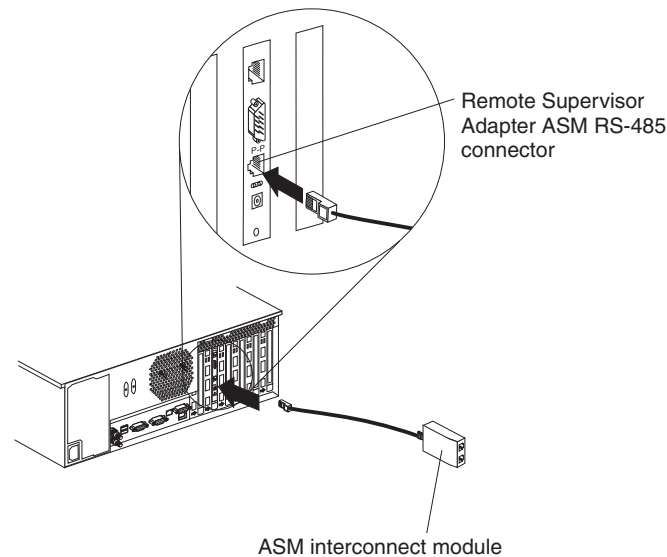

2. Connect one or two Category 3 or Category 5 Ethernet cables to the other end of the ASM interconnect module.

Using the RS-485 terminator plugs on interconnected servers

The Remote Supervisor Adapter comes with two RS-485 terminator plugs. To ensure successful RS-485 communication on your ASM interconnect network, you must install the terminator plugs in the open connectors at each end of the RS-485 bus. The illustrations in “ASM interconnect network configuration examples” on page 49 can help you determine where to put the RS-485 terminator plugs on your ASM interconnect network. For special considerations when interconnecting xSeries 335 servers, see “Considerations when configuring xSeries 335 servers” on page 42.

Note: An xSeries 335 server is self-terminating; therefore, do not install an RS-485 terminator plug in the last open RS-485 connector in the ASM interconnect network.

ASM interconnect network configuration examples

The illustrations in this section show sample ASM interconnect network configurations.

The following example shows a rack of xSeries 330 servers. The top server in the rack cabinet (Server 1) has a Remote Supervisor Adapter installed. The xSeries 330 with the Remote Supervisor Adapter will act as the gateway to the ASM interconnect network, forwarding system-management data generated by the other systems in the ASM interconnect network to the system-management administration system that is connected to the network. This example environment uses all xSeries 330 servers.

Note: You might need to obtain additional cables or connectors to set up the ASM interconnect network.

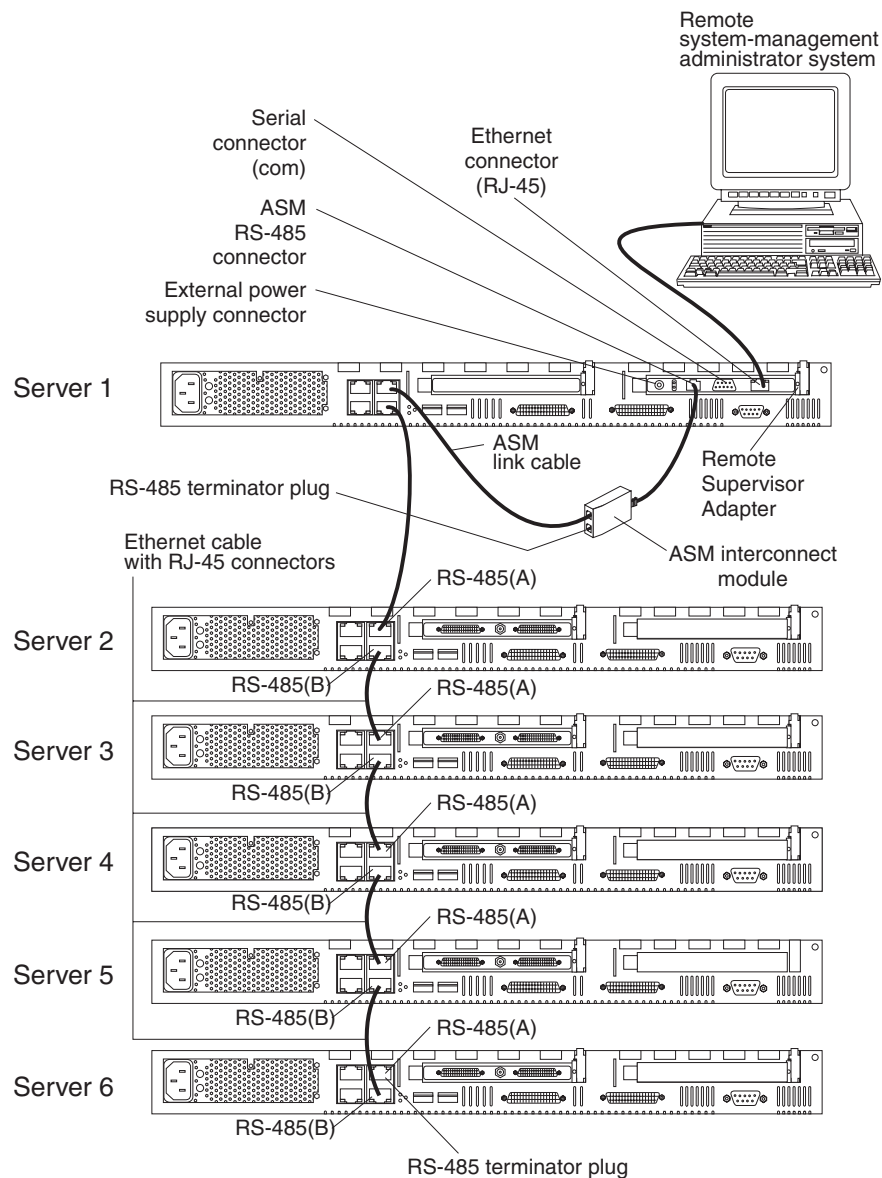

In the following example, an Ethernet cable connects the remote system management administrator's system to the Remote Supervisor Adapter that is installed in an xSeries 220. In this case, the xSeries 220 uses the LAN connection to forward system-management data generated by the other servers in the ASM interconnect network to the remote system-management administrator.

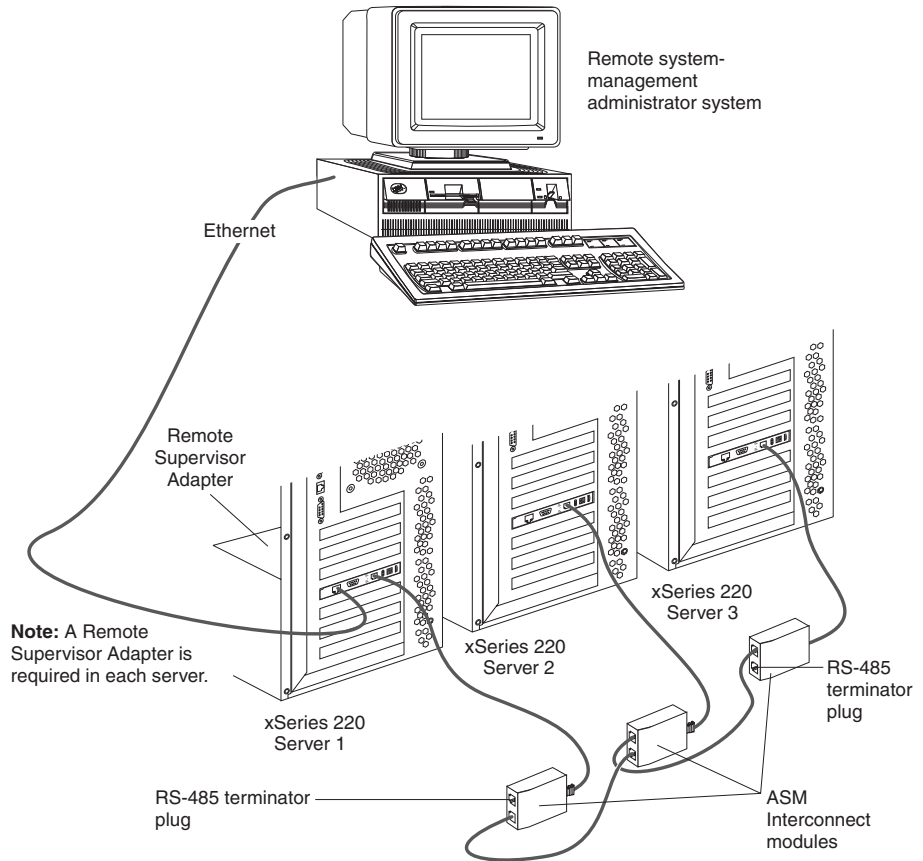

Note: An ASM interconnect module is connected to the ASM RS-485 connector on the back panel of the Remote Supervisor Adapter in each server.

In the following example, an Ethernet cable connects the remote system management administrator's system to the Remote Supervisor Adapter that is installed in an xSeries 342. In this case, the xSeries 342 uses the LAN connection to forward system-management data generated by the other servers in the ASM interconnect network to the remote system-management administrator.

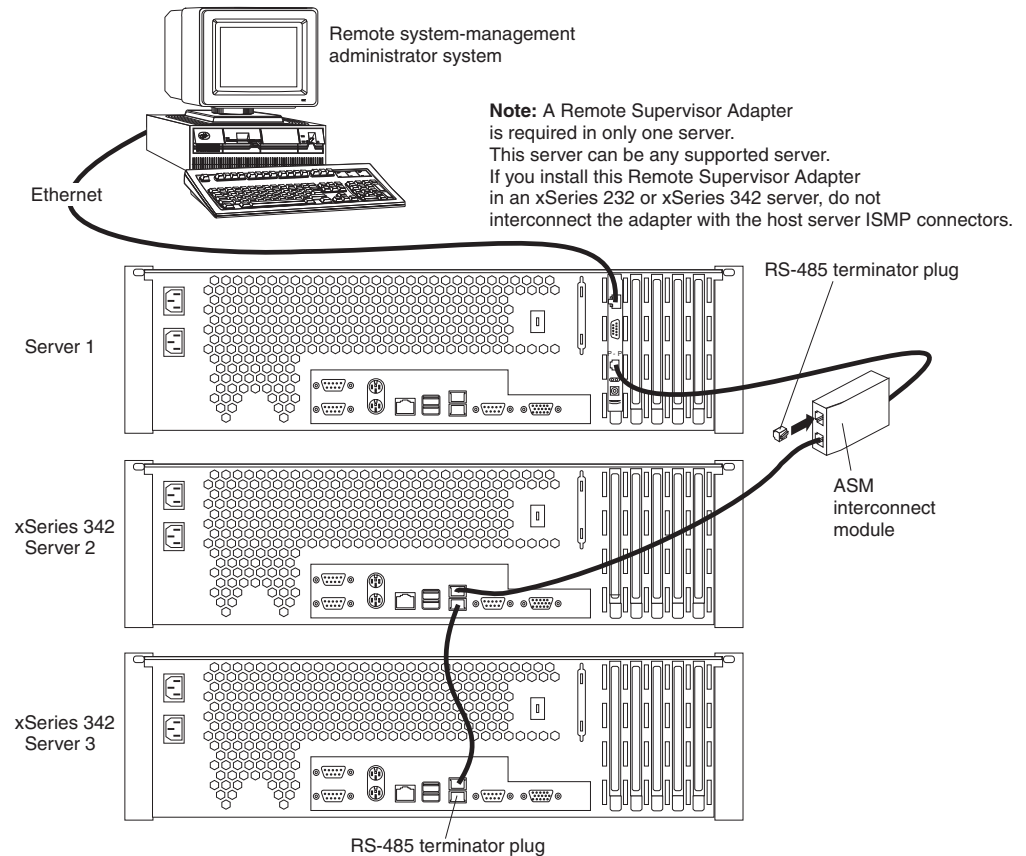

Note: An ASM interconnect module is connected to the ASM RS-485 connector on the back panel of the Remote Supervisor Adapter.

In the following example, a Remote Supervisor Adapter is installed in an xSeries 220, and creates an interconnect network with the xSeries 220 server and the xSeries 350 servers. A modem is connected to the serial connector of the Remote Supervisor Adapter, a modem is connected to the ASM PCI adapter in the server connected to the end of the ASM interconnect network, and a modem is connected to the remote system-management administrator's system. Placing modems at opposite ends of the ASM interconnect network bus ensures that if an ASM interconnect connection in the bus fails, all of the systems on the ASM interconnect network have access to a modem to forward system-management data to the remote system-management administrator. This example environment contains multiple server models.

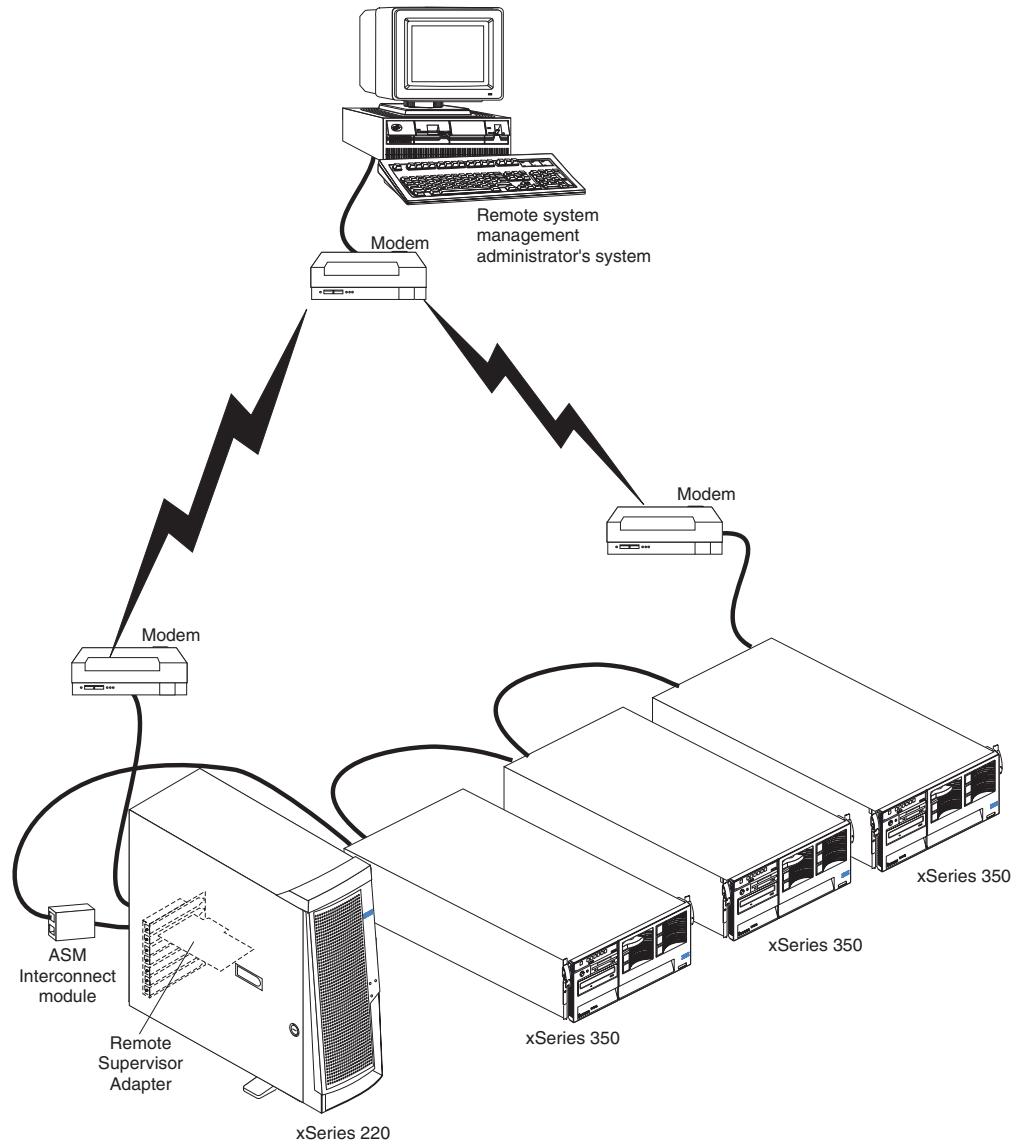

Note: For information about connecting a modem to the serial port on an xSeries 350, see the documentation that comes with the server.

In the following example, the ASM interconnect network includes three xSeries 360 servers. An Ethernet cable connects the remote system-management administrator system to the Remote Supervisor Adapters preinstalled in xSeries 360 Server 1. In this case, the xSeries 360 Server 1 uses a LAN connection to forward system-management data generated by the other servers in the ASM interconnect network bus to the remote system-management administrator.

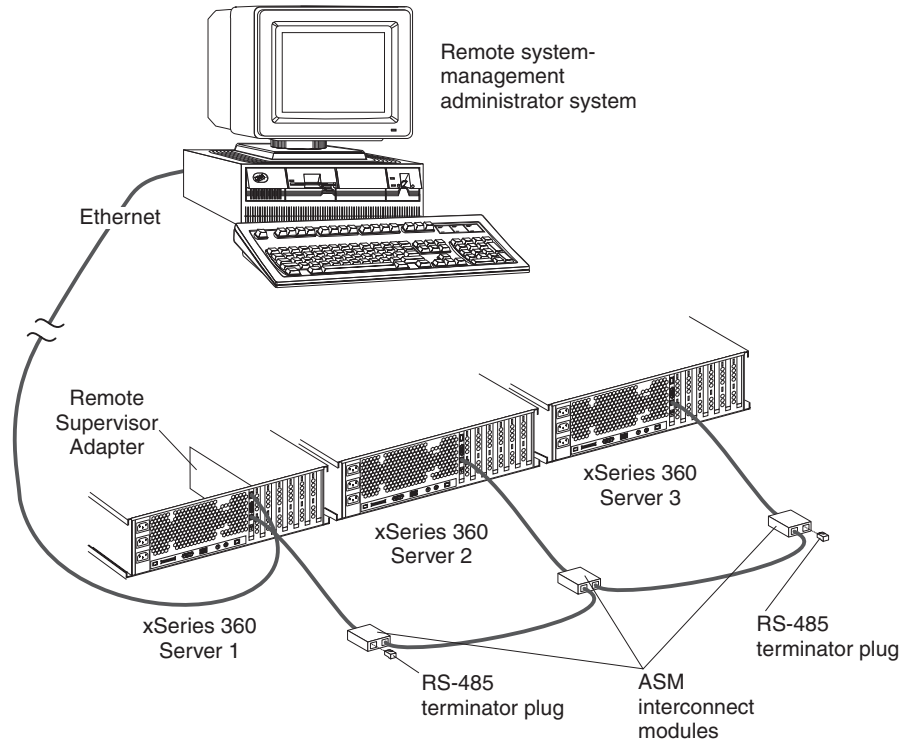

Note: An ASM interconnect module is connected to the RS-485 port on the back panel of the Remote Supervisor Adapter in each server.

Appendix A. Getting help and technical assistance

If you need help, service, or technical assistance or just want more information about IBM products, you will find a wide variety of sources available from IBM to assist you. This appendix contains information about where to go for additional information about IBM and IBM products, what to do if you experience a problem with your xSeries or IntelliStation[®] system, and whom to call for service, if it is necessary.

Before you call

Before you call, make sure that you have taken these steps to try to solve the problem yourself:

- Check all cables to make sure that they are connected.
- Check the power switches to make sure that the system is turned on.
- Use the troubleshooting information in your system documentation, and use the diagnostic tools that come with your system.
- Go to the IBM Support Web site at <http://www.ibm.com/pc/support/> to check for technical information, hints, tips, and new device drivers.
- Use an IBM discussion forum on the IBM Web site to ask questions.

You can solve many problems without outside assistance by following the troubleshooting procedures that IBM provides in the online help or in the publications that are provided with your system and software. The information that comes with your system also describes the diagnostic tests that you can perform. Most xSeries and IntelliStation systems, operating systems, and programs come with information that contains troubleshooting procedures and explanations of error messages and error codes. If you suspect a software problem, see the information for the operating system or program.

Using the documentation

Information about your IBM xSeries or IntelliStation system and preinstalled software, if any, is available in the documentation that comes with your system. That documentation includes printed books, online books, README files, and help files. See the troubleshooting information in your system documentation for instructions for using the diagnostic programs. The troubleshooting information or the diagnostic programs might tell you that you need additional or updated device drivers or other software. IBM maintains pages on the World Wide Web where you can get the latest technical information and download device drivers and updates. To access these pages, go to <http://www.ibm.com/pc/support/> and follow the instructions. Also, you can order publications through the IBM Publications Ordering System at <http://www.elink.ibm.com/public/applications/publications/cgibin/pbi.cgi>.

Getting help and information from the World Wide Web

On the World Wide Web, the IBM Web site has up-to-date information about IBM xSeries and IntelliStation products, services, and support. The address for IBM xSeries information is <http://www.ibm.com/eserver/xseries/>. The address for IBM IntelliStation information is <http://www.ibm.com/pc/intellistation/>.

You can find service information for your IBM products, including supported options, at <http://www.ibm.com/pc/support/>. If you click **Profile** from the support page, you can create a customized support page. The support page has many sources of information and ways for you to solve problems, including:

- Diagnosing problems, using the IBM Online Assistant
- Downloading the latest device drivers and updates for your products
- Viewing Frequently Asked Questions (FAQ)
- Viewing hints and tips to help you solve problems
- Participating in IBM discussion forums
- Setting up e-mail notification of technical updates about your products

Software service and support

Through IBM Support Line, you can get telephone assistance, for a fee, with usage, configuration, and software problems with xSeries servers, IntelliStation workstations, and appliances. For information about which products are supported by Support Line in your country or region, go to <http://www.ibm.com/services/sl/products/>.

For more information about Support Line and other IBM services, go to <http://www.ibm.com/services/>, or go to <http://www.ibm.com/planetwide/> for support telephone numbers.

Hardware service and support

You can receive hardware service through IBM Integrated Technology Services or through your IBM reseller, if your reseller is authorized by IBM to provide warranty service. Go to <http://www.ibm.com/planetwide/> for support telephone numbers.

In the U.S. and Canada, hardware service and support is available 24 hours a day, 7 days a week. In the U.K., these services are available Monday through Friday, from 9 a.m. to 6 p.m.

Appendix B. Warranty information

This section contains information about your warranty period and the service and support that are provided by your warranty.

Warranty period

The warranty period varies by machine type and country or region.

Contact your place of purchase for warranty service information. Some IBM Machines are eligible for on-site warranty service depending on the country or region where service is performed.

Prior to on-site warranty service, you are required to go through problem determination with an IBM service specialist call center technician.

This paragraph applies only to products with a warranty period of 3 years on parts and 1 year on labor. A warranty period of 3 years on parts and 1 year on labor means that IBM will provide warranty service without charge for:

1. parts and labor during the first year of the warranty period
2. parts only, on an exchange basis, in the second and third years of the warranty period. IBM will charge you for any labor it provides in performance of the repair or replacement.

The IBM Machine Warranties Web site at http://www.ibm.com/servers/support/machine_warranties/ contains a worldwide overview of the IBM Statement of Limited Warranty for IBM Machines, a glossary of terms used in the Statement of Limited Warranty, Frequently Asked Questions (FAQ), and links to Product Support Web pages. The IBM Statement of Limited Warranty is available from this Web site in 29 languages in Portable Document Format (PDF).

Machine - IBM Remote Supervisor Adapter

Country or region	Warranty period	Service delivery method
Worldwide	Parts - 3 years Labor - 3 years	On-site

Problem determination

Prior to on-site warranty service, you are required to go through problem determination with an IBM service specialist call center technician. The service specialist will run diagnostic tests on the hardware and check the software.

Running diagnostics

The IBM service specialist will help you determine whether your equipment is functioning as specified. It might be necessary to isolate the failing xSeries, Netfinity, or IntelliStation system; IBM component; or both from any active production environment to run diagnostics and perform defect-isolation programs. You are responsible for making the system, IBM component, or both available for running diagnostics and defect-isolation programs.

Checking software

The IBM service specialist will help you ensure that the correct BIOS code, firmware, device drivers, and other supporting IBM software are installed and

correctly configured. It might be necessary to manually gather information about the relevant software levels or run IBM-approved utility programs to gather this information. It might be necessary to isolate the failing system from any active production environment to gather this information. You are responsible, with assistance from the service specialist, for gathering this information. The IBM Statement of Limited Warranty does not include on-site assistance with this activity.

Warranty service and support

With the original purchase of an IBM xSeries or IntelliStation system, you have access to extensive service and support. During the IBM Machine warranty period, you may call IBM or your reseller for problem-determination assistance under the terms of the IBM Statement of Limited Warranty.

The following services are available during the warranty period:

- **Problem determination** - Trained personnel are available to assist you with determining if you have a hardware problem and deciding what action is necessary to fix the problem.
- **IBM hardware repair** - If the problem is determined to be caused by IBM hardware under warranty, trained service personnel are available to provide the applicable level of service, either on-site or at an IBM service center as determined by IBM.
- **Engineering Change management** - Occasionally, there might be changes that are required after a product has been shipped from IBM. In those instances, IBM will make Engineering Changes (ECs) available that apply to your hardware.
- **Customer replaceable units (CRUs)** - Some parts of IBM xSeries and IntelliStation systems are designated as customer replaceable units. IBM ships CRUs to you for replacement by you. CRUs include keyboards, monitors, memory, diskette drives, hard disk drives, and mice (this list is not inclusive of all CRUs).

The following items are not covered under warranty service:

- Replacement or use of non-IBM parts. All IBM parts contain a 7-character identification in the format IBM FRU XXXXXXXX.
- Identification of software problem sources.
- Installation of customer replaceable units (CRUs).
- Installation and configuration of BIOS code, firmware, or device drivers that are designated as customer installable.

See the IBM Statement of Limited Warranty for a full explanation of IBM warranty terms. Be sure to retain your proof of purchase to obtain warranty service.

Please have the following information ready when you call:

- The machine type and model of your IBM hardware product (if available)
- Serial numbers of your IBM hardware products
- A description of the problem
- The exact wording of any error messages
- Hardware and software configuration information

International Warranty Service

If you travel with your xSeries or IntelliStation system or relocate it to a country or region where your system is sold and serviced by IBM or IBM resellers authorized

to perform warranty service, International Warranty Service (IWS) is available during the warranty period. Eligible IBM systems are identified by their four-digit machine types.

You can obtain IWS through the service delivery method (such as depot, carry-in, or on-site) provided in the servicing country or region. Service methods and procedures vary by country or region, and some service or parts might not be available in all countries and regions. Service centers in certain countries or regions might not be able to service all models of a particular machine type. In addition, some countries or regions might have fees and restrictions that apply at the time of service.

To determine whether your system is eligible for IWS, go to <http://www.ibm.com/pc/support/> and click **Warranty lookup**.

Purchasing additional services

During and after the warranty period, you can purchase additional services, such as support for IBM and non-IBM hardware, operating systems, and application programs; network setup and configuration; upgraded or extended hardware repair services; and custom installations. Service availability and service name might vary by country or region.

For more information about these services, contact your IBM marketing representative.

IBM Statement of Limited Warranty Z125-4753-06 8/2000

Part 1 - General Terms

This Statement of Limited Warranty includes Part 1 - General Terms and Part 2 - Country-unique Terms. The terms of Part 2 replace or modify those of Part 1. The warranties provided by IBM in this Statement of Limited Warranty apply only to Machines you purchase for your use, and not for resale, from IBM or your reseller. The term "Machine" means an IBM machine, its features, conversions, upgrades, elements, or accessories, or any combination of them. The term "Machine" does not include any software programs, whether pre-loaded with the Machine, installed subsequently or otherwise. Unless IBM specifies otherwise, the following warranties apply only in the country where you acquire the Machine. Nothing in this Statement of Limited Warranty affects any statutory rights of consumers that cannot be waived or limited by contract. If you have any questions, contact IBM or your reseller.

The IBM Warranty for Machines: IBM warrants that each Machine 1) is free from defects in materials and workmanship and 2) conforms to IBM's Official Published Specifications ("Specifications"). The warranty period for a Machine is a specified, fixed period commencing on its Date of Installation. The date on your sales receipt is the Date of Installation unless IBM or your reseller informs you otherwise.

If a Machine does not function as warranted during the warranty period, and IBM or your reseller are unable to either 1) make it do so or 2) replace it with one that is at least functionally equivalent, you may return it to your place of purchase and your money will be refunded.

Extent of Warranty: The warranty does not cover the repair or exchange of a Machine resulting from misuse, accident, modification, unsuitable physical or operating environment, improper maintenance by you, or failure caused by a product for which IBM is not responsible. The warranty is voided by removal or alteration of Machine or parts identification labels.

THESE WARRANTIES ARE YOUR EXCLUSIVE WARRANTIES AND REPLACE ALL OTHER WARRANTIES OR CONDITIONS, EXPRESS OR IMPLIED, INCLUDING, BUT NOT LIMITED TO, THE IMPLIED WARRANTIES OR CONDITIONS OF MERCHANTABILITY AND FITNESS FOR A PARTICULAR PURPOSE. THESE WARRANTIES GIVE YOU SPECIFIC LEGAL RIGHTS AND YOU MAY ALSO HAVE OTHER RIGHTS WHICH VARY FROM JURISDICTION TO JURISDICTION. SOME JURISDICTIONS DO NOT ALLOW THE EXCLUSION OR LIMITATION OF EXPRESS OR IMPLIED WARRANTIES, SO THE ABOVE EXCLUSION OR LIMITATION MAY NOT APPLY TO YOU. IN THAT EVENT, SUCH WARRANTIES ARE LIMITED IN DURATION TO THE WARRANTY PERIOD. NO WARRANTIES APPLY AFTER THAT PERIOD.

Items Not Covered by Warranty: IBM does not warrant uninterrupted or error-free operation of a Machine. Any technical or other support provided for a Machine under warranty, such as assistance via telephone with "how-to" questions and those regarding Machine set-up and installation, will be provided **WITHOUT WARRANTIES OF ANY KIND.**

Warranty Service: To obtain warranty service for a Machine, contact IBM or your reseller. If you do not register your Machine with IBM, you may be required to present proof of purchase.

During the warranty period, IBM or your reseller, if approved by IBM to provide warranty service, provides without charge certain types of repair and exchange service to keep Machines in, or restore them to, conformance with their Specifications. IBM or your reseller will inform you of the available types of service for a Machine based on its country of installation. At its discretion, IBM or your reseller will 1) either repair or exchange the failing Machine and 2) provide the service either at your location or a service center. IBM or your reseller will also manage and install selected engineering changes that apply to the Machine.

Some parts of IBM Machines are designated as Customer Replaceable Units (called "CRUs"), e.g., keyboards, memory, or hard disk drives. IBM ships CRUs to you for replacement by you. You must return all defective CRUs to IBM within 30 days of your receipt of the replacement CRU. You are responsible for downloading designated Machine Code and Licensed Internal Code updates from an IBM Internet Web site or from other electronic media, and following the instructions that IBM provides.

When warranty service involves the exchange of a Machine or part, the item IBM or your reseller replaces becomes its property and the replacement becomes yours. You represent that all removed items are genuine and unaltered. The replacement may not be new, but will be in good working order and at least functionally equivalent to the item replaced. The replacement assumes the warranty service status of the replaced item. Many features, conversions, or upgrades involve the removal of parts and their return to IBM. A part that replaces a removed part will assume the warranty service status of the removed part.

Before IBM or your reseller exchanges a Machine or part, you agree to remove all features, parts, options, alterations, and attachments not under warranty service.

You also agree to

1. ensure that the Machine is free of any legal obligations or restrictions that prevent its exchange;
2. obtain authorization from the owner to have IBM or your reseller service a Machine that you do not own; and
3. where applicable, before service is provided:
 - a. follow the problem determination, problem analysis, and service request procedures that IBM or your reseller provides;
 - b. secure all programs, data, and funds contained in a Machine;
 - c. provide IBM or your reseller with sufficient, free, and safe access to your facilities to permit them to fulfill their obligations; and
 - d. inform IBM or your reseller of changes in a Machine's location.

IBM is responsible for loss of, or damage to, your Machine while it is 1) in IBM's possession or 2) in transit in those cases where IBM is responsible for the transportation charges.

Neither IBM nor your reseller is responsible for any of your confidential, proprietary or personal information contained in a Machine which you return to IBM or your reseller for any reason. You should remove all such information from the Machine prior to its return.

Limitation of Liability: Circumstances may arise where, because of a default on IBM's part or other liability, you are entitled to recover damages from IBM. In each such instance, regardless of the basis on which you are entitled to claim damages from IBM (including fundamental breach, negligence, misrepresentation, or other

contract or tort claim), except for any liability that cannot be waived or limited by applicable laws, IBM is liable for no more than

1. damages for bodily injury (including death) and damage to real property and tangible personal property; and
2. the amount of any other actual direct damages, up to the charges (if recurring, 12 months' charges apply) for the Machine that is subject of the claim. For purposes of this item, the term "Machine" includes Machine Code and Licensed Internal Code.

This limit also applies to IBM's suppliers and your reseller. It is the maximum for which IBM, its suppliers, and your reseller are collectively responsible.

UNDER NO CIRCUMSTANCES IS IBM LIABLE FOR ANY OF THE FOLLOWING: 1) THIRD-PARTY CLAIMS AGAINST YOU FOR DAMAGES (OTHER THAN THOSE UNDER THE FIRST ITEM LISTED ABOVE); 2) LOSS OF, OR DAMAGE TO, YOUR RECORDS OR DATA; OR 3) SPECIAL, INCIDENTAL, OR INDIRECT DAMAGES OR FOR ANY ECONOMIC CONSEQUENTIAL DAMAGES, LOST PROFITS OR LOST SAVINGS, EVEN IF IBM, ITS SUPPLIERS OR YOUR RESELLER IS INFORMED OF THEIR POSSIBILITY. SOME JURISDICTIONS DO NOT ALLOW THE EXCLUSION OR LIMITATION OF INCIDENTAL OR CONSEQUENTIAL DAMAGES, SO THE ABOVE LIMITATION OR EXCLUSION MAY NOT APPLY TO YOU.

Governing Law: Both you and IBM consent to the application of the laws of the country in which you acquired the Machine to govern, interpret, and enforce all of your and IBM's rights, duties, and obligations arising from, or relating in any manner to, the subject matter of this Agreement, without regard to conflict of law principles.

Part 2 - Country-unique Terms

AMERICAS

BRAZIL

Governing Law: *The following is added after the first sentence:* Any litigation arising from this Agreement will be settled exclusively by the court of Rio de Janeiro.

NORTH AMERICA

Warranty Service: *The following is added to this Section:* To obtain warranty service from IBM in Canada or the United States, call 1-800-IBM-SERV (426-7378).

CANADA

Governing Law: *The following replaces "laws of the country in which you acquired the Machine" in the first sentence:* laws in the Province of Ontario.

UNITED STATES

Governing Law: *The following replaces "laws of the country in which you acquired the Machine" in the first sentence:* laws of the State of New York.

ASIA PACIFIC

AUSTRALIA

The IBM Warranty for Machines: *The following paragraph is added to this Section:* The warranties specified in this Section are in addition to any rights you may have under the Trade Practices Act 1974 or other similar legislation and are only limited to the extent permitted by the applicable legislation.

Limitation of Liability: *The following is added to this Section:* Where IBM is in breach of a condition or warranty implied by the Trade Practices Act 1974 or other similar legislation, IBM's liability is limited to the repair or replacement of the goods or the supply of equivalent goods. Where that condition or warranty relates to right to sell, quiet possession or clear title, or the goods are of a kind ordinarily acquired for personal, domestic or household use or consumption, then none of the limitations in this paragraph apply.

Governing Law: *The following replaces "laws of the country in which you acquired the Machine" in the first sentence:* laws of the State or Territory.

CAMBODIA, LAOS, AND VIETNAM

Governing Law: *The following replaces "laws of the country in which you acquired the Machine" in the first sentence:* laws of the State of New York.

The following is added to this Section: Disputes and differences arising out of or in connection with this Agreement shall be finally settled by arbitration which shall be held in Singapore in accordance with the rules of the International Chamber of Commerce (ICC). The arbitrator or arbitrators designated in conformity with those rules shall have the power to rule on their own competence and on the validity of the Agreement to submit to arbitration. The arbitration award shall be final and binding for the parties without appeal and the arbitral award shall be in writing and set forth the findings of fact and the conclusions of law.

All proceedings shall be conducted, including all documents presented in such proceedings, in the English language. The number of arbitrators shall be three, with each side to the dispute being entitled to appoint one arbitrator.

The two arbitrators appointed by the parties shall appoint a third arbitrator before proceeding upon the reference. The third arbitrator shall act as chairman of the proceedings. Vacancies in the post of chairman shall be filled by the president of the ICC. Other vacancies shall be filled by the respective nominating party. Proceedings shall continue from the stage they were at when the vacancy occurred.

If one of the parties refuses or otherwise fails to appoint an arbitrator within 30 days of the date the other party appoints its, the first appointed arbitrator shall be the sole arbitrator, provided that the arbitrator was validly and properly appointed.

The English language version of this Agreement prevails over any other language version.

HONG KONG AND MACAU

Governing Law: *The following replaces "laws of the country in which you acquired the Machine" in the first sentence:* laws of Hong Kong Special Administrative Region.

INDIA

Limitation of Liability: *The following replaces items 1 and 2 of this Section:*

1. liability for bodily injury (including death) or damage to real property and tangible personal property will be limited to that caused by IBM's negligence;
2. as to any other actual damage arising in any situation involving nonperformance by IBM pursuant to, or in any way related to the subject of this Statement of Limited Warranty, IBM's liability will be limited to the charge paid by you for the individual Machine that is the subject of the claim.

JAPAN

Governing Law: *The following sentence is added to this Section:* Any doubts concerning this Agreement will be initially resolved between us in good faith and in accordance with the principle of mutual trust.

NEW ZEALAND

The IBM Warranty for Machines: *The following paragraph is added to this Section:* The warranties specified in this Section are in addition to any rights you may have under the Consumer Guarantees Act 1993 or other legislation which cannot be excluded or limited. The Consumer Guarantees Act 1993 will not apply in respect of any goods which IBM provides, if you require the goods for the purposes of a business as defined in that Act.

Limitation of Liability: *The following is added to this Section:* Where Machines are not acquired for the purposes of a business as defined in the Consumer Guarantees Act 1993, the limitations in this Section are subject to the limitations in that Act.

PEOPLE'S REPUBLIC OF CHINA (PRC)

Governing Law: *The following replaces this Section:* Both you and IBM consent to the application of the laws of the State of New York (except when local law requires otherwise) to govern, interpret, and enforce all your and IBM's rights, duties, and obligations arising from, or relating in any manner to, the subject matter of this Agreement, without regard to conflict of law principles.

Any disputes arising from or in connection with this Agreement will first be resolved by friendly negotiations, failing which either of us has the right to submit the dispute to the China International Economic and Trade Arbitration Commission in Beijing, the PRC, for arbitration in accordance with its arbitration rules in force at the time. The arbitration tribunal will consist of three arbitrators. The language to be used therein will be English and Chinese. An arbitral award will be final and binding on all the parties, and will be enforceable under the Convention on the Recognition and Enforcement of Foreign Arbitral Awards (1958).

The arbitration fee will be borne by the losing party unless otherwise determined by the arbitral award.

During the course of arbitration, this Agreement will continue to be performed except for the part which the parties are disputing and which is undergoing arbitration.

EUROPE, MIDDLE EAST, AFRICA (EMEA)

THE FOLLOWING TERMS APPLY TO ALL EMEA COUNTRIES: The terms of this Statement of Limited Warranty apply to Machines purchased from IBM or an IBM reseller.

Warranty Service: If you purchase an IBM Machine in Austria, Belgium, Denmark, Estonia, Finland, France, Germany, Greece, Iceland, Ireland, Italy, Latvia, Lithuania, Luxembourg, Netherlands, Norway, Portugal, Spain, Sweden, Switzerland or United Kingdom, you may obtain warranty service for that Machine in any of those countries from either (1) an IBM reseller approved to perform warranty service or (2) from IBM. If you purchase an IBM Personal Computer Machine in Albania, Armenia, Belarus, Bosnia and Herzegovina, Bulgaria, Croatia, Czech Republic, Georgia, Hungary, Kazakhstan, Kirghizia, Federal Republic of Yugoslavia, Former Yugoslav Republic of Macedonia (FYROM), Moldova, Poland, Romania, Russia, Slovak Republic, Slovenia, or Ukraine, you may obtain warranty service for that Machine in any of those countries from either (1) an IBM reseller approved to perform warranty service or (2) from IBM.

If you purchase an IBM Machine in a Middle Eastern or African country, you may obtain warranty service for that Machine from the IBM entity within the country of purchase, if that IBM entity provides warranty service in that country, or from an IBM reseller, approved by IBM to perform warranty service on that Machine in that country. Warranty service in Africa is available within 50 kilometers of an IBM authorized service provider. You are responsible for transportation costs for Machines located outside 50 kilometers of an IBM authorized service provider.

Governing Law: The applicable laws that govern, interpret and enforce rights, duties, and obligations of each of us arising from, or relating in any manner to, the subject matter of this Statement, without regard to conflict of laws principles, as well as Country-unique terms and competent court for this Statement are those of the country in which the warranty service is being provided, except that in 1) Albania, Bosnia-Herzegovina, Bulgaria, Croatia, Hungary, Former Yugoslav Republic of Macedonia, Romania, Slovakia, Slovenia, Armenia, Azerbaijan, Belarus, Georgia, Kazakhstan, Kyrgyzstan, Moldova, Russia, Tajikistan, Turkmenistan, Ukraine, and Uzbekistan, the laws of Austria apply; 2) Estonia, Latvia, and Lithuania, the laws of Finland apply; 3) Algeria, Benin, Burkina Faso, Cameroon, Cape Verde, Central African Republic, Chad, Congo, Djibouti, Democratic Republic of Congo, Equatorial Guinea, France, Gabon, Gambia, Guinea, Guinea-Bissau, Ivory Coast, Lebanon, Mali, Mauritania, Morocco, Niger, Senegal, Togo, and Tunisia, this Agreement will be construed and the legal relations between the parties will be determined in accordance with the French laws and all disputes arising out of this Agreement or related to its violation or execution, including summary proceedings, will be settled exclusively by the Commercial Court of Paris; 4) Angola, Bahrain, Botswana, Burundi, Egypt, Eritrea, Ethiopia, Ghana, Jordan, Kenya, Kuwait, Liberia, Malawi, Malta, Mozambique, Nigeria, Oman, Pakistan, Qatar, Rwanda, Sao Tome, Saudi Arabia, Sierra Leone, Somalia, Tanzania, Uganda, United Arab Emirates, United Kingdom, West Bank/Gaza, Yemen, Zambia, and Zimbabwe, this Agreement will be governed by English Law and disputes relating to it will be submitted to the exclusive jurisdiction of the English courts; and 5) in Greece, Israel, Italy, Portugal, and Spain any legal claim arising out of this Statement will be brought before, and finally settled by, the competent court of Athens, Tel Aviv, Milan, Lisbon, and Madrid, respectively.

THE FOLLOWING TERMS APPLY TO THE COUNTRY SPECIFIED:

AUSTRIA AND GERMANY

The IBM Warranty for Machines: *The following replaces the first sentence of the first paragraph of this Section:* The warranty for an IBM Machine covers the functionality of the Machine for its normal use and the Machine's conformity to its Specifications.

The following paragraphs are added to this Section:

The minimum warranty period for Machines is six months. In case IBM or your reseller is unable to repair an IBM Machine, you can alternatively ask for a partial refund as far as justified by the reduced value of the unrepaired Machine or ask for a cancellation of the respective agreement for such Machine and get your money refunded.

Extent of Warranty: *The second paragraph does not apply.*

Warranty Service: *The following is added to this Section:* During the warranty period, transportation for delivery of the failing Machine to IBM will be at IBM's expense.

Limitation of Liability: *The following paragraph is added to this Section:* The limitations and exclusions specified in the Statement of Limited Warranty will not apply to damages caused by IBM with fraud or gross negligence and for express warranty.

The following sentence is added to the end of item 2: IBM's liability under this item is limited to the violation of essential contractual terms in cases of ordinary negligence.

EGYPT

Limitation of Liability: *The following replaces item 2 in this Section:* as to any other actual direct damages, IBM's liability will be limited to the total amount you paid for the Machine that is the subject of the claim. For purposes of this item, the term "Machine" includes Machine Code and Licensed Internal Code.

Applicability of suppliers and resellers (unchanged).

FRANCE

Limitation of Liability: *The following replaces the second sentence of the first paragraph of this Section:* In such instances, regardless of the basis on which you are entitled to claim damages from IBM, IBM is liable for no more than: *(items 1 and 2 unchanged).*

IRELAND

Extent of Warranty: *The following is added to this Section:* Except as expressly provided in these terms and conditions, all statutory conditions, including all warranties implied, but without prejudice to the generality of the foregoing all warranties implied by the Sale of Goods Act 1893 or the Sale of Goods and Supply of Services Act 1980 are hereby excluded.

Limitation of Liability: *The following replaces items one and two of the first paragraph of this Section:* 1. death or personal injury or physical damage to your real property solely caused by IBM's negligence; and 2. the amount of any other actual direct damages, up to 125 percent of the charges (if recurring, the 12 months' charges apply) for the Machine that is the subject of the claim or which otherwise gives rise to the claim.

Applicability of suppliers and resellers (unchanged).

The following paragraph is added at the end of this Section: IBM's entire liability and your sole remedy, whether in contract or in tort, in respect of any default shall be limited to damages.

ITALY

Limitation of Liability: *The following replaces the second sentence in the first paragraph: In each such instance unless otherwise provided by mandatory law, IBM is liable for no more than: 1. (unchanged) 2. as to any other actual damage arising in all situations involving nonperformance by IBM pursuant to, or in any way related to the subject matter of this Statement of Warranty, IBM's liability, will be limited to the total amount you paid for the Machine that is the subject of the claim. Applicability of suppliers and resellers (unchanged).*

The following replaces the third paragraph of this Section: Unless otherwise provided by mandatory law, IBM and your reseller are not liable for any of the following: (items 1 and 2 unchanged) 3) indirect damages, even if IBM or your reseller is informed of their possibility.

SOUTH AFRICA, NAMIBIA, BOTSWANA, LESOTHO AND SWAZILAND

Limitation of Liability: *The following is added to this Section: IBM's entire liability to you for actual damages arising in all situations involving nonperformance by IBM in respect of the subject matter of this Statement of Warranty will be limited to the charge paid by you for the individual Machine that is the subject of your claim from IBM.*

UNITED KINGDOM

Limitation of Liability: *The following replaces items 1 and 2 of the first paragraph of this Section:*

1. death or personal injury or physical damage to your real property solely caused by IBM's negligence;
2. the amount of any other actual direct damages or loss, up to 125 percent of the charges (if recurring, the 12 months' charges apply) for the Machine that is the subject of the claim or which otherwise gives rise to the claim;

The following item is added to this paragraph: 3. breach of IBM's obligations implied by Section 12 of the Sale of Goods Act 1979 or Section 2 of the Supply of Goods and Services Act 1982.

Applicability of suppliers and resellers (unchanged).

The following is added to the end of this Section: IBM's entire liability and your sole remedy, whether in contract or in tort, in respect of any default shall be limited to damages.

Appendix C. Notices

This publication was developed for products and services offered in the U.S.A.

IBM may not offer the products, services, or features discussed in this document in other countries. Consult your local IBM representative for information on the products and services currently available in your area. Any reference to an IBM product, program, or service is not intended to state or imply that only that IBM product, program, or service may be used. Any functionally equivalent product, program, or service that does not infringe any IBM intellectual property right may be used instead. However, it is the user's responsibility to evaluate and verify the operation of any non-IBM product, program, or service.

IBM may have patents or pending patent applications covering subject matter described in this document. The furnishing of this document does not give you any license to these patents. You can send license inquiries, in writing, to:

*IBM Director of Licensing
IBM Corporation
North Castle Drive
Armonk, NY 10504-1785
U.S.A.*

INTERNATIONAL BUSINESS MACHINES CORPORATION PROVIDES THIS PUBLICATION "AS IS" WITHOUT WARRANTY OF ANY KIND, EITHER EXPRESS OR IMPLIED, INCLUDING, BUT NOT LIMITED TO, THE IMPLIED WARRANTIES OF NON-INFRINGEMENT, MERCHANTABILITY OR FITNESS FOR A PARTICULAR PURPOSE. Some jurisdictions do not allow disclaimer of express or implied warranties in certain transactions, therefore, this statement may not apply to you.

This information could include technical inaccuracies or typographical errors. Changes are periodically made to the information herein; these changes will be incorporated in new editions of the publication. IBM may make improvements and/or changes in the product(s) and/or the program(s) described in this publication at any time without notice.

Any references in this publication to non-IBM Web sites are provided for convenience only and do not in any manner serve as an endorsement of those Web sites. The materials at those Web sites are not part of the materials for this IBM product, and use of those Web sites is at your own risk.

IBM may use or distribute any of the information you supply in any way it believes appropriate without incurring any obligation to you.

Edition notice

**© COPYRIGHT INTERNATIONAL BUSINESS MACHINES CORPORATION, 2002.
All rights reserved.**

Note to U.S. Government Users — Documentation related to restricted rights — Use, duplication or disclosure is subject to restrictions set forth in GSA ADP Schedule Contract with IBM Corp.

Trademarks

The following terms are trademarks of International Business Machines Corporation in the United States, other countries, or both:

C2T Interconnect	Predictive Failure Analysis
e-business logo	ServerGuide
IBM	ServerProven
IntelliStation	X-Architecture
Netfinity	xSeries

Action Media, LANDesk, MMX, Pentium, and ProShare are trademarks of Intel Corporation in the United States, other countries, or both.

Microsoft, Windows, and Windows NT are trademarks of Microsoft Corporation in the United States, other countries, or both.

UNIX is a registered trademark of The Open Group in the United States and other countries.

Java and all Java-based trademarks and logos are trademarks or registered trademarks of Sun Microsystems, Inc. in the United States, other countries, or both.

Linux is a registered trademark of Linus Torvalds.

Other company, product, or service names may be trademarks or service marks of others.

Important notes

Processor speeds indicate the internal clock speed of the microprocessor; other factors also affect application performance.

CD-ROM drive speeds list the variable read rate. Actual speeds vary and are often less than the maximum possible.

When referring to processor storage, real and virtual storage, or channel volume, KB stands for approximately 1000 bytes, MB stands for approximately 1 000 000 bytes, and GB stands for approximately 1 000 000 000 bytes.

When referring to hard disk drive capacity or communications volume, MB stands for 1 000 000 bytes, and GB stands for 1 000 000 000 bytes. Total user-accessible capacity may vary depending on operating environments.

Maximum internal hard disk drive capacities assume the replacement of any standard hard disk drives and population of all hard disk drive bays with the largest currently supported drives available from IBM.

Maximum memory may require replacement of the standard memory with an optional memory module.

IBM makes no representation or warranties regarding non-IBM products and services that are ServerProven[®], including but not limited to the implied warranties of merchantability and fitness for a particular purpose. These products are offered and warranted solely by third parties.

IBM makes no representations or warranties with respect to non-IBM products. Support (if any) for the non-IBM products is provided by the third party, not IBM.

Some software may differ from its retail version (if available), and may not include user manuals or all program functionality.

Electronic emission notices

Federal Communications Commission (FCC) statement

Note: This equipment has been tested and found to comply with the limits for a Class A digital device, pursuant to Part 15 of the FCC Rules. These limits are designed to provide reasonable protection against harmful interference when the equipment is operated in a commercial environment. This equipment generates, uses, and can radiate radio frequency energy and, if not installed and used in accordance with the instruction manual, may cause harmful interference to radio communications. Operation of this equipment in a residential area is likely to cause harmful interference, in which case the user will be required to correct the interference at his own expense.

Properly shielded and grounded cables and connectors must be used in order to meet FCC emission limits. Properly shielded and grounded cables and connectors must be used in order to meet FCC emission limits. IBM is not responsible for any radio or television interference caused by using other than recommended cables and connectors or by using other than recommended cables and connectors or by unauthorized changes or modifications to this equipment. Unauthorized changes or modifications could void the user's authority to operate the equipment.

This device complies with Part 15 of the FCC Rules. Operation is subject to the following two conditions: (1) this device may not cause harmful interference, and (2) this device must accept any interference received, including interference that may cause undesired operation.

Industry Canada Class A emission compliance statement

This Class A digital apparatus complies with Canadian ICES-003.

Avis de conformité à la réglementation d'Industrie Canada

Cet appareil numérique de la classe A est conforme à la norme NMB-003 du Canada.

Australia and New Zealand Class A statement

Attention: This is a Class A product. In a domestic environment this product may cause radio interference in which case the user may be required to take adequate measures.

United Kingdom telecommunications safety requirement

Notice to Customers

This apparatus is approved under approval number NS/G/1234/J/100003 for indirect connection to public telecommunication systems in the United Kingdom.

European Union EMC Directive conformance statement

This product is in conformity with the protection requirements of EU Council Directive 89/336/EEC on the approximation of the laws of the Member States relating to electromagnetic compatibility. IBM cannot accept responsibility for any failure to satisfy the protection requirements resulting from a nonrecommended modification of the product, including the fitting of non-IBM option cards.

This product has been tested and found to comply with the limits for Class A Information Technology Equipment according to CISPR 22/European Standard EN 55022. The limits for Class A equipment were derived for commercial and industrial environments to provide reasonable protection against interference with licensed communication equipment.

Attention: This is a Class A product. In a domestic environment this product may cause radio interference in which case the user may be required to take adequate measures.

Taiwanese Class A warning statement

警告使用者：
這是甲類的資訊產品，在
居住的環境中使用時，可
能會造成射頻干擾，在這
種情況下，使用者會被要
求採取某些適當的對策。

Japanese Voluntary Control Council for Interference (VCCI) statement

この装置は、情報処理装置等電波障害自主規制協議会（VCCI）の基準に基づきクラスA情報技術装置です。この装置を家庭環境で使用すると電波妨害を引き起こすことがあります。この場合には使用者が適切な対策を講ずるよう要求されることがあります。

Power cords

For your safety, IBM provides a power cord with a grounded attachment plug to use with this IBM product. To avoid electrical shock, always use the power cord and plug with a properly grounded outlet.

IBM power cords used in the United States and Canada are listed by Underwriter's Laboratories (UL) and certified by the Canadian Standards Association (CSA).

For units intended to be operated at 115 volts: Use a UL-listed and CSA-certified cord set consisting of a minimum 18 AWG, Type SVT or SJT, three-conductor cord, a maximum of 15 feet in length and a parallel blade, grounding-type attachment plug rated 15 amperes, 125 volts.

For units intended to be operated at 230 volts (U.S. use): Use a UL-listed and CSA-certified cord set consisting of a minimum 18 AWG, Type SVT or SJT, three-conductor cord, a maximum of 15 feet in length and a tandem blade, grounding-type attachment plug rated 15 amperes, 250 volts.

For units intended to be operated at 230 volts (outside the U.S.): Use a cord set with a grounding-type attachment plug. The cord set should have the appropriate safety approvals for the country in which the equipment will be installed.

IBM power cords for a specific country or region are usually available only in that country or region.

IBM power cord part number	Used in these countries and regions
13F9940	Argentina, Australia, China (PRC), New Zealand, Papua New Guinea, Paraguay, Uruguay, Western Samoa
13F9979	Afghanistan, Algeria, Andorra, Angola, Austria, Belgium, Benin, Bulgaria, Burkina Faso, Burundi, Cameroon, Central African Rep., Chad, China (Macau S.A.R.), Czech Republic, Egypt, Finland, France, French Guiana, Germany, Greece, Guinea, Hungary, Iceland, Indonesia, Iran, Ivory Coast, Jordan, Lebanon, Luxembourg, Malagasy, Mali, Martinique, Mauritania, Mauritius, Monaco, Morocco, Mozambique, Netherlands, New Caledonia, Niger, Norway, Poland, Portugal, Romania, Senegal, Slovakia, Spain, Sudan, Sweden, Syria, Togo, Tunisia, Turkey, former USSR, Vietnam, former Yugoslavia, Zaire, Zimbabwe
13F9997	Denmark
14F0015	Bangladesh, Burma, Pakistan, South Africa, Sri Lanka
14F0033	Antigua, Bahrain, Brunei, Channel Islands, China (Hong Kong S.A.R.), Cyprus, Dubai, Fiji, Ghana, India, Iraq, Ireland, Kenya, Kuwait, Malawi, Malaysia, Malta, Nepal, Nigeria, Polynesia, Qatar, Sierra Leone, Singapore, Tanzania, Uganda, United Kingdom, Yemen, Zambia
14F0051	Liechtenstein, Switzerland
14F0069	Chile, Ethiopia, Italy, Libya, Somalia
14F0087	Israel
1838574	Thailand
6952301	Bahamas, Barbados, Bermuda, Bolivia, Brazil, Canada, Cayman Islands, Colombia, Costa Rica, Dominican Republic, Ecuador, El Salvador, Guatemala, Guyana, Haiti, Honduras, Jamaica, Japan, Korea (South), Liberia, Mexico, Netherlands Antilles, Nicaragua, Panama, Peru, Philippines, Saudi Arabia, Suriname, Taiwan, Trinidad (West Indies), United States of America, Venezuela

Index

Numerics

20-pin ribbon cable, installing 20

A

adapter installation
 other server models 9
 xSeries 220 11
 xSeries 232 13
 xSeries 330 15
 xSeries 342 18
alerts, forwarding 46
ASM interconnect module, installing 47
ASM interconnect network
 configuration examples 49
 forwarding alerts 46
 overview 41
 planning and cabling 41
 xSeries 232 and xSeries 342 considerations 42
 xSeries 335 considerations 42
ASM link cable, using 22
ASM processor device drivers, installing and updating 32
ASM RS-485 connector 8

C

cabling
 ASM interconnect network 41
 Ethernet LAN connector 23
 serial connector 24
Caldera Open UNIX device drivers, installing 38
Class A electronic emission notice 71
components, adapter 6
configuring
 Ethernet settings 27
 point-to-point protocol (PPP) 30
 remote control passwords 38
 serial connector 29
connector
 Ethernet 8
 external power supply 8
 RS-485 8
 serial 8
 system-management 8

D

device drivers, installing
 ASM processor 32
 Caldera Open UNIX 38
 Linux 34
 Novell Netware 37
 Remote Supervisor Adapter 32
 SCO Unixware 38
 Windows 2000 33
 Windows NT 34

DHCP server, using 27
documentation browser
 system requirements 3
 using 4
documentation, related 4

E

electronic emission Class A notice 71
Ethernet
 cabling 23
 configuring settings 27
 connector 8
 LEDs 24
external power-supply adapter
 connecting 20
 connector location 8

F

FCC Class A notice 71
firmware, updating 25
forwarding alerts 46

H

help and technical assistance, getting 55

I

installation
 completing 39
 prerequisites 1
 requirements 2
 task list 9
 task summary table 10
inventory checklist 6

L

LAN (Ethernet) connector, cabling 23
LEDs, Ethernet 24
Linux device drivers, installing 34

N

notes, important 70
notices
 electronic emission 71
 FCC, Class A 71
 handling static-sensitive device 5
 product 69
notices and statements 5
Novell NetWare device drivers, installing 37

P

- planning an ASM interconnect network 41
- point-to-point protocol (PPP), setting 30
- power cords 72
- power-supply adapter
 - connecting 20
 - connector location 8
- product notices 69

R

- Red Hat Linux device driver, installing 34
- remote access
 - configuring 26
 - enabling 26
- remote control passwords, configuring 38
- Remote Supervisor Adapter
 - components 7
 - features 3
 - installing device drivers 32
 - installing in other servers 9
 - installing in xSeries 220 11
 - installing in xSeries 232 14
 - installing in xSeries 330 15
 - installing in xSeries 342 19
 - updating firmware 25
- Remote Supervisor Utility, using to
 - configure Ethernet settings 27
 - configure PPP 30
 - configure serial connector 29
 - update firmware 25
- ribbon cable, installing 20
- RS-485 connector 8
- RS-485 terminator plugs, using 48

S

- SCO UnixWare device drivers, installing 38
- serial connector
 - cabling 24
 - configuring 29
 - location 8
- static-sensitive devices, handling 5
- SuSE Linux device driver, installing 34
- system-management connector 8

T

- task list for installation 9
- technical assistance and help, getting 55
- Telnet session 30
- terminator plugs, using 48
- trademarks 70

U

- United States FCC Class A notice 71
- updating firmware 25
- utility, using Remote Supervisor 25

W

- warranty information 57
- Web browser requirements 2
- Windows 2000 device drivers, installing 33
- Windows NT device drivers, installing 34

X

- xSeries 220
 - adapter installation 11
 - system board view 13
- xSeries 232
 - adapter installation 13
 - system board view 14
- xSeries 330
 - adapter installation 15
 - system board view 15
- xSeries 342
 - adapter installation 18



Part Number: 48P9832

Printed in U.S.A.

(1P) P/N: 48P9832

