

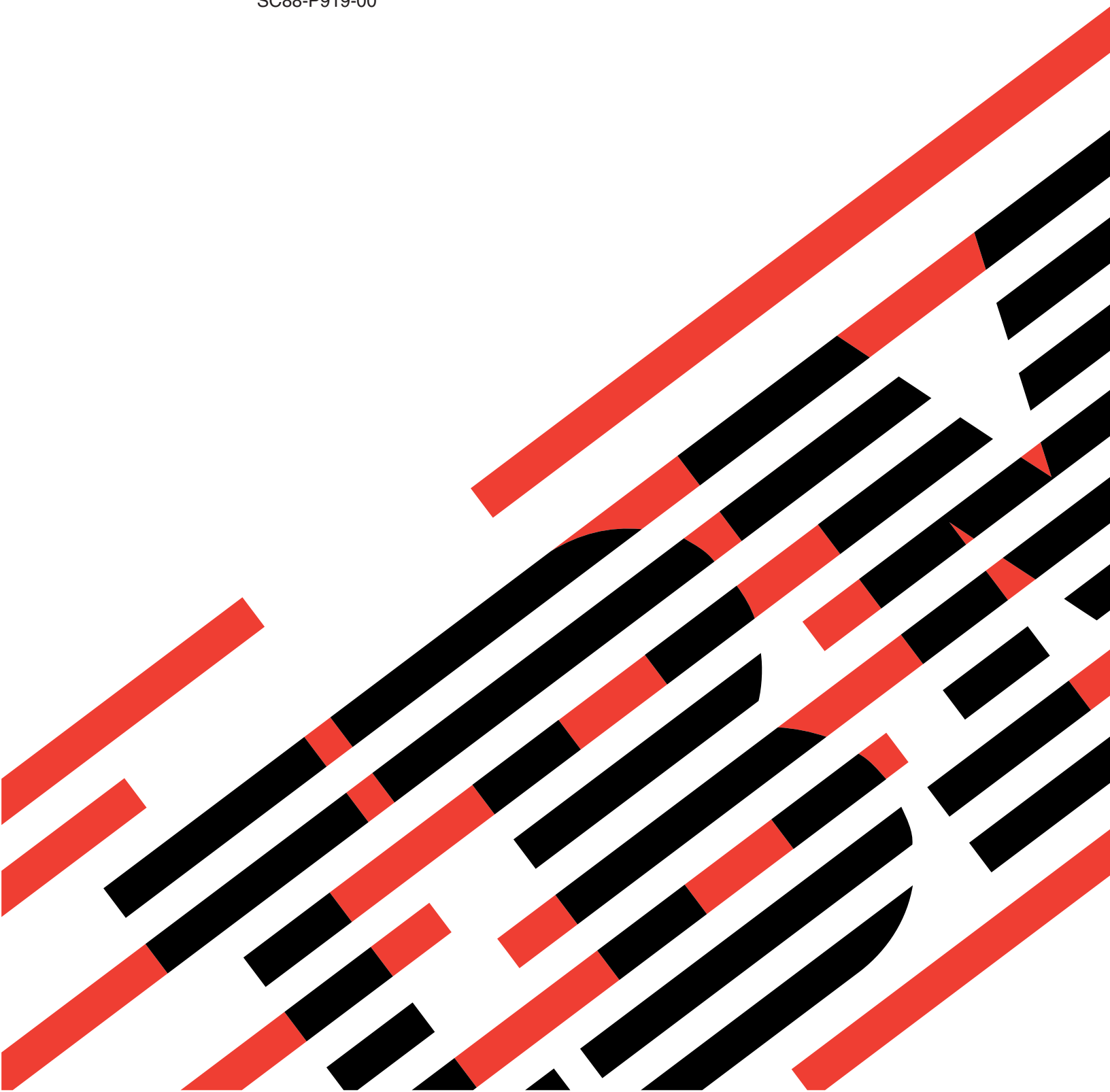

IBM xSeries 345
Type 8670

Option Installation Guide

SC88-P919-00





@server

IBM xSeries 345
Type 8670

Option Installation Guide

SC88-P919-00

Note:

Before using this information and the product it supports, be sure to read the general information in “Notices”, on page 45.

Second Edition (May 2003)

© Copyright International Business Machines Corporation 2003. All rights reserved.

US Government Users Restricted Rights – Use, duplication or disclosure restricted by GSA ADP Schedule Contract with IBM Corp.

Contents

Safety	v
Chapter 1. Introduction	1
Related publications	1
Notices and statements used in this book	2
Major components of the xSeries 345 Type 8670 server	3
System-board option connectors	4
PCI riser-card option connectors	4
System-board internal cable connectors	5
System-board external port connectors	6
System-board switches and jumpers	7
System-board LED	9
Light Path Diagnostics panel	10
Chapter 2. Installing options	11
Installation guidelines	11
System reliability considerations	11
Working inside the server with the power on	11
Handling static-sensitive devices	11
Server power features	13
Turning on the server	13
Turning off the server	13
Removing the cover and bezel	15
Working with adapters	16
Installing a ServeRAID-5i controller	21
Installing a hot-swap drive	22
Installing memory modules	23
Installing a microprocessor	26
Installing a hot-swap power-supply option	31
Replacing a hot-swap fan	33
Replacing the battery	34
Completing the installation.	36
Installing the server cover and bezel	36
Installing the server in a rack.	36
Updating your server configuration.	36
Connecting external options	37
Cabling the server.	37
Chapter 3. Input/output connectors	39
Auxiliary-device (pointing device) connector	40
Ethernet connectors	40
Integrated system management processor (ISMP) interconnect ports	40
Keyboard connector	40
Serial connector	41
Ultra320 SCSI controller system-board connectors	41
SCSI cabling requirements	41
SCSI IDs	41
SCSI connector	42
Universal Serial Bus version 1.1 connectors	42
Video connector	42
Appendix. Notices	45
Edition notice	45

Trademarks	46
Important notes.	46
Product recycling and disposal	47
Electronic emission notices	47
Federal Communications Commission (FCC) statement	47
Industry Canada Class A emission compliance statement	48
Australia and New Zealand Class A statement	48
United Kingdom telecommunications safety requirement.	48
European Union EMC Directive conformance statement.	48
Taiwanese Class A warning statement	49
Chinese Class A warning statement	49
Japanese Voluntary Control Council for Interference (VCCI) statement	49
Power cords	49
Index	53

Safety

Before installing this product, read the Safety Information.

قبل تركيب هذا المنتج، يجب قراءة الملاحظات الأمنية

Antes de instalar este produto, leia as Informações de Segurança.

在安装本产品之前，请仔细阅读 **Safety Information** (安全信息)。

安裝本產品之前，請先閱讀「安全資訊」。

Prije instalacije ovog produkta obavezno pročitajte Sigurnosne Upute.

Před instalací tohoto produktu si přečtěte příručku bezpečnostních instrukcí.

Læs sikkerhedsforskrifterne, før du installerer dette produkt.

Lees voordat u dit product installeert eerst de veiligheidsvoorschriften.

Ennen kuin asennat tämän tuotteen, lue turvaohjeet kohdasta Safety Information.

Avant d'installer ce produit, lisez les consignes de sécurité.

Vor der Installation dieses Produkts die Sicherheitshinweise lesen.

Πριν εγκαταστήσετε το προϊόν αυτό, διαβάστε τις πληροφορίες ασφάλειας (safety information).

לפני שתתקינו מוצר זה, קראו את הוראות הבטיחות.

A termék telepítése előtt olvassa el a Biztonsági előírásokat!

Prima di installare questo prodotto, leggere le Informazioni sulla Sicurezza.

製品の設置の前に、安全情報をお読みください。

본 제품을 설치하기 전에 안전 정보를 읽으십시오.

Пред да се инсталира овој продукт, прочитајте информацијата за безбедност.

Les sikkerhetsinformasjonen (Safety Information) før du installerer dette produktet.

Przed zainstalowaniem tego produktu, należy zapoznać się z książką "Informacje dotyczące bezpieczeństwa" (Safety Information).

Antes de instalar este produto, leia as Informações sobre Segurança.

Перед установкой продукта прочтите инструкции по технике безопасности.

Pred inštaláciou tohto zariadenia si pečítajte Bezpečnostné predpisy.

Pred namestitvijo tega proizvoda preberite Varnostne informacije.

Antes de instalar este producto, lea la información de seguridad.

Läs säkerhetsinformationen innan du installerar den här produkten.

Statement 1



Danger

Electrical current from power, telephone, and communication cables is hazardous.

To avoid a shock hazard:

- Do not connect or disconnect any cables or perform installation, maintenance, or reconfiguration of this product during an electrical storm.
- Connect all power cords to a properly wired and grounded electrical outlet.
- Connect to properly wired outlets any equipment that will be attached to this product.
- When possible, use one hand only to connect or disconnect signal cables.
- Never turn on any equipment when there is evidence of fire, water, or structural damage.
- Disconnect the attached power cords, telecommunications systems, networks, and modems before you open the device covers, unless instructed otherwise in the installation and configuration procedures.
- Connect and disconnect cables as described in the following table when installing, moving, or opening covers on this product or attached devices.

To connect:

1. Turn everything OFF.
2. First, attach all cables to devices.
3. Attach signal cables to connectors.
4. Attach power cords to outlet.
5. Turn device ON.

To disconnect:

1. Turn everything OFF.
2. First, remove power cords from outlet.
3. Remove signal cables from connectors.
4. Remove all cables from devices.

Statement 2



CAUTION:

When replacing the lithium battery, use only IBM Part Number 33F8354 or an equivalent type battery recommended by the manufacturer. If your system has a module containing a lithium battery, replace it only with the same module type made by the same manufacturer. The battery contains lithium and can explode if not properly used, handled, or disposed of.

Do not:

- Throw or immerse into water.
- Heat to more than 100° C (212° F)
- Repair or disassemble

Dispose of the battery as required by local ordinances or regulations.

Statement 3



CAUTION:

When laser products (such as CD-ROMs, DVD drives, fiber optic devices, or transmitters) are installed, note the following:

- Do not remove the covers. Removing the covers of the laser product could result in exposure to hazardous laser radiation. There are no serviceable parts inside the device.
- Use of controls or adjustments or performance of procedures other than those specified herein might result in hazardous radiation exposure.



Danger

Some laser products contain an embedded Class 3A or Class 3B laser diode. Note the following. Laser radiation when open. Do not stare into the beam, do not view directly with optical instruments, and avoid direct exposure to the beam.

Statement 4



≥18 kg (39.7 lb)



≥32 kg (70.5 lb)



≥55 kg (121.2 lb)

CAUTION:

Use safe practices when lifting.

Statement 5



CAUTION:

The power-control button on the device and the power switch on the power supply do not turn off the electrical current supplied to the device. The device also might have more than one power cord. To remove all electrical current from the device, ensure that all power cords are disconnected from the power source.

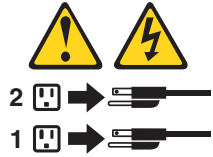

Statement 8



CAUTION:

Never remove the cover on a power supply or any part that has the following label attached.



Hazardous voltage, current, and energy levels are present inside any component that has this label attached. There are no serviceable parts inside these components. If you suspect a problem with one of these parts, contact a service technician.

Statement 12



CAUTION:

The following label indicates a hot surface nearby.



Statement 13



DANGER:

Overloading a branch circuit is potentially a fire hazard and a shock hazard under certain conditions. To avoid these hazards, ensure that your system electrical requirements do not exceed the branch circuit protection requirements. Refer to the information that is provided with your IBM device for electrical specifications.

Statement 14



CAUTION:

Hazardous voltage, current, and energy levels might be present. Only a qualified service technician is authorized to remove the covers where the following label is attached.



Statement 15



CAUTION:

Make sure that the rack is secured properly to avoid tipping when the server unit is extended.

Statement 16



CAUTION:

Some accessory or option board outputs exceed Class 2 or limited power source limits and must be installed with appropriate interconnecting cabling in accordance with the national electric code.

Statement 17



CAUTION:

The following label indicates moving parts nearby.



WARNING: Handling the cord on this product or cords associated with accessories sold with this product, will expose you to lead, a chemical known to the State of California to cause cancer, and birth defects or other reproductive harm. ***Wash hands after handling.***

ADVERTENCIA: El contacto con el cable de este producto o con cables de accesorios que se venden junto con este producto, pueden exponerle al plomo, un elemento químico que en el estado de California de los Estados Unidos está considerado como un causante de cancer y de defectos congénitos, además de otros riesgos reproductivos. ***Lávese las manos después de usar el producto.***

Chapter 1. Introduction

This *Option Installation Guide* contains instructions for installing, removing, and connecting optional devices that your server supports.

Related publications

In addition to this *Option Installation Guide*, the following documentation comes with your server:

- *User's Guide*

This publication is in Portable Document Format (PDF) on the IBM® *xSeries Documentation CD*. It contains general information about your server.

- *Installation Guide*

This printed publication contains instructions for setting up your server and basic instructions for installing some options.

- *Safety Information*

This publication is in PDF on the IBM *xSeries Documentation CD*. It contains translated caution and danger statements. Each caution and danger statement that appears in the documentation has a number that you can use to locate the corresponding statement in your language in the *Safety Information* book.

- *Rack Installation Instructions*

This printed publication contains instructions for installing your server in a rack.

- *Hardware Maintenance Manual and Troubleshooting Guide*

This publication is in PDF on the IBM *xSeries Documentation CD*. It contains information to help you solve problems yourself, and it contains information for service technicians.

Depending on your server model, additional publications might be included on the IBM *xSeries Documentation CD*.

Your server might have features that are not described in the documentation that you received with the server. The documentation might be updated occasionally to include information about those features, or technical updates might be available to provide additional information that is not included in your server documentation. These updates are available from the IBM Web site. Complete the following steps to check for updated documentation and technical updates:

1. Go to <http://www.ibm.com/pc/support/>.
2. In the **Quick path to a product** field, type 8670 and click **Go**.
3. On the left side of the "xSeries 345 8670 support" page, click **Online publications**.
4. From the **Online publications by category** menu, select the category of publications you want to display.

Notices and statements used in this book

The caution and danger statements that appear in this book are also in the multilingual *Safety Information* book, which is on the IBM *xSeries Documentation* CD. Each statement is numbered for reference to the corresponding statement in the *Safety Information* book.

The following notices and statements are used in the documentation:

- **Notes:** These notices provide important tips, guidance, or advice.
- **Important:** These notices provide information or advice that might help you avoid inconvenient or problem situations.
- **Attention:** These notices indicate potential damage to programs, devices, or data. An attention notice is placed just before the instruction or situation in which damage could occur.
- **Caution:** These statements indicate situations that can be potentially hazardous to you. A caution statement is placed just before the description of a potentially hazardous procedure step or situation.
- **Danger:** These statements indicate situations that can be potentially lethal or extremely hazardous to you. A danger statement is placed just before the description of a potentially lethal or extremely hazardous procedure step or situation.

Major components of the xSeries 345 Type 8670 server

The orange color on components and labels in the server indicates hot-swap or hot-plug components. You can install or remove these components while the server is running, provided that the server is configured to support hot-swap and hot-plug features.

The blue color on components and labels indicates touch points, where a component can be gripped, a latch moved, and so on.

The following illustration shows the major components in the server.

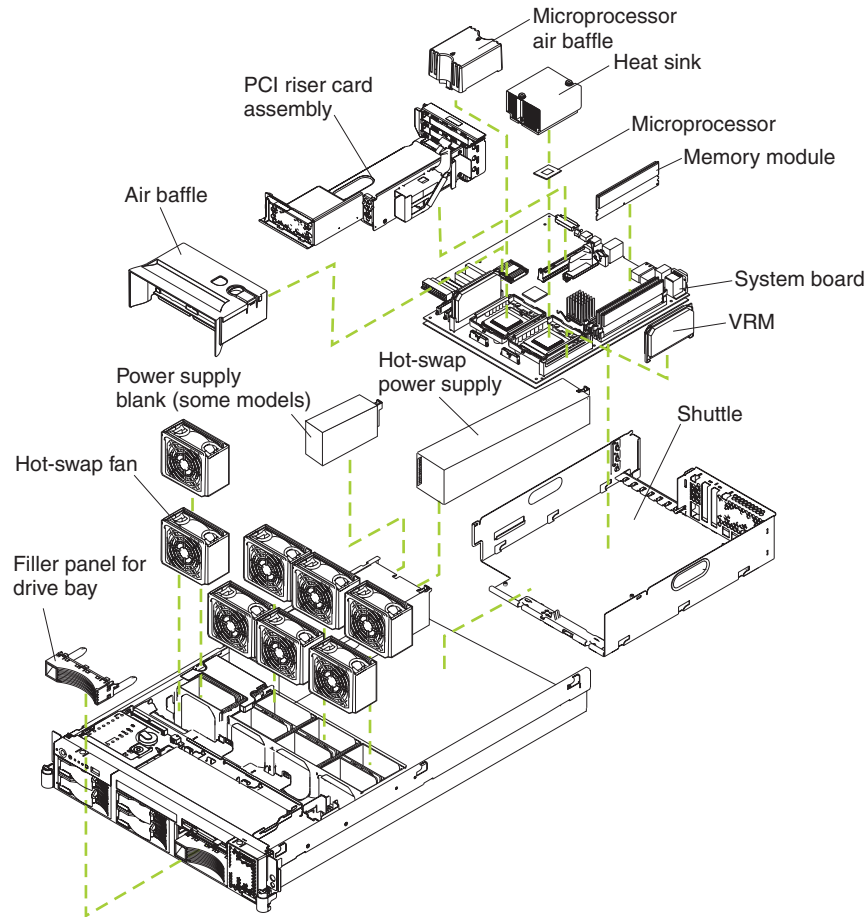

System-board option connectors

The following illustration shows the connectors on the system board for user-installable options.

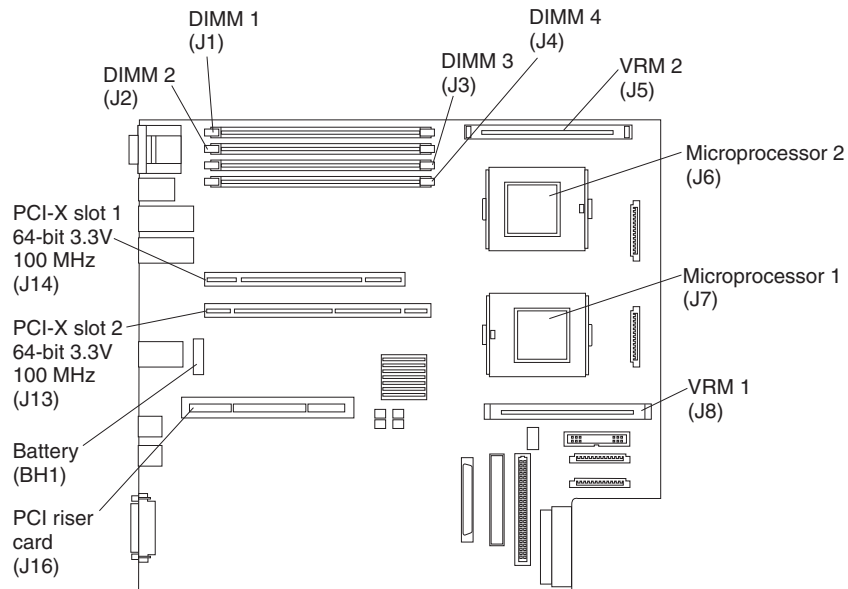

PCI riser-card option connectors

The following illustration shows the connectors on the PCI-riser card for user-installable options.

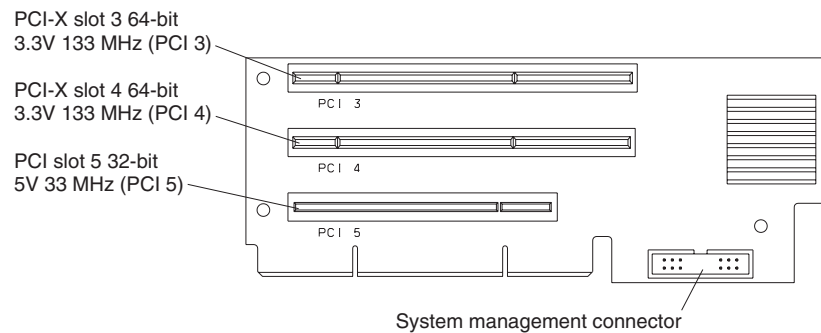

System-board internal cable connectors

The following illustration shows the internal connectors on the system board.

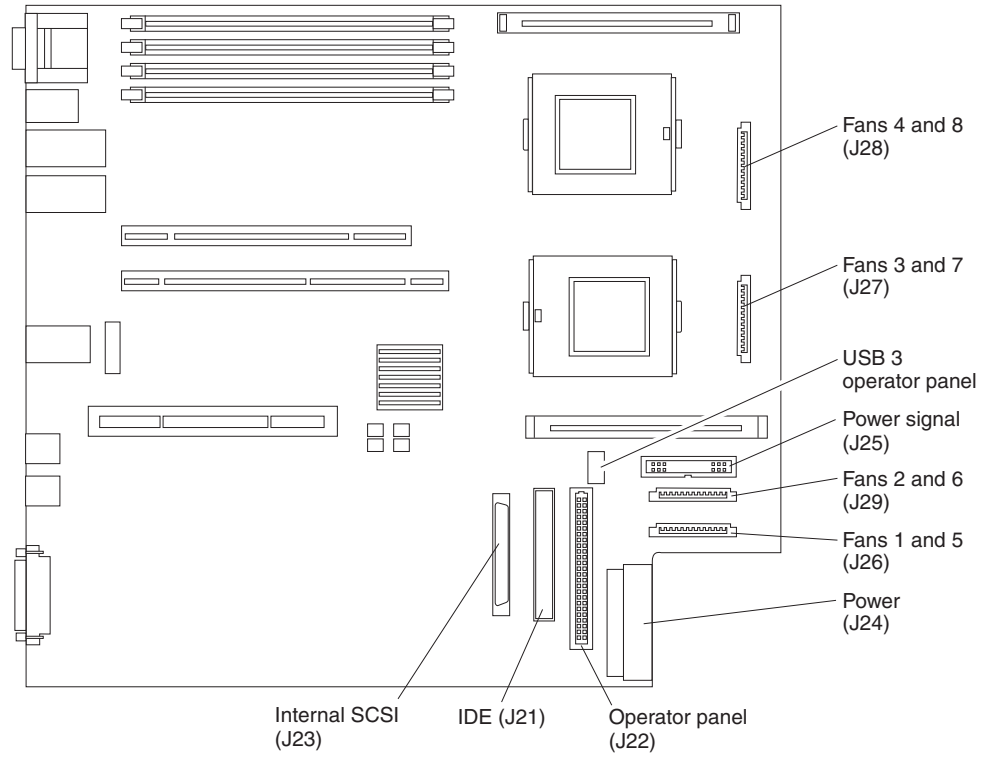

System-board external port connectors

The following illustration shows the external input/output connectors on the system board.

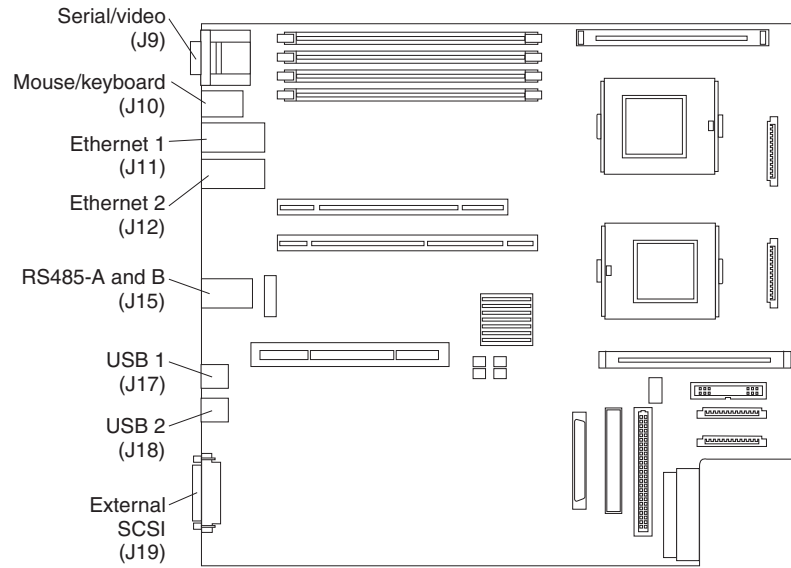

System-board switches and jumpers

The following illustration shows the switches and jumpers on the system board.

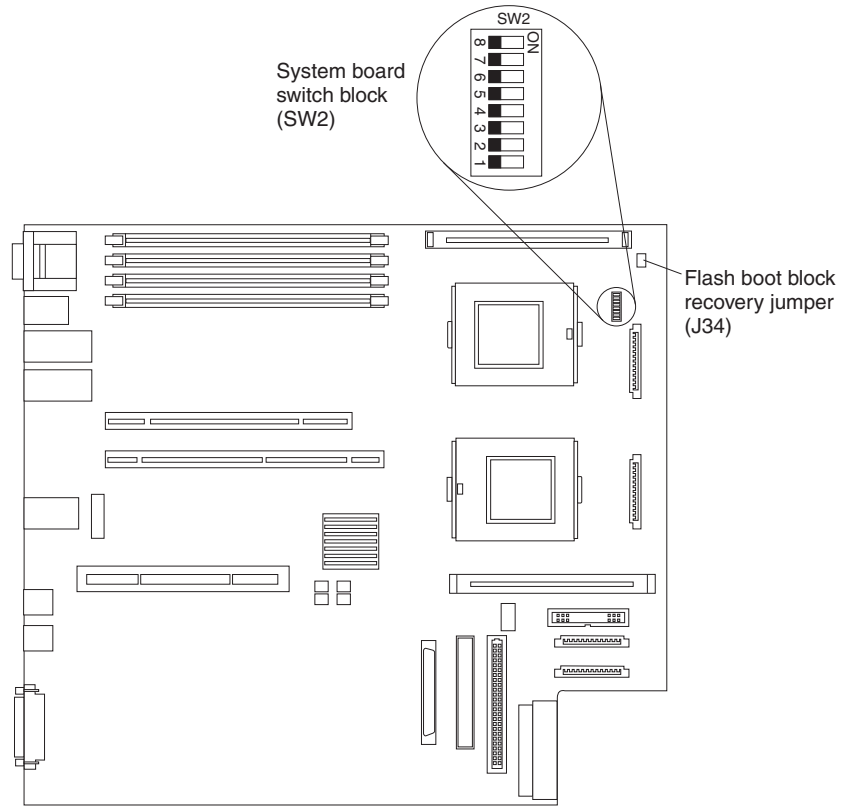

Table 1 describes the function of each switch on the switch block.

Table 1. Switches 1-8

Switch number	Default value	Switch description
8	Off	Reserved.
7	Off	Reserved.
6	Off	Reserved.
5	Off	Reserved.
4	Off	Reserved.
3	Off	Power-on override. When toggled to On, this switch forces the power on, overriding the power-on button.
2	Off	<p>Power-on password override. Changing the position of this switch bypasses the power-on password check the next time the server is turned on and starts the Configuration/Setup Utility program so that you can change or delete the power-on password. You do not need to move the switch back to the default position after the password is overridden.</p> <p>Changing the position of this switch does not affect the administrator password check if an administrator password is set.</p> <p>See the <i>User's Guide</i> on the IBM xSeries Documentation CD for additional information about the power-on password.</p>
1	Off	H8 out serial port. This switch is reserved for service use only.

Notes:

1. Before changing any switch settings or moving any jumpers, turn off the server; then, disconnect all power cords and external cables. (Review the information in "Safety" on page v, "Installation guidelines" on page 11, "Handling static-sensitive devices" on page 11, and "Turning off the server" on page 13.)
2. Any system-board switch or jumper blocks that are not shown in the illustrations in this book are reserved.

System-board LED

The following illustration shows the light-emitting diodes (LEDs) on the system board.

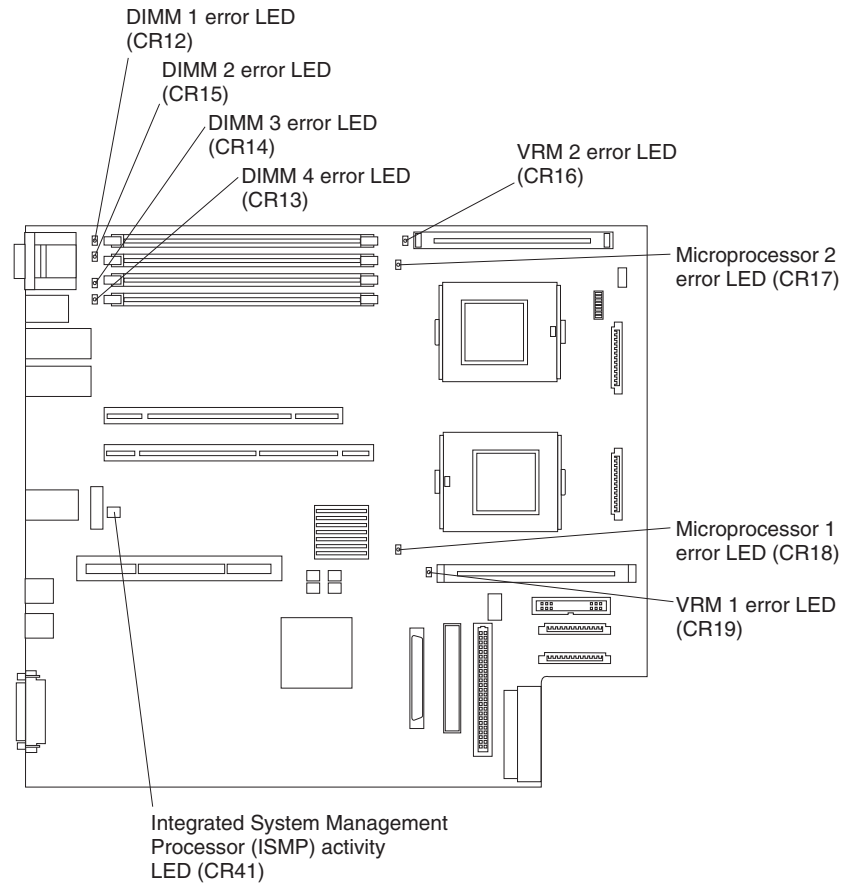

Light Path Diagnostics panel

The following illustration shows the error LEDs on the Light Path Diagnostics™ panel.

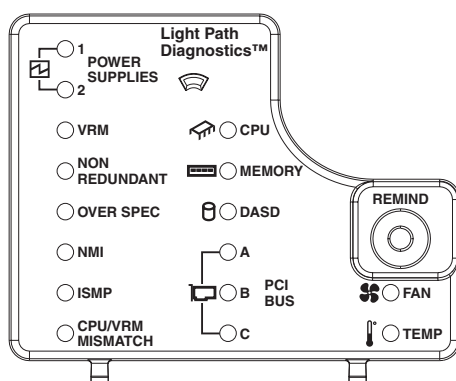

To access the Light Path Diagnostics panel, remove the top cover.

For more information about the Light Path Diagnostics feature, see the *Hardware Maintenance Manual and Troubleshooting Guide* on the IBM xSeries Documentation CD.

To acknowledge a system error but not take immediate action, press the Remind button and place the Light Path Diagnostics feature in Remind mode. The system-error LED on the front of the server flashes in Remind mode. If a new failure occurs, the system-error LED is lit again.

The following table describes the LEDs on the Light Path Diagnostics panel.

Table 2. Diagnostics panel LEDs

Diagnostic panel LED	Description
POWER SUPPLY 1	The power supply in bay 1 failed.
POWER SUPPLY 2	The power supply in bay 2 failed.
VRM	An error occurred on one or both microprocessor voltage regulator modules (VRMs).
CPU	One or both microprocessors failed, or one is seated in the wrong socket.
NON REDUNDANT	The server power supplies are no longer redundant (applicable only with redundant power).
MEMORY	One or more dual inline memory modules (DIMMs) failed.
OVER SPEC	The system has shut down due to a system over load condition.
DASD	The SCSI backplane or a device connected to a SCSI bus failed.
NMI	A nonmaskable interrupt occurred.
PCI BUS A	An error occurred on an adapter in PCI-X slots 1 or 2 or on one of the integrated PCI devices.
ISMP	The integrated system management processor detected an internal error.
PCI BUS B	An error occurred on an adapter in PCI-X slots 3 or 4.
FAN	A fan (1, 2, 3, 4, 5, 6, 7, or 8) failed or is operating slowly.
CPU/VRM MISMATCH	The service processor detected a CPU or VRM mismatch.
PCI BUS C	An error occurred on an adapter in PCI slot 5.
TEMP	The system temperature exceeded the maximum rating.

Chapter 2. Installing options

This chapter provides detailed instructions for installing hardware options in your server.

Installation guidelines

Before you begin installing options in your server, read the following information:

- Read the safety information beginning on page v and the guidelines in “Handling static-sensitive devices”. This information will help you work safely with your server and options.
- Make sure that you have an adequate number of properly grounded electrical outlets for your server, monitor, and other devices that you will connect to the server.
- Back up all important data before you make changes to disk drives.
- Have a small flat-blade screwdriver available.
- For a list of supported options for your server, go to <http://www.ibm.com/pc/compat/> on the World Wide Web.

System reliability considerations

To help ensure proper system cooling and system reliability, make sure that:

- Each of the drive bays has a drive or a filler panel and electromagnetic compatibility (EMC) shield installed in it.
- There is adequate space around the server to allow the server cooling system to work properly. Leave approximately 50 mm (2 in.) of open space around the front and rear of the server. Do not place objects in front of the fans.
- You have followed the cabling instructions that come with optional adapters.
- You have replaced a failed fan as soon as possible.

Working inside the server with the power on

Your server supports hot-plug, hot-add, and hot-swap devices and is designed to operate safely while turned on with the cover removed. Follow these guidelines when you work inside a server that is turned on:

- Avoid loose-fitting clothing on your forearms. Button long-sleeved shirts before working inside the server; do not wear cuff links while you are working inside the server.
- Do not allow your necktie or scarf to hang inside the server.
- Remove jewelry, such as bracelets, necklaces, rings, and loose-fitting wrist watches.
- Remove items from your shirt pocket (such as pens or pencils) that could fall into the server as you lean over it.
- Avoid dropping any metallic objects, such as paper clips, hair pins, or screws, into the server.

Handling static-sensitive devices

Attention: Static electricity can damage electronic devices and your system. To avoid damage, keep static-sensitive devices in their static-protective packages until you are ready to install them.

To reduce the possibility of electrostatic discharge, observe the following precautions:

- Limit your movement. Movement can cause static electricity to build up around you.
- Handle the device carefully, holding it by its edges or its frame.
- Do not touch solder joints, pins, or exposed printed circuitry.
- Do not leave the device where others can handle and possibly damage the device.
- While the device is still in its static-protective package, touch it to an unpainted metal part of the system unit for at least 2 seconds. (This drains static electricity from the package and from your body.)
- Remove the device from its package and install it directly into your system unit without setting it down. If it is necessary to set the device down, place it in its static-protective package. Do not place the device on your system unit cover or on a metal table.
- Take additional care when handling devices during cold weather because heating reduces indoor humidity and increases static electricity.

Server power features

When the server is connected to an ac power source but is not turned on, the operating system does not run, and all core logic except for the service processor is shut down; however, the server can respond to requests from the service processor, such as a remote request to turn on the server. The power-on LED flashes to indicate that the server is connected to ac power but not turned on.

Turning on the server

Approximately 20 seconds after the server is connected to ac power, the power-control button becomes active, and you can turn on the server and start the operating system by pressing the power-control button. The server can also be turned on in any of the following ways:

- If a power failure occurs while the server is turned on, the server will restart automatically when power is restored.
- If the server is connected to an Advanced System Management interconnect network that contains at least one server with an optional Remote Supervisor Adapter installed, the server can be turned on from the Remote Supervisor Adapter user interface.
- If your operating system supports the system-management software for an optional Remote Supervisor Adapter, the system-management software can turn on the server.
- If your operating system supports the Wake on LAN[®] feature, the Wake on LAN feature can turn on the server.

Note: When 4 GB or more of memory (physical or logical) is installed, some memory is reserved for various system resources and is unavailable to the operating system. The amount of memory that is reserved for system resources depends on the operating system, the configuration of the server, and the configured PCI options.

Turning off the server

When you turn off the server and leave it connected to ac power, the server can respond to requests from the service processor, such as a remote request to turn on the server. To remove all power from the server, you must disconnect it from the power source.

Some operating systems require an orderly shutdown before you turn off the server. See your operating-system documentation for information about shutting down the operating system.

Statement 5:



CAUTION:

The power control button on the device and the power switch on the power supply do not turn off the electrical current supplied to the device. The device also might have more than one power cord. To remove all electrical current from the device, ensure that all power cords are disconnected from the power source.

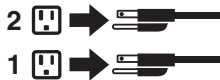

The server can be turned off in any of the following ways:

- You can turn off the server from the operating system, if your operating system supports this feature. After an orderly shutdown of the operating system, the server will be turned off automatically.
- You can press the power-control button to start an orderly shutdown of the operating system and turn off the server, if your operating system supports this feature.
- If the operating system stops functioning, you can press and hold the power-control button for more than 4 seconds to turn off the server.
- If the server is connected to an Advanced System Management interconnect network that contains at least one server with an optional Remote Supervisor Adapter installed, the server can be turned off from the Remote Supervisor Adapter user interface.
- If an optional Remote Supervisor Adapter is installed in the server, the server can be turned off from the Remote Supervisor Adapter user interface.
- If the Wake on LAN feature turned on the server, the Wake on LAN feature can turn off the server.
- The integrated system management processor can turn off the server as an automatic response to a critical system failure.
- You can turn off the server through a request from the service processor.

Removing the cover and bezel

The following illustration shows how to remove the cover and bezel.

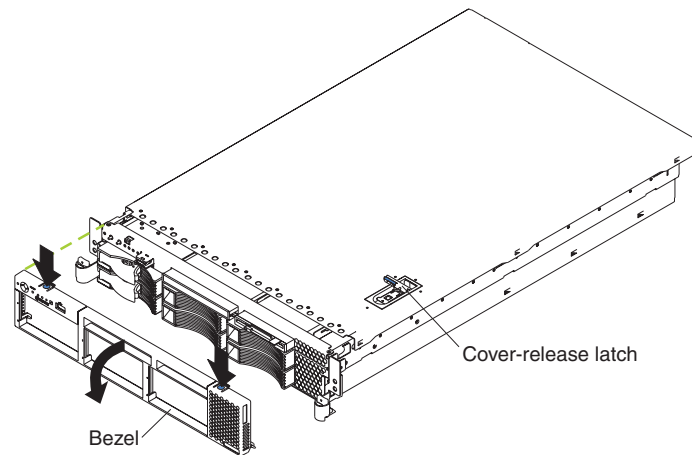

Complete the following steps to remove the server top cover:

1. Read the safety information beginning on page v, and “Installation guidelines” on page 11.
2. If you are planning to install or remove a microprocessor, memory-module, PCI adapter, or battery, turn off the server and all attached devices and disconnect all external cables and power cords (see “Turning off the server” on page 13).
3. Press down on the left and right side latches and pull the server out of the rack enclosure until both side rails lock.

Note: You can reach the cables on the back of the server when the server is in the locked position.

4. Lift the cover-release latch. Lift the cover off the server and set the cover aside.

Attention: For proper cooling and airflow, replace the cover before turning on the server. Operating the server for extended periods of time (over 30 minutes) with the cover removed might damage server components.

Complete the following steps to remove the bezel:

1. Press in on the tabs on the top of the bezel, and rotate the bezel away from the server front.
2. Store the bezel in a safe place

Working with adapters

The following notes describe the types of adapters that your server supports and other information that you must consider when installing adapters:

Before you install an adapter, review the following information:

- Read the documentation that comes with your operating system.
- Locate the documentation that comes with the adapter and follow those instructions in addition to the instructions in this chapter. If you need to change the switch or jumper settings on your adapter, follow the instructions that come with the adapter.
- You can install only low-profile adapters in slots 1 and 2.
- You can install standard full-length adapters, with the adapter guides removed from the adapters, in slots 3 and 4.
- You can install only a half-length adapter in slot 5.
- The ServeRAID-5i controller can be installed only in PCI slot 2. The low-profile 2-U bracket that comes with the controller is required to install the controller.
- The optional IBM Remote Supervisor Adapter can be installed only in PCI slot 5. Use the ribbon cable that comes with the adapter to connect the adapter to the system management connector on the PCI riser-card.
- Your server supports 5.0 V and universal PCI adapters on the 32-bit PCI slot 5; your server supports only 3.3 V and universal PCI adapters in the 64-bit PCI/PCI-X slot 3 and 4.
- The PCI bus configuration is:
 - Non-hot-plug, 64-bit PCI-X slots 1 through 2 (PCI bus A, 100 MHz)
 - Non-hot-plug, 64-bit PCI-X slots 3 through 4 (PCI bus B, 133 MHz)
 - Non-hot-plug, 32-bit PCI slot 5 (PCI bus C, 33 MHz)
- The system scans PCI and PCI-X slots 1 through 5 to assign system resources; then the system starts (boots) the system devices in the following order, if you have not changed the default boot precedence: integrated Ethernet controller, integrated SCSI controller, and then PCI and PCI-X slots 5, 3, 4, 1, and 2.

Notes:

1. If the ServeRAID-5i controller is installed, it takes control of the integrated SCSI controller with RAID capabilities and operates at 66 MHz. The ServeRAID-5i controller can be installed only in slot 2.
2. To have SCSI capabilities if you remove the ServeRAID-5i controller or other RAID controller, start the Configuration/Setup Utility program and select **Devices and I/O Ports** from the main menu to enable the SCSI controller with RAID capabilities. See the *User's Guide* on the IBM xSeries *Documentation* CD for details about using the Configuration/Setup Utility program.
3. To change the boot precedence for PCI and PCI-X devices, start the Configuration/Setup Utility program and select **Start Options** from the main menu. See the *User's Guide* on the IBM xSeries *Documentation* CD for details about using the Configuration/Setup Utility program.

The following illustrations show the location of the PCI and PCI-X adapter expansion slots on the system board and PCI riser card.

System board

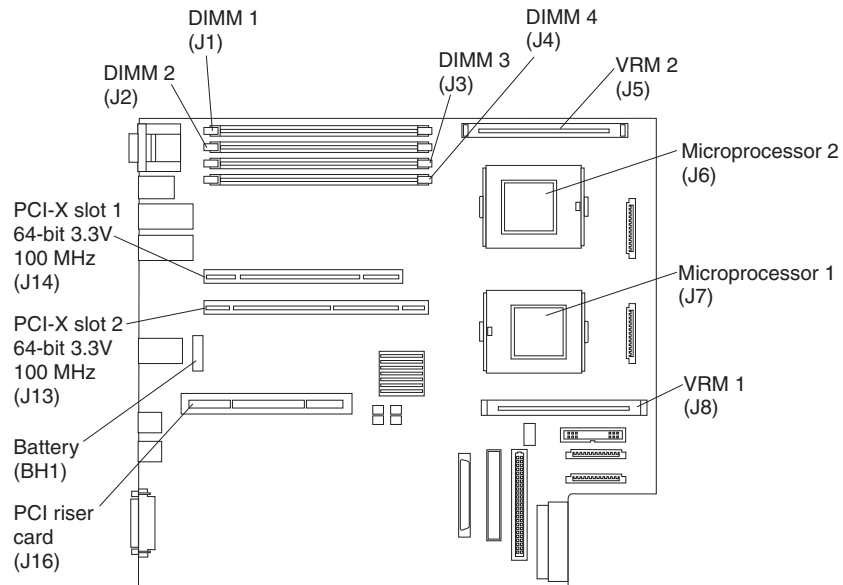

PCI riser card

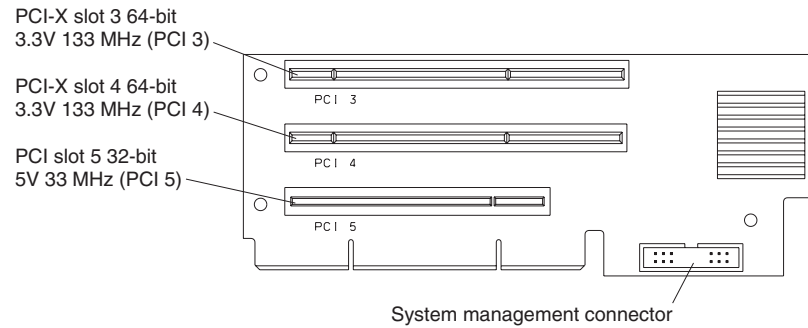

The following illustration shows how to install a PCI or PCI-X adapter.

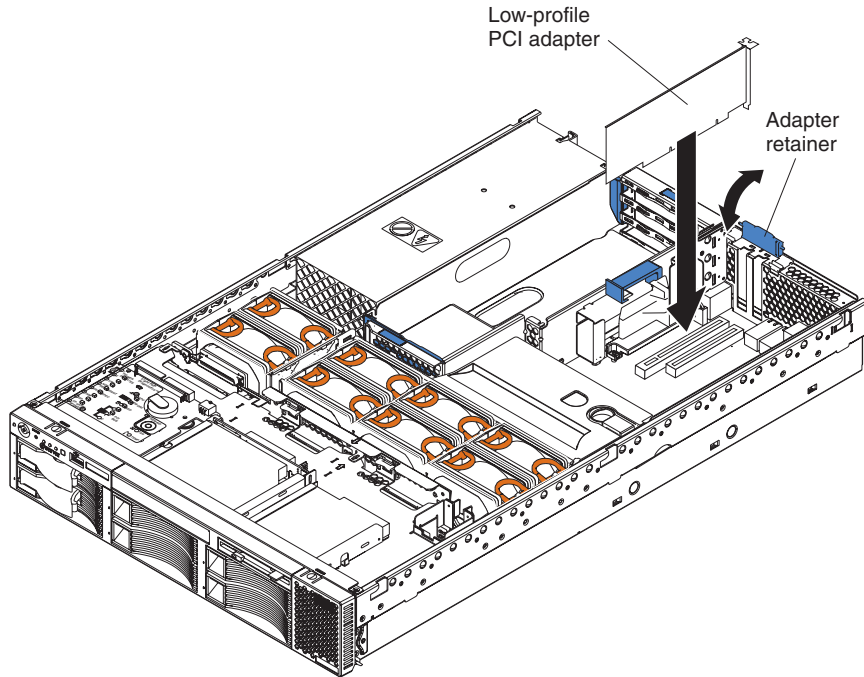

Complete the following steps to install a PCI or PCI-X adapter:

1. Read the safety information beginning on page v, and “Installation guidelines” on page 11.
2. Turn off the server and peripheral devices and disconnect all power cords and external cables (see “Turning off the server” on page 13); then, remove the cover (see “Removing the cover and bezel” on page 15).
3. Determine which expansion slot you will use for the adapter.

4. If you are installing an adapter in PCI slot 3, 4, or 5, remove the PCI riser-card assembly.

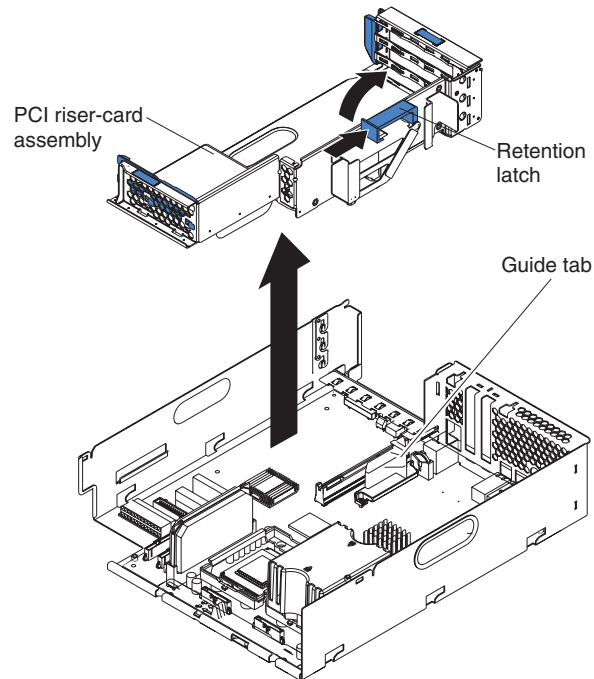

- a. Lift the retention latch to release the PCI riser-card assembly.
 - b. Lift the assembly from the server.
 - c. Place the assembly on a flat, level surface.
5. Open the adapter retainer and slide the expansion-slot cover out of the server or PCI riser-card assembly. Store it in a safe place for future use.
Attention: Expansion-slot covers must be installed on all empty slots. This maintains the electronic emissions characteristics of the system and ensures proper cooling of system components.
 6. See the documentation that comes with your adapter for any cabling instructions. It might be easier for you to route cables before you install the adapter.
 7. Remove the adapter from the static-protective package.
Attention: Avoid touching the components and gold-edge connectors on the adapter.

8. Install the adapter:

- a. If you are installing a full-length adapter, remove the blue adapter guide (if any) from the end of the adapter.

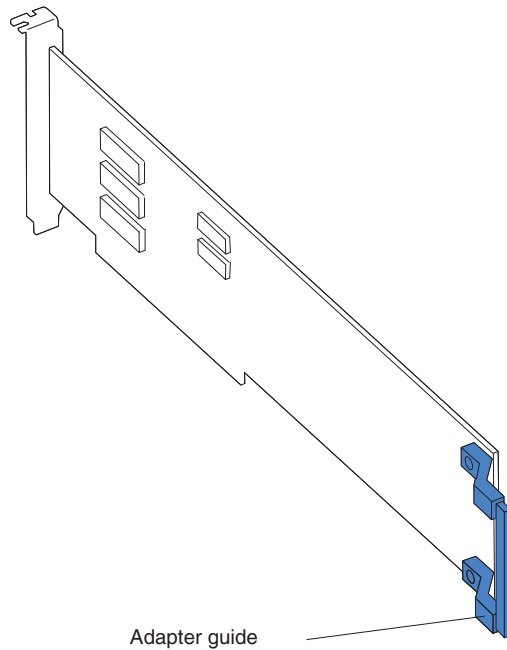

- b. Carefully grasp the adapter by its top edge or upper corners, and align it with the expansion slot.
- c. Press the adapter *firmly* into the expansion slot and close the adapter retainer.

Attention: When you install an adapter in the server, be sure that it is completely and correctly seated in the connector. Incomplete insertion might cause damage to the system board or the adapter.

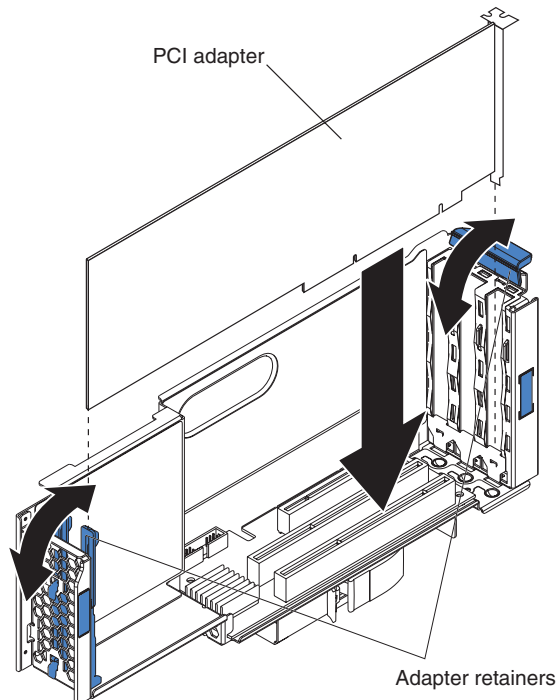

9. If you removed the PCI riser-card assembly to install the adapter, press the PCI riser-card assembly *firmly* into the connector and close the retention latch.

Note: Make sure that the PCI riser-card assembly is properly seated on the system-board connector and that the cables under the PCI riser-card assembly are not pinched.

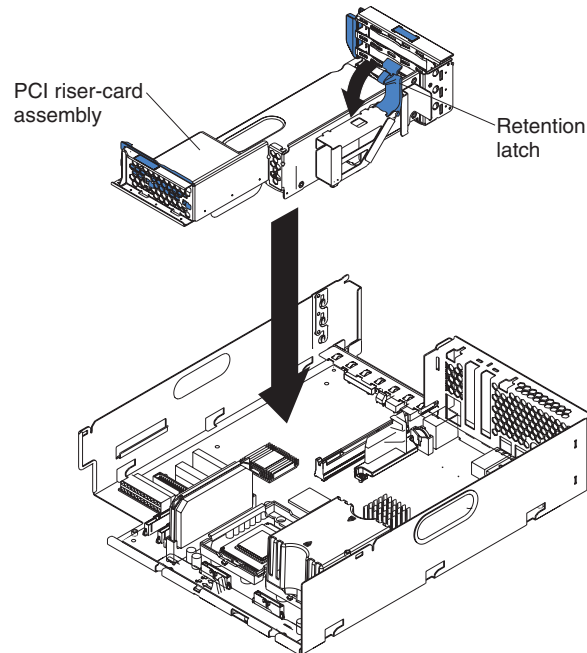

10. Connect any needed cables to the adapter. See the documentation that comes with your adapter for cabling instructions.

Attention:

- When you route the cables, do not block the ventilated space around any of the fans. In addition, route any cables that are plugged into the PCI adapter under adjacent adapters so they are not pinched between the top edge of the adapter and the shuttle side wall.
- To ensure system reliability, an optional SCSI adapter cannot control internal hard disk drives.

If you have other options to install or remove, do so now. Otherwise, go to “Installing the server cover and bezel” on page 36.

Installing a ServeRAID-5i controller

The following notes describe the ServeRAID-5i controller and other information that you must consider when installing the ServeRAID-5i controller:

- You can install an optional RAID controller in your server to control the internal hot-swap hard disk drives, for example, to enable you to configure the internal hot-swap hard disk drives into disk arrays. You can also cable a RAID adapter to external hard disk drives. See your RAID controller option documentation for complete instructions on installing a RAID controller in your server and for additional information on RAID controllers.
- No rerouting of the internal SCSI cable is required if you are installing the ServeRAID-5i controller. The ServeRAID-5i controller uses the SCSI connector on the system board for output.

- The ServeRAID-5i controller can be installed only in PCI-X slot 2. Slot 2 is the only PCI-X slot that supports the ServeRAID-5i controller requirements.
- Connections made to external SCSI devices will be asynchronous.
- To have SCSI capabilities if you remove the ServeRAID-5i controller or other RAID controller, start the Configuration/Setup Utility program and select **Devices and I/O Ports** from the main menu to enable the SCSI controller with RAID capabilities. See the *User's Guide* on the IBM *xSeries Documentation CD* for details about using the Configuration/Setup Utility program.

Complete the following steps to install a ServeRAID-5i controller:

1. Read the safety information beginning on page v, and “Installation guidelines” on page 11.
2. Turn off the server and peripheral devices and disconnect all power cords and external cables (see “Turning off the server” on page 13); then, remove the cover (see “Removing the cover and bezel” on page 15).
3. Open the adapter retainer and slide the slot 2 expansion-slot cover out of the server. Store it in a safe place for future use.

Attention: Expansion-slot covers must be installed on all empty slots. This maintains the electronic emissions characteristics of the system and ensures proper cooling of system components.

4. Install the low profile 2-U bracket on the adapter:
 - a. Remove the adapter from the static-protective package. Set the adapter down on a nonconductive, static-protected surface (place it component side up).
5. Install the adapter:
 - a. Carefully grasp the adapter by its top edge or upper corners, and align it with the expansion slot on the system board.
 - b. Press the adapter *firmly* into the expansion slot and close the adapter retainer.

Attention: Avoid touching the components and gold-edge connectors on the adapter.

Attention: When you install an adapter in the server, be sure that it is completely and correctly seated in the connector. Incomplete insertion might cause damage to the system board or the adapter.

If you have other options to install or remove, do so now. Otherwise, go to “Installing the server cover and bezel” on page 36.

Installing a hot-swap drive

The following notes describe the type of hard disk drive that your server supports and other information that you must consider when installing a hard disk drive:

- Your server supports six 1-inch (26 mm) slim 3.5-inch low-voltage differential (LVD) hard disk drives.
- All hot-swap drives installed in the server should have the same throughput speed rating. Mixing hard disk drives with different speed ratings will cause all drives to operate at the lower throughput speed.
- The SCSI ID assigned to each bay is printed on the bezel.

The following illustration shows how to install a hot-swap hard disk drive.

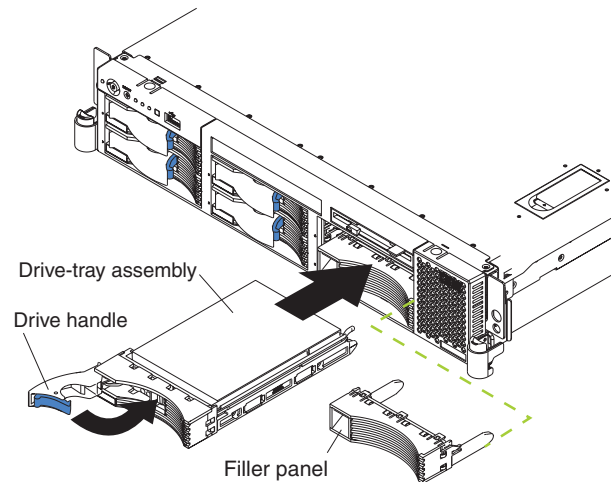

Complete the following steps to install a drive in a hot-swap bay.

Attention: To maintain proper system cooling, do not operate the server for more than 10 minutes without either a drive or a filler panel installed in each bay.

1. Read the safety information beginning on page v, and “Installation guidelines” on page 11.
2. Remove the filler panel from one of the empty hot-swap bays by inserting your finger into the depression at the left side of the filler panel and pulling it away from the server.
3. Install the hard disk drive in the hot-swap bay:
 - a. Ensure that the tray handle is open (that is, perpendicular to the drive).
 - b. Align the drive assembly with the guide rails in the bay.
 - c. Gently push the drive assembly into the bay until the drive stops.
 - d. Push the tray handle to the closed (locked) position.
 - e. Check the hard disk drive status LED to verify that the hard disk drive is operating properly.

If the amber hard disk drive status LED for a drive is lit continuously, that individual drive is faulty and needs to be replaced. If the green hard disk drive activity LED is flashing, the drive is being accessed.

Note: If you have a RAID configuration on your server using the integrated SCSI controller with RAID capabilities, or if your server has a RAID adapter installed, you might need to reconfigure your disk arrays after installing hard disk drives. See the RAID documentation on the IBM *xSeries Documentation* CD for information about RAID adapters.

Installing memory modules

The following notes describe the types of dual inline memory modules (DIMMs) that your server supports and other information that you must consider when installing DIMMs:

- The system board contains four DIMM connectors and supports two-way memory interleaving.
- The DIMM options available for your server are 256 MB, 512 MB, 1 GB, and 2 GB.

- The amount of usable memory will be reduced depending on the system configuration. The BIOS will display the total amount of installed memory and the amount of configured memory.
- Your server supports a minimum of two 256 MB DIMMs (for a total of 512 MB) installed in the DIMM 1 and DIMM 2 memory connectors (J1 and J2, respectively). When you install additional DIMMs, install them in pairs, with the next pair in DIMM connectors 3 and 4 (J3 and J4).
- Both DIMMs in a pair must be the same size, speed, type, and technology. You can mix compatible DIMMs from various manufacturers.
- The second pair of DIMMs do not have to be the same size, speed, type, and technology as the first pair.
- Install only 2.5 V, 184-pin, double-data-rate (DDR), PC2100, registered synchronous dynamic random-access memory (SDRAM) with error correcting code (ECC) DIMMs. These DIMMs must be compatible with the latest PC2100 (and downward compatible with PC1600) SDRAM Registered DIMM specification, which is available from <http://www.jedec.org/> on the World Wide Web. For a list of supported options for your server, go to <http://www.ibm.com/us/compat/> on the World Wide Web.
- Your server supports Chipkill™ technology, if the DIMMs are all of the type 4x.
- Save new configuration information only if you replace a faulty DIMM that was marked as **Disabled** in the Configuration/Setup Utility program **Memory Settings** menu. In this case, re-enable the memory row in the Configuration/Setup Utility program or reload the default memory settings. See the *User's Guide* on the IBM xSeries Documentation CD for more information.
- Before you begin, read the documentation that comes with your option.
- Install the DIMMs in the order shown in the following table:

Table 3. DIMM order of installation

Pair	DIMM connectors
First	1 and 2 (J1, J2)
Second	3 and 4 (J3, J4)

The following illustration shows how to install DIMMs on the system board.

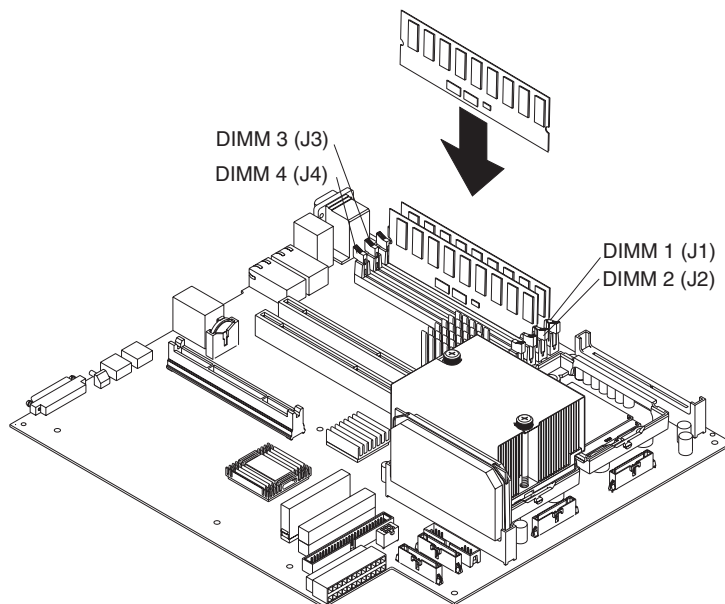

Complete the following steps to install a DIMM:

1. Read the safety information beginning on page v, and “Installation guidelines” on page 11.
2. Turn off the server and disconnect all power cords and external cables (see “Turning off the server” on page 13); then, remove the server cover (see “Removing the cover and bezel” on page 15).
3. Locate the DIMM connectors on the system board and determine the connectors into which you will install the DIMMs.
4. Touch the static-protective package that contains the DIMM option to any unpainted metal surface on the server. Then, remove the DIMM from the package.
5. To install the DIMM, repeat the following steps for each DIMM that you install:
 - a. Turn the DIMM so that the DIMM keys align correctly with the connector on the system board.

Attention: To avoid breaking the retaining clips or damaging the DIMM connectors, handle the clips gently.
 - b. If closed, open the retaining clips; then, insert the DIMM by pressing the DIMM straight into the connector. Be sure that the retaining clips snap into the closed position.

Note: If a gap exists between the DIMM and the retaining clips, the DIMM has not been properly installed. In this case, open the retaining clips and remove the DIMM; then, reinsert the DIMM.

If you have other options to install or remove, do so now. Otherwise, go to “Installing the server cover and bezel” on page 36.

Installing a microprocessor

The following notes describe the type of microprocessor that your server supports and other information that you must consider when installing a microprocessor:

- Your server supports up to two microprocessors. With two microprocessors, your server can operate as a symmetric multiprocessing (SMP) server. With SMP, certain operating systems and application programs can distribute the processing load between the microprocessors. If your server comes with one microprocessor, you can install a second microprocessor.
- You might need to update the server BIOS code. Be sure to read the documentation that comes with the microprocessor so that you can determine whether you need to update the server BIOS code. You can download the latest level of BIOS code and many other code updates for your server at <http://www.ibm.com/pc/support/> on the World Wide Web.
- (Optional) Obtain an SMP-capable operating system. For a list of supported operating systems and other options, go to <http://www.ibm.com/pc/us/compat/> on the World Wide Web.
- To order additional microprocessor options, contact your IBM reseller or IBM marketing representative.
- When you install the microprocessor in socket J6, you must also install the voltage regulator module (VRM) that comes with the microprocessor in VRM connector J5.
- The microprocessor speeds are automatically set for this server; therefore, you do not need to set any microprocessor frequency-selection jumpers or switches.
- If you need to replace a microprocessor, call for service.
- If your server supports a 400 MHz front-side bus, install only a microprocessor with one pin missing from one corner and two pins missing from an adjacent corner. If your server supports a 400 MHz front-side bus, the heat-sink retention mechanism surrounding the microprocessor connector is metallic gray.

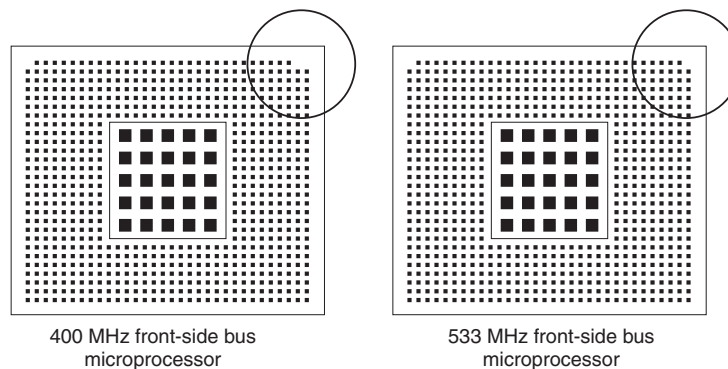

If your server supports a 533 MHz front-side bus, install only a microprocessor with one pin missing from each of two adjacent corners. If your server supports a 533 MHz front-side bus, the heat-sink retention mechanism surrounding the microprocessor connector is black.

- If the thermal-grease protective cover (for example, a plastic cap or tape liner) is removed from the heat sink or fan sink, do not touch the thermal grease on the bottom of the heat sink or fan sink or set down the heat sink or fan sink.

Note: Removing the heat sink or fan sink from the microprocessor destroys the even distribution of the thermal grease and requires replacing the thermal grease. Setting down the heat sink or fan sink onto any surface when the

thermal-grease protective cover is removed will contaminate the thermal grease. If the thermal grease becomes contaminated with particles, it must be replaced.

For information about replacing contaminated thermal grease on the heat sink or fan sink, contact IBM Integrated Technology Services. For the most up-to-date phone numbers, go to <http://www.ibm.com/planetwide/>, or in the U.S. and Canada, call 1-800-IBM-SERV (1-800-426-7378).

Have the following information ready when you call:

- Machine type and model
- Serial number of your server or computer
- Do not remove the first microprocessor from the system board to install the second microprocessor.

The following illustration is a simplified layout of the microprocessor connector locations and other microprocessor-related components on the system board.

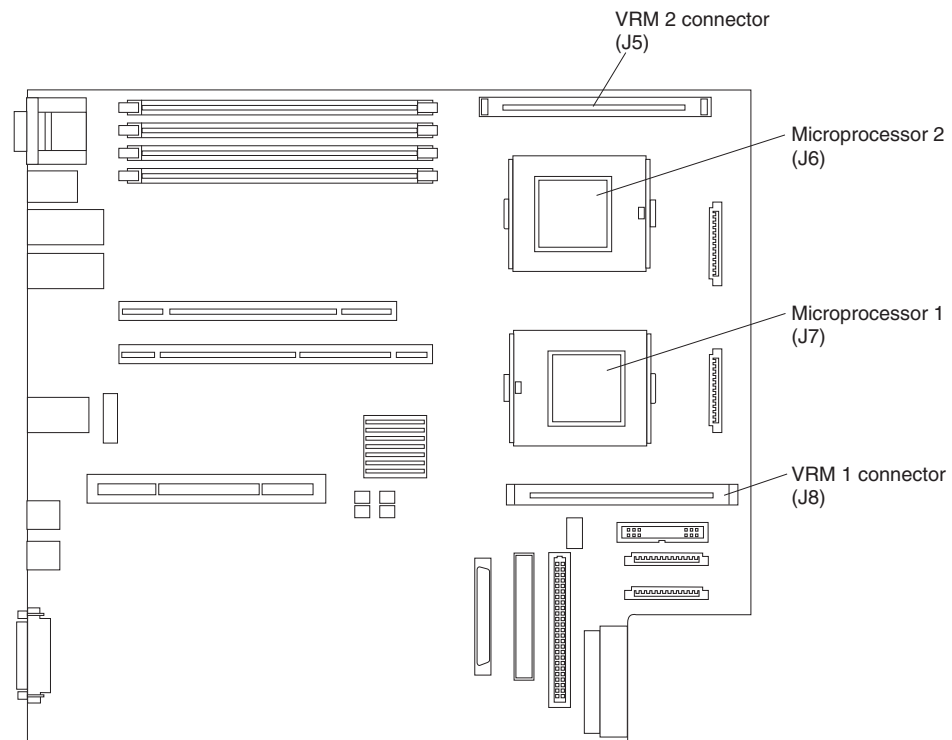

Note: For additional illustrations of the system-board components, see “System-board option connectors” on page 4.

The following illustration shows how to install the second microprocessor on the system board.

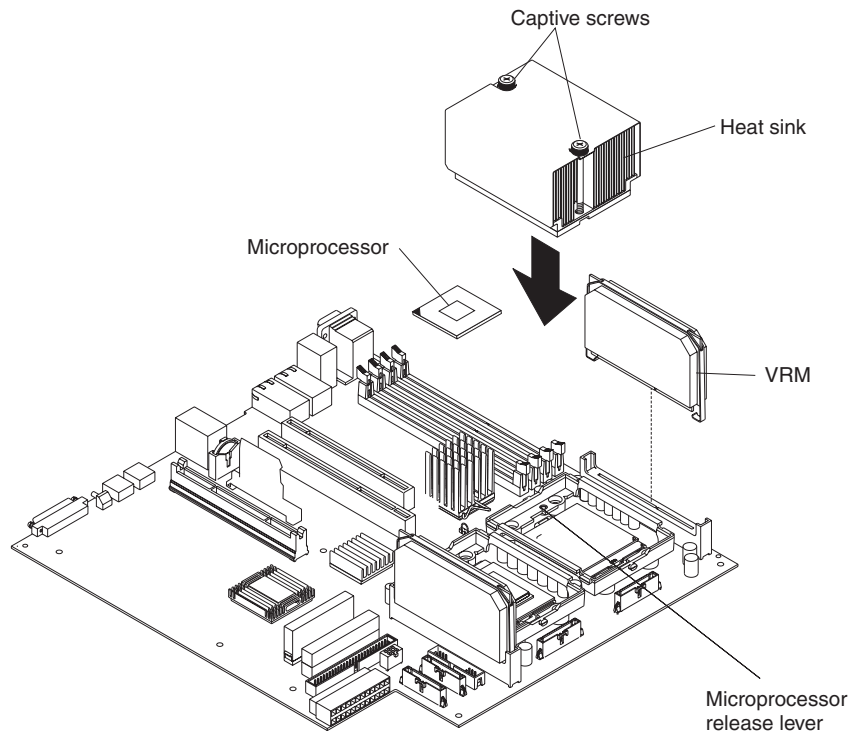

Attention:

- A startup (boot) processor must always be installed in socket J7 on the system board.
- To ensure proper server operation when you install an additional microprocessor, use microprocessors that have the same cache size and type, and the same clock speed. Microprocessor internal and external clock frequencies must be identical.

Complete the following steps to install an additional microprocessor:

1. Read the safety information beginning on page v, and “Installation guidelines” on page 11.
2. Turn off the server and disconnect all power cords and external cables (see “Turning off the server” on page 13); then, remove the server cover (see “Removing the cover and bezel” on page 15).
3. Remove the air baffle covering the microprocessor section of the system board and set the air baffle aside.

4. Remove the air baffle from the empty microprocessor socket. Store it in a safe place for future use. An empty microprocessor socket must contain an air baffle.

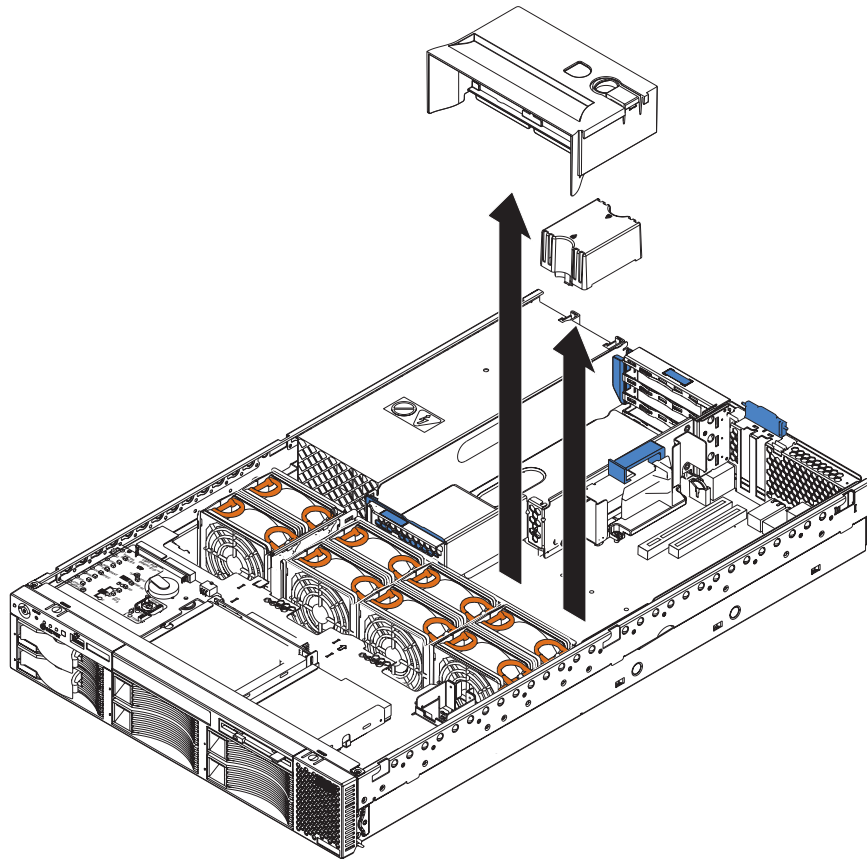

5. Install a VRM in the VRM connector (J5). See the illustration at the beginning of these instructions for the location of the connectors:
 - a. Center the VRM over the connector. Make sure that the VRM is oriented and aligned correctly.
 - b. Carefully but firmly push down the VRM to seat the VRM in the connector.
 - c. Insert one end of the retainer clip on the side of the connector and fit the retainer clip over the VRM. Insert the free end of the retainer clip on the other side of the connector.

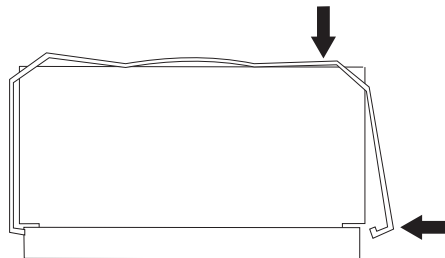

6. Locate the second microprocessor socket (connector J6) on the system board.

7. Install the microprocessor:

- a. Touch the static-protective package containing the microprocessor to any unpainted metal surface on the server. Then, remove the microprocessor from the package.
- b. Remove the protective cover, tape, or label from the surface of the microprocessor socket, if present.

Attention: You must ensure that the locking lever on the microprocessor socket is in the fully open position before you insert the microprocessor in the socket. Failure to do so might result in permanent damage to the microprocessor, microprocessor socket, and system board.

- c. Rotate the locking lever on the microprocessor socket from its closed and locked position until it stops or clicks in the fully open position (approximately 135° angle).

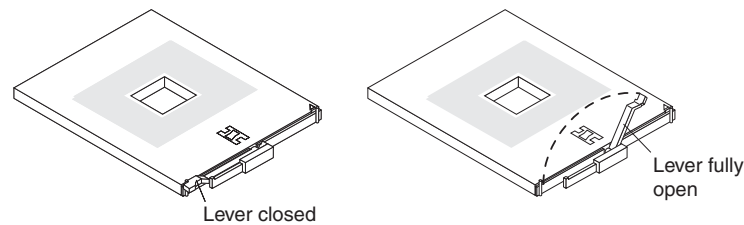

Attention:

- Do not use excessive force when pressing the microprocessor into the socket.
 - Make sure that the microprocessor is oriented and aligned correctly with pin number 1 in the socket before you try to close the lever.
- d. Center the microprocessor over the microprocessor socket. Align the triangle on the corner of the microprocessor with the triangle on the corner of the socket and carefully press the microprocessor into the socket.

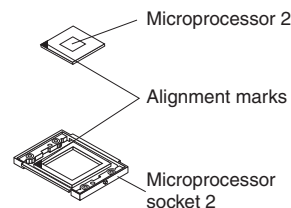

- e. Carefully close the microprocessor-release lever to secure the microprocessor in the socket.

8. Install a heat sink on the microprocessor:

Attention:

- Do not set the heat sink down after you remove the plastic cover.

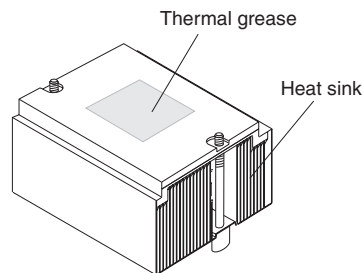

- Do not touch the thermal grease on the bottom of the heat sink or set down the heat sink. Any contact with the thermal grease will contaminate it. For details, see the thermal grease information on page 26.
 - a. Remove the plastic protective cover from the bottom of the heat sink.
 - b. Align and place the heat sink on top of the microprocessor with the thermal grease side down. Press firmly on the heat sink.
Attention: If you do not alternate the tightening of the two captive screws, you might damage the microprocessor. Ensure that the screws are completely tightened; otherwise, the server will not function properly.
 - c. Alternate the tightening of the captive screws to secure the heat sink to the microprocessor. Turn one screw a few turns and then turn the other screw a few turns, alternating between the screws until the heat sink is secure.
9. Install the air baffle over the microprocessor section of the system board.

If you have other options to install or remove, do so now. Otherwise, go to “Installing the server cover and bezel” on page 36.

Installing a hot-swap power-supply option

Your server supports a maximum of two hot-swap power supplies.

Statement 8



CAUTION:

Never remove the cover on a power supply or any part that has the following label attached.



Hazardous voltage, current, and energy levels are present inside any component that has this label attached. There are no serviceable parts inside these components. If you suspect a problem with one of these parts, contact a service technician.

The following illustration shows how to install a power supply.

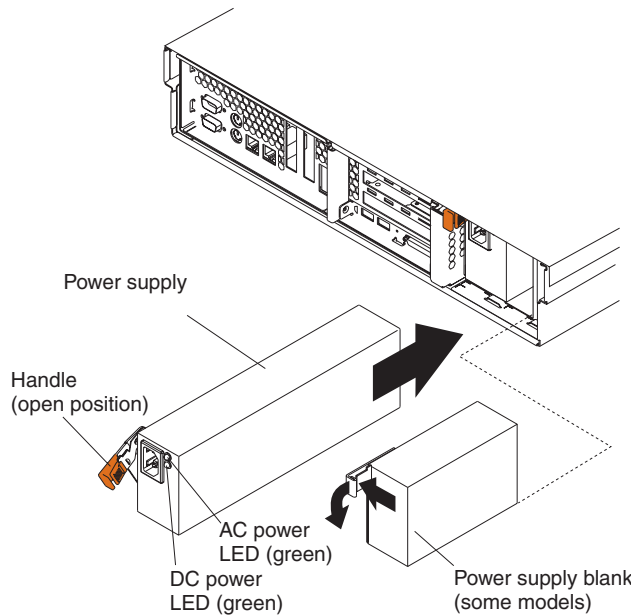

Complete the following steps to install a power supply:

1. Read the safety information beginning on page v, and “Installation guidelines” on page 11.
2. (Some models) Remove the power-supply blank from the empty power-supply bay by pinching the side clip and pulling the power-supply blank from the bay. Save the power-supply blank in case you remove the power supply at a later time.

Attention: During normal operation, each power-supply bay must have either a power supply or power-supply blank installed for proper cooling.

3. Install the power supply in the bay:
 - a. Move the handle on the power supply into the open position, pinch the side-clip, and slide the power supply into the chassis.
 - b. Gently close the handle to seat the power supply in the bay.
4. Plug the power cord for the new power supply into the power-cord connector on the power supply.

The following illustration shows the power-supply connectors on the back of the server.

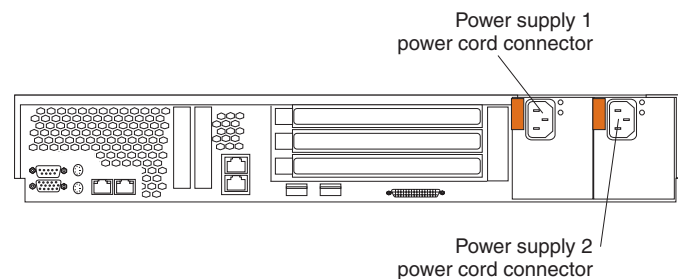

5. Route the power cord through the cable-management arm. (See “Installing the server in a rack” on page 36).
6. Plug the power cord into a properly grounded electrical outlet.
7. Verify that the dc power LED and ac power LED on the power supply are lit, indicating that the power supply is operating correctly.

Replacing a hot-swap fan

The following notes describe information that you must consider when installing a hot-swap fan.

Attention: To ensure proper server operation, if a fan fails, replace it as soon as possible.

- Your server supports a maximum of eight hot-swap fans.
- The following illustration shows the location of the hot-swap fans.

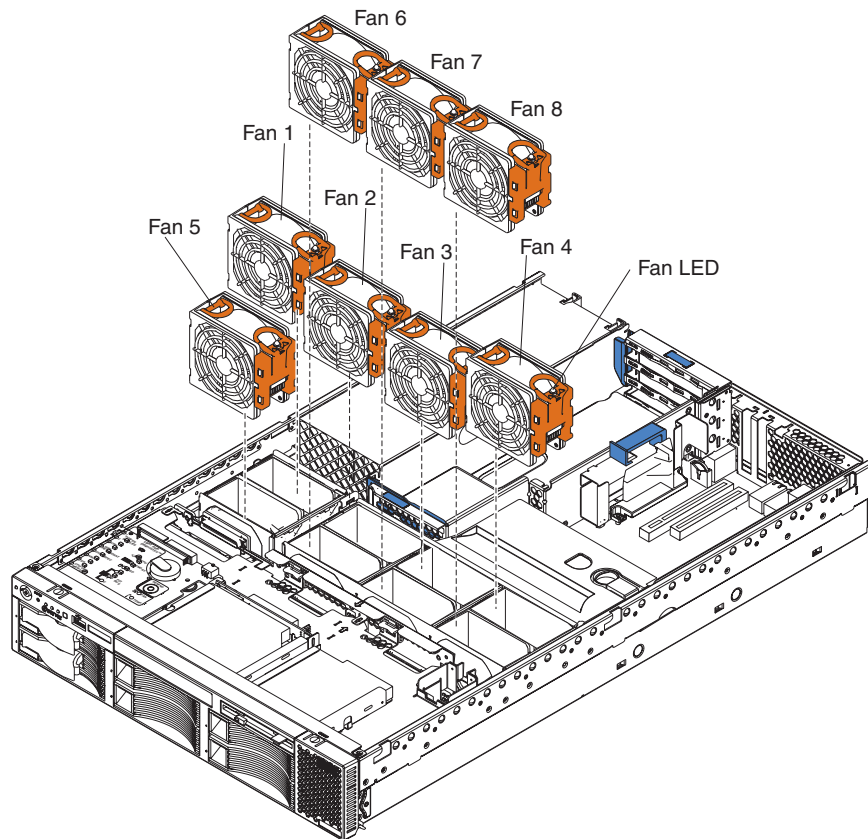

Complete the following steps to replace a hot-swap-fan:

1. Read the safety information beginning on page v, and “Installation guidelines” on page 11.
2. Remove the cover. See “Removing the cover and bezel” on page 15. The LED on the failing fan assembly will be lit.
Attention: To ensure proper system cooling, do not remove the top cover for more than 30 minutes during this procedure.
3. Place your fingers into the two handles on the top of the failing fan.
4. Press the handles and lift the fan out of the server.
5. Orient the new fan so the LED on top of the fan is to the right of the server.
6. Push the replacement fan assembly into the server until it clicks into place.
7. Replace the cover. See “Installing the server cover and bezel” on page 36.

Replacing the battery

The following notes describe information that you must consider when replacing the battery:

- IBM has designed this product with your safety in mind. The lithium battery must be handled correctly to avoid possible danger. If you replace the battery, you must adhere to the following instructions.

Note: In the U. S., call 1-800-IBM-4333 for information about battery disposal.

- If you replace the original lithium battery with a heavy-metal battery or a battery with heavy-metal components, be aware of the following environmental consideration. Batteries and accumulators that contain heavy metals must not be disposed of with normal domestic waste. They will be taken back free of charge by the manufacturer, distributor, or representative, to be recycled or disposed of in a proper manner.
- To order replacement batteries, call 1-800-772-2227 within the United States, and 1-800-465-7999 or 1-800-465-6666 within Canada. Outside the U.S. and Canada, call your IBM reseller or IBM marketing representative.

Note: After you replace the battery, you must reconfigure your server and reset the system date and time.

Statement 2



CAUTION:

When replacing the lithium battery, use only IBM Part Number 33F8354 or an equivalent type battery recommended by the manufacturer. If your system has a module containing a lithium battery, replace it only with the same module type made by the same manufacturer. The battery contains lithium and can explode if not properly used, handled, or disposed of.

Do not:

- Throw or immerse into water.
- Heat to more than 100° C (212° F)
- Repair or disassemble

Dispose of the battery as required by local ordinances or regulations.

Complete the following steps to replace the battery:

1. Read the safety information beginning on page v, and “Installation guidelines” on page 11.
2. Follow any special handling and installation instructions supplied with the battery.
3. Turn off the server and all attached devices and disconnect all power cords and external cables (see “Turning off the server” on page 13); then, remove the server cover (see “Removing the cover and bezel” on page 15).
4. Remove the adapters from PCI slots 1 and 2 (see “Working with adapters” on page 16).
5. Disconnect any internal cables, as necessary.

6. Locate the battery (connector BH1) on the system board.

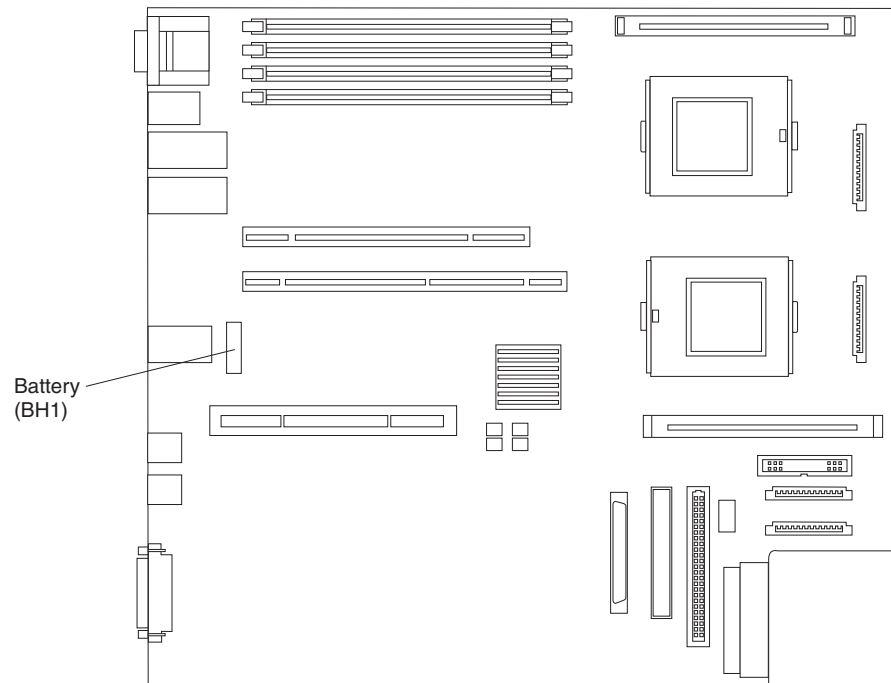

7. Remove the battery:
 - a. Use one finger to press the top of the battery clip away from the battery.
 - b. Lift and remove the battery from the socket.

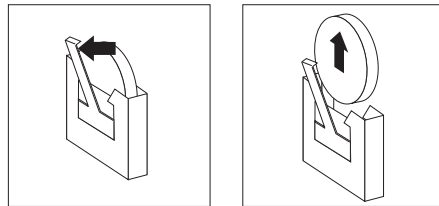

8. Insert the new battery:
 - a. Use one finger to press the top of the battery clip away from the battery.
 - b. Press the battery into the socket until it clicks into place. Make sure the battery clip holds the battery securely.

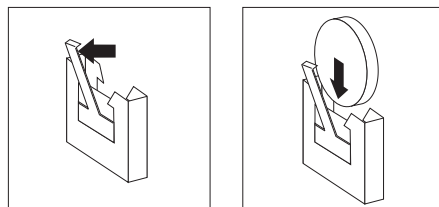

9. Reinstall the adapters that you removed, and reconnect the internal cables that you disconnected.
10. Connect all external cables and all power cords.
11. Reinstall the server cover (see "Installing the server cover and bezel" on page 36).

12. Start the Configuration/Setup Utility program and set configuration parameters as needed. See the *User's Guide* on the IBM xSeries Documentation CD for additional information about using the Configuration/Setup Utility program.

Completing the installation

To complete your installation, reinstall the bezel, reinstall the server cover, reconnect all cables that you disconnected earlier, and for certain options, run the Configuration/Setup Utility program. Follow the instructions in this section.

Attention:

- For proper cooling and airflow, replace the server cover before or shortly after turning on the server. Operating the server for extended periods of time (over 30 minutes) with the server cover removed might damage server components.
- To ensure proper server operation, do not remove the air-baffle assembly from the server except when installing or removing the components that are located under the air baffle.

Installing the server cover and bezel

The following illustration shows how to install the server cover and bezel.

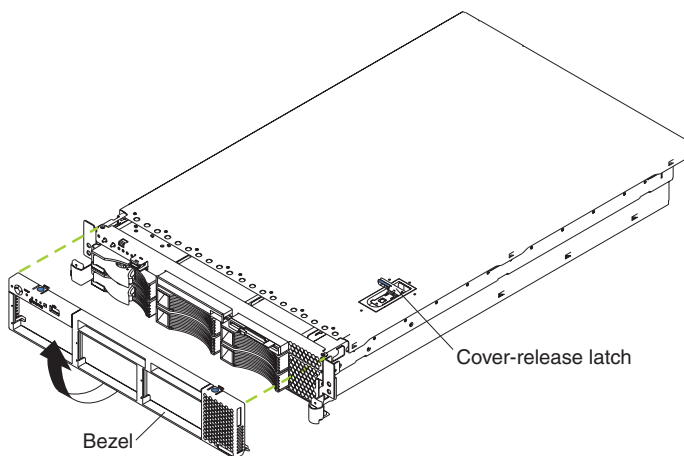

Complete the following steps to install the server cover:

1. Place the cover-release latch in the open (up) position.
2. Insert the bottom tabs of the top cover into the matching slots in the server chassis.
3. Press down on the cover-release latch to lock the cover in place.

Complete the following steps to install the bezel:

1. Align the hooks on the bottom of the bezel with the server.
2. Press the bezel toward the server until it clicks into place.

Installing the server in a rack

Detailed cabling instructions for a typical rack server configuration are in the *Rack Installation Instructions* that come with your server.

Updating your server configuration

When you start your server for the first time after you add or remove an internal option or an external SCSI device, you might see a message telling you that the

configuration has changed. The Configuration/Setup Utility program automatically starts so that you can save the new configuration information. See the *User's Guide* on the IBM *xSeries Documentation* CD for more information about the Configuration/Setup Utility program.

Some options have device drivers that you need to install. See the documentation that comes with your option for information about installing any required device drivers.

Your server comes with one or two microprocessors installed on the system board. If your server comes with two microprocessors or if your server comes with one microprocessor and you have installed an additional microprocessor, your server can now operate as an SMP server. Therefore, you might need to upgrade your operating system to support SMP. See the *User's Guide* on the IBM *xSeries Documentation* CD and your operating-system documentation for additional information.

If you have a RAID configuration on your server using the integrated SCSI controller or if your server has a RAID controller installed, and you have installed or removed a hard disk drive, you might need to reconfigure your disk arrays. See the RAID documentation on the IBM *xSeries Documentation* CD for information about reconfiguring your disk arrays.

To have SCSI capabilities if you remove the ServeRAID-5i controller or other RAID controller, start the Configuration/Setup Utility program and select **Devices and I/O Ports** from the main menu to enable the SCSI controller with RAID capabilities. See the *User's Guide* on the IBM *xSeries Documentation* CD for details about using the Configuration/Setup Utility program.

Connecting external options

If you install a SCSI adapter or use the external SCSI connector, you can attach external SCSI devices, such as a SCSI storage expansion enclosure, to your server. You can attach additional external options to the other input/output (I/O) connectors on the front and rear of your server. (See Chapter 3, "Input/output connectors", on page 39 for more information.)

Complete the following steps to attach an external device:

1. Read the safety information beginning on page v, and "Installation guidelines" on page 11. Also, read the documentation that comes with your options.
2. Turn off the server and all attached devices (see "Turning off the server" on page 13).
3. Follow the instructions that come with the option to prepare it for installation and to connect it to the server.

Note: If you are attaching an external SCSI device, see "Ultra320 SCSI controller system-board connectors" on page 41 for information about SCSI cabling and SCSI IDs.

Cabling the server

Notes:

1. You must turn off the server (see "Turning off the server" on page 13) before connecting any cables to or disconnecting any cables from the server.

2. See the documentation that comes with your options for additional cabling instructions. It might be easier for you to route cables before you install certain options.
3. Cable identifiers are printed on the cables that come with your server and options. Use these identifiers to connect the cables to the correct connectors.

The following illustrations show the locations of the input and output connectors on your server.

Rear view

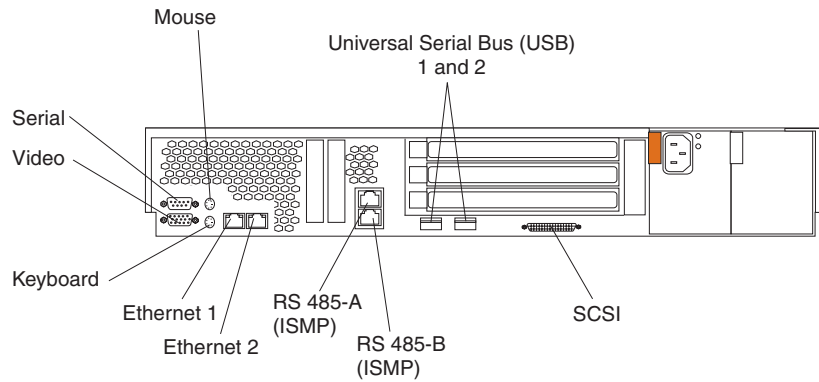

Front view

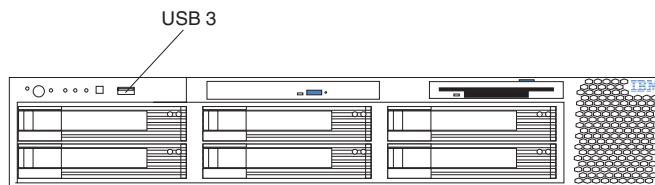

Chapter 3. Input/output connectors

Your server has the following input/output (I/O) connectors:

- One auxiliary-device (pointing device)
- Two Ethernet
- Two integrated system management (RS-485)
- One keyboard
- One serial
- One Ultra320 SCSI controller (LVD) SCSI
- Three Universal Serial Bus (USB) version 1.1 (USB 1 and USB 2 on the rear, USB 3 on the front)
- One video

The following illustrations show the locations of these connectors.

Rear view

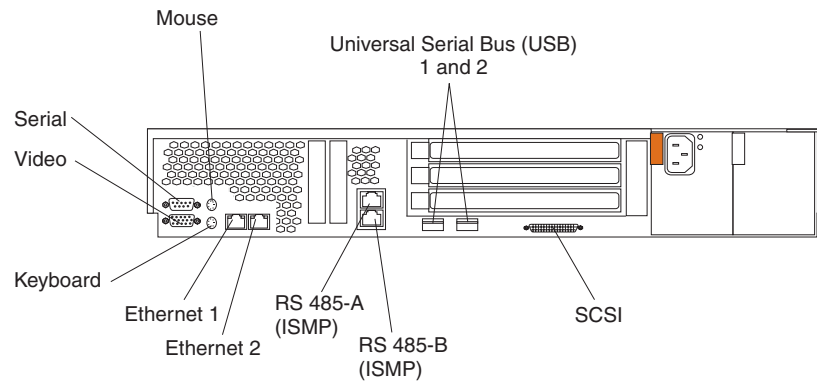

Front view

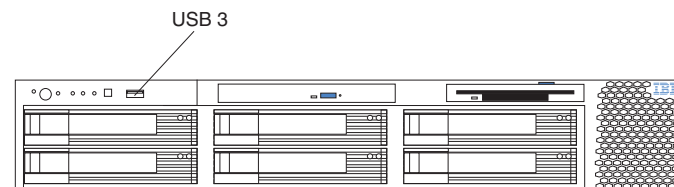

The following sections describe these connectors.

If you have an optional Remote Supervisor Adapter (system-management adapter) installed in PCI slot 5, your server also has an additional Ethernet connector, an additional serial connector, and an Advanced System Management (ASM) Interconnect connector. See the documentation that comes with the Remote Supervisor Adapter for more information about the ASM Interconnect network.

Auxiliary-device (pointing device) connector

Use this connector to connect a mouse or other pointing device. The following illustration shows an auxiliary-device connector.

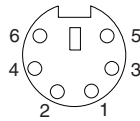

Ethernet connectors

The following illustration shows an Ethernet connector.

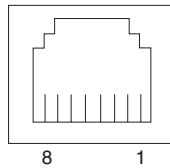

Connect a Category 3, 4, or 5 unshielded twisted-pair cable to this connector. 100BASE-TX and 1000BASE-T Fast Ethernet standards require Category 5 or higher cabling.

See the *User's Guide* on the *IBM xSeries Documentation* CD for more information about the Ethernet controller.

Integrated system management processor (ISMP) interconnect ports

The integrated system management processor (ISMP) ports (RS-485 A and B) use a dual RJ-45 connector to interconnect ISMPs of several servers through an optional Remote Supervisor Adapter.

Note: ISMP ports (RS-485 A and B) are used for the RS-485 interconnect network communications. These ports become inactive if you install an optional IBM Remote Supervisor Adapter in this server. If you install an optional IBM Remote Supervisor Adapter, you must use the RJ-45 connector on the adapter for interconnect network communications.

Keyboard connector

Use this connector to connect a PS/2 (non-USB) keyboard to the server. The following illustration shows a keyboard connector.

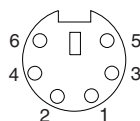

If you attach a keyboard to this connector, USB ports and devices are disabled during POST.

Serial connector

Use a serial connector to connect a serial device. The following illustration shows a serial connector.

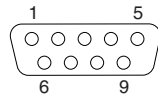

Ultra320 SCSI controller system-board connectors

The integrated dual channel small computer system interface (SCSI) controller with RAID capabilities supports two independent Ultra320 SCSI channels: one external and one internal. Each channel supports up to 15 SCSI devices. You can use the external LVD SCSI channel connector on the rear of your server to connect different types of SCSI devices, such as drives or printers. This controller uses:

- Double-transition clocking to achieve up to 320 MB-per-second data-transfer rates
- Domain name validation to negotiate compatible data-transfer speeds with each device
- Cyclic redundancy checking (CRC), instead of the usual parity checking, to improve data reliability
- An active terminator for SCSI bus termination

The server comes with one SCSI cable, which connects the internal connector on the system board to the standard hot-swap-drive backplane. If you plan to attach external SCSI devices, you must order additional cables. To select and order the correct cables for use with external devices, contact your IBM reseller or IBM marketing representative.

SCSI cabling requirements

For information about the maximum length of SCSI cable, go to the American National Standards Institute (ANSI) SCSI standards on the ANSI Web site at <http://www.ansi.org/> on the World Wide Web. Adhering to these standards will help to ensure that your server operates properly.

SCSI IDs

Each SCSI device that is connected to a SCSI controller must have a unique SCSI ID. This ID enables the SCSI controller to identify the device and ensure that different devices on the same SCSI channel do not attempt to transfer data simultaneously. SCSI devices that are connected to different SCSI channels can have duplicate SCSI IDs. Table 4 lists the SCSI IDs for the hard disk drives and backplanes that are connected to one channel.

Table 4. SCSI IDs for standard hot-swap hard disk drives, controller, and backplane

Device	SCSI ID
Drive bay 1	0
Drive bay 2	1
Drive bay 3	2
Drive bay 4	3
Drive bay 5	4
Drive bay 6	5

Table 4. SCSI IDs for standard hot-swap hard disk drives, controller, and backplane (continued)

Device	SCSI ID
Controller	7
Backplane	8

The hot-swap-drive backplane controls the SCSI IDs for the internal hot-swap drive bays. However, when you attach an external SCSI device to an optional SCSI adapter, you must set a unique ID for the device. See the information that comes with the device for instructions to set its SCSI ID.

SCSI connector

The following illustration shows a SCSI connector.

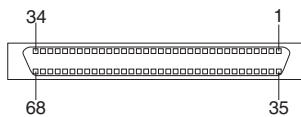

Universal Serial Bus version 1.1 connectors

Use a Universal Serial Bus (USB) connector to connect a USB device. USB technology transfers data at up to 12 Mb per second (Mbps) with a maximum of 127 devices and a maximum signal distance of 5 meters (16 ft) per segment. Using Plug and Play technology, USB devices are configured automatically. The following illustration shows a USB connector.

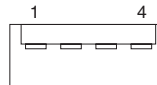

Use a 4-pin cable to connect a device to a USB connector. If you need to connect more USB devices than the server has USB connectors for, use a USB hub to connect additional devices.

If you connect a PS/2 (non-USB) keyboard to the keyboard connector, USB ports and devices are disabled during POST.

If you connect a USB keyboard that has a mouse port, the keyboard emulates a mouse, and you cannot disable the mouse settings in the Configuration/Setup Utility program.

Video connector

The integrated super video graphics array (SVGA) video controller is not removable, but you can disable it through the Configuration/Setup Utility program or by installing a PCI video adapter.

Note: If you install a PCI video adapter, the server BIOS will automatically disable the integrated video controller.

The following illustration shows a video connector.

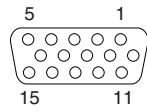

Appendix. Notices

This information was developed for products and services offered in the U.S.A.

IBM may not offer the products, services, or features discussed in this document in other countries. Consult your local IBM representative for information on the products and services currently available in your area. Any reference to an IBM product, program, or service is not intended to state or imply that only that IBM product, program, or service may be used. Any functionally equivalent product, program, or service that does not infringe any IBM intellectual property right may be used instead. However, it is the user's responsibility to evaluate and verify the operation of any non-IBM product, program, or service.

IBM may have patents or pending patent applications covering subject matter described in this document. The furnishing of this document does not give you any license to these patents. You can send license inquiries, in writing, to:

*IBM Director of Licensing
IBM Corporation
North Castle Drive
Armonk, NY 10504-1785
U.S.A.*

INTERNATIONAL BUSINESS MACHINES CORPORATION PROVIDES THIS PUBLICATION "AS IS" WITHOUT WARRANTY OF ANY KIND, EITHER EXPRESS OR IMPLIED, INCLUDING, BUT NOT LIMITED TO, THE IMPLIED WARRANTIES OF NON-INFRINGEMENT, MERCHANTABILITY OR FITNESS FOR A PARTICULAR PURPOSE. Some states do not allow disclaimer of express or implied warranties in certain transactions, therefore, this statement may not apply to you.

This information could include technical inaccuracies or typographical errors. Changes are periodically made to the information herein; these changes will be incorporated in new editions of the publication. IBM may make improvements and/or changes in the product(s) and/or the program(s) described in this publication at any time without notice.

Any references in this information to non-IBM Web sites are provided for convenience only and do not in any manner serve as an endorsement of those Web sites. The materials at those Web sites are not part of the materials for this IBM product, and use of those Web sites is at your own risk.

IBM may use or distribute any of the information you supply in any way it believes appropriate without incurring any obligation to you.

Edition notice

**© COPYRIGHT INTERNATIONAL BUSINESS MACHINES CORPORATION, 2003.
All rights reserved.**

Note to U.S. Government Users Restricted Rights — Use, duplication or disclosure restricted by GSA ADP Schedule Contract with IBM Corp.

Trademarks

The following terms are trademarks of International Business Machines Corporation in the United States, other countries, or both:

Active Memory	Predictive Failure Analysis
Active PCI	PS/2
Active PCI-X	ServeRAID
Alert on LAN	ServerGuide
C2T Interconnect	ServerProven
Chipkill	TechConnect
EtherJet	Tivoli
e-business logo	Tivoli Enterprise
@server	Update Connector
FlashCopy	Wake on LAN
IBM	XA-32
IntelliStation	XA-64
Light Path Diagnostics	X-Architecture
NetBAY	Xcel4
Netfinity	XpandOnDemand
NetView	xSeries
OS/2 WARP	

Lotus, Lotus Notes, SmartSuite, and Domino are trademarks of Lotus Development Corporation and/or IBM Corporation in the United States, other countries, or both.

ActionMedia, LANDesk, MMX, Pentium, ProShare, and Xeon are trademarks of Intel Corporation in the United States, other countries, or both.

Microsoft, Windows, and Windows NT are trademarks of Microsoft Corporation in the United States, other countries, or both.

UNIX is a registered trademark of The Open Group in the United States and other countries.

Java and all Java-based trademarks and logos are trademarks or registered trademarks of Sun Microsystems, Inc. in the United States, other countries, or both.

Linux is a registered trademark of Linus Torvalds.

Other company, product, or service names may be trademarks or service marks of others.

Important notes

Processor speeds indicate the internal clock speed of the microprocessor; other factors also affect application performance.

CD-ROM drive speeds list the variable read rate. Actual speeds vary and are often less than the maximum possible.

When referring to processor storage, real and virtual storage, or channel volume, KB stands for approximately 1000 bytes, MB stands for approximately 1 000 000 bytes, and GB stands for approximately 1 000 000 000 bytes.

When referring to hard disk drive capacity or communications volume, MB stands for 1 000 000 bytes, and GB stands for 1 000 000 000 bytes. Total user-accessible capacity may vary depending on operating environments.

Maximum internal hard disk drive capacities assume the replacement of any standard hard disk drives and population of all hard disk drive bays with the largest currently supported drives available from IBM.

Maximum memory may require replacement of the standard memory with an optional memory module.

IBM makes no representation or warranties regarding non-IBM products and services that are ServerProven[®], including but not limited to the implied warranties of merchantability and fitness for a particular purpose. These products are offered and warranted solely by third parties.

IBM makes no representations or warranties with respect to non-IBM products. Support (if any) for the non-IBM products is provided by the third party, not IBM.

Some software may differ from its retail version (if available), and may not include user manuals or all program functionality.

Product recycling and disposal

This unit contains materials such as circuit boards, cables, electromagnetic compatibility gaskets, and connectors which may contain lead and copper/beryllium alloys that require special handling and disposal at end of life. Before this unit is disposed of, these materials must be removed and recycled or discarded according to applicable regulations. IBM offers product-return programs in several countries. For country-specific instructions, refer to the following Web site:
<http://www.ibm.com/ibm/environment/products/prp.shtml>.

This product may contain a sealed lead acid, nickel cadmium, nickel metal hydride, lithium, or lithium ion battery. Consult your user manual or service manual for specific battery information. The battery must be recycled or disposed of properly. Recycling facilities may not be available in your area. For information on disposal of batteries, contact your local waste disposal facility.

In the United States, IBM has established a collection process for reuse, recycling, or proper disposal of used IBM sealed lead acid, nickel cadmium, nickel metal hydride, and battery packs from IBM equipment. For information on proper disposal of these batteries, contact IBM at 1-800-426-4333. Have the IBM part number listed on the battery available prior to your call.

Electronic emission notices

Federal Communications Commission (FCC) statement

Note: This equipment has been tested and found to comply with the limits for a Class A digital device, pursuant to Part 15 of the FCC Rules. These limits are designed to provide reasonable protection against harmful interference when the

equipment is operated in a commercial environment. This equipment generates, uses, and can radiate radio frequency energy and, if not installed and used in accordance with the instruction manual, may cause harmful interference to radio communications. Operation of this equipment in a residential area is likely to cause harmful interference, in which case the user will be required to correct the interference at his own expense.

Properly shielded and grounded cables and connectors must be used in order to meet FCC emission limits. Properly shielded and grounded cables and connectors must be used in order to meet FCC emission limits. IBM is not responsible for any radio or television interference caused by using other than recommended cables and connectors or by using other than recommended cables and connectors or by unauthorized changes or modifications to this equipment. Unauthorized changes or modifications could void the user's authority to operate the equipment.

This device complies with Part 15 of the FCC Rules. Operation is subject to the following two conditions: (1) this device may not cause harmful interference, and (2) this device must accept any interference received, including interference that may cause undesired operation.

Industry Canada Class A emission compliance statement

This Class A digital apparatus complies with Canadian ICES-003.

Avis de conformité à la réglementation d'Industrie Canada

Cet appareil numérique de la classe A est conforme à la norme NMB-003 du Canada.

Australia and New Zealand Class A statement

Attention: This is a Class A product. In a domestic environment this product may cause radio interference in which case the user may be required to take adequate measures.

United Kingdom telecommunications safety requirement

Notice to Customers

This apparatus is approved under approval number NS/G/1234/J/100003 for indirect connection to public telecommunication systems in the United Kingdom.

European Union EMC Directive conformance statement

This product is in conformity with the protection requirements of EU Council Directive 89/336/EEC on the approximation of the laws of the Member States relating to electromagnetic compatibility. IBM cannot accept responsibility for any failure to satisfy the protection requirements resulting from a nonrecommended modification of the product, including the fitting of non-IBM option cards.

This product has been tested and found to comply with the limits for Class A Information Technology Equipment according to CISPR 22/European Standard EN 55022. The limits for Class A equipment were derived for commercial and industrial environments to provide reasonable protection against interference with licensed communication equipment.

Attention: This is a Class A product. In a domestic environment this product may cause radio interference in which case the user may be required to take adequate measures.

Taiwanese Class A warning statement

警告使用者：
這是甲類的資訊產品，在居住的環境中使用時，可能會造成射頻干擾，在這種情形下，使用者會被要求採取某些適當的對策。

Chinese Class A warning statement

聲 明
此為 A 級產品。在生活環境中，該產品可能會造成無線電干擾。在這種情況下，可能需要用戶對其干擾採取切实可行的措施。

Japanese Voluntary Control Council for Interference (VCCI) statement

この装置は、情報処理装置等電波障害自主規制協議会（VCCI）の基準に基づきクラスA情報技術装置です。この装置を家庭環境で使用すると電波妨害を引き起こすことがあります。この場合には使用者が適切な対策を講ずるよう要求されることがあります。

Power cords

For your safety, IBM provides a power cord with a grounded attachment plug to use with this IBM product. To avoid electrical shock, always use the power cord and plug with a properly grounded outlet.

IBM power cords used in the United States and Canada are listed by Underwriter's Laboratories (UL) and certified by the Canadian Standards Association (CSA).

For units intended to be operated at 115 volts: Use a UL-listed and CSA-certified cord set consisting of a minimum 18 AWG, Type SVT or SJT, three-conductor cord, a maximum of 15 feet in length and a parallel blade, grounding-type attachment plug rated 15 amperes, 125 volts.

For units intended to be operated at 230 volts (U.S. use): Use a UL-listed and CSA-certified cord set consisting of a minimum 18 AWG, Type SVT or SJT,

three-conductor cord, a maximum of 15 feet in length and a tandem blade, grounding-type attachment plug rated 15 amperes, 250 volts.

For units intended to be operated at 230 volts (outside the U.S.): Use a cord set with a grounding-type attachment plug. The cord set should have the appropriate safety approvals for the country in which the equipment will be installed.

IBM power cords for a specific country or region are usually available only in that country or region.

IBM power cord part number	Used in these countries and regions
02K0546	China
13F9940	Australia, Fiji, Kiribati, Nauru, New Zealand, Papua New Guinea
13F9979	Afghanistan, Albania, Algeria, Andorra, Angola, Armenia, Austria, Azerbaijan, Belarus, Belgium, Benin, Bosnia and Herzegovina, Bulgaria, Burkina Faso, Burundi, Cambodia, Cameroon, Cape Verde, Central African Republic, Chad, Comoros, Congo (Democratic Republic of), Congo (Republic of), Cote D'Ivoire (Ivory Coast), Croatia (Republic of), Czech Republic, Dahomey, Djibouti, Egypt, Equatorial Guinea, Eritrea, Estonia, Ethiopia, Finland, France, French Guyana, French Polynesia, Germany, Greece, Guadeloupe, Guinea, Guinea Bissau, Hungary, Iceland, Indonesia, Iran, Kazakhstan, Kyrgyzstan, Laos (People's Democratic Republic of), Latvia, Lebanon, Lithuania, Luxembourg, Macedonia (former Yugoslav Republic of), Madagascar, Mali, Martinique, Mauritania, Mauritius, Mayotte, Moldova (Republic of), Monaco, Mongolia, Morocco, Mozambique, Netherlands, New Caledonia, Niger, Norway, Poland, Portugal, Reunion, Romania, Russian Federation, Rwanda, Sao Tome and Principe, Saudi Arabia, Senegal, Serbia, Slovakia, Slovenia (Republic of), Somalia, Spain, Suriname, Sweden, Syrian Arab Republic, Tajikistan, Tahiti, Togo, Tunisia, Turkey, Turkmenistan, Ukraine, Upper Volta, Uzbekistan, Vanuatu, Vietnam, Wallis and Futuna, Yugoslavia (Federal Republic of), Zaire
13F9997	Denmark
14F0015	Bangladesh, Lesotho, Maceo, Maldives, Namibia, Nepal, Pakistan, Samoa, South Africa, Sri Lanka, Swaziland, Uganda
14F0033	Abu Dhabi, Bahrain, Botswana, Brunei Darussalam, Channel Islands, China (Hong Kong S.A.R.), Cyprus, Dominica, Gambia, Ghana, Grenada, Iraq, Ireland, Jordan, Kenya, Kuwait, Liberia, Malawi, Malaysia, Malta, Myanmar (Burma), Nigeria, Oman, Polynesia, Qatar, Saint Kitts and Nevis, Saint Lucia, Saint Vincent and the Grenadines, Seychelles, Sierra Leone, Singapore, Sudan, Tanzania (United Republic of), Trinidad and Tobago, United Arab Emirates (Dubai), United Kingdom, Yemen, Zambia, Zimbabwe
14F0051	Liechtenstein, Switzerland
14F0069	Chile, Italy, Libyan Arab Jamahiriya
14F0087	Israel

IBM power cord part number	Used in these countries and regions
1838574	Antigua and Barbuda, Aruba, Bahamas, Barbados, Belize, Bermuda, Bolivia, Brazil, Caicos Islands, Canada, Cayman Islands, Costa Rica, Colombia, Cuba, Dominican Republic, Ecuador, El Salvador, Guam, Guatemala, Haiti, Honduras, Jamaica, Japan, Mexico, Micronesia (Federal States of), Netherlands Antilles, Nicaragua, Panama, Peru, Philippines, Taiwan, United States of America, Venezuela
24P6858	Korea (Democratic People's Republic of), Korea (Republic of)
34G0232	Japan
36L8880	Argentina, Paraguay, Uruguay
49P2078	India
49P2110	Brazil
6952300	Antigua and Barbuda, Aruba, Bahamas, Barbados, Belize, Bermuda, Bolivia, Caicos Islands, Canada, Cayman Islands, Colombia, Costa Rica, Cuba, Dominican Republic, Ecuador, El Salvador, Guam, Guatemala, Haiti, Honduras, Jamaica, Mexico, Micronesia (Federal States of), Netherlands Antilles, Nicaragua, Panama, Peru, Philippines, Saudi Arabia, Thailand, Taiwan, United States of America, Venezuela

Index

A

- adapter
 - boot option 16
 - considerations 16
 - installing
 - non-hot-plug 18
 - RAID 21
 - PCI bus, identification 16
 - retention bracket 3
 - support bracket 3
- Advanced System Management ports 40
- air-baffle assembly
 - illustration 3
- auxiliary-device port 40

B

- battery
 - connector 4
 - replacing 34
- bezel
 - installing 36

C

- cable
 - connectors 5, 6
 - routing 38
 - SCSI 41
- cabling
 - external 38, 41
 - system-board external connectors 6
 - system-board internal connectors 5
 - the server 38
- Class A electronic emission notice 47
- components
 - major 3
 - system board 4
- configuration
 - hardware, cabling for 36
 - updating 36
- connectors
 - adapter 4
 - battery 4
 - cable 5
 - Ethernet 40
 - external port 6
 - internal cable 5
 - memory 4
 - microprocessor 4
 - port 6
 - SCSI 41
 - system board 4
 - system-board switch block 7
 - Universal Serial Bus 42
 - VRM 4

D

- DIMM.
 - See memory module
- drive
 - hot-swap
 - installing 23
 - internal 22

E

- electrical safety information viii
- electronic emission Class A notice 47
- Ethernet connector 40
- external
 - cabling 38
 - devices, connecting 37

F

- fan, replacing 33
- FCC Class A notice 47
- filler panel
 - hard disk drive bay 23

H

- handling
 - static-sensitive devices 11
- hot-swap and hot-plug devices
 - drives 3, 23
 - fans 3, 33
 - power supplies 31
- hot-swap drive
 - installing 23
- hot-swap fan, replacing 33
- hot-swap power supply
 - installing 31
- hub 42

I

- installation order
 - memory modules 24
- installing
 - bezel 36
 - hot-swap drive 23
 - hot-swap fan 33
 - hot-swap power supply 31
 - memory module 23
 - microprocessor 26
 - non-hot-plug adapter 18
 - options 11
 - RAID adapter 21
 - VRM 29

K

keyboard port 40

L

LEDs

- CPU 10
- DASD 10
- FAN 10
- MEMORY 10
- NMI 10
- NONREDUNDANT 10
- PCI BUS 10
- POWER SUPPLY 1 10
- POWER SUPPLY 2 10
- SERVICE PROCESSOR BUS 10
- system board 9
- TEMPERATURE 10
- VRM 10

M

memory module

- installing 23
- order of installation 24
- supported 23

microprocessor

- heat sink 30
- installing 26
- VRM 29

N

notes, important 46

notices

- attention 2
- book 2
- caution 2
- danger 2
- electronic emission 47
- FCC, Class A 47
- important 2

O

options

- external
 - cabling requirements 41
 - connecting 37
 - installing 11
- order of installation
 - memory modules 24

P

PCI

- bus A 16
- bus B 16
- bus C 16

pointing device port 40

port

- Advanced System Management 40
- auxiliary-device 40
- connectors 6
- input/output 39
- keyboard 40
- parallel 42
- pointing device 40
- serial 41
- Universal Serial Bus 42

power cords 49

power supply

- installing 31
- operating requirements 31

power-on password override switch 8

R

rack, installing server in 36

related publications 1

replacing

- battery 34
- hot-swap fan 33

S

safety information

- electrical vi, viii
- laser vii
- lifting vii

SCSI

- adapter boot option 16
- cable
 - external devices 41
 - maximum length 41
- IDs 41

SCSI connector

- description 41
- location 5

SCSI controller 41

serial port 41

Standby mode 13

statements

- attention 2
- caution 2
- danger 2
- important 2

static electricity 11

static-sensitive devices

- handling 11

switch

- power-on password override 8

switch block 7

system board

- connectors
 - user-installable options 4
- LEDs 9
- switch block 7

system reliability 11

- system-board
 - connectors
 - external port 6
 - internal cable 5
 - SCSI 5, 41

T

- thermal material
 - heat sink 31
- trademarks 46
- turning off the server 13
- turning on the server 13

U

- United States electronic emission Class A notice 47
- United States FCC Class A notice 47
- Universal Serial Bus connector 42
- Universal Serial Bus port 42

V

- video port 42
- voltage regulator module
 - installing 29
- VRM
 - See voltage regulator module

W

- Web site
 - SCSI standards 41
- working inside server with power on 11



Part Number: 88P9190

Printed in U.S.A.

SC88-P919-00



(1P) P/N: 88P9190

