

IBM 48X/32X/48X/16X Max CD-RW/DVD-ROM
複合式光碟機



使用手冊

IBM 48X/32X/48X/16X Max CD-RW/DVD-ROM
複合式光碟機



使用手冊

註: 在使用本資訊及其支援的產品之前，請先閱讀在第 F-1 頁的附錄 F, 『IBM Statement of Limited Warranty - Z125-4753-07 - 11/2002』和 第 G-1 頁的附錄 G, 『Notices』中的資訊。

安全：請先閱讀

安裝本產品之前，請先看過「安全資訊」。

مج، يجب قراءة دات السلامة

Antes de instalar este produto, leia as Informações de Segurança.

在安裝本產品之前，請仔細閱讀 **Safety Information**
(安全信息)。

Prije instalacije ovog produkta obavezno pročitajte Sigurnosne Upute.

Před instalací tohoto produktu si přečtěte příručku bezpečnostních instrukcí.

Læs sikkerhedsforskrifterne, før du installerer dette produkt.

Ennen kuin asennat tämän tuotteen, lue turvaohjeet kohdasta Safety Information.

Avant d'installer ce produit, lisez les consignes de sécurité.

Vor der Installation dieses Produkts die Sicherheitshinweise lesen.

Πριν εγκαταστήσετε το προϊόν αυτό, διαβάστε τις πληροφορίες ασφάλειας
(safety information).

לפני שתתקינו מוצר זה, קראו את הוראות הבטיחות.

A termék telepítése előtt olvassa el a Biztonsági előírásokat!

Prima di installare questo prodotto, leggere le Informazioni sulla Sicurezza.

製品の設置の前に、安全情報をお読みください。

본 제품을 설치하기 전에 안전 정보를 읽으십시오.

Пред да се инсталира овој продукт, прочитајте информацијата за безбедност.

Lees voordat u dit product installeert eerst de veiligheidsvoorschriften.

Les sikkerhetsinformasjonen (Safety Information) før du installerer dette produktet.

Przed zainstalowaniem tego produktu, należy zapoznać się
z książką "Informacje dotyczące bezpieczeństwa" (Safety Information).

Antes de instalar este produto, leia as Informações sobre Segurança.

Перед установкой продукта прочтите инструкции по
технике безопасности.

Pred inštaláciou tohto zariadenia si pečítajte Bezpečnostné predpisy.

Pred namestitvijo tega proizvoda preberite Varnostne informacije.

Antes de instalar este producto lea la información de seguridad.

Läs säkerhetsinformationen innan du installerar den här produkten.

安裝本產品之前，請先閱讀「安全資訊」。

一般安全準則

請務必遵守下列預防措施以減少受傷及財產損壞的風險。

維修

請勿嘗試自己維修產品，除非 IBM 支援中心指示您這麼做。只將產品送至經核准修理您特定產品的 IBM 授權服務供應商。

註：客戶可以自行升級或更換部份零件。這些零件稱為客戶可更換裝置或 CRU。IBM 會明確指出這些 CRU，並在客戶更換這些零件時提供說明文件。您在執行這樣的更換時必須嚴格依照所有指示。在嘗試更換前，請務必確定電源已關閉，而且產品也切斷任何電源。如果您有任何問題或考量，請與 IBM 支援中心聯絡。

電源線和電源整流器

只使用產品製造廠商提供的電源線和電源整流器。

請勿將電源線繞在電源整流器或其他物品上。這麼做會導致電線磨損、斷裂或捲曲。這會帶來安全上的顧慮。

請勿將電源線佈置在容易被踩到、將人絆倒或被物品擠壓的地方。

避免電線及電源整流器碰觸到液體。例如，請勿將電源線或電源整流器留在靠近水槽、浴缸、廁所的地方或使用液體清潔劑清潔過的地板上。液體會引起短路，尤其是在不當使用而壓壞了電線或電源整流器的情況下。液體還會使電源線終端及/或整流器上的接頭終端逐漸腐蝕，最終導致過熱。

請務必按照正確的順序連接電源線及訊號線，並確保所有電源線接頭都安全並完全插入插座。

請勿使用交流電輸入接腳腐蝕及/或交流電輸入處或電源整流器上的任何地方有過熱跡象（如塑料變形）的任何電源整流器。

請勿使用任一端電氣接點有腐蝕或過熱跡象或電源線顯然已損壞的任何電源線。

延長線及相關裝置

經評估後，確定延長線、穩壓保護器、不斷電系統、以及所使用的多孔延長線可滿足本產品的耗電需求。使用上述裝置時，勿使耗電量超載。如果使用多孔延長線，負載

不應超過多孔延長線輸入額定功率。有關電源負載、電源需求及輸入額定功率的問題，請向電氣技術人員請教以獲得更多資訊。

插頭及插座

如果與電腦設備搭配使用的插座（電源插座）看起來損壞或腐蝕，請讓合格的電氣技術人員更換插座後再使用。

請勿彎曲或變更插頭。如果插頭損壞，請與製造廠商聯絡以取得更換品。

部份產品配有三相插頭。這類插頭只適合接地電源插座。這是安全特殊裝置。請勿嘗試將其插入非接地的插座中，會破壞此項安全特性。如果您無法將插頭插入插座，請與電氣技術人員聯絡，取得經認證的插座整流器，或將插座更換為可使用這類安全特殊裝置的插座。請勿使輸電插座超載。系統的總負載不能超過旁路比率的百分之八十。有關電源負載及旁路額定功率的問題，請向電氣技術人員請教以獲得更多資訊。

請確定您使用的電源插座適當接線、可方便存取且位置接近設備。請勿將電源線拉伸到處於受力的狀態。

小心地將設備從電源插座上插拔。

電池

所有 IBM 個人電腦都附有不可充電的硬幣狀電池，來為系統時鐘提供電源。此外，許多攜帶式產品（如 Thinkpad 筆記型電腦）在攜帶時是利用充電電池組提供系統電源。IBM 提供來與您的產品搭配使用的電池已經過相容性測試，僅應以 IBM 核准的零件更換。

切勿嘗試打開或維修任何電池。請勿壓碎、戳破或焚燒電池或使金屬接點短路。請勿讓電池接觸到水或其他液體。請務必嚴格遵照產品文件中所附的說明來對電池組充電。

電池過度使用或處理不當會導致電池過熱，可能造成電池組或硬幣電池「放出」氣體或火焰。如果您的電池已經受損，或您注意到電池有任何的漏溢情況，或電池極端出現雜質堆積，請停止使用電池，並向電池製造廠商購買新電池。

電池很久沒用時會降解。對於一些充電電池來說（尤其是鋰電池），電池在放電狀態下不使用會增加電池短路的危險，縮短電池的壽命，也具有安全上的顧慮。請勿讓充電鋰電池完全放電，或讓這些電池處於放電狀態。

熱能及產品通風

電腦在開啓和電池充電時會產生熱能。筆記型電腦由於體積較小，因此會產生相當多的熱能。請務必依照以下的基本預防措施：

- 當電腦正在運作或電池充電時，請勿長時間將電腦底座放在膝上或身體的任一部份。您的電腦在一般操作期間會產生一些熱能。長時間與身體接觸可能會引起不舒服或可能造成皮膚灼傷。
- 請勿在易燃物附近或易爆炸的環境下操作電腦或為電池充電。
- 為求安全、舒適和可靠操作，產品附有通風槽、風扇及/或散熱器。這些特殊裝置可能會由於產品放置在床、沙發、地毯或其他彈性表面上而無法發揮功能。切勿阻礙、遮蓋或停用這些特殊裝置。

CD 和 DVD 光碟機安全

CD 和 DVD 光碟機以高速旋轉光碟。如果 CD 或 DVD 有破裂或任何受損，使用 CD 光碟機時，光碟有可能會斷開甚至會破碎。爲了防止這種情況可能導致的損傷並減少機器損壞的危險，請執行下列步驟：

- 務必將 CD/DVD 光碟存放在原始包裝中
- 務必將 CD/DVD 光碟存放在遠離陽光直射及直接熱源處
- 不用時，請從電腦中取出 CD/DVD 光碟
- 勿彎曲或屈折 CD/DVD 光碟，或將它們強行放入電腦或其包裝中
- 在使用每片 CD/DVD 光碟前請檢查是否有破裂。請勿使用破裂或損壞的光碟

目錄

安全：請先閱讀	iii	關於 CD 與 DVD 映像檔	1-10
一般安全準則	iv	觀看 DVD 影片	1-10
維修	iv	DVD 區域碼	1-10
電源線和電源整流器	iv	保養與維護	1-11
延長線及相關裝置	iv	CD 安全資訊	1-11
插頭及插座	v	CD 或 DVD 的保養	1-11
電池	v	IBM 48X/32X/48X/16X Max CD-RW/DVD-ROM	
熱能及產品通風	v	複合式光碟機的保養	1-12
CD 和 DVD 光碟機安全	vi	手動退出光碟	1-12
關於本書	ix	附錄 A. 產品規格	A-1
註冊您的選用設備	ix	附錄 B. 問題解決	B-1
安裝及使用手冊	1-1	附錄 C. 自訂裝置驅動程式配置設定	C-1
產品說明	1-1	在 Windows Me 上啓用 DMA	C-1
軟體說明	1-1	在 Windows 2000 上啓用 DMA	C-1
安裝需求	1-2	在 Windows XP 上啓用 DMA	C-2
準備工作	1-2	附錄 D. 啓用數位音訊解壓縮	D-1
搬運及處理注意事項	1-2	附錄 E. 服務與支援	E-1
光碟機控制與接頭	1-2	線上技術支援	E-1
安裝光碟機	1-3	電話技術支援	E-1
步驟 1. 打開電腦	1-3	附錄 F. IBM Statement of Limited	
步驟 2. 打開光碟機的包裝	1-4	Warranty - Z125-4753-07 - 11/2002	F-1
步驟 3. 設定配置跳接器	1-4	Part 2 - Country-unique Terms	F-4
步驟 4. 選取 IDE 接頭	1-5	Part 3 - Warranty Information	F-16
步驟 5. 將光碟機安裝到機槽中	1-5	附錄 G. Notices	G-1
步驟 6. 將接線連接到光碟機	1-6	Federal Communications Commission (FCC) statement	G-1
步驟 7. 完成硬體安裝	1-6	Trademarks	G-4
步驟 8. 更新您的電腦配置	1-6	Electronic emission notices	G-4
步驟 9. 安裝 CD-RW 和 DVD 軟體	1-7	Federal Communications Commission (FCC)	
步驟 10. 設定您電腦的 DVD 影片播放	1-7	statement	G-4
步驟 11. 設定系統的 CD 播放	1-8		
使用 CD-R 和 CD-RW 光碟	1-8		
格式化光碟	1-9		
使用 RecordNow 軟體	1-10		
RecordNow 專案	1-10		
製作開機 CD 或 DVD	1-10		

關於本書

本手冊內有安裝和使用「IBM® 48X/32X/48X/16X Max CD-RW/DVD-ROM 複合式光碟機」相關的說明。本手冊分成以下幾個部份：

第 1 部份：安裝及使用手冊

本手冊以下列語言提供您產品說明以及安裝說明。

- 巴西葡萄牙文
- 捷克文
- 英文
- 法文
- 德文
- 義大利文
- 日文
- 簡體中文
- 斯洛代克
- 西班牙文
- 繁體中文
- 土耳其文

第 2 部份：附錄

本節中包含了有關裝置驅動程式、問題解決、保證和支援資訊，以及注意事項等的資訊。

註：手冊中的圖例可能會和您的硬體略有不同。

註冊您的選用設備

感謝您購買本 IBM 產品。請用一點時間為產品註冊，並提供一些相關資訊，這將幫助 IBM 在未來提供您更好的服務。您的回應在開發對您相當重要的產品和服務時會很有價值，並且能提供最佳的溝通管道。您可以在下列的 IBM 網站上註冊您的產品：

<http://www.ibm.com/pc/register>

除非您在網站上的問卷指出，您不想收到進一步的資訊，否則 IBM 會提供您所註冊的產品的資訊及更新。

安裝及使用手冊

本章節內有「IBM 48X/32X/48X/16X Max CD-RW/DVD-ROM 複合式光碟機」的產品說明、硬體與軟體安裝方法，以及操作的相關資訊。

產品說明

本產品內有一部多功能光碟機，可以讀寫 CD-R 和 CD-RW 光碟，並可讀取 CD-ROM、DVD-ROM、DVD-RW 和 DVD-R 光碟。本套產品另附有一片 CD，內容有適用於 Microsoft® Windows® 2000 Professional、Microsoft Windows Millennium Edition (Me)、Microsoft Windows XP Home 及 Microsoft Windows XP Professional 的線上使用手冊、DVD 播放軟體以及 CD 燒錄軟體。

本產品的配件有下列各項：

- 「IBM 48X/32X/48X/16X Max CD-RW/DVD-ROM 複合式光碟機」一部
- 有牙的四顆安裝螺絲 (M3 x 5-mm) 一袋
- 18 英寸長的 IDE 接線一條
- IBM CD-RW/DVD-ROM 複合式光碟機軟體及使用手冊光碟 一片
- 快速安裝手冊一份

上述物品若有遺漏或損壞時，請和原經銷商連絡。請務必保留本產品的購買證明資料；日後在要求售後保證服務時，可能會用到這些資料。請參閱第 F-1 頁的附錄 F，『IBM Statement of Limited Warranty - Z125-4753-07 - 11/2002』，以取得技術支援資訊。

本光碟機可以讀取多種 DVD 和 CD 格式，包括 DVD 影片、影音光碟以及音樂 CD 等格式。也可以寫入大部份的 CD-RW 可重覆寫入格式和 CD-R 可燒錄格式，包括高速 CD-R 媒體在內。您必須安裝隨附的 DVD 播放軟體，才能播放 DVD 視訊，而且也必須安裝隨附的光碟燒錄軟體，才能燒錄 CD-R 和 CD-RW 光碟。本光碟機也能讀取多階段作業、延伸架構 (CD-XA) 的光碟，以及 Kodak Photo CD。這部光碟機能以高達 48 倍標準 CD 光碟機速度 (48X)，傳輸 CD-ROM 和 CD-R 媒體上的資料。這部光碟機能以高達 16 倍標準 DVD 光碟機的速度 (16X)，傳輸 DVD 媒體上的資料。這部光碟機也可以讀取大部份的

DVD-RAM、DVD-RW 和 DVD-R 媒體類型，並且符合 DVD-Multi Player 相容性規格。在設計上，這部光碟機適用於使用 Integrated Drive Electronics (IDE) 或 Enhanced IDE (EIDE) 介面架構的個人電腦。

軟體說明

使用手冊與軟體光碟包含下列軟體：

- **IBM RecordNow**：利用 RecordNow，您可以利用各種方式錄製您自己的光碟。您可以使用 CD 對錄機功能備份光碟，或者將硬碟上的檔案製作資料光碟。您也可以將 MP3 檔案製作成音樂 CD，或複製其他的音樂 CD。RecordNow 也可以將光碟的映像檔儲存到硬碟，之後再將那些映像檔燒錄成光碟。您還可以利用 RecordNow，製作開機光碟。

- **IBM Drive Letter Access (DLA)**：使用 IBM Drive Letter Access (DLA)，讓您可以以磁碟代號存取 CD-RW 光碟機。您可以使用 Windows 指令行或拖放方法，將檔案複製到可錄製的媒體。
- **UDF Reader**：使用 UDF Reader 可以讀取在別台電腦上以 IBM Drive Letter Access (DLA) 寫入的光碟。

安裝需求

安裝光碟機之前，請先確定您的電腦是否符合下列系統需求：

- 微處理器最低需求：
 - Intel® Pentium® 133 MHz
 - Intel Pentium II 233 MHz（若要播放 DVD）
- RAM 最低需求：32 MB
- Windows 2000、Windows Me、Windows XP Home 或 Windows XP Professional 作業系統
- 半高式磁碟機機槽
- IDE 接頭
- 40 MB 的可用硬碟空間
- 若要執行 CD 複製功能，還需有 700 MB 可用的硬碟空間
- 具備可支援 44.1 或 48 kHz 取樣率的音訊解決方案
- 自行選購的立體聲喇叭
- 若要播放 DVD，需具備支援影像覆疊（Overlay Video）的 2 倍速 AGP 視訊功能

準備工作

在您安裝「IBM 48X/32X/48X/16X Max CD-RW/DVD-ROM 複合式光碟機」之前，應該先讀取本章節中有關搬運及處理注意事項與光碟機控制和接頭使用的相關資訊。

搬運及處理注意事項

下列搬運及處理注意事項可以保護光碟機：

- 請將「IBM 48X/32X/48X/16X Max CD-RW/DVD-ROM 複合式光碟機」放在防靜電袋中，等到準備要安裝時才取出。在安裝時動作不要太大，否則移動時容易產生靜電。
- 小心移動或搬運光碟機。掉落或搖動光碟機可能會損壞光碟機槽中的元件。
- 不要強行插入 IDE 或電源線。強行插入電源線的接頭，可能會傷及接頭或光碟機。

光碟機控制與接頭

下圖為光碟機控制與接頭的位置和功能。

光碟機正面:

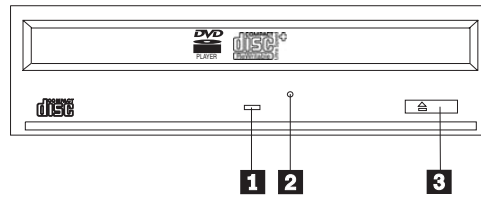

1 作業指示燈

這個指示燈會在光碟機讀取、寫入光碟時亮起。

2 緊急退出孔

這個退出孔提供退出機制，可以用來取出光碟機中的光碟。

3 開啓/關閉按鈕

只要按下這個按鈕就可以開啓或關閉光碟托盤。

光碟機後視圖

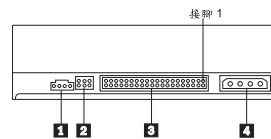

1 音訊輸出接頭

這個接頭會將類比音訊傳輸至音效配接卡。

2 配置接腳

您可以使用這些接腳用來設定光碟機的各种配置。

3 IDE 接頭

您可利用這個接頭，連接 CD-RW/DVD-ROM 複合式光碟機的 IDE 接線。

4 電源接頭

使用這個接頭來連接「IBM 48X/32X/48X/16X Max CD-RW/DVD-ROM 複合式光碟機」的電源線。

安裝光碟機

安裝 CD-RW/DVD-ROM 複合式光碟機時，請依照下列步驟：

步驟 1. 打開電腦

1. 請關閉電腦以及所有連接裝置的電源。
2. 拔掉電腦及其所有附屬裝置的電源線。
3. 卸下電腦的外殼。此一卸下外殼的步驟請參閱電腦說明文件中的說明和指示。

步驟 2. 打開光碟機的包裝

1. 在打開包裝光碟機的防靜電袋之前，請先將袋子和未上漆的金屬表面接觸至少二秒鐘。這樣可以釋放包裝以及您身上的靜電。
2. 從袋中取出光碟機。

如果您必須放下光碟機，請先將防靜電袋放置在平坦鋪平（例如雜誌）的表面，然後再將光碟機放置在防靜電袋上。

步驟 3. 設定配置跳接器

您可以按照所下圖標示的方式，將跳接器插在配置接腳上，將光碟機配置成「主要」(master) **1**、「從屬」(slave) **2** 或「電纜線選擇」(cable-select) **3**。

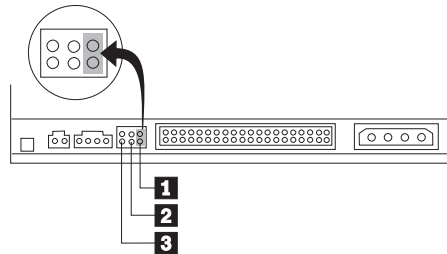

請使用下列的準則，來決定「IBM 48X/32X/48X/16X Max CD-RW/DVD-ROM 複合式光碟機」正確的設定。

- 如果「IBM 48X/32X/48X/16X Max CD-RW/DVD-ROM 複合式光碟機」是唯一連接到 IDE 接線的裝置時，請將它配置成「主要」(master)。這是預設的配置。
- 如果「IBM 48X/32X/48X/16X Max CD-RW/DVD-ROM 複合式光碟機」是 IDE 接線上第二個裝置時，請將它配置成「從屬」(slave)。請務必將其他裝置配置成「主要」(master)。在某些情況下，當同一條接線上的另一項裝置配置成「從屬」(slave) 時，硬碟機可能需要「主要/從屬並存」跳接器設定。如需在其他裝置上設定配置跳接器的相關資訊，請參閱您電腦所隨附的說明文件。
- 部份非 IBM 電腦，會使用在裝置接頭中具有兩條反向電線的特殊 ATA 接線，以便由接線（而非由跳接器）的位置來配置磁碟機。只有在配備這些特殊接線的電腦上，才能使用「電纜線選擇」(cable-select) 位置。請參閱電腦隨附的說明文件，來判定您的 ATA 配接卡，是否需要將跳接器插在「電纜線選擇」(cable-select) 位置上。

如果您將跳接器插在「電纜線選擇」(cable-select) 位置上，IDE 接線會依據磁碟機在接線上的位置，自動指定「主要」(master) 和「從屬」(slave) 設定。不論「IBM 48X/32X/48X/16X Max CD-RW/DVD-ROM 複合式光碟機」為連接到接線的唯一裝置，或是第二項裝置，對於此纜線安裝系統而言，您都必須使用「電纜線選擇」(cable-select) 設定。最靠近 IDE 控制器的磁碟機，會自動成為「主要」(master) 磁碟機。在 IDE 接線上任何其他的裝置，也必須設成「電纜線選擇」(cable-select)。

步驟 4. 選取 IDE 接頭

新型的電腦通常有兩個 IDE 接頭。如果您的電腦有兩個 IDE 接頭，請使用第二個 IDE 接頭來連接「IBM 48X/32X/48X/16X Max CD-RW/DVD-ROM 複合式光碟機」。通常，第二個 IDE 接頭會緊臨於連接硬碟機的主要 IDE 接頭的旁邊。您選取的 IDE 接頭和接線位置將會決定光碟機所用的配置接腳設定。

- 如果您有兩個 IDE 接頭，請使用光碟機所附的 IDE 接線，將「IBM 48X/32X/48X/16X Max CD-RW/DVD-ROM 複合式光碟機」連接到第二個 IDE 接頭上。如果「IBM 48X/32X/48X/16X Max CD-RW/DVD-ROM 複合式光碟機」是第二個 IDE 接頭上唯一的裝置，請使用「主要」(master) 配置設定。如果除了「IBM 48X/32X/48X/16X Max CD-RW/DVD-ROM 複合式光碟機」之外，在次要接頭上還有另外的裝置時，您將會使用「從屬」(slave) 配置設定。
- 如果將「CD-RW/DVD-ROM 複合式光碟機」和較快速的裝置（例如，硬碟機），連接到同一個 IDE 接頭上，對於「IBM 48X/32X/48X/16X Max CD-RW/DVD-ROM 複合式光碟機」請使用「從屬」(slave) 設定，而較快速的裝置，則使用「主要」(master) 設定。在某些情況下，當同一條接線上的另一項裝置配置成「從屬」(slave) 時，硬碟機可能需要「主要/從屬並存」設定。有關在其他裝置上設定配置接腳的進一步資訊，請參閱電腦或裝置所附的說明文件。
- 有些非 IBM 電腦支援「電纜線選擇」(cable-select) 設定，在接線上裝置的位置，可以決定該裝置為「主要」(master) 或「從屬」(slave) 的裝置。請參閱電腦附隨的說明文件，來判斷您的系統是否支援這種設定。

步驟 5. 將光碟機安裝到機槽中

警告： 將螺絲直接拴在光碟機上時，請務必要使用選用配件包內的安裝用螺絲。使用太長的螺絲可能會使光碟機受損。

您可以將「IBM 48X/32X/48X/16X Max CD-RW/DVD-ROM 複合式光碟機」以水平或直立的方式安裝到您的電腦中。如果要以垂直方式安裝光碟機，您必須在光碟托盤關閉之前，先將要放入光碟機中的光碟放妥，否則 CD-RW/DVD-ROM 複合式光碟機將無法正確讀取光碟資料。

1. 將光碟機推入機槽中；在您的電腦安裝儲存裝置時可能需要特殊的程序。請參閱電腦附隨的說明文件取得儲存裝置的相關資訊。
2. 將光碟機機槽螺絲孔對準光碟機槽或安裝框架上的螺紋孔。
3. 輕輕拴上螺絲檢查位置，通常每側必須拴上二個螺絲。確認已經對準後，再將螺絲拴緊。螺絲不可以拴得太緊。

步驟 6. 將接線連接到光碟機

下圖標示光碟機上連接導線的位置。

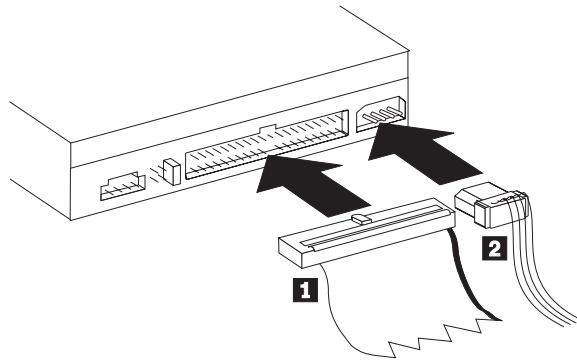

1. 將 40 接腳的 IDE 接線接頭 **1** 連接至光碟機的 IDE 接頭上。對齊電纜，從而使彩色碼邊與電源線接頭 **2** 最近。若 IDE 連接埠上沒有連接接線，或者電腦 IDE 連接埠上只有一個裝置接頭，或者您電腦上的現有電纜為 40 腳類型的低速接線，則請使用此選項附隨的高速 IDE 接線。IDE 接線最多可能會有三個接頭。如果只有一個裝置連到 IDE 接線，請將接頭的一端連到 IDE 接頭上，再將接線的另一端連到光碟機。請不要使用中間的接頭。

如果您必須使用該 IDE 接線來連接兩部裝置，請將排線的一端連接至 IDE 接頭上；然後將剩餘的兩個排線接頭分別連接至主要和次要的裝置上。在許多電腦中，會有兩條排線可讓您最多連接四部 ATA 的裝置；若要取得最佳的使用效能，請將第一部裝置（像是硬碟機）連接至主要 IDE 接頭上，然後將「IBM 48X/32X/48X/16X Max CD-RW/DVD-ROM 複合式光碟機」或是另一部慢速裝置（像是 CD 光碟機、磁帶機和可攜式媒體）連接至次要的 IDE 接頭上。

2. 將 4 接腳電源線 **2** 連到「IBM 48X/32X/48X/16X Max CD-RW/DVD-ROM 複合式光碟機」上的電源接頭。

請檢查確定所有的接線不會被裝回的電腦外殼夾到或擠壓，而且所有的訊號排線和電源線均已固定接好。

步驟 7. 完成硬體安裝

1. 請檢查確定「IBM 48X/32X/48X/16X Max CD-RW/DVD-ROM 複合式光碟機」已固定裝妥，而其所有的接頭也都穩固連接。
2. 確定接線不會妨礙電腦外殼，也不會擋住電源供應器的風扇葉片或通風路徑。
3. 重新裝回電腦外殼。
4. 重新連接所有外部裝置。
5. 將所有電源線插到電源插座上。

步驟 8. 更新您的電腦配置

在您完成硬體的安裝作業之後，請重新啓動您的電腦；通常，當您打開電腦的電源時，會顯示配置設定資訊畫面。如果您沒有看到這個畫面，請查閱您的電腦說明文件中，有關存取配置或安裝公用程式的資訊。

在大部份的 IBM 電腦中，如果要查看配置資訊，請在啓動期間，當螢幕右上角顯示 IBM 圖形時，按下 F1；當您檢視完相關的設定資訊之後，請儲存變更然後離開檢視畫面。

步驟 9. 安裝 CD-RW 和 DVD 軟體

如果要使用光碟機的 CD-RW 和 DVD 影片的功能，您必須安裝三項軟體應用程式。前述的應用程式都在 *IBM CD-RW/ DVD-ROM* 軟體及使用手冊光碟內。

在 *IBM CD-RW/DVD-ROM* 軟體及使用手冊光碟中，包含下列的軟體應用程式：

- Intervideo WinDVD，可以支援 DVD 影片播放
- IBM RecordNow，可以支援傳統光碟的編輯功能
- IBM Drive Letter Access (DLA)，可以支援拖放式光碟燒錄。
- UDF UDF Reader，可以讀取在其他電腦上以 IBM Drive Letter Access (DLA) 燒錄的光碟。

Windows XP 具有內建的拖放式支援。您的光碟機不需要其他軟體，便可執行這項作業。如果您安裝 DLA，作業系統內建的支援，便會由 DLA 功能所取代，但是可以從磁碟機代號上的內容功能表來啓用此項目。

若要安裝這三個應用程式，請執行下列步驟：

1. 將 *IBM CD-RW/DVD-ROM* 軟體及使用手冊光碟，插入到您的「IBM 48X/32X/48X/16X Max CD-RW/DVD-ROM 複合式光碟機」中。隨即會自動啓動您電腦中的瀏覽器程式。
2. 在瀏覽器中，請按一下 **RecordNow**，再按一下 **Drive Letter Access**，然後再按一下 **WinDVD**。
3. 重新啓動您的電腦。
4. 如果瀏覽器程式並未自動啓動，在安裝每個應用程式時，請開啓命令提示字元視窗並輸入以下指令；其中，e 代表「CD-RW/DVD 複合式光碟機」的磁碟機字母代號：
e:\launch.bat

步驟 10. 設定您電腦的 DVD 影片播放

本章節提供您啓用 DMA 設定的說明，以便您能使用「IBM 48X/32X/48X/16X Max CD-RW/DVD-ROM 複合式光碟機」播放 DVD 影片。

1. 以滑鼠右鍵按一下桌面上或「開始功能表」中的**我的電腦**。
2. 從蹦現功能表中，選取「內容」。
3. 請檢查您的作業系統，然後再依照第 C-1 頁的附錄 C，『自訂裝置驅動程式配置設定』中所提供的適當指示來啓用 DMA。
 - 如果您的作業系統為 Windows Me，請依照第 C-1 頁的『在 Windows Me 上啓用 DMA』中的指示。
 - 如果您的作業系統為 Windows 2000，請依照第 C-1 頁的『在 Windows 2000 上啓用 DMA』中的指示。
 - 如果您的作業系統為 Windows XP，請依照第 C-2 頁的『在 Windows XP 上啓用 DMA』中的指示。

步驟 11。設定系統的 CD 播放

若要在光碟機上播放音樂 CD，必須啓用數位播放。數位播放時，是以 IDE 資料傳輸線將音訊資料從光碟機傳輸到電腦，而非使用類比音訊傳輸線。這樣可以有更好的播放品質，但是爲了將數位資料轉換爲類比音效，電腦的負載會較高。要收聽 CD 音效，有兩部分要設定：設定光碟機與設定播放應用程式。

數位播放時的光碟機設定

若使用 Windows XP，則會自動將光碟機設定成數位播放。

若使用 Windows 2000 或 Windows Me，若要使用數位播放，需要另外設定您的電腦系統。請參照附錄 D 中關於如何啓用數位解壓縮的說明步驟。

數位播放時的應用程式設定

要在您的電腦系統收聽 CD 音效，還必須配合數位播放，另外設定 CD 播放應用程式。如果要使用 Windows Media Player 作爲播放應用程式，請依照附錄 D 中的說明，啓用 Windows Media Player 的數位播放功能。如果您使用其他廠商的 CD 播放器應用程式，請詳閱該應用程式的說明文件。

使用 CD-R 和 CD-RW 光碟

「IBM 48X/32X/48X/16X Max CD-RW/DVD-ROM 複合式光碟機」可以寫入 CD-R 和 CD-RW 光碟。CD-RW 光碟可以抹寫和重複使用許多次，而 CD-R 光碟只能寫入一次。



RecordNow 可以複製光碟、建立新的資料光碟，以及製作可供標準 CD-RW 光碟機，及光碟播放程式所讀取的音樂 CD。RecordNow 也可以建立 ISO9660 格式的光碟映像檔，並且將先前儲存的映像檔燒錄成光碟。

DLA 可用來製作檔案保存檔以及資料 CD，並且可以多次更改這些資料；它也具備了可以直接以磁碟代號存取的便利性。在使用 CD-RW 媒體時，DLA 和使用磁片來儲存檔案非常相似。如果將 DLA 和 CD-R 媒體一起使用，您可以持續寫入和覆寫資料，直到 CD 已滿爲止，寫入的資料都會以固定資料儲存在光碟上。使用 DLA 所建立的媒體只能用支援多重讀取模式的新型光碟機和 DVD 光碟機來讀取；

使用其它電腦來讀取關閉的 DLA 媒體時，可能需要 UDF 讀取器。在其他需要讀取此光碟的電腦系統上，安裝所提供的 UDF 讀取器，而不是在您的系統上。

CD-R 光碟可以使用音效光碟播放程式進行播放；而大部份的音效光碟播放程式無法播放 CD-RW 光碟。

CD-RW 媒體有四種不同的類型：多速、高速、極高速以及超高速。通常會將多速媒體指定爲 2X 或 2X-4X。「高速」媒體通常會被列示爲 4X-10X 或 4X-12X，並且帶有「高速」標誌。「極高速」媒體通常被列示爲 16X-24X，並且帶有「極高速」標誌。「超高速」媒體通常被列示爲 6X-32X，並且帶有「極高速」標誌。您的 CD-RW 可以寫入到所有四種 CD-RW 媒體類型。如果您使用「高速」、「極高速」或「超高速」CD-RW 媒體，配備低速 CD-RW 光碟機的電腦就不能將資料加入這個媒體。下表顯示，不同光碟機中不同媒體的相容性，以及在光碟機和媒體上的標誌。

	光碟機類型			
				
媒體類型：  2X - 4X 媒體	讀取 寫入	讀取 寫入	讀取 寫入	讀取 寫入
 4X - 12X 媒體	讀取	讀取 寫入	讀取 寫入	讀取 寫入
 16X - 24X 媒體	讀取	讀取	讀取 寫入	讀取 寫入
 16X - 32X 媒體	讀取	讀取	讀取	讀取 寫入

格式化光碟

如果要使用 DLA 拖放檔案，必須先將空白的 CD-R 或 CD-RW 光碟格式化。

如果要使用 DLA 程式來格式化 CD-R 或 CD-RW 光碟：

1. 請插入空白光碟。
2. 連按兩下**我的電腦**。
3. 在 **CD-RW** 圖示上按一下滑鼠的左鍵。
4. 按一下**格式化**。
5. 請在「磁碟機標籤」視窗中鍵入光碟的標題；光碟名稱的長度上限為 11 個字元。
6. 如果您想要使用 EasyWrite 在背景中執行格式化，請選取 **EasyWrite** 核取方塊。
7. 按一下**開始**即可開始格式化光碟；而在格式化作業完成後，請按一下**確定**。
8. 當「格式化完成」對話方塊顯示時，按一下**確定**。現在，您可以將資料寫入這片光碟中。

註：一般的格式化將會花費 4 到 45 分鐘，視該媒體的速度而定。EasyWrite 格式化將花費不到 2 分鐘，但是在退出光碟或是電腦關閉時，將會需要額外的時間。

註：在光碟進行格式化作業期間，您仍然可以在電腦上進行其他的工作。

使用 RecordNow 軟體

RecordNow 可讓您錄製 DVD、音效光碟、資料光碟，並可複製現有光碟。它可讓您將映像檔儲存在硬碟裡，並將先前建立的映像檔燒錄成光碟。RecordNow 說明檔裡有關於使用 RecordNow 的詳細資訊。您可以按下 RecordNow 功能表中的 F1，來存取 RecordNow 說明。

若要在 Windows Me 或 Windows 2000 中啟動 RecordNow，選取**開始** → **程式** → **IBM RecordNow**。

RecordNow 專案

一旦 RecordNow 啟動，要從三個標籤選擇一種，三種各有不同的功能。

Audio Project 可讓您建立音效光碟、MP3 Jukebox 光碟或收聽音效光碟或製作命名光碟標籤。

Data Project 可讓您製作資料光碟、完整的複製、抹寫可覆寫式光碟或命名 CD 或 DVD 標籤。

Backup Project 可讓您保存您的檔案，製作完整複製、儲存 CD 或 DVD 的映像檔、將所儲存的映像檔燒錄成光碟中或命名光碟標籤。

對所有可變更的光碟與 DVD 專案檔而言，只要選取了專案檔，RecordNow 可從光碟機裡的 CD 或 DVD 上的任何資料開始。

製作開機 CD 或 DVD

要製作開機 CD 或 DVD，開啓一個資料專案，並按下視窗的右上角的 bootable CD 按鈕。會提示您從硬碟裡選取一個開機映像檔或從軟碟製作一個開機映像檔。

關於 CD 與 DVD 映像檔

RecordNow 能夠儲存並建立 ISO 與 GI 的 CD 映像檔。ISO 映像檔僅適用於儲存僅具有一個資料階段作業的資料光碟。您必須使用 GI 格式來儲存音效光碟、DVD、多階段作業光碟以及混合類型光碟的映像檔。

觀看 DVD 影片

在您完成「IBM 48X/32X/48X/16X Max CD-RW/DVD-ROM 複合式光碟機」的安裝、DMA 的設定以及播放 DVD 影片的軟體之後，您就可以觀看 DVD 影片。

當您插入 DVD 時，WinDVD 便會自動啟動。如果您想要以手動來啟動 WinDVD，請依照下列指示：

1. 按一下**開始**，再按一下**程式集**，然後再按一下 **Intervideo WinDVD**。
2. 按一下 **Intervideo WinDVD**。

就會顯示 DVD 影片播放程式的視窗。如需有關如何使用「DVD 影片播放程式」的相關資訊，請按一下 F1 鍵來參閱 WinDVD 的線上說明。

DVD 區域碼

區域碼可以保護 DVD 的內容防止未經授權的盜錄行為；全世界已被區分成六個區域，而 MPEG-2 解碼軟體中則包含對應於光碟機使用區域的區域碼設定值。通常，每一片

DVD 會以區域碼進行燒錄生產，所以該 DVD 就只能在含有相同區域碼設定的 DVD 光碟機上讀取其中的資料。DVD 的區域碼設定可以由包裝背面所顯示的區域碼符號加以識別，下表即列出了這六大區域，以及其相對應的區域碼符號。

區域碼	區域
1	美國及加拿大
2	歐洲、中東、南美及日本
3	東南亞、臺灣及韓國
4	拉丁美洲、澳洲及紐西蘭
5	前蘇聯、非洲其他地區以及印度
6	中華人民共和國

程式會提示您進行區域的設定；如果您插入含有與初始區域碼不同區域碼的 DVD 時，WinDVD 便會問您是否要變更區域碼的設定。您最多可以變更區域碼的起始設定四次；當您變更起始區域碼達四次之後，則會固定在最後一個設定而無法再行變更。若要變更區域碼，您必須要使用含有新區域碼設定的 DVD。

若要顯示區域碼的狀態，請依照下列指示作業：

1. 在 WinDVD 視窗中，請按一下 **DVD Options**。
2. 按一下 **DVD Region**。

保養與維護

本章節提供您有關保養「IBM 48X/32X/48X/16X Max CD-RW/DVD-ROM 複合式光碟機」及搭配使用的 CD 與 DVD 光碟的相關資訊。

CD 安全資訊

小心處理和清潔光碟，特別是像 CD-R 和 CD-RW 光碟之類的可寫入媒體類型，這樣才能保持可讀性。您可以利用下列預防措施，來延長光碟的壽命。

- 務必將光碟存放在原本的包裝中
- 儲存光碟時，避免直接日曬。
- 總是讓光碟遠離直接的熱源。
- 不用時，請從電腦中取出光碟
- 在每次使用「之前」，檢查光碟是否有毀損
- 請勿將光碟強行塞進電腦/包裝中
- 請勿彎曲或折彎光碟

CD 或 DVD 的保養

數位光碟是一種高密度媒體，必須小心使用以及保持乾淨，以確保可以繼續讀取其中資料；以下是延長光碟壽命的預防措施。

警告： 如果您以圓形方式擦拭光碟，可能會損壞光碟而造成資料流失的情況。

- 只接觸光碟的邊緣以及中央小孔。請不要碰觸光碟的表面。
- 清除灰塵或指紋時，請以柔軟無纖維的布由中央向邊緣擦拭。
- 不可以在其表面上寫字。
- 不要將光碟直接放置在陽光下。

- 請不要使用市售的清潔劑清潔光碟。
- 不要彎曲光碟。

IBM 48X/32X/48X/16X Max CD-RW/DVD-ROM 複合式光碟機的保養

在操作期間，請採取下列預防措施，保護「IBM 48X/32X/48X/16X Max CD-RW/DVD-ROM 複合式光碟機」：

- 當機器在使用期間，請勿移動光碟機；如果發生這種情況，可能會造成資料錯誤、光碟機損壞或光碟。
- 不要讓光碟機曝露在下列環境：
 - 高濕度
 - 高溫
 - 過多灰塵
 - 機械性振動
 - 掉落或有突震
 - 放置於傾斜的表面上
 - 陽光直射
 - 溫度驟變
- 請勿將異物插入光碟機中。
- 不要在光碟機上堆放物件
- 請勿拆開光碟機的外殼嘗試自行維修。
- 在移動光碟機單元時，應該先取出光碟托盤中的光碟，並確定托盤已關閉至定位。
- 保留原來的包裝盒；如果您必須將光碟機單元搬運至另一個位置時，請使用原來的包裝盒包裝光碟機，以確保運輸過程中的安全。

手動退出光碟

如果停電而造成光碟機無法退出光碟時，請先關閉電腦，然後將一根迴紋針拉直作成退片的工具。拉直的一端長度至少要 45 公釐（1.8 英吋）。將拉直的一端，插入光碟機前方的緊急退出孔中（請參閱第 1-3 頁上的「光碟機正面」）。請推入迴紋針，直到托盤打開為止；輕輕拉出托盤，直到可以取出光碟為止。

附錄 A. 產品規格

本附錄中包含下列資訊：

- 實體規格
- 電源需求
- 環境需求
- 讀取速度
- 寫入速度

實體規格

32X/10X/40X/16 MAX CD-RW/DVD-ROM 複合式光碟機的實體規格¹下列表格列示
48X/32X/48X/16 Max CD-RW/DVD-ROM 複合式光碟機實體規格。

實體規格	
高度	41.3 公釐 (1.62 英吋)
寬度	146 公釐 (5.75 英吋)
長度	190 公釐 (7.48 英吋)
重量	900 克 (1.98 磅)

電源需求

下表是以供電電壓的多少，列出 48X/32X/48X/16 Max CD-RW/DVD-ROM 複合式光碟機的電源規格。電源規格，是以光碟機電源接頭位置測得之數據為準，並且是額定值。

電源規格	電壓	平均	最大
電壓位於	5V dc	700 mA	1300 mA
電壓位於	12V dc	650 mA	1300 mA

1. 產品說明資料詳述 IBM 的設計目標，並供比較之用；而實際的結果會因為許多因素而有所不同。本產品資料並不作為保證用途。其中的資料得隨時變更，而不另行通知。

環境需求

規格	操作中	非操作中
溫度 (非凝結時)	+5° C 到 +45° C (+41° F 到 +113° F)	-20° C 到 +60° C (-4° F 到 140° F)
相對濕度 (非凝結時)	10% 到 80%	5% 到 90%

讀取速度

媒體	持續資料傳輸速率
DVD 光碟機	(6.5x-16x CAV, 4.7 GB DVD 光碟機讀取) : 8.7 至 22.1 MB/s
DVD 光碟機	(3.3x-8x CAV, 8.5 GB 雙層讀取) : 4.4 至 11.0 MB/s
DVD-R	(2.5x-6x CAV, 4.7 GB DVD-R 讀取) : 3.3 至 8.1 MB/s
DVD+R	(2.5x-6x CAV, 4.7 GB DVD+R 讀取) : 3.3 至 8.1 MB/s
DVD-R	(2.5x-5x CAV, 3.95 GB DVD-R 讀取) : 3.3 至 6.7 MB/s
DVD-RAM	(2x CLV, 4.7 GB DVD-RAM 讀取) : 2.7 MB/s
DVD-RW	(2.5x-6x CAV, 4.7 GB DVD-RW 讀取) : 3.3 至 8.1 MB/s
DVD+RW	(2.5x-6x CAV, 4.7 GB DVD+RW 讀取) : 3.3 至 8.1 MB/s
CD 光碟機	(20x-48x CAV, CD-ROM 讀取) : 3.0 至 7.2 MB/s
CD-R	(20x-48x CAV, CD-R 讀取) : 3.0 至 7.2 MB/s
CD-RW	(18x-40x CAV, CD-RW 讀取) : 2.7 至 6.0 MB/s

最大叢發資料傳送速率：

- Ultra DMA 模式 2 : 33 MB/s

平均存取時間：

- DVD 光碟機 - 單層 : 120 ms (包括延遲時間)
- CD 光碟機 - 110 ms (包括延遲時間)
- RW - 110 ms (包括延遲時間)
- 2 MB 資料緩衝區

寫入速度

媒體	寫入速度
CD-R (48X)	3.0 至 7.2 MB/s CAV

媒體	寫入速度
CD-RW <ul style="list-style-type: none"> • 多速 (4X) • 高速 (10X) • 超速 (24X 最大) • 超速 + (32X 最大) 	<ul style="list-style-type: none"> • 0.6 MB/s CLV • 1.5 MB/s CLV • 2.4 to 3.6 MB/s PCAV • 3.0 to 4.8 MB/s PCAV

註: 垂直或水平方式裝載本光碟機皆可。

附錄 B. 問題解決

電腦的問題可能是由硬體、軟體或使用者錯誤所造成。只要利用本節中的資訊，您就可以自行解決問題，或是將收集到的相關資訊，傳給維修技術人員。您可能需要參考電腦、作業系統或音效配接卡的說明文件。

請詳閱下列各項說明，找出適用於您遭遇的問題說明。

- **電腦或 CD-RW/DVD-ROM 複合式光碟機無法正確地操作，或是作業指示燈不亮。**

請採取下列動作：

1. 請檢查在放入光碟時，標籤面是否向上。
2. 請檢查所有的裝置，是否已適當地連接到電腦和電源插座上。
3. 關閉電腦的電源，拔掉您電腦和所有連接裝置的接線，再取下電腦外殼。
4. 請檢查所有的電源和 IDE 接線，是否已連接妥當。請拔除 IDE 接線的連接，並檢查接腳是否彎曲或沒有對齊。如果您找不到任何問題，請重新連接排線。重新裝回電腦外殼，再重新連接所有的接線和電源線。開啓電腦的電源，重新啓動作業系統，再按下「開啓/關閉」按鈕來嘗試開啓托盤。如果托盤無法開啓，而且忙碌指示燈也沒有亮起時，請關閉電腦的電源，然後再試著使用另一條 4 接腳 DC 電源線。
5. 請檢查 IDE 接線上彩色編碼的邊緣，是否對齊 IDE 接頭上的接腳 1，並且是最靠近 CD-RW/DVD-ROM 複合式光碟機上的電源線。請參閱第 1-6 頁的『步驟 6. 將接線連接到光碟機』。
6. 請檢查 IDE 接線上的 CD-RW/DVD-ROM 複合式光碟機和任何其他裝置，其設定是否適當。
7. 如果 IDE 接線上的中間接頭連接到主機板上的 IDE 接頭時，請拔除此接頭，然後再重新連接這條接線。如果在 IDE 接頭上只有一項裝置，請將接線一端上的接頭連接到 IDE 接頭上，再將接線的另一端上的接頭連接到此裝置，讓中間接頭（如果有的話）仍可以使用。

如果在 IDE 接頭上有兩項裝置，請將接線一端上的接頭連接到 IDE 接頭上。如果有一部硬碟機時，請將它連接到接線另一端的接頭上，並且將 CD-RW/DVD-ROM 複合式光碟機連接到中間的接頭上。

- **您無法存取 CD-RW/DVD-ROM 複合式光碟機，或是 DVD-ROM (CD-ROM) 圖示並未顯示。**

當 CD-RW/DVD-ROM 複合式光碟機已適當地安裝之後，在「我的電腦」視窗中便會顯示一項 DVD-ROM 或 CD-ROM 圖示。請連按兩下**我的電腦**。如果在開啓視窗中並未顯示 CD-ROM 圖示，請檢查此光碟機是否已適當地安裝。請檢查配置跳接器是否適當地設定。再重新啓動您的電腦。如果光碟機圖示仍未顯示時，請繼續執行下列步驟：

1. 按一下**開始**，再按一下**設定**，然後再按一下**控制台**。
2. 按一下**系統**。
3. 按一下**裝置管理員**標籤。
4. 連按兩下**裝置 (按類型)**。

5. 從「裝置管理員」內所顯示的清單中，選取**硬碟控制卡**。請檢查控制卡是否有任何的衝突。裝置狀態會顯示控制卡是否適當地運作中。
6. 從「裝置管理員」內所顯示的清單中，選取 **CD-ROM**。請檢查清單中是否有 CD-ROM 裝置，而且沒有存在任何的衝突。裝置狀態會指示這項裝置是否適當地運作中。
7. 按一下**確定**。
8. 關閉所有的視窗，然後再重新啟動電腦。

如果裝置圖示仍未顯示，請檢查所有接線的連接和裝置跳接器設定，並排除已有的衝突。

- **作業系統無法辨識「IBM 48X/32X/48X/16X Max CD-RW/DVD-ROM 複合式光碟機」，或是本光碟機執行時不規律。**

某些電腦會具有針對使用於大量儲存裝置的「相容和高效能」模式。通常，「IBM 48X/32X/48X/16X Max CD-RW/DVD-ROM 複合式光碟機」在「高效能」模式下運作時，會有較好的效能。不過，如果您的光碟機在該模式無法適當地運作時，便可能需要使用「相容」模式。

請使用下列程序，來檢查您電腦的配置設定資訊。

1. 存取您的系統配置公用程式。在大部份的 IBM 電腦上，您可以在系統啟動時按下 F1 鍵。
2. 選取**裝置**。
3. 向下捲動到**大量儲存裝置**區段。

請參閱您電腦隨附的說明文件，以取得其他關於選取 IDE 效能模式的詳細資訊。

- **此光碟無法讀取。**

請採取下列動作：

1. 此光碟可能不乾淨；請利用第 1-11 頁的『CD 或 DVD 的保養』中所說明的方式來加以清潔。
2. 此光碟可能已毀損；請再試另一張光碟。
3. 此光碟並不相容於 ISO-9660、High Sierra Group (HSG) 或 Universal Disc Format (UDF)。請與您當初購買的店家聯絡。

- **這張光碟沒有聲音。**

1. 請檢查您所使用的是否為資料光碟。
2. 調整音效配接卡的音量控制。請參閱您音效配接卡和音樂 CD 播放程式隨附的說明文件。
3. 啟用數位音效，如 第 D-1 頁的附錄 D, 『啟用數位音訊解壓縮』。

- **當您在 Windows 2000 上使用 WinDVD 時，出現無法建立重疊視窗。**

1. 您的視訊裝置驅動程式需要更新，才能啟用重疊支援。請與您視訊配接卡或電腦的製造廠商聯絡，以取得更新項目。在 IBM CD-RW/DVD-ROM 軟體及使用手冊光碟上，已提供部份的裝置驅動程式。
2. 您螢幕的解析度可能太高。請試著將解析度設成 60 Hz 的 800 x 600 x 16 bpp。

- **DVD 影片在插入「IBM 48X/32X/48X/16X Max CD-RW/DVD-ROM 複合式光碟機」後，未自動播放。**

1. 「自動播放」已經關閉。請依照下列指示來開啓「自動播放」：

- a. 請按一下**開始**，然後按一下**控制台**，接著再按一下**裝置管理員**。
 - b. 請勾選**自動安插通知**。
2. 具有這些程式和 DVD 影片內容的 DVD，便會自動播放程式的內容。如果要檢視影片的內容，請以手動來啟動 WinDVD。如需其他關於手動啟動 WinDVD 的資訊，請參閱第 1-10 頁的『觀看 DVD 影片』。
- **影片看起來斷斷續續，或者是播放格中斷。**
 1. 請確定您電腦硬碟機控制卡已啟用 DMA。
 2. 您螢幕的解析度可能太高。將解析度設成 800 x 600 x 16 bpp，60 Hz。
 3. 如果您電腦的微處理器低於 Pentium II 450，在某些 DVD 上會有些許抖動的現象。
 - **於 Windows 2000 環境下，不重新啟動系統，就無法讀取 CD 媒體（資料或音訊）。**
 1. IBM Rapid Access II 鍵盤裝置驅動程式可能會干擾到光碟機的操作。
 - a. 從「控制台」中的「新增/移除程式」，移除 Rapid Access II 鍵盤裝置驅動程式。
 - b. 如果您使用 Rapid Access II 鍵盤，並想要還原其功能，請至 IBM 支援網站下載最新的裝置驅動程式（第 1007 版或更新的版本）。

附錄 C. 自訂裝置驅動程式配置設定

Windows Me 具有兩項裝置驅動程式配置參數：Auto Insert Notify 和 DMA。

Auto Insert Notify 參數可以在將光碟插入光碟機之後，讓電腦自動啟動播放或是存取這張光碟。

DMA 參數可以讓電腦 DMA 控制卡處理從 CD 到記憶體的資料傳輸，並釋放電腦微處理器來執行其他重要的作業，進而增進電腦的效能。例如，啟動 DMA 可以讓電影和遊戲在執行時更順暢，因為微處理器將會配置更多的處理時間給影片。

在 Windows Me 上啟用 DMA

如果要從 Windows Me 桌面上變更 DMA 參數設定時，請執行下列步驟：

1. 按一下**開始** --> **設定** --> **控制台**。
2. 按一下**檢視所有的控制台選項**。
3. 連按兩下**系統**。
4. 按一下**裝置管理員**標籤。
5. 連按兩下 **CD 光碟機**。
6. 按一下您想要修改的光碟機。
7. 按一下**設定**標籤。
8. 按下來選取 **DMA** 核取方塊。
9. 按一下**確定**。

在 Windows 2000 上啟用 DMA

如果要在 Windows 2000 上變更 DMA 參數設定時，請執行下列步驟：

1. 按一下**開始** --> **設定** --> **控制台**。
2. 連按兩下**系統**。
3. 按一下**硬體**標籤。
4. 按一下**裝置管理員**。
5. 按一下 **IDE ATA/ATAPI 控制器**展開樹狀結構。
6. 連按兩下對應到 CD-ROM 埠的裝置。本裝置為**主要 IDE 通道**或**次要 IDE 通道**。
7. 按一下**進階設定**標籤。
8. 按一下**轉送模式**功能表，再選取使用 **DMA**（如果可用的話）。
9. 按一下**確定**。
10. 按一下**關閉**來關閉「系統內容」視窗。這時便會顯示一則訊息，通知您系統設定已經變更。
11. 按一下**確定**，以重新啟動電腦。

在 Windows XP 上啓用 DMA

如果要從 Windows XP 桌面上變更 DMA 參數設定時，請執行下列步驟：

1. 按一下開始 --> 控制台。
2. 按一下切换到傳統檢視。
3. 連按兩下系統。
4. 按一下硬體標籤。
5. 按一下裝置管理員按鈕。
6. 按一下 **IDE ATA/ATAPI** 控制卡來展開樹狀結構。
7. 連按兩下對應到您 CD-RW 所在的控制卡（**主要 IDE** 或**次要 IDE**）。
8. 按一下進階設定標籤。
9. 選取對應到 CD-RW 位置的適當**轉送模式**下拉功能表，（**裝置 0** 適用於「主要」(Master)，而**裝置 1** 則適用於「從屬」(Slave)）。
10. 選取**使用 DMA**（如果可以用的話）。
11. 按一下**確定**。

附錄 D. 啓用數位音訊解壓縮

要適當地配置系統，才可以使用本光碟機播放數位音效。有兩項必須配置的設定。其中一項在「裝置內容」裡設定，另一項設定在 Windows Media Player 裡設定。

要設定裝置內容，請依照下列程序：

1. 以滑鼠右鍵按一下「我的電腦」，並選取「內容」。



2. 選取「硬體」標籤上的「裝置管理員」。在 Windows Me 中，無須按下此按鈕，直接顯示「裝置管理員」。

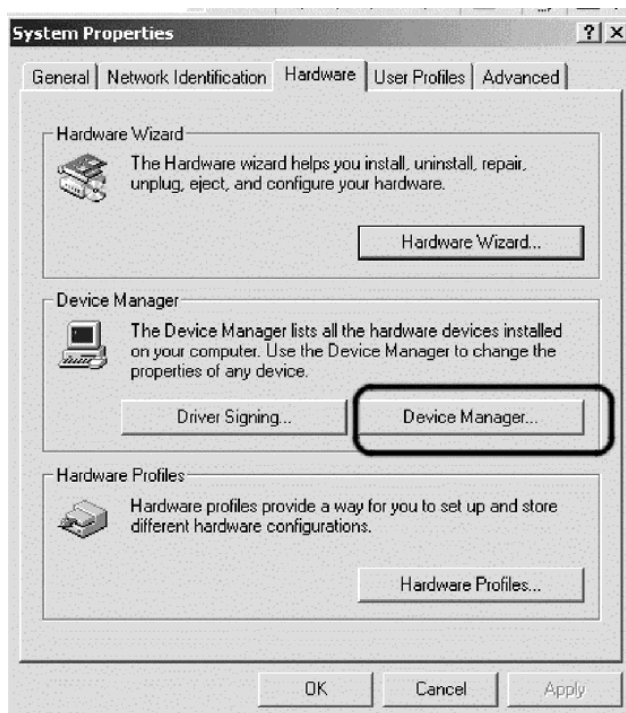

3. 在「裝置管理員」中，按一下 DVD/CD-ROM 光碟機前的 +，並選取「內容」。

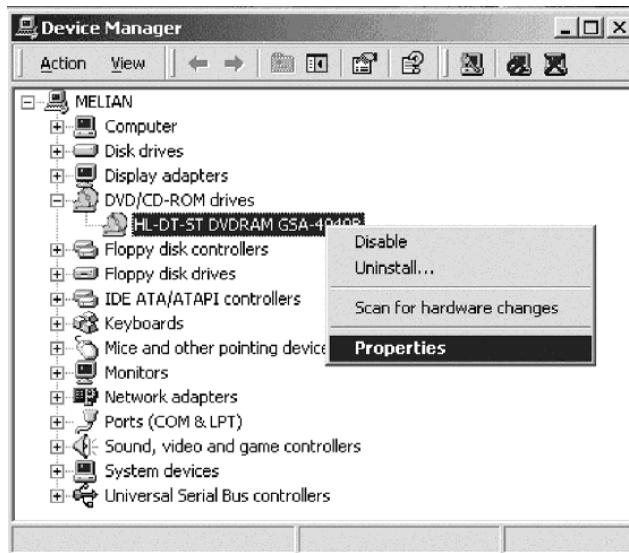

4. 選取「內容」標籤，並勾選「啓用數位音效」。

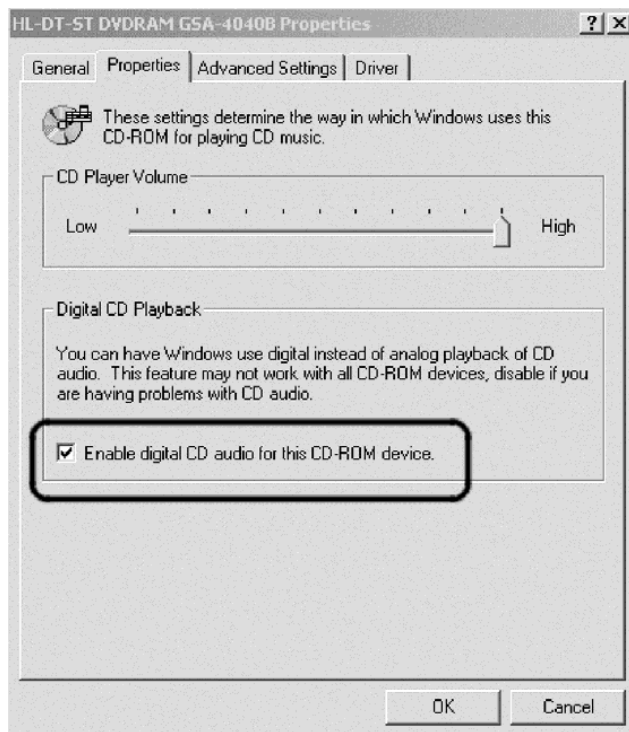

要啓用 Windows Media Player 中的「數位音效播放」，請執行以下步驟：

- a. 開啓 Windows Media Player。
- b. 從 Windows Media Player 功能表中選取工具 → 選項...
- c. 選取「CD 音效」標籤，並勾選「數位播放」方塊

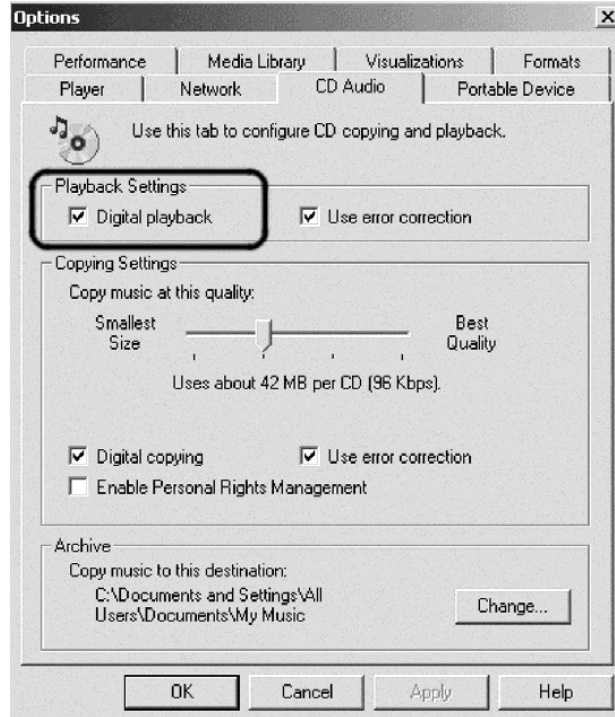

附錄 E. 服務與支援

下列資訊說明在保固期限或產品的使用壽命期間，您的產品可用的技術支援。參照完整解釋 IBM 保固條款之「IBM 限制保固聲明」。

線上技術支援

在產品的使用壽命期間，可以透過「個人電腦支援網站」使用線上技術支援：

www.ibm.com/pc/support

在保固期限內，可以更換或交換毀損的元件。此外，若 IBM 電腦上安裝有 IBM 選購配備，則可以在您所在地尋求服務。IBM 的技術支援人員會協助您決定最適合的處理方式。

電話技術支援

因 IBM 的各項考量，在該選購配備停止販售 90 天後，IBM HelpCenter® 或改採收費服務。其他方面的服務亦有提供，包括協助全程安裝，僅收取些許費用。

爲了讓技術支援人員儘快掌握狀況，請盡可能提供下列資訊：

- 選購配備的名稱
- 選購配備的序號
- 採購證明
- 電腦製造廠商、型號、序號（若爲 IBM 的電腦）以及手冊
- 若有出現錯誤訊息，請提供完整的錯誤訊息
- 向技術支援人員說明問題的狀況
- 您電腦系統硬體與軟體等的相關設定

若情況允許，請在您的電腦旁邊。IBM 的技術支援人員可能會直接用電話通話的方式，指導您排除問題。

各國的服務電話號碼與服務時間，請參照下表。若未列您所在國家或地區的號碼，請聯絡 IBM 經銷商或 IBM 業務代表。回覆的時間，會依所告知狀況的性質與數量而不同。

電話號碼會變更，而不另行通知。欲了解最新的電話號碼，請至 www.ibm.com/pc/support 點選 **Support phone list**。

國家或地區	電話號碼	國家或地區	電話號碼
阿根廷	0800-666-0011	馬來西亞	03-7727-7800
澳大利亞	1300-130-426	墨西哥	001-866-434-2080
奧地利	01-24592-5901	荷蘭	020-514-5770
比利時	荷蘭語 02-210-9820 法語 02-210-9800	紐西蘭	0800-446-149

國家或地區	電話號碼	國家或地區	電話號碼
玻利維亞	0800-0189	挪威	66 81 11 00
巴西	55-11-3889-8986	祕魯	0-800-50-866
加拿大	1-800-565-3344 Toronto 416-383-3344	菲律賓	632-995-2225
智利	800-224-488	葡萄牙	21-791 51 47
中國 (PRC)	800-810-1818	俄羅斯	095-940-2000
中國 (香港特別行政區)	852-2825-7799	新加坡	1800-840-9911
哥倫比亞	980-912-3021	Spain	91-662 49 16
丹麥	45 20 82 00	瑞典	08-477 4420
厄瓜多爾	1-800-426911 (語音選項 #4)	瑞士	058-333-09-00
芬蘭	09-459 69 60	臺灣	886-0800-000-700
法國	02 38 55 74 50	泰國	66-2-273-4000
德國	07032-1549 201	土耳其	00-800-446-32-041
印度尼西亞	021-523-8535	英國	0-1475-555 055
愛爾蘭	01-815-9202	美國	1-800-426-7378
義大利	02-7031-6101	烏拉圭	000-411-005-6649
日本	個人用戶 0120-887-870 企業用戶 0120-887-874	Venezuela	0-800-100-2011
盧森堡	298-977 5063	越南	848-8295-160

附錄 F. IBM Statement of Limited Warranty - Z125-4753-07 - 11/2002

Part 1 - General Terms

*This Statement of Limited Warranty includes Part 1 - General Terms, Part 2 - Country-unique Terms, and Part 3 - Warranty Information. The terms of Part 2 replace or modify those of Part 1. The warranties provided by IBM in this Statement of Limited Warranty apply only to Machines you purchase for your use, and not for resale. The term "Machine" means an IBM machine, its features, conversions, upgrades, elements, or accessories, or any combination of them. The term "Machine" does not include any software programs, whether pre-loaded with the Machine, installed subsequently or otherwise. **Nothing in this Statement of Limited Warranty affects any statutory rights of consumers that cannot be waived or limited by contract.***

What this Warranty Covers

IBM warrants that each Machine 1) is free from defects in materials and workmanship and 2) conforms to IBM's Official Published Specifications ("Specifications") which are available on request. The warranty period for the Machine starts on the original Date of Installation and is specified in Part 3 - Warranty Information. The date on your invoice or sales receipt is the Date of Installation unless IBM or your reseller informs you otherwise. Many features, conversions, or upgrades involve the removal of parts and their return to IBM. A part that replaces a removed part will assume the warranty service status of the removed part. Unless IBM specifies otherwise, these warranties apply only in the country or region in which you purchased the Machine.

THESE WARRANTIES ARE YOUR EXCLUSIVE WARRANTIES AND REPLACE ALL OTHER WARRANTIES OR CONDITIONS, EXPRESS OR IMPLIED, INCLUDING, BUT NOT LIMITED TO, THE IMPLIED WARRANTIES OR CONDITIONS OF MERCHANTABILITY AND FITNESS FOR A PARTICULAR PURPOSE. SOME STATES OR JURISDICTIONS DO NOT ALLOW THE EXCLUSION OF EXPRESS OR IMPLIED WARRANTIES, SO THE ABOVE EXCLUSION MAY NOT APPLY TO YOU. IN THAT EVENT, SUCH WARRANTIES ARE LIMITED IN DURATION TO THE WARRANTY PERIOD. NO WARRANTIES APPLY AFTER THAT PERIOD. SOME STATES OR JURISDICTIONS DO NOT ALLOW LIMITATIONS ON HOW LONG AN IMPLIED WARRANTY LASTS, SO THE ABOVE LIMITATION MAY NOT APPLY TO YOU.

What this Warranty Does not Cover

This warranty does not cover the following:

- any software programs, whether pre-loaded or shipped with the Machine, or installed subsequently;
- failure resulting from misuse (including but not limited to use of any Machine capacity or capability, other than that authorized by IBM in writing), accident, modification, unsuitable physical or operating environment, or improper maintenance by you;

- failure caused by a product for which IBM is not responsible; and
- any non-IBM products, including those that IBM may procure and provide with or integrate into an IBM Machine at your request.

The warranty is voided by removal or alteration of identification labels on the Machine or its parts.

IBM does not warrant uninterrupted or error-free operation of a Machine.

Any technical or other support provided for a Machine under warranty, such as assistance via telephone with "how-to" questions and those regarding Machine set-up and installation, is provided **WITHOUT WARRANTIES OF ANY KIND**.

How to Obtain Warranty Service

If the Machine does not function as warranted during the warranty period, contact IBM or your reseller to obtain warranty service. If you do not register the Machine with IBM, you may be required to present proof of purchase as evidence of your entitlement to warranty service.

What IBM Will Do to Correct Problems

When you call for service, you must follow the problem determination and resolution procedures that IBM specifies. A technician will attempt to make an initial diagnosis of your problem and help you resolve it over the telephone.

The type of warranty service applicable to your Machine is specified in Part 3 - Warranty Information.

You are responsible for downloading and installing designated Machine Code (microcode, basic input/output system code (called "BIOS"), utility programs, device drivers, and diagnostics delivered with an IBM Machine) and other software updates from an IBM Internet Web site or from other electronic media, and following the instructions that IBM provides.

If your problem can be resolved with a Customer Replaceable Unit ("CRU") (e.g., keyboard, mouse, speaker, memory, hard disk drive and other easily replaceable parts), IBM will ship these parts to you for replacement by you.

If the Machine does not function as warranted during the warranty period and your problem cannot be resolved over the telephone, through your application of Machine Code or software updates, or with a CRU, IBM or your reseller, if approved by IBM to provide warranty service, will either, at its discretion, 1) repair it to make it function as warranted, or 2) replace it with one that is at least functionally equivalent. If IBM is unable to do either, you may return the Machine to your place of purchase and your money will be refunded.

IBM or your reseller will also manage and install selected engineering changes that apply to the Machine.

Exchange of a Machine or Part

When the warranty service involves the exchange of a Machine or part, the item IBM or your reseller replaces becomes its property and the replacement becomes yours. You represent that all removed items are genuine and unaltered. The replacement may not be new, but will be in good working order and at least functionally equivalent to the item replaced. The replacement assumes the warranty service status of the replaced item.

Your Additional Responsibilities

Before IBM or your reseller exchanges a Machine or part, you agree to remove all features, parts, options, alterations, and attachments not under warranty service.

You also agree to:

1. ensure that the Machine is free of any legal obligations or restrictions that prevent its exchange;
2. obtain authorization from the owner to have IBM or your reseller service a Machine that you do not own; and
3. where applicable, before service is provided:
 - a. follow the service request procedures that IBM or your reseller provides;
 - b. backup or secure all programs, data, and funds contained in the Machine;
 - c. IBM or your reseller with sufficient, free, and safe access to your facilities to permit IBM to fulfill its obligations; and
 - d. inform IBM or your reseller of changes in the Machine's location.
4. (a) ensure all information about identified or identifiable individuals (Personal Data) is deleted from the Machine (to the extent technically possible), (b) allow IBM, your reseller or an IBM supplier to process on your behalf any remaining Personal Data as IBM or your reseller considers necessary to fulfill its obligations under this Statement of Limited Warranty (which may include shipping the Machine for such processing to other IBM service locations around the world), and (c) ensure that such processing complies with any laws applicable to such Personal Data.

Limitation of Liability

IBM is responsible for loss of, or damage to, your Machine only while it is 1) in IBM's possession or 2) in transit in those cases where IBM is responsible for the transportation charges.

Neither IBM nor your reseller are responsible for any of your confidential, proprietary or personal information contained in a Machine which you return to IBM for any reason. You should remove all such information from the Machine prior to its return.

Circumstances may arise where, because of a default on IBM's part or other liability, you are entitled to recover damages from IBM. In each such instance, regardless of the basis on which you are entitled to claim damages from IBM (including fundamental breach, negligence, misrepresentation, or other contract or tort claim), except for any liability that cannot be waived or limited by applicable laws, IBM is liable for no more than

1. damages for bodily injury (including death) and damage to real property and tangible personal property; and

2. the amount of any other actual direct damages, up to the charges (if recurring, 12 months' charges apply) for the Machine that is subject of the claim. For purposes of this item, the term "Machine" includes Machine Code and Licensed Internal Code ("LIC").

This limit also applies to IBM's suppliers and your reseller. It is the maximum for which IBM, its suppliers, and your reseller are collectively responsible.

UNDER NO CIRCUMSTANCES IS IBM, ITS SUPPLIERS OR RESELLERS LIABLE FOR ANY OF THE FOLLOWING EVEN IF INFORMED OF THEIR POSSIBILITY: 1) THIRD PARTY CLAIMS AGAINST YOU FOR DAMAGES (OTHER THAN THOSE UNDER THE FIRST ITEM LISTED ABOVE); 2) LOSS OF, OR DAMAGE TO, DATA; 3) SPECIAL, INCIDENTAL, OR INDIRECT DAMAGES OR FOR ANY ECONOMIC CONSEQUENTIAL DAMAGES; OR 4) LOST PROFITS, BUSINESS REVENUE, GOODWILL OR ANTICIPATED SAVINGS. SOME STATES OR JURISDICTIONS DO NOT ALLOW THE EXCLUSION OR LIMITATION OF INCIDENTAL OR CONSEQUENTIAL DAMAGES, SO THE ABOVE LIMITATION OR EXCLUSION MAY NOT APPLY TO YOU. SOME STATES OR JURISDICTIONS DO NOT ALLOW LIMITATIONS ON HOW LONG AN IMPLIED WARRANTY LASTS, SO THE ABOVE LIMITATION MAY NOT APPLY TO YOU.

Governing Law

Both you and IBM consent to the application of the laws of the country in which you acquired the Machine to govern, interpret, and enforce all of your and IBM's rights, duties, and obligations arising from, or relating in any manner to, the subject matter of this Statement of Limited Warranty, without regard to conflict of law principles.

THESE WARRANTIES GIVE YOU SPECIFIC LEGAL RIGHTS AND YOU MAY ALSO HAVE OTHER RIGHTS WHICH VARY FROM STATE TO STATE OR JURISDICTION TO JURISDICTION.

Jurisdiction

All of our rights, duties, and obligations are subject to the courts of the country in which you acquired the Machine.

Part 2 - Country-unique Terms

AMERICAS

ARGENTINA

Governing Law: *The following is added after the first sentence:*

Any litigation arising from this Statement of Limited Warranty will be settled exclusively by the Ordinary Commercial Court of the city of Buenos Aires.

BRAZIL

Governing Law: *The following is added after the first sentence:*

Any litigation arising from this Statement of Limited Warranty will be settled exclusively by the court of Rio de Janeiro, RJ.

Peru

Limitation of Liability: *The following is added at the end of this section:*

In accordance with Article 1328 of the Peruvian Civil Code the limitations and exclusions specified in this section will not apply to damages caused by IBM's willful misconduct ("dolo") or gross negligence ("culpa inexcusable").

NORTH AMERICA

How to Obtain Warranty Service: *The following is added to this Section:*

To obtain warranty service from IBM in Canada or the United States, call 1-800-IBM-SERV (426-7378).

CANADA

Limitation of Liability: *The following replaces item 1 of this section:*

1. damages for bodily injury (including death) or physical harm to real property and tangible personal property caused by IBM's negligence; and

Governing Law: *The following replaces 『laws of the country in which you acquired the Machine』 in the first sentence:*
laws in the Province of Ontario.

UNITED STATES

Governing Law: *The following replaces 『laws of the country in which you acquired the Machine』 in the first sentence:*
laws of the State of New York.

ASIA PACIFIC

AUSTRALIA

What this Warranty Covers: *The following paragraph is added to this Section:*

The warranties specified in this Section are in addition to any rights you may have under the Trade Practices Act 1974 or other similar legislation and are only limited to the extent permitted by the applicable legislation.

Limitation of Liability: *The following is added to this Section:*

Where IBM is in breach of a condition or warranty implied by the Trade Practices Act 1974 or other similar legislation, IBM's liability is limited to the repair or replacement of the goods or the supply of equivalent goods. Where that condition or warranty relates to right to sell, quiet possession or clear title, or the goods are of a kind ordinarily acquired for personal, domestic or household use or consumption, then none of the limitations in this paragraph apply.

Governing Law: *The following replaces 『laws of the country in which you acquired the Machine』 in the first sentence:*
laws of the State or Territory.

CAMBODIA, LAOS, AND VIETNAM

Governing Law: *The following replaces 『laws of the country in which you acquired the Machine』 in the first sentence:*
laws of the State of New York, United States of America.

CAMBODIA, INDONESIA, LAOS, AND VIETNAM

Arbitration: The following is added under this heading:

Disputes arising out of or in connection with this Statement of Limited Warranty shall be finally settled by arbitration which shall be held in Singapore in accordance with the Arbitration Rules of Singapore International Arbitration Center ("SIAC Rules") then in effect. The arbitration award shall be final and binding for the parties without appeal and shall be in writing and set forth the findings of fact and the conclusions of law.

The number of arbitrators shall be three, with each side to the dispute being entitled to appoint one arbitrator. The two arbitrators appointed by the parties shall appoint a third arbitrator who shall act as chairman of the proceedings. Vacancies in the post of chairman shall be filled by the president of the SIAC. Other vacancies shall be filled by the respective nominating party. Proceedings shall continue from the stage they were at when the vacancy occurred.

If one of the parties refuses or otherwise fails to appoint an arbitrator within 30 days of the date the other party appoints its, the first appointed arbitrator shall be the sole arbitrator, provided that the arbitrator was validly and properly appointed.

All proceedings shall be conducted, including all documents presented in such proceedings, in the English language. The English language version of this Statement of Limited Warranty prevails over any other language version.

HONG KONG S.A.R. OF CHINA AND MACAU S.A.R. OF CHINA

Governing Law: *The following replaces 『laws of the country in which you acquired the Machine』 in the first sentence:*
laws of Hong Kong Special Administrative Region of China.

INDIA

Limitation of Liability: *The following replaces items 1 and 2 of this Section:*

1. liability for bodily injury (including death) or damage to real property and tangible personal property will be limited to that caused by IBM's negligence; and
2. as to any other actual damage arising in any situation involving nonperformance by IBM pursuant to, or in any way related to the subject of this Statement of Limited Warranty, , the charge paid by you for the individual Machine that is the subject of the claim. For purposes of this item, the term "Machine" includes Machine Code and Licensed Internal Code ("LIC").

Arbitration: *The following is added under this heading :*

Disputes arising out of or in connection with this Statement of Limited Warranty shall be finally settled by arbitration which shall be held in Bangalore, India in accordance with the laws of India then in effect. The arbitration award shall be final and binding for the parties without appeal and shall be in writing and set forth the findings of fact and the conclusions of law.

The number of arbitrators shall be three, with each side to the dispute being entitled to appoint one arbitrator. The two arbitrators appointed by the parties shall appoint a third arbitrator who shall act as chairman of the proceedings. Vacancies in the post of chairman shall be filled by the president of the Bar Council of India. Other vacancies shall be filled by the respective nominating party. Proceedings shall continue from the stage they were at when the vacancy occurred.

If one of the parties refuses or otherwise fails to appoint an arbitrator within 30 days of the date the other party appoints its, the first appointed arbitrator shall be the sole arbitrator, provided that the arbitrator was validly and properly appointed.

All proceedings shall be conducted, including all documents presented in such proceedings, in the English language. The English language version of this Statement of Limited Warranty prevails over any other language version.

JAPAN

Governing Law: *The following sentence is added to this section:*

Any doubts concerning this Statement of Limited Warranty will be initially resolved between us in good faith and in accordance with the principle of mutual trust.

MALAYSIA

Limitation of Liability: *The word "SPECIAL" in item 3 of the fifth paragraph is deleted.*

NEW ZEALAND

What this Warranty Covers: *The following paragraph is added to this section:*

The warranties specified in this section are in addition to any rights you may have under the Consumer Guarantees Act 1993 or other legislation which cannot be excluded or limited. The Consumer Guarantees Act 1993 will not apply in respect of any goods which IBM provides, if you require the goods for the purposes of a business as defined in that Act.

Limitation of Liability: *The following is added to this section:*

Where Machines are not acquired for the purposes of a business as defined in the Consumer Guarantees Act 1993, the limitations in this section are subject to the limitations in that Act.

PEOPLE'S REPUBLIC OF CHINA (PRC)

Governing Law: *The following replaces "laws of the country in which you acquired the Machine" in the first sentence:*

laws of the State of New York, United States of America (except when local law requires otherwise).

PHILIPPINES

Limitation of Liability: *Item 3 in the fifth paragraph is replaced by the following:*

SPECIAL (INCLUDING NOMINAL AND EXEMPLARY DAMAGES), MORAL, INCIDENTAL, OR INDIRECT DAMAGES FOR ANY ECONOMIC CONSEQUENTIAL DAMAGES; OR

Arbitration: The following is added under this heading

Disputes arising out of or in connection with this Statement of Limited Warranty shall be finally settled by arbitration which shall be held in Metro Manila, Philippines in accordance with the laws of the Philippines then in effect. The arbitration award shall be final and binding for the parties without appeal and shall be in writing and set forth the findings of fact and the conclusions of law.

The number of arbitrators shall be three, with each side to the dispute being entitled to appoint one arbitrator. The two arbitrators appointed by the parties shall appoint a third arbitrator who shall act as chairman of the proceedings. Vacancies in the post of chairman shall be filled by the president of the Philippine Dispute Resolution Center, Inc.. Other vacancies shall be filled by the respective nominating party. Proceedings shall continue from the stage they were at when the vacancy occurred.

If one of the parties refuses or otherwise fails to appoint an arbitrator within 30 days of the date the other party appoints its, the first appointed arbitrator shall be the sole arbitrator, provided that the arbitrator was validly and properly appointed.

All proceedings shall be conducted, including all documents presented in such proceedings, in the English language. The English language version of this Statement of Limited Warranty prevails over any other language version.

SINGAPORE

Limitation of Liability: The words "**SPECIAL**" and "**ECONOMIC**" in item 3 in the fifth paragraph are deleted.

EUROPE, MIDDLE EAST, AFRICA (EMEA)

THE FOLLOWING TERMS APPLY TO ALL EMEA COUNTRIES:

The terms of this Statement of Limited Warranty apply to Machines purchased from IBM or an IBM reseller.

How to Obtain Warranty Service: If you purchase a Machine in Austria, Belgium, Cyprus, Denmark, Estonia, Finland, France, Germany, Greece, Iceland, Ireland, Italy, Latvia, Liechtenstein, Lithuania, Luxembourg, Monaco, Netherlands, Norway, Portugal, Spain, San Marino, Sweden, Switzerland, United Kingdom or Vatican State, you may obtain warranty service for that Machine in any of those countries from either (1) an IBM reseller approved to perform warranty service or (2) from IBM, provided the Machine has been announced and made available by IBM in the country in which you wish to obtain service. If you

purchased a Personal Computer Machine in Albania, Armenia, Belarus, Bosnia and Herzegovina, Bulgaria, Croatia, Czech Republic, Georgia, Hungary, Kazakhstan, Kyrgyzstan, Federal Republic of Yugoslavia, Former Yugoslav Republic of Macedonia (FYROM), Moldova, Poland, Romania, Russia, Slovak Republic, Slovenia, or Ukraine, you may obtain warranty service for that Machine in any of those countries from either (1) an IBM reseller approved to perform warranty service or (2) from IBM.

If you purchase a Machine in a Middle Eastern or African country, you may obtain warranty service for that Machine from the IBM entity within the country of purchase, if that IBM entity provides warranty service in that country, or from an IBM reseller, approved by IBM to perform warranty service on that Machine in that country. Warranty service in Africa is available within 50 kilometers of an IBM approved service provider. You are responsible for transportation costs for Machines located outside 50 kilometers of an IBM approved service provider.

*Add the following paragraph in **Western Europe** (Austria, Belgium, Cyprus, Denmark, Finland, France, Germany, Greece, Iceland, Ireland, Italy, Liechtenstein, Luxembourg, Monaco, Netherlands, Norway, Portugal, Spain, San Marino, Sweden, Switzerland, United Kingdom, Vatican State):*

The warranty for Machines acquired in Western Europe shall be valid and applicable in all Western Europe countries provided the Machines have been announced and made available in such countries.

Governing Law:

The phrase "the laws of the country in which you acquired the Machine" is replaced by:

1) "the laws of Austria" in **Albania, Armenia, Azerbaijan, Belarus, Bosnia-Herzegovina, Bulgaria, Croatia, Georgia, Hungary, Kazakhstan, Kyrgyzstan, FYR Macedonia, Moldova, Poland, Romania, Russia, Slovakia, Slovenia, Tajikistan, Turkmenistan, Ukraine, Uzbekistan, and FR Yugoslavia;**
2) "the laws of France" in **Algeria, Benin, Burkina Faso, Cameroon, Cape Verde, Central African Republic, Chad, Comoros, Congo Republic, Djibouti, Democratic Republic of Congo, Equatorial Guinea, French Guiana, French Polynesia, Gabon, Gambia, Guinea, Guinea-Bissau, Ivory Coast, Lebanon, Madagascar, Mali, Mauritania, Mauritius, Mayotte, Morocco, New Caledonia, Niger, Reunion, Senegal, Seychelles, Togo, Tunisia, Vanuatu, and Wallis & Futuna;** 3) "the laws of Finland" in **Estonia, Latvia, and Lithuania;** 4) "the laws of England" in **Angola, Bahrain, Botswana, Burundi, Egypt, Eritrea, Ethiopia, Ghana, Jordan, Kenya, Kuwait, Liberia, Malawi, Malta, Mozambique, Nigeria, Oman, Pakistan, Qatar, Rwanda, Sao Tome, Saudi Arabia, Sierra Leone, Somalia, Tanzania, Uganda, United Arab Emirates, the United Kingdom, West Bank/Gaza, Yemen, Zambia, and Zimbabwe;** and 5) "the laws of South Africa" in **South Africa, Namibia, Lesotho and Swaziland.**

Jurisdiction: *The following exceptions are added to this section:*

1) **In Austria** the choice of jurisdiction for all disputes arising out of this Statement of Limited Warranty and relating thereto, including its existence, will be the competent court of law in Vienna, Austria (Inner-City); 2) **in Angola, Bahrain, Botswana, Burundi, Egypt, Eritrea, Ethiopia, Ghana, Jordan, Kenya, Kuwait, Liberia, Malawi, Malta, Mozambique, Nigeria, Oman, Pakistan, Qatar, Rwanda, Sao Tome, Saudi Arabia, Sierra Leone, Somalia, Tanzania, Uganda, United Arab Emirates, West Bank/Gaza, Yemen, Zambia, and Zimbabwe** all disputes arising out of this Statement of Limited Warranty or related to its execution, including summary proceedings, will be submitted to the exclusive jurisdiction of the English courts; 3) **in Belgium and Luxembourg**, all disputes arising out of this Statement of Limited Warranty or related to its interpretation or its execution, the law, and the courts of the capital city, of the country of your registered office and/or commercial site location only are competent; 4) **in France, Algeria, Benin, Burkina Faso, Cameroon, Cape Verde, Central African Republic, Chad, Comoros, Congo Republic, Djibouti, Democratic Republic of Congo, Equatorial Guinea, French Guiana, French Polynesia, Gabon, Gambia, Guinea, Guinea-Bissau, Ivory Coast, Lebanon, Madagascar, Mali, Mauritania, Mauritius, Mayotte, Morocco, New Caledonia, Niger, Reunion, Senegal, Seychelles, Togo, Tunisia, Vanuatu, and Wallis & Futuna** all disputes arising out of this Statement of Limited Warranty or related to its violation or execution, including summary proceedings, will be settled exclusively by the Commercial Court of Paris; 5) **in Russia**, all disputes arising out of or in relation to the interpretation, the violation, the termination, the nullity of the execution of this Statement of Limited Warranty shall be settled by Arbitration Court of Moscow; 6) **in South Africa, Namibia, Lesotho and Swaziland**, both of us agree to submit all disputes relating to this Statement of Limited Warranty to the jurisdiction of the High Court in Johannesburg; 7) **in Turkey** all disputes arising out of or in connection with this Statement of Limited Warranty shall be resolved by the Istanbul Central (Sultanahmet) Courts and Execution Directorates of Istanbul, the Republic of Turkey; 8) in each of the following specified countries, any legal claim arising out of this Statement of Limited Warranty will be brought before, and settled exclusively by, the competent court of a) Athens for **Greece**, b) Tel Aviv-Jaffa for **Israel**, c) Milan for **Italy**, d) Lisbon for **Portugal**, and e) Madrid for **Spain**; and 9) **in the United Kingdom**, both of us agree to submit all disputes relating to this Statement of Limited Warranty to the jurisdiction of the English courts.

Arbitration: *The following is added under this heading:*

In Albania, Armenia, Azerbaijan, Belarus, Bosnia-Herzegovina, Bulgaria, Croatia, Georgia, Hungary, Kazakhstan, Kyrgyzstan, FYR Macedonia, Moldova, Poland, Romania, Russia, Slovakia, Slovenia, Tajikistan, Turkmenistan, Ukraine, Uzbekistan, and FR Yugoslavia all disputes arising out of this Statement of Limited Warranty or related to its violation, termination or nullity will be finally settled under the Rules of Arbitration and Conciliation of the International Arbitral Center of the Federal Economic Chamber in Vienna (Vienna Rules) by three arbitrators appointed in accordance with these rules. The arbitration will be held in Vienna, Austria, and the official language of the proceedings will be English. The decision of the arbitrators will be final and binding upon both parties. Therefore, pursuant to paragraph 598 (2) of the Austrian Code of Civil Procedure, the parties expressly waive the application of paragraph 595 (1) figure 7 of the Code. IBM may, however, institute proceedings in a competent court in the country of installation.

In Estonia, Latvia and Lithuania all disputes arising in connection with this Statement of Limited Warranty will be finally settled in arbitration that will be held in Helsinki, Finland in accordance with the arbitration laws of Finland then in effect. Each party will appoint one arbitrator. The arbitrators will then jointly appoint the chairman. If arbitrators cannot agree on the chairman, then the Central Chamber of Commerce in Helsinki will appoint the chairman.

EUROPEAN UNION (EU)

THE FOLLOWING TERMS APPLY TO ALL EU COUNTRIES:

Consumers have legal rights under applicable national legislation governing the sale of consumer goods. Such rights are not affected by the warranties provided in this Statement of Limited Warranty.

How to Obtain Warranty Service: *The following is added to this section:*

To obtain warranty service from IBM in EU countries, see the telephone listing in Part 3 - Warranty Information.

You may contact IBM at the following address:

IBM Warranty & Service Quality Dept.

PO Box 30

Spango Valley

Greenock

Scotland PA 16 OAH

AUSTRIA, DENMARK, FINLAND, GREECE, ITALY, NETHERLANDS, PORTUGAL, SPAIN, SWEDEN AND SWITZERLAND

Limitation of Liability: *The following replaces the terms of this section in its entirety:*

Except as otherwise provided by mandatory law:

1. IBM's liability for any damages and losses that may arise as a consequence of the fulfillment of its obligations under or in connection with this Statement of Limited Warranty or due to any other cause related to this Statement of Limited Warranty is limited to the compensation of only those damages and losses proved and actually arising as an immediate and direct consequence of the non-fulfillment of such obligations (if IBM is at fault) or of such cause, for a maximum amount equal to the charges you paid for the Machine. For purposes of this item, the term "Machine" includes Machine Code and Licensed Internal Code ("LIC").

The above limitation shall not apply to damages for bodily injuries (including death) and damages to real property and tangible personal property for which IBM is legally liable.

2. **UNDER NO CIRCUMSTANCES IS IBM, ITS SUPPLIERS OR RESELLERS LIABLE FOR ANY OF THE FOLLOWING, EVEN IF INFORMED OF THEIR**

POSSIBILITY: 1) LOSS OF, OR DAMAGE TO, DATA; 2) INCIDENTAL OR INDIRECT DAMAGES, OR FOR ANY ECONOMIC CONSEQUENTIAL DAMAGES; 3) LOST PROFITS, EVEN IF THEY ARISE AS AN IMMEDIATE CONSEQUENCE OF THE EVENT THAT GENERATED THE DAMAGES; OR 4) LOSS OF BUSINESS, REVENUE, GOODWILL, OR ANTICIPATED SAVINGS.

FRANCE AND BELGIUM

Limitation of Liability: *The following replaces the terms of this section in its entirety:*

Except as otherwise provided by mandatory law:

1. IBM's liability for any damages and losses that may arise as a consequence of the fulfillment of its obligations under or in connection with this Statement of Limited Warranty is limited to the compensation of only those damages and losses proved and actually arising as an immediate and direct consequence of the non-fulfillment of such obligations (if IBM is at fault), for a maximum amount equal to the charges you paid for the Machine that has caused the damages. For purposes of this item, the term "Machine" includes Machine Code and Licensed Internal Code ("LIC").

The above limitation shall not apply to damages for bodily injuries (including death) and damages to real property and tangible personal property for which IBM is legally liable.

2. **UNDER NO CIRCUMSTANCES IS IBM, ITS SUPPLIERS OR RESELLERS LIABLE FOR ANY OF THE FOLLOWING, EVEN IF INFORMED OF THEIR POSSIBILITY: 1) LOSS OF, OR DAMAGE TO, DATA; 2) INCIDENTAL OR INDIRECT DAMAGES, OR FOR ANY ECONOMIC CONSEQUENTIAL DAMAGES; 3) LOST PROFITS, EVEN IF THEY ARISE AS AN IMMEDIATE CONSEQUENCE OF THE EVENT THAT GENERATED THE DAMAGES; OR 4) LOSS OF BUSINESS, REVENUE, GOODWILL, OR ANTICIPATED SAVINGS.**

THE FOLLOWING TERMS APPLY TO THE COUNTRY SPECIFIED:

AUSTRIA

What this Warranty Covers: *The following replaces the first sentence of the first paragraph of this section:*

The warranty for an IBM Machine covers the functionality of the Machine for its normal use and the Machine's conformity to its Specifications.

The following paragraphs are added to this Section:

The minimum warranty period for Machines is 12 months from the date of delivery. . The limitation period for consumers in action for breach of warranty is the statutory period as a minimum. In case IBM or your reseller is unable to repair an IBM Machine, you can alternatively ask for a partial refund as far as justified by the reduced value of the unrepaired Machine or ask for a cancellation of the respective agreement for such Machine and get your money refunded.

The second paragraph does not apply.

What IBM Will Do to Correct Problems: *The following is added to this section:*

During the warranty period, transportation for delivery of the failing Machine to IBM will be at IBM's expense.

Limitation of Liability: *The following paragraph is added to this section:*

The limitations and exclusions specified in the Statement of Limited Warranty will not apply to damages caused by IBM with fraud or gross negligence and for express warranty.

The following sentence is added to the end of item 2:

IBM's liability under this item is limited to the violation of essential contractual terms in cases of ordinary negligence.

EGYPT

Limitation of Liability: *The following replaces item 2 in this section:*

as to any other actual direct damages, IBM's liability will be limited to the total amount you paid for the Machine that is the subject of the claim. For purposes of this item, the term 『Machine』 includes Machine Code and Licensed Internal Code (LIC).

Applicability of suppliers and resellers (unchanged).

FRANCE

Limitation of Liability: *The following replaces the second sentence of the first paragraph of this section:*

In such instances, regardless of the basis on which you are entitled to claim damages from IBM, IBM is liable for no more than: *(items 1 and 2 unchanged).*

GERMANY

What this Warranty Covers: *The following replaces the first sentence of the first paragraph of this section:*

The warranty for an IBM Machine covers the functionality of the Machine for its normal use and the Machine's conformity to its Specifications.

The following paragraphs are added to this section:

The minimum warranty period for Machines is twelve months. In case IBM or your reseller is unable to repair an IBM Machine, you can alternatively ask for a partial refund as far as justified by the reduced value of the unrepaired Machine or ask for a cancellation of the respective agreement for such Machine and get your money refunded.

The second paragraph does not apply.

What IBM Will Do to Correct Problems: *The following is added to this section:*

During the warranty period, transportation for delivery of the failing Machine to IBM will be at IBM's expense.

Limitation of Liability: *The following paragraph is added to this section:*

The limitations and exclusions specified in the Statement of Limited Warranty will not apply to damages caused by IBM with fraud or gross negligence and for express warranty.

The following sentence is added to the end of item 2:

IBM's liability under this item is limited to the violation of essential contractual terms in cases of ordinary negligence.

HUNGARY

Limitation of Liability: *The following is added at the end of this section:*

The limitation and exclusion specified herein shall not apply to liability for a breach of contract damaging life, physical well-being, or health that has been caused intentionally, by gross negligence, or by a criminal act.

The parties accept the limitations of liability as valid provisions and state that the Section 314.(2) of the Hungarian Civil Code applies as the acquisition price as well as other advantages arising out of the present Statement of Limited Warranty balance this limitation of liability.

IRELAND

What this Warranty Covers: *The following is added to this section:*

Except as expressly provided in these terms and conditions, all statutory conditions, including all warranties implied, but without prejudice to the generality of the foregoing all warranties implied by the Sale of Goods Act 1893 or the Sale of Goods and Supply of Services Act 1980 are hereby excluded.

Limitation of Liability: *The following replaces the terms of this section in its entirety:*

For the purposes of this section, a "Default" means any act, statement, omission, or negligence on the part of IBM in connection with, or in relation to, the subject matter of this Statement of Limited Warranty in respect of which IBM is legally liable to you, whether in contract or tort. A number of Defaults which together result in, or contribute to, substantially the same loss or damage will be treated as one Default occurring on the date of occurrence of the last such Default.

Circumstances may arise where, because of a Default, you are entitled to recover damages from IBM.

This section sets out the extent of IBM's liability and your sole remedy.

1. IBM will accept unlimited liability for death or personal injury caused by the negligence of IBM.
2. Subject always to the Items for Which IBM is Not Liable below, IBM will accept unlimited liability for physical damage to your tangible property resulting from the negligence of IBM.
3. Except as provided in items 1 and 2 above, IBM's entire liability for actual damages for any one Default will not in any event exceed the greater of 1) EUR 125,000, or 2) 125% of the amount you paid for the Machine directly relating to the Default.

Items for Which IBM is Not Liable

Save with respect to any liability referred to in item 1 above, under no circumstances is IBM, its suppliers or resellers liable for any of the following, even if IBM or they were informed of the possibility of such losses:

1. loss of, or damage to, data;
2. special, indirect, or consequential loss; or
3. loss of profits, business, revenue, goodwill, or anticipated savings.

SLOVAKIA

Limitation of Liability: *The following is added to the end of the last paragraph:*

The limitations apply to the extent they are not prohibited under §§ 373-386 of the Slovak Commercial Code.

SOUTH AFRICA, NAMIBIA, BOTSWANA, LESOTHO AND SWAZILAND

Limitation of Liability: *The following is added to this section:*

IBM's entire liability to you for actual damages arising in all situations involving nonperformance by IBM in respect of the subject matter of this Statement of Warranty will be limited to the charge paid by you for the individual Machine that is the subject of your claim from IBM.

UNITED KINGDOM

Limitation of Liability: *The following replaces the terms of this section in its entirety:*

For the purposes of this section, a "Default" means any act, statement, omission, or negligence on the part of IBM in connection with, or in relation to, the subject matter of this Statement of Limited Warranty in respect of which IBM is legally liable to you, whether in contract or tort. A number of Defaults which together result in, or contribute to, substantially the same loss or damage will be treated as one Default.

Circumstances may arise where, because of a Default, you are entitled to recover damages from IBM.

This section sets out the extent of IBM's liability and your sole remedy.

1. IBM will accept unlimited liability for:
 - a. death or personal injury caused by the negligence of IBM; and
 - b. any breach of its obligations implied by Section 12 of the Sale of Goods Act 1979 or Section 2 of the Supply of Goods and Services Act 1982, or any statutory modification or re-enactment of either such Section.
2. IBM will accept unlimited liability, subject always to the Items for Which IBM is Not Liable below, for physical damage to your tangible property resulting from the negligence of IBM.

3. IBM's entire liability for actual damages for any one Default will not in any event, except as provided in items 1 and 2 above, exceed the greater of 1) Pounds Sterling 75,000, or 2) 125% of the total purchase price payable or the charges for the Machine directly relating to the Default.

These limits also apply to IBM's suppliers and resellers. They state the maximum for which IBM and such suppliers and resellers are collectively responsible.

Items for Which IBM is Not Liable

Save with respect to any liability referred to in item 1 above, under no circumstances is IBM or any of its suppliers or resellers liable for any of the following, even if IBM or they were informed of the possibility of such losses:

1. loss of, or damage to, data:
2. special, indirect, or consequential loss; or
3. loss of profits, business, revenue, goodwill, or anticipated savings.

Part 3 - Warranty Information

This Part 3 provides information regarding the warranty applicable to your Machine, including the warranty period and type of warranty service IBM provides.

Warranty Period

The warranty period may vary by country or region and is specified in the table below. NOTE: "Region" means either Hong Kong or Macau Special Administrative Region of China.

48X/32X/48X/16X Max CD-RW/DVD-ROM Combination Drive

Country or Region of Purchase	Warranty Period	Type of Warranty Service
Worldwide	1 year	1, 4

A warranty period of 1 year on parts and 1 year on labor means that IBM provides warranty service without charge for parts and labor during the 1 year warranty period.

Types of Warranty Service

If required, IBM provides repair or exchange service depending on the type of warranty service specified for your Machine in the above table and as described below. Warranty service may be provided by your reseller if approved by IBM to perform warranty service. Scheduling of service will depend upon the time of your call and is subject to parts availability. Service levels are response time objectives and are not guaranteed. The specified level of warranty service may not be available in all worldwide locations, additional charges may apply outside IBM's normal service area, contact your local IBM representative or your reseller for country and location specific information.

1. Customer Replaceable Unit ("CRU") Service

IBM will ship CRU parts to you for your replacement. If IBM instructs you to return the replaced CRU, you are responsible for returning it to IBM in accordance with IBM's instructions. If you do not return the defective CRU, if IBM so instructs, within 30 days of your receipt of the replacement CRU, IBM may charge you for the replacement.

2. On-site Service

IBM or your reseller will either repair or exchange the failing Machine at your location and verify its operation. You must provide suitable working area to allow disassembly and reassembly of the IBM Machine. The area must be clean, well lit and suitable for the purpose. **For some Machines, certain repairs may require sending the Machine to an IBM service center.**

3. Courier or Depot Service¹

You will disconnect the failing Machine for collection arranged by IBM. IBM will provide you with a shipping container for you to return your Machine to a designated service center. A courier will pick up your Machine and deliver it to the designated service center. Following its repair or exchange, IBM will arrange the return delivery of the Machine to your location. You are responsible for its installation and verification.

4. Customer Carry-In or Mail-In Service

You will deliver or mail as IBM specifies (prepaid unless IBM specifies otherwise) the failing Machine suitably packaged to a location IBM designates. After IBM has repaired or exchanged the Machine, IBM will make it available for your collection or, for Mail-in Service, IBM will return it to you at IBM's expense, unless IBM specifies otherwise. You are responsible for the subsequent installation and verification of the Machine.

The IBM Machine Warranty worldwide web site at http://www.ibm.com/servers/support/machine_warranties/ provides a worldwide overview of IBM's Limited Warranty for Machines, a Glossary of IBM definitions, Frequently Asked Questions (FAQs) and Support by Product (Machine) with links to Product Support pages. **The IBM Statement of Limited Warranty is also available on this site in 29 languages.**

To obtain warranty service contact IBM or your IBM reseller. In Canada or the United States, call 1-800-IBM-SERV (426-7378). For other countries, see the telephone numbers below.

Phone numbers are subject to change without notice. For the latest phone number list, go to www-3.ibm.com/pc/support/site.wss/ and click **Support Phone List**.

Country or Region	Telephone Number	Country or Region	Telephone Number
Argentina	0800-666-0011	Malaysia	03-7727-7800
Australia	1300-130-426	Mexico	001-866-434-2080
Austria	01-24592-5901	Netherlands	020-514-5770

1. This type of service is called ThinkPad EasyServ or EasyServ in some countries.

Country or Region	Telephone Number	Country or Region	Telephone Number
Belgium	Dutch 02-210-9820 French 02-210-9800	New Zealand	0800-446-149
Bolivia	0800-0189	Norway	66 81 11 00
Brazil	55-11-3889-8986	Peru	0-800-50-866
Canada	1-800-565-3344 Toronto 416-383-3344	Philippines	632-995-2225
Chile	800-224-488	Portugal	21-791 51 47
China (PRC)	800-810-1818	Russia	095-940-2000
China (Hong Kong S.A.R.)	852-2825-7799	Singapore	1800-840-9911
Columbia	980-912-3021	Spain	91-662 49 16
Denmark	45 20 82 00	Sweden	08-477 4420
Ecuador	1-800-426911 (option #4)	Switzerland	058-333-09-00
Finland	09-459 69 60	Taiwan	886-2-2725-9799
France	02 38 55 74 50	Thailand	66-2-273-4000
Germany	07032-1549 201	Turkey	00-800-446-32-041
Indonesia	021-523-8535	United Kingdom	0-1475-555 055
Ireland	01-815-9202	United States	1-800-426-7378
Italy	02-7031-6101	Uruguay	000-411-005-6649
Japan	Consumer customers 0120-887-870 Business customers 0120-887-874	Venezuela	0-800-100-2011
Luxembourg	298-977 5063	Vietnam	848-8295-160

附錄 G. Notices

Federal Communications Commission (FCC) statement

Note: This equipment has been tested and found to comply with the limits for a Class B digital device, pursuant to Part 15 of the FCC Rules. These limits are designed to provide reasonable protection against harmful interference in a residential installation. This equipment generates, uses, and can radiate radio frequency energy and, if not installed and used in accordance with the instructions, may cause harmful interference to radio communications. However, there is no guarantee that interference will not occur in a particular installation. If this equipment does cause harmful interference to radio or television reception, which can be determined by turning the equipment off and on, the user is encouraged to try to correct the interference by one or more of the following measures:

- Reorient or relocate the receiving antenna.
- Increase the separation between the equipment and receiver.
- Connect the equipment into an outlet on a circuit different from that to which the receiver is connected.
- Consult an IBM authorized dealer or service representative for help.

Properly shielded and grounded cables and connectors must be used in order to meet FCC emission limits. Proper cables and connectors are available from IBM authorized dealers. IBM is not responsible for any radio or television interference caused by using other than recommended cables and connectors or by unauthorized changes or modifications to this equipment. Unauthorized changes or modifications could void the user's authority to operate the equipment.

This device complies with Part 15 of the FCC Rules. Operation is subject to the following two conditions: (1) this device may not cause harmful interference, and (2) this device must accept any interference received, including interference that may cause undesired operation.

Responsible party:

International Business Machines Corporation
New Orchard Road
Armonk, NY 10504
Telephone: 1-919-543-2193

 Tested To Comply
With FCC Standards
FOR HOME OR OFFICE USE

Industry Canada Class B emission compliance statement

This Class B digital apparatus complies with Canadian ICES-003.

Avis de conformité a la réglementation d'Industrie Canada

Cet appareil numérique de la classe B est conforme à la norme NMB-003 du Canada.

Deutsche EMV-Direktive (electromagnetische Verträglichkeit)

Zulassungsbeseinigunglaut dem Deutschen Gesetz über die elektromagnetische Verträglichkeit von Geräten (EMVG) vom 30. August 1995 (bzw. der EMC EG Richtlinie 89/336):

Dieses Gerät ist berechtigt in Übereinstimmungmit dem Deutschen EMVG das EG-Konformitätszeichen - CE - zu führen. Verantwortlich für die Konformitätserklärung nach Paragraph 5 des EMVG ist die:

IBM Deutschland Informationssysteme GmbH, 70548 Stuttgart.

Informationen in Hinsicht EMVG Paragraph 3 Abs. (2) 2:

Das Gerät erfüllt die Schutzanforderungen nach EN 55024:1998 und EN 55022:1998 Klasse B.
--

EN 55022 Hinweis:

『Wird dieses Gerät in einer industriellen Umgebung betrieben (wie in EN 55022:B festgelegt), dann kann es dabei eventuell gestört werden. In solch einem FA11 ist der Abstand bzw. die Abschirmungzu der industriellen Störquelle zu vergrößern.』

Anmerkung:

Um die Einhaltung des EMVG sicherzustellen sind die Geräte, wie in den IBM Handbüchern angegeben, zu installieren und zu betreiben.

European Union - emission directive

This product is in conformity with the protection requirements of EU Council Directive 89/336/ECC on the approximation of the laws of the Member States relating to electromagnetic compatibility.

IBM can not accept responsibility for any failure to satisfy the protection requirements resulting from a non-recommended modification of the product, including the fitting of non-IBM option cards.

This product has been tested and found to comply with the limits for Class B Information Technology Equipment according to European Standard EN 55022. The limits for Class B equipment were derived for typical residential environments to provide reasonable protection against interference with licensed communication devices.

Union Européenne - Directive Conformité électromagnétique

Ce produit est conforme aux exigences de protection de la Directive 89/336/EEC du Conseil de l'UE sur le rapprochement des lois des États membres en matière de compatibilité électromagnétique.

IBM ne peut accepter aucune responsabilité pour le manquement aux exigences de protection résultant d'une modification non recommandée du produit, y compris l'installation de cartes autres que les cartes IBM.

Ce produit a été testé et il satisfait les conditions de l'équipement informatique de Classe B en vertu de Standard européen EN 55022. Les conditions pour l'équipement de Classe B ont été définies en fonction d'un contexte résidentiel ordinaire afin de fournir une protection raisonnable contre l'interférence d'appareils de communication autorisés.

Unione Europea - Directiva EMC (Conformidad electromagnética)

Este producto satisface los requisitos de protección del Consejo de la UE, Directiva 89/336/CEE en lo que a la legislatura de los Estados Miembros sobre compatibilidad electromagnética se refiere.

IBM no puede aceptar responsabilidad alguna si este producto deja de satisfacer dichos requisitos de protección como resultado de una modificación no recomendada del producto, incluyendo el ajuste de tarjetas de opción que no sean IBM.

Este producto ha sido probado y satisface los límites para Equipos Informáticos Clase B de conformidad con el Estándar Europeo EN 55022. Los límites para los equipos de Clase B se han establecido para entornos residenciales típicos a fin de proporcionar una protección razonable contra las interferencias con dispositivos de comunicación licenciados.

Union Europea - Normativa EMC

Questo prodotto è conforme alle normative di protezione ai sensi della Direttiva del Consiglio dell'Unione Europea 89/336/CEE sull'armonizzazione legislativa degli stati membri in materia di compatibilità elettromagnetica.

IBM non accetta responsabilità alcuna per la mancata conformità alle normative di protezione dovuta a modifiche non consigliate al prodotto, compresa l'installazione di schede e componenti di marca diversa da IBM.

Le prove effettuate sul presente prodotto hanno accertato che esso rientra nei limiti stabiliti per le apparecchiature di informatica Classe B ai sensi della Norma Europea EN 55022. I limiti delle apparecchiature della Classe B sono stati stabiliti al fine di fornire ragionevole protezione da interferenze mediante dispositivi di comunicazione in concessione in ambienti residenziali tipici.

이 기기는 가정용으로 전자파 적합등록을 한 기기로서
주거지역에서는 물론 모든 지역에서 사용할 수 있습니다.

この装置は、情報処理装置等電波障害自主規制協議会（VCCI）の基準に基づくクラスB情報技術装置です。この装置は、家庭環境で使用することを目的としていますが、この装置がラジオやテレビジョン受信機に近接して使用されると、受信障害を引き起こすことがあります。
取扱説明書に従って正しい取り扱いをして下さい。

Japanese statement of compliance for products less than or equal to 20 A per phase

高調波ガイドライン適合品

Trademarks

The following terms are trademarks of International Business Machines Corporation in the United States, other countries, or both:

IBM

IBM logo

Intel and Pentium are trademarks of Intel Corporation in the United States, other countries, or both.

Microsoft, Windows, and Windows NT are trademarks of Microsoft Corporation in the United States, other countries, or both.

Other company, product, or service names may be trademarks or service marks of others.

Electronic emission notices

Machine - 48X/32X/48X/16X Max CD-RW/DVD-ROM Combination Drive

Federal Communications Commission (FCC) statement

Note: This equipment has been tested and found to comply with the limits for a Class B digital device, pursuant to Part 15 of the FCC Rules. These limits are designed to provide reasonable protection against harmful interference when the equipment is operated in a commercial environment. This equipment generates, uses, and can radiate radio frequency energy and, if not installed and used in accordance with the instruction manual, may cause harmful interference to radio communications. Operation of this equipment in a residential area is likely to cause harmful interference, in which case the user will be required to correct the interference at his own expense.

Properly shielded and grounded cables and connectors must be used in order to meet FCC emission limits. IBM is not responsible for any radio or television interference caused by using other than recommended cables and connectors or by unauthorized changes or modifications to this equipment. Unauthorized changes or modifications could void the user's authority to operate the equipment.

This device complies with Part 15 of the FCC Rules. Operation is subject to the following two conditions: (1) this device may not cause harmful interference, and (2) this device must accept any interference received, including interference that may cause undesired operation.

Industry Canada Class B emission compliance statement

This Class B digital apparatus complies with Canadian ICES-003.

Avis de conformite a la reglementation d'Industrie Canada

Cet appareil numérique de la classe A est conforme à la norme NMB-003 du Canada.

Deutsche EMV-Direktive (electromagnetische Verträglichkeit)

Dieses Gerät ist berechtigt in Übereinstimmung mit dem deutschen EMVG vom 9.Nov.92 das EG-Konformitätszeichen zu führen.

Der Aussteller der Konformitätserklärung ist die IBM UK, Greenock.

Dieses Gerät erfüllt die Bedingungen der EN 55022 Klasse A. Für diese Klasse von Geräten gilt folgende Bestimmung nach dem EMVG:

Geräte dürfen an Orten, für die sie nicht ausreichend entstört sind, nur mit besonderer Genehmigung des Bundesministers für Post und Telekommunikation oder des Bundesamtes für Post und Telekommunikation betrieben werden. Die Genehmigung wird erteilt, wenn keine elektromagnetischen Störungen zu erwarten sind.

(Auszug aus dem EMVG vom 9.Nov.92, Para.3. Abs.4)

Hinweis: Dieses Genehmigungsverfahren ist von der Deutschen Bundespost noch nicht veröffentlicht worden.

European Union - EMC directive

This product is in conformity with the protection requirements of EU Council Directive 89/336/ECC on the approximation of the laws of the Member States relating to electromagnetic compatibility.

IBM cannot accept responsibility for any failure to satisfy the protection requirements resulting from a non-recommended modification of the product, including the fitting of non-IBM option cards.

This product has been tested and found to comply with the limits for Class B Information Technology Equipment according to CISPR 22/European Standard EN 55022. The limits for Class B equipment were derived for commercial and industrial environments to provide reasonable protection against interference with licensed communication equipment.

Warning: This is a Class B product. In a domestic environment this product may cause radio interference in which case the user may be required to take adequate measures.
--

Union Européenne - Directive Conformité électromagnétique

Ce produit est conforme aux exigences de protection de la Directive 89/336/EEC du Conseil de l'UE sur le rapprochement des lois des États membres en matière de compatibilité électromagnétique.

IBM ne peut accepter aucune responsabilité pour le manquement aux exigences de protection résultant d'une modification non recommandée du produit, y compris l'installation de cartes autres que les cartes IBM.

Ce produit a été testé et il satisfait les conditions de l'équipement informatique de Classe A en vertu de CISPR22/Standard européen EN 55022. Les conditions pour l'équipement de Classe A ont été définies en fonction d'un contexte d'utilisation commercial et industriel afin de fournir une protection raisonnable contre l'interférence d'appareils de communication autorisés.

Avvertissement : Ceci est un produit de Classe A. Dans un contexte résidentiel, ce produit peut causer une interférence radio exigeant que l'utilisateur prenne des mesures adéquates.

Union Europea - Normativa EMC

Questo prodotto è conforme alle normative di protezione ai sensi della Direttiva del Consiglio dell'Unione Europea 89/336/CEE sull'armonizzazione legislativa degli stati membri in materia di compatibilità elettromagnetica.

IBM non accetta responsabilità alcuna per la mancata conformità alle normative di protezione dovuta a modifiche non consigliate al prodotto, compresa l'installazione di schede e componenti di marca diversa da IBM.

Le prove effettuate sul presente prodotto hanno accertato che esso rientra nei limiti stabiliti per le apparecchiature di informatica Classe A ai sensi del CISPR 22/Norma Europea EN 55022. I limiti delle apparecchiature della Classe A sono stati stabiliti al fine di fornire ragionevole protezione da interferenze mediante dispositivi di comunicazione in concessione in ambienti commerciali ed industriali.

Avvertimento: Questo è un prodotto appartenente alla Classe A. In ambiente domestico, tale prodotto può essere causa di interferenze radio, nel qual caso l'utente deve prendere misure adeguate.

Unione Europea - Directiva EMC (Conformidad electromagnética)

Este producto satisface los requisitos de protección del Consejo de la UE, Directiva 89/336/CEE en lo que a la legislación de los Estados Miembros sobre compatibilidad electromagnética se refiere.

IBM no puede aceptar responsabilidad alguna si este producto deja de satisfacer dichos requisitos de protección como resultado de una modificación no recomendada del producto, incluyendo el ajuste de tarjetas de opción que no sean IBM.

Este producto ha sido probado y satisface los límites para Equipos Informáticos Clase A de conformidad con el Estándar CISPR22 y el Estándar Europeo EN 55022. Los límites para los equipos de Clase A se han establecido para entornos comerciales e industriales a fin de proporcionar una protección razonable contra las interferencias con dispositivos de comunicación licenciados.

Advertencia: Este es un producto de Clase A. En un entorno doméstico este producto podría causar radiointerferencias en cuyo caso el usuario deberá tomar las medidas adecuadas.

この装置は、情報処理装置等電波障害自主規制協議会（VCCI）の基準に基づくクラスA情報技術装置です。この装置を家庭環境で使用すると電波妨害を引き起こすことがあります。この場合には使用者が適切な対策を講ずるよう要求されることがあります。

警告使用者：
這是甲類的資訊產品，在居住的環境中使用時，可能會造成射頻干擾，在這種情況下，使用者會被要求採取某些適當的對策。



Part Number: 73P3304

Printed in China

(1P) P/N: 73P3304

