

ThinkCentre™



# A35 Tower Hardware Maintenance Manual Types 8139



**Date : 22-Feb-2005**

# Contents

Chapter 1. About this manual.....	2
Chapter 2. General information.....	3
Specifications.....	4
Block diagram.....	4
Feature summary.....	5
Mother board layout.....	6
Parts listing.....	7
Recover CD number.....	8
Chapter 3. Hardware Installation.....	10
Considerations Prior to Installation.....	10
Exchange of the HDD.....	11
Exchange of the ODD.....	12
Exchange of the FDD.....	13
Installation of the CPU and Heat-sink.....	14
Installation of the CPU.....	14
Installation of the Heat0sink.....	15
Installation of Memory.....	16
Installation of Expansion Cards.....	17
I/O Back Panel Introduction.....	18
Connectors Introduction.....	19
Chapter 4. BIOS Specification and Setup.....	30
BIOS Requirement.....	31
Specific Features.....	31
BIOS Error Messages.....	37
BIOS Setup.....	44
Standard CMOS Features.....	44
Advanced BIOS Features.....	46
Integrated Peripherals.....	48
Power Management Setup.....	49
PnP/PCI Configurations.....	51
PC Health Status.....	52
MB Intelligent Tweaker (M.I.T.).....	53
Top Performance.....	54
Select Language.....	55
Load Fail-Safe Defaults.....	55
Load Optimized Defaults.....	55
Set Supervisor/User Password.....	56
Save & Exit Setup.....	57
Exit Without Saving.....	57
Chapter 5. Safety Information . . . . .	58
Safety information . . . . .	58
General safety . . . . .	58
Electrical safety . . . . .	59
Safety inspection guide . . . . .	60
Safety notices (multi-lingual translations).....	61

# Chapter 1. About this manual

This manual contains service and reference information for IBM® computer Types Natucket.

This manual is divided into product service sections and a related service section, as follows:

- v The product service sections include procedures for isolating problems to a FRU, a Symptom-to-FRU Index, additional service information and an illustrated parts catalog.
- v The related service section includes safety notices and safety information, and problem determination tips.

# Chapter 2. General information

This section lists the physical specifications for your computer

### Dimensions

Height: 352 mm (13.86 in.)  
Width: 180 mm (7.09 in.)  
Depth: 407 mm (16.02 in.)

### Weight

Minimum configuration as shipped: 9.1 kg (20.06 lb)  
Maximum configuration: 9.2 kg (20.29 lb)

### Environment

#### Air temperature:

System on: 10° to 35°C (50° to 95° F)  
System off: 10° to 43°C (50° to 110° F)  
Maximum altitude: 3000 m (10000 ft)

*Note:* The maximum altitude, 3000 m (10000 ft), is the maximum altitude at which the specified air temperatures apply. At higher altitudes, the maximum air temperatures are lower than those specified.

#### Humidity:

System on: 10% to 90%  
System off: 10% to 90%

### Electrical input

#### Input voltage:

##### Low range:

Minimum: 100 V ac  
Maximum: 127 V ac  
Input frequency range: 50–60 Hz  
Voltage switch setting: 115 V ac

##### High range:

Minimum: 200 V ac  
Maximum: 240 V ac  
Input frequency range: 50–60 Hz  
Voltage switch setting: 230 V ac

#### Input kilovolt-amperes (KVA) (approximate):

Minimum configuration as shipped: 0.158 KVA  
Maximum configuration: 0.213 KVA

*Note:* Power consumption and heat output vary depending on the number and type of optional features installed and the power-management optional features in use.

### Heat output (approximate) in British thermal units (Btu) per hour:

Minimum configuration: 95.6 Btu/hr (28 watts)  
Maximum configuration: 129.7 Btu/hr (38 watts)

### Airflow

Approximately 2.45 cubic meters every minute (66 cubic feet every minute) maximum

### Acoustical noise-emission values

#### Average sound-pressure levels:

##### At operator position:

Idle: 32dBA  
Operating: 42dBA

##### At bystander position - 1 meter (3.3 ft):

Idle: 28dBA  
Operating: 38dBA

### Declared (upper limit) sound-power levels:

Idle: 4.5bels  
Operating: 5.2bels

*Note:* These levels were measured in controlled acoustical environments according to the procedures specified by the American National Standards Institute (ANSI) S12.10 and ISO 7779 and are reported in accordance with ISO 9296. Actual sound-pressure levels in a given location might exceed the average values stated because of room reflections and other nearby noise sources. The declared sound-power levels indicate an upper limit, below which a large number of computers will operate.

# Block Diagram

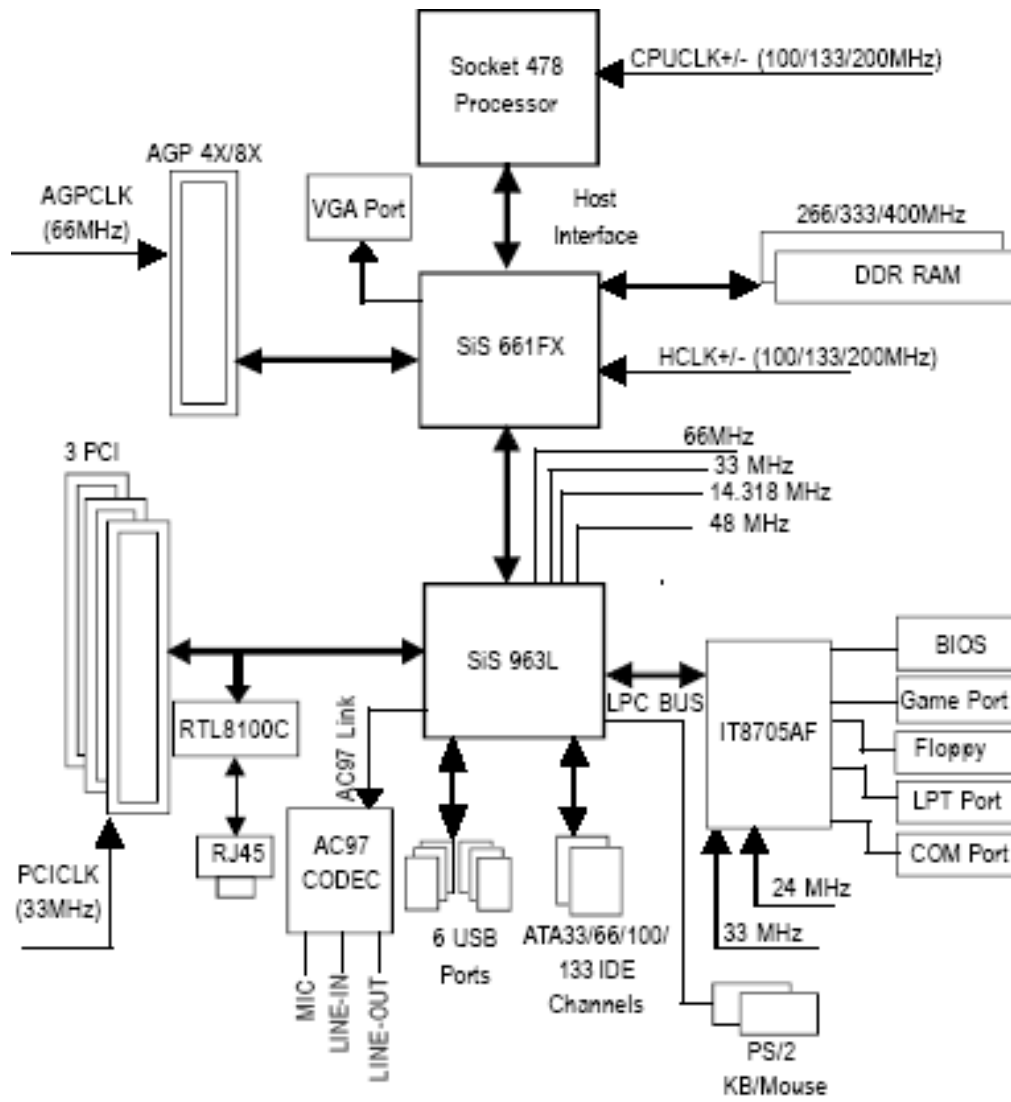

## Feature Summary

CPU	<ul style="list-style-type: none"><li>◆ Socket 478 for Intel® Pentium® 4 (Northwood, Prescott) processor with HT Technology</li><li>◆ Supports 800/533/400 MHz FSB</li><li>◆ L2 cache varies with processors</li></ul>
Chipset	<ul style="list-style-type: none"><li>◆ Northbridge: SiS® 661FX</li><li>◆ Southbridge: SiS® 963L</li></ul>
Memory	<ul style="list-style-type: none"><li>◆ 2 184-pin DDR DIMM slots</li><li>◆ Supports DDR400/333/266 DIMM</li><li>◆ Supports up to 2GB (Max.)</li></ul>
Slots	<ul style="list-style-type: none"><li>◆ 1 AGP slot 4X/8X (1.5V) device support</li><li>◆ 3 PCI slots</li></ul>
IDE Connections	<ul style="list-style-type: none"><li>◆ 2 IDE connection (UDMA 33/ATA 66/ATA 100/ATA133), allows connection of 4 IDE devices</li></ul>
FDD Connections	<ul style="list-style-type: none"><li>◆ 1 FDD connection, allows connection of 2 FDD devices</li></ul>
Peripherals	<ul style="list-style-type: none"><li>◆ 1 parallel port supporting Normal/EPP/ECP mode</li><li>◆ 1 VGA port, 1 COM port</li><li>◆ 6 USB 2.0/1.1 ports (rear x 2, front x 4 via cable)</li><li>◆ 1 front audio connector</li><li>◆ 1 PS/2 keyboard port</li><li>◆ 1 PS/2 mouse port</li></ul>
Onboard VGA	<ul style="list-style-type: none"><li>◆ Built-in SiS® 661FX Chipset</li></ul>
Onboard LAN	<ul style="list-style-type: none"><li>◆ RTL8100C chip</li><li>◆ 1 RJ45 port</li></ul>
Onboard Audio	<ul style="list-style-type: none"><li>◆ Realtek ALC655 CODEC</li><li>◆ Supports Line In ; Line Out ; MIC In</li><li>◆ Supports 2 / 4 / 6 channel audio</li><li>◆ SPDIF In/Out connection</li><li>◆ CD In connection/Game port</li></ul>
I/O Control	<ul style="list-style-type: none"><li>◆ IT8705AF</li></ul>
Hardware Monitor	<ul style="list-style-type: none"><li>◆ CPU/System fan speed detection</li><li>◆ System voltage detection</li><li>◆ CPU/System temperature detection</li><li>◆ CPU Smart Fan Control</li></ul>
BIOS	<ul style="list-style-type: none"><li>◆ Use of licensed AWARD BIOS</li></ul>
Form Factor	<ul style="list-style-type: none"><li>◆ Micro-ATX form factor; 24.4cm x 23.0cmCH</li></ul>

# Parts Listing

The following illustration will help you locate the various Components in the computer

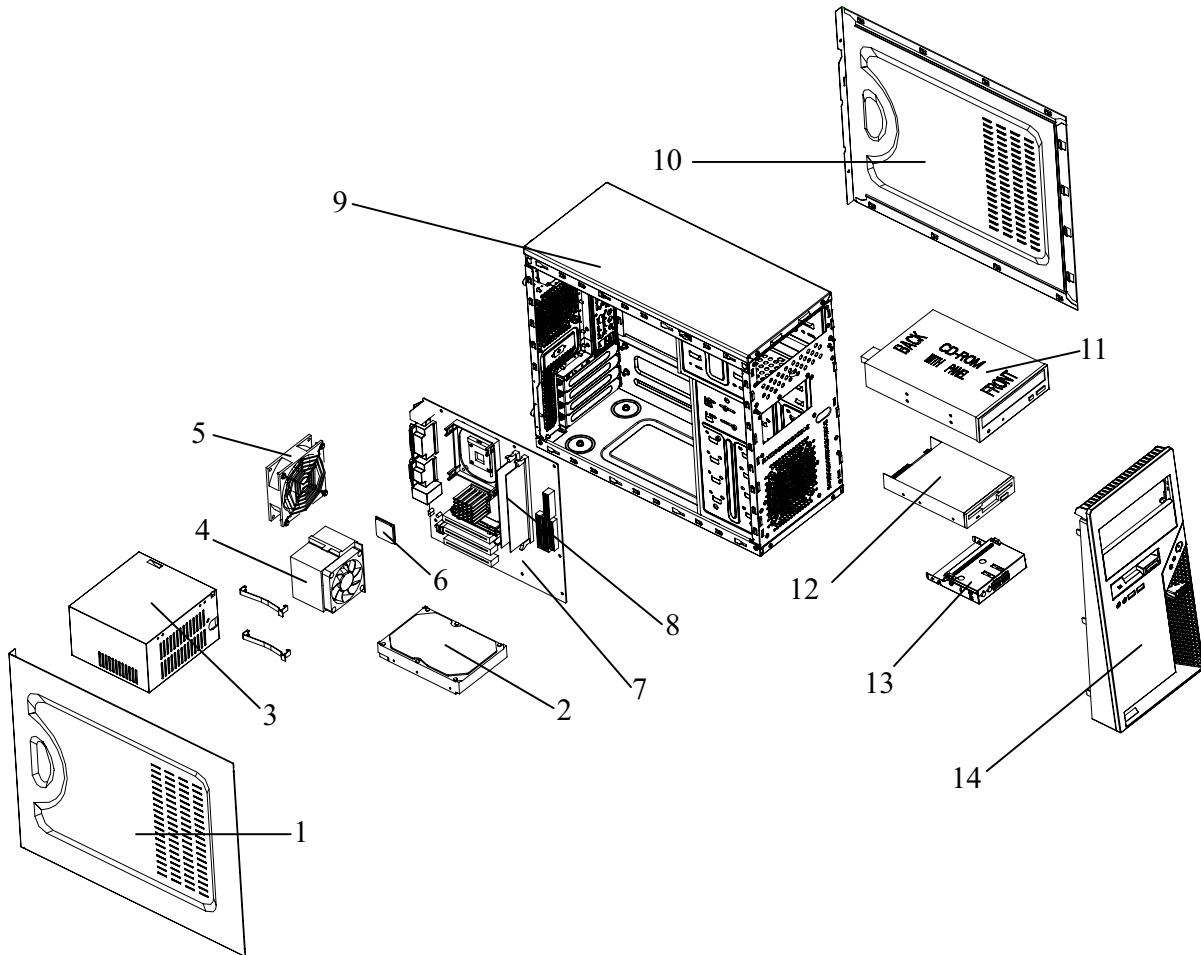

Item	Parts listing	FRU	CRU
1	SPS-PAINTED TOP COVER	3SA72-051	
2	SPS-HDD, 40GB 7200 EIDE ATA-100		3SA72-261
2	SPS-HDD, EIDE 80GB 7200 ATA-100		3SA72-271
3	SPS-POWER SUPPLY, 250W	3SA72-001	
4	SPS-FANSINK, Celeron D 2.66GHz	3SA72-201	
4	SPS-FANSINK, P4, Prescott 2.8GHz	3SA72-211	
5	SPS-SYSTEM FAN (FOR P4 CPU ONLY)		3SA72-031
6	SPS-CPU, Celeron D 2.66	3SA72-221	
6	SPS-CPU, P4 2.8GHz, Prescott	3SA72-231	
6	SPS-CPU, P4 Northwood 3.0GHz	3SA72-241	
7	SPS-MOTHER BOARD	3SA72-011	
8	SPS-MOMORY, DDR 256MB PC3200		3SA72-251
9	SPS-WHU PACKAGING	3SA72-181	
10	SPS-RIGHT SIDE COVER(PAINT)		3SA72-161

Item	Parts listing	FRU	CRU
11	SPS-5.25" ODD BLANK BEZEL		3SA72-101
11	SPS-ODD/HDD Cable		3SA72-121
12	SPS-FDD		3SA72-021
12	SPS-FDD BEZEL ASSY	3SA72-081	
12	SPS-FDD BLANK BEZEL		3SA72-091
13	SPS-USB BOARD	3SA72-151	
13	SPS-USB CABLE ASSY		3SA72-141
14	SPS-BEZELASSY	2LB64-01	



Description: **A35 Tower 8139 Recovery CD**  
 Ship support date: A35 Tower 8139 03/01/2005  
 Owner: Robert Ferrier, T/L 441-0891

Change/Edit	FRU p/n	Description	Models
Add 13G	39J7402	US/UK/AP/TH XP-H Recovery CD	13G
Add 13G	39J7403	FR/CF XP-H Recovery CD	13G
Add 13G	39J7404	GR XP-H Recovery CD	13G
Add 13G	39J7405	SP/LA XP-H Recovery CD	13G
Add 13G	39J7406	IT XP-H Recovery CD	13G
Add 13G	39J7407	SV (Swedish) XP-H Recovery CD	13G
Add 13G	39J7408	DK XP-H Recovery CD	13G
Add 13G	39J7409	FI XP-H Recovery CD	13G
Add 13G	39J7410	NO XP-H Recovery CD	13G
Add 13G	39J7411	NL XP-H Recovery CD	13G
	30R4863	Korean XP-H Recovery CD	
	30R4868	Hong Kong-TC XP-H Recovery CD	
	30R4873	Taiwan-TC XP-H Recovery CD	
	30R4878	Japanese XP-H Recovery CD	
Add 13G	39J7412	HE XP-H Recovery CD	13G
Add 13G	39J7413	PL XP-H Recovery CD	13G
Add 13G	39J7414	CZ XP-H Recovery CD	13G
Add 13G	39J7415	AE XP-H Recovery CD	13G
Add 13G	39J7416	RU XP-H Recovery CD	13G
Add 13G	39J7417	TR XP-H Recovery CD	13G
Add 13G	39J7418	HU XP-H Recovery CD	13G
Add 13G	39J7419	PO XP-H Recovery CD	13G
Add 13G	39J7420	GK XP-H Recovery CD	13G
	rcdXPP_fr XP Pro		
Add 12U 12A 14A 15U	39J7241	US/UK/AP/TH XP-P Recovery CD	12U 12A 14A 15U
Add 16G	39J7242	FR/CF XP-P Recovery CD	16G
Add 16G	39J7243	GR XP-P Recovery CD	16G
Add 16G	39J7244	SP/LA XP-P Recovery CD	16G
Add 16G	39J7245	IT XP-P Recovery CD	16G
Add 16G	39J7246	SV (Swedish) XP-P Recovery CD	16G
Add 16G	39J7247	DK XP-P Recovery CD	16G
Add 16G	39J7248	FI XP-P Recovery CD	16G
Add 16G	39J7249	NO XP-P Recovery CD	16G
Add 16G	39J7250	NL XP-P Recovery CD	16G
	30R4842	Korea XP-P Recovery CD	
	30R4847	Hong Kong-TC XP-P Recovery CD	
	30R4852	Taiwan-TC XP-P Recovery CD	
	30R4857	Japanese XP-P Recovery CD	
Add 16G	39J7251	HE XP-P Recovery CD	16G
Add 16G	39J7252	PL XP-P Recovery CD	16G
Add 16G	39J7253	CZ XP-P Recovery CD	16G
Add 16G	39J7254	AE XP-P Recovery CD	16G
Add 16G	39J7255	RU XP-P Recovery CD	16G

Add 16G	39J7256	TR XP-P Recovery CD	16G
Add 16G	39J7257	HU XP-P Recovery CD	16G
Add 16G	39J7258	PO XP-P Recovery CD	16G
Add 16G	39J7259	GK XP-P Recovery CD	16G
Add 16G	39J7260	SL XP-P Recovery CD	16G

Model List			
MT	Model	Geography	
Add model	12U	US/Canadian English	
Add model	12A	ASEAN English	
Add model	13G	EMEA	
Add model	14A	ASEAN English	
Add model	15U	US/Canadian English	
Add model	16G	EMEA	

Country Code Matrix		
Suffix	Country	Geo
U	US/Canadian English	NA
F	Canadian French	NA
S	Spanish LV	LA
P	Portuguese	LA
L	LA English	LA
D	Spanish HV	LA
Y	APU Spanish HV	LA
G	EMEA	EMEA
A	ASEAN English	AP
Q	Indian English	AP
M	ANZ/ASEAN English (OEM)	AP
N	China English	AP
T	Thailand	AP
C	Simplified Chinese	AP
B	HK Traditional Chinese	AP
V	Taiwan Trad Chinese	AP
H	HK English	AP
K	Korean	AP
J	Japanese	AP
E	Japanese English	AP
O	CTO: NA & EMEA	CTO
R	Korean English	AP

# Chapter 3 Hardware Installation

## Considerations Prior to Installation

### Preparing Your Computer:

The motherboard contains numerous delicate electronic circuits and components which can become damaged as a result of electrostatic discharge (ESD). Thus, prior to installation, please follow the instructions below:

1. Please turn off the computer and unplug its power cord.
2. When handling the motherboard, avoid touching any metal leads or connectors.
3. It is best to wear an electrostatic discharge (ESD) cuff when handling electronic components(CPU, RAM).
4. Prior to installing the electronic components, please have these items on top of an antistatic pad or within a electrostatic shielding container.
5. Please verify that you the power supply is switched off before unplugging the power supply connector from the motherboard.

#### **Installation Notices:**

1. Prior to installation, please do not remove the stickers on the motherboard. These stickers are required for warranty validation.
2. Prior to the installation of the motherboard or any hardware, please first carefully read the information in the provided manual.
3. Before using the product, please verify that all cables and power connectors are connected.
4. To prevent damage to the motherboard, please do not allow screws to come in contact with the motherboard circuit or its components.
5. Please make sure there are no leftover screws or metal components placed on the motherboard or within the computer casing.
6. Please do not place the computer system on an uneven surface
7. Turning on the computer power during the installation process can lead to damage to system components as well as physical harm to the user.
8. If you are uncertain about any installation steps or have a problem related to the use of the product, please consult a certified computer technician.

## Exchange of the HDD



1. Using the screw drive remove the marked screw and set aside as shown



2. Remove two panels in both sides as shown

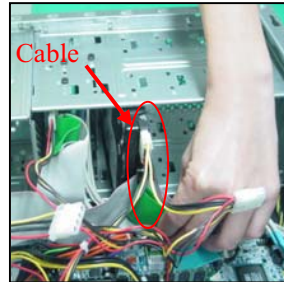

3. Remove the power of cable and the data of cable as shown

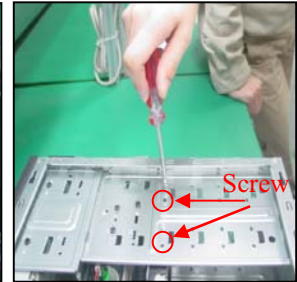

4. Using the screw drive remove the marked screw and set aside as shown.

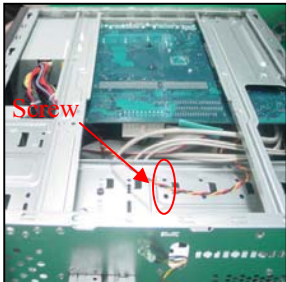

5. Using the screw drive remove the marked screw and set aside..

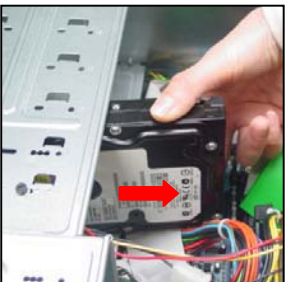

6. Gently remove the HDD from the bracket as the shown direction. Then gently assemble the HDD into the bracket



7. Using the screw drive assemble of the marked screw as shown.

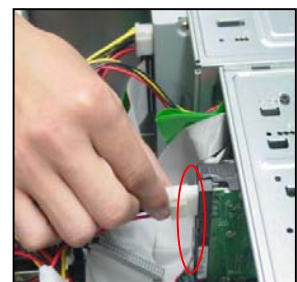

8. Gently plug into the power of cable and the data of the cable as shown.



9. Assemble of the two panels in both sides as the shown, then using screw drive assemble of the screw.

## Exchange of the ODD

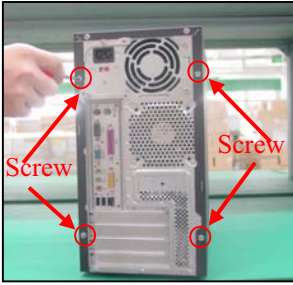

1. Using the enclosed magnetic screw-drive, remove the marked screw and set aside as shown



2. Remove the two panels in both sides as shown

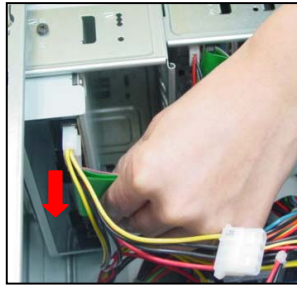

3. Gently remove the data of cable and the power of the cable as shown.

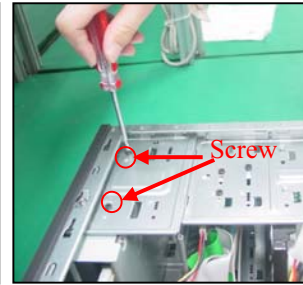

4. Using the screw drive remove the marked screw and set aside.

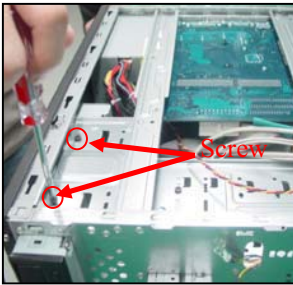

5. Using the screw drive remove the marked screw and set aside.



6. Gently remove the ODD from the bracket as shown



7. Gently assemble of the ODD into the bracket as shown direction.

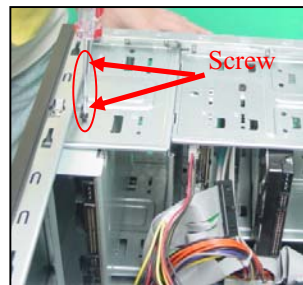

8. Using the screw drive assemble of the screw.

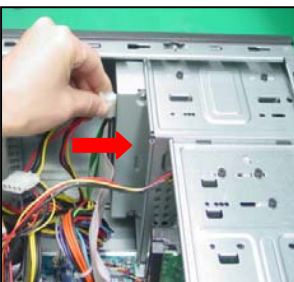

9. Gently plug into the power of cable and the data of the cable as shown.



10. Assemble of the two panels in both sides as shown, then using screw drive assemble of the screw.

## Exchange of the FDD



1. Using the screw drive remove the marked screw and set aside.



2. Remove the two panels in both sides as shown



3. Gently remove the data of cable and the power of the cable as shown.

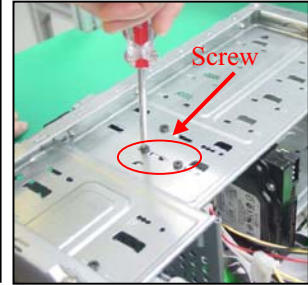

4. Using the screw-drive remove the marked screw and set aside

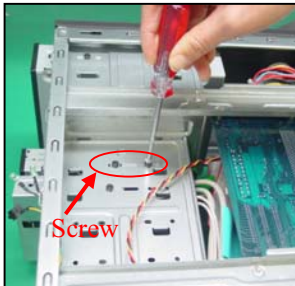

5. Using the screw-drive, remove the marked screw and set aside as shown

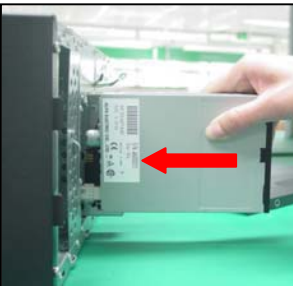

6. Gently remove the FDD from the bracket, then gently plug the FDD into the bracket as shown.

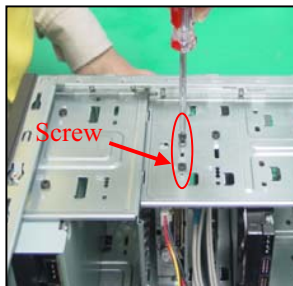

7. Using the screw drive assemble of the screw, then plug into the data of cable and the power of cable.



8. Assemble of the two panels in both sides as shown, then using screw drive assemble of the screw.

## Installation of the CPU and Heat-sink

Before installing the CPU, please comply with the following conditions:

1. Please make sure that the motherboard supports the CPU.
2. Please take note of the one indented corner of the CPU. If you install the CPU in the wrong direction, the CPU will not insert properly. If this occurs, please change the insert direction of the CPU.
3. Please add an even layer of heat sink paste between the CPU and heat-sink.
4. Please make sure the heat-sink is installed on the CPU prior to system use, otherwise overheating and permanent damage of the CPU may occur.
5. Please set the CPU host frequency in accordance with the processor specifications. It is not recommended that the system bus frequency be set beyond hardware specifications since it does not meet the required standards for the peripherals. If you wish to set the frequency beyond the proper specifications, please do so according to your hardware specifications including the CPU, graphics card, memory, hard drive, etc.

HT functionality requirement content :

Enabling the functionality of Hyper-Threading Technology for your computer system requires all of the following platform components:

- CPU: An Intel® Pentium 4 Processor with HT Technology
- Chipset: An SiS® Chipset that supports HT Technology
- BIOS: A BIOS that supports HT Technology and has it enabled
- OS: An operation system that has optimizations for HT Technology

## Installation of the CPU

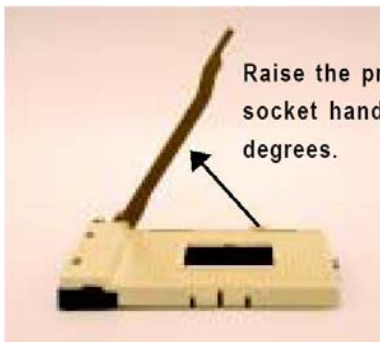

1. Raise the processor socket handle to 65 degrees. You may feel a kind of tight



2. Raise the processor socket handle all the way up to a fully raised position (around 90 degrees) till you hear a "click."





3. Locate the Pin One Indicator on the processor.

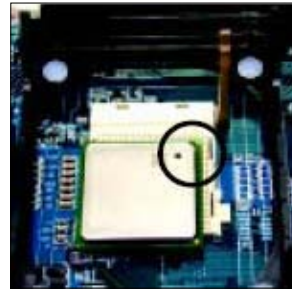

4. Locate Pin One in the socket and look for a (golden) cut edge on the CPU upper corner. Then insert the CPU into the socket and close the socket handle

### Installation of the heat-sink



1. Push down the cooler clip to secure to the retention mechanism hooks for all four corners.

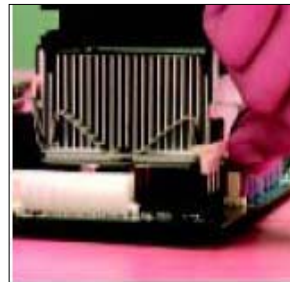

2. Plug the cooler power cable into the CPU fan connector on the motherboard.

### Note:

1. Please use Intel® approved cooling fan.
2. We recommend you to apply the thermal tape to provide better heat conduction between your CPU and heat-sink. (The CPU cooling fan might stick to the CPU due to the hardening of the thermal paste. During this condition if you try to remove the cooling fan, you might pull the processor out of the CPU socket along with the cooling fan, and might damage the processor. To avoid this from happening, we suggest you to either use thermal tape instead of thermal paste, or remove the cooling fan with extreme caution.)
3. Make sure the CPU fan power cable is plugged in to the CPU fan connector this completes the installation.
4. Please refer to CPU heat sink user's manual for more detail installation procedure



## Installation of Memory

Before installing the memory modules, please comply with the following conditions:

1. Please make sure that the memory used is supported by the mother-board. It is recommended that memory of similar capacity, specifications and brand be used.
2. Before installing or removing memory modules, please make sure that the computer power is switched off to prevent hardware damage.
3. Memory modules have a foolproof insertion design. A memory module can be installed in only one direction.
4. If you are unable to insert the module, please switch the direction.

The motherboard has 2 dual inline memory module (DIMM) sockets. The BIOS will automatically detect memory type and size. To install the memory module, just push it vertically into the DIMM socket. The DIMM module can only fit in one direction due to the notch. Memory size can vary between sockets.

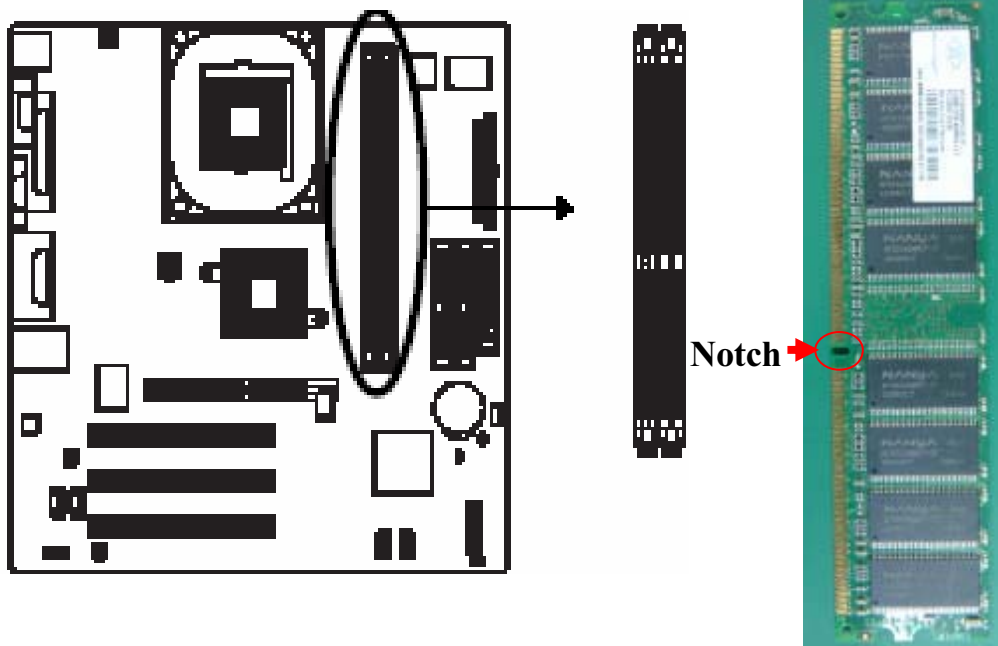

1. The DIMM socket has a notch, so the DIMM memory module can only fit in one direction. Insert the DIMM memory module vertically into the DIMM socket. Then push it down.

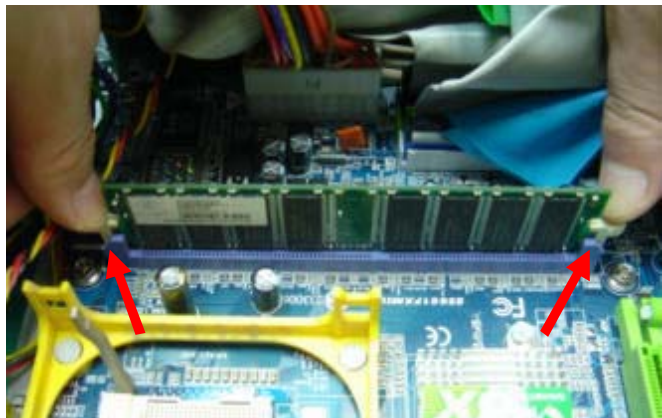

2. Close the plastic clip at both edges of the DIMM sockets to lock the DIMM module. Reverse the installation steps when you wish to remove the DIMM module.



## Installation of Expansion Cards

You can install your expansion card by following the steps outlined below:

1. Read the related expansion card's instruction document before installing the expansion card into the computer.
2. Remove your computer's chassis cover, screws and slot bracket from the computer.
3. Press the expansion card firmly into expansion slot in motherboard.
4. Be sure the metal contacts on the card are indeed seated in the slot.
5. Replace the screw to secure the slot bracket of the expansion card.
6. Replace your computer's chassis cover.
7. Power on the computer, if necessary, setup BIOS utility of expansion card from BIOS.
8. Install related driver from the operating system.

Installing a AGP expansion card:



Please carefully pull out the small white-draw able bar at the end of the AGP slot when you try to install/uninstall the VGA card. Please align the VGAcards to the onboard AGP slot and press firmly down on the slot. Make sure your VGA card is locked by the small white-draw able bar.

AGP Card

# I/O Back Panel Introduction

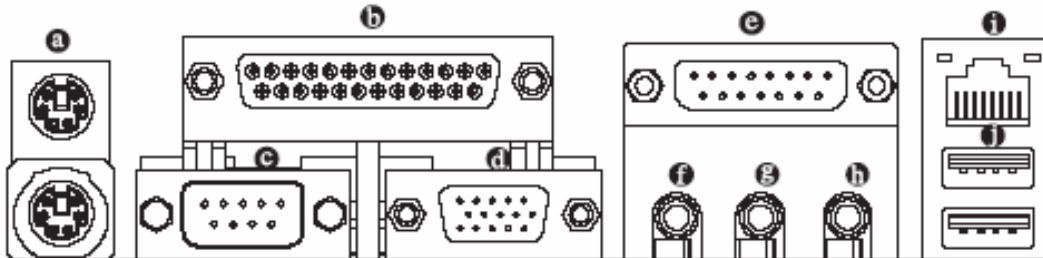

## a. PS/2 Keyboard and PS/2 Mouse Connector

To install a PS/2 port keyboard and mouse, plug the mouse to the upper port (green) and the keyboard to the lower port (purple).

## b. Parallel Port

The parallel port allows connection of a printer, scanner and other peripheral devices.

## c. Serial Port (COMA)

Devices like mouse, modems, and etc. can be connected to Serial port.

## d. VGA Port

Monitor can be connected to VGA port.

## e. Game/MIDI Port

This connector supports joystick, MIDI keyboard and other related audio devices.

## f. Line Out (Front Speaker Out)

Connect the stereo speakers, earphone or front surround channels to this connector.

## g. Line In

Devices like CD-ROM, walkman etc. can be connected to Line In jack.

## h. MIC In

Microphone can be connected to MIC In jack.

## i. LAN Port

The LAN port provides Internet connection.

## j. USB port

Before you connect your device(s) into USB connector(s), please make sure your device(s) such as USB keyboard, mouse, scanner, zip, speaker...etc. have a standard USB interface. Also make sure your OS supports USB controller. If your OS does not support USB controller, please contact OS vendor for possible patch or driver upgrade. For more information please contact your OS or device(s) vendors.

# Connectors Introduction

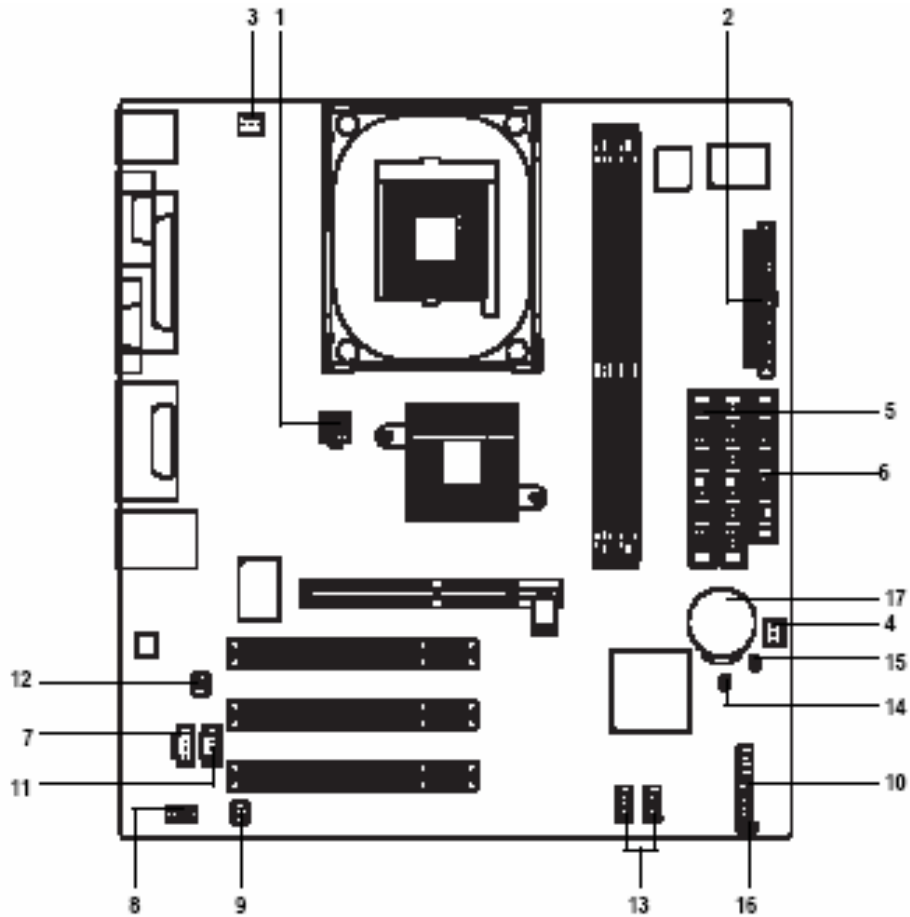

- |              |                   |
|--------------|-------------------|
| 1) ATX_12V   | 10) F_PANEL       |
| 2) ATX       | 11) CD_IN         |
| 3) CPU_FAN   | 12) SPDIF_IO      |
| 4) SYS_FAN   | 13) F_USB1/F_USB2 |
| 5) IDE1/IDE2 | 14) CI            |
| 6) FDD       | 15) CLR_CMOS      |
| 7) AUX_IN    | 16) PWR_LED       |
| 8) F_AUDIO   | 17) BAT           |
| 9) SUR_CEN   |                   |

## 1/2) ATX\_12V/ATX (Power Connector)

With the use of the power connector, the power supply can supply enough stable power to all the components on the motherboard. Before connecting the power connector, please make sure that all components and devices are properly installed. Align the power connector with its proper location on the motherboard and connect tightly.

The ATX\_12V power connector mainly supplies power to the CPU. If the ATX\_12V power connector is not connected, the system will not start.

### Caution:

Please use a power supply that is able to handle the system voltage requirements. It is recommended that a power supply that can withstand high power consumption be used (300W or greater). If a power supply is used that does not provide the required power, the result can lead to an unstable system or a system that is unable to start.

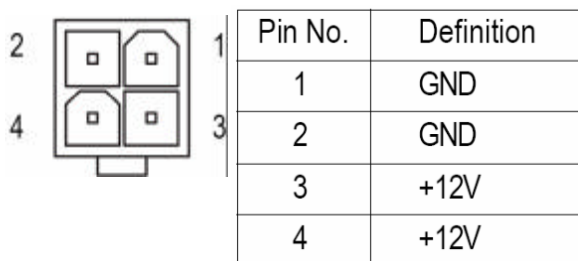
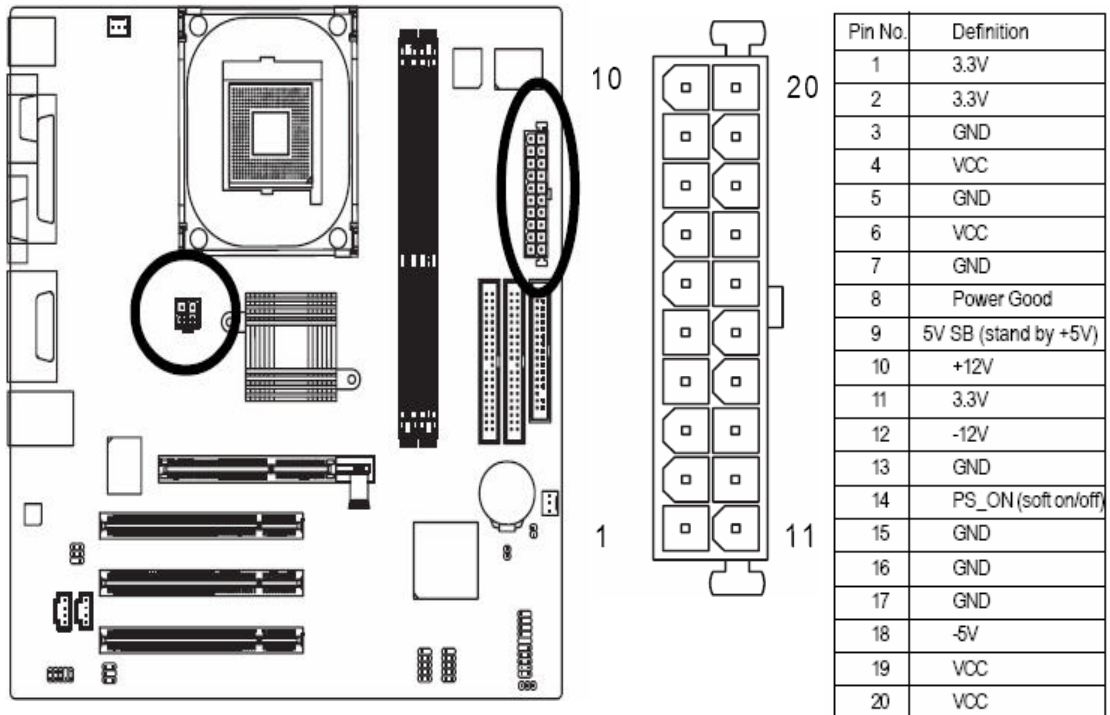

### 3/4 CPU\_FAN / SYS\_FAN (Cooler Fan Power Connector)

The cooler fan power connector supplies a +12V power voltage via a 3-pin power connector and possesses a fool-proof connection design.

Most coolers are designed with color-coded power connector wires. A red power connector wire indicates a positive connection and requires a +12V power voltage. The black connector wire is the ground wire (GND).

#### Caution:

Please remember to connect the power to the cooler fan to prevent system overheating and failure. Please remember to connect the power to the CPU fan to prevent CPU overheating and failure.

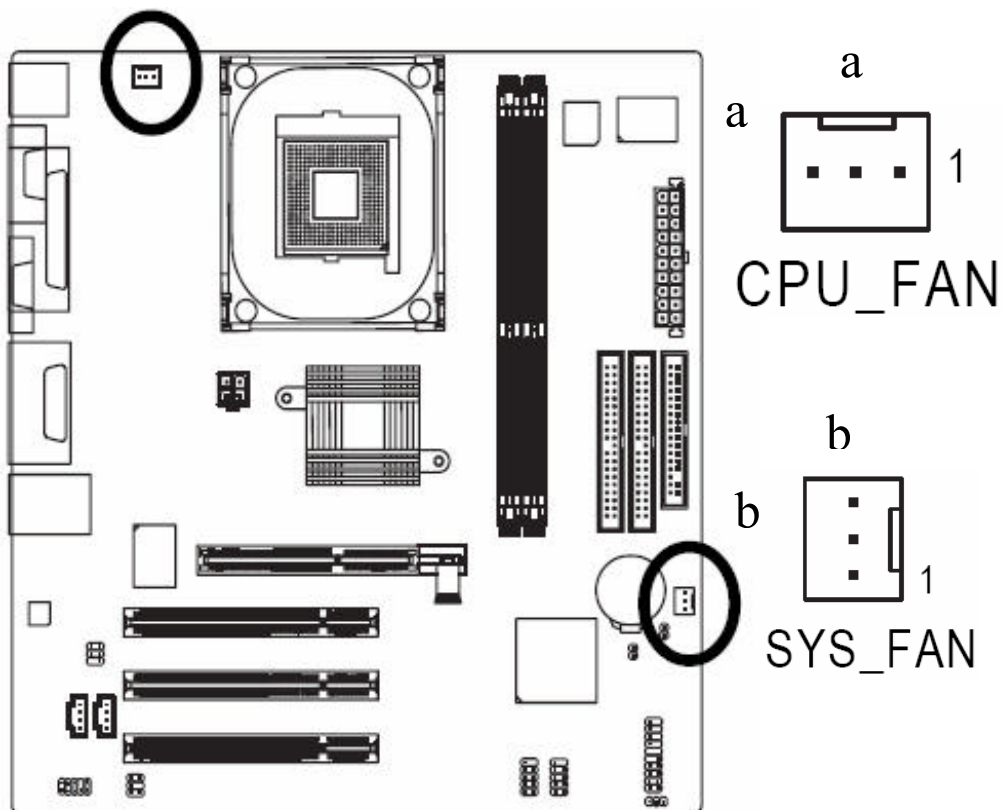

Pin No.	Definition
1	GND
2	+12V
3	Sense



## 5) IDE1/IDE2 (IDE Connector)

An IDE device connects to the computer via an IDE connector. One IDE connector can connect to one IDE cable, and the single IDE cable can then connect to two IDE devices (hard drive or optical drive). If you wish to connect two IDE devices, please set the jumper on one IDE device as Master and the other as Slave (for information on settings, please refer to the instructions located on the IDE device).

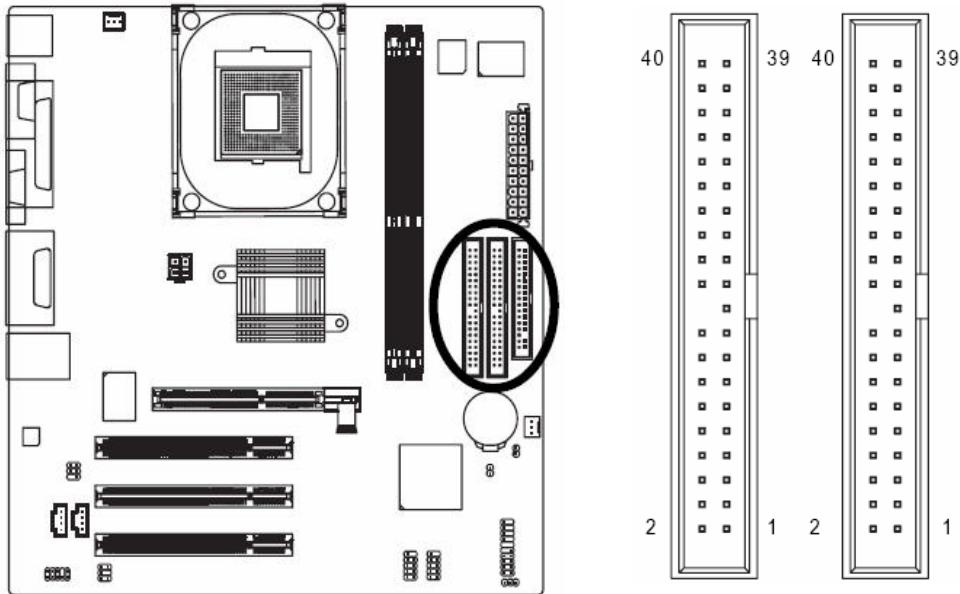

## 6) FDD (FDD Connector)

The FDD connector is used to connect the FDD cable while the other end of the cable connects to the FDD drive. The types of FDD drives supported are: 360KB, 720KB, 1.2MB, 1.44MB and 2.88MB. Please connect the red power connector wire to the pin1 position.

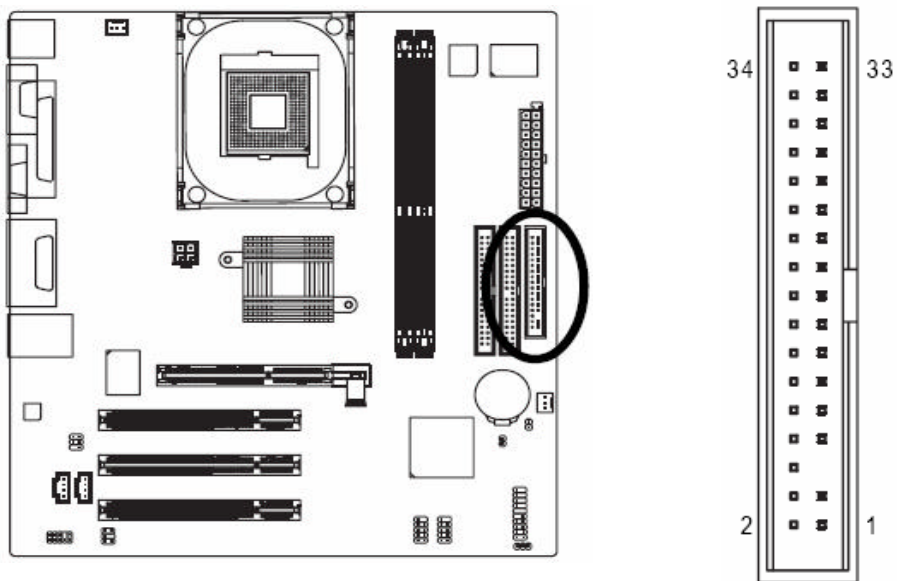

## 7) AUX\_IN (AUX In Connector)

Connect other device (such as PCI TV Tuner audio out) to the connector.

Pin No.	Definition
1	AUX-L
2	GND
3	GND
4	AUX-R

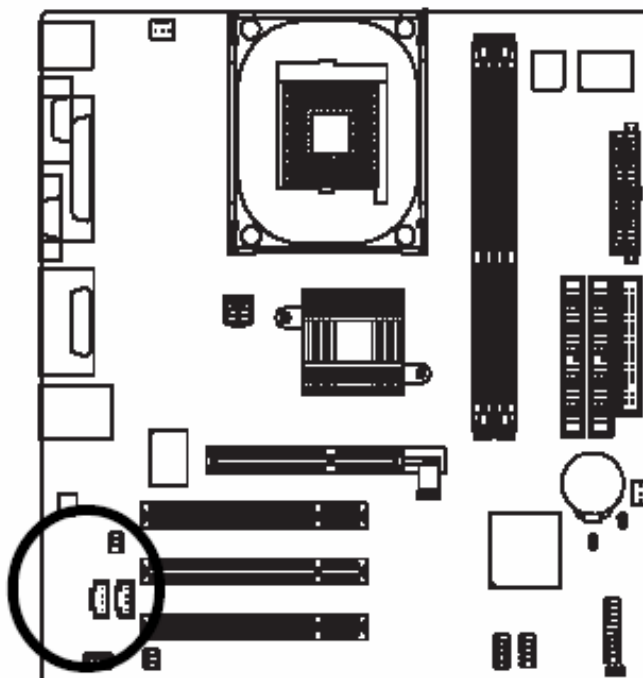

## 8) F\_AUDIO (Front Audio Panel Connector)

Please make sure the pin assignment on the cable is the same as the pin assignment on the MB header. To find out if the chassis you are buying support front audio panel connector, please contact your dealer. If you want to use "Front Audio" connector, you must remove the jumpers from pins 5-6,9-10.

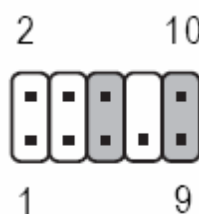
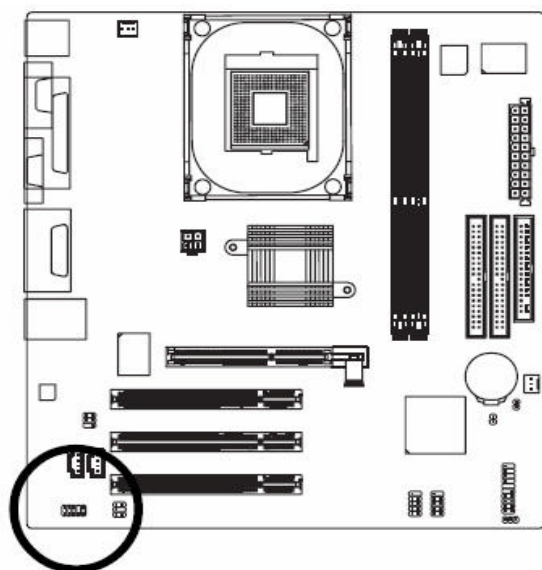

Pin No.	Definition
1	MIC
2	GND
3	REF
4	POWER
5	Front Audio (R)
6	Rear Audio (R)
7	Reserved
8	No Pin
9	Front Audio (L)
10	Rear Audio (L)



### 9) SUR\_CEN

Please contact your nearest dealer for optional SUR\_CEN cable.

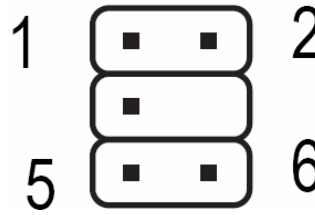
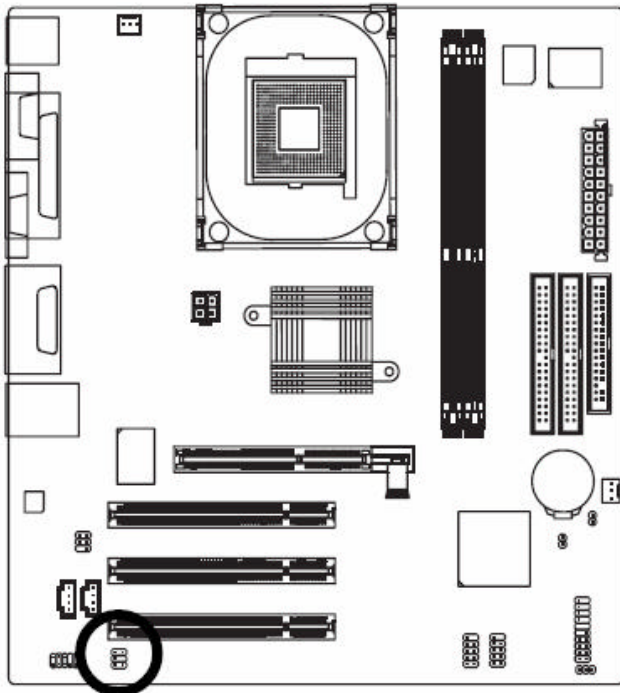

Pin No.	Definition
1	SUR OUTL
2	SUR OUTR
3	GND
4	No Pin
5	CENTER_OUT
6	BASS_OUT

### 10) CD\_IN (CD IN Connector)

Connect CD-ROM or DVD-ROM audio out to the connector.

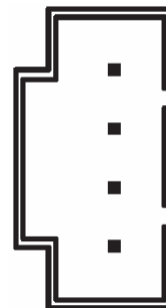
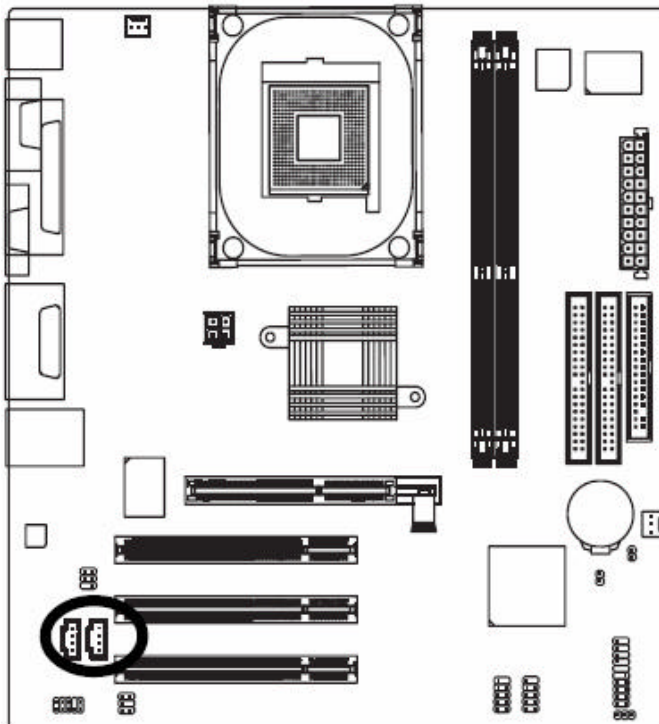

Pin No.	Definition
1	CD-L
2	GND
3	GND
4	CD-R

## 11) F\_PANEL (Front Panel Connector)

Please connect the power LED, PC speaker, reset switch and power switch etc. of your chassis front panel to the F\_PANEL connector according to the pin assignments below.

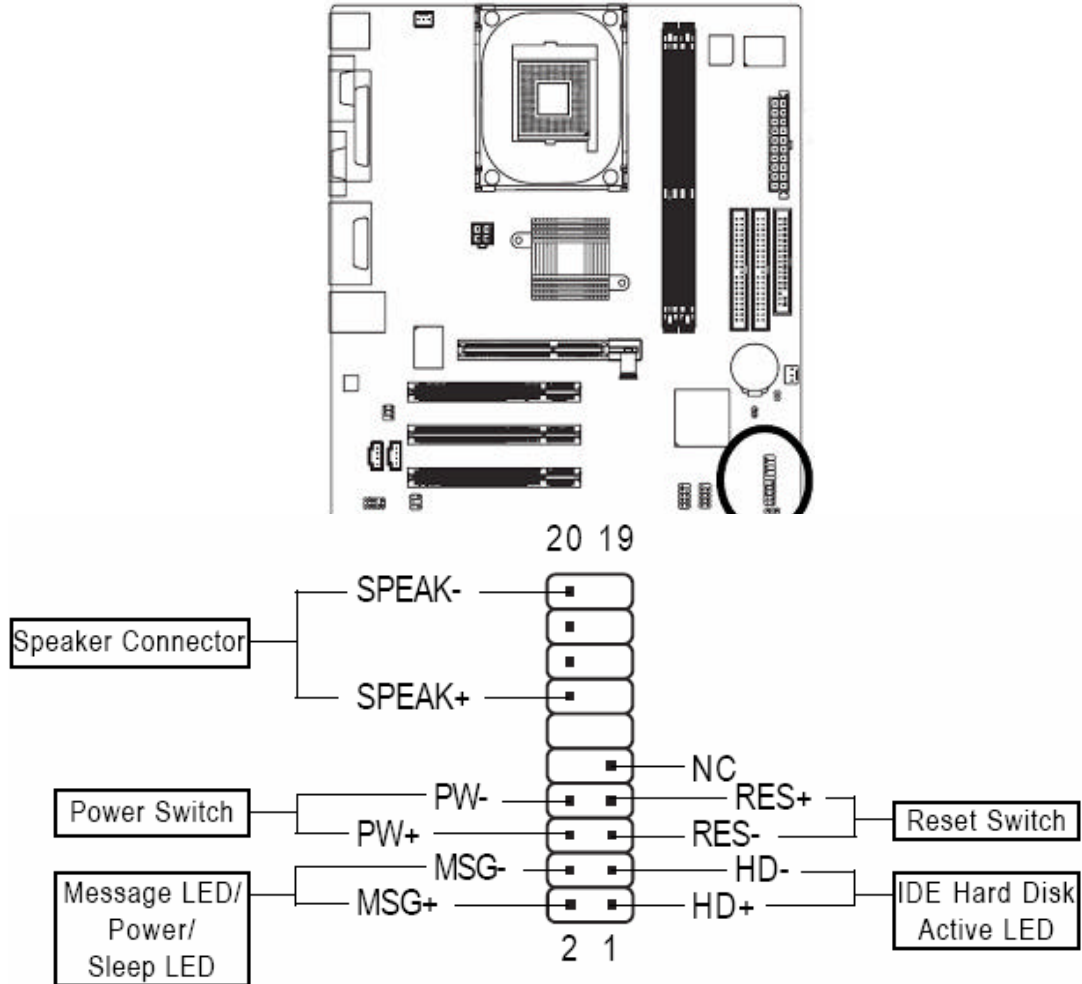

HD (IDE Hard Disk Active LED)	Pin 1: LED anode(+) Pin 2: LED cathode(-)
SPEAK (Speaker Connector)	Pin 1: VCC(+) Pin 2- Pin 3: NC Pin 4: Data(-)
RES (Reset Switch)	Open: Normal Operation Close: Reset Hardware System
PW (Power Switch)	Open: Normal Operation Close: Power On/Off
MSG (Message LED/Power/Sleep LED)	Pin 1: LED anode(+) Pin 2: LED cathode(-)
NC	NC

## 12) SPDIF\_IO (SPDIF In/ Out)

The SPDIF output is capable of providing digital audio to external speakers or compressed AC3 data to an external Dolby Digital Decoder. Use this feature only when your stereo system has digital input function. Use SPDIF IN feature only when your device has digital output function. Be careful with the polarity of the SPDIF\_IO connector. Check the pin assignment carefully while you connect the SPDIF\_IO cable. Incorrect connection between the cable and connector will make the device unable to work or even damage it. For optional SPDIF\_IO cable, please contact your local dealer.

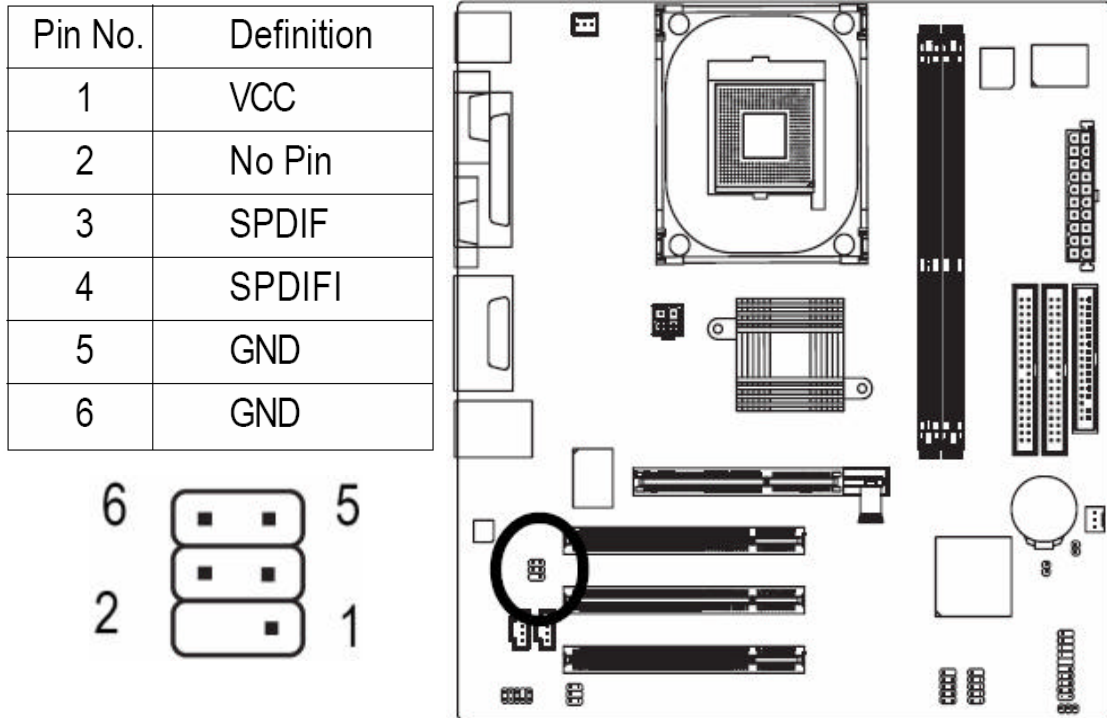

## 13) F1\_USB / F2\_USB (Front USB Connectors)

Be careful with the polarity of the front USB connector. Check the pin assignment carefully while you connect the front USB cable, incorrect connection between the cable and connector will make the device unable to work or even damage it. For optional front USB cable, please contact your local dealer.

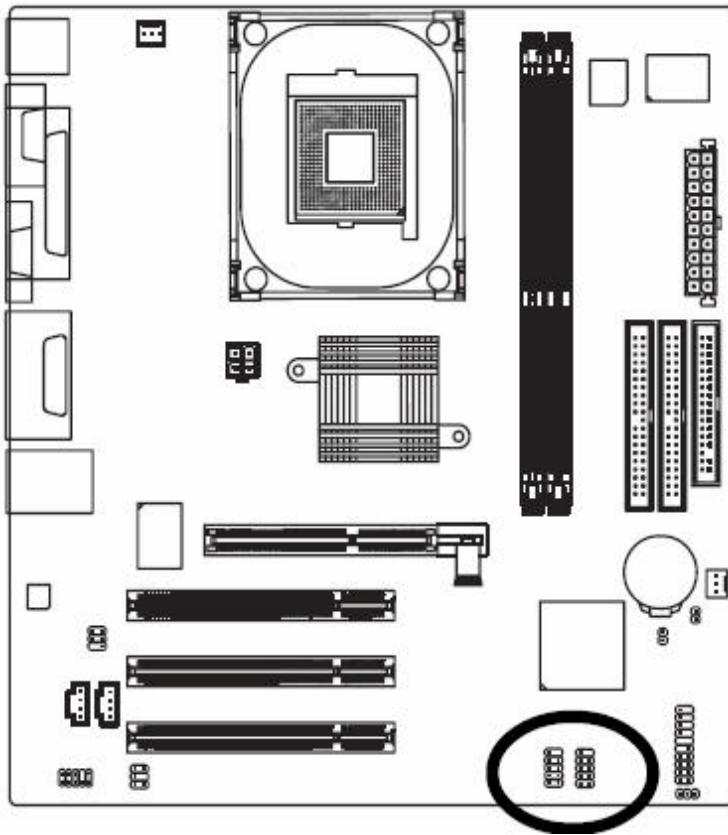

Pin No.	Definition
1	Power
2	Power
3	USB0 DX-
4	USB1 Dy-
5	USB0 DX+
6	USB1 Dy+
7	GND
8	GND
9	No Pin
10	NC

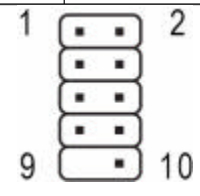

#### 14) CI (Chassis Intrusion, Case Open)

This 2-pin connector allows your system to detect if the chassis cover is removed. You can check the "Case Open" status in BIOS Setup.

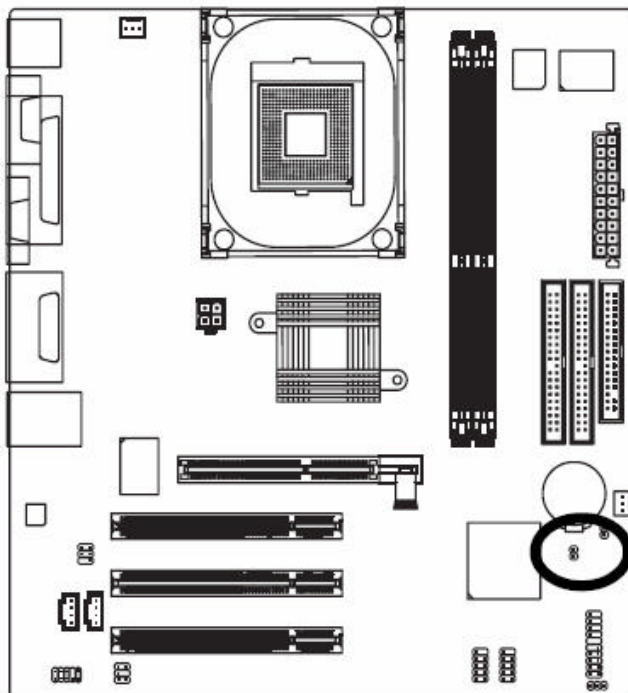

Pin No.	Definition
1	Signal
2	GND



### 15) CLR\_CMOS (Clear CMOS)

You may clear the CMOS data to its default values by this jumper. To clear CMOS, temporarily short pins 1-2. To prevent improper use of this header, we do not include a jumper on it.

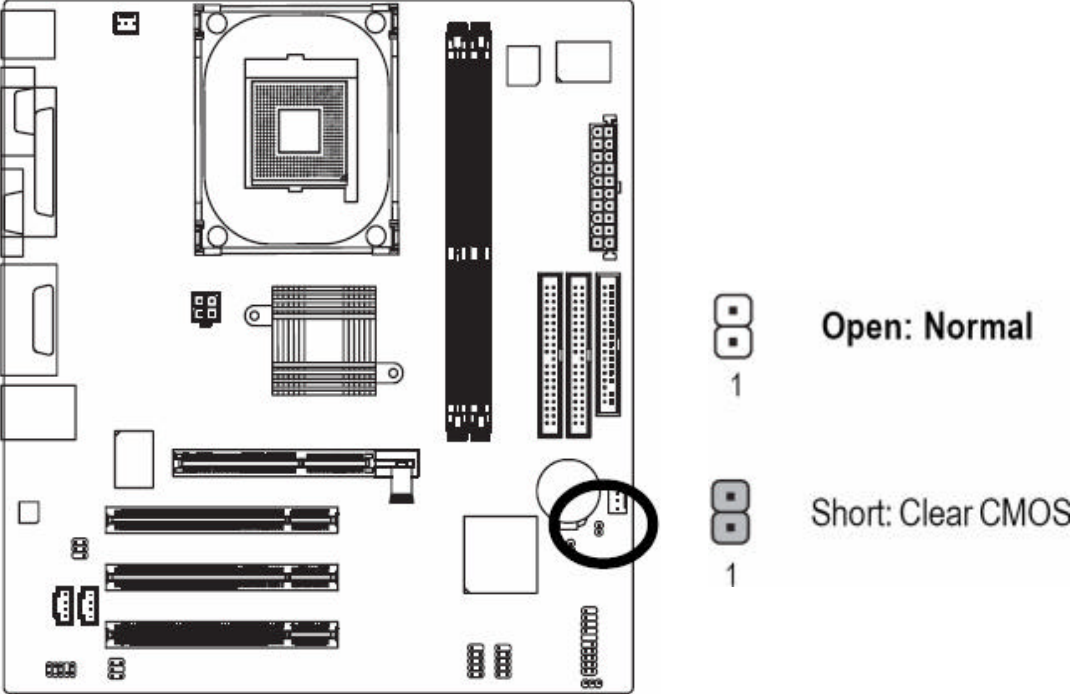

### 16) PWR\_LED

PWR\_LED is connected with the system power indicator to indicate whether the system is on/off. It will blink when the system enters suspend mode.

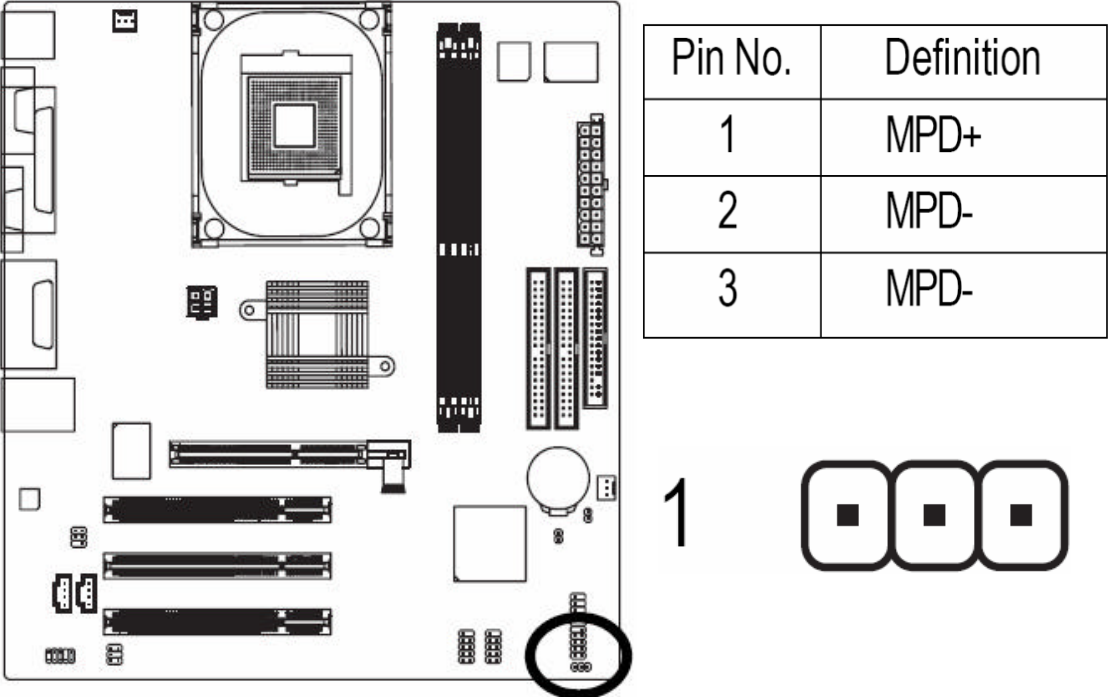

## 17) BAT (Battery)

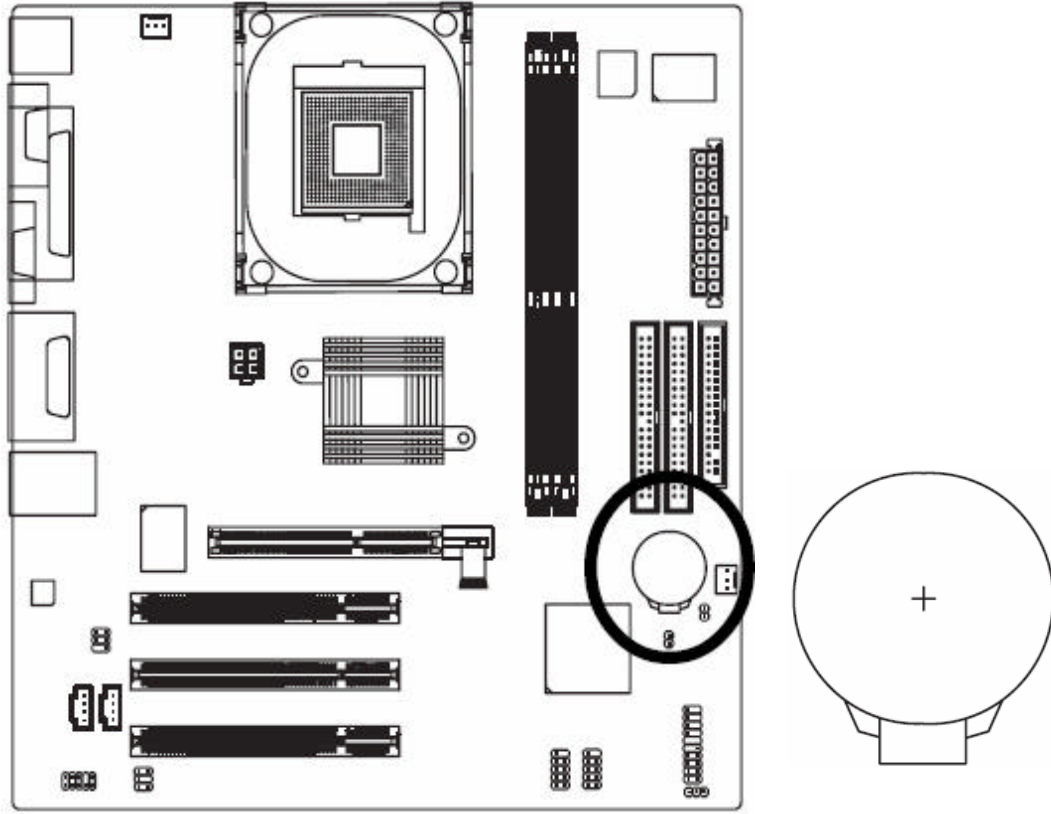

- Danger of explosion if battery is incorrectly replaced.
- Replace only with the same or equivalent type recommended by the manufacturer.
- Dispose of used batteries according to the manufacturer's instructions.

### If you want to erase CMOS...

1. Turn off the computer and unplug the power cord.
2. Remove the battery and wait for 30 seconds.
3. Re-install the battery.
4. Plug the power cord and turn on the computer.

# Chapter 4 BIOS Specification and Setup

## 1. PRODUCT SUMMARY

- $\mu$ ATX compliant form factor
- Supports the following Intel processors:
  - 400MHz/533MHz/800MHz Front Side Bus
  - Intel Pentium 4 Northwood-478 family processors
  - Intel Pentium 4 Prescott-478 family processors
  - Intel Celeron family processors
- SiS661FXHost/Memory Controller
  - Built-in a high performance 256-bit 3D GPU
  - Programmable shared frame buffer size 32MB or 64MB for display memory
- I/O Controller Hub (SiS963L)
- 4Mb Flash ROM
  - BIOS update in MS-DOS supported
  - BIOS update in Windows supported
- IDE interface:
  - Dual IDE Master/Slave Controller
  - PIO Mode 0,1,2,3,4 and Multiword DMA Mode 0,1,2
  - Ultra DMA 33/66/100/133
  - ATA/ATAPI 48-bit addressing compliance and support greater than 137Gbytes device
- FDD interface:
  - Support one 360K/720K/1.2M/1.44M/2.88M floppy disk
- AGP interface supported:
  - The external AGP slot with AGP 4X/8X capability
- System memory:
  - 2 DIMM sockets
  - DDR266/333/400 MHz module supported
  - Up to 2 un-buffered DIMM DDR400
  - Up to 1 GB per DIMM with maximum memory size up to 2GB
- PCI interface:
  - 3 PCI request-grant pairs for support of 3 PCI Bus Masters ( $\mu$ ATX)
  - Complies to PCI Specification Rev. 2.3
- 2 Independent OHCI USB 1.1 Host controllers and 1 EHCI USB 2.0 Host Controllers, support up to 6 Ports
- Audio Options:
  - AC'97 Specification v2.2 compliant audio
  - Real-tek ALC655 5.1 interface

- RTL8100C LAN(10/100 mbit)
- ITE IT8705AF super I/O with Hardware monitor supported
- Support ACPI S0,S1,S3,S4, and S5 power state for supported operating systems
- ACPI 1.0b, ACPI 2.0, APM 1.2, PnP 1.0a, SMBIOS 2.3.4, WFM 2.0, USB 1.1, USB 2.0 Compliance.

## 2. BIOS REQUIREMENT

### 2.1 Standard BIOS Feature

- Phoenix Award BIOS
- Intel 478 P4-Celeron and Prescott processor detection and initialization
- SiS661-FX chipset initialization modules, Sis memory sizing reference code
- Auto-detect keyboard and mouse
- Auto-detect of off-board serial/parallel ports, floppy ports, IDE controllers with auto-configuration of on-board devices
- Auto-detect of IDE drive type installed
- High performance IDE controller support with ATA -5 features, including LBA mode for large hard drives, advanced PIO modes 3 & 4 for faster PCI IDE disk access. BIOS will automatically configure drives for highest performance. Performance options set up on a per-drive basis
- INT 13h extensions to support drives larger than 16GB
- Ultra DMA 33 Mode and Ultra ATA66/100/133 (33,66,100,133MB/s)
- ATAPI support for IDE CD-ROM and tape drives
- Support for 3 mode floppy devices for Japanese market
- LS-120 removable media support
- USB 1.1 and USB 2.0 compliance support (with support for legacy input devices)
- ACPI 1.0b and 2.0 compliance
- APM 1.2 compliance
- SMBIOS 2.3.4 compliance
- Wire For Management 2.0 (WFM) support
- Plug and Play 1.0a specification, support for Windows ‘95
- PCI add-in card auto-configuration, PCI 2.3 compliance
- AC power loss state retention management
- User and administrator mode for system setup screens with 2 separate password-protected accesses.
- Maximum of 2GB system memory
  - Two DIMM slots are provided for flexible memory configurations
  - BIOS will not initialize installed memory greater than 2GB
- Single or double-sided DIMM configurations
- Mixed speed DIMM configuration will default to the slowest speed DIMM installed.
- Suspend-to-RAM support
  - Wake from S3
  - Wake from S4
  - Wake from S5 for Onboard LAN.



## 2.2 Device Boot Support

- FDD Boot
- HDD Boot
- CDROM Boot
- PXE remote boot
- USB (removable media) boot
- USB Flash Boot (Support USB-HDD, USB-FDD and USD-ZIP standard)
- LS120 FDD Drive
- Parallel Zip Drive

## 2.3 Power Management

- Support APM and ACPI modes and all devices standby states as are listed bellow (Note S4 wake is OS dependent):

Devices	S1	S3	S4	S5
Power Button	✓	✓	✓	✓
PS2 Mouse/Keyboard	✓	✓	✓	✓
RTC Alarm	✓	✓	✓	✓
Ring-in	✓	✓	✓	✓
LAN	✓	✓	✓	✓
PME	✓	✓	✓	✓
USB device	✓	✓		

- Power LED Status State

System State	Dual Color Power LED State
S0	Green
S1	Blink in Green
S3	OFF
S4	OFF
S5	OFF

## 2.4 Hardware Monitor and PC Health Status Features

Hardware Monitor and Fan Speed Control Implementation in BIOS PC Health Status Menu

Voltage	Description
Vcore	CPU Voltage
VCC18	+1.8V
+12V	+12V
+5V	+5V
+3.3V	+3.3V

Temperature	Description
Sensor 1 Temp	CPU Temperature
Sensor 2 Temp	System Temperature
Snesor 3 Temp	N/A

Fan Speed	Description
FAN 1 Speed	CPU Fan
FAN 2 Speed	<a href="#">System Fan</a>
FAN 3 Speed	N/A

## 3. IBM Specific Features

### 3.1 F11/Enter Key

The F11 and Enter Keys cannot have any system specific function during boot. When the F11 or Enter Key is pressed during POST, The key press is saved and reported when Int 15h AX=4200h is called.

```
Int 15 Interface:
; Entry:          ax - 4200h
;
; Exit:          No Carry Flag - function supported
;                - AX = 0001 - F11/Enter was hit
;                - AX = 0000 - F11/Enter was not hit
;                Carry Flag - function not supported
```

#### **IBM Rescue and recovery with Rapid Restore**

IBM Rescue and Recovery with Rapid Restore program is on a separate hard drive partition

**Attention** Make sure all data is backed up to avoid loss when the IBM Rescue and Recovery with Rapid Restore program is used.

To start the program:

1. If your computer is already on when you start this procedure, shut down the operating system and turn off the computer.
2. Press and hold the F11 key then turn on the computer. When you hear multiple beeps, release the F11 key.

Notes:

- a. If you are using a USB keyboard and the IBM Setup Utility does not open using this method, press and release the F11 key repeatedly rather than holding it pressed when turning on the computer.
  - b. If a user password or an administrator password has been set, IBM Rescue and Recovery with Rapid Restore menu is not displayed until you type the password.
3. If you get a message asking which operating system to install, select the operating system, and press Enter.
  4. A message is displayed "Full Recovery :". Press Enter to select.
  5. On each of the next three windows, press the Y key
  6. Follow the prompts to complete the recovery.

#### **Restoring the pre-installed system**

When the hard disk drive is replaced because of a failure, no Product Recovery program is on the new hard disk. In this case, you must use the recovery CD for the computer. Order the recovery CD and the hard disk drive at the same time so that you can recover the new hard disk drive with the pre-installed software when they arrive. For information on which CD to order, see "Recovery CDs".

## **Recovery to Factory Contents by using Product Recovery CDs**

To create the service partition and install the factory contents from the recovery CD, do the following:

Note: The recovery process might take up to 2 hours.

1. Insert the recovery CD into the CD or DVD drive, then restart the computer
2. Following message is displayed:” Your computer originally included a Product Recovery program...Reinstall the Product Recovery program?(Y/N)[ ]”.
3. Press Y key. The service partition is created and loaded with the Product Recovery program files.
4. At next window, press Enter to continue.
  - a. The service partition is created. The system automatically reboots during this process.
  - b. The recovery process copies some files to the service partition, and PKUNZIP others.
  - c. Follow the prompts. You may be prompted to change CDs.
  - d. When the process is complete, the system reboots.

### **3.2 ROM-based setup**

Pressing the F1 key during POST will allow the user to enter the BIOS Setup Utility.

### **3.3 Boot Menu**

Pressing the F12 key during POST will allow the user to boot an alternate boot sequence.

### **3.4 Language**

ROM-based setup in system will support Dutch, English, French, German, Italian, Japanese, and Spanish.

### **3.5 IBM CORPORATION string must be in the BIOS**

In the address range E000:0000 to F000:FFF0, the following string must be imbedded: ‘IBM CORPORATION’ the hex equivalent is: 49 42 4D 20 43 4F 52 50 4F 52 41 54 49 4F 4E

### **3.6 Boot Time**

The BIOS shall hand off control of the system to the OS within the following time limits:

- S5->S0 10 seconds
- S4->S0 10 seconds
- S3->S0 0.5 seconds

### 3.7 IBM Logo Screen

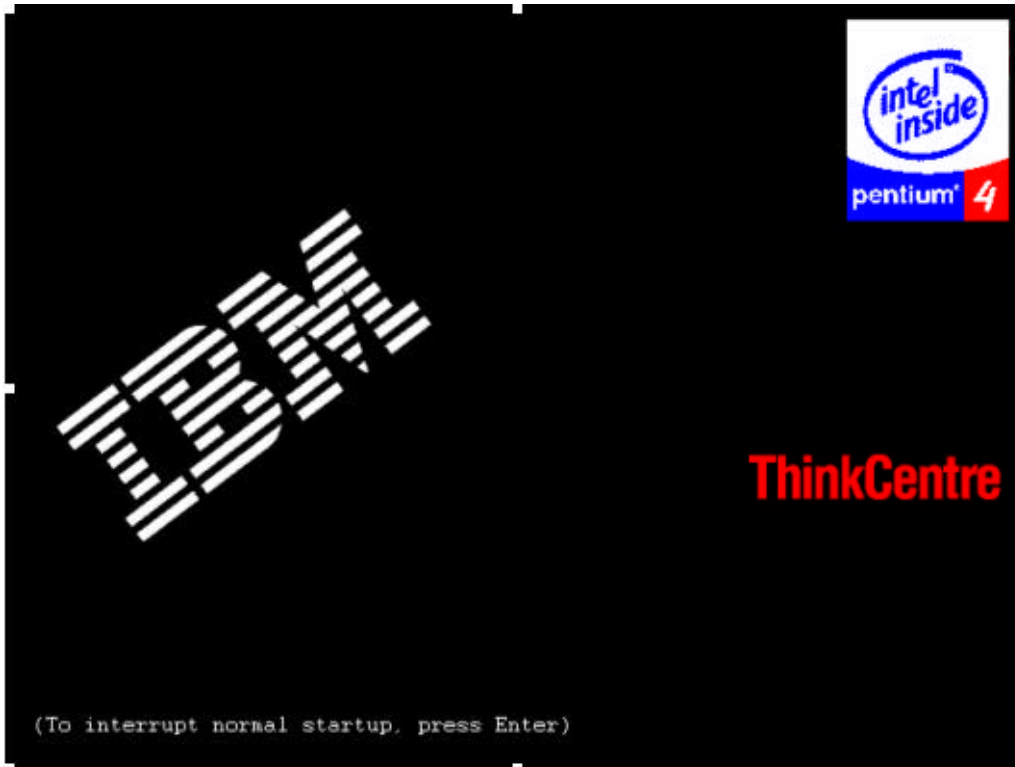

Figure 1: Sample POST IBM Logo Screen for a hyperthreading processor

Default IBM logo will be provided by IBM.

### 3.8 LogoScreen Text – translated into the user language

(To interrupt normal startup, press Enter)

### 3.9 Intel On-Screen-Branding Display

The badges for the current processor must be displayed according to the latest level Intel On-Screen Specification (minimum rev: 2.82).

### 3.10 Dummy SMI

When a soft SMI is issued with  $eax = 534Dxx20$  (where  $xx$  is any hex number), return  $80000000h$  in  $eax$ .

## 4. BIOS Error Messages

### 4.1 Beep Codes

- 1 short: System boots successfully
- 2 short: CMOS setting error
- 1 long 1 short: DRAM or M/B error
- 1 long 2 short: Monitor or display card error
- 1 long 3 short: Keyboard error
- 1 long 9 short: BIOS ROM error
- Continuous long beeps: DRAM error
- Continuous short beeps: Power error

### 4.2 POST Messages

<b>CMOS battery failed</b>	The CMOS battery is no longer functional. Contact your system dealer for a replacement battery.
<b>CMOS checksum error - Defaults loaded</b>	Checksum of CMOS is incorrect, so the system loads the default equipment configuration. A checksum error may indicate that CMOS has become corrupt. A weak battery may have caused this error. Check the battery and replace if necessary.
<b>CPU at nnnn</b>	Displays the running speed of the CPU.
<b>Press ESC to skip memory test</b>	The user may press Esc to skip the full memory test.
<b>HARD DISK INSTALL FAILURE</b>	Cannot find or initialize the hard drive controller or the drive. Make sure the controller is installed correctly. If no hard drives are installed, be sure the Hard Drive selection in Setup is set to NONE.
<b>Keyboard error or no keyboard present</b>	Cannot initialize the keyboard. Make sure the keyboard is attached correctly and no keys are pressed during POST. To purposely configure the system without a keyboard, set the error halt condition in Setup to HALT ON ALL, BUT KEYBOARD. The BIOS then ignores the missing keyboard during POST.
<b>Memory Test:</b>	This message displays during a full memory test, counting down the memory areas being tested.
<b>Memory test fail</b>	If POST detects an error during memory testing, additional information appears giving specifics about the type and location of the memory error.
<b>Press TAB to show POST screen</b>	System OEMs may replace the Phoenix Technologies' Award BIOS POST display with their own proprietary display. Including this message in the OEM display permits the operator to switch between the OEM display and the default POST display.

<b>Error: Non-System disk or disk error</b> <b>Replace and press any key when ready</b>	The BIOS was unable to find a suitable boot device. For Argali, this may mean an uninitialized or corrupt ATA flash

## 5. ROM-Based Setup

ROM-based setup is the standard Award BIOS setup with the following changes. The default values are print in bold type.

### 5.1 *Standard CMOS Features*

Data (mm:dd:yy)	Week, mm/dd/yyyy
Time (hh:mm:ss)	hh/mm/ss
IDE Primary Master	
IDE Primary Slave	
IDE Secondary Master	
IDE Secondary Slave	
Drive A	None 360K, 5.25" 1.2M, 5.25" 720K, 3.5" <b>1.44M, 3.5"</b> 2.88M, 3.5"
Drive B	<b>None</b> 360K, 5.25" 1.2M, 5.25" 720K, 3.5" 1.44M, 3.5" 2.88M, 3.5"
Floppy 3 Mode Support	<b>Disabled</b> Drive A Drive B Both
Halt On:	All Errors No Errors <b>All, But Keyboard</b> All, But Diskette All, But Disk/Key
Base Memory	<>
Extended Memory	<>
Total Memory	<>



## 5.2 Advanced BIOS Features

Hard Disk Boot Priority  
First Boot Device

**Floppy**  
LS120  
Hard Disk  
CDROM  
ZIP  
USB-FDD  
USB-ZIP  
USB-CDROM  
USB-HDD  
Legacy LAN  
Disabled

Second Boot Device

Floppy  
LS120  
LS120  
**Hard Disk**  
CDROM  
ZIP  
USB-FDD  
USB-ZIP  
USB-CDROM  
USB-HDD  
Legacy LAN  
Disabled

Third Boot Device

Floppy  
LS120  
Hard Disk  
CDROM  
**ZIP**  
USB-FDD  
USB-ZIP  
USB-CDROM  
USB-HDD  
Legacy LAN  
Disabled

Boot Other Device  
Boot Up Floppy Seek  
Password Check  
CPU Hyper-Threading

Disabled/**Enabled**  
**Disabled**/Enabled  
**Setup**/System  
Disabled/**Enabled**  
*Note: Controlled by CPU type.*  
Enabled/**Disabled**

Limit CPUID Max. to 3

Full screen LOGO Show  
 Intel Onscreen Branding  
 Flexible AGP 8x  
 Init Display First

*Note: Controlled by CPU type.*

Disabled/**Enabled**  
 Disabled/**Enabled**  
**Auto**/4X  
**PCI/AGP**

### 5.3 Integrated Peripherals

IDE1 Conductor Cable

Auto  
 ATA66/100/133  
 ATA33

IDE2 Conductor Cable

Auto  
 ATA66/100/133  
 ATA33

On-Chip Primary PCI IDE  
 On-Chip Secondary PCI IDE  
 AC97 Audio  
 USB Controller  
 USB Legacy Support  
 Onboard LAN device  
 Onboard LAN Boot ROM

Disabled/**Enabled**  
 Disabled/**Enabled**  
**Enabled**/Disabled  
 Disabled/**Enabled**  
**Disabled**/Enabled  
**Enabled**/Disabled  
 Disabled/**Enabled**

Onboard Serial Port 1

Disabled  
**3F8/IRQ4**  
 2F8/IRQ3  
 3E8/IRQ4  
 2E8/IRQ3  
 Auto

Onboard Parallel Port

Disabled  
**378/IRQ7**  
 278/IRQ5  
 3BC/IRQ3

Parallel Port Mode

SPP  
 EPP  
**ECP**  
 ECP+EPP

ECP Mode Use DMA

1/3

Game Port Address

Disabled/**201**/209

Midi Port Address **Disabled/330/300**

Midi Port IRQ **5/10**

#### 5.4 *Power Management Setup*

ACPI Suspend Type **S1(POS)/ S3(STR)**  
Soft-off by PWR\_BTTN **Off/Suspend**  
System after AC Back **Off/On/Last State**  
IRQ[3-7,9-15],NMI **Disabled/Enabled**  
Modem Ring On **Disabled/Enabled**  
PME Event Wake Up **Disabled/Enabled**  
Power On by Keyboard **Any Key/Password/Disabled**  
Power On by Mouse **Enabled/Disabled**  
Resume by Alarm **Disabled/Enabled**  
Month Alarm  
Date (of Month)  
Time(hh:mm:ss)

Power LED in S1 State **Blinking**  
Dual/OFF

#### 5.5 *PnP/PCI Configurations*

PCI 1 IRQ Assignment **Auto**  
3,4,5,9,10,11,12,14,15  
PCI 2 IRQ Assignment **Auto**  
3,4,5,9,10,11,12,14,15  
PCI 3 IRQ Assignment **Auto**  
3,4,5,9,10,11,12,14,15

#### 5.6 *PC Health Status*

Reset Case Open Status **Disabled/Enabled**  
Case Opened **NO/YES**  
V-core **<**  
VCC18 **<**  
+3.3V **<**  
+5V **<**  
+12V **<**  
Current System Temperature **<**  
Current CPU Temperature **<**  
Current CPU FAN Speed **<**  
Current SYSTEM FAN Speed **<**  
CPU Smart FAN Control **Enabled/Disabled**  
System Smart FAN Control **Enabled/Disabled**

### 5.7 Top Performance

Disabled  
Enabled

### 5.8 Select Language

English  
Francais  
Deutsch  
Espanol  
Dutch(TBD)  
Italian(TBD)  
日本語

## 6. BIOS Setup

### 6-1 Standard CMOS Features

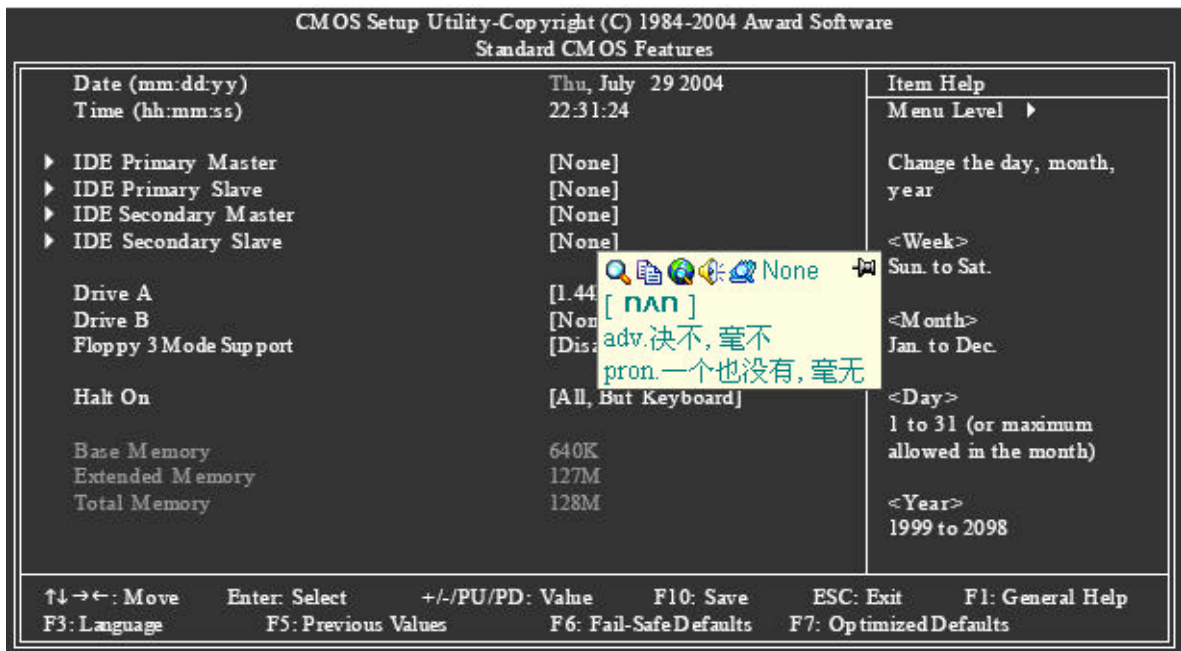

#### Date

The date format is <week>, <month>, <day>, <year>.

1. Week: The weekday, from Sun. to Sat., is determined by the BIOS and displayed only.
2. Month: The month, from Jan. to Dec.
3. Day: The date, from 1 to 31 (or the maximum allowed in the month).
4. Year: The year, from 1999 through 2098.

#### Time

The times format in <hour> <minute> <second>. The time is calculated based on the 24-hour military-time clock. For example, 1 p.m. is 13:00:00.

#### IDE Primary Master, Slave /IDE Secondary Master, Slave

1. IDE HDD Auto-Detection: Press "Enter" to select this option for automatic device detection.
2. IDE Primary/Secondary Master(Slave) setup: You can use one of the three methods below:
  - Auto Allows BIOS to automatically detect IDE devices during POST. (Default value)
  - None Select this if no IDE devices are used and the system will skip the automatic detection step and allow for faster system start up.
  - Manual User can manually input the correct settings
3. Access Mode: Use this to set the access mode for the hard drive. The four options are: CHS/LBA/Large/Auto (Default:Auto)

4. Capacity: Capacity of currently installed hard disk.  
Hard drive information should be labeled on the outside drive casing.  
Enter the appropriate option based on this information.
5. Cylinder: Number of cylinders
6. Head: Number of heads
7. Precomp: Write precomp
8. Landing: Zone Landing zone
9. Sector : Number of sectors

#### **Drive A / Drive B**

The category identifies the types of floppy disk drive A or drive B that has been installed in the computer.

1. None: No floppy drive installed
2. 360K, 5.25": 5.25 inch PC-type standard drive; 360K byte capacity.
3. 1.2M, 5.25": 5.25 inch AT-type high-density drive; 1.2M byte capacity  
(3.5 inch when 3 Mode is Enabled).
4. 720K, 3.5": 3.5 inch double-sided drive; 720K byte capacity
5. 1.44M, 3.5": 3.5 inch double-sided drive; 1.44M byte capacity. (Default value)
6. 2.88M, 3.5": 3.5 inch double-sided drive; 2.88M byte capacity.

#### **Floppy 3 Mode Support (for Japan Area)**

1. Disabled: Normal Floppy Drive. (Default value)
2. Drive : A Drive A is 3 mode Floppy Drive.
3. Drive : B Drive B is 3 mode Floppy Drive.
4. Both: Drive A & B are 3 mode Floppy Drives.

#### **Halt on**

The category determines whether the computer will stop if an error is detected during power-up.

1. No Errors: The system boot will not stop for any error that may be detected and you will be prompted.
2. All Errors: Whenever the BIOS detects a non-fatal error the system will be stopped.
3. All, But Keyboard: The system boot will not stop for a keyboard error; it will stop for all other errors. (Default value)
4. All, But Diskette: The system boot will not stop for a disk error; it will stop for all other errors.
5. All, But Disk/Key: The system boot will not stop for a keyboard or disk error; it will stop for all other errors.

#### **Memory**

The category is display-only and is determined by POST (Power On Self Test) of the BIOS.

#### **Base Memory**

The POST of the BIOS will determine the amount of base (or conventional) memory installed in the system. The value of the base memory is typically 512K for systems with 512K memory installed on the motherboard, or 640K for systems with 640K or more memory installed on the motherboard.

#### **Extended Memory**

The BIOS determines how much extended memory is present during the POST.

This is the amount of memory located above 1 MB in the CPU's memory address map.

#### **Total Memory**

This item displays the memory size that used.

## 6-2 Advanced BIOS Features

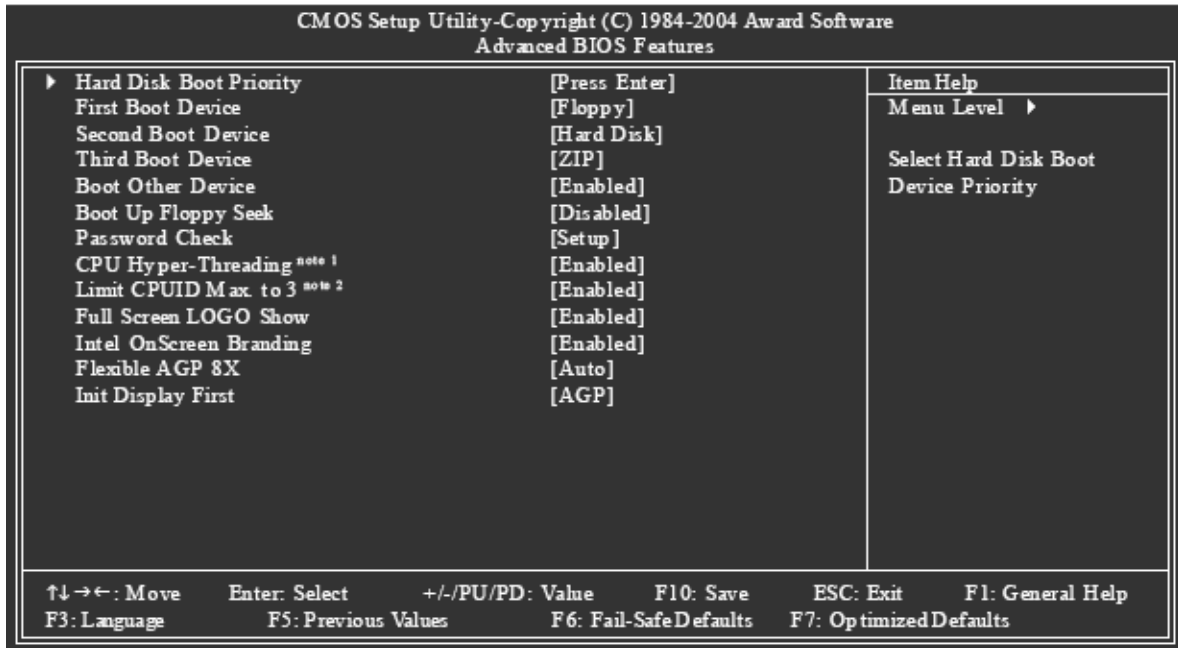

Note 1: This option is available only when the processor you install supports Intel® Hyper-Threading Technology.

Note 2: This option is available only when you install an Intel® Prescott processor.

### Hard Disk Boot Priority

Select boot sequence for onboard (or add-on cards) SCSI, RAID, etc.

Use <> or <> to select a device, then press<+> to move it up, or <-> to move it down the list. Press <ESC> to exit this menu.

#### First / Second / Third Boot Device

1. Floppy: Select your boot device priority by Floppy.
2. LS120: Select your boot device priority by LS120.
3. Hard Disk: Select your boot device priority by Hard Disk.
4. CDROM: Select your boot device priority by CDROM.
5. ZIP : Select your boot device priority by ZIP.
6. USB-FDD: Select your boot device priority by USB-FDD.
7. USB-ZIP: Select your boot device priority by USB-ZIP.
8. USB-CDROM: Select your boot device priority by USB-CDROM.
9. USB-HDD: Select your boot device priority by USB-HDD.
10. Legacy LAN: Select your boot device priority by LAN.
11. Disabled: Select your boot device priority by Disabled.

### **Boot Other Device**

1. Enabled: Enable to boot from other device.(Default value)
2. Disabled: Disable to boot from other device.

### **Boot Up Floppy Seek**

During POST, BIOS will determine if the installed floppy disk drive is 40 or 80 tracks. 360K type is 40 tracks 720K, 1.2M and 1.44M are all 80 tracks.

1. Disabled: BIOS will not search for the type of floppy disk drive by track number. Note that there will not be any warning message if the drive installed is 360K. (Default value)
2. Enabled: BIOS searches for floppy disk drive to determine if it is 40 or 80 tracks. Note that BIOS can not tell from 720K, 1.2M or 1.44M drive type as they are all 80 tracks.

### **Password Check**

1. Setup: The system will boot but will not access to Setup page if the correct password is not entered at the prompt. (Default value)
2. System: The system will not boot and will not access to Setup page if the correct password is not entered at the prompt.

If you want to cancel the setting of password, please just press ENTER to make [SETUP] empty.

### **CPU Hyper-Threading**

This option appears only when the processor you install supports Intel® Hyper-Threading Technology.

1. Enabled Enable CPU Hyper-Threading feature. Please note that this feature only works for operating system with multiprocessors mode supported. (Default value)
2. Disabled Disable CPU Hyper-Threading.

### **Limit CUID Max. to 3**

This option is available only when you install an Intel® Prescott processor

1. Enabled Limit CUID Maximum value to 3 when using older OS like NT4. (Default value)
2. Disabled Disable CUID Limit for Windows XP.

### **Full Screen LOGO Show**

1. Enabled Display Full Screen LOGO during POST. (Default value)
2. Disabled Do not display Full Screen LOGO during POST.

### **Intel OnScreen Branding**

1. Enabled Show Intel OnScreen Branding. (Default value)
2. Disabled Do not display Intel brand LOGO.

### **Flexible AGP 8X**

1. Auto Automatically set AGP transfer rate according to the compability and staility of the AGP graphics card.(Default value)
2. 4x Set AGP transfer rate to 4x mode no matter what the AGP transfer rate the card has.

### **Init Display First**

Select the first initiation of the monitor display from AGP or PCI VGA card.

1. PCI Set Init Display First to PCI VGA card.



2. AGP Set Init Display First to AGP VGA card.(Default value)

### 6-3 Integrated Peripherals

CMOS Setup Utility-Copyright (C) 1984-2004 Award Software		
Integrated Peripherals		
IDE1 Conductor Cable	[Auto]	Item Help
IDE2 Conductor Cable	[Auto]	Menu Level ▶
On-Chip Primary PCI IDE	[Enabled]	
On-Chip Secondary PCI IDE	[Enabled]	[Auto]
AC97 Audio	[Enabled]	Auto-detect IDE cable type
USB Controller	[Enabled]	
USB Legacy Support	[Disabled]	
Onboard LAN device	[Enabled]	[ATA 66/100/133]
Onboard LAN Boot ROM	[Disabled]	Set Conductor Cable to ATA66/100/133 (80 Pins)
Onboard Serial Port 1	[3F8/IRQ4]	
Onboard Parallel Port	[378/IRQ7]	
Parallel Port Mode	[ECP]	
ECP Mode Use DMA	[3]	[Disabled]
Game Port Address	[201]	Set Conductor Cable to ATA33 (40 Pins)
Midi Port Address	[Disabled]	
x Midi Port IRQ	10	

↑↓→←: Move    Enter: Select    +/-/PU/PD: Value    F10: Save    ESC: Exit    F1: General Help  
 F3: Language    F5: Previous Values    F6: Fail-Safe Defaults    F7: Optimized Defaults

#### IDE1 Conductor Cable

1. Auto: BIOS auto-detects IDE1 conductor cable .(Default Value)
2. ATA66/100/133: Set IDE1 Conductor Cable to ATA66/100/133 (Please make sure your IDE device and cable are compatible with ATA66/100/133).
- 3.ATA33: Set IDE1 Conductor Cable to ATA33. (Please make sure your IDE device and cable are compatible with ATA33)

#### IDE2 Conductor Cable

- 1.Auto: BIOS auto-detects IDE2 conductor cable. (Default Value)
- 2.ATA66/100/133: Set IDE2 Conductor Cable to ATA66/100/133. (Please make sure your IDE device and cable are compatible with ATA66/100/133)
- 3.ATA33: Set IDE2 Conductor Cable to ATA33. (Please make sure your IDE device and cable are compatible with ATA33)

#### On-Chip Primary PCI IDE

- 1.Enabled: Enable onboard 1st channel IDE port. (Default value)
- 2.Disabled: Disable onboard 1st channel IDE port.

#### On-Chip Secondary PCI IDE

- 1.Enabled: Enable onboard 2nd channel IDE port. (Default value)
- 2.Disabled: Disable onboard 2nd channel IDE port.

#### AC97 Audio

- 1.Enabled: Auto-detect AC97 audio function. (Default value)
- 2.Disabled: Disable AC97 audio function.

#### USB Controller

- 1.Enabled: Enable USB Controller. (Default value)

2.Disabled: Disable USB Controller.

## 6-4 Power Management Setup

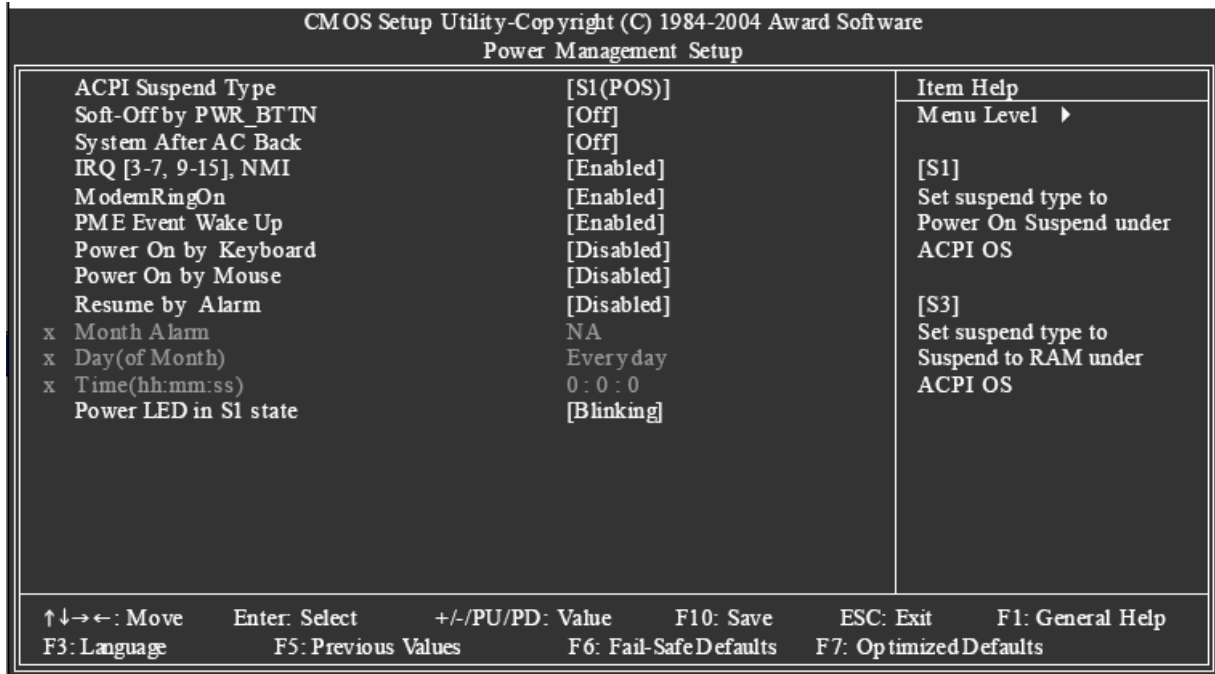

### ACPI Suspend Type

- 1.S1(POS): Set ACPI suspend type to S1/POS (Power On Suspend). (Default value)
- 2.S3(STR): Set ACPI suspend type to S3/STR (Suspend To RAM).

### Soft-Off by PWR-BTTN

- 1.Off: Press power button to turn off the system instantly. (Default value)
- 2.Suspend: Press power button for 4 seconds to turn off the system. The system will enter suspend mode if the button is pressed for less than 4 seconds.

### System After AC Back

- 1.Off: When AC-power is back to the system, the system will be in "Off" state. (Default value)
- 2.On: When AC-power is back to the system, the system will be always in "On" state.
- 3.Laststate: When AC-power is back to the system, the system will return to the last state before AC-power was off.

### IRQ [3-7, 9-15], NMI

When IRQ [3-7, 9-15] or NMI triggered, the suspend timer will be reloaded to prevent system from getting into green mode.

- 1.Disabled: Don't monitor IRQ [3-7, 9-15] or NMI.
- 2.Enabled: Monitor IRQ [3-7, 9-15] or NMI.(Default value)

### Modem Ring On

- 1.Disabled: Disable Modem Ring On function.
- 2.Enabled: Enable Modem Ring On function.(Default value)

### PME Event Wake Up

This feature requires an ATX power supply that provides at least 1A on the 5VSB lead.

- 1.Disabled: Disable this function.
- 2.Enabled: Enable PME Event Wake up. (Default value)

#### **Power On By Keyboard**

- 1.Password: Enter one to eight characters to set the Keyboard Power On password.
  - 2.Disabled: Disabled this function. (Default value)
- Any Key Press any key to turn on the computer.

#### **Power On By Mouse**

- 1.Disabled: Disable this function. (Default value)
- 2.Enabled: Move or click the left button of the PS/2 mouse to turn on the computer.

#### **Resume by Alarm**

You can enable **Resume by Alarm** and set date/time to turn on your system.

- 1.Disabled: Disable this function. (Default value)
- 2.Enabled: Enable **Resume by Alarm** function to turn on system.

If **Resume by Alarm** is Enabled:

- 1.Month Alarm: Jan.~Dec.
- 2.Day (of Month): Everyday, 1~31
- 3.Time (hh: mm: ss): (0~23) : (0~59) : (0~59)

#### **Power LED in S1 State**

- 1.Blinking: The Power LED will be blinking during S1 state. (Default value)
- 2.Dual/OFF: The Power LED will be turned off or change color.

## **6-5 PnP/PCI Configurations**

CMOS Setup Utility-Copyright (C) 1984-2004 Award Software	
PnP/PCI Configurations	
PCI 1 IRQ Assignment	[Auto]
PCI 2 IRQ Assignment	[Auto]
PCI 3 IRQ Assignment	[Auto]
	Item Help
	Menu Level ▶

↑↓→←: Move    Enter: Select    +/-/PU/PD: Value    F10: Save    ESC: Exit    F1: General Help  
F3: Language    F5: Previous Values    F6: Fail-Safe Defaults    F7: Optimized Defaults

### PCI 1 IRQ Assignment

- 1.Auto: Auto assign IRQ to PCI 1. (Default value)
- 2,3,4,5,7,9,10,11,12,14,15: Set IRQ 3,4,5,7,9,10,11,12,14,15 to PCI 1.

### PCI 2 IRQ Assignment

- 1.Auto: Auto assign IRQ to PCI 2. (Default value)
- 2,3,4,5,7,9,10,11,12,14,15: Set IRQ 3,4,5,7,9,10,11,12,14,15 to PCI 2.

### PCI 3 IRQ Assignment

- 1.Auto: Auto assign IRQ to PCI 3. (Default value)
- 2,3,4,5,7,9,10,11,12,14,15: Set IRQ 3,4,5,7,9,10,11,12,14,15 to PCI 3.

## 6-6 PC Health Status

CMOS Setup Utility-Copyright (C) 1984-2004 Award Software		
PC Health Status		
		Item Help
Reset Case Open Status	[Disabled]	Menu Level ▶
Case Opened	Yes	[Disabled]
Vcore	1.314V	Don't reset case open status
VCC18	1.824V	[Enabled]
+3.3V	3.280V	Clear case open status and set to be Disabled at next boot
+5V	4.927V	
+12V	11.478V	
Current System Temperature	33°C	
Current CPU Temperature	33°C	
Current CPU FAN Speed	4687 RPM	
Current SYSTEM FAN Speed	0 RPM	
CPU Smart FAN Control	[Enabled]	

↑↓→←: Move    Enter: Select    +/-/PU/PD: Value    F10: Save    ESC: Exit    F1: General Help  
F3: Language    F5: Previous Values    F6: Fail-Safe Defaults    F7: Optimized Defaults

### Reset Case Open Status

- 1.Disabled: Don't reset case open status. (Default value)
- 2.Enabled: Clear case open status at next boot.

### Case Opened

If the case is closed, **Case Opened** will show "No."

If the case is opened, **Case Opened** will show "Yes."

If you want to reset **Case Opened** value, enable **Reset Case Open Status** and save the change to CMOS, and then your computer will restart.

### Current Voltage(V) V-core / VCC18/ +3.3V/+5V / +12V

Detect system's voltage status automatically.

### Current System Temperature

Detect system temperature automatically.

### Current CPU Temperature

Detect CPU temperature automatically.

### Current CPU/SYSTEM FAN Speed (RPM)

Detect CPU/SYSTEM fan speed status automatically.

**CPU Smart FAN Control**

- 1.Enabled: Enable the **CPU Smart FAN Control** function. (Default Value)
  - a. When the CPU temperature is higher than 65 degrees Celsius, CPU fan will operate at full speed
  - b. When the CPU temperature is between 20 and 65 degrees Celsius, the CPU fan speed will change depending on the actual CPU temperature.
  - c. When the CPU temperature is lower than 20 degrees Celsius, CPU fan will stop spinning.
- 2.Disabled: Disable the **CPU Smart FAN Control** function.

**6-7 MB Intelligent Tweaker (M.I.T.)**

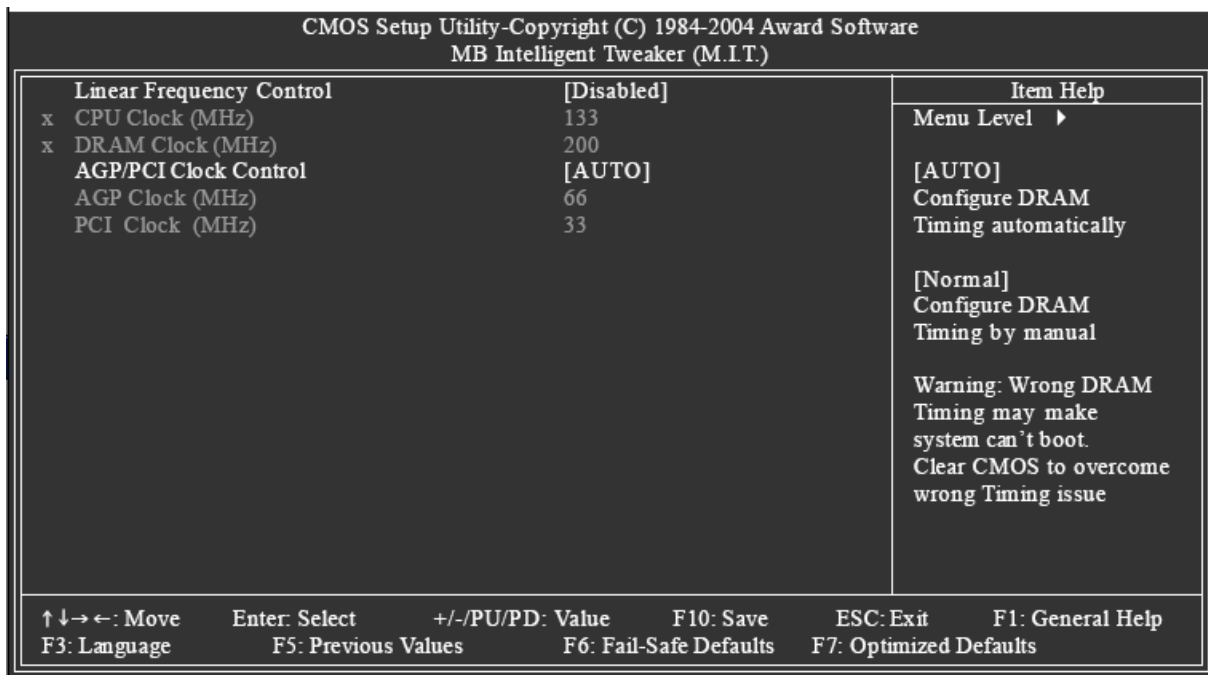

Incorrect using these features may cause your system corrupted. For power users only.

**Linear Frequency Control**

- 1.Disabled: Disable this function. (Default value)
- 2.Enabled: Enable this function.

**CPU Clock (MHz)**

This option is available only when **Linear Frequency Control** is enabled.

100~355 Select CPU Clock to 100MHz~355MHz.

If you use a Pentium 4 processor with 400MHz FSB, please set "CPU Clock" to 100MHz.

If you use a Pentium 4 processor with 533MHz FSB, please set "CPU Clock" to 133MHz.

If you use a Pentium 4 processor with 800MHz FSB, please set "CPU Clock" to 200MHz.

Incorrect using it may cause your system corrupted. For power users only!

**DRAM Clock (MHz)**

This option is available only when **Linear Frequency Control** is enabled.

Please set DRAM Clock according to your requirement.

If you use DDR266 DRAM module, please set "DRAM Clock(MHz)" to 266. If you use DDR333 DRAM module, please set "DRAM Clock(MHz)" to 333.

Incorrect using it may cause your system corrupted. For power users only!

#### **AGP/PCI Clock Control**

AUTO: Set AGP/PCI clock automatically. (Default)

#### **AGP Clock (MHz)**

This option is available only when **AGP/PCI Clock Control** is set to Manual.

Please set AGP Clock according to your requirement.

Incorrect using it may cause your system corrupted. For power users only!

#### **PCI Clock (MHz)**

When you select to set the AGP Clock (MHz) manually, the PCI Clock (MHz) will change automatically depending on the AGP Clock (MHz) you set.

### **6-8 Top Performance**

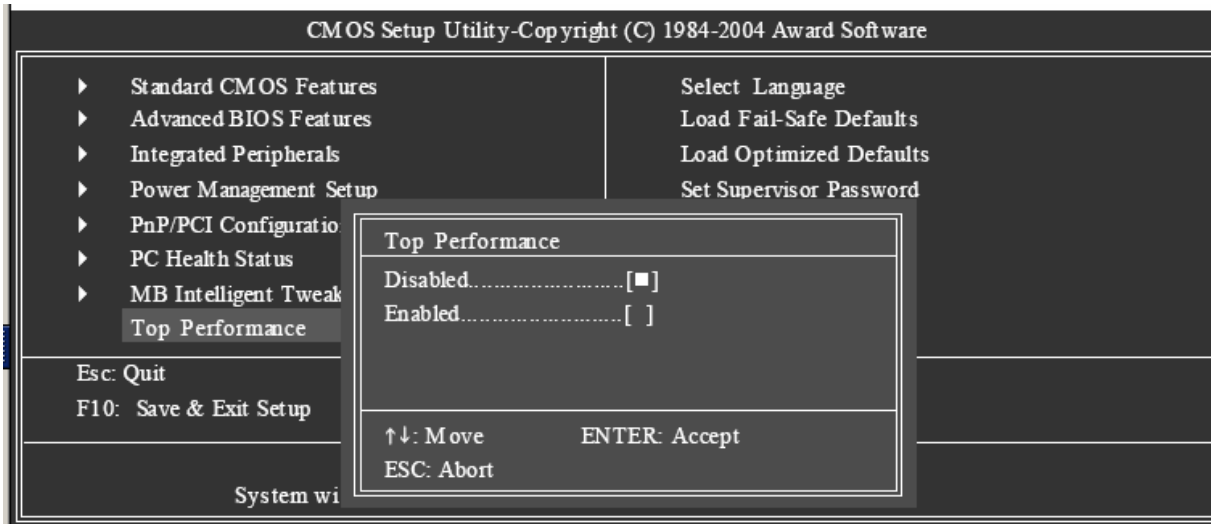

If you wish to maximize the performance of your system, enable "Top Performance."

1.Disabled: Disable this function. (Default Value)

2.Enabled: Enable Top Performance function.

"Top Performance" will increase H/W working speed. Different system configuration (both H/W component and OS) will affect the result. For example, the same H/W configuration might not run properly with Windows XP, but works smoothly with Windows NT. Therefore, if your system is not perform enough, the reliability or stability problem will appear sometimes, and we will recommend you disabling the option to avoid the problem as mentioned above.

## 6-9 Select Language

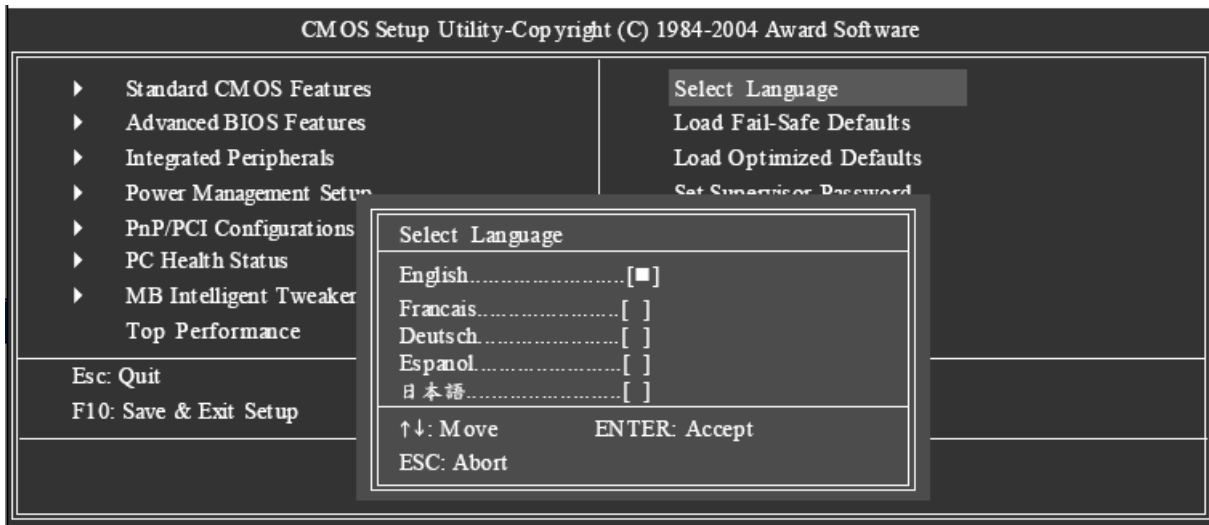

Multi-language supports 5 languages. There are English, French, German, Spanish and Japanese.

## 6-10 Load Fail-Safe Defaults

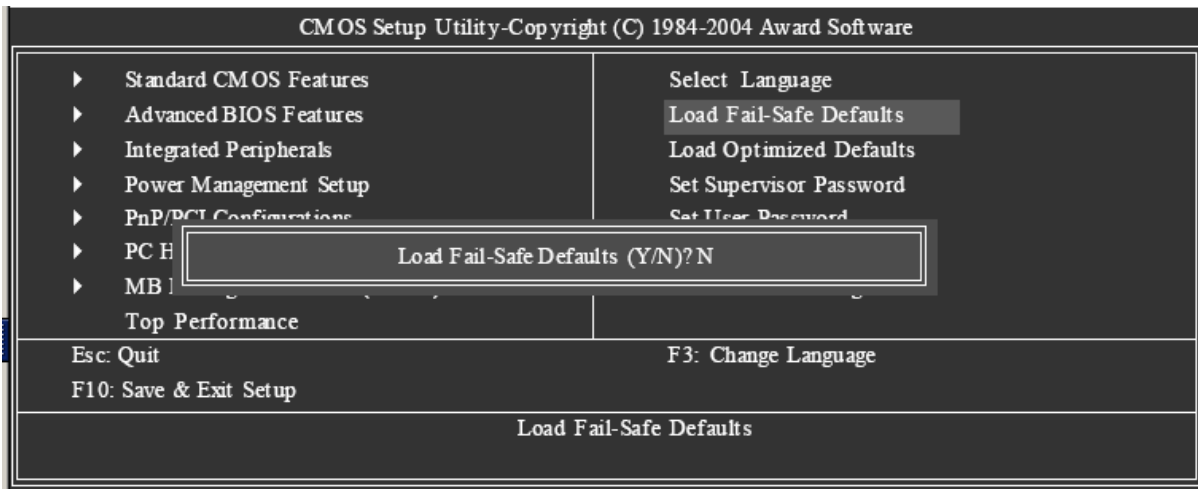

Fail-Safe defaults contain the most appropriate values of the system parameters that allow minimum system performance.

## 6-11 Load Optimized Defaults

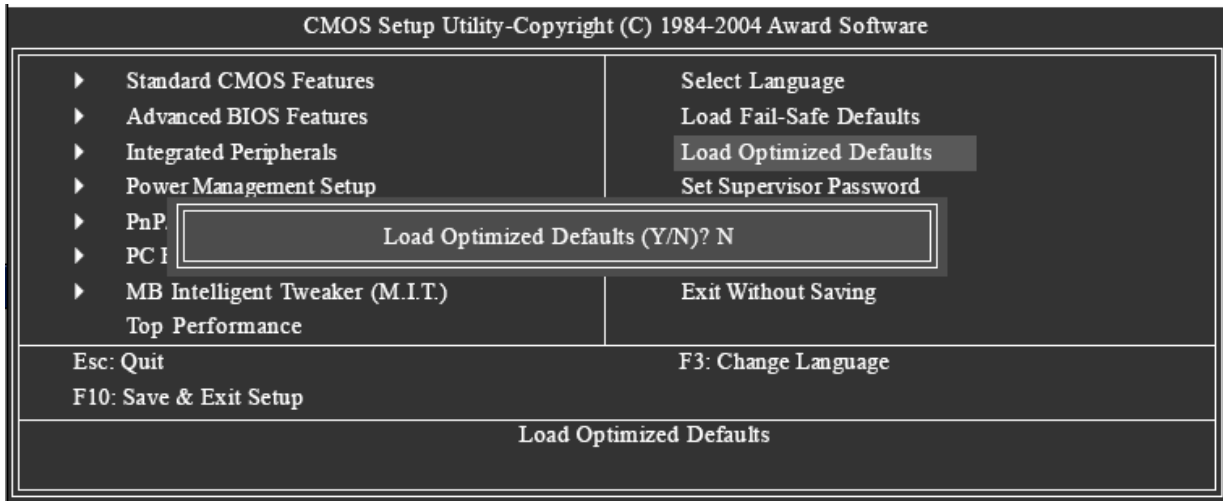

Selecting this field loads the factory defaults for BIOS and Chipset Features which the system automatically detects.

## 6-12 Set Supervisor/User Password

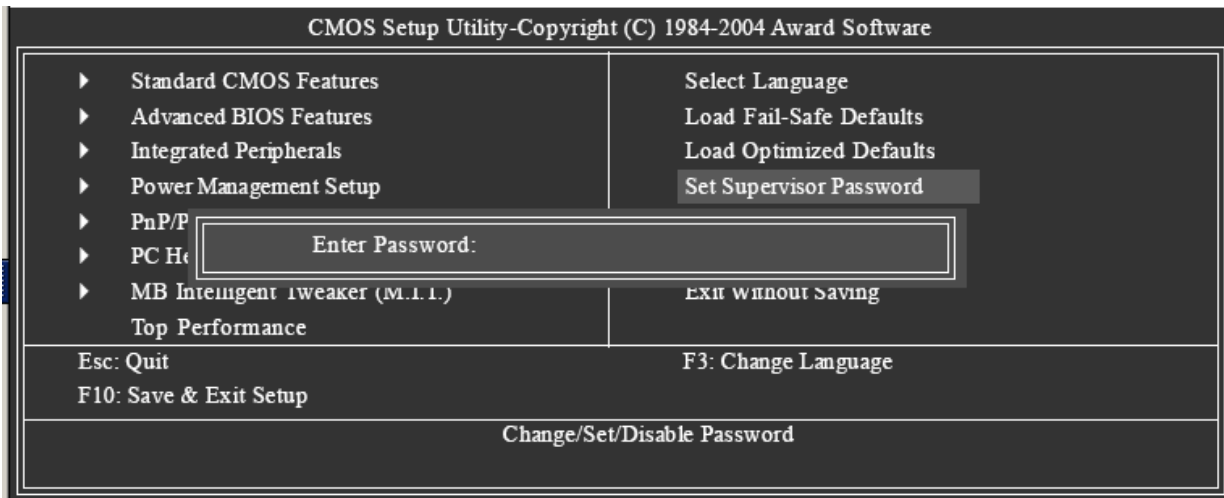

Selecting this field loads the factory defaults for BIOS and Chipset Features which the system automatically detects.

When you select this function, the following message will appear at the center of the screen to assist you in creating a password.

Type the password, up to eight characters, and press <Enter>. You will be asked to confirm the password.

Type the password again and press <Enter>. You may also press <Esc> to abort the selection and not enter a password.

To disable password, just press <Enter> when you are prompted to enter password. A message "PASSWORD DISABLED" will appear to confirm the password being disabled. Once the



password is disabled, the system will boot and you can enter Setup freely.

The BIOS Setup program allows you to specify two separate passwords: SUPERVISOR PASSWORD and a USER PASSWORD. When disabled, anyone may access all BIOS Setup program function. When enabled, the Supervisor password is required for entering the BIOS Setup program and having full configuration fields, the User password is required to access only basic items.

If you select "System" at "Password Check" in Advance BIOS Features Menu, you will be prompted for the password every time the system is rebooted or any time you try to enter Setup Menu.

If you select "Setup" at "Password Check" in Advance BIOS Features Menu, you will be prompted only when you try to enter Setup.

### 6-13 Save & Exit Setup

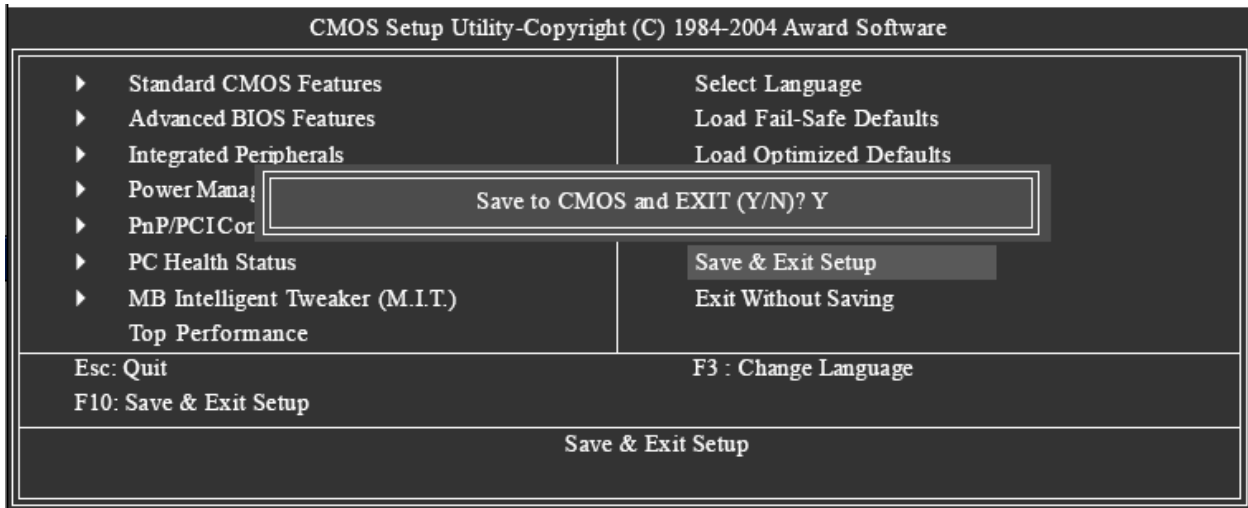

Type "Y" will quit the Setup Utility and save the user setup value to RTC CMOS.

Type "N" will return to Setup Utility.

### 6-14 Exit Without Saving

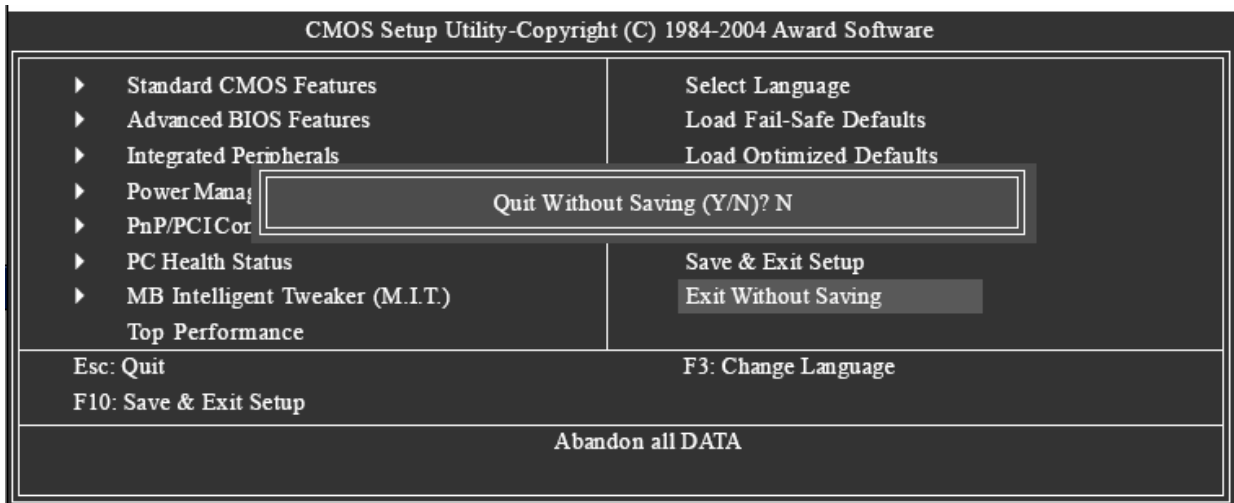

Type "Y" will quit the Setup Utility without saving to RTC CMOS.  
Type "N" will return to Setup Utility.

# Chapter 5. Safety information

The following section contains the safety information that you need to be familiar with before servicing an IBM computer.

## General safety

Follow these rules to ensure general safety:

- v Observe good housekeeping in the area of the machines during and after maintenance.
- v When lifting any heavy object:
  - 1.Ensure you can stand safely without slipping.
  - 2.Distribute the weight of the object equally between your feet.
  - 3.Use a slow lifting force. Never move suddenly or twist when you attempt to lift.
  - 4.Lift by standing or by pushing up with your leg muscles; this action removes the strain from the muscles in your back. *Do not attempt to lift any objects that weigh more than 16 kg (35 lb) or objects that you think are too heavy for you*
- v Do not perform any action that causes hazards to the customer, or that makes the equipment unsafe.
- v Before you start the machine, ensure that other service representatives and the customer's personnel are not in a hazardous position.
- v Place removed covers and other parts in a safe place, away from all personnel, while you are servicing the machine.
- v Keep your tool case away from walk areas so that other people will not trip over it.
- v Do not wear loose clothing that can be trapped in the moving parts of a machine. Ensure that your sleeves are fastened or rolled up above your elbows. If your hair is long, fasten it.
- v Insert the ends of your necktie or scarf inside clothing or fasten it with a nonconductive clip, approximately 8 centimeters (3 inches) from the end.
- v Do not wear jewelry, chains, metal-frame eyeglasses, or metal fasteners for your clothing.  
**Remember:** Metal objects are good electrical conductors.
- v Wear safety glasses when you are: hammering, drilling soldering, cutting wire, attaching springs, using solvents, or working in any other conditions that might be hazardous to your eyes.
- v After service, reinstall all safety shields, guards, labels, and ground wires. Replace any safety device that is worn or defective.
- v Reinstall all covers correctly before returning the machine to the customer.

## Electrical safety



### CAUTION:

**Electrical current from power, telephone, and communication cables can be hazardous. To avoid personal injury or equipment damage, disconnect the attached power cords, telecommunication systems, networks, and modems before you open the server/workstation covers, unless instructed otherwise in the installation and configuration procedures.**

Observe the following rules when working on electrical equipment.

**Important:** Use only approved tools and test equipment. Some hand tools have handles covered with a soft material that does not insulate you when working with live electrical currents. Many customers have, near their equipment, rubber floor mats that contain small conductive fibers to decrease electrostatic discharges. Do not use this type of mat to protect yourself from electrical shock.

- v Find the room emergency power-off (EPO) switch, disconnecting switch, or electrical outlet. If an electrical accident occurs, you can then operate the switch or unplug the power cord quickly.
  - v Do not work alone under hazardous conditions or near equipment that has hazardous voltages.
  - v Disconnect all power before:
    - Performing a mechanical inspection
    - Working near power supplies
    - Removing or installing main units
  - v Before you start to work on the machine, unplug the power cord. If you cannot unplug it, ask the customer to power-off the wall box that supplies power to the machine and to lock the wall box in the off position.
  - v If you need to work on a machine that has exposed electrical circuits, observe the following precautions:
    - Ensure that another person, familiar with the power-off controls, is near you. **Remember:** Another person must be there to switch off the power, if necessary.
    - Use only one hand when working with powered-on electrical equipment; keep the other hand in your pocket or behind your back  
**Remember:** There must be a complete circuit to cause electrical shock. By observing the above rule, you may prevent a current from passing through your body.
    - When using testers, set the controls correctly and use the approved probe leads and accessories for that tester.
    - Stand on suitable rubber mats (obtained locally, if necessary) to insulate you from grounds such as metal floor strips and machine frames.
- Observe the special safety precautions when you work with very high voltages; these instructions are in the safety sections of maintenance information. Use extreme care when measuring high voltages.
- v Regularly inspect and maintain your electrical hand tools for safe operational condition.
  - v Do not use worn or broken tools and testers.
  - v *Never assume* that power has been disconnected from a circuit. First, *check* that it has been powered-off.

- ∨ Always look carefully for possible hazards in your work area. Examples of these hazards are moist floors, nongrounded power extension cables, power surges, and missing safety grounds.
- ∨ Do not touch live electrical circuits with the reflective surface of a plastic dental mirror. The surface is conductive; such touching can cause personal injury and machine damage.
- ∨ Do not service the following parts with the power on when they are removed from their normal operating places in a machine: – Power supply units – Pumps – Blowers and fans – Motor generators and similar units. (This practice ensures correct grounding of the units.)
- ∨ If an electrical accident occurs: – Use caution; do not become a victim yourself. – Switch off power. – Send another person to get medical aid.

## Safety inspection guide

The intent of this inspection guide is to assist you in identifying potentially unsafe conditions on these products. Each machine, as it was designed and built, had required safety items installed to protect users and service personnel from injury. This guide addresses only those items. However, good judgment should be used to identify potential safety hazards due to attachment of non-IBM features or options not covered by this inspection guide.

If any unsafe conditions are present, you must determine how serious the apparent hazard could be and whether you can continue without first correcting the problem.

Consider these conditions and the safety hazards they present:

- ∨ Electrical hazards, especially primary power (primary voltage on the frame can cause serious or fatal electrical shock).
- ∨ Explosive hazards, such as a damaged CRT face or bulging capacitor
- ∨ Mechanical hazards, such as loose or missing hardware

The guide consists of a series of steps presented in a checklist. Begin the checks with the power off, and the power cord disconnected.

Checklist:

1. Check exterior covers for damage (loose, broken, or sharp edges).
2. Power-off the computer. Disconnect the power cord.
3. Check the power cord for:
  - a. A third-wire ground connector in good condition. Use a meter to measure third-wire ground continuity for 0.1 ohm or less between the external ground pin and frame ground.
  - b. The power cord should be the appropriate type as specified in the parts listings.
  - c. Insulation must not be frayed or worn.
4. Remove the cover.
5. Check for any obvious non-IBM alterations. Use good judgment as to the safety of any non-IBM alterations.
6. Check inside the unit for any obvious unsafe conditions, such as metal filings, contamination, water or other liquids, or signs of fire or smoke damage.
7. Check for worn, frayed, or pinched cables.

8. Check that the power-supply cover fasteners (screws or rivets) have not been removed or tampered with.

## Handling electrostatic discharge-sensitive devices

Any computer part containing transistors or integrated circuits (ICs) should be considered sensitive to electrostatic discharge (ESD). ESD damage can occur when there is a difference in charge between objects. Protect against ESD damage by equalizing the charge so that the machine, the part, the work mat, and the person handling the part are all at the same charge.

### Notes:

1. Use product-specific ESD procedures when they exceed the requirements noted here.
2. Make sure that the ESD protective devices you use have been certified (ISO 9000) as fully effective.

When handling ESD-sensitive parts:

- ✓ Keep the parts in protective packages until they are inserted into the product.
- ✓ Avoid contact with other people.
- ✓ Wear a grounded wrist strap against your skin to eliminate static on your body.
- ✓ Prevent the part from touching your clothing. Most clothing is insulative and retains a charge even when you are wearing a wrist strap.
- ✓ Use the black side of a grounded work mat to provide a static-free work surface. The mat is especially useful when handling ESD-sensitive devices.
- ✓ Select a grounding system, such as those listed below, to provide protection that meets the specific service requirement.

**Note:** The use of a grounding system is desirable but not required to protect against ESD damage.

- Attach the ESD ground clip to any frame ground, ground braid, or green-wire ground.
- Use an ESD common ground or reference point when working on a double-insulated or battery-operated system. You can use coax or connector-outside shells on these systems.
- Use the round ground-prong of the ac plug on ac-operated computers.

## Grounding requirements

Electrical grounding of the computer is required for operator safety and correct system function. Proper grounding of the electrical outlet can be verified by a certified electrician.

### Safety notices (multi-lingual translations)

The caution and danger safety notices in this section are provided in the following languages:

- ✓ English
- ✓ Brazilian/Portuguese
- ✓ Chinese
- ✓ French
- ✓ German

- v Italian
- v Korean
- v Spanish



**DANGER**

Electrical current from power, telephone and communication cables is hazardous.

**To avoid a shock hazard:**

- v **Do not connect or disconnect any cables or perform installation, maintenance, or reconfiguration of this product during an electrical storm.**
- v **Connect all power cords to a properly wired and grounded electrical outlet.**
- v **Connect to properly wired outlets any equipment that will be attached to this product.**
- v **When possible, use one hand only to connect or disconnect signal cables.**
- v **Never turn on any equipment when there is evidence of fire, water, or structural damage.**
- v **Disconnect the attached power cords, telecommunications systems, networks, and modems before you open the device covers, unless instructed otherwise in the installation and configuration procedures.**
- v **Connect and disconnect cables as described in the following table when , moving, or opening covers on this product or attached devices.**

To Connect	To Disconnect
1. Turn everything OFF. 2. First, attach all cables to devices. 3. Attach signal cables to connectors. 4. Attach power cords to outlet. 5. Attach power cords to outlet.	1. Turn everything OFF. 2. First, remove power cords from outlet. 3. Remove signal cables from connectors. 4. Remove all cables from devices.



**CAUTION:**

**When replacing the lithium battery, use only IBM Part Number 33F8354 or an equivalent type battery recommended by the manufacturer. If your system has a module containing a lithium battery, replace it only with the same module type made by the same manufacturer. The battery contains lithium and can explode if not properly used, handled, or disposed of.**

***Do not:***

- v **Throw or immerse into water**
- v **Heat to more than 100°C (212°F)**
- v **Repair or disassemble**

**Dispose of the battery as required by local ordinances or regulations.**



**CAUTION:**

When laser products (such as CD-ROMs, DVD-ROM drives, fiber optic devices, or transmitters) are installed, note the following:

- v Do not remove the covers. Removing the covers of the laser product could result in exposure to hazardous laser radiation. There are no serviceable parts inside the device.
- v Use of controls or adjustments or performance of procedures other than those specified herein might result in hazardous radiation exposure.



**DANGER:**

Some laser products contain an embedded Class 3A or Class 3B laser diode. Note the following:

Laser radiation when open. Do not stare into the beam, do not view directly with optical instruments, and avoid direct exposure to the beam.



**CAUTION:**

Use safe practices when lifting.



≥18 kg (37 lbs)



≥32 kg (70.5 lbs)



≥55 kg (121.2 lbs)



**CAUTION:**

The power control button on the device and the power switch on the power supply do not turn off the electrical current supplied to the device. The device also might have more than one power cord. To remove all electrical current from the device, ensure that all power cords are disconnected from the power source.

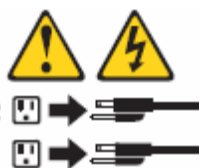



**CAUTION:**

Do not place any object weighing more than 82 kg (180 lbs.) on top of rack-mounted devices.



**PERIGO**

A corrente eléctrica proveniente de cabos de alimentação, de telefone e de comunicações é perigosa.

Para evitar risco de choque:

- ✓ Não conecte ou desconecte cabos e não realize instalação, manutenção ou reconfiguração deste produto durante uma tempestade com raios.
- ✓ Conecte todos os cabos de alimentação a tomadas eléctricas corretamente instaladas e aterradas.
- ✓ Conecte todos os equipamentos ao qual esse produto será conectado a tomadas corretamente instaladas.
- ✓ Sempre que possí vel, utilize apenas uma das mãos para conectar ou desconectar cabos de sinal.
- ✓ Nunca ligue qualquer equipamento quando existir evidência de danos por fogo, água ou na estrutura.
- ✓ Desconecte cabos de alimentação, sistemas de telecomunicação, redes e modems antes de abrir as tampas dos dispositivos, a menos que especificado de maneira diferente nos procedimentos de instalação e configuração.
- ✓ Conecte e desconecte cabos conforme descrito na seguinte tabela, ao instalar ou movimentar este produto ou os dispositivos conectados, ou ao abrir suas tampas.

Para Conectar:	Para Desconectar:
1. DESLIGUE Tudo.	1. DESLIGUE Tudo.
2. Primeiramente, conecte todos os cabos aos dispositivos.	2. Primeiramente, remova os cabos de alimentacao das tomadas.
3. Conecte os cabos de sinal aos conectores.	3. Remova os cabos de sinal dos conectores.
4. Conecte os cabos de alimentacao as tomadas.	4. Remova todos os cabos dos dispositivos.
5. LIGUE os dispositivos.	



**CUIDADO:**

Ao substituir a bateria de lítio, utilize apenas uma bateria IBM, Número de Peça 33F8354 ou uma bateria de tipo equivalente, recomendada pelo fabricante. Se o seu sistema possui um módulo com uma bateria de lítio, substitua-o apenas pelo mesmo tipo de módulo, do mesmo fabricante. A bateria contém lítio e pode explodir se não for utilizada, manuseada e descartada de maneira correta.

Não:

- v Jogue ou coloque na água
- v Aqueça a mais de 100°C (212°F)
- v Conserte nem desmonte

Para descartar a bateria, entre em contato com a área de atendimento a clientes IBM, pelo telefone (011) 889-8986, para obter informações sobre como enviar a bateria pelo correio para a IBM.



**PRECAUCIÓN:**

Quando produtos a laser (unidades de CD-ROM, unidades de DVD, dispositivos de fibra ótica, transmissores, etc.) estiverem instalados, observe o seguinte:

- v Não remova as tampas. A remoção das tampas de um produto a laser pode resultar em exposição prejudicial à radiação de laser. Nenhuma peça localizada no interior do dispositivo pode ser consertada.
- v A utilização de controles ou ajustes ou a execução de procedimentos diferentes dos especificados aqui pode resultar em exposição prejudicial à radiação.

**PERIGO**

Alguns produtos a laser contêm um diodo laser da Classe 3A ou Classe 3B embutido. Observe o seguinte:

Radiação de laser quando aberto. Não olhe diretamente para o raio a olho nu ou com instrumentos óticos, e evite exposição direta ao raio.

**CUIDADO:**

Ao levantar a máquina, faça-o com segurança.

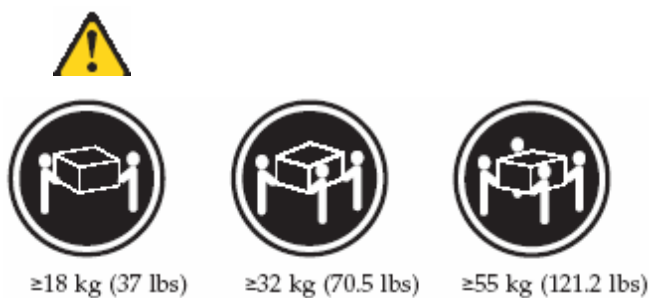

**CUIDADO:**

Os botões Liga/Desliga localizados no dispositivo e na fonte de alimentação não desligam a corrente elétrica fornecida ao dispositivo. O dispositivo também pode ter mais de um cabo de alimentação. Para remover toda a corrente elétrica do dispositivo, assegure que todos os cabos de alimentação estejam desconectados da fonte de energia elétrica.

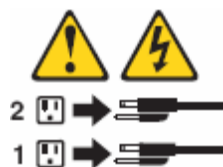

**CUIDADO:**



**CUIDADO:**



Não coloque nenhum objeto com peso superior a 82 kg (180 lbs.) sobre dispositivos montados em rack.